



403696



# NATURE

A WEEKLY

ILLUSTRATED JOURNAL OF SCIENCE

VOLUME XXII.

MAY 1880 to OCTOBER 1880

*“ To the solid ground  
Of Nature trusts the mind which builds for*

London and New York:  
MACMILLAN AND CO.

1880

LONDON :  
R. CLAY, SONS, AND TAYLOR, PRINTERS,  
BREAD STREET HILL, E.C.

# INDEX

- ABERDEEN**, Museum of Science and Art in, 66  
 Abercromby (Hon. Ralph), Tay Bridge Storm, 533  
 Absorption Bands in Certain Colourless Liquids, Dr. W. J. Russell, F.R.S., and William Lapraik, 368  
 Abyssinia, Count Louis Pennazzi's proposed Journey in, 232  
 Accademia dei Lincei, 257  
 Acidulated Water, Immersion of Steel and Iron in, W. H. Johnson, 11  
 Actinism of the Sun's Rays and of Daylight, Measurement of, Dr. R. Angus Smith, 70  
 Adams (Prof. W. G., F.R.S.), Opening Address in Section A at the British Association, 411; on the Comparison of Declination Magnetographs at various Places, 447  
 Adelaide Botanic Garden, 253  
 Aeronautics: and Advertising, 17; Aeronautical Society of Great Britain, 155; New Scheme for directing Balloons, W. de Fonvielle, 303; *see also* Balloons  
**Africa**: Association for the Exploration and Civilization of Central, 10; Missionary Societies' Exploration of, 19; German African Society, 114; Marn's Expedition, 114; New Map of Equatorial, by E. G. Ravenstein, 134; African Exploration Fund's Expedition, 303; Baptist Society's Map of Equatorial, 351; International Expedition to, 376; Royal Geographical Society's East African Expedition, 479; London Missionary Society's Expedition to Tanganyika, 514; German African Society's Mittheilungen, 544; Italian Expedition to Shoa, 579; French Expedition to the Upper Senegal, 579; Plants from Lakes Nyassa and Tanganyika, 585; In. Low's Expedition, 618  
 "After Images of Motion," Herr Zehfus on, 92  
 Agassiz (Prof. Alexander): Obituary Notice of Count L. E. de Pourtales, 371; Paleontological and Embryological Development, 424  
**Agriculture**: the Royal Agricultural College, Cirencester, 64, 154; Establishment of Two Scholarships at the, 185; Meeting of National Society for the Encouragement of, 69; Education of the People in, in France, 155; Earl Spencer on Agriculture and Science, 182; Establishment of a New School of Agriculture at Canterbury, New Zealand, 182; Agricultural Show at Carlisle, 253, 275; Prof. Church on Agricultural Chemistry, 275, 300; Dr. J. H. Gilbert, F.R.S., on Agricultural Chemistry, 472, 497, 523  
 Air-Bladder of Herring, Alf. C. Haddon, 534  
 Air-Engine, Col. Beaumont's, 567  
 Alabama, Geological Survey of, 348  
 Albania and the Albanians, A. H. Keane, 243  
 Alis (W. Steinhilber), "Elementary Treatise on Spherical Geometry," 531  
 Aleurone-Grains, the Chemical Composition of, Dr. Vines, 91  
 Alexander (T.), Elementary Applied Mechanics, 265  
 Alexandra Palace, Arctic Exhibition at, 254  
 Alge of the Siberian Polar Sea, 376  
 Alge, G. F. Chantrell, 382  
 Algeria: Decrease of Lions in, 204; Population of, 239  
 Algiers Observatory, M. Coggia appointed Director, 154  
 Algol, Minimum of, 156  
 Alen (H. Romilly) Cup and Ring Stone, 97  
 Alen (Frank J.), Songs of Birds, 122  
 Alen (Gran), a Doubtful British Mollusk, 435  
 Alligators, Chinese, 112  
 Allan (Prof. G. O. J., F.R.S.), the Freshwater Mollusca, 177, 218, 290  
 Allwood (T.), Double-Egg, .  
 Alpine Flowers, Dr. Hermann Muller's work on, 204  
 Albrese? What is, Dr. A. Ernst, 585  
 Alhai Mountains, Jurassic Rocks of, 349  
 American Naturalist, 20, 137, 282, 551, 623  
 American Journal of Science, 45, 186, 257, 483  
 American Journal of Mathematics, 73, 276  
 American (East Coast) Siphonophora, 113  
 American Blue Pike, Parasitism of, 114  
 American Journal of Philology, 167  
 American Journal of Microscopy, 319  
 American Academy of Arts and Sciences, 332  
 American Association for the Advancement of Science, 345, 397, 498; the Entomological Club of the, 317; Prof. Agassiz's Address on Paleontological and Embryological Development, 424  
 American Anti-Quarian Society, 417  
 Amphipods, Nest-Building, 594  
 Anatomy of Man, Comparative, Prof. Flower, F.R.S., 59, 78, 97  
 Ancher-See, 31, 54, 171  
 Ancient Monuments, Preservation of, Aberdeen Herbert on, 228  
 Ancient Geography, Bunsbury's History of, 333  
 Anderson (R.), New Zinc-Carbon Battery, 13  
 Anderson (Richard), on the Necessity for a Regular Impulse of Lightning Conductors, 449  
 Anderson (Dr. Tempe), on Astigmatism, 475; Improved Heliograph or Sun Signal, 499  
 Andersson (Dr. Nils Johann), Obituary Notice of, 39  
 Anemometer, Cup, Constants of, Rev. Dr. Robinson, F.R.S., 494  
 Angel's "Plane Geometry," 557  
 Animals, Depraved Tastes in, 329, 330; Arthur Nichol's, 339  
 T. R. Greenwood, 364  
 Annalen der Physik und Chemie, 46, 79, 185, 307, 551  
 Annular Entozoon, G. L. Dobson, 533  
 Ansted (Prof. David Thomas, F.R.S.), Death of, 86  
 Anthropology: Anthropological Institute, 22, 47, 72, 107, 211, 235; Annual Congress of the German Anthropological Society, 345, 453; International Congress of, 449; General P. Rivers's (Lane Fox) Anthropological Collection, 480, 511  
 Antipatharia of the *Zee* Expedition, 113  
 Ants, E. Whymer's Association, 19  
 Ant, Sir John Lubbock on the History of, 184; S. and J. Peal, S. E. Peal, 583  
 Antwerp Geographical Society's Bulletin, 200  
 Apiary, A. J. Cook's Manual of the, 131  
 Apiculture, Exhibition of Apparatus relating to, 17  
 Aquarium, Variable Star in, 205  
 Aqueous Vapour in relation to Perpetual Snow, Dr. J. Crall, F.R.S., 191  
 Archives of Science, Physiques et Naturelles, 20, 100, 257, 38  
 Arctic Exploration: Proposed Expedition under Lieut. B. de la Motte, the proposed Observing Station, 60; Breaking-up of the Ice, 115; another Balloon Scheme, 134; the *Herzog* Expedition, 134; Scientific Results of the *Herzog* Polar Expedition, 1877-78, 171; Bergh's proposed Expedition, 157; Departure of the *Zee* from Peterhead, 184; Arctic Exhibition at the Alexandra Palace, 254; the Franklin Store Expedition, 544; Arctic Fossils from the Arctic and Temperature, J. S. Galloway, 341; Arctic News, 5, 6; Loch Smith's Cruise, 51

- Argentine Entomology, W. L. Distant, 238  
 Argyll (Duke of, F.R.S.), the Lesser Spotted Woodpecker, 95; a Fourth State of Matter, 168; a Fragment of Primæval Europe, 407  
 Aristotelian Society, 519  
 Armstrong (Prof. H. E., F.R.S.), Miller's Elements of Chemistry, 559  
 Arrow Heads, Stone, W. L. Distant, 11  
 Arrow-heads, Chipped, Dr. R. W. Copping, 97  
 Arthropods, Transverse Comensure in, 520  
 Artificial Diamonds, R. Mallet, F.R.S., 192; J. B. Hannay, 241, 255  
 Asia, Central, Geology of, 348  
 Asterabad, the Province of, 281  
 Astigmatism, Dr. Tempest Anderson on, 476  
 Astronomical Column, 18, 67, 88, 112, 131, 156, 184, 205, 231, 276, 301, 347, 374, 399, 454, 466, 495, 541, 569, 593, 616  
 Astronomy, Prof. Asaph Hall on the progress of, 570  
 Atmospheric Phenomenon, 362, 607  
 Atoms, Vortex, S. Tolver Preston, 121  
 Atti della R. Accademia dei Lincei, 234  
 Audiphone, a New, Thos. Fletcher, 145  
 Audition, Binaural, Prof. Graham Bell's Experiment in, 586  
 August Perseids of 1880, W. F. Denning, 470  
 Aurora: the Inevitable Test for, Prof. Piazz Smyth, 76; Warren De La Rue, F.R.S., and Hugo W. Muller, F.R.S., 96; J. R. Capron, 291; Height of the, John I. Plummer, 362; Aurora in Scotland, 373; Observations of Auroræ on August 12 and 13, Ralph Copeland, 510; Auroras in America, 594; Aurora Borealis, the, Warren De La Rue, F.R.S., and Hugo W. Muller, F.R.S., 33; Robert H. Scott, F.R.S., 33; Aurora Borealis and its Colours, T. W. Backhouse, 145; Warren De La Rue, F.R.S., and Hugo W. Muller, F.R.S., 169; Aurora Borealis and Magnetic Storms, Rev. S. J. Perry, F.R.S., 361; J. A. B. Oliver, 361; F. J. Mott, 361; Auroral Observations, Prof. Sophus Tromholt, 192  
 "Australian Orchids," R. O. Fitzgerald, 53  
 Australia, Meteorology of South, C. Mann, 120; C. Todd, 120  
 Australia, a supposed Survivor of Leichhardt's Expedition, 18  
 "Automatic Multiplier and Calculator," J. Sawyer, 316  
 Ayrton (Prof. W. E.), Seeing by Telegraphy, 31; Wire Torsion, 604; on Technical Education, 616  
 Axon (William E.), Stone in the Nest of the Swallow, 242  
 Azores, supposed New Island in the, Prof. T. E. Thorpe, F.R.S., 509
- Bach (Albertus B.), Lecture at Royal Academy of Music on the Cultivation of the Voice, and his Resonator, 204  
 Backhouse (T. W.), Aurora Borealis and its Colours, 145  
 "Bacterium fœtidum: an Organism Associated with Profuse Sweating from the Soles of the Feet," Gen. Thin, M.D., 209  
 Baer, Karl Ernst von, proposed Monument to, 64  
 Bailly (Prof. W. Whitman), Intellect in Brutes, 607  
 Bailion and Decaisne, 12  
 Bailion (Prof.), on a Case of Apparent Insectivory, 277  
 Balfour (F. M., F.R.S.), Address in Section D at the British Association, 417; "Comparative Embryology," Prof. E. Ray Lankester, F.R.S., 601  
 Balfour (Dr. J. B.), on Socotra, 477  
 Ball Lightning, W. F. Smith, 267  
 Balloons: as Advertising Mediums, 17; Balloon Expedition from France to England, 111; another project for reaching the North Pole by, 134; Photographs from a, 183, 204; Balloon Accident at Le Mans, 253; new Scheme for Directing, W. de Fonvielle, 304; Manufacture of War Balloons in France, 346; Accident to an Aeronautist, 374; Ascent at Cherbourg, 398; Balloon Contest in London, 441; Balloon Society of Great Britain, 441, 495; Military Ballooning, 441; Balloon Contest at the Crystal Palace, 519, 592, 615; Proposed Captive at Milan, 615  
 Barfoed (Dr. Chr. Th.), "Lehrbuch der organischen Qualitativen Analyse," 581  
 Barrow-in-Furness, Summer Meeting of the Institution of Mechanical Engineers, 300  
 Barrows, Round and Long, Prof. Rolleston on, 478  
 Bathurst, near Tuena, Discovery of Gold in, 275  
 Batrachia, on the Structure and Development of the Skull in the, W. K. Parker, F.R.S., 161  
 Battery, Secondary, a New, 521  
 Bautzen, Discovery of Ancient Burial-Ground near, 66  
 Bavaria, Prof. H. Ohlenschlager's Prehistoric Map of, 68  
 Bay of Biscay, French Deep-Sea Exploration of, Dr. J. Gwyn Jeffreys, F.R.S., 468  
 Beaumont (Col.), Air-Engine, 567  
 Becquerel (M. Henri), on the Magneto-Optic Properties of Gases, 280  
 Bedfordshire Pomona, 615  
 Bees, Exhibition of Apparatus relating to, 17  
 Bee-Keeping, English and American Works on, 433  
 Beetles, Monstrous, 520  
 Beetles, Branch-Cutting, Fritz Müller, 533  
 Behnke (Emil), "The Mechanism of the Human Voice," 239  
 "Belfast Lough, Birds, Fishes, and Cetacea commonly frequenting," Robert Lloyd Patterson, 289  
 Belgium, the National Exhibition at Brussels, 345; the Geology of, 348  
 Bell (Prof. Graham), Photophone, Prof. S. P. Thompson, 481; Selenium and the Photophone, 500; Experiments in Binaural Audition, 586  
 Bennett (A. W.), the Classification of Cryptogams, 451  
 Bergsma (Dr. P. A.), Rainfall of the East Indian Archipelago, 434  
 Berlin, Formation of Society of Zoology at, 65; the Geographical Society of, 254, 618, 624; Anthropological Congress at, 345  
 Bermuda, Remarkable Discovery of a Murder in, H. N. Moseley, 170  
 Berthelot's Essay on Chemical Dynamics, 285  
 Beryllium, 350  
 Bessmer (Sir Henry, F.R.S.), Presentation of the Freedom of the City of London to, 64  
 Betti (Prof. E.), "Teoria delle Forze Newtoniane e sui applicazioni all' Elettrostatica e al Magnetismo," 557  
 Bibliography, the "Ronalds" Catalogue of Works on Electricity, Magnetism, &c., 87  
 Bichromate Battery, an Improved, 375  
 Bidie (Dr. G.), Calcareous Concretions in Timber, 169  
 Biederman (Dr. Richard), Death of, 87  
 Binary Stars a Centauri, 399, 541;  $\delta$  Pegasi, 467;  $\delta$  Equulei, 593  
 Binaural Audition, Prof. Graham Bell's Experiments in, 586  
 Binocular Glasses, the Inventor of, 567  
 Binomio di Newton, Ignazio Casaletti, 582  
 Biological Notes, 112, 277, 520, 594  
 Biology, a New Term Wanted, D. Sharp, 364  
 Bird (Isabella), "Unbeaten Tracks in Japan," 610  
 Birds, the Songs of, 97; James Macfadzean, 12; Prof. Alfred Newton, F.R.S., 122; Frank J. Allen, 122; Migratory, at Lighthouses, 25; Notes of—Wild Swans, J. Birmingham, 171; "Birds, Fishes, and Cetacea commonly frequenting Belfast Lough," Robert Lloyd Patterson, 289; the Toothed Birds of Kansas, 457; Migration of, Prof. Newton, F.R.S., 477; Classification of, Dr. P. L. Selater, F.R.S., 549  
 Birmingham Philosophical Society's Fund for the Endowment of Original Research, 203, 299  
 Birmingham, Mason Science College, 514; Prof. Huxley at, 16  
 Birmingham Natural History Society, 539  
 Birmingham (John), Notes of the Cuckoo, 76; Variability of 60 Caneri, 76; Wild Swans—Notes of Birds, 171; Chipped Flints, 319; a New Red Star, 408  
 Bismuth, the Density of Fluid, 448  
 Black Beetles and Yeast, 11  
 Blight, Mosquito, Flies, &c., Protection against, Wm. Chappell, F.S.A., 11  
 Blowpipe Analysis, Alphabetical Manual of, Col. W. A. Ross, 336  
 Blue Pike, American, Parasite on, 114  
 Blyth (James), on Currents produced by Friction between Conducting Substances, and on a New Form of Telephone Receiver, 330  
 Boguslawski on Ocean Temperature, 114  
 Bohemian Physicians and Naturalists, Congress of, 379  
 Books, &c., Recall of Appearance of, Cornelius Walford, 220  
 Borchardt (Prof. C. W.), Death of, 251  
 Borneo, Geological Formation of Soil of, 41  
 Boston, U.S., Meeting of the American Association at, 345, 397, 424, 493; American Academy of Arts and Sciences, 332  
 Botany: Curious Botanical Phenomenon, 30; Prof. Thistelton Dyer on Botanic Gardens, 39; Safe Arrival of Botanical Col-

- lections from Socotra at Kew, 64; New Botanical Work by Dr. Dodel-Port, 87; Text-Book of Botany, Prof. K. Prantl, 216; "Botanische Jahrbücher," A. Engler, 434; Botanical Text-Book, Prof. Asa Gray, 482; the Jamaica Hurricane and the Botanical Gardens, D. Morris, 538; "Botanical Gazette," Indiana, 568
- Bottomley (J. J.), the Elasticity of Wires, 447
- Bottomley (J. T.), Experiment with Glass Tubes, 291
- Bove (Lieut.), proposed Arctic Expedition, 42
- Bower (F. Orpen), Germination of *Wolwitschia mirabilis*, 590; Sieve-Tubes of Dicotyledonous Plants, 602
- Brain, 456
- Brain Dynamics, on a Point Relating to, S. Tolver Preston, 29; G. J. Romanes, F.R.S., 75; Rev. W. Clement Ley, 121; S. Tolver Preston, 121
- "Brain as an Organ of Mind," Dr. H. Charlton Bastian, F.R.S., 381
- Braithwaite (Dr. R.), "Sphagnaceæ, or Peat-Mosses of Europe and North America," 556
- Branch-cutting Beetles, Fritz Müller, 533
- Breath, Temperature of, 607; Dr. R. E. DuRoi, 241, 584; C. J. McNally, 534
- Bregut (M. Antoine), Recent Advances in Telegraphy, 18
- Bremon (C. McPherson de), Lightning Conductors, 382
- Brieg, Switzerland, Shock of Earthquake at, 230
- Bristol, University College, 494
- BRITISH ASSOCIATION: Meeting at Swansea, Officers and Preliminary arrangements, 181, 383; and Provincial Scientific Societies, John Hopkinson, 310, 440; the Geology of Swansea, 323; Excursions, &c., 324; Inaugural Address of the President, Dr. Andrew Crombie Ramsay, F.R.S., 383; the Natural History Collections and the, 410; Excursions, *Soirées*, Evening Lectures, &c., 410, 411; the Annual Grants, 411, 442; Report on the Best Means for the Development of Light from Coal Gas, 442; Report on Underground Temperatures, 442; Report on the Specific Inductive Capacity of a Good Sprengel Vacuum, 443; Report on the Ultra-Violet Spectra by Prof. A. K. Huntington, 444; on the Spectra of Metalloids, Dr. A. Schuster, F.R.S., 444; Report of the Committee on Erratic Blocks, 444; Report on the Exploration of Caves in the South of Ireland, 445; Report on the Carboniferous Polyzoa, 445; Report on the "Geological Record," 445; Sixteenth Report of the Committee for Exploring Kent's Cavern, 445; Report on H.M. Inspectors of Schools and the Science Subjects of the Code, 445; Report on the Influence of Bodily Exercise on the Elimination of Nitrogen, 445; Report on the Tertiary Flora of the Basalts of the North of Ireland, W. H. Bailey, 476; Report on the Viviparous Nature of the Ichthyosauri, Prof. H. C. Seeley, 476; the Sixth Report of the Underground Water Committee, 476; Report on the present State of our Knowledge of the Crustacea, C. Spence Bate, F.R.S., 476
- Section A (Mathematics and Physics).*—Opening Address by the President, Prof. W. Grylls Adams, F.R.S., 411; on some Laws which regulate the Succession of Temperature and Rainfall in the Climate of London, H. Courtenay Fox, 455; W. H. Preece on the Best Form to give to Lightning Conductors, 446; Richard Anderson on the Necessity for a Regular Inspection of Lightning Conductors, 446; Sir William Thomson on a Method of Measuring Contact Electricity, 446; Sir William Thomson on a Method of Determining without Mechanism the Limiting Steam-Liquid Temperature of a Fluid, 446; G. F. Fitzgerald on the Possibility of Originating Wave-Disturbances in the Ether, 446; W. Ladd on the Best Form of Magnet for Magneto-Machines, 446; J. J. Bottomley on the Elasticity of Wires, 447; Prof. W. G. Adams on the Comparison of Declination Magnetographs at various places, 447; Prof. G. H. Minchin on Photo-Electricity, 447; Prof. S. P. Thompson on Electric Convection Currents, 447; Hon. F. A. R. Russell on "Experiments on Thin Films of Water, with Regard to the Absorption of Radiant Heat," 447; Dr. Tempest Anderson on an Improved Apparatus for the Objective Estimation of Astigmatism, 476
- Section B (Chemical Science).*—Opening Address of the President, Dr. J. H. Gilbert, F.R.S., 472; on the Influence of Water on the Union of Carbonic Oxide with Oxygen at a High Temperature, Harold B. Dixon, 447; Metallic Compounds containing Organic Radicals, J. Sakurai, 448; on some Relations between the Atomic Volumes of Certain Elements and the Heat of Formation of some of their Compounds, Walter Weldon, 448; on the Specific Rotary Power of Cane and Invert-Sugar, Alfred H. Allen, 448; on the Identification of the Coal-Tar Colours, John Spiller, 448; on the Density of Fluid Bismuth, W. C. Roberts, F.R.S., and Thomas Wrightson, 448; on Petroleum Spirit and Analogous Liquids, A. H. Allen, 448; on the so-called Normal Solution for Volumetric Analysis, A. H. Allen, 448; on the Determination of the Loss of Heat in Steam Boilers from Incrustation, Wm. Thomson, 448; on the Identification of the Ink used in Writing as evidence in Cases of Libel, Forgery, &c., W. Thomson, 448; the Effects of Magnesia on Vegetation, Major-Gen. Scott, F.R.S., 448; on Bleaching-powder Residues, J. F. W. Hodges, 448; on the Refraction Equivalent of Diamond and the Carbon Compounds, Dr. J. H. Gladstone, F.R.S., 449; on a New Process for the Production from Aluminous Minerals of Sulphate of Alumina from Iron, J. W. Kynaston, 449; on a New Process for separating Silver from Copper Ores and Reguluses, by W. Henderson, 449
- Section C (Geology).*—Opening Address by the President, H. C. Sorby, LL.D., F.R.S., 390; Notes on the Sub-Marine Geology of the English Channel off the Coast of South Devon, A. R. Hunt, F.G.S., 449; on the Site of a Palæolithic Implement Manufactory at Crayford, Kent, F. C. Spurrell, 449; on the Island of Torgshaten, Norway, and on the Influence of Joints on Denudation, Prof. W. J. Sollas, 449; on the Contortion of a Quartz Vein in the Mica Schist from Bodo, Norway, Prof. W. J. Sollas, 449; on the Geological Age and Relations of the Sewalik, and Pikerini Vertebrate and Invertebrate Faunas, W. T. Blanford, 449; on the Relations to be Established between Coast-line Direction represented by Great Circles on the Globe and the Localities marked by Earthquakes in Europe, Prof. J. P. O'Reilly, 449; on the Sandstones and Grits of the Lower and Middle Series of the Bristol Coal-Fields, E. Wethered, 449; on the Hiatus said to have been found in the Rocks of West Cork, G. H. Kinahan, 449; Note on the Range of the Lower Tertiaries of East Suffolk, W. H. Dalton, 450; Proof of the Organic Nature of *Lozoon Canadense*, Charles Moore, 450; on the Post-Tertiary and Glacial Deposits of Kashmir, Lieut.-Col. Godwin-Austen, 450; on the Fault-Systems of Central and West Cornwall, J. H. Collins, 450; on the Geology of the Balearic Islands, Dr. Phénic, 450; on some Pre-Cambrian Rocks in the Harlech Mountains, Dr. Hicks, 450; on the Action of Carbonic Acid on the Limestone, Prof. Boyd Dawkins, F.R.S., 450; on a Raised Beach with Diluvial Drift in Rhos Sili Bay, Gower; on the Geological Evidence of the Submergence of the South-West of Europe during the Early Human Period, Prof. Prestwich, 450; on a Striated Stone from the Trias of Portishhead; on the Action of a Lichen on Limestone; on Sponge Spicules from the Chalk of Trimmingham, Norfolk, Prof. W. J. Sollas, 451; on the Geological Literature of Wales, W. Whitaker, 451; Sketch of the Geology of British Columbia, Dr. G. M. Dawson, jun., 451; Notes on the Occurrence of Stone Implements in the Coast Laterite, South of Madras, and in High-Level Gravel and other Formations in the South Mahratta Country, R. Bruce Foote, 451; on the Pre-Glacial Contour and Post-Glacial Denudation of the North-West of England, C. E. De Rance, 451
- Section D (Biology).*—Opening Address by the President, Dr. A. C. L. G. Günther, F.R.S., 393; on the Classification of Cryptogams, A. W. Bennett, 451; Further Remarks on the Mollusca of the Mediterranean, Dr. Gwyn Jeffreys, F.R.S., 452, 477; on the Migration of Birds, and Messrs. Brown and Corderaux's Method of obtaining Systematic Observations of the same at Lighthouses and Lightships, Prof. Newton, F.R.S., 477
- Department of Anatomy and Physiology.*—Address by F. M. Balfour, F.R.S., 417; Dr. J. B. Balfour on Socotra, 477
- Department of Anthropology.*—Address by F. W. Rudler, F.G.S., 421; on Anthropological Colour-Phenomena in Belgium and Elsewhere, J. Beddoe, M.D., F.R.S., 477; Pocket Registrar for Anthropological Purposes, Francis Galton, F.R.S., 478; on the Retention of Ancient and Prehistoric Customs in the Pyrenees, Dr. Phénic, F.S.A., 478; Mr. Thomas Plumet, on an Ancient Seltle-



- ment in the Coal Box near Bohoe, 478; Prof. Rolleston on the Structure of Round and Long Barrows, 478; Miss Buckland on Surgery and Superstition in Neolithic Times, 478
- Section E (Geography).—The Royal Geographical Society's East African Expedition, 479; Col. Tanner on the Dara Nur and its Inhabitants, 479; the Galapagos Islands, by Capt. Markham, 480*
- "British Islands, A Short Geography of," by J. R. and Alice S. Green, 119
- British Medical Association at Cambridge, 64, 372; Gold Medal of, 209
- British Museum, Fresh Maps at the, 184; Report of the, 246; the Electric Light at, 299; the Removal of the Natural History Collections to South Kensington, 328; the Attendants, Wm. Flinders Petrie, 338; Discussion in the House of Commons on, 345
- British Wild Flowers, a New and Easy Method of Studying, by Natural Analysis, P. A. Messer, 532
- British Columbia, the Trees of, 592
- Broca (Paul), Obituary Notice of, 249; H. F. C. ten Kate on, 292; Proposed Erection of a Statue to, 299
- Brock (H. R. J.), Evolution of Dibranchiate Cephalopods, 277
- Brooklyn, Centre of the, at Home, J. Innes Rogers, 559
- Bromine, Chlorine, and Iodine, Densities of at High Temperatures, 278
- Bronze Statuary and the Process of Electrodeposition, 18
- Bronze Implements, Discovery of in Sardinia, 540
- "Brook's Popular Botany," 347
- Brauer's, International Exhibition of, 131, 315; Proposed International Congress of Commerce and Industry at, 275
- Brates, Intellect in, F. Lewis, 25; W. W. Nicholls, 266; Rev. George Henslow, 319; Surgeon-Major Curran, 339; Henry MacCormack, 362; L. P. Guatacap, 408; Consul E. L. Howard, 607; Prof. W. Whitman Bailey, 607
- Buchanan (J. Y.), Compressibility of Glass, 377
- Buchanan (J.), "Manual of the Indigenous Grasses of New Zealand," 532
- Buckland (Miss A. W.), on Surgery and Superstitions in Neolithic Times, 478
- Buitenzorg, Java, Dr. M. Neuf, appointed Director of Botanical Gardens of, 64
- of the Tongary Botanical Club, 136
- of the United States Geological and Geographical
- Bulletin de la Société d'Anthropologie de Paris, 290, 331, 575
- Bulletin de l'Académie Royale des Sciences de Belgique, 230, 257, 331, 455, 525, 552
- Banbury (E. H.), "History of Ancient Geography," 333
- Bun on Barner, New Form of, 322
- Bardana (S. W.), his Report on the Proposed Lick Observatory, 515
- Buchmann (Dr.), Death of, 66
- Byerly (W. E.), Differential Calculus, 509
- Coddie-Hies, Monograph on, R. McLachlan, F.R.S., 314
- Calantariens (Dr.), on Crystal Ice, 130
- Calcareous Concretions in Timber, Dr. G. Bidie, 169
- Cambier (M.) on Recent Earthquakes on Lake Tanganyika, 67
- Cambridge: Proposed Admission of Women to Academic Degree, 70; the University Commission, 623
- Candlette (Gonardo), Il Binomio di Newton, 532
- Camp on the Malvern Hills, 211
- "Camp in the Caribbees; the Adventures of a Naturalist in the Lesser Antilles," F. A. Ober, 214
- Cancer 69, Variability of, John Birmingham, 76
- Cape Town Botanic Gardens, 517
- Capello (J.), Comparative Curves in Terrestrial Magnetism, 220
- Capron (J. Rand), Storm Effects, 290; Inevitable Test for Aurora, 291
- Carbon and Carbon Compounds, Prof. A. S. Herschel, 320
- Carbon, Electrical Conductivity of, 514
- Carbon, on the Spectra of the Compounds of, with Hydrogen and Nitrogen, Professors Liebig and Dewar, 620
- Carbon Compounds and the Refraction Equivalents, 279
- Carbon Compounds, Chemistry of the, M. M. Pattison Muir, 519
- Carbon Compounds and Phosphorescence, 543
- Carbonic Acid? does Chlorophyll Decompose, Dr. J. W. Draper, 29
- Carboniferous Forest at Oldham, Jas. Nield, 30
- Caribbean Sea, 242
- Caribbees, Camps in the, the Adventures of a Naturalist in the Lesser Antilles, F. A. Ober, 214
- Carlisle, Royal Agricultural Society at, 253, 275
- Carminchael (Prof.) on the Vibrations of a Flame, 18
- Carnelley (Dr. Thos.), Conditions Necessary for the Existence of Matter in the Liquid State, 434; Existence of Ice at High Temperatures, 434, 510; Ice under Pressure, 583
- Carnivorous Wasps, 31
- Carpenter (Dr. W. B., F.R.S.), Ocean Circulation, 217
- Carr (G. S.), Synopsis of Elementary Results in Pure and Applied Mathematics, 582
- "Carriage, the Waiting," W. M. F. Petrie, 534
- Cas el, General Meeting of the German Geometrical Society at, 16
- Caves in South of Ireland, 445
- Caverns, Discovery of Natural, in the Neighbourhood of West Harpree, 204
- Celestial Object, a Novel, Prof. E. C. Pickering, 483
- Celluloid, 370
- Centrifugal Machine for Schools, 375
- Cephalopods, Dibranchiate, Evolution of, Dr. J. Brock on, 277
- Ceraski's New Variable Star, 616; Prof. E. C. Pickering, 603; Geo. Knott, 603
- "Ceylon Coffee Soils and Manures; Report to the Ceylon Coffee Planters' Association," John Hughes, 144
- Châlets, Swiss, Rev. Geo. Henslow, 534; H. N. Moseley, 559
- Chamblandes, Canton Vaud, Discovery of Walled Tombs at, 40
- Champagne, the manufacture of, 397
- Champlain Iron Region, New Mineral from the, 278
- Chantrell (J. F.), Algae, 382
- Chappell (Wm., F.S.A.), Protection against Mosquitoes, Flier, and Blight, 11
- Charney (M. Desiré), Exploration of the Ancient Remains of Mexico, 42
- Chatel, Pa-cination, 484
- Chemistry: Wurtz's Elements of Modern Chemistry, 8; Chemical Society, 21, 47, 139, 162, 211; Grants from Research Fund of, 228; Chemical Notes, 278, 349, 542, 617; Chemical Dynamics, M. M. Pattison Muir, 285; Tilden's Qualitative Analysis, 360; Agricultural Chemistry, Dr. J. H. Gilbert, 472, 497, 523; "Miller's Chemistry of the Carbon Compounds," M. M. Pattison Muir, 530; Prof. H. E. Armstrong, F.R.S., on the same, 559; Recent Chemical Research, M. M. Pattison Muir, 608
- Cherbourg, Balloon Ascent at, 398
- Chicago Observatory, 301
- Chimborazo, E. Whymper's Ascent of, 19
- China, Easton's Journey in the North-West of, 41; Chinese Alligators, 112; Rainfall of Southern China, 431; Chinese Geographical Names, 618
- Chlorine, Bromine, and Iodine, Densities of, at High Temperatures, 278
- Chlorophyll, does it decompose Carbonic Acid? Dr. J. W. Chlorophyllan, Hoppe-Seyler on, 279
- Christie (W. H. M.), Spectrum of Hartwig's Comet, 557
- Chrystal (Prof. G.), Experiments with the Wire Telephone on strongly magnetic Metals, 168, 303
- Church (Prof. A. H.), Lectures on Agricultural Chemistry, 275; Agricultural Chemistry, 300
- Church (John A.), Subterranean Kaolinisation, 317
- Claudian (G.), Spectroscopic Investigations, 575
- Ciliated Plant, a New Green, 521
- Cinchona Cultivation, 568, 592
- Cirencester, Royal Agricultural College, Establishment of Two Scholarships, 185
- Citric Acid from Glycerin, Grimaux and Adam, 349, 567, 585
- City and Guilds of London Institute, 17, 44, 183
- Clarens, Remarkable Electrical Phenomenon at, 204
- Clark (Lieut. J. W.), Utricularia, 318
- Clay, London, Diatoms in the, W. H. Shrubsole, 221
- Claypole (Prof. E. W.), Stags' Horns, 145; Minerva Ornaments, 193
- Clifford (Prof. W. K., F.R.S.), Energy and Force, 122

- Climates, Geological, Rev. Prof. Samuel Haughton, F.R.S., 532; Dr. P. Martin Duncan, F.R.S., 559
- Clocks, Synchronised, in France, 182
- Clocks, Pneumatic, 226
- Clöe's Thermoelectric Pile, Improvement of, 19
- Cloud Classification, 96; Rev. W. Clement Ley, 144
- Clouds, a New Form of Nefoscope, 132
- Coal Measures, Plants of the, Prof. W. C. Williamson, F.R.S., 281
- Coal Mines, Explosions in, 300
- Coal Mines in Japan, 616
- Coal-Tar Colours, John Spiller, 448
- Coasts, Present System of Lighting our, 229
- Colæca Penduliflora (Hook. Fil.), on the Fertilisation of, Dr. A. Ernst, 148
- Coffee, Ceylon, Soils and Manures, John Hughes, 144
- Coffee Disease in New Granada, Dr. A. Ernst, 292
- Coffee Trees and Locusts, Dr. A. Ernst, 408
- Coleoptera, Parthenogenesis in the, Rev. J. A. Osborne, 509
- Colladon (Prof.), on Thunderstorm in Geneva, 65
- Collier (Mr.), Crystallisable Sugar, 278
- Colour Combinations, C. J. Woodward, 171
- Colour Phenomena in Belgium, 477
- Colour Sense of the Maris, 494
- Colour-Blindness in the United States, 65, 373; proposed Commission on, 567
- Colours, Handbook of, for Painters, W. J. Muckley, 357
- Columbus (Christopher), proposed Memorial of, 65
- Colvée (Don Pablo), "Lusayo sobre una nueva enfermedad del Olivo," 29
- Coma, Rudimentary, in, Godetia, 595
- Comets: Comet of 1106, 18; Second of 1880, 67, 89; Great Southern of 1880, 156, 231, 399; Cape Observations of Comet 1880 (1), 374; Comets 1880 *d* and *e*, 594; Winnecke's, 131; Paye's, 156, 301, 466, 593; Schaberle's, 467; Swift's New Comet, 467; Westphal's Comet, 184; Third Comet of 1822, 205; the Comet of 1668, 276; Comets of Short Period, 347; a New, 455, 542; Spectrum, &c., of Hartwig's Comet, W. H. M. Christie, 557, 569, 593
- Coming of Age of the Origin of Species, Prof. T. H. Huxley, F.R.S., 1
- Comparative Anatomy of Man, 1; Prof. Flower, F.R.S., 59
- "Comparative Embryology," Francis M. Balfour's, F.R.S., Prof. E. Ray Lankester, F.R.S., 601
- "Compendium der Naturwissenschaften an der Schule zu Fulda in IX. Jahrhundert," 229
- Compressibility of Glass, J. Y. Buchanan, 377
- Corncock Lode, the Heat of the, J. A. Phillips, 337
- Conics, Elementary Geometry of, C. Taylor, 603
- Confere, a Chapter in the History of the, J. Stukie Gardner, 199
- Constance (Lake of), Solar Halo on, 111
- Continuous Manifolds, on the Simplest, of Two Dimensions and of Finite Extent, F. W. Frankland, 170
- Continuous Manifold, the Simplest, of Two Dimensions and of Finite Extent, C. J. Monro, 218
- Cook (A. J.), "Manual of the Apiary," 433
- Copeland (Ralph), Observations of Aurora, August 12 and 13, 510
- Copping (Dr. R. W.), "Chipped Arrow heads," 97
- Coral Reefs and Islands, John Murray on, 23, 351; Prof. Joseph LeConte, 558
- Corals, Fossil, 112
- "Coronella laevis," H. King, 220
- Corazon, E. Whympcr's Ascent of, 19
- Corea, the Japanese Trading Station in, 596
- Cornea, Optical Property of the, 595
- Cornwall, Birds of, Edward Hearle Rodd, 507
- Cotopaxi, E. Whympcr's Ascent of, 19
- Coues (Dr. Elliott), "Ornithological Bibliography," 373
- Cows, Phosphoric Acid in the Urine of, 595
- Crabs, Fiddler, 278
- Crannog, a Scottish, 13, 34
- Crayfish, Ural, W. H. Twelvetrees, 30
- Crayfish in France, 494
- Crickets as Housepets in Lisbon, 540
- Croll (Dr. J., F.R.S.), Aqueous Vapour in Relation to Perpetual Snow, 191
- Crookes (W., F.R.S.), Contributions to Molecular Physics in High Vacuo, 101, 125; a Fourth State of Matter, 153.
- Cross (Chas. R.), Permanent Record of Foucault's Pendulum Experiment, 240
- Cryptogamic Society of Scotland, Annual Conference of, 398
- Cryptogams, the Classification of, A. W. Barrett, 451
- Crystal Ice, 54, 139, 145
- Crystallisable Sugar, Mr. Collier on, 278
- Cuckoo, Notes of the, John Birmingham, 76
- Culture and Science, Prof. T. H. Huxley, F.R.S., 545
- Cumming (L.), Effects of Lightning on Trees, 220
- Cup-Stones, Cup-Marked Stones, or Cups and Kings, 221; Morton Middleton, jun., 77; Romilly Allen, 97; James Linn, 122
- Curran (Surgeon-Major W.), Fascination in Man, 318; Strange Method of Crossing a Torrent, 339; Intellect in Brutes, 339
- Currents produced by Friction between Conducting Substances, James Blyth, 330
- Curves, Comparative, in Terrestrial Magnetism, Rev. S. J. Perry, F.R.S., 120; J. Capello, 223
- Cuttlefish, Large, 113
- Dancer (J. B.), Quassia and Moquitos, 335
- Danzig, Meeting of German Association at, 298, 493, 527, 530
- Dara Nur and its Inhabitants, 479
- Darwin (G. H., F.R.S.), Preton on Vortex Atoms, 95
- Darwin's Theory of the Origin of Coral Reefs and Islands, 351
- Darwinian Essays, Two, Alfred R. Wallace, 141
- Darwinism, Degeneration, a Chapter in, Prof. E. Ray Lankester, F.R.S., 141
- Daubrée (M.), on Descartes, 183
- "Davis Lectures for 1880," 130
- Dawkins (Prof. Boyd, F.R.S.), "Early Man in Britain," 82
- Dawson (Principal J. W., F.R.S.), Fossil Men, 82; Eozoic or Palæozoic, 382
- Death by Hanging, 595
- Deceisne and Baillon, 12
- Dechevrens (Père Marc), on Typhoon, 183
- Deep-Sea Animals, Organs of, M. O. Grimm on, 278
- Deep-Sea Exploration, a French Expedition, 134, 345, 372; of the Bay of Biscay, Dr. J. Gwyn Jeffreys, F.R.S., 468
- Deep-Sea Sounding and Dredging, 508
- Deer, Domestication of, 278
- "Degeneration, a Chapter in Darwinism," Prof. E. Ray Lankester, F.R.S., 141
- De La Rue (Warren, F.R.S.), the Aurora Borealis, 33; the Inevitable Test for Aurora, 96; Aurora Borealis and its Colours, 169; Experimental Researches in Electricity, 149, 174, 196; on some Points connected with Terrestrial Magnetism, 169
- Dolocyathus italicus* Ed. and H., P. Martin Duncan, 531
- Denning (W. F.), the Shower of August Perseids, 1880, 470
- Densities of Chlorine, Bromine, and Iodine at High Temperatures, 278
- Depraved Tastes in Animal, 329, 339; Arthur Nichols, 339; F. R. Greenwood, 364
- Deprez's (M. Marcel), Apparatus for Transmitting a Movement of Rotation by Electricity, 10; Galvanometer for Strong Currents, 246; New Electric Motor, 301
- Descartes, M. Daubré on, 183
- "Descent, Studies on the Theory of," Dr. Aug. Weismann, 141
- Desmarests (M. Paul), Success of his Balloon Photographs, 204
- Determinants, the Theory of, R. F. Scott, 458
- Diamonds, Artificial, R. Mallet, F.R.S., 192; J. B. Hannay, 241, 255
- Diamonds and the Carbon Compounds, the Refraction Equivalent of, Dr. J. H. Gladstone, F.R.S., 449
- Diatoms in the London Clay, W. H. Shrubsole, 221
- Dibranchiate Cephalopod, Evolution of, Dr. J. Brock on, 277
- Dickins (Fredk. V.), Luminous Painting, 121; "Chiu-hingura": a Japanese Romance, 288
- Dicotyledonous Plants, Sieve-Tubes of, F. Orpen Bower, 602
- Differential Calculus, Rice and Johnson's Treatise on, 509; Elements of, W. E. Byerly, 509
- Digestion in Plants, 521
- Dilation of the Iris, 220
- Diluvial Bones, Discovery of, at Weltend, 66
- Dimorphism in Nature on June 17, Prof. E. Ray Lankester, F.R.S., 361
- Dinosaurs, Sternum in, 113
- Distant (W. L.), Stone Arrow Heads, 11; Argentine Entomology, 238

- ; and Living in Irrespirable Atmospheres, Fleuss's Method, 32
- Dixon (W. A.), Meteorology of a Guano Island, 254
- Dobson (G. E.), an Ammelidan Entozoon, 583
- Dog, Prolonged Fast of a, 347
- Domestication of Deer, 278
- Dominica, Recent Volcanic Eruption in, Edmund Watt, 77 ; Volcanic Dust from, M. E. Wadsworth, 266
- Dorn (Herr), the Propagation of Electricity, 280
- Double-Stars: 85 Pegasi, 205 ; the Colours of, C. S. Peirce, 201
- Draper (Dr. J. W.), Does Chlorophyll Decompose Carbonic Acid? 29
- Draper (Prof. Henry), Photograph of the Nebula of Orion, 583
- Dredging, Deep-Sea Sounding and, 508
- Drift of Oldham, Peat Bed in, G. H. Morton, 511 ; P. O. Hutchinson, 583 ; James Nichol, 583
- Dudgeon (Dr. R. E.), Temperature of the Breath, 241, 584
- Dumas (M.), Occluding Gases, Experiments on, 89 ; Presentation of Civic Crown to, 109
- Duncan (W. S.), Specialised and United Palaeontological Research, 120
- Duncan (Prof. P. Martin), the Late Count L. F. de Pourtales, 337 ; *Dolichoptilus italicus*, Ed. and H., 534 ; Geological Climates, 550
- Duparquet (Père) on Ovampo-Land, 41
- Dusseldorf, Meeting of Iron and Steel Institute, 87, 452
- Dust, Fall of, 76
- Dutton (Capt. C. E.), the High Plateau of Utah, Prof. A. Geikie, F.R.S., 324
- Dyaks, a Forest People of Borneo, Portraits of, 157
- Dyer (Prof. Thibetson), on the Botanical Enterprise of the Empire, 39
- Dynamics, Brain, on a Point relating to, S. Tolver Preston, 29 ; G. J. Romané, F.R.S., 75 ; Rev. W. Clement Ley, 121 ; S. Tolver Preston, 121
- Dynamics, a Treatise on Elementary, for the Use of Colleges and Schools, W. Garnett, 265
- Dynamics, Chemical, M. M. Patti on Muir, 285
- Dynastes hercules*, Dr. A. Ernst, 585
- Early Man in Britain, Prof. Boyd Dawkins, F.R.S., 82
- Earth-Current and Magnetic Disturbance, Wm. Ellis, 361
- Earthquakes: Observation, Prof. Milne, 64 ; at Hanz, 66 ; Prof. Palmieri on, 155 ; in Surrey, 230 ; at Brieg, Switzerland, 230 ; Further Accounts of the Earthquake in Switzerland, 252 ; in Manila, 276, 300 ; in Naples, 300 ; in Smyrna, 329 ; Hyde Clark, 363 ; in the Tyrol, 369 ; at Tribourg, 519 ; in Transylvania, 592 ; in Rangoon, 615
- East, the Sacred Book of the, Edited by I. Max Muller, Prof. A. H. Sayce on, 189
- East Indian Archipelago, Rainfall of the, 434
- Easton's Journey in the North-West of China, 41
- Echinoderms, Haemoglobin in, 505
- Echis carinata*, Sir J. Fayer, F.R.S., 124
- Eclipse, the Next Total Solar, 112
- Edelweiss, the, in England, 87
- Edinburgh, Royal Society, 23, 187, 284, 331
- Education Code, the New, 105
- Education, Elementary, 237
- Education Report, 298
- Education in New Zealand, 298
- Education Debate, the, 312
- Education, the Place of Science in, 529
- Edward (M. Betham), "Six Life Studies of Famous Women," 75
- Eggs, Double, T. Allwood, 78
- Eisenach, Formation of a "Thuringer Wald" Club at, 20
- Ekin (Charles), Water Supply, 221
- Elder-Pith, Magnetic Behaviour of, 18
- Electricity: Electric Currents, Effects of, on the Surfaces of Mutual Contact of Aqueous Solutions, G. Gore, F.R.S., 21 ; Electric Currents, some Thermal Effects of, W. H. Preece, 138 ; Electric Light: M. Jamin's New Electric Lamp, 17, 131, 355 ; Electric Light, Jablochkoff, 17 ; Jablochkoff's Electric Light in Paris, 17, 131 ; Dr. John Hopkinson, F.R.S., on, 42 ; Proposal to Light the Sheldonian Theatre, Oxford, by, 87 ; Wild Candles, Illumination of the Industrial Exhibition of Melan with, 131, 155 ; in Paris, 252 ; at the Palais Royal, Paris, 441 ; Electric Light as an Insect-Catcher, 567 ; Experiments in Electric Lighting at Boston, 593 ; Electrical Observations at Montsouris, 16 ; Dr. Siemens' Newest Electrical Results, 135 ; Curious Electric Phenomenon, F. T. Mott, 193 ; Electrical Phenomenon at Claren-, 204 ; Electrical Ring Figures, Prof. Keitlinger and Dr. Wächter on, 302 ; Electrical Stone-Breaker, 302 ; M. Marcel Deprez's Apparatus for Transmitting a Movement of Rotation by Electricity, 19 ; Instrument for Recording the Notes played on a Piano, 19 ; Kidout's Improved Thermo-Electric Apparatus, 22 ; the way Trees are Struck by Lightning, 65 ; Experiment, in Electricity, Prof. Lemstrom, 89 ; Electric Machine, "Holtz's," Prof. Righi on, 89 ; Electric Brakes on the French Eastern Railway, Achard, 110 ; Electricity and Horticulture, 135 ; Experimental Researches in Electricity, Warren De La Rue, F.R.S., Hugo W. Müller, F.R.S., 149, 174, 196 ; Electric Machine, an Immense, 206 ; Suggested System for the Transmission of Light by Electricity, 206 ; a New Relation between Light and Electricity, 207 ; the Inventor of the Electric Telegraph, 219 ; "Electricity and Magnetism," Keith Johnston's, 240 ; "Electricity and Magnetism, a Physical Treatise on," J. E. H. Gordon, 263 ; on the Propagation of Electricity, Her Dom, 280 ; M. Marcel Deprez's New Electric Motor, 301 ; a New Kind of Electric Repulsion, Dr. Arthur Schuster, F.R.S., 535 ; Electricity and Radiant Heat, 596
- Electrode, the Luminosity of a Negative, 133
- Electrode matter, Radiant, Dr. J. Puluj, 280
- Electrodeposition, Application of, in the Production of Bronze Statuary, 18
- Electrometer, a New Capillary, 157
- Electrometer Engine, a New, 543
- Electrophone (M. Marche), 131
- Elementary Education, 237
- Elephant Calf, the Mode of Suckling of the, 11
- "Elephant Sugar Cane," 518
- Ellis (Herbert), Stag's Horns, 221
- Ellis (A. J., F.R.S.), "Notes of Observations on Musical Beats," 234
- Ellis (Wm.), Magnetic and Earth-Current Disturbance, 361
- "Embryology, Comparative," Francis M. Balfour's, F.R.S., Prof. E. Ray Lankester, F.R.S., on, 601
- "Energy and Force," the late Prof. Clifford, F.R.S., J. F. Moulton on, 122
- England and Wales, on the Increase of Population in, R. Price Williams, 205
- Engler (Dr. A.), "Entwicklungs-geschichte der Pflanzenwelt," 190 ; "Botanische Jahrbücher," 434
- English Philology, Recent Progress of, Rev. A. H. Sayce, 167
- "Ensayo sobre una nueva Enfermedad del Olivo," Por Don Pablo Colvce, 29
- Entomozoon Living in Tree-Tops, 55
- Entomology: Entomological Society, 23, 92, 163, 308, 504, 623 ; Carnivorous Wasps, 31 ; Solving a Problem in Entomology, M. Vaysiere, 130 ; Argentine Entomology, W. L. Distant, 238 ; Entomological Club of the American Association, 397 ; Modern Entomology, Prof. S. H. Scudder, 550
- Entozoon, an Ammelidan, G. E. Dobson, 583
- Eozoic and Palaeozoic, Principal J. W. Dawson, F.R.S., 382
- Eriocaulon Canadense*, Charles Moore, 450
- Epping Forest and County of Essex, Naturalist's Field Club, meeting of, 110, 300, 540
- Ernst (Dr. A.) On the Fertilisation of *Cobea panduliflora* (Hook., Fil.), 148 ; Coffee Disease in New Granada, 292 ; Locusts and Coffee Trees, 408 ; *Dynastes hercules*, 585 ; What is Alreze? 585
- Erratic Blocks, British Association, Report on, 444
- "Estudios Físicos," Don Eduardo Lozano, 302
- "Estudio Micrográfico de algunos Basaltos de Ciudad-Real," Don Francisco Quiroga, 582
- Etna, apprehended Eruption of, 17 ; Prof. Silvestri on renewed activity of, 39 ; Ascent of, 171 ; Eruption of, 346, 465 ; Prof. O. Silvestri, G. F. Rodwell, 359 ; the Observatory, 373
- "Eucalyptographia," Baron F. von Mueller, F.R.S., 118
- Europe, a fragment of Primeval, Prof. A. Geikie, F.R.S., 400 ; Duke of Argyll, F.R.S., 407
- Evolution of the Vegetable Kingdom, W. B. Hemsley, 190
- Evolution of Dibranchiate Cephalopods, 277
- Evolution and Female Education, S. Tolver Preston, 485
- Excretion of Water by Leaves, Dr. J. W. Moll, 403

- Explosions, the Recent, 228, 265, 267; Prof. Herbert McLeod, 290, 337  
Explosion at Seaham Colliery, 464
- Falb (Herr Rudolf), Discoveries regarding "the Original Language of the Human Race," 66  
Famine, Indian, Commission, 553  
"Famous Women, Six Life Studies of," M. Betham Edwards, 75  
Faraday exhibiting Ghosts, 583  
Fascination, Surgeon-Major W. Curran, 318; Rev. T. R. R. Stebbing, 338, 534; Richard Hodgson, 383; Chatel, 484  
Fatigue, on the Law of, in the Work done by Men or Animals, Rev. Dr. Haughton, F.R.S., 128  
Faulds (Dr. Henry), on the Skin-Furrows of the Hand, 605  
Faye (M.), on the Physical Forces which have produced the Present Figure of the Earth, 206  
Faye's Comet, 156, 301, 466, 593  
Fayer (Sir J., F.R.S.), *Echis carinata*, 124; the Recent Gas Explosion, 265  
Female Education, Evolution and, S. Tolver Preston, 485  
Fermat's Asserted Prime-Form, 405  
"Fern Etchings: Illustrating all the Species of Ferns indigenous to the North-Eastern United States and Canada," J. Williamson, 168  
Fiddler Crabs, 278  
Fijian Burial Customs, Rev. Lorimer Fison, 22  
Films of Water and the Absorption of Radiant Heat, Hon. F. A. Rollo Russell, 447  
Fire-Ball, Rev. S. J. Perry, F.R.S., 362  
Fire-Damp, the Report of the French Commission on, 328  
Fish: First Decade of the United States Fish Commission, its Plan of Work and accomplished Results, Scientific and Economical, G. Brown Goode, 597  
Fison (Rev. Lorimer), Fijian Burial Customs, 22  
Fitzgerald (R. O.), Australian Orchids, 53  
Flame, Vibrations of, Prof. Cornichael, 18  
Fletcher (Thos.), a New Audiphone, 145; New Gas Furnace, 615  
Fletcher (L.) appointed Keeper of the Mineral Department of the British Museum, 203  
Fleuss's System of Diving and Living in Irrespirable Atmosphere, Dr. B. W. Richardson, F.R.S., 32  
Flie, Mosquitos, and Blight, Protection against, Wm. Chappell, F.S.A., 11  
Flies, Clouds of, in America, 518  
Flints, Chipped, J. Birmingham, 319  
Floating Grass in Queensland, 110  
Flora of Turkestan, Dr. Regel on, 19  
Florida, Singular Phenomenon seen off the Coast of, 301  
Flower (Prof. W. H., F.R.S.) at the Royal Institution, 16; "Comparative Anatomy of Man," 59, 78, 97  
Flowers, British Wild, F. A. Messer, 532  
Flowers, Familiar Wild, F. E. Hulme, 532  
Fluids, the Motion of, Horace Lamb, 145  
Fonvielle (W. de), New Scheme for Directing Balloons, 303  
"Force and Energy," the late Prof. Clifford, F.R.S., J. F. Moulton on, 122  
Forbes (Henry O.), Obituary Notice of Dr. Rudolf Scheffer, 12  
Forest Trees of North America, 111  
Fossil men, Prof. J. W. Dawson, F.R.S., 82  
Fossil Corals, 112  
Foster (Dr. M., F.R.S.), Gamgee's "Physiological Chemistry," 555  
Foucault's Pendulum Experiment, Permanent Record of, Chas. R. Cross, 240  
Fourth State of Matter, S. Tolver Preston, 192; E. Douglas Archibald, 218; Geo. E. Newton, 240  
Fox (H. Courtenay), the Succession of Temperature and Rain-fall in the Climate of London, 445  
France: Statues of Men of Science in, 39; the Telegraphic Service in, 40; French Association for the Advancement of Science, Meeting of, at Rheims, 154, 276, 372, 397; Arthur Young's Travels in, Prof. S. P. Thompson, 219; Geology of North, 348; Museum of National Antiquities at St. Germain, 441  
Frankfort-on-the-Main, Exhibitions to be held at, in 1881, 155  
Frankland (F. W.), on the Simplest Continuous Manifolds of Two Dimensions and of Finite Extent, 170; On a Mode of Explaining Transverse Vibrations of Light, 317  
Franklin Search Expedition, 544  
Freshwater Rhizopods of North America, J. Leidy, 165  
Freshwater Jelly Fish, the New, Prof. E. Ray Lankester, F.R.S., 147, 177, 190, 241, 316; Prof. J. Allman, F.R.S., 177, 218; G. J. Romanes, F.R.S., 177.  
Fribourg, Earthquake at, 519  
Friction, Experiments on the, of Air and Water, 207  
Frogs, "Experimental Researches on the True Relations of the Excitatory Process in," J. Burdon Sanderson, M.D., and F. J. M. Page, 137  
Fuego, Volcano of, 346; Eruption of, 441, 544  
Fungus, Inoculation for Insects, J. P. Leslie, 31; Goethe on, 64
- Galapagos Islands, 480  
Galton (Francis, F.R.S.), The Opportunities of Science Masters at Schools, 9; Pocket Registrar for Anthropological Purposes, 478  
Galvanic Current, Theory of, Herr Hoorweg on, 90  
Galvanic Battery, Aluminium, 375  
Galvanometer for Strong Currents, Marcel Deprez's, 246  
Gamgee (Prof. A., F.R.S.), "Text Book of Physiological Chemistry," 398; Dr. M. Foster, F.R.S., on, 555  
Gamwell (S.C.) "Handbook to Swansea and District," 431  
Gardner (J. Starkie) A Chapter in the History of the Coniferæ, 199; Arctic Fossil Floras and Temperature, 341.  
Garnett (W.) "A Treatise on Elementary Dynamics for the Use of Colleges and Schools," 265  
"Garrod Memorial Fund," 182, 251  
Gases, W. Ramsay on the Critical state of, 46  
Gas, Explosion of, in London, 228; S. Tolver Preston, 265; Sir J. Fayer, F.R.S., 265; Prof. Herbert McLeod, 290, 337  
Gas-burners, Report on, 442  
Gas Furnace, Fletcher's New, 615  
Gase, Magneto-Optic properties of, M. Henri Becquerel, 280  
Gaugain, Jean-Mothée, Death of, 181; Obituary Notice of, 198  
Gauss, Unveiling of the Statue to, 181  
"Gazetta Chimica Italiana," 161  
Geikie (Prof. A., F.R.S.), Rock-weathering as Illustrated in Churchyards, 104; Old Norway, 117; North American Geology—Idaho and Wyoming, 268; Captain C. E. Dutton on the High Plateau of Utah, 324; A Fragment of Primeval Europe, 400  
Geikie (Dr. James, F.R.S.) elected President of the Perthshire Society of Natural History, 66  
Geneva, Thunderstorm in, Prof. Colladon, 65; Geology of, 348  
Geography: Geographical Notes, 19, 41, 90, 114, 134, 157, 184, 205, 231, 254, 280, 303, 351, 376, 455, 467, 544, 569, 596, 618; "Geography for Little Children," by Mrs. Zimmern, 20; Historical, Political, Physical, and Descriptive, by Keith Johnston, 95; in China, 114; "A Short Geography of the British Islands," John Richard Green and Alice S. Green, 119; Bunbury's "History of Ancient Geography," 333; International Congress of, 398; Royal Geographical Society, *see* Royal  
Geology: "Geological Antiquity of Insects," Herbert Goss, 9; Geologists' Association Excursion to Oxford, 16; Proposed Excursions, 204; Geological Society, 21, 71, 91, 163, 187, 259; "Geological Record," 28, 445; Dr. Woodward appointed Keeper of Geological Department of the British Museum, 228; Stratigraphical Geology, 264; "Geology of the Henry Mountains," Robert Mallet, F.R.S., 266; North American Geology—Idaho and Wyoming, Prof. Archibald Geikie, F.R.S., 268; Geology of Central Asia, 348; Geology of Geneva, 348; Geological Notes, 348; Geological Survey of Alabama, 348; On the Recurrence of certain Phenomena in Geological Time, Prof. A. C. Ram-ay, F.R.S., 383; International Geological Congress, 431; Whitaker's "Guide to the Geology of London," 481; Geological Climate, Rev. Prof. Samuel Haughton, F.R.S., 532; Dr. P. Martin Duncan, F.R.S., 558; Geology of the Lybian Desert, 587  
Geometrical Society (German), General Meeting of, at Cassel, 16  
Geometrical Figures, Optical Illusion in looking at, 207  
Geometry, Text-book of, Professor Petersen, 360; Treatise on Solid Elementary, W. Steadman Aldis, 531; Angel's Practical Plane Geometry, 557; C. Taylor's Geometry of Conics, 603  
Germany: German African Society, 114; List of Scientific Expeditions sent out by, 41; *Mittheilungen* of, 544; German Anthropological Society, General Meeting of the, 64; Con-

- gress of, 453; German Horticultural Exhibition pro-  
130; German Association of Naturalists and Physicians,  
Meeting at Danzig, 298, 493, 527, 539
- Ghosts, Faraday Exhibiting, 583
- Gifford (Anne), Lunar Rainbows, 319
- Gilbert (Dr. J. H., F.R.S.), Agricultural Chemistry, 472, 497,  
523
- Gill (Capt. W.) "The River of Golden Sand," 26
- Giltay (T. W.), Hardening of Steel, 461
- Gladstone (Dr. J. II., F.R.S.), The Refraction Equivalent of  
Diamonds and the Carbon Compounds, 449
- Glaisher (J. W. L., F.R.S.), American Journal of Mathematics,  
Pure and Applied, 73
- Glasgow, proposed Exhibition of Naval and Marine Engineer-  
ing Models at, 16; Mitchell Library of, 65
- Glass, Expansion of, by Heat, 157; Prof. John LeConte, 318
- Glass, Toughened, Noble Taylor, 241; T. B. Sprague, 292
- Glass Tubes, Experiment with, J. T. Bottomley, 291
- Glass, Compressibility of, 377
- Glycerin, Citric Acid from, Grimaux and Adam, 567, 585
- Godeffroy Museum, the, 110
- Godetia, Rudimentary Coma in, 395
- Gold, Discovery of, in the Bathurst district near Tuena, 275; in  
Queensland and Tasmania, 329
- Golden Sand, the River of, Capt. W. Gill, 26
- Goode (G. Brown), the Menhaden, 335; First Decade of the  
United States Fish Commission, its Plan of Work and Ac-  
complished Results, Scientific and Economical, 597
- Gordon (J. E. H.), "A Physical Treatise on Electricity and  
Magnetism," 263
- Gore (G., F.R.S.), "Effects of Electric Currents on the Sur-  
faces of Mutual Contacts of Aqueous Solutions," 21
- Goss (Herbert), "Geological Antiquity of Insects," 9
- Göttingen, Royal Society of Sciences, 48, 332
- Grass, Floating, in Queensland, 110
- Grasses, Indigenous, of New Zealand, Manual of, J. Buchanan,  
532
- Gratacap (L. P.), Intellect in Brutes, 408
- Gray (Prof. Asa), Botanical Text-Book, 482
- Great Southern Comet of 1880, 156, 231
- Green (J. R. and Alice S.), "A Short Geography of the British  
Islands," 119
- Greenwich Observatory, Report, 158
- Greenwood (F. R.), Depraved Taste in Animals, 364
- Gregory (J. R.), Medal Awarded to, at the Sydney Exhibition,  
204
- Grimaux and Adam, Synthesis of Citric Acid, 567, 585
- Grimm (M. O.), Organs of Deep-Sea Animals, 278
- Grube (Adolf Eduard), Obituary Notice of, 435
- Guano Island, Meteorology of a, W. A. Dixon on, 254
- Guiana, British, E. F. in Thurn's Journey to, 41
- Guns, Woolwich, 293
- Günther (Dr. A. C. L. G., F.R.S.), Opening Address in  
Section D at the British Association Meeting, 393
- Guppy (Surgeon H. B.), the Yang-tse, the Yellow River, and  
the Pei-ho, 486; the Classification of Rivers, 606
- Gyroscope, Electro-magnetic, W. de Fonvielle, 40; New  
Method of Rotating, 131
- Haddon (A. C.), his Temporary Zoological Station at Torbay,  
517, 560; Air-Bladder of Herring, 534
- Hæmatopoetic Function, the, 520
- Hæmoglobin in Echinoderms, 595
- Hagentach (Prof.), the Phenomena of Explosion of Bombs by  
Freezing of Water, 302
- Hailstones, Large, George Peterson, 292
- Hall-storm at Mussooree, India, 229
- Haldeman (Prof. S. S.), Death of, 517
- Hall (Prof. Asaph), on the Progress of Astronomy, 570
- Halo, A. L. Soames, 435
- Hamburg, Thunderstorms at, G. Ambrose Pogson on, 155
- Hand, on the Skin Furrows of the, Dr. H. Faulds, 605
- Hanging, Death by, 595
- Hannay (J. B.), Artificial Diamonds, 241, 255; Experiments on  
the States of Matter, 483
- Hart (W. Hume), Rainfall of Sierra Leone, 585
- Hartwig's Comet, 569, 593; Spectrum of, W. H. M. Christie,  
557
- Hartz Mountains, Forest Fire in, 131
- (J. A.), Ornithological Journal of the Winner of  
1878-79, 315
- Hats and Memory, 252
- Haughton (Rev. Prof., F.R.S.), on the Law of Fatigue in the  
Work done by Man or Animals, 128; Geological Climates,  
532
- Heat, Expansion of Glass by, 157; the Mechanical Equivalent  
of, 596
- Heat-rays, the Absorption of, by Powders, 350
- Heliograph, an Improved, Dr. Tempest Anderson, 499]
- Helvetic Society of Natural Science, 131
- Hemiptera-Heteroptera, the number of Known Species of, Dr.  
Buchanan White, 606
- Hensley (W. B.), Evolution of the Vegetable Kingdom, 150;  
Engler's "Botanische Jahrbücher," &c., 434
- Henslow (Rev. George), Reversals by Memory, 241; Intellect  
in Brutes, 319; Swiss Châlets, 534
- Henry Mountains, Geology of, Robert Mallet, F.R.S., 266
- Herbarium Royal Gardens, Kew, Important Accessions to, 228
- Herbert (Auberon), Preservation of Ancient Monuments, 228
- Herr Flege! on West Africa, 41
- Herring, Visceral Anatomy of, 520; Air-Bladder of, Alf. C.  
Haddon, 534
- Herschel (Prof. A. S.), Carbon and Carbon Compounds, 320
- Herschel (Major J., F.R.S.), Wire Torsion, 557
- Hill (Mr. Edward Smith), Death of, 65
- Hindus, Weapons and Politics of the Ancient, G. Oppert, 581
- Hobson (Captain), Death of, 570
- Hodgson (Richard), Fascination, 383
- Holmes (E. M.), Museum Conference, 10
- Holmes (Gordon), "The Science of Voice Production and Voice  
Preservation, for the Use of Speakers and Singers," 143
- Holub's (Dr.) Exhibition at Vienna, 68
- Hoorweg (Herr), on the Thermic Theory of the Galvanic Current,  
90
- Hopkinson (Dr. John, F.R.S.), Electric Lighting, 42
- Hoppe-Seyler on Chlorophylla, 279
- Horner (Père), Death of, 114
- Horns, Stags', E. W. Claypole, 146; Herbert Ellis, 221; C.  
Overton, 221
- Horse, Intestinal Worms in the, H. Krabbe on, 277
- Horticulture and Electricity, 135
- "Howard Medal," Essays for, 276
- Howgate Polar Expedition, 1877-78, Scientific Results of, 171
- Huggins (Dr. Wm., F.R.S.), Spectrum of the Flame of  
Hydrogen, 283; Obituary Notice of Dr. William Lassell,  
F.R.S., 565
- Hughie (John), "Ceylon Coffee Soils and Manures: Report to  
the Ceylon Coffee Planters' Association," 144
- Hulme (F. E.), "Familiar Wild Flowers," 532
- Human Voice, the Mechanism of the, Emil Behnke, 239
- Human Hybernation, 366
- Mumphry (Prof., F.R.S.), Rede Lecture, 115
- Humpidge (Prof. T. S.), New Metals, 232
- Huntington (Prof. A. K.), Report on the Ultra-Violet Spectra,  
444
- Hurricane, the Jamaica, and the Botanical Gardens, D. Morris,  
538
- Hutchinson (P. O.), Peat Bed in the Drift at Oldham, 583
- Huxley (Prof. T. II., F.R.S.), The Coming of Age of the  
Origin of Species, 1; at the Science College, Birmingham,  
16; Science and Culture, 545
- Iwan-nao*, Mr. Tremlett on, 183
- Hyacinths, Curious Growth of, 30
- Hybernation, Human, 366
- Hydræ, Variable R., 542
- Hydrates, Formation of Water of, 542
- Hydrogen, Iron and, H. J. Johnston-Lavis, 220; Walter R.  
Brown, 242
- Hydrogen, Spectrum of the Flame of, W. Huggins, F.R.S.,  
283
- Hydrographic Department, 86; Lieut. Geo. T. Temple, 192
- "Hygiene, Nature's: A Series of Essays on Popular Scientific  
Subjects, with Special Reference to the Chemistry and  
Hygiene of the Eucalyptus and the Pine," C. T. Kingzett,  
142
- Hygiene, Parkes Museum of, First Annual Meeting in connec-  
tion with, 300
- Hygiene, Congress at Hamburg, 493
- "Hyper-Space," 383

- Ibaraki, Japan, Discovery of different Coloured Marble on, 1
- Ice, Anchor, 31, 171; J. Rae, 64
- Ice-Crystals, 145; Prof. J. LeConte, 54
- Ice at High Temperature, Existence of, Thos. Carnelley, 434, 510; Prof. J. LeConte, 603
- Ice under Pressure, 559; Dr. Thos. Carnelley, 583
- Idaho and Wyoming, North American Geology, Prof. Archibald Geikie, F.R.S., 268
- Ilanz, Earthquake, 66
- Imray (Hon. John, M.D.), Death of, 539
- Imrie (John), Monkeys in the West Indies, 77
- Index Society, Second Annual Meeting of, 251
- India, Natural History Survey of, 567
- Indian Famine Commission, 553
- Inoculation, Fungus, for Insects, J. P. Lesley, 31
- Insect Variety, A. H. Swinton, 579
- Insectivorism, on a Case of Apparent, Prof. Baillon, 277
- Insects, Fungus Inoculation for, J. P. Lesley, 31; Goethe's Poem concerning, 64
- Inspectors of Schools and the Scientific Subjects of the Code, 445
- Institute of Civil Engineers, 72, 230
- Institution of Mechanical Engineers, Summer Meeting of, at Barrow-in-Furness, 300
- Intellect in Brutes, W. W. Nicholls, 266; Rev. George Henslow, 319; Surgeon-Major Curran, 339; Henry MacCormack, 362; L. P. Gratacap, 408; Consul E. L. Layard, 607; Prof. W. Whitman Bailey, 607
- Intestinal Worms in the Horse, H. Krabbe on, 277
- Iodine Vapour, Density of, 279; Prof. v. Meyer, 130
- Iodine, Chlorine, and Bromine, Densities of at High Temperature, 278
- Iris, Dilation of the, 220
- Iron and Steel, Immersion of, in Acidulated Water, W. H. Johnson, 11
- Iron and Steel Institute, 37, 87, 328, 452
- Iron and Hydrogen, H. J. Johnston-Lavis, 220; Walter R. Browne, 242
- Iron, Researches on the Passivity of, J. Varenne, 279
- Iron Bars, Changes of Length in, by Magnetisation, 543
- Italy, Discovery of a Prehistoric Burial-Ground, 111
- Italian Antarctic Expedition, Proposed, 157
- Jablochkoff Electric Light Company, 17
- Jablochkoff's Electric Lights in Paris, 131
- Jack (R. L.), Survey of Queensland, 155; Reports on the Geology of Queensland, 431
- Jamaica Hurricane and the Botanical Gardens, D. Morris, 538
- Jarvis's New Electric Lamp, 17; Experiments with, 131, 355
- Janssen's New Sun Photographs, 302
- Japan: New Railway in, 17; Experiments on Japanese Magic Mirrors, 133; Seismology in, Prof. John Milne, 208; Mining and Mines in, C. Netto, 316; Meteorology in, 342; Tea Cultivation in, 569; Sir E. J. Reed's Work on, 610; Miss Isabella Bird's Work on, 610; Coal-Mines in, 616; a Japanese Romance, H. N. Moseley, F.R.S., 288; Japanese Porcelain Clays, 349
- Java, Notes from, 148
- Jeannette Arctic Expedition, 68, 570
- Jeffreys (Dr. J. Gwyn, F.R.S.), The Mollusca of the Mediterranean, 452, 477; French Deep Sea Exploration in the Bay of Biscay, 468
- Jelly-Fish, A New, of the Order Trachomedusæ Living in Fresh Water, Prof. E. Ray Lankester, F.R.S., 147, 177; Prof. George J. Allman, F.R.S. 177; George J. Romanes, F.R.S., 177
- Jenkin (Prof. Fleeming), Keith Medal Awarded to, 16
- Johnson (W. II.), Immersion of Iron and Steel in Acidulated Water, 11
- Johnson (Charles), Death of, 517
- Johnson (Keith), "Physical, Historical, Political, and Descriptive Geography," 95; "Illustrations of Electricity and Magnetism," 240
- Johnston-Lavis (H. J.), Iron and Hydrogen, 220; Hardening of Steel, 511; Mosquitos, 511
- Jolly (W.), on the Parallel Roads of Lochaber, 68
- Jordan's Glycerine Barometer at the Times Office, 614
- Joule (James Prescott, F.R.S.), the Albert Medal of the Society of Arts awarded to, 154
- Journal of Anatomy and Physiology, 20, 455
- Journal of the Royal Microscopical Society, 20, 282, 552
- Journal of the Franklin Institute, 46, 137, 234, 331, 623, 513
- Journal de Physique, 46, 160, 257, 503, 552
- Journal of Botany, 136
- Journal of Philology, 167
- Jupiter, the Rotation of, 617
- Kate Fibre, 542
- "Kalkül der abzählenden Geometrie," Dr. H. Schubert, 557
- Kate (H. F. C. ten) Paul Broca, 292
- Kattenau, remarkable Phenomenon observed at, 64
- Kaolinisation, Subterranean, John A. Church, 317
- Keane (A. H.), Sayce's "Science of Language," 49; Albania and the Albanians, 243
- Keith Medal, Awarded to Prof. Fleeming Jenkin, 16
- Kensington Gardens, A Snake in, J. Harris Stone, 193
- Kent's Cavern, British Association, Report on, 445
- Kerosene, supposed in the neighbourhood of Sydney, 88
- Kew Gardens, Important Accessions to the Herbarium at, 228
- "Key to the Universe," Orson Pratt, sen., 290
- Kinahan (G. II.), Metamorphic Rocks, Ireland, 606
- King (H.), "Coronella lævis," 220
- Kingzett (C. J.), "Nature's Hygiene: A Series of Essays on Popular Scientific Subjects with Special Reference to the Chemistry and Hygiene of the Eucalyptus and the Pine," 142
- Kjerulf (Dr. Theodor), Geology of Norway, 117
- Knights Errant*, The Cruise of the, Sir Wyville Thomson, F.R.S., 405
- Knott (Geo.), Ceraski's New Variable Star, 603
- Koch (Karl), Proposed Memorial Stone on the Grave of, 274
- König (Dr.), on the Vibrations of a Normal Tuning-fork, 90
- Kordofan, Notes on, 455
- Krabbe (H.), Intestinal Worms in the Horse, 277
- Lacustrine Volcano, 129
- Ladd (W.), On the best form of Magnet for Magneto-Machines, 446
- "La Exploradora," An Association for the Exploration and Civilisation of Central Africa, 19
- Lake Lemán and the Dam at Geneva, 158
- Lake Tanganyika and Lake Nyassa, Plants from, 586
- Lake-village near Auvergnier, discovery of, 494; discovery of, near Milan, 540
- Lamb (Horace), The Motion of Fluids, 145
- Landslips, 505
- Landslip, The Naini Tal, E. Douglas Archibald, 533
- Landslips, Thos. Ward, 560
- Language, Introduction to the Science of, Prof. A. H. Sayce, 49
- Lankester (Prof. E. Ray, F.R.S.), On a New Jelly-Fish of the Order Trachomedusæ, Living in Fresh Water, 147, 177, 190, 241, 316, 361; "Degeneration: A Chapter in Darwinism," 141; on Gresham College, 228; Dimorphism of NATURE on June 17, 361; Balfour's "Comparative Embryology," 601
- Laplace (Marquis de), New Edition of his Works, 300
- Lapraik (William), Absorption Bands in certain Colourless Liquids, 368
- Lassell (Dr. William, F.R.S.), Obituary Notice of by Dr. William Huggins, F.R.S., 565
- Layard (Consul E. L.), Yuccas under Cultivation, 606; Intellect in Brutes, 607
- Leaves, Excretion of Water by, Dr. J. W. Moll, 403
- LeConte (Prof. John), Ice-Crystals, 54; Expansion of Glass by Heat, 318; Coral Reefs and Islands, 558; Solid Ice at High Temperature, 603
- Lees (W.), Keith Johnston's "Electricity and Magnetism," 240
- "L'Exploration," 281
- Leibnitz, Erection of Monument to, 109
- Leichhardt's Expedition, a supposed Survivor of, 184
- Leidy (Dr. J.), Freshwater Rhizopods of North America, 165
- Leipzig, Branch of "Thüringer-wald Club" at, 111
- Le Mans, Balloon Accident at, 253
- Lemström (Prof.), Experiment in Electricity, 89
- Lens, A, of Variable Focus, 280
- Lepidosteus, Development of, 520
- Lesley (J. P.), Fungus Inoculation for Insects, 31
- Lewis (F.), Intellect in Brutes, 40
- Ley (Rev. W. Clement), Brain Dynamics, 121; Cloud Classification, 144

- Leyden Jars, Voltameters, &c., Reduction of Observations on, 258
- Libyan Desert, Geology of, 587
- Lick Observatory, the Proposed, 515
- Light and Electricity, a New Relation between, 207
- Light, on a Mode of Explaining Transverse Vibrations of, J. W. Frankland, 317
- Light, Transverse Vibrations of, 363
- "Light and Heat." Capt. W. Sedgwick, 483
- Light, Polarisation of, Experiment in, 595
- Lighthouses, Migratory Birds at, 25
- Lighthouses and the Migration of Birds, 477
- Lighting our Coasts, present System of, 229
- Lightning, the way Trees are struck by, 65; L. Cumming, 220; the Sorbonne struck by, 466
- Lightning Ball, W. F. Smith, 267
- Lightning Conductors, C. McPherson de Bremon, 382; W. H. Preece on the best Form of, 446; Richard Anderson on the Necessity for a Regular Inspection of Lightning Conductors, 446
- Linn (James), Cup-marked Stones, 122
- Linnean Society, 39, 71, 115, 162, 210
- Lions, Decrease of, in Algeria, 204
- Liquids, the Cooling of, 280
- Lissajous (M.), Death of, 299
- "Livadia," Russian Imperial Yacht, 270
- Living and Dewar (Professors), On the Spectra of the Compounds of Carbon with Hydrogen and Nitrogen, 620
- Liverpool, Proposed University College at, 308, 307, 519
- Lloyd (W. A.), Death of, 274; Obituary Notice of, 299
- "Loch Etive," and "The Sons of Uisnach," 289
- Lochaber, Parallel Roads of—the Problem and its Solutions, W. Jolly, 68
- Locke (John), The Stone in the Swallow's Nest, 146
- Lockyer (J. Norman, F.R.S.), On Multiple Spectra, 4, 309, 562
- Locusts and Coffee-trees, Dr. A. Ernst, 408
- Logarithms, Four-Figure and Anti-Logarithms, 496
- London Missionary Society, Exploration of East Central Africa, 19
- London Clay, Diatoms in the, W. H. Shrubsole, 221
- London University, Examinations and Women, 399
- London, the Succession of Temperature and Rainfall in the Climate of, H. Courtenay Fox, 445
- London, the Geology of, W. Whitaker, 481
- London Mathematical Society, 71, 162, 614
- Long (Herr), Diffusion of Salts in Aqueous Solution, 280
- Longitude, Telegraphic Determination of, 496
- Loomis (Prof.), on the Temperature of the United States, 594
- Lozano (Don Eduardo), "Estudios Físicos," 302
- Lubbock (Sir John), on the Habits of Ants, 184
- Ludlam (Henry), Death of, 203
- Ludwig (Prof.), on the Decomposition of Organic Compounds by Zinc Powder, 89
- Lunar Rainbows, Anne Gifford, 319
- Lunn (Charles), "Vox Populi: Sequel to the Philosophy of Voice," 556
- MacCormack (Henry), Intellect in Brutes, 362
- Macfadzean (James), the Songs of Birds, 12
- McGill College, Montreal, the New Museum, 614
- Mackinlay Ranges, Expedition to, 570
- McLachlan (R., F.R.S.), "The Trichoptera of the European Fauna," 314; *Protopistoma punctifrons*, 460
- McLeod (Prof. Herbert, F.R.S.), the Recent Gas Explosion, 290, 337
- McNally (C. J.), Temperature of the Breath, 534
- Magic Mirrors of Japan, Experiments on, 133
- Magnet, on the Best Form of, for Magneto-Machines, W. Ladd, 446
- Magnetic Experiment, a Pretty, 133
- Magnetic and Earth-Current Disturbance, Wm. Ellis, 361
- Magnetic Storms, Aurora Borealis and, 361
- Magnetic Storm, G. M. Whipple, 558
- Magnetisation, Influence of, on Iron, Signor Piazzoli, 89
- Magnetism, Terrestrial, Comparative Curves in, Rev. S. J. Perry, F.R.S., 120; J. Capelle, 220
- Magnetism, Terrestrial, on Some Points Connected with, Warren De La Rue, F.R.S., and Hugo W. Müller, F.R.S., 169; Prof. B. Stewart, F.R.S., 146, 202
- Magnetism and Electricity, a Physical Treatise on, J. E. H. Gordon, 263
- Magnetographs, on the Comparison of Declination, at Various Places, Prof. W. G. Adams, 447
- Magnetometer, the Bifilar, Modification of, 544
- Mallet (J. W., F.R.S.), "Revision of the Atomic Weight and Valence of Aluminium," 21; Artificial Diamonds, 192; Geology of the Henry Mountains, 266
- Mallory Screw, a New Vessel Propelled by, 252
- Malvern Hills, Camps on the, 211
- Mammoth Skull, Discovery of, at Posen, 66
- Man, Comparative Anatomy of, Prof. Flower, F.R.S., 59, 78, 97
- Man, Primitive, 82
- Manchester, Victoria University, 274
- Manila, Earthquake at, 276, 360
- Mann (C.), Meteorology of South Australia, 120
- Maoris, the Colour Sense of, 494
- Map of Existing and Projected Railways in the Provinces of Rio de Janeiro, Minas, and San Paulo, 205
- Maps, Fresh, in the British Museum, 184
- Marble, Coloured, Discovery of, in Japan, 88
- Marine-Zoology Class, Alfred C. Haddon, 560
- Mariotte's Law, Variations from, 61
- Mars, Polar Compression of, 112
- Marsh (Prof. O. C.), Toothed Birds of Kansas, 457
- Maskelyne (N. Storey, F.R.S., M.P.), Obituary Notice of Prof. W. Miller, 247
- Mason College, Birmingham, 514; Prof. Huxley's Address, 545
- Mathematical Society, 71, 162, 614
- Mathematical Journals, J. W. L. Glaisher, F.R.S., 73
- Mathematics, American Journal of, 276
- Mathematics, Pure and Applied, Synopsis of Elementary Results in, G. S. Carr, 582
- Matter, a Fourth State of, W. Crookes, F.R.S., 153; Duke of Argyll, 168; S. Tolver Preston, 192; E. Douglas Archibald, 218; George E. Newton, 240
- Matter, Experiments on the States of, J. B. Hannay, 483
- Matter in the Liquid State, Conditions Necessary for the Existence of, Thomas Carnelley, 434
- Maximum and Minimum Energy in Vortex Motion, Sir William Thomson, F.R.S., 618
- Maya History, the Katunes of, 442
- Meat, Tinned, Reported Poisoning by, 567
- Medical Congress, International, 275
- Medusa, Freshwater, a New, Prof. E. Ray Lankester, F.R.S., 147, 177, 190, 241, 316, 361; Prof. G. J. Allman, F.R.S., 177, 218, 290; G. J. Romanes, F.R.S., 177
- Mechanics, Elementary Applied, T. Alexander, 265
- "Mechanism of the Human Voice," Emil Behnke, 239
- Melanesia, the Religious Beliefs of, 211
- Melun Base Line, 329
- Memory, Reversals by, Rev. Geo. Henslow, 241; Feat of, 252
- Menhaden, the, G. Browne Goode, 335
- Mensurational Spectroscopy, Three Years' Experimenting in, Prof. Piazzoli Smyth, 193, 222
- Mercurial Air-Pump, a New, 543
- Mercury, Transit of, 67; Visibility of, to the Naked Eye, T. D. Simonton, 119
- Mercury, the Surface Tension of, Experiment illustrating, 157
- Meredit (Mrs. L. A.), "Tasmanian Friends and Foes, Feathered, Furred, and Finned," 300
- Messer (F. A.), "A New and Easy Method of Studying British Wild Flowers by Natural Analysis," 532
- Metalloids, on the Spectra of the, Dr. A. Schuster, F.R.S., 444
- Metals, New, Prof. T. S. Humpidge, 232
- Metamorphic Rocks, Ireland, G. H. Kinahan, 606
- Meteorology: Meeting of the International Congress of Meteorology at Vienna, 16; Meteorological Society, 23, 139, 235; Climatological Stations of, 594; U.S. Weather Maps, 36, 100, 249, 372, 516; Proposed Alteration in the Hour for Simultaneous Observations, 86; Meteorology of the Italian Mountains, Rev. Prof. F. Denza on, 87; Meteorology of South Australia, C. Mann, 120; C. Todd, 120; Intercolonial Meteorological Conference at Sydney, 160; Meteorological Observatory, Sántis Mountain, 131; Meteorological Notes, 132, 253, 594; Missouri Weather Report, 253; Meteorology of a Guano Island, W. A. Dixon, 254; Scottish Meteorological Society, 275; International Meteorology, 307, 471,

- 568; Meteorology in Japan, 342; Station in Mexico, 399; Rainfall of the East Indian Archipelago, 434; the Climate, &c., of London, 445; Prof. Loomis on the Temperature of the United States, 594
- Meteors: W. Odell, 193; Major G. L. Tupman, 242; F. C. Penrose, 267; the August Meteors, 374; in India, 431; C. Thwaites, 484
- Mexico: Exploration of Ancient Remains of, by M. Desiré Charnay, 42; Meteorological Stations in, 399
- Meyer (Prof. V.) on the Density of Iodine Vapour, 130
- Miami Natural History Society, 374
- Michaelis (Dr. A.), Presentation of Cothenius Medal to, 86
- Microscopes and Telescopes, Construction of, 607
- Middleton (Morton, jun.), Cup-marked Stones, 77
- Midland Union of Natural History Societies, Annual Meeting, 182; the "Darwin Prize" of, 299
- Milan, Discovery of Pile-Dwellings in, 65
- Miller (Prof. W. H.), Death of, 86; Obituary Notice of, N. Storey Maskelyne, F.R.S., 247
- Miller's Chemistry of the Carbon Compounds, New Edition, 530; Prof. H. E. Armstrong, F.R.S., 559
- Milne (Prof. J.), Earthquake Observation, 64; Seismology in Japan, 208
- Minchin (Prof. George), "Treatise on Statics," 52
- Mind, the Brain as an Organ of, Dr. H. Charlton Bastian, F.R.S., 381
- Minima of Algol, 156
- Mineral, New, from the Champlain Iron Region, 278
- Mineralogical Society of Great Britain, General Meeting of, 87, 140, 431; Annual Meeting, 398
- Minerva Ornaments, Prof. E. W. Claypole, 193; Prof. A. H. Sayce, 219
- "Mining and Mines in Japan," C. Netto, 316
- Mines, Royal School of, Appointment of W. C. Roberts, F.R.S., 10, 39
- Minor Planets, 89
- Miocene Flora, 349
- Missouri: Weather Service Report, 253; the Tornadoes in, 253; the Archaeology of, 519
- Moebius (Prof.), on the Food of Marine Animals, 528
- Molecular Physics in High Vacuo, Contributions to, W. Crookes, F.R.S., 101, 125
- Molecular Weights of Substances, on the Relation between, and their Specific Gravities when in the Liquid State, Prof. T. E. Thorpe, F.R.S., 262
- Molecules, the Weight of, 350
- Moll (Dr. J. W.), Excretion of Water by Leaves, 403
- Mollusca of the Mediterranean, Dr. J. Gwyn Jeffreys, 452, 477
- Mollusk, a Doubtful British, Grant Allen, 435
- Monkeys in the West Indies, John Inurie, 77; Edmund Watt, 318
- Monkey, Utilisation of a Langur, 398
- Monstrous Beetles, 520
- Mont Blanc, Ascent of, by a Blind Man, 495
- Moon, the apparent distance of, 375
- Mouro (C. J.), on the Simplest Continuous Manifold of Two Dimensions and of Finite Extent, 218
- Montsouris, Electrical Observations at, 16
- Morphologisches Jahrbuch, 161, 552
- Morris (D.), The Jamaica Hurricane and Botanical Gardens, 538
- Morton (G. H.), Peat Bed in the Drift of Oldham, 511
- Moseley (H. N.), Remarkable Discovery of a Murder in Bermuda, 170; A Japanese Romance, 288; Obituary Notice of Louis François de Pourtales, 322; Swiss Châlets, 559
- Mosquitos, Flies, and Blight, Protection against, Wm. Chappell, F.S.A., 11
- Mosquitos and Quassia, J. B. Dancer, 338
- Mosquitos, M. A. Veeder, 460; H. J. Johnston-Lavis, 511
- Moss (Dr. E. L.), Loss of, in the *Atalanta*, 181
- Motay (Tessie du), death of, 204
- Motion in Algae, Herr Stahl, 114
- Mott (F. T.), Curious Electric Phenomenon, 193; Aurora Borealis and Magnetic Storms, 361
- Mouchet (M.), Researches on the Utilisation of Solar Heat, 206
- Moulton (J. F.), Energy and Force, Prof. W. K. Clifford, F.R.S., 122
- Mountaineering Exploits in South America, E. Whympers, 19
- Mourlon, Geology of Belgium, 348
- Muckley (W. J.), "Handbook for Painters: on Colours," 357
- Mueller (Baron F. von, F.R.S.) "Eucalyptographia," 118
- Muir (M. M. Pattison), Chemical Dynamics, 285
- Miller's "Chemistry of the Carbon Compounds," 530; Recent Chemical Research, 608
- Mulder (Prof. J. G.), death of, 87; Obituary Notice of, 108
- Müller (Hugo W., F.R.S.), The Aurora Borealis, 33; the Inevitable test for Aurora, 96; Aurora Borealis and its Colours, 169; Experimental Researches in Electricity, 149; on some Points connected with Terrestrial Magnetism, 169
- Müller (Prof. F. Max), The Sacred Books of the East, 189
- Müller (Dr. Hermann), Alpine Flowers, 204; *Saxifraga umbrosa* adorned with brilliant Colours by the Selection of Syrphids, 219
- Müller (Fritz), Branch-Cutting Beetles, 533
- Multiple Spectra, J. Norman Lockyer, F.R.S., 4, 309, 562
- Mundella (Mr.), On Education, 274
- Munro (Dr. Robert), A Scottish Crannog, 34
- Murder, Remarkable Discovery of, in Bermuda, H. N. Moseley, 170
- Murray (John), Structure and Origin of Coral Reefs and Islands, 351
- Museum Conference, E. M. Holmes, 10
- Museum of Natural History, The New, 237
- Museums, Dr. Günther, F.R.S., on, 393
- "Musical Beats, Notes of Observations on," A. J. Ellis, F.R.S., 234
- Mussooree, India, Violent Hailstorm at, 229
- Myer (General Albert J.), Obituary Notice of, 462
- Naini Tal Landslip, E. Douglas Archibald, 533
- Naples, Shock of Earthquake in, 300
- Natural History, the New Museum of, 237
- "Nature's Hygiene: a Series of Essays on Popular Scientific Subjects, with special reference to the Chemistry and Hygiene of the Eucalyptus and the Pine," C. T. Kingzett, 142
- Nebula, Variable, near  $\zeta$  Tauri, 231
- Nebula, Two New Planetary, Edward C. Pickering, 327
- Nebula in Orion, Photograph of, Prof. Henry Draper, 583
- Nefoscope, a New Form of, 132
- Nest of the Swallow, Stone in the, W. E. A. Axon, 242
- Net-Building Amphipods, 594
- Netherlands Zoological Society, 203
- Neumann (Dr. Karl), Death of, 252
- Newcastle College of Science, 519
- Newfoundland, Island of, Railway across, 184
- New Granada, Coffee Disease in, Dr. A. Ernst, 292
- New Jersey, Geological Survey of, 348
- New South Wales, Discovery of Silver and Gold in, 183
- Newton (Prof. Alfred, F.R.S.), "Winter Swallows," 29; Songs of Birds, 122; on the Migration of Birds, 477
- Newton (Geo. E.), a Fourth State of Matter, 240
- New York, Report of Central Park Menagerie, 16
- New Zealand, New Map of, 134; Establishment of a New School of Agriculture at Canterbury, 182; Education in, 298; New Zealand Institute, 461; Manual of Indigenous Grasses of New Zealand, J. Buchanan, 532; University of, 560
- Niagara River, Soundings of, 41
- Nicholls (W. W.), Intellect in Invertebrates, 266
- Nicols (Arthur), Depraved Taste in Animals, 339
- Nield (James), Carboniferous Forest at Oldham, 30; Peat Bed in the Drift at Oldham, 460, 583
- Nineteenth Century Building Society, 568
- Nitrogen, the Influence of Bodily Exercise on the Elimination of, 445
- Noailles, Railway at, 40
- North America, Freshwater Rhizopods of, J. Leidy, 165
- North American Geology—Idaho and Wyoming, Prof. Archibald Geikie, F.R.S., 268
- Norton (Lord), and Elementary Education, 165, 237
- Norway, Old, Prof. Arch. Geikie, F.R.S., 117
- Norway, Science in, 574
- Nuovo Giornale Botanico Italiano, 136
- Nyanza (Lake), Mr. J. Stewart on, 67
- Nyassa, Lake, Plants from, 586
- Obach (Dr.), Action of Phosphorescent Light on Selenium, 496
- Ober (F. A.) "Camps in the Caribbees. The Adventures of a Naturalist in the Lesser Antilles," 214



- O'Brien (C. G.), An Octopus, 585  
 Observatories: Annual Visitation of the Royal Observatory, 130; Report of, 158; Imperial, Strassburg, 132; Algiers Observatory, M. Coggia appointed Director, 154; Chicago Observatory, 301; Mount Etna, 373; The Proposed Lick, 515; The Paris Popular, 592; The Radcliffe, 599; The New Warner, 614.  
 Occultation of a Fixed Star by Saturn, 112  
 Ocean Temperatures, Herr von Boguslawski, 114  
 Ocean Circulation, Dr. William B. Carpenter, F.R.S., 217.  
 Octopus, C. G. O'Brien, 585  
 Odontornithes: a Monograph of the Extinct Toothed Birds of North America, 457  
 Ohlenschlager (Prof. H.), Prehistoric Map of Bavaria, 68  
 Oldham, Carboniferous Forest at, James Nield, 30; Peat Bed in the Drift of, G. H. Morton, 511; P. O. Hutchinson, James Nield, 460, 583  
 Oliver (J. A. B.), Aurora Borealis and Magnetic Storms, 361  
 Olympia, Austrian Expedition to, 68  
 Onagraceæ, Stipules in, 521  
 Oppert (G.), "Weapons and Politics of the Ancient Hindus," 581  
 Optical Illusion in looking at Geometrical Figures, 207  
 Optical Property of the Cornea, 595  
 Orchids, Australian, R. O. Fitzgerald, 53  
 Ordnance Survey, the, and the Government, 135  
 Organic Qualitative Analysis, Dr. Barfoed's "Lehrbuch" of, 581  
 Organs of Deep-Sea Animals, M. O. Grinnon on, 278  
 Origin of Species, the Coming of Age of, Prof. T. H. Huxley, F.R.S., 1  
 Orion, Photograph of the Nebula in, Prof. Henry Draper, 583  
 Ornaments, Minerva, Prof. E. W. Claypole, 193; Prof. A. H. Sayce, 219  
 "Ornithological Journal of the Winter of 1878-79," J. A. Harvie-Brown, 315  
 Osborne (Rev. J. A.), Parthenogenesis in the Coleoptera, 509  
 Ostrich, Extraordinary Contents of Stomach of, 66  
 Ovampo-Land (Western Africa), Père Duparquet on, 41  
 Overton (C.), Stags' Horns, 221  
 Owen (Richard, C.B., F.R.S.), Notice of (*with Portrait*), 577  
 Oxford Observatory, 599  
 Oysters, Green Colour of, 549  
 Ozone: Liquefaction of, 560; Liquid, 596; Atmospheric, 617  
 Page (F. J. M.), Experimental Researches on the Time Relations of the Excitatory Process in Frogs, 137  
 Printing, Luminous, Fredk. V. Dickins, 121  
 Palæontological Research, Specialised and United, W. S. Duncan, 120  
 Palæontological Nomenclature, the Right of Priority in, 348  
 Palæontological and Embryological Development, Prof. Alex. Agassiz, 424  
 Palæozoic and Eozoic, Principal J. W. Dawson, F.R.S., 382  
 Palander (Lieut. A. Louis) Elected Corresponding Member of the French Geographical Society, 90  
 Palmieri (Prof.) on Earthquakes, 155  
 Papin (Denis), Statue of, 431  
 Paraglobulin, the Rotatory Power of, 596  
 Paris: Academy of Sciences, 24, 48, 72, 92, 116, 140, 164, 187, 212, 236, 260, 284, 308, 332, 356, 380, 432, 456, 480, 504, 528, 552, 576, 600, 624; Access to the Library of the, 539; Monthyon Prize Awarded to M. Camille Flammarion, 154; Admiral Mouchez on the Paris Observatory, 65; Formation of a Society in, for the Prevention of Excessive Smoking, 65; Small Pox in, 111; Jablockhoff Lights in, 131; Electric Light in, 252; the Electric Light in the Palais Royale, 441; Street Astronomers in, 182; Improvements in the National Library, 252, 276, 495; Popular Observatory, 592  
 Parker (W. K., F.R.S.), "On the Structure and Development of the Skull in the *Batrachia*," Part III., 161  
 Parkes Museum of Hygiene, First Annual Meeting in connection with, 300  
 Parliament, Science in, 7  
 Parthenogenesis in the Coleoptera, Rev. J. A. Osborne, 509  
 Pascal, Statue to, 347, 441  
 Paterson (George), Large Hailstones, 292  
 Patterson (Robert Lloyd), "Birds, Fishes, and Cetacea commonly frequenting Belfast Lough," 289  
 Peabody Institute of Baltimore, Thirteenth Annual "Report of," 205  
 Peal (S. E.), Sounds made by Ants, 583  
 Peat Bed in the Drift of Oldham, J. Nield, 460, 583; G. H. Morton, 511; P. O. Hutchinson, 583  
 Peat-Mosses of Europe and North America, R. Braithwaite, 556  
 Peaty Water, Action of the Air upon, Miss Halcrow and Dr. Frankland, 139  
 Pegasi, 85; Double-star, 205  
 Pel-ho, the Yang-tse, and the Yellow River, Surgeon H. B. Guppy, 486; T. Mellard Reade, 559  
 Peirce (C. S.), the Colour of Double-stars, 291  
 Peirce (Prof. Benjamin, F.R.S.), Obituary Notice of, 607  
 Pendulum Experiment, Foucault's, Permanent Record of Chas. R. Cross, 240  
 Penrose (F. C.), Large Meteors, 267  
 Perry (Prof. John), Seeing by Telegraphy, 31; Wire Torsion, 604  
 Perry (Rev. S. J., F.R.S.), Comparative Curves in Terrestrial Magnetism, 120; Aurora Borealis and Magnetic Storms, 361; Fire Ball, 362  
 Perseids, The Shower of August, W. F. Denning, 470  
 Perthshire Society of Natural History, Dr. James Geikie elected President of, 66  
 Petermann's Mittheilungen, 158, 254, 351, 596  
 Peters (Prof. C. A. F.), death of, 67; Obituary Notice of, 88  
 Petersen (Carl), Death of, at Copenhagen, 206  
 Petersen (Professor Julius), Text-books of Geometry, 360  
 Petrie (Wm. Flinders), The British Museum Attendants, 338  
 "Waiting Carriage," 534.  
 Petroleum Spirit and Analogous Liquids, 448  
 Phené (Dr.), On Prehistoric Customs in the Pyrenees, 478  
 Phenomena of Explosion of Bombs by Freezing of Water, Prof. Hagenbach on, 302  
 Philadelphia Academy of Natural Sciences, 116, 236; Proceedings, 330  
 Phillips (J. A.), the Heat of the Comstock Lode, 337  
 Philology, English, Recent Progress of, Rev. A. H. Sayce, 167  
 Philosophy of Voice, Vox Populi, Sequel to the, Charles Lunn, 556  
 Phosphorescence and Carbon Compounds, 543  
 Phosphoric Acid in the Urine of Cows, 595  
 Photo-Electricity, Prof. Minchin's Researches on, 91  
 Photographic Society, 48; Exhibition of, 540  
 Photographs from a Balloon of the Land below, 183, 204  
 Photographing by Lightning, 351  
 Photophone, the, Prof. Silvanus P. Thompson, 481  
 Photophone and Selenium, Prof. Graham Bell, 500  
 Phylloxera, Appearance of the, in the Vineyards of Vesuvius and the Gulf at Puzzioli and Pianura, 17  
 Physical Society, 16, 22, 91, 139, 210, 258  
 Physical Notes, 18, 89, 133, 156, 206, 280, 301, 350, 375, 521, 543, 595  
 Physical Aspects of the Vortex-Atom Theory, 145; S. Tolver Preston, 56  
 Physical Science in Russia, 207  
 Physics without Apparatus, 320, 343, 366, 438, 462, 488, 537, 588  
 "Physiological Chemistry," by Prof. A. Gamgee, F.R.S., 398; Dr. M. Foster, F.R.S., 555  
 Phytogeography, Dr. Engler's Work on, 190  
 Piano, Electrical Instrument for recording the Notes played on a, 19  
 Piazzoli (Signor), the Influence of Magnetisation on Iron, 89  
 Pickering (Prof. Edward C.): Two New Planetary Nebulae, 327; Novel Celestial Object, 483; Ceraski's New Variable Star, 603  
 Pile-Dwellings, Discovery of, in the Vicinity of Milan, 66  
 Planets, Minor, 89  
 Planetary Nebulae, Two New, Edward C. Pickering, 327  
 Plants of the Coal Measures, Prof. W. C. Williamson, F.R.S., 281  
 Plants, Digestion in, 521  
 Plants from Lake Nyassa and Lake Tanganyika, 586  
 Plummer (John I.), Height of the Aurora, 362  
 Pneumatic Clocks, 226  
 Pogson (G. Ambrose), Thunderstorms at Hamburg, 155  
 Polar Expedition, 1877-78, the Scientific Results of the Howgate, 171

- Polar-Compression of Mars, 112  
Polarisation Spectroscope of Great Dispersion, a Rotary, 360  
Polarisation of Light, Experiment in the, 595  
Polariser, Prazmowski's, 157  
Ponton (Mungo), his Inventions, &c., 431  
Population, the Increase of, in England and Wales, R. Price Williams on, 205  
Population of the Earth, 467  
Porcelain Clays, Japanese, 349  
Posen, Mammoth Skull discovered near, 66  
Potagos (Dr. Panagiotis), his Travels, 134  
Pottery, Prehistoric, of Missouri, 519  
Pourtales (Count Louis François de), Obituary Notice of, H. N. Moseley, F.R.S., 322; Prof. P. Martin Duncan on, 337; Obituary Notice of, Prof. Alexander Agassiz, 371  
Prague, Congress of Bohemian Naturalists, 109  
Pratt (Orson, sen.), "Key to the Universe," 290  
Preece (W. H.), New Microphone, 133; on some Thermal Effects of Electric Currents, 138; on the Best Form of Lightning-Conductor, 446  
Prejevalsky (Col.), Letter from, 41  
Pressure, Ice under, Dr. Thos. Carnelley, 583  
Preston (S. Tolver), on a Point relating to Brain Dynamics, 29; Brain Dynamics, 121; on Vortex-Atom Theory, 56; on Vortex-Atoms, G. H. Darwin, F.R.S., 95; Vortex-Atoms, 121; a Fourth State of Matter, 192; the Recent Gas Explosion, 265; on the Mode of Explaining the Transverse Vibrations of Light—the Expression "Radiant Matter," 363; Evolution and Female Education, 485  
Primeval Europe, a Fragment of, Prof. A. Geikie, F.R.S., 400; Duke of Argyll, F.R.S., 407  
Primitive Man, 82  
*Priz Volta*, Award of the, 299  
Proceedings of the Boston Society of Natural History, 186  
Proceedings of the Linnean Society of New South Wales, 234  
*Prasopistoma punctifrons*, R. McLachlan, F.R.S., 460  
Public Health, Society of Arts Conference on, 154  
Puluj (Dr. J.), Radiant Electrode Matter, 280  
Pyrenees, Prehistoric Customs in, Dr. Phené, 478  
Python, a Doctor's Encounter with a Sick, 541  
  
"Qualitativen Analyse, Lehrbuch der organischen," Dr. Chr. Th. Barfoed, 581  
Quarterly Journal of Microscopical Science, 503  
Quassia and Mosquitos, J. B. Dancer, 338  
Queensland, Discovery of Gold-Field in, 131, 329; R. I. Jack's Reports on Geology of, 431  
Queenwood College Mutual Improvement Society, 511  
Quetelet, Unveiling the Statue of, 131  
Quiroga (Don Francisco), "Estudio Micrográfico ne Algunos Basaltos de Ciudad-Real," 582  
  
Rae (J.), Anchor-Ice, 54  
Radiant Heat in Gases, Absorption of 543  
Radiant Heat and Electricity, 596  
"Radiant Matter," S. Tolver Preston, 363  
Radiation—a Query, 363  
Radiometers, Suggestion with regard to, 252; Experiments with, 350  
Rainbows, Lunar, Anne Gifford, 319  
Rainfall of the East Indian Archipelago, 434  
Rainfall of Sierra Leone, W. Hume Hart, 585  
Ralton (Dr.), Suez Canal Rock Salt, 11; Sodid Chloride Crystals, 11  
Ramsay (Prof. A. C., F.R.S.), Presidential Address at the Meeting of the British Association at Swansea, 383  
Ramsay (W.), On the Critical State of Gases, 46  
Rangoon, Earthquakes in, 615  
Rankine (Prof. Macquorn), Memorial Volume to, 539  
Rayleigh (Lord), Colour Combinations, 133  
Reade (T. Mellard), the Yang-tse, the Yellow River, and the Pei-ho, 569  
Reale Istituto Lombardo di Scienze e Lettere, 46, 88, 160, 234, 257, 380, 504, 623  
Rede Lecture, Prof. Humphry's, 115  
Reed (Sir E. J.), "Japan," 610  
Reefs, Coral-, and Islands, Prof. Joseph LeConte, 553  
References to Authorities in Scientific Memoirs, 203  
Regel (Dr.), on the Flora of Turkestan, 19  
Reitlinger (Prof.) Electrical Ring-figures, 302  
Repulsion, Electric, a New Kind of, Dr. Arthur Schuster, F.R.S., 535  
Renshaw (A. G.) "Sarsens," 55  
Retina, the Action of the, 89  
Reversals by Memory, Rev. Geo. Henslow, 241  
Revue des Sciences Naturelles, 20, 283  
Revue Internationale des Sciences, 20  
Revue Internationale des Sciences Biologiques, 161  
Revue d'Anthropologie, 503  
Rheims, Meeting of the French Association for the Advancement of Science, at, 154, 276, 397  
Rhizopods, Freshwater, of North America, J. Leidy, 165  
Rice (J. M.), and W. W. Johnson's Treatise on the Differential Calculus, 509  
Richardson (Dr. B. W., F.R.S.), Further Observations and Researches on Fleuss's System of Diving and Living in Irrespirable Atmospheres, 32; On a Prolonged Fast by a Dog, 347  
Ridout's Improved Thermo-Electric Apparatus, 22  
Rifled Arms, Sir Joseph Whitworth on, 130  
Righi (Prof.), Holtz's Electric Machine, 89  
Riimmer (Richard), Land and Freshwater Shells of Great Britain, 483  
Ring and Cup Stones, 221  
Ring-figures, Electrical, Prof. Reitlinger and Dr. Wächter on, 302  
Rio de Janeiro, Minas and San Paulo, Map of Existing and Projected Railways in the Provinces of, 205  
Ritter (Dr. Karl), Presentation of a Gold Medal to, 17  
"River of Golden Sand," Capt. W. Gill, 26  
Rivers (General Pitt [Lane-Fox]) Anthropological Collection, 489, 511  
Rivers, the Classification of, Surgeon H. B. Guppy, 606  
"Revista Scientifico-Industriale," 20, 46, 234, 480, 503  
Robinson (Rev. Dr., F.R.S.), On the Constants of the Cup Anemometer, 404  
Robinson (James F.), "British Bee-Farming," 433  
Rock Salt, Suez Canal, Dr. Ralton, 11  
Rock-weathering, as Illustrated in Churchyards, Prof. A. Geikie, F.R.S., 104  
Rodd's (Edward Hearle), "Birds of Cornwall and the Scilly Islands," 507  
Rodwell (G. F.), Etna, Prof. O. Silvestri, 359  
Roemer (Dr.), "Lethæa geognostica," 264  
Rogers (J. Innes), Spectre of the Brocken at Home, 551  
Rolleston (Prof., F.R.S.) on Round and Long Barrows, 478  
Romanes (G. J., F.R.S.) on Brain Dynamics, 75; the New Freshwater Jelly-fish, 177  
Ronalds (Sir F.), Catalogue of Works on Electricity, Magnetism, &c., 87  
Rooks at Kirkwall, 88  
Ross (Col. W. A.), Alphabetical Manual of Blowpipe Analysis, 336  
Rosse (Lord, F.R.S.), his Telescope, 75  
Rowland (Prof.), on Thermometry, 18  
Royal Academy of Music, Signor Alberto B. Bach on the Cultivation of the Voice, and his Resonator, 204  
Royal Geographical Society's Proceedings, 19, 157, 232, 351, 468, 544; Fiftieth Anniversary of, 114; Journal, 569  
Royal Institution, Prof. W. H. Flower, F.R.S., at the, 16; Annual Meeting, 17; proposed Lectures at, 40  
Royal School of Mines, Prizes and Associateships awarded, 253  
Royal Society, 21, 46, 70, 91, 129, 137, 161, 186, 209, 234, 258, 283, 404  
Royal Society of New South Wales, Sydney, Annual Meeting of, 253  
Royal Microscopical Society, 235; Journal of, 282  
Ruby Lake, disappearance of Water from, 41  
Rudler (F. W.), Address in Section D at the British Association, 421  
Rugby School Natural History Society, 17  
Russell (Dr. W. J.), and Dr. West, on the Relation of the Urea to the total Nitrogen of the Urine in Disease, 186; Absorption Bands in Certain Colourless Liquids, 368  
Russell (Hon. F. A. R.), Experiments on Thin Films of Water with regard to the Absorption of Radiant Heat, 447  
Russia: Physical Science in, 207; Russian Geographical Society, 157; *Isvestia*, 348; the Imperial Yacht *Livadia*, 270

- Sacred Books of the East, Edited by F. Max Müller, Prof. A. H. Sayce on, 189
- St. Elmo's Fire, 375
- St. Gothard Tunnel, 40, 110, 130, 229
- St. Petersburg Society of Naturalists, 183
- Sakhalin, the Miocene Flora of, 349
- Salt: Rock, Suez Canal, Dr. Ralton, 11; Tables for the Analysis of a Simple, A. Vinter, 337
- Salts, Diffusion of, in Aqueous Solution, Herr Long, 280
- Sanderson (Dr. Burdon, F.R.S.), "Experimental Researches on the Time Relations of the Excitatory Process in Frogs," 137
- Sanitation, Society of Arts Conference on, 154
- Sanitary Congress, 540
- Sanitary Institute, 519
- Sapphire Mines in Siam, 230
- "Sarsens," A. G. Renshaw, 55
- Saturn: Occultation of a Fixed Star by, 112; the Satellites of, 399
- Saxifraga umbrosa* adorned with Brilliant Colours by the Selection of Syrpidae, Dr. Hermann Müller, 219
- Sawyer (John), "Automatic Multiplier and Calculator," 316
- Saxon and Thuringian Natural History Society, General Meeting of, at Nordhausen, 131
- Sayce (Prof. A. H.), "Science of Language," A. H. Keane, 49; Garrick Mallery's "Introduction to the Study of Sign Language among the North American Indians," 93; the Recent Progress of English Philology, 167; the Sacred Books of the East, Edited by F. Max Müller, 189; Minerva Ornaments, 219
- Scandinavian Naturalists and Physicians, Meeting of, at Stockholm, 130
- Scandium, 350
- Schäberle's Comet, 467
- Scheffer (Dr. Rudolf), Obituary Notice of, Henry O. Forbes, 12
- Schlagintweit (Herr Robert von), Arrival of, at New York, 68
- Schomburgk (Dr.), Report on the Progress of the Botanic Garden and Government Plantation of South Australia, 253
- Schools, the Opportunities of Science Masters at, Francis Galton, F.R.S., 9
- Schubert (Gotthilf Heinrich von), Celebration of the Centenary of the Birth of, 66
- Schubert (Dr. H.), "Kalkül der abzählenden Geometrie," 557
- Schuster (Dr. A., F.R.S.), on the Spectra of the Metalloids, 444; New Kind of Electric Repulsion, 535
- Schwendler (Louis), "Instruction for Testing Telegraph Lines and the Technical Arrangement of Offices," 94; on the Utilization of Monkeys for Work, 398
- Schwerin, Exhibition of Apparatus relating to Bee-Culture at, 17
- Sciaccia, Discovery of Coral near, 131
- Science in Parliament, 7
- Science Masters, the Opportunities of, at Schools, Francis Galton, F.R.S., 9
- Science and Art, Museum of, in Aberdeen, 66
- Science and Agriculture, Earl Spencer on, 182
- Science and Culture, Prof. T. H. Huxley, F.R.S., 545
- Science, the Place of, in Education, 529
- Science, a New Journal, 275
- Sciences Naturelles, Revue des, 283
- Scientific Practice, 229
- Scientific Societies, Provincial, and the British Association, John Hopkinson, 319, 440
- SCIENTIFIC WORTHIES, XVI.: Richard Owen, C.B., F.R.S. (with Portrait), 577
- Scilly Islands, Birds of, Edward Hearle Rodd, 507
- Sclater (P. L., F.R.S.), Waterfowl, 295; Classification of Birds, 549
- Scotland, Thunderstorms in, A. Buchan, 594
- Scott (Robert H.), the Aurora Borealis, 33
- Scott (R. F.), the Theory of Determinants, 458
- Scottish Cranog, a, 13; Dr. Robert Munro, 34
- Scottish Meteorological Society, 275
- Scottish Naturalists, 137
- Scudder (Prof. S. H.), Modern Entomology, 550
- Seaham Colliery, the Explosion at, 464
- Secchi (Father), Statue of, 39
- Sedgwick (Adam), Proposed Life of, 275
- Sedgwick (Capt.), "Light and Heat," 483
- Seeing by Telegraphy, Profs. John Perry, W. E. Ayrton, 31
- Seismology in Japan, Prof. John Milne, 208
- Selenium, 585; Action of Phosphorescent Light on, 495; and the Photophone, Prof. Graham Bell, 500
- Septum Permeable to Water and Impermeable to Air, with Application to a Navigational Depth Gauge, Sir W. Thomson, F.R.S., 548
- Sewage and Potable Waters, 349
- Sharp (D.), New Biological Term, 364
- Shells, the Land and Freshwater of Great Britain, Richard Rimmer, 483
- Shettle (Dr.), on the Influence of Solar Radiation on the Earth's Rotation, 210
- Shrubsole (W. H.), Diatoms in the London Clay, 221
- Siam, Discovery of Sapphire Mines in, 230
- Siemens (Dr.), Newest Electrical Results, 135
- Sierra Leone, Rainfall of, W. Hume Hart, 585
- Sieve-Tubes of Dicotyledonous Plants, F. Orpen Bower, 602
- Sign-Language among the American Indians, Prof. A. H. Sayce, 93
- Silkworm Culture in Spain, 541
- Silvestri (Prof. O.), Etna, G. F. Rodwell, 359
- Simonton (T. D.), Visibility of Mercury to the Naked Eye, 119
- Simpson-Baikie's, International Dictionary for Naturalists, 17
- Sinholagna, E. Whympers Ascent of, 19
- Siphonophora, American (East Coast), 113
- Sirius, the Companion of, 132
- Skin Furrows of the Hand, Dr. H. Faulds, 605
- Slags, Artificial and Erupted Rocks, Dr. H. C. Sorby, F.R.S., on, 390
- Small Pox in Paris, 111
- Smith (Dr. R. Angus, F.R.S.), Measurement of Actinism of the Sun's Rays and of Daylight, 70
- Smith (W. F.), Ball Lightning, 267
- Smithson (James), and the Smithsonian Institution, 110
- Smithsonian Institute, Annual Report of, 518
- Smyrna: Earthquake at, 329; Hyde Clarke, 363
- Smyth (Prof. Piazzi), an Inevitable Test for Aurora, 76; Three Years' Experimenting in Mensurational Spectroscopy, 193, 222
- Snake, Black, Mr. S. H. Wintle on, 40
- Snake, Green, Experiment on, 40
- Snake in Kensington Gardens, J. Harris Stone, 193
- Snow, Perpetual, Aqueous Vapour in relation to, Dr. J. Croll, F.R.S., 191
- Soames (L.), a Halo, 435
- Society of Arts: Conference on Public Health, 154; the Albert Medal of, awarded to James Prescott Joule, F.R.S., 154; Medals, 203; Annual Meeting, 229
- Socotra, Dr. J. B. Balfour on, 477
- Sodic Chloride Crystals, 31; Dr. Ralton, 11
- Solar Eclipse, the next Total, 112
- Solar Halo on Lake Constance, 111
- Solar Heat, M. Mouchet's Researches on the Utilisation of, 206
- Solar Physics, Preliminary Report on, by the Committee of Council on Education, 44
- Solar Radiation, on the Influence of, on the Earth's Rotation, Dr. Shettle, 210
- Solar Spectrum, the Magnesium Lines in, 596
- Solid Bodies, the Welding of, 350
- Solid Geometry, Elementary Treatise on, W. Steadman Aldis, 531
- Solothurn, Geological Discovery at, 399
- Songs of Birds, 97
- Sorbonne, the, struck by Lightning, 466
- Sorby (Dr. H. C., F.R.S.), Opening Address in Section C at the British Association Meeting, 390
- South African Museum, Report of, for 1879, 205
- South America, Mr. G. Whympers Mountaineering Exploits in, 19
- South Kensington Museum, Opening of the Indian Section of, to the Public, 66
- Sparks (Dr. E. J.), Death of, 591
- Species, Origin of, the Coming of Age of, Prof. T. H. Huxley, F.R.S., 1
- Specific Gravities when in the Liquid State, on the Relation between the Molecular Weights of Substances and their, Prof. T. E. Thorpe, F.R.S., 262
- Spectre of the Brocken at Home, J. Innes Rogers, 559
- Spectrum Analysis: Multiple Spectra, J. Norman Lockyer, F.R.S., 4, 3:9, 562; The Ultra-Violet Spectrum, 90; Three Years' Experimenting in Mensurational Spectroscopy, Prof.

- Piazz Smyth, 193, 222; Spectrum of the Flame of Hydrogen, W. Huggins, F.R.S. on, 283; the line D<sub>2</sub>, 350; A Rotary Polarisation Spectroscope of great Dispersion, Prof. P. G. Tait, 360; Absorption Bands in certain Colourless Liquids, 368; Report on the Ultra-Violet Spectra by Prof. A. K. Huntington, 444; On the Spectra of the Metalloids, Dr. A. Schuster, F.R.S., 444; The Present State of Spectrum Analysis, 522; Spectrum of Hartwig's Comet, W. H. M. Christie, 557; Spectroscopic Investigations, G. Ciamician, 575; The Magnesium Lines in the Solar Spectrum, 596; On the Spectra of the Compounds of Carbon with Hydrogen and Nitrogen, Profs. Living and Dewar, 620
- Spencer (Earl), On Science and Agriculture, 182
- Sphagnaceæ, or Peat-Mosses, Dr. R. Braithwaite, 556
- Spiders and Wasps, 110
- Splenotomy in Dogs, 520
- Sponges, Proposed Bibliography of, 539
- Sportsman's Guide to Scotland, 17
- Sprague (T. B.), Toughened Glass, 292
- Sprengel Pump, Improvements in, 375
- Sprengel Vacuum, the Specific Inductive Capacity of a Good, British Association Report on, 443
- Stags' Horns, Prof. E. W. Claypole, 146; Herbert Ellis, C. Overton, 221
- Stahl (Herr), Motion in Algae, 114
- Standard Weights, Dr. Werner Siemens and his Set of, 64
- Stars, Occultation of a Fixed, by Saturn, 112; Binary α Centauri, 85, 399, 541; Pegasi, 205, 467; δ Equulei, 593; the Colour of Double Stars, C. S. Peirce, 291; Colours of Southern, 495; Variable, 277; Variable Star in Aquarius, 205; Ceraski's New Variable, 455, 616; Prof. E. C. Pickering, 603; Geo. Knott, 603; η Cygni, 348; R Hydra, 542; A New Red Star, John Birmingham, 408
- Statics, Treatise on, Prof. George M. Minchin, 52
- Statistical Society, 116
- Steam-boilers, Incrustation in, 448
- Stebbing (Rev. T. R. R.), Fascination, 338, 534
- Steel and Iron, Immersion of, in Acidulated Water, W. H. Johnson, 11
- Steel, Hardening of, T. W. Giltay, 461; H. J. Johnston-Lavis, 511
- Step Backwards, A, 165
- Stereotyping, a New Process of, 328
- Sternum in Dinosaurs, 113
- Stewart (Prof. Balfour, F.R.S.), Systematic Sun-spot Periodicity, 80; On Some Points Connected with Terrestrial Magnetism, 146, 202
- Stewart (J.), on Lake Nyanza, 67
- Stone Arrow-Heads, W. L. Distant, 11
- Stone in the Swallow's Nest, 459; John Locke, 146; W. E. A. Axon, 242
- Stone (J. Harris), A Snake in Kensington Gardens, 193
- Stone-breaker, An Electrical, 302
- Stones, Cup and Ring, J. Romilly Allen, 97, 221; James Quin, 122
- Storm Effects, J. Rand Capron, 290
- Storm, Magellanic, G. M. Whipple, 558
- Storms of the United States, 594
- Strassburg, Imperial Observatory at, 132
- Stratigraphical Geology, 264
- Streams, Crossing Rapid, 607
- Subterranean Kaolinisation, John A. Church, 317
- Suez Canal Rock Salt, Dr. Ralton, 11
- Sugar, Crystallisable, Mr. Collier on, 278
- Sugar-Cane, the Elephant, 518
- Suicides, Statistics of, 576
- Sulphur, the Elementary Nature of, 349
- Sunday Art Exhibitions, 155
- Sun Signal, or Heliograph, Improved, Dr. Tempest Anderson, 499
- Sun-Spot Periodicity, Systematic, Prof. Balfour Stewart, F.R.S., 80
- Surgery and Superstition in Neolithic Times, 478
- "Swallows," Winter, Prof. Alfred Newton, F.R.S., 29
- Swallow, the Stone in the Nest of the, John Locke, 146; W. E. A. Axon, 242; Chatel, 459
- Swans, Wild—Notes of Birds, J. Birmingham, 171
- Swansea, Handbook to, S. C. Gamwell, 431
- Swedish Lakes and Temperature of Sweden, 132
- Swift's New Comet, 467
- Swinton (A. H.), "Insect Variety," 579
- Swiss Châlets, Rev. Geo. Henslow, 534; H. N. Moseley, 559
- Swiss Natural History Society, Meeting at Brieg, 110
- Switzerland, the Earthquake in, 252; the Triangulation of, 518
- Sydney, University of, Bequest to the, 45
- Sydney, supposed Discovery of Kerosene at, 88; Intercolonial Meteorological Conference at, 160
- Tait (Prof. P. G.), a Rotary Polarisation Spectroscope of Great Dispersion, 360; Thunderstorms, 339, 364, 408, 436
- Tanganyika, Lake of, Establishment of Germans on, 67; Plants from, 586
- Tasmania, Royal Society of, Report of, 133; Discovery of Gold-Fields in, 329
- "Tasmanian Friends and Foes, Feathered, Furred, and Finned," Mrs. L. A. Meredith, 300
- Tay Bridge Accident, 11, 213, 266; Hon. Ralph Abercromby, 533
- Taylor (Alfred Swaine, F.R.S.), Death of, 109
- Taylor (Noble), Toughened Glass, 241
- Taylor (Henry J.), "The Bee-Keeper's Manual," 433
- Taylor (C.), "Elementary Geometry of Conics," 603
- Tea Cultivation in Japan, 569
- Technical Education, Prof. Ayrton on, 616
- Telegraphy: Recent Advances in, M. Antoine Breguet on, 18; Seeing by, Profs. John Perry and W. E. Ayrton, 31; Testing Telegraph Lines, Louis Schwendler, 94
- Telekophon, the, 375
- Telephone: a New Use for the, 157; the Fine Wire, Prof. G. Chrystal, 168; at Liverpool, 230; in South Australia, 275; Experiments with the Wire, chiefly on Strongly Magnetic Metals, Prof. G. Chrystal, 303; Experiments in Switzerland, 329; on a New Form of Receiver, James Blyth, 330; Prof. Chrystal on the Differential, 331; the Telephone and Deaf Persons, 376; "A Baby Telephonist," 442
- Telescope (Lord Rosse's), Otto Struve, 75
- Telescopes and Microscopes, Construction of, 607
- Temperature and Arctic Fossil Floras, J. S. Gardner, 341
- Temperature of the Bread, 607; C. J. McNally, 534; Dr. R. E. Dudgeon, 584
- Temperature, Underground, British Association Report on, 442
- Temple (Lieut. Geo. T.), on the Hydrographic Department, 191; Letter to Col. Fr. Sejersted, 432
- "Teoria delle Forze Newtoniane e sui applicazioni all' Elettrostatica e al Magnetismo del Prof. Enrico Betti," 557
- Terrestrial Magnetism, Comparative Curves in, Rev. S. J. Perry, F.R.S., 120; J. Capello, 220
- Terrestrial Magnetism, on some points connected with, Prof. B. Stewart, F.R.S., 146, 202; Warren De La Rue, F.R.S., Hugo W. Müller, F.R.S., 169
- Thermoelectric Pile, Clöe's, Improvement of the, 19
- Thermoelectric Currents and Chemical Action, 156
- Thermometer, Water-Stream, Sir William Thomson's, 91
- Thermometry, Prof. Rowland on, 18
- Thin (Geo. M. D.), "On *Bacterium fatidum*: an Organism associated with Profuse Sweating from the Soles of the Feet," 209
- Thompson (Prof. S. P.), Arthur Young's Travels in France, 219
- Thomson (Sir Wm., F.R.S.), on "Turning the World Upside Down," 493; on a Septum permeable to Water and impermeable to Air, with Application to a Navigational Depth Gauge, 548; on Maximum and Minimum Energy in Vortex Motion, 618
- Thomson (Sir Wyville, F.R.S.), the Cruise of the *Knight Errant*, 405
- Thorpe (Prof. T. E., F.R.S.), Longstaff Medal awarded to, 109; on the Relation between the Molecular Weights of Substances and their Specific Gravities when in the Liquid State, 262; Supposed New Island in the Azores, 509
- Thunderstorms: in Geneva, Prof. Colladon on, 65; at Hamburg, G. Ambrose Pogson on, 155; at Moylough, 347; Prof. P. G. Tait on, 339, 364, 408, 436; in Scotland, A. Buchan, 554
- "Thüringer Wald" Club, Formation of, at Eisenach, 20
- Thurn (Everard, F. im), Journey to British Guiana, 41
- Thwaites (C.), Fascination, 484
- Tiberias, Lake of, the Fishes of, 494
- Tilden (Dr. W. A.), Principles of Qualitative Analysis, 360
- Timber, Calcareous Concretions in, Dr. G. Bidie, 169
- Tinned Meats, reported Poisoning by, 567
- Tobacco-smoking, Formation of Society against, in Paris, 65

- Todd (C.), Meteorology of South Australia, 120  
Tokio, University of, 230; the Acceleration of Gravity at, 521  
Tombs, Discovery of, at Chamblades, 40  
Tomsk, University of, 441  
Tong-pang-chong, Chinese Remedy for Skin Disease, 541  
Topographical Society of London, 592  
Tornadoes in Missouri, 253  
Torrent, Strange Method of Crossing a, W. Curran, 339; F. F. Tuckett, 382  
Torsion of Wires of Steel, Iron, and Copper, Experiments on, by Herr Warburg, 207  
Torsion, Wire, Major J. Herschel, F.R.S., 557  
Toughened Glass, Noble Taylor, 241; T. B. Sprague, 292  
Trachomedusa, a New Jelly-Fish of the Order of, Living in Fresh-water, Prof. E. Ray Lankester, F.R.S., 147, 177, 190, 241, 316, 361  
Trains, a Substitute for Stopping, 519  
Transverse Vibrations of Light, 363; on a Mode of Explaining, J. W. Frankland, 317  
Transylvania, Earthquake in, 592  
Tree Pruner, Samuel Wood, 336  
Tree Planter, Samuel Wood, 336  
Trees, Effect of Lightning on, L. Cumming, 220  
Treub (Dr. M.), Appointed Director of Botanical Gardens at Buitenzorg, Java, 64  
Trichoptera, European, Monograph of, R. McLachlan, F.R.S., 314  
Trinity College, London, 540  
Tromholt (Prof. Sophus), Auroral Observations, 192  
Tubes, Glass, Experiments with, J. T. Bottomley, 291  
Tuckett (F. F.), Strange Method of Crossing a Torus, 382  
Tuning-forks, Vibrations of, Dr. König, 92  
Tupman (Major G. I.), Great Meteor, 242  
Turkestan, Flora of, Dr. Regel on, 19  
Twelvetrees (W. II.), Ural Crayfish, 10  
Two Dimensions and of Finite Extent, on the Simplest Continuous Manifold of, C. J. Monro, 218  
Typhoons, Père Marc Dechevrens on, 183  
Tyrol, Earthquakes in the, 399  
"U-nach, the Sons of," and "Loch Etive," 289  
Ujfalvy (C. E. de), Expedition to Central Asia, 351  
Underground Temperature, British Association Report on, 442  
United States: Weather Maps, August, 1878, 36, 100, 249, 516; Geological Survey of New Jersey, 348; Prof. Loomis on the Temperature of, 594  
"Universe, Key to the," Orson Pratt, sen., 290  
University College, London, Meeting to Raise Funds for the Completion of the Buildings, 228  
University College, London, Prof. Ray Lankester, F.R.S., on, 228  
University and Educational Intelligence, 45, 70, 90, 115, 136, 160, 185, 208, 233, 257, 282, 307, 330, 575, 590, 623  
Universities, the Proposed Abolition of Clerical Fellowships, &c., 250; the *Times* on the Functions of, 251  
Ural Crayfish, W. II. Twelvetrees, 10  
Urea, Relation of, to the Total Nitrogen of the Urine in Disease, Doctors Russell and West, 186  
Urine of Cows, Phosphoric Acid in the, 595  
Utah, the Plateau of, Capt. C. E. Dutton, Prof. A. Geikie, F.R.S., 324  
Utricularia, Lieut. J. W. Clark, 318  
Vacuo, High, Contributions to Molecular Physics in, W. Crookes, F.R.S., 125  
"Valley Naturalist," 568  
Vapour Densities, Determinations of, 349  
Varenne (J.), Researches on the Passivity of Iron, 279  
Variable Nebula near  $\zeta$  Tauri, 231  
Variable Stars, 277; in Aquarius, 205;  $\eta$  Cygni, 348, 454; Ceraski's New, 455, 603, 616; R Hydrae, 542  
Vaucanson Collection, Catalogue of, 276  
Vayssière (M.), on a Problem in Entomology, 130  
Veeder (M. A.), Mosquitos, 460  
Vegetable Kingdom, Evolution of, W. B. Hemsley, 190  
Venice, International Congress of Geography at, 398  
Verhandlungen der k.k. Zoologisch-botanischen Gesellschaft in Wien, 20  
Vesta, Diameter of, 231  
Vesuvius, appearance of the Phylloxera in the Vineyards of, 17  
Opening of the Railway, 131; Activity of, 466  
Vevey Cigars, 87  
Vibration, Experiments on, 207  
Vibrations of Flames, Prof. Carmichael on, 18  
Vibrations of Light: on a Mode of Explaining Transverse, J. W. Frankland, 317; Transverse, 363  
Victoria: Mineral Statistics of, 343; Royal Society of, Transactions, 518  
Victoria (Philosophical) Institute, 92, 163  
Victoria University, Manchester, 261, 274  
Vienna: the International Congress of Meteorology at, 16  
Imperial Academy of Sciences, 48, 163, 187, 236, 260, 308, 356; Mittheilungen of Geographical Society, 68  
Vine, A New, 495  
Vines (S. H.), Translation of "Prant's Text-Book of Botany," 216  
Vinter (A), Tables for the Analysis of a Simple Salt, 337  
Violins, Tone of, Lewis Wright, 435  
Vivisection, Dr. B. G. Wilder on the two Kinds of, 517  
Voice, The Science of Production and Preservation of, for the Use of Speakers and Singers, Gordon Holmes, 143  
Voice, Human, the Mechanism of the, Emil Behnke, 239  
Voice, Philosophy of, Sequel to the, Chas. Lunn, 556  
Volcanic Eruption in Dominica, Edmund Wall, 77  
Volcano (Lacustrine), 129  
Volcanic Dust from Dominica, W. E. Wadsworth, 266  
Volcanoes: Mount Etna, 346; Fuego, 346, 441, 544; Vesuvius, 466  
Voltmeters, Leyden Jars, &c., Reduction of Observations on, 258  
Vortex Atom Theory, S. Tolver Preston, 56, 121; G. H. Darwin, F.R.S., 95; On the Physical Aspects of the, 145  
Vortex Motion, On Maximum and Minimum Energy in, Sir William Thomson F.R.S., 618  
"Vox Populi": A Sequel to the "Philosophy of Voice," Chas. Lunn, 556  
Wächter (Dr.), Electrical Ring-figures, 322  
Wadsworth (M. E.), Volcanic Dust from Dominica, 266  
Wagner (Dr. Hofrath von), Death of, 567  
"Waiting Carriage," W. M. F. Petrie, 534  
Walford (Cornelius), Recall of Appearance of Books, &c., 220  
Wales, South, Ethnology of, 421  
Wallace (Alfred R.), on Two Darwinian Essays, 141; "Island Life," 398  
Ward (Rev. J. Clifton), Proposed Memorial to, 328  
Warner Observatory, 614  
Wartegg (Chevalier Ernst von Hesse), Travels in North Africa, 231  
Washington, Philosophical Society of, 440  
Wasps, Carnivorous, 31  
Wasps and Spiders, 110  
Water Supply, Charles Ekin, 221  
Water, Living on, 294  
Water, Excretion of, by Leaves, Dr. J. W. Moll, 403  
Waterfowl, P. L. Sclater, F.R.S., 295  
Watt (Edmund), Recent Volcanic Eruption in Dominica, 77; Monkeys in the West Indies, 318  
"Weapons and Politics of the Ancient Hindus," G. Oppert, 581  
Weather Maps (United States), 36, 100, 249, 372, 516  
Weights, Standard, Dr. Werner Siemens and his Set of, 64  
Weismann (Dr. Aug.), "Studies in the Theory of Descent," 141  
Welding of Solid Bodies, 357  
Weltende, Discovery of Diluvial Bones at, 66  
*Welsitschia mirabilis*, Germination of, F. Orpen Bower, 590  
West Indies, Monkeys in, John Murie, 77, 318  
Westphal's Comet (1852, IV.), 184  
West Harptree, Discovery of Natural Caverns in the Neighbourhood of, 204  
Whipple (G. M.), Magnetic Storm, 558  
Whitaker (J.), "Guide to the Geology of London," 481  
White (Dr. Buchanan), the number of Known Species of Hemiptera-Heteroptera, 606  
Whitworth (Sir Joseph), on Rifled Arms, 130  
Whymper's (E.), Mountaineering Exploits in South America, 19; Ascent of Pichincha, 41

- Wickham, New South Wales, Discovery of Metallic Stone at, 131
- Wilder (Dr. B. G.), on "The Two Kinds of Vivisection," 517
- Williams (B. Price), on "The Increase of Population in England and Wales," 205
- Williamson (J.), "Fern Etchings: Illustrating all the Species of Ferns Indigenous to the North-Eastern United States and Canada," 168
- Williamson (Prof. W. C., F.R.S.), Plants of the Coal Measures, 281
- Wines, Doctored, 561
- Winnecke's Comet, 131
- Winter "Swallows," Prof. Alfred Newton, F.R.S., 29
- Wintle, S. H., on Black Snakes, 40
- Wire Telephone, Experiments with the, chiefly on Strongly Magnetic Metals, Prof. G. Chrystal, 303
- Wire Torsion, Major J. Herschel, F.R.S., 557; Professors John Perry and W. E. Ayrton, 604
- Wires, the Elasticity of, J. J. Bottomley, 447
- Women's Admission to Academic Degrees, Proposed, 70
- Women and the London University Examinations, 399
- Woodpecker, the Lesser Spotted, Duke of Argyll, 95
- Woodward (C. J.), Colour Combinations, 171
- Woodward (Dr.) appointed Keeper of the Geological Department of the British Museum, 228
- Wood (Samuel), the "Tree Planter," 336; the "Tree Pruner," 336
- Woolwich Guns, 293
- Worms, Circulation in, 113
- Worms, Intestinal, in the Horse, H. Krabbe on, 277
- Wright (Lewis), Tone of Violins, 435
- Wurtz (A.), "Elements of Modern Chemistry," 8
- Wyoming and Idaho, North American Geology, Prof. Archibald Geikie, F.R.S., 268
- Yacht, Russian Imperial, *Livadia*, 270
- Yale College, the Collection of Vertebrate Fossils, 373
- Yang-tse, the, the Yellow River, and the Pei-ho, Surgeon H. B. Guppy, 486; T. Mellard Reade, 559
- Yeast and Black Beetles, 11
- Yeddo, article in "L'Exploration" on, 68
- Yellow River, the, the Yang-tse, and the Pei-ho, Surgeon H. B. Guppy, 486; T. Mellard Reade, 559
- Yorkshire College, Annual Report, 347
- Young's (Arthur) Travels in France, Prof. S. P. Thompson, 219
- Ytterbium, 349
- Yuccas under Cultivation, Consul E. L. Layard, 606
- Zehfuss (Herr), on "After-Images of Motion," 90
- Zeitschrift für das chemische Grossgewerbe, Jul. Post, 95
- Zeitschrift für wissenschaftliche Zoologie, 20, 160, 552
- Zimmern's (Mrs.) "Geography for Little Children," 20
- Zinc-Carbon Battery, New, R. Anderson, 133
- Zinc Powder, Decomposition of Organic Compounds by, Prof. Ludwig, 89
- Zittel (Dr.), the Geology of the Libyan Desert, 587
- Zoological Gardens, Additions to, 17, 40, 66, 88, 111, 155, 183, 205, 230, 276, 301, 330, 347, 374, 399, 432, 466, 495, 519, 541, 569, 616; the Guide to, 329
- Zoological Society, 16, 21, 71, 162, 235, 442
- Zoological Station, A. C. Haddon's Temporary, at Torbay, 517, 560
- Zoology, Society of, Berlin, 65



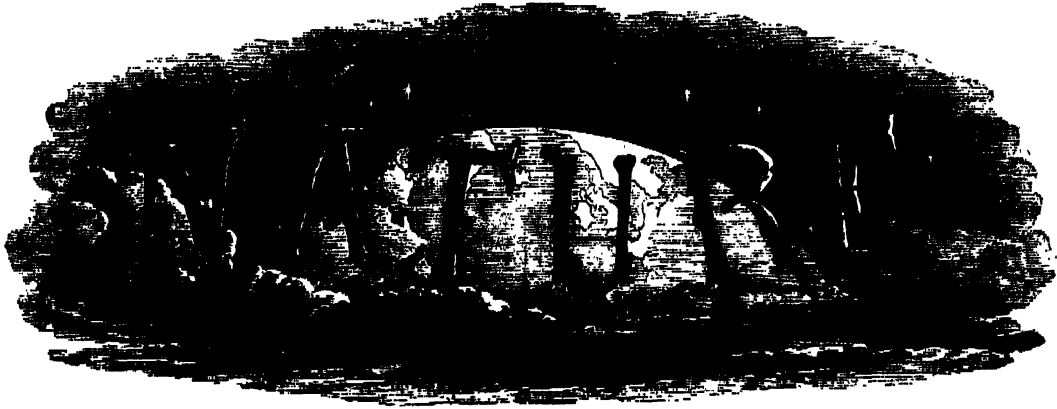

## A WEEKLY ILLUSTRATED JOURNAL OF SCIENCE

*"To the solid ground  
Of Nature trusts the mind which builds for aye."*—WORDSWORTH

THURSDAY, MAY 6, 1880

### *THE COMING OF AGE OF THE ORIGIN OF SPECIES\**

MANY of you will be familiar with the aspect of this small green-covered book. It is a copy of the first edition of the "Origin of Species," and bears the date of its production—the first of October, 1859. Only a few months, therefore, are needed to complete the full tale of twenty-one years since its birthday.

Those whose memories carry them back to this time will remember that the infant was remarkably lively, and that a great number of excellent persons mistook its manifestations of a vigorous individuality for mere naughtiness; in fact there was a very pretty turmoil about its cradle. My recollections of the period are particularly vivid; for, having conceived a tender affection for a child of what appeared to me to be such remarkable promise, I acted for some time in the capacity of a sort of under-nurse, and thus came in for my share of the storms which threatened even the very life of the young creature. For some years it was undoubtedly warm work, but considering how exceedingly unpleasant the apparition of the new-comer must have been to those who did not fall in love with him at first sight, I think it is to the credit of our age that the war was not fiercer, and that the more bitter and unscrupulous forms of opposition died away as soon as they did.

I speak of this period as of something past and gone, possessing merely a historical, I had almost said an antiquarian interest. For, during the second decade of the existence of the "Origin of Species," opposition, though by no means dead, assumed a different aspect. On the part of all those who had any reason to respect themselves, it assumed a thoroughly respectful character. By this time the dullest began to perceive that the child was not likely to perish of any congenital weakness or infantile disorder, but was growing into a stalwart personage, upon whom mere goody scoldings and threatenings with the birch-rod were quite thrown away.

In fact, those who have watched the progress of science within the last ten years will bear me out to the full when I assert that there is no field of biological inquiry in which the influence of the "Origin of Species" is not traceable; the foremost men of science in every country are either avowed champions of its leading doctrines, or at any rate abstain from opposing them; a host of young and ardent investigators seek for and find inspiration and guidance in Mr. Darwin's great work; and the general doctrine of Evolution, to one side of which it gives expression, finds in the phenomena of biology a firm base of operations whence it may conduct its conquest of the whole realm of nature.

History warns us, however, that it is the customary fate of new truths to begin as heresies and to end as superstitions; and, as matters now stand, it is hardly rash to anticipate that, in another twenty years, the new generation, educated under the influences of the present day, will be in danger of accepting the main doctrines of the Origin of Species with as little reflection, and it may be with as little justification, as so many of our contemporaries, twenty years ago, rejected them.

Against any such a consummation let us all devoutly pray; for the scientific spirit is of more value than its products, and irrationally-held truths may be more harmful than reasoned errors. Now the essence of the scientific spirit is criticism. It tells us that to whatever doctrine claiming our ascent we should reply, Take it if you can compel it. The struggle for existence holds as much in the intellectual as in the physical world. A theory is a species of thinking, and its right to exist is coextensive with its power of resisting extinction by its rivals.

From this point of view it appears to me that it would be but a poor way of celebrating the Coming of Age of the Origin of Species were I merely to dwell upon the facts, undoubted and remarkable as they are, of its far-reaching influence and of the great following of ardent disciples who are occupied in spreading and developing its doctrines. Mere insanities and inanities have before now swollen to portentous size in the course of twenty years. Let us rather ask this prodigious change in opinion to justify itself; let us inquire whether anything has happened since 1859 which will explain, on rational grounds, why so many are worshipping that which they burned, and burning

\* A Lecture delivered at the Royal Institution, Friday, March 19.  
VOL. XXII.—NO. 549



that which they worshipped. It is only in this way that we shall acquire the means of judging whether the movement we have witnessed is a mere eddy of fashion, or truly one with the irreversible current of intellectual progress, and, like it, safe from retrogressive reaction.

Every belief is the product of two factors: the first is the state of the mind to which the evidence in favour of that belief is presented; and the second is the logical cogency of the evidence itself. In both these respects the history of biological science during the last twenty years appears to me to afford an ample explanation of the change which has taken place; and a brief consideration of the salient events of that history will enable us to understand why, if the "Origin of Species" appeared now, it would meet with a very different reception from that which greeted it in 1859.

One-and-twenty years ago, in spite of the work commenced by Hutton and continued with rare skill and patience by Lyell, the dominant view of the past history of the earth was catastrophic. Great and sudden physical revolutions, wholesale creations and extinctions of living beings, were the ordinary machinery of the geological epic brought into fashion by the misapplied genius of Cuvier. It was gravely maintained and taught that the end of every geological epoch was signalised by a cataclysm, by which every living being on the globe was swept away, to be replaced by a brand-new creation when the world returned to quiescence. A scheme of nature which appeared to be modelled on the likeness of a succession of rubbers of whist, at the end of each of which the players upset the table and called for a new pack, did not seem to shock anybody.

I may be wrong, but I doubt if at the present time there is a single responsible representative of these opinions left. The progress of scientific geology has elevated the fundamental principle of uniformitarianism, that the explanation of the past is to be sought in the study of the present, into the position of an axiom; and the wild speculations of the catastrophists, to which we all listened with respect a quarter of a century ago, would hardly find a single patient hearer at the present day. No physical geologist now dreams of seeking outside the ranges of known natural causes for the explanation of anything that happened millions of years ago, any more than he would be guilty of the like absurdity in regard to current events.

The effect of this change of opinion upon biological speculation is obvious. For, if there have been no periodical general physical catastrophes, what brought about the assumed general extinctions and re-creations of life which are the corresponding biological catastrophes? And if no such interruptions of the ordinary course of nature have taken place in the organic, any more than in the inorganic, world, what alternative is there to the admission of Evolution?

The doctrine of Evolution in Biology is the necessary result of the logical application of the principles of uniformitarianism to the phenomena of life. Darwin is the natural successor of Hutton and Lyell, and the "Origin of Species" the natural sequence of the "Principles of Geology."

The fundamental doctrine of the "Origin of Species," as of all forms of the theory of Evolution applied to biology, is "that the innumerable species, genera, and families of organic beings with which the world is peopled have all descended, each within its own class or

group, from common parents, and have all been modified in the course of descent."<sup>1</sup>

And, in view of the facts of geology, it follows that all living animals and plants "are the lineal descendants of those which lived long before the Silurian epoch."<sup>2</sup>

It is an obvious consequence of this theory of Descent with Modification, as it is sometimes called, that all plants and animals, however different they may now be, must, at one time or other, have been connected by direct or indirect intermediate gradations, and that the appearance of isolation presented by various groups of organic beings must be unreal.

No part of Mr. Darwin's work ran more directly counter to the prepossessions of naturalists twenty years ago than this. And such prepossessions were very excusable, for there was undoubtedly a great deal to be said, at that time, in favour of the fixity of species and of the existence of great breaks, which there was no obvious or probable means of filling up, between various groups of organic beings.

For various reasons, scientific and unscientific, much had been made of the hiatus between man and the rest of the higher mammalia, and it is no wonder that issue was first joined on this part of the controversy. I have no wish to revive past and happily forgotten controversies, but I must state the simple fact that the distinctions in cerebral and other characters, which were so hotly affirmed to separate man from all other animals in 1860, have all been demonstrated to be non-existent, and that the contrary doctrine is now universally accepted and taught.

But there were other cases in which the wide structural gaps asserted to exist between one group of animals and another were by no means fictitious; and, when such structural breaks were real, Mr. Darwin could account for them only by supposing that the intermediate forms which once existed had become extinct. In a remarkable passage he says:—

"We may thus account even for the distinctness of whole classes from each other—for instance of birds from all other vertebrate animals—by the belief that many animal forms of life have been utterly lost, through which the early progenitors of birds were formerly connected with the early progenitors of the other vertebrate classes."<sup>3</sup>

Adverse criticism made merry over such suggestions as these. Of course it was easy to get out of the difficulty by supposing extinction; but where was the slightest evidence that such intermediate forms between birds and reptiles as the hypothesis required ever existed? And then probably followed a tirade upon this terrible forsaking of the paths of "Baconian induction."

But the progress of knowledge has justified Mr. Darwin to an extent which could hardly have been anticipated. In 1862, the specimen of *Archæopteryx*, which until the last two or three years has remained unique, was discovered; and it is an animal which, in its feathers and the greater part of its organisation, is a veritable bird, while, in other parts, it is as distinctly reptilian.

In 1868, I had the honour of bringing under your notice, in this theatre, the results of investigations made, up to that time, into the anatomical characters of certain ancient

<sup>1</sup> "Origin of Species," ed. 1, p. 457.

<sup>2</sup> "Origin of Species," ed. 1, p. 458.

<sup>3</sup> "Origin of Species," ed. 1, p. 431.

reptiles, which showed the nature of the modifications in virtue of which the type of the quadrupedal reptile passed into that of the bipedal bird; and abundant confirmatory evidence of the justice of the conclusions which I then laid before you has since come to light.

In 1875, the discovery of the toothed birds of the cretaceous formation in North America, by Prof. Marsh, completed the series of transitional forms between birds and reptiles, and removed Mr. Darwin's proposition that "many animal forms of life have been utterly lost, through which the early progenitors of birds were formerly connected with the early progenitors of the other vertebrate classes," from the region of hypothesis to that of demonstrable fact.

In 1859, there appeared to be a very sharp and clear hiatus between vertebrated and invertebrated animals, not only in their structure, but, what was more important, in their development. I do not think that we even yet know the precise links of connection between the two; but the investigations of Kowalewsky and others upon the development of *Amphioxus* and of the *Tunicata* prove beyond a doubt that the differences which were supposed to constitute a barrier between the two are non-existent. There is no longer any difficulty in understanding how the vertebrate type may have arisen from the invertebrate, though the full proof of the manner in which the transition was actually effected may still be lacking.

Again, in 1859, there appeared to be a no less sharp separation between the two great groups of flowering and flowerless plants. It is only subsequently that the series of remarkable investigations inaugurated by Hofmeister has brought to light the extraordinary and altogether unexpected modifications of the reproductive apparatus in the *Lycopodiaceae*, the *Rhizocarpeae*, and the *Gymnospermae*, by which the ferns and the mosses are gradually connected with the Phanerogamic division of the vegetable world.

So, again, it is only since 1859 that we have acquired that wealth of knowledge of the lowest forms of life which demonstrates the futility of any attempt to separate the lowest plants from the lowest animals, and shows that the two kingdoms of living nature have a common borderland which belongs to both or to neither.

Thus it will be observed that the whole tendency of biological investigation since 1859 has been in the direction of removing the difficulties which the apparent breaks in the series created at that time; and the recognition of gradation is the first step towards the acceptance of evolution.

As another great factor in bringing about the change of opinion which has taken place among naturalists, I count the astonishing progress which has been made in the study of embryology. Twenty years ago, not only were we devoid of any accurate knowledge of the mode of development of many groups of animals and plants, but the methods of investigation were rude and imperfect. At the present time there is no important group of organic beings the development of which has not been carefully studied, and the modern methods of hardening and section-making enable the embryologist to determine the nature of the process in each case, with a degree of minuteness and accuracy which is truly astonishing to those whose memories carry them back to the beginnings

of modern histology. And the results of these embryological investigations are in complete harmony with the requirements of the doctrine of Evolution. The first beginnings of all the higher forms of animal life are similar, and however diverse their adult conditions, they start from a common foundation. Moreover the process of development of the animal or the plant from its primary egg or germ is a true process of evolution—a progress from almost formless to more or less highly organised matter, in virtue of the properties inherent in that matter.

To those who are familiar with the process of development all *a priori* objections to the doctrine of biological evolution appear childish. Any one who has watched the gradual formation of a complicated animal from the protoplasmic mass which constitutes the essential element of a frog's or a hen's egg has had under his eyes sufficient evidence that a similar evolution of the animal world from the like foundation is, at any rate, possible.

Yet another product of investigation has largely contributed to the removal of the objections to the doctrine of Evolution current in 1859. It is the proof afforded by successive discoveries that Mr. Darwin did not overestimate the imperfection of the geological record. No more striking illustration of this is needed than a comparison of our knowledge of the mammalian fauna of the Tertiary epoch in 1859 with its present condition. M. Gaudry's researches on the fossils of Pikermi were published in 1868, those of Messrs. Leidy, Marsh, and Cope on the fossils of the Western Territories of America, have appeared almost wholly since 1870; those of M. Filhol, on the phosphorites of Quercy, in 1878. The general effect of these investigations has been to introduce us to a multitude of extinct animals, the existence of which was previously hardly suspected; just as if zoologists were to become acquainted with a country, hitherto unknown, as rich in novel forms of life, as Brazil or South Africa once were to Europeans. Indeed the fossil fauna of the Western Territories of America bids fair to exceed in interest and importance all other known Tertiary deposits put together; and yet, with the exception of the case of the American tertiary, these investigations have extended over very limited areas, and at Pikermi were confined to an extremely small space.

Such appear to me to be the chief events in the history of the progress of knowledge, during the last twenty years, which account for the changed feeling with which the doctrine of Evolution is at present regarded by those who have followed the advance of biological science in respect of those problems which bear indirectly upon that doctrine.

But all this remains mere secondary evidence. It may remove dissent, but it does not compel assent. Primary and direct evidence in favour of Evolution can be furnished only by palæontology. The geological record, so soon as it approaches completeness, must, when properly questioned, yield either an affirmative or a negative answer; if evolution has taken place, there will its mark be left; if it has not taken place, there will lie its refutation.

What was the state of matters in 1859? Let us hear Mr. Darwin, who may be trusted always to state the case against himself as strongly as possible.

"On this doctrine of the extermination of an infinitude of connecting links between the living and extinct inhabi-

tants of the world, and at each successive period between the extinct and still older species, why is not every geological formation charged with such links? Why does not every collection of fossil remains afford plain evidence of the gradation and mutation of the forms of life? We meet with no such evidence, and this is the most obvious and plausible of the many objections which may be urged against my theory."<sup>1</sup>

Nothing could have been more useful to the opposition than this characteristically candid avowal, twisted as it immediately was into an admission that the writer's views were contradicted by the facts of palæontology. But, in fact, Mr. Darwin made no such admission. What he says in effect is, not that palæontological evidence is against him, but that it is not distinctly in his favour; and without attempting to attenuate the fact, he accounts for it by the scantiness and the imperfection of that evidence.

What is the state of the case now, when, as we have seen, the amount of our knowledge respecting the mammalia of the Tertiary epoch is increased fifty-fold, and in some directions even approaches completeness?

Simply this, that if the doctrine of Evolution had not existed palæontologists must have invented it, so irresistibly is it forced upon the mind by the study of the remains of the Tertiary mammalia which have been brought to light since 1859.

Among the fossils of Pikermi, Gaudry found the successive stages by which the ancient civets passed into the more modern hyænas; through the Tertiary deposits of Western America, Marsh tracked the successive forms by which the ancient stock of the horse has passed into its present form; and innumerable less complete indications of the mode of evolution of other groups of the higher mammalia have been obtained.

In the remarkable memoir on the Phosphorites of Quercy, to which I have referred, M. Filhol describes no fewer than seventeen varieties of the genus *Cynodictis*, which fill up all the interval between the viverrine animals and the bear-like dog *Amphicyon*; nor do I know any solid ground of objection to the supposition that in this *Cynodictis-Amphicyon* group we have the stock whence all the Viveridæ, Felidæ, Hyænidæ, Canidæ, and perhaps the Procyonidæ and Ursidæ, of the present fauna have been evolved. On the contrary, there is a great deal to be said in its favour.

In the course of summing up his results, M. Filhol observes<sup>2</sup> :—

"During the epoch of the phosphorites, great changes took place in animal forms, and almost the same types as those which now exist became defined from one another.

"Under the influence of natural conditions of which we have no exact knowledge, though traces of them are discoverable, species have been modified in a thousand ways: races have arisen which, becoming fixed, have thus produced a corresponding number of secondary species."

In 1859, language of which this is an unintentional paraphrase, occurring in the "Origin of Species," was scouted as wild speculation; at present, it is a sober statement of the conclusions to which an acute and critically-minded investigator is led by large and patient study of the facts of palæontology. I venture to repeat what I have said before, that, so far as the animal world is con-

cerned, Evolution is no longer a speculation, but a statement of historical fact. It takes its place alongside of those accepted truths which must be taken into account by philosophers of all schools.

Thus when, on the first day of October next, the "Origin of Species" comes of age, the promise of its youth will be amply fulfilled; and we shall be prepared to congratulate the venerated author of the book, not only that the greatness of his achievement and its enduring influence upon the progress of knowledge have won him a place beside our Harvey; but, still more, that, like Harvey, he has lived long enough to outlast detraction and opposition, and to see the stone that the builders rejected become the head-stone of the corner.

T. H. HUXLEY

### ON MULTIPLE SPECTRA

"Nunc age, quo motu genitalia materia  
Corpora res varias gignant, genitasque resolvant  
Et qua vi facere id cogantur."

*Lucretius*, ii., 61-2.

"Prima moventur enim per se primordia rerum :  
Inde ea, quæ parvo sunt corpora conciliatu,  
Et quasi proxima sunt ad vireis principiorum,  
Ictibus illorum cæcis impulsa cœntur  
Ipsaque, quæ porro paulo maiora, læcessunt."

*Lucretius*, ii. 132-6.

"It is conceivable that the various kinds of matters, now recognised in different elementary substances, may possess one and the same ultimate or atomic molecule existing in different conditions of movement.

"The essential unity of matter is an hypothesis in harmony with the equal action of gravity upon all bodies."—*Graham's Researches*, p. 299.

IN a recent paper<sup>1</sup> I showed that a study of the minute anatomy of spectra, both terrestrial and celestial, forces upon us the conclusion that both in the electric arc and in the hottest region of the sun the so-called chemical elements behave after the manner of compound bodies.

I then dealt more especially with the question of the basic lines in the various spectra, and it is clear that if, at any one temperature, there be some lines only truly basic in the spectrum of any element, we at once divide the lines visible at that temperature into two groups, those which are basic and those which are not. This would give a compound origin to the lines, and this is the real point.

It is now years ago since the view was first held that the elementary bodies had double spectra, that is, that each, or at all events several, under changed conditions of temperature or electric tension, gave us now a fluted spectrum and now one composed of lines.

I glimpsed the idea some time afterwards that the line spectrum was in its turn in all probability a complex whole, in other words that it was the summation of the spectra of various molecular groupings.

Recent work has to my mind not only shown that this is true, but that in the case of many bodies the complexity, and therefore the number, of the molecular groupings which give rise to that compound whole called a line spectrum, is considerable.

It is therefore important from my point of view to reconsider the evidence on which the assertion that the

<sup>1</sup> "Origin of Species, ed. 1, p. 463.

<sup>2</sup> This passage was omitted in the delivery of the lecture.

<sup>1</sup> "On the Necessity for a New Departure in Spectrum Analysis" (NATURE, vol. xxi. p. 8).

fluted bands and the line spectrum (taken as a whole) of a substance really belong to that substance, because if we find that this must be accepted and that it can easily be explained on the view that the two kinds of spectra are produced by different molecular groupings, the fact of other molecular groupings giving rise to a complex line spectrum can be more readily accepted, contrary though it be to modern "chemical philosophy," as taught at all events in the text-books.

Plucker and Hittorf were, I believe, the first to point out that the same chemical substance, when in a state of gas or vapour, gave out different spectra under different conditions. On this point they wrote fifteen years ago:—

"The first fact which we discovered in operating with our tubes . . . was the following one:—

"There is a certain number of elementary substances which, when differently heated, furnish two kinds of spectra of quite a different character, not having any line or any band in common.

"The fact is important, as well with regard to theoretical conceptions as to practical applications—the more so as the passage from one kind of spectrum to the other is by no means a continuous one, but takes place abruptly. By regulating the temperature you may repeat the two spectra in any succession *ad libitum*." (Plucker and Hittorf on the Spectra of Ignited Gases and Vapours: *Phil. Trans. Royal Society*, 1865, part i. p. 6.)

Ångström, whose name must ever be mentioned with the highest respect by any worker in spectrum analysis, was distinctly opposed to this view, and in the text which accompanies his *Spectre Normal* we find the following statement—

"Dans un Mémoire sur les spectres 'doubles' des corps élémentaires que nous publierons prochainement, M. Thalén et moi, dans les Actes de la Société des Sciences d'Upsal, nous traiterons d'une manière suffisamment complète les questions importantes qu'on peut se proposer sur cet intéressant sujet. Pour le présent, je me borne à dire que les résultats auxquels nous sommes arrivés, ne confirment aucunement l'opinion émise par Plücker, qu'un corps élémentaire pourrait donner, suivant sa température plus ou moins élevée, des spectres tout-à-fait différents. C'est le contraire qui est exact. En effet en augmentant successivement la température, on trouve que les raies varient en intensité d'une manière très-compliquée, et que, par suite, de nouvelles raies peuvent même se présenter, si la température s'élève suffisamment. Mais, indépendamment de toutes ces mutations, le spectre d'un certain corps conservera toujours son caractère individuel."<sup>2</sup>

Ångström did not object merely on theoretical grounds. He saw, or thought he saw, room to ascribe all these fluted spectra to impurities.

He was strengthened in this view by observing how, in the case of the spectra of known compounds, there were always flutings in one part of the spectrum or another; a rapid induction naturally, therefore, ascribed all flutings to compounds. The continuity of the gaseous and liquid states of matter, let alone the continuity of Nature's processes generally, never entered into the question. For Ångström, as for the modern chemist, there was no such thing as evolution, no possibility of a close physical relationship between elements, so called, driven to incandescence from the solid state, and binary compounds of those elements.

<sup>1</sup> Ångström sur "Le Spectre normal du Soleil," page 39.

In a memoir, however, which appeared after Ångström's death, and which, though under a different title, was in all probability the one referred to, this opinion was to a large extent recalled, and in favour of Plucker's view, in the following words:—

" . . . Nous ne nions certainement pas qu'un corps simple ne puisse dans certains cas donner différents spectres. Citons, par exemple, le spectre d'absorption d'iode que ne ressemble en aucune façon au système des raies brillantes du même corps, obtenues au moyen de l'électricité; et remarquons de plus qu'en général tout corps simple, présentant la propriété d'allotropie, doit donner à l'état d'incandescence des spectres différents, pourvu que la dite propriété de la substance subsiste non seulement à l'état gazeux du corps, mais encore à la température même de l'incandescence. . . .

"Le soufre solide possède, comme on sait, plusieurs états allotropiques, et, d'après certaines observations, ce corps, même à son état gazeux, prendrait des formes différentes. Par conséquent, en supposant que cela soit vrai, le soufre gazeux doit donner plusieurs spectres d'absorption, tandis que la possibilité d'un seul ou de plusieurs spectres brillants dépendra de la circonstance suivante, savoir si les états allotropiques plus complexes de cette substance supporteront la température de l'incandescence, avant de se décomposer.

"Il est bien évident que les cas dont nous venons de parler, ne forment pas une exception à la loi générale énoncée ci-dessus, savoir que chaque corps simple ne peut donner qu'un seul spectre. En effet, si l'on suppose que l'état allotropique est dû à la constitution moléculaire du corps, soit que les molécules se combinent les unes avec les autres, soit qu'elles s'arrangent entre elles d'une certaine manière, cet état allotropique possèdera au point de vue spectroscopique, toutes les propriétés significatives d'un corps composé, et par conséquent il doit être décomposé de la même façon que celui-ci par les effets de la décharge disruptive de l'électricité."<sup>1</sup>

I say that in this paper Ångström recalled his own in favour of Plucker's view, because (as it has been remarked by Dr. Schuster<sup>2</sup>) the word "element" is used in a special sense—because in reality allotropic states are classed as compounds, that particular allotropic state which is to be regarded as truly elemental not being stated, nor any reason given why one should be thus singled out.

In the letter to which I have just referred Dr. Schuster gives an instance in which in order to show that elementary bodies did not really possess two spectra, a double spectrum was assigned to an acknowledged compound; the fluted spectra of hydrogen and carbon which differ from each other as widely as fluted spectra can, being both ascribed to acetylene.

Salet in his admirable work on the Spectra of the Metalloids,<sup>3</sup> was driven to the conclusion that many of these bodies must be held to possess two spectra. His conclusions are thus expressed:—

"Nous avons comparé le spectre d'absorption du brome et de l'iode à leur spectre électrique, et cette comparaison nous semble mettre hors de doute la possibilité des spectres doubles. . . .

"Nous avons obtenu, par voie électrique, un spectre primaire de l'iode correspondant à son spectre d'absorption. Le soufre, le sélénium et le tellure nous ont offert des spectres de combustion très-analogues aux spectres primaires obtenus par voie électrique, mais différant essentiellement des spectres des lignes. . . .

<sup>1</sup> Ångström and Thalén's "Recherches sur les Spectres des Métalloïdes," p. 5.  
<sup>2</sup> *NATURE*, vol. xv. p. 447.  
<sup>3</sup> *Ann. de Chimie et de Physique*, 1873, vol. xxviii. p. 1.

"Nous avons produit le spectre primaire de l'azote avec différents corps qui n'ont absolument de commun que l'azote; nous pensons donc avoir démontré qu'il appartient bien réellement à ce métalloïde." (*Annales de Chimie et de Physique*, 4 série, tome xxviii, pp. 70, 71).

In 1868 Wullner<sup>1</sup> gave his attention to this subject, and strongly supported Plucker's view of the existence of double spectra, indicating at the same time that the difference of temperature must be regarded as the sole cause of the phenomenon, adding, however, "a decomposition with further elements is not to be thought of." In the case of hydrogen he showed that the banded spectrum ascribed to acetylene really depended upon a change in the emissive power brought about by an alteration of temperature. Touching oxygen, he showed that three distinct spectra may be obtained, while in nitrogen two are observed.

I may say that in my early laboratory experiments I was at first led to think that, in the case of metallic vapours, Ångström's first expressed opinion was correct, and I said so. But after more experience and knowledge had been acquired, I was compelled by the stern logic of facts to abandon it, and I showed, first, that more "orders" of spectra—to use Plucker's term—were necessary, and then that the line spectrum itself was in all probability compound; that is, that it was in some cases built up by the vibration of dissimilar molecules, some of which might even give us a fluted spectrum, if we could study them alone.

Although, however, in the views I have expressed on former occasions I have had the advantage of the support of the opinion of Plucker and Ångström, and later of Dr. Schuster,<sup>2</sup> not to mention others, I am aware that though there is a general consensus among spectroscopic workers that double spectra cannot be ascribed to impurities, it is not absolute.

I propose therefore in this place to refer to a special case in which this question has been recently brought prominently forward.

I have already stated that Ångström, who was the first to map the line-spectrum of carbon, ascribed the flutings ordinarily seen in the carbon compounds to acetylene.

Now Attfeld, in 1862, as a result of a most carefully conducted and admirably-planned set of experiments, came to the conclusion that the flutings were really due to carbon: in short, that carbon, like hydrogen, iodine, sulphur, nitrogen, and other bodies, had a fluted spectrum as well as one consisting wholly of lines.

The work of Attfeld will be gathered from the following extract from his paper (*Phil. Trans.*, vol. clii. part 1, p. 221 *et seq.*):—

"On recently reading Swan's paper by the light that

<sup>1</sup> *Phil. Mag.*, sec. 4, vol. xxxvii, p. 405.

<sup>2</sup> Dr. Schuster's recently published investigations are as follows:—

Mr. Lockyer's investigations have shown that most bodies give us a continuous spectrum, as a gas, before they condense, and many at a considerable temperature above the boiling point. Mr. Lockyer has rightly drawn the conclusion from these facts, that the atomic aggregation of the molecules is the cause of the different orders of spectra.

That the discontinuous spectra of different orders (line and band spectra) are due to different molecular combination, I consider to be pretty well established, and analogy has led me (and Mr. Lockyer before me) to explain the continuous spectra by the same cause; for the change of the continuous spectrum to the line or band-spectrum takes place in exactly the same way as the change of spectra of different orders into each other. Analogy is not a strong guide, yet some weight may be given to it in a case like the one under discussion, where experiment hitherto has failed to give a decided answer. (Dr. A. Schuster on the Spectra of Metalloids, *Phil. Trans. Royal Society*, 1879. Part i. page 38 and 83, n. te.)

Professors Bunsen and Kirchhoff have thrown on the subject, I came to the conclusion that these bands must be due to incandescent carbon vapour; that, if so, they must be absent from flames in which carbon is absent, and present in flames in which carbon is present; that they must be observable equally in the flames of the oxide, sulphide, and nitride as in that of the hydride of carbon; and, finally, that they must be present whether the incandescence be produced by the chemical force, as in burning jets of the gases in the open air, or by the electric force, as when hermetically-sealed tubes of the gases are exposed to the discharge of a powerful induction-coil.

"To establish the absolute identity of the hydro- and nitro-carbon spectra, excluding of course the lines due to nitrogen, they were simultaneously brought into the field of the spectroscope; one occupying the upper, and the other the lower half of the field.

"This was readily effected after fixing the small prism, usually supplied with spectroscopes, over half of the narrow slit at the further end of the object-tube of the instrument. The light from the oxyhydrocarbon flame was now directed up the axis of the tube by reflection from the little prism, while that from the oxynitrocarbon flame passed directly through the uncovered half of the slit. A glance through the eye-tube was sufficient to show that the characteristic lines of the hydrocarbon spectrum were perfectly continued in the nitrocarbon spectrum. A similar arrangement of apparatus, in which the hydrocarbon light was replaced by that of pure nitrogen, showed that the remaining lines of the nitrocarbon spectrum were identical with those of the nitrogen spectrum. In this last experiment the source of the pure nitrogen light was the electric discharge through the rarefied gas.

"The above experiment certainly seemed to go far towards proving the spectrum in question to be that of the element carbon. Nevertheless, the ignition of the gases having been effected in air, it was conceivable that hydrogen, nitrogen, or oxygen had influenced the phenomena. To eliminate this possible source of error, the experiments were repeated out of contact with air. A thin glass tube 1 inch in diameter and 3 inches long, with platinum wires fused into its sides, and its ends prolonged by glass quills having a capillary bore, was filled with pure dry cyanogen, and the greater portion of this gas then removed by a good air-pump. Another tube was similarly prepared with olefiant gas. The platinum wires in these tubes were then so connected with each other that the electric discharge from a powerful induction-coil could pass through both at the same time. On now observing the spectra of these two lights in the simultaneous manner previously described, the characteristic lines of the hydrocarbon spectrum were found to be rigidly continued in that of the nitrocarbon. Moreover, by the same method of simultaneous observation, the spectrum of each of these electric flames, as they may be termed, was compared with the corresponding chemical flames, that is, with the oxyhydrocarbon and oxynitrocarbon jets of gas burning in air. The characteristic lines were present in every case. Lastly, by similar inter-observation a few other lines in the electric spectrum of the hydrocarbon were proved to be due to the presence of hydrogen, and several others in the electric spectrum of the nitrocarbon to be caused by the presence of nitrogen. . . ."

"The spectrum under investigation having then been obtained in one case when only carbon and hydrogen were present, and in another when all elements but carbon and nitrogen were absent, furnishes, to my mind, sufficient evidence that the spectrum is that of carbon."

"But an interesting confirmation of the conclusion just stated is found in the fact that the same spectrum is obtained when no other elements but carbon and oxygen are present, and also when carbon and sulphur are the

only elements under examination. And first with regard to carbon and oxygen. Carbonic oxide burned in air gives a flame possessing a continuous spectrum. A mixture of carbonic oxide and oxygen burned from a platinum-tipped safety-jet also gives a more or less continuous spectrum, but the light of the spectrum has a tendency to group itself in ill-defined ridges. Carbonic oxide, however, ignited by the electric discharge in a semi-vacuous tube, gives a bright sharp spectrum. This spectrum was proved, by the simultaneous method of observation, to be that of carbon plus the spectrum of oxygen. With regard to carbon and sulphur almost the same remarks may be made. Bisulphide of carbon vapour burns in air with a bluish flame. Its spectrum is continuous. Mixed with oxygen and burned at the safety-jet, its flame still gives a continuous spectrum, though more distinctly furrowed than in the case of carbonic oxide; but when ignited by the electric current its spectrum is well defined, and is that of carbon plus the sulphur. That is to say, it is the spectrum of carbon plus the spectrum that is obtained from vapour of sulphur when ignited by the electric discharge in an otherwise vacuous tube."

"Having thus demonstrated that dissimilar compounds containing carbon emit, when sufficiently ignited, similar rays of light, I come to the conclusion that those rays are characteristic of ignited carbon vapour, and that the phenomena they give rise to on being refracted by a prism is the spectrum of carbon."

This question was next taken up by Morren. He wrote<sup>1</sup> (in 1865) fifteen years ago:—

"A la réception de cet intéressant et substantiel Mémoire, j'avoue que je ne regardai pas d'abord comme fondée l'assertion de M. Attfeld. . . .

"Je me suis donc mis au travail avec la pensée préconçue de combattre l'assertion émise par le savant anglais; mais pas du tout, il résulte au contraire des expériences auxquelles je me suis livré que M. Attfeld a raison, et que c'est bien la vapeur du carbone qui donne le spectre indiqué plus haut. . . .

"Si on fait brûler le cyanogène au moyen du chalumeau à deux courants, en faisant arriver au centre de la flamme du cyanogène un courant d'oxygène très-pur (cette condition est indispensable), on voit se produire un des plus beaux effets de combustion possible, et cette expérience est certainement une des plus magnifiques qu'on puisse réaliser sur la combustion des gaz. Il se produit, au milieu de la flamme rose-violetée du cyanogène, une boule d'un blanc vert ébouillant qui rappelle la lumière électrique produite par le courant de la pile entre deux charbons de cornue. Si le spectroscopie est dirigé sur cette brillante lumière, on aperçoit, avec une splendeur merveilleuse, le même spectre de la partie bleue des flammes hydrocarbonées. Ainsi donc c'est du charbon seul, mais à l'état de vapeur, qui forme cette boule brillante qui plus loin, par son union avec l'oxygène, va passer à l'état d'acid carbonique. Du reste ce spectre n'est pas seul; avec lui on voit, mais très-effacé, le spectre spécial du cyanogène, et celui-ci tend de plus en plus à disparaître à mesure que l'oxygène arrive avec plus d'abondance et brûle de mieux en mieux le cyanogène. Quant au spectre de l'azote, on ne l'aperçoit pas dans cette vive lumière. Le magnifique éclat de ce beau spectre, le plus beau qu'il m'ait été donné de voir, permet de bien comprendre l'aspect creusé et ombré avec une teinte croissante qu'on remarque dans les parties qui n'ont pas de raies brillantes, et même entre ces raies."

Four years later Dr. Watts devoted himself to this subject, and in 1869 his work was thus summarised by himself:<sup>2</sup>—

<sup>1</sup> *Annales de Chimie et de Physique*, 4 série, t. me iv. p. 309, 312.  
<sup>2</sup> *Phil. Mag.*, October, 1869.

"This spectrum [that consisting of the flutings in question] may be obtained from the flame of any hydrocarbon, though in many cases, owing to the faintness of the spectrum, only some of the groups can be recognised. In the flame of an ordinary Bunsen burner  $\delta$  and  $\epsilon$  are easily seen,  $\gamma$  and  $f$  are much fainter, and the red group cannot be detected.

"This spectrum is proved to be that of carbon, inasmuch as it can be obtained alike from compounds of carbon with *hydrogen*, with *nitrogen*, with *oxygen*, with *sulphur*, and with *chlorine*. I have obtained it, namely, from each of the following compounds:—olefiant gas, cyanogen, carbonic oxide, naphthalin, carbonic disulphide, carbonic tetrachloride, amylic alcohol, and marsh-gas."

That these conclusions, successively arrived at by Attfeld, Morren, and Watts, are sound, I shall show in my next notice.

J. NORMAN LOCKYER

(To be continued.)

### SCIENCE IN PARLIAMENT

THE House of Commons is now complete; all the boroughs and counties have made their choice, and the composition of the new Parliament has been and will be criticised from many points of view. So far as the interests of science and of what we conceive to be good education are concerned, there is, we fear, little difference between the present House of Commons and its predecessor; just a thin ray of light athwart a cloud of darkness, a tiny morsel of knowledge in a mass of ignorance. This ignorance, however, we are bound to believe is not wilful; we must admit that our new rulers are willing to be enlightened, unless in time they should show themselves otherwise disposed.

On this ground, as well as on others, it is to be lamented that one of the most eminent and useful scientific members of the House has lost his scat through some local caprice. The absence of Sir John Lubbock from the new Parliament is one we are sure every true lover of science will deplore. Where there is so much ignorance to be overcome, it seems to us we cannot have too many representatives of science in Parliament; and we are sure all who desire to see science advanced in this country would welcome any chance of getting Sir John back to his old place. Such an opportunity has, some may think almost providentially, presented itself in the vacancy that has occurred in the representation of London University by the promotion of Mr. Lowe to "another place." Several candidates have been proposed for the vacant scat, but alongside of Sir John Lubbock all must strike an impartial onlooker as singularly unsuitable. The "doctors" have been attempting to put in a strong claim to have themselves specially represented, supporting their cause, so far as London University is concerned, by somewhat shaky statistics. But medicine has no lack of friends in both Houses of Parliament; the claims which it has on the country are patent to all, and it is, moreover, included under the wider region of science. If the latter gets fair play from Government, medicine need have no fear that her claims will be neglected. Already are two Scottish universities represented by Dr. Lyon Playfair, who is nothing if not medical. Not one of our English universities has a man of science as its representative, and it is surely important that an institution in which science holds so prominent

a place as London University should have a scientific man for its representative. Sir George Jessel has for some reason a few strenuous advocates, who seem to forget that their candidate resigned his seat for Dover on the ground that it was contrary to the spirit of the act. Sir George is an excellent lawyer, but there are already too many of them in Parliament. Sir John Lubbock has already been fourteen years member of the Senate, and nearly eight vice-chancellor; thus by returning him not only would the London University confer a benefit on Parliament and the country at large, but at the same time would do the best they could for their own interests. We need not here insist on the claims of Sir John as a man of science; his eminence in this department, as well as a man of business is, known to all. He is indeed so many-sided that he would represent as few others could the different faculties which combine to form the London University. His career in Parliament has been marked by a large number of measures which he has carried through Parliament, all of them of a kind more or less affecting the alumni of London University, and several of them directly affecting those very medical men that would now turn their backs upon him. Sir John has been officially connected with various bodies and various movements having for their object the promotion of learning and science, and now we believe he has had the great honour of being designated as President of the British Association for its jubilee meeting at York next year. We should have thought that for a body like the members of London University it would have been unnecessary to point out Sir John Lubbock's claims upon them, and his peculiar fitness to represent them in Parliament. We are confident that all the scientific members of the institution will record their votes in his favour, and by sending him to Parliament strengthen the hands of the few who are intelligently convinced of the necessity of introducing and carrying out those reforms which are so much needed in the attitude of Government towards science and education.

#### WURTZ'S "CHEMISTRY"

*Elements of Modern Chemistry.* By Adolphe Wurtz. Translated and edited by Wm. H. Greene, M.D. (London: W. Swan Sonnenschein and Allen, 1880.)

**M** WURTZ is one of the recognised leaders of modern chemistry: a text-book from his pen is sure to be hailed with interest and pleasure.

The reputation of the author as an original thinker and worker in chemical science leads one to look for something more than the ordinary orthodox collection of oft-repeated facts in any work bearing his name. And the opening pages of the book before us are certainly very refreshing. Simple and commonly-occurring facts are clearly and simply stated, and on these, as a basis, is laid at once the foundation of chemical theory.

The leading features of the book are, clearness of statement, selection of typical facts from among the vast array at the service of the chemical compiler, and devotion of a comparatively large space to chemical theory and to generalisations which are usually dismissed in a few words in the ordinary text-book.

Perhaps the most remarkable feature of M. Wurtz's book is that, notwithstanding that within less than 700

moderate-sized pages there is given an account of the leading properties of all the more important substances known to chemistry, the book is nevertheless exceedingly interesting and eminently readable. Probably this result could only be attained by a French writer.

In a very early part of the book the modern theory of valency or equivalency is explained, and this theory pervades the whole of the work. The great objection to the book, considered as an exponent of modern chemistry, in our opinion, is this marked devotion to one favourite theory. The objection which we should make to the book, considered more broadly as a scientific treatise, is that theoretical considerations are too much treated as identical with facts, and that facts are, seemingly, supposed to be explained when they are only stated in the language of that peculiar theory which finds in such expressions as "exchange of affinities," "satisfaction of bonds," &c., an *explanation* of chemical phenomena. The theory of valency assumes that the molecular weights of those compounds which are employed in determinations of valency are known. But at present we know the molecular weights of gasifiable bodies only; hence no exact conclusions concerning valencies can be drawn from a study of non-gasifiable compounds. Nevertheless M. Wurtz appears to regard the formulæ of many non-volatile metallic oxides as on an equal footing with those of such compounds as water, hydrochloric acid, &c., and as just as serviceable for determinations of elementary valencies.

Indeed we do not find given a clear definition of molecular weight as distinguished from atomic weight. Avogadro's hypothesis, it is true, is mentioned, but not clearly stated as the basis of the modern system of molecular weight determinations. And without a definition of molecular weight, clearly established, it is impossible to grasp the modern acceptance of the term atomic weight.

In such a work as this one might reasonably look for a statement of the results of the recent work, of first-rate importance, of Guldberg and Waage, and of Ostwald, on Chemical Affinity, more especially as the subject of mass action is mentioned and Berthollet's laws are detailed.

The general subject of affinity is somewhat vaguely treated. Thermal chemistry scarcely finds any recognition in the work.

It may seem invidious to mention faults of detail; but there are a few which, we think, might very profitably be corrected in a second edition.

The nomenclature of the oxyacids of sulphur is certainly erroneous: hyposulphurous acid— $H_2SO_2$ —is called hydrosulphurous, and thiosulphuric— $H_2S_2O_3$ —hyposulphurous. The nomenclature of the oxides of iodine is also peculiar, and the formulæ of the known oxides are somewhat startling: perbromic acid is still enumerated among the oxyacids of bromine. Dry sulphuretted hydrogen is said to be energetically decomposed by iodine.  $SO_2$  is called sulphurous oxide *or* sulphurous acid gas; and, lastly, Lavoisier is said to have determined the composition of water in 1785.

That part of the book which deals with the carbon compounds is not so satisfactory as the portion treating of inorganic chemistry. The classification is most unnatural, and the treatment of many important groups, *e.g.*, the alcohols and terpenes, is unsatisfactory.

We should not think it possible for an average student

of chemistry, beginning the study of the carbon compounds with the aid of this manual, to gain any but most hazy ideas regarding the general scope of this branch of the science.

But notwithstanding such defects as those we have mentioned there can be little doubt that M. Wurtz's book is possessed of many admirable qualities. In place of masses of unconnected facts he presents the student with carefully-selected leading data; he may, we think, strain some of his favourite theories too much, yet he inculcates the paramount necessity of theoretical explanations; he gives prominence to generalisations, such as equivalents, combining weights, and laws of multiple proportions, nomenclature and notation, bases, acids, and salts, &c., &c., and these he develops historically with great clearness and rare felicity of illustration; and he gives just sufficient detail concerning chemical manufactures as suffices to render these intelligible to the ordinary student of chemistry.

The translation appears to be admirably executed. The book is well printed, and the illustrations are distinct. But why should one be led to believe that spirit-lamps and charcoal-furnaces are still the ordinary appliances for raising the temperature of substances in chemical laboratories?

In reading the historical notes which are given concerning most of the important compounds and generalisations of chemistry, one is almost persuaded to believe that, after all, "chemistry is a French science."

M. M. P. M.

#### OUR BOOK SHELF

*The Geological Antiquity of Insects.* Twelve Papers on Fossil Entomology. By Herbert Goss, F.L.S. 8vo, pp. 1-50. (London: John Van Voorst, 1880.)

THIS bulky pamphlet must prove decidedly useful both to geologists and entomologists. The subject of fossil entomology has of late assumed gigantic proportions, and asserted an importance little dreamt of when palæontology first substantiated its claims as the real guide to geologists in determining the nature of many strata. Indeed, as is truly stated by Mr. Goss, the wonder is that remains of any animals so fragile as insects could have been preserved sufficiently for scientific purposes; yet we find contemporaneous with the remains of those marvellous Devonian fishes those of the earliest types of insects, chiefly only wings, it is true, but wings in such a complete state of preservation that the intricacies of neuration can be traced; and this neuration is in some cases so difficult to homologise with that of existing forms that a separate, supposed extinct order (*Palæodictyoptera*) has been formed (probably unnecessarily) for the reception of these remains. Mr. Goss has given detailed accounts (with copious references) of almost every described species of fossil insect from the older formations, and has contrived to very lucidly place before his readers the sequence of appearance of the now-existing orders according to the testimony of the rocks. As we ascend in the geological scale the indications become less complete, and only genera, or eventually only families, are alluded to, but always with the same copious references to authorities. It could not be otherwise. As we ascend the materials increase enormously, until at last, in the post-tertiary system, we find ourselves in the presence of remains that have been identified with species now living in the same district; and in somewhat less recent strata in North

America the multitude of fossil remains of insects is such as to place it out of the question that any detailed account could be given of them. Not the least useful feature in the work consists in the notes on the correlation of special insect-forms with the most remarkable animal and vegetable relics from the same formations.

This pamphlet has no claims as embodying the results of original research; it is a useful concentrated compilation from the literature on the subject by one who evidently has an intelligent knowledge of it both in its geological and zoological aspects, and as such cannot fail to be of service as a text-book, giving the student a clear outline sketch, and the references where to seek more detailed information. Such a work [is often more useful than original essays, which, from the magnitude of the subject, can only be limited in their aim. The treatment may be a little unequal, and we think it would be possible to point out cases in which certain fossil-insects have been referred to a wrong position; but this is the fault of the original describers.

We are rather sorry to see that all notice of Amber-Insects is intentionally omitted for the present, more especially as, from the medium in which they are preserved, these are the most perfect of all fossil insect-remains. They consist for the most part of well-marked existing genera, but we think no one has yet dared to identify any amber-insect with an existing species. In connection with this subject one word of caution to palæontologists with regard to many fossil insects. We find many insects (excluding those in amber) referred to modern genera, and even among those from ancient strata. This is a convenience only; it indicates that certain fossils present the general appearance of the existing genera to which they are referred; but in the majority of instances it does not prove that they would be so referred if the remains were in the same condition as the recent materials. In most cases we think it would be otherwise.

The substance of this pamphlet originally appeared as a series of introductory papers in vols. xv. and xvi. of the *Entomologist's Monthly Magazine*, but the reprint contains additional matter.

#### LETTERS TO THE EDITOR

[The Editor does not hold himself responsible for opinions expressed by his correspondents. Neither can he undertake to return, or to correspond with the writers of, rejected manuscripts. No notice is taken of anonymous communications.]

[The Editor urgently requests correspondents to keep their letters as short as possible. The pressure on his space is so great that it is impossible otherwise to ensure the appearance even of communications containing interesting and novel facts.]

#### The Opportunities of Science Masters at Schools

IN consequence of my publishing in your columns some facts on visual and other memory, I have been favoured with letters from many persons and from many countries; few however have been more acceptable than those from the masters and mistresses of schools. Confining my remarks for the present to the masters of the larger establishments, I may mention that the science masters of Cheltenham and of Winchester have promised assistance, but I write especially to acknowledge the aid already rendered to me by Mr. W. H. Poole, the science master of Charterhouse, and to make some comments thereon, in order to show how wide and yet how neglected a field for original research lies open to every schoolmaster. Mr. Poole has sent me returns from all the boys who attended his classes—172 in number. He selected certain of my questions concerning visual and other memory, he explained them clearly to the boys and interested them in the subject, and then he set them the questions to answer in writing, just as he would have set questions in the ordinary course of school-work. Lastly, he forwarded to me the replies in separate bundles corresponding to the different classes, and each paper was numbered, so that if I wanted to learn more about any of them and sent him the numbers, he



could ascertain the names of the writers. In this simple manner, by almost a single stroke, Mr. Poole has called a mass of statistical data into existence, more thorough and complete than could perhaps have been procured in any other way. I have spent many hours in analysing the answers, and find that they bear generally the marks of painstaking and veracity; they have already led me to results which appear important, but of which this is not the time to speak.

The observation I desire to make is that as every hospital fulfils two purposes, the primary one of relieving the sick, and the secondary one of advancing pathology, so every school might be made not only to fulfil the primary purpose of educating boys, but also that of advancing many branches of anthropology. The object of schools should be not only to educate, but also to promote directly and indirectly the science of education.

It is astonishing how little has been done by the schoolmasters of our great public schools in this direction, notwithstanding their enviable opportunities. I know absolutely of no work written by one of them in which his experiences are classified in the same scientific spirit as hospital cases are by a physician, or as other facts are by the scientific man in whose special line of inquiry they lie. Yet the routine of school work is a daily course of examination. There, if anywhere, the art of putting questions and the practice of answering them is developed to its highest known perfection. In no other place are persons so incessantly and for so long a time under close inspection. Nowhere else are the conditions of antecedents, age, and present occupation so alike as in the boys of the same form. Schools are almost ideally perfect places for statistical inquiries. If a census on other subjects such as this that has been made by Mr. Poole, was carried out, say once a term, or even once a year, at each great public school, what a rich statistical output we should annually witness. Or again, if a schoolmaster were now and then found capable and willing to codify in a scientific manner his large experiences of boys, to compare their various moral and intellectual qualities, to classify their natural temperaments, and generally to describe them as a naturalist would describe the fauna of some new land, what excellent psychological work might be accomplished! But all these great opportunities lie neglected. The masters come and go, their experiences are lost, or almost so, and the incidents on which they were founded are forgotten, instead of being stored and rendered accessible to their successors; thus our great schools are like mediæval hospitals, where care-taking was unknown, where pathological collections were never dreamt of, and where in consequence the art of healing made slow and uncertain advance.

Some schoolmaster may put the inquiry, What are the subjects fitted for investigation in schools? I can only reply, Take any book that bears on psychology, select any subject concerning the intellect, emotions, or senses in which you may feel an interest; think how a knowledge of it might best be advanced either by statistical questioning or by any other kind of observation, consult with others, plan carefully a mode of procedure that shall be as simple as the case admits, then take the inquiry in hand and carry it through.

FRANCIS GALTON

### Museum Conference

PRESUMING that the object of a museum is twofold, viz., to instruct the general public through the eye and to serve as a repository of material by means of which specialists can carry on their scientific and historical researches, it must be obvious to every thoughtful observer how inadequate the machinery generally is to the end in view. A visitor, let us suppose, to the zoological department of a museum, observes a number of birds bearing a general family likeness, and a name under each specimen. Having no pictorial clue to the habits, native country, or specific distinctions of the numerous specimens, no verbal description before him, and no intelligent curator on the spot to give the information required, he goes away with a hazy impression of what he has seen, and too often with a headache. Surely there is room for improvement in the direction of the amount of information that could be conveyed by proper adjuncts to the specimens, and by grouping them according to the countries to which they belong, &c.? Many a missionary going abroad would gladly learn something of the economical and medicinal products of the country to which he is going; but in a museum in which vegetable products are grouped according to their natural orders his difficulties are increased tenfold. I can imagine no better means of improving the character of museums and of increasing their usefulness than

a conference of curators to exchange ideas and the results of their experience. With regard to the use of museums by those seeking special information, the circumstances are very different in large cities and in small towns. In cities, as a rule, the curator naturally becomes in time the depository of a large amount of special information, for which there is such a demand that time is rarely left him for the manual labour and supervision which the keeping of a museum in good order involves. In this case it is assistance that is required rather than increase of salary, although a curator should in my opinion be so well paid that he need not be obliged to resort to literary work to eke out a living.

In provincial towns the case is somewhat different. The curator has less demand made upon his time by specialists, but he needs to be well acquainted with almost every branch of art and natural history, and is often expected to be able to lecture upon any subject that can at all be included within the range of objects in the museum. Such extensive knowledge is rarely to be found concentrated in one person, and consequently one branch of natural history is often pursued to the exclusion of others, as of arts and antiquities, or *vice versa*; and it is little consolation to the naturalist who has done good local work to think that if his collection be left to the local museum it may become devoured by insects or neglected by a subsequent curator who takes little or no interest in that particular branch.

A monthly or quarterly publication would form an excellent means of communication for the exchange of duplicates, the distribution to suitable quarters of the productions of foreign countries for purposes of investigation, for the record of improvements in manipulation or exhibition, and for the results of experience in various directions. Such a publication, if circulated abroad, might be made the means of incalculable benefit to trade by suggesting uses for little known native productions and by bringing residents abroad in communication with those at home who could direct them how best to utilise the resources of newly-explored districts.

I see no reason also why museums, especially those of a technical character, should not be made in some degree self-supporting, by charging a small admission fee to visitors and a fixed fee for the identification of objects used or to be used in trade. I trust the subject of a museum conference will be well ventilated in your columns, and that the liberal offer of the Council of the Society of Arts will soon be turned to account by a preliminary meeting in the rooms of that Society. I would suggest that those who are able and willing to form an executive committee should forward their names at once to Mr. Paton, who will then be in a position to carry out a scheme which cannot fail to produce a beneficial effect upon the education of the nation at large.

E. M. HOLMES

### Ural Crayfish

REFERRING to the notice in NATURE, vol. xxi. p. 454, of M. Malakhoff's memoir on Ural Crayfish, you will perhaps allow me, a resident among the foot-hills of the South-Western Urals, space for a few words. *Astacus leptodactylus* is found in most of the streams here, in some abundantly. The variety is that in which the cephalo-thorax and chelæ are studded with tubercles, and is accurately represented in Prof. E. Ray Lankester's Fig. 2, in NATURE, vol. xxi. p. 354. I have one before me at the present moment from a tributary of the River Bielala, measuring five inches in length, and this is the average size. I have never seen the mountain variety mentioned in M. Malakhoff's paper. His remark that "in the Ural the natives call the freshwater *Unio Rak* (*Ecrevisse*) and the true crayfish *Rak-ryba* (*Ecrevisse poisson*)" does not apply to this district, for here the latter is called simply "rak" and the *unio* "rakovitz" and "rakovina" indifferently, general terms for a mollusc and its shell. Various opinions exist in reference to the quality of the flesh. For my own part I find it extremely insipid, and I believe any Englishman eating it for the first time would be of the same opinion; but the inhabitants of the country, who have, of course, no opportunity of tasting fresh marine crustacea, rather esteem the flesh. Englishmen staying here a long time often grow to like it in default of anything better, till I verily believe in some cases they leave the country praising it as a delicacy. This may be one of the ways in which the diverging opinions respecting its quality have originated.

W. H. TWELVE TREES

Voshresensky Zavod, near Orenburg, Russia,  
March 27 (April 8)

**Protection against Mosquitos, Flies, and Blight**

MR. HAGEN'S letter on the destruction of insect-pests (NATURE, vol. xxi. p. 611) induces me to make generally known an absolute preventive of the bites of mosquitos, gnats, of green-fly in the vinery, blight in the garden, and a protection to animals from these "insect-pests." A few years ago I had some peach-trees which, being on a wall exposed to draught, were annually blighted. One died, and the new wood of the others was not more than a hand's length. A scientific friend advised me to try a weak solution of quassia to water them with, and the success was complete. Blight was prevented. The first year the trees bore well and the new wood was elbow-length or more. I next tried quassia in the vinery. Instead of lime-washing the walls to get rid of the green-fly, one watering with quassia dismissed them in a day. My head-gardener, who had previously much experience in nursery-grounds, wondered that he had never heard of it before. He now uses it in all cases as a protection from flies and blight. The dilution goes a long way: one pound of chips of quassia-wood boiled and reboiled in other water until he has eight gallons of the extract for his garden-engine. He finds it inadvisable to use it stronger for some plants. This boiling makes the quassia adhesive, and being principally applied to the underleaf, because most blight settles there, it is not readily washed off by rain. Quassia is used in medicine as a powerful tonic, and the chips are sold by chemists at from sixpence to a shilling a pound. The tree is indigenous to the West Indies and to South America.

And now as to gnats and mosquitos. A young friend of mine, severely bitten by mosquitos and unwilling to be seen so disfigured, sent for quassia-chips and had boiling water poured upon them. At night, after washing, she dipped her hands into the quassia water and left it to dry on her face. This was a perfect protection, and continued to be so whenever applied. The pastilles sold in Florence and elsewhere, which are vaunted to be safeguards against mosquitos, are, from my own experience, of no use.

At the approach of winter, when flies and gnats get into houses and sometimes bite venomously, a grandchild of mine, eighteen months old, was thus attacked. I gave the nurse some of my weak solution of quassia to be left to dry on his face, and he was not bitten again. It is innocuous to children, and it may be a protection also against bed insects, which I have not had the opportunity of trying. When the solution of quassia is strong it is well known to be an active fly-poison, and is mixed with sugar to attract flies, but this is not strong enough to kill at once. If it be true that mosquitos have been imported into one of the great hotels in the south-west of London, it might be very useful to anoint some of the furniture with it. Then a strong solution with sugar set about the rooms ought to clear them out.

Oatlands Park, Weybridge

WM. CHAPPELL

**Immersion of Iron and Steel in Acidulated Water**

IN NATURE, vol. xxi. p. 602, I have read an interesting account of Prof. Hughes's experiments on the change produced in iron and steel wire by immersion in acidulated water.

May I ask you to draw the Professor's attention to my experiments on this subject, *vide Proceedings of the Literary and Philosophical Society of Manchester*, January 7, March 4, December 30, 1873; January 13, March 10 and 24, 1874; and *Proceedings of the Royal Society*, No. 158, 1875; and a short article in NATURE, I think.

It has long been known to manufacturers of iron wire that iron becomes brittle after immersion in dilute sulphuric or hydrochloric acids. I believe, however, that I was the first to show that this change was due to occluded hydrogen, and by a careful series of experiments to determine approximately the percentage alteration in the breaking strain and elongation at the moment of rupture produced by occluded hydrogen in—

- (a) Ordinary or puddled iron wire;
- (b) Iron wire manufactured with charcoal instead of coal;
- (c) Mild or Bessemer steel;
- (d) Cast steel.

I also found an increased electrical resistance in wire containing occluded hydrogen, though subsequent experiments have led me to believe that the numbers I first published were too large.

My papers also called attention to the diffusion of hydrogen in iron wire beyond the part immersed in acidulated water; the increase in the length of wire charged with hydrogen and some other phenomena.

The whole subject of the occlusion of hydrogen by metals is one of great interest, and the scientific world will be glad if an accomplished experimenter like Prof. Hughes turns his attention to the subject.

WILLIAM H. JOHNSON

The Ferns, Bowdon, near Manchester, April 26

**Stone Arrow Heads**

THE interesting investigations of Mr. Redding on the method of making the above objects, as referred to in NATURE, vol. xxi. p. 613, have been somewhat anticipated by Mr. Paul Schumacher, "Methods of making stone weapons," *Bull. U.S. Geol. and Geog. Survey*, vol. iii. p. 547, 1877, which again was a translation from an earlier publication in *Archiv für Anthropologie*, vol. vii. p. 263. Mr. Schumacher's information was derived from the last arrow-maker of a tribe of Klamath Indians, and appears to correspond generally with that obtained by Mr. Redding from the representative of another tribe in the same region. Mr. Schumacher states that obsidian is not the only stone used, but chert, chalcedony, jasper, agate, and similar stones of conchoidal fracture. "The rock is first exposed to fire, and, after a thorough heating, rapidly cooled off, when it flakes readily into shreds of different sizes under well-directed blows at its cleavage." The process is also illustrated in Mr. Schumacher's paper. Superior stone mortars are often found in use amongst these Californian Indians, who deny their capability of making such objects, and account for their possession as "finds" either on the surface or beneath the earth, and describe them as the work of another and previous race.

W. L. DISTANT

Derwent Grove, East Dulwich, May 1

**The Mode of Suckling of the Elephant Calf**

IN some of the accounts recently published of the birth of an elephant in a menagerie in America it is stated that up to this time naturalists had always believed that the elephant calf obtained its mother's milk by means of its trunk, and not directly by the mouth.

Whether this be the case or not, Aristotle was certainly an exception, as the following passage from the twenty-seventh chapter of the sixth book of his "Historia Animalium" (Ed. Bekker, Oxford, 1837) clearly proves—*Ὁ δὲ σέλιμος, ἔταν γέννηται, θηλάζει τῷ στόματι, οὐ τῷ μυκτῆρι, καὶ θάβει καὶ βλέπει εὐθὺς γεννηθὲς.*—"And the calf, when it is born, sucks with its mouth and not with its trunk; and it both walks and sees as soon as it is born."

J. C. G.

May 3

**The Tay Bridge Inquiry**

IN the *Pall Mall* of April 21 appeared a report of the evidence of Mr. Henry Law, C.E., in the Tay Bridge inquiry. In this report Mr. Law is made to say: "The heavy girders would fall more rapidly than the carriages; a train moving forward at a great speed would not fall so rapidly as a quiescent structure."

I have been induced to ask your insertion of this note in NATURE in the hope that some of your readers who are at home in such matters may confirm or contradict these statements. A person with a mere elementary knowledge of dynamics would disbelieve the latter of them, and would doubt that the former has any practical truth.

Q. C.

Queenwood College, near Stockbridge, Hants

**Yeast and Black Beetles**

IN what form should yeast be applied for the destruction of black beetles? If Prof. Laukester will show us how to exterminate them he will earn the gratitude of every

LONDON HOUSEHOLDER

27, Marlborough Hill, N.W., May 1

SUEZ CANAL ROCK SALT.—Dr. Ralton wishes to know where information can be obtained on the subject of the rock salt beds which were cut through in constructing the Suez Canal.

SODIC CHLORIDE CRYSTALS.—Dr. Ralton asks, what is the action of urea in modifying the crystal form of sodic chloride crystals, referred to by our reviewer of Dr. Ord's book?

[Sodium chloride usually crystallises in cubes; it is stated, however, by Prof. Maskelyne in a lecture before the Royal

Institution that in presence of uric acid it crystallises in *octahedra*. There are other similar facts: thus alum usually crystallises in *octahedra*; but if sulphate of alumina is present in excess the alum crystallises in *cubes*.]

THE SONGS OF BIRDS.—In Pennant's "British Zoology," vol. ii., Mr. C. C. Starling will find in an appendix a very interesting paper by the Hon. Daines Barrington on the singing of birds. The paper is dated 1773, and published in the *Philosophical Transactions*, vol. lxxiii.—JAMES MACFADZEAN.

#### DECAISNE AND BAILLON<sup>1</sup>

IT is perhaps now time to make a protest against a scandal which has in no small degree excited the disgust of scientific men in various parts of Europe, who, like ourselves, have been favoured with copies of the privately-circulated publication of which the name stands at the foot of this note. That scientific men should quarrel, and quarrel sometimes with singular bitterness, is only to affirm in other terms that they are not exempt from the ordinary frailties of human nature. That they should make blunders in their work, however conscientiously performed, is but another illustration of the same truth. But that a scientific man with any respect for his calling should not merely think it worth while to publish the errors of one who has long laboured, and on the whole laboured not ingloriously, under the same roof as himself, and in the same pursuits, and should persist in the unhandsome enterprise of seeking out and raking together faults, even the most microscopic and frivolous, with all the relish and vindictiveness of gratified spite, is a thing so wholly disgusting that a protest should be made against it in the interest of common decency. Decaisne has spent a laborious life in botanical work of great usefulness and excellence, and his scientific reputation has long been established and acknowledged by his contemporaries, who have been quite capable of estimating the value of what he has done. Baillon, a much younger man, is scarcely less regarded for the industrious profusion and frequent originality of his botanical publications. But he will not materially affect the position of Decaisne by his animadversions, and it is pitiful that any portion of his abounding energy should be devoted to the attempt to discredit writings which, after all, will always be consulted by students on their own merits, and having regard to the state of knowledge at the time they were published. The fact is that no scientific man could undergo with credit such a scathing revision as that to which Baillon has subjected his unfortunate fellow-savant, and we do not say without some reason that the last person who would emerge from the process with anything like satisfaction would be Prof. Baillon himself.

#### DR. RUDOLF SCHEFFER

IT is with sincere regret that we have to record the sudden death of Dr. Rudolf H. C. C. Scheffer, the director of the Botanical Gardens, Buitenzorg, Java, which took place at Sindanglaya on March 9. The loss of Dr. Scheffer will be felt by a large circle of botanists throughout the world, for the splendid gardens of which he was superintendent were in communication with every home and colonial botanical institution; but in the Netherlands Indian Colonies, however, it is that his death will be most felt and deplored.

It is now some twelve years since Dr. Scheffer came out from Holland to take the first directorship of the gardens, which had come into high repute by the great number and variety of species collected into it by numerous eminent botanists and by the energy and zeal of its well-known hortulanus, J. E. Teysmann, who has by his numerous voyages added so many new species to the

East Indian flora, and on the fiftieth anniversary of whose uninterrupted connection with the gardens Dr. Scheffer took so warm and active a part last January. Soon after his arrival Dr. Scheffer instituted a school for the training of native boys in the science of agriculture; and for their practical instruction he was the means of having an agricultural garden opened at Zjikoemah, close to the school, and some two miles from Buitenzorg. In this school Dr. Scheffer took the very highest interest and pleasure. It was not intended, on its institution, that he should take any active teaching duties, his superintendence was considered to be all that he could well bestow on it; but finding that the teaching staff was insufficient, he squeezed out of his already overburdened time several hours every day to devote to the tuition of these native boys. When on February 9, on his departure on a botanical journey to the south coast of Java, the writer, little thinking he was saying farewell for the last time, took leave of Dr. Scheffer, seemingly in his ordinary health, he received from him, to aid him in his work, a native boy who had lately taken his diploma of proficiency in the agricultural school. This boy was found to be well acquainted with the general flora of the district and with the classification of plants; he could accurately describe their organs and functions and state their economic uses; he had a good idea of the methods of fertilisation and the values of self- and cross-breeding. He was fairly grounded in the rudiments of zoology, anatomy, and physiology. Until he had tested this youth the writer did not believe it possible for the Malay mind to so clearly comprehend and so accurately to arrange scientific facts. In this the great power of Dr. Scheffer as a teacher appears, especially when it is remembered that he lectured almost to virgin minds and in a language so devoid of all precise and accurate terms as Malay. I am told by a friend, a competent botanist, who has listened to his lectures, that Dr. Scheffer's power of lucid explanation was very great. "I wish," he said, "I had had as good a course of lectures on botany in Holland."

In addition to the labour and anxiety attaching to this section of his work, Dr. Scheffer had also to give occasional lectures to the *aspirant controllours*, the young unplaced civil servants, and to superintend their examinations in agriculture. Over and above this he had the general superintendence of the large botanical gardens on his shoulders, with daily arrivals and despatches of plants to and from all quarters of the globe, on which he had to be consulted daily. If one had entered his small study in the fine building containing the herbarium, one would have found him engaged in his own peculiar work, in which he took so much delight, with his microscope and camera lucida studying the *Hemelia vastatrix*, a subject to which he had been lately devoting much time; in another corner would be a series of Palms—part of Dr. Beccari's collection, on whose examination and description he was engaged, the sectional coloured drawings being done by one of his own native pupils. If we did not find him here we should see the microscope and pencil conveniently left so as to resume work at the shortest possible notice; and adjourning to his house, near the entrance to the gardens, we should certainly find him in his neat library surrounded by a diverse collection of botanical works, and with the spare corners decorated with the busts and photographs of distinguished botanists, with an enormous pile of correspondence, to which he was writing heads of reply in Dutch, French, English, German, for his amanuensis. Dr. Scheffer told the writer that he wrote more than 3,000 letters a year with his own hand. He corresponded with every country and every botanical garden in the world; he had to give all sorts of advice to agriculturists throughout the Archipelago, on the cultivation of or the diseases affecting coffee, tea, sugar, tobacco, &c., and the many great improvements effected in the production of these valuable products is

<sup>1</sup> "Errorum Decaisneanorum graviorum vel minus cognitorum centuria quinta, Auctore H. Baillon."

due in a great measure to his advice. Need we wonder, then, even with youth in his favour, that at the early age of about thirty-seven, being yoked in such heavy double harness, he has died with it on, leaving a large amount of accomplished valuable work, which was waiting for a spare moment to prepare for the publisher.

For some time Dr. Scheffer had been suffering from defective digestive powers and frequent sleeplessness, but he neglected these warnings and the advice of his friends to take some rest. He was unfortunate in being surrounded by those who, with few exceptions, took little interest in his work, and by none to whom he thought he could entrust the work in which he was so hard and enthusiastic a worker, so he worked on. The fatal affection was inflammation of the liver. The seizure was very acute, and at an early stage danger was imminent; but at length he rallied. His medical attendants considered the crisis past, and recommended his removal to his own estate near Sindanglaya, to reach which a tedious climb of 4,500 feet over the Megameudoeng Pass had to be surmounted. He never reached his destination, expiring, on March 9, at the Sanatorium at Sindanglaya, where he now lies buried.

In his private life he was a man to be loved and esteemed; quiet, unassuming, very kind-hearted, ever ready to give whatever assistance he could, especially to scientific travellers. With him the Netherlands Indian Government has lost a valued public servant, to whom it will not be easy to find a successor, and botanical science has to deplore an earnest worker, a learned disciple, and a great helper.

HENRY O. FORBES

Preanger, Java

#### A SCOTTISH CRANNOG<sup>1</sup>

**B**ETWEEN geology and history there lies an intermediate sphere in which these sciences dovetail into one another. In this common territory or borderland lies the domain of prehistoric archæology, and to its most recent portion, or that which archæologists have designated the "Late Celtic Period," must be assigned the antiquarian remains I have here the pleasure of describing. During this period it appears that the Celtic races of Scotland and Ireland were in the habit of constructing artificial islands in marshes and shallow lakes to which, in troublous times, they resorted for safety. They were generally formed by the superposition of trunks of trees and brushwood mingled with stones strongly palisaded by stakes, and so situated as to be inaccessible except by means of causeways, or occasionally by a narrow gangway or mole. These island forts, or *crannogs*, as they have been called in the Irish annals, were very numerous in former times, but owing to the gradual rising of the level of the lakes, they appear to have been so completely lost sight of that their very existence was unknown to modern antiquaries, so that their discovery in the present century marks an important epoch in the history of archæology.

In October, 1878, I drew the attention of antiquaries, through the columns of NATURE, to the remains of an ancient lake-dwelling just then discovered on the farm of Lochlee, in the parish of Torbolton, Ayrshire. Since then a series of excavations have been made with the view of ascertaining the exact nature of this structure, in the course of which a large collection of most interesting relics has been made.

In the year 1839, while a small lake on this farm was being artificially dried up for agricultural purposes, the attention of the labourers was directed to a singular mound, in which, on cutting drains through it, they exposed some wrought wood-work; but their observations,

<sup>1</sup> A full report of the Lochlee Crannog is given in vol. xiii. of the *Proceedings* of the Society of Antiquaries of Scotland, and in vol. ii. of the *Collections* of the Ayrshire and Wigtownshire Archæological Association.

though freely talked of in the neighbourhood at the time, led to no further results till forty years later, when it was found necessary to re-drain the locality, and hence the present investigations. By a curious coincidence the early drainage at Lochlee was made in the same year that Sir W. R. Wilde discovered and examined the first Irish crannog, viz., that of Lagore in County Meath. The Irish discovery, however, owing to a general system of drainage that was then going on, led at once to the most brilliant results, so that it soon became apparent that crannogs existed very generally over the country. Up to the present time over a hundred have been examined, and have furnished the Irish museums with a vast collection of relics. In the year 1854 a great impetus was given to the study of these researches by the discovery of the remains of ancient lake villages in Switzerland, which have now become so famous and well known all over the continent of Europe; but it was not till 1857 that the subject began to attract the attention of Scottish archæologists. In this year Mr. Joseph Robertson read a paper to the Society of Antiquaries of Scotland, and in 1866 Dr. Stuart, who was then Secretary to this Society, collected and published all the scattered notices of Scottish crannogs known up to that date. Since the publication of Dr. Stuart's elaborate paper no further investigations on Scottish crannogs, with the exception of an occasional notice of a fresh discovery of the site of one, have been recorded.

But though traces of these crannogs have been found in almost every county of Scotland, there has been no systematic examination of them worthy of comparison with the investigations that have been made in other countries; nor, with the exception of a few articles found at Dowalton, is there any collection of relics which would enable archæologists to form an opinion with much certainty as to the purpose they served in the social economy of the period they represent; nor can their range in the dim vista of prehistoric times be determined with greater accuracy.

Before the Lochlee Lake was originally drained no one appears to have surmised that a small island (visible only in the summer time) which formed a safe habitation for gulls and other sea-birds during the breeding season, was formerly the residence of man. It was situated near the outlet of the lake-basin, and the nearest land, its southern bank, was about seventy-five yards distant. The general appearance which it presented when the present investigations were commenced was that of a grassy knoll, drier, firmer, and slightly more elevated than the surrounding field. Towards the circumference of this mound the tops of a few piles were observed barely projecting above the grass. Guided by these workmen dug a deep circular trench, in which they exposed numerous piles and transverse beams having square-cut holes in their ends, through which the former projected about eighteen inches or two feet. In the course of further explorations it became apparent that these piles formed a series of stockades surrounding a somewhat circular space about fifty feet in diameter. Beyond this circle on the south side there were indications of other rows of uprights which appeared to unite into one on the north side. Here, instead of further rows of piles, the corresponding space was occupied by an intricate arrangement of woodwork, consisting of young trees and stout branches, mixed with slanting stakes and logs running in all directions, the whole forming a dense protective barrier. The diameter of the island was about 120 feet. The central area was about three feet lower than the surrounding stockades with their transverses, and had a flooring of prepared logs resembling railway sleepers. Near the centre of this log pavement were found four circular hearths placed one above the other with an interval between each of 18 inches to 2½ feet. These hearths were neatly constructed of flat stones of various

sizes, and had a raised rim round them, also formed of flat stones, but uniformly selected and set on edge. Each of them was imbedded in a thin layer of clay, which extended several feet beyond, and the intermediate strata consisted of ashes, charcoal, and small bits of burnt bones. The top of the upper hearth was 7 feet 9 inches above the log pavement, but only about one foot below the surface of the mound, so that the greatest depth of the accumulated rubbish since the log pavement was laid would be about  $8\frac{1}{2}$  feet. The lowest or first fireplace was separated from the log pavement by a thick layer of turf and then a layer of clay.

On a level with the third hearth, counting from below, there were decayed portions of several massive stakes, with square-cut ends which appeared to have been the remains of a hut. One stake was found to have a small portion projecting from the centre of its base, which neatly mortised into a hole formed by a piece of wood, a flat stone, and some clay, and another had pressed down the portion of clay on which it rested nearly a foot. It was thus evident that the stakes were so formed as to prevent them as much as possible from sinking by pressure. Immediately below this level, all over the area of the log-pavement, but more particularly within a circle a few feet from the fireplace, most of the relics were found. Close to this hearth, but about two feet lower, we extracted the skeleton of an animal like that of a goat or sheep, the skull of which was entire, and had short horn-cores attached to it. The relic bed was made up of partially decomposed vegetable matters, and could be separated into thin layers; the common bracken, moss, parts of the stems of coarse grass, heather, and large quantities of the broken shells of hazel-nuts were frequently met with. One of the latter was found to have a hole gnawed in it, as if made by a squirrel.

The space immediately beyond and on the south side of the log pavement, extending between it and the outer circles of piles, was occupied by a refuse heap or midden, consisting of gritty ash, decayed bones, and vegetable matters. Its breadth was ten or twelve feet, and its length from east to west nearly double that. Its surface was three feet below that of the field, so that its average depth would be about four feet. Some important relics were found here, such as metal instruments and daggers, two fibulæ, several wooden vessels, and a few bone implements. It is noteworthy that the metal objects were all comparatively near the surface of the midden, and also that no boars' tusks were found in it except at its very lowest stratum.

The probable existence of some kind of communication between the crannog and the shore of the lake was suggested at an early stage of the investigations by the discovery of a few oak piles in a drain outside the mound on its south side. Upon making excavations in the line thus indicated a very singular wooden structure was discovered, which I found no less difficult to comprehend than it now is to describe. The tops of upright stakes were first revealed, which seemed to conform to no regular arrangement, but by and by, in addition to single piles, groups of three, four, and five, here and there, were detected. The first horizontal beam was reached 7 feet below the surface of the field, which proved to be one of a complete network of similar beams lying in various directions. At a depth of 10 feet the workmen could find no more horizontal beams, and the lake silt became harder and more friable. The reason of grouping the piles now became apparent. The groups were placed in a somewhat zigzag fashion near the sides of the gangway, and from each there radiated a series of horizontal beams, the ends of which crossed each other and were kept in position by the uprights. One group was carefully inspected. The first or lowest beam was right across; the next lay lengthways, and of course at right angles to the former; then three or four spread out diagonally, like a

fan, and terminated in other groups at the opposite side of the gangway; and, lastly, one again lay lengthways. Thus each beam raised the level of the general structure the exact height of its thickness, though large lozenge-shaped spaces remained in the middle quite clear of any beams. The general breadth of the portion of this unique structure examined was about 10 feet, and its thickness varied from 3 to 4 feet. A large oak plank, 10 feet long, showing the marks of a sharp cutting instrument by which it was formed, was found lying on edge at its west side and beyond the line of piles, but otherwise no remains of a platform were seen. All the beams and stakes were made of oak, and so thoroughly bound together that, though not a single joint, mortise, or pin was discovered, the whole fabric was as firm as a rock. No relics were found in any of the excavations along the line of this gangway.

The thickness, composition, and mode of structure of the island itself was ascertained by sinking a shaft at the south end of the log pavement (*i.e.*, near the centre of the island). This shaft was rectangular in form, and large enough to allow three men to work in it together. After removing the three or four layers of oak planks which constituted the log pavement, we came upon a thin layer of brushwood, and then large trunks of trees laid in regular beds or layers, each layer having its logs lying parallel to each other, but transversely and sometimes obliquely to those of the layer immediately above or below it. At the west end of the trench, after removing the first and second layers of the log pavement, we found part of a small canoe hollowed out of an oak trunk. This portion was 5 feet long, 12 inches deep, and 14 inches broad at the stern, but widened towards the broken end, where its breadth was 19 inches. This was evidently part of an old worn-out canoe, thus economised and used instead of a prepared log. Much progress in this kind of excavation was by no means an easy task, as it was necessary to keep two men constantly pumping the water which copiously flowed from all directions into the trench and even then there always remained some at the bottom. As we advanced downwards we encountered layer upon layer of the trunks of trees with the branches closely chopped off, and so soft that the spade easily cut through them. Birch was the prevailing kind of wood, but occasionally beams of oak were found, with holes at their extremities, through which pins of oak penetrated into other holes in the logs beneath. One such pin, some 3 or 4 inches in diameter, was found to pass through no less than four beams in successive layers, and to terminate ultimately in a round trunk over 13 inches in diameter. One of the oak beams was extracted entire, and measured 8 feet 3 inches in length and 10 inches in breadth, and the holes in it were 5 feet apart. Others were found to have small round projections, which evidently fitted into mortised holes in adjacent beams. Down to a depth of about 4 feet the logs were rudely split, but below this they appeared to be round rough trunks, with the bark still adhering to them. Their average diameter would be from 6 inches to 1 foot, and amongst them were some curiously gnarled stems occasionally displaying large knotty protuberances. Of course the wood in the act of digging the trench was cut up into fragments, and, on being uncovered, its tissues had a natural and even fresh-like appearance, but in a few minutes after exposure to the air they became as black as ink. Amongst the *débris* thrown up from a depth of 6 feet below the log pavement I picked up the larger portion of a broken hammer-stone or polisher, which, from the worn appearance presented by its fractured edges, must have been used subsequently to its breakage. After a long and hard day's work we reached a depth of 7 feet 4 inches, but yet there were no indications of approaching the bottom of this subaqueous fabric. However, towards the close of the second day's labour, when the probability

of total discomfiture in reaching the bottom was freely talked of, our most energetic foreman announced, after cutting through a large flat trunk 14 inches thick, that underneath this he could find no trace of further woodwork. The substance removed from below the lowest logs consisted of a few twigs of hazel brushwood, imbedded in a dark, firm, but friable, and somewhat peaty soil, which we concluded to be the silt of the lake deposited before the foundations of the crannog were laid. The depth of this solid mass of woodwork, measuring from the surface of the log pavement, was 9 feet 10 inches, or about 16 feet from the surface of the field. Amongst the very last spadefuls pitched from this depth was found nearly one-half of a well-formed and polished ring made out of shale, the external and internal diameters of which were  $3\frac{1}{2}$  and 2 inches respectively.

In all the trenches made at the margin and beyond the crannog the stuff dug up was of the same character and composition. First or uppermost there was a bed of fine clay rather more than 2 feet thick, and then a soft, dark substance formed of decomposed vegetable matters. The source of the latter was evident from the occurrence in its upper stratum of large quantities of leaves, stems, branches, and the roots of stunted trees apparently *in situ*. This uniformity in the composition of the silt forming the bed of the lake points to the fact that for centuries the increase was due principally to the decomposition of vegetable matters, while latterly it was caused more by a deposition of fine clay. A change so marked in the sediment can only be accounted for by a corresponding change in the surrounding scenery, and no explanation is more likely than that the primæval forests had given place to the inroads of agriculture, when some of the upturned virgin soil would be washed down, as it still is, by every trickling rill that finds its way into this lake basin.

The remains of human industry found during the excavations of the Lochlee Crannog, calculated to throw light on the civilisation and social economy of its occupiers, are very abundant. They comprise a large variety of objects, such as warlike weapons, industrial implements, and personal ornaments, made of stone, bone, horn, wood, metal, &c. In the following description of them I have adopted the principle of classification suggested by the materials of which they are composed:—

I.—Objects made of Stone

**Hammer Stones.**—A great many water-worn pebbles, of a similar character to those observed in the surrounding glacial drift and river courses, which were used as

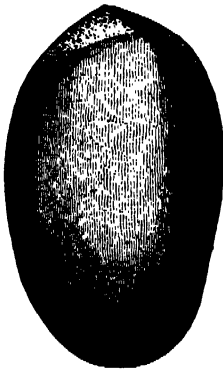

FIG. 1.—Hammer-Stone (Scale  $\frac{1}{2}$ ).

hammers, pounders, or rubbers, were found in the *débris* all over the crannog, but more abundantly in the deeper layers of a small circular area surrounding the hearths. As typical specimens of such implements I have collected no less than nineteen. Of these fourteen are of a somewhat elongated oval shape, and were used at one or both ends (Fig. 1). They vary considerably in size, the major

diameter of the largest measuring 6 inches, and the rest graduating downwards to about the half of this. Two are flat and circular, and show friction markings all round, while other three were used on their flat surfaces only. One of these is divided into two portions, each of which was picked up separately, about a yard asunder, and found to fit exactly. It would thus appear that it was broken while being used on the crannog, and then pitched aside as useless.

**Heating-Stones and Slings-Stones.**—A large number of round stones, varying in size from half an inch to three inches in diameter, some having their surfaces roughened and cracked as if by fire, but others presenting no marks whatever, were met with. The former might have been used as heating-stones for boiling water in wooden vessels—the only ones found on the crannog—the latter as sling-stones or missiles.

**Anvil.**—About a foot below the surface, and a few feet to the north of the upper fireplace, a beautiful quartz pebble was found, which has the appearance of having been used as an anvil. It is of a circular shape, flat

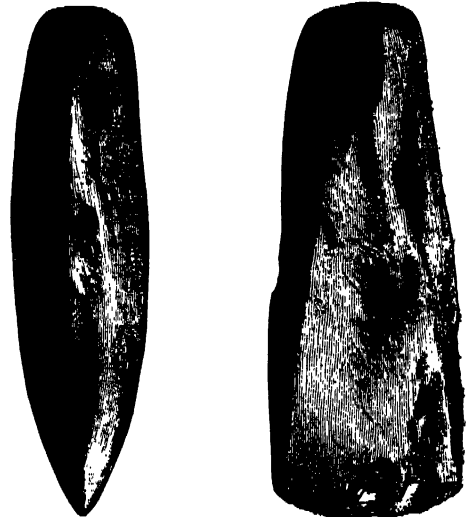

FIG. 2.—Stone Celt (Scale  $\frac{1}{2}$ ).

below, somewhat rounded above, and measures 27 inches in circumference.

**Sharpening-Stones or Whetstones.**—Five whetstones were collected from various parts of the island. They are made of a hard, smooth claystone, one only being made of a fine-grained sandstone, and vary in length from 5 to 7 inches.

**Polished Celt.**—Only one polished stone celt was found. It is a wedge-shaped instrument  $5\frac{1}{2}$  inches long and 2 broad along its cutting edge, which bears the evidence of having been well used, and tapers gently towards the other end, which is round and blunt. It is made of a hard mottled greenstone (Fig. 2.).

**Querns.**—Five upper, and portions of several lower quern stones were disinterred at different periods, all of which, however, with the exception of a pair found over the log pavement, and an upper stone observed towards the west margin of the crannog, were imbedded in the *débris* not far from the site of the fireplaces. Some are made of granite, while others are of schist or hard whinstone.

**Cup-marked Stones.**—Two portions of red sandstone, having cup-shaped cavities about 1 inch deep and 3 inches in diameter, were found amongst the *débris*. One of them was lying underneath, and as if supporting one of the horizontal raised beams at the north side of the

crannog. The other, the position of which was not determined, has two circular grooves or rings round the cup, the outer of which is 9 inches in diameter (Fig. 3).



FIG. 3.—Cup Stone (Scale  $\frac{1}{2}$ ).

*Other Stone Relics.*—Amongst a variety of other stone relics there is one peculiar implement manufactured out of a bit of hard trap-rock. It presents two flat surfaces 3 inches in diameter, with a round periphery, and is  $1\frac{1}{8}$  inch thick.

*Flint implements.*—Only three flint implements were found on the crannog—a large knife flake 3 inches long and  $1\frac{1}{4}$  inch broad; the posterior portion of another flake; and a beautifully-chipped horseshoe-shaped scraper here figured (Fig. 4).

*Spindle whorls.*—Three small circular objects, supposed to be spindle whorls, are here classed together. Two are made of clay, and were found in the relic bed near the fireplaces. The smaller of the two (Fig. 5) is



FIG. 4.—Flint Scraper (Scale  $\frac{1}{2}$ ).

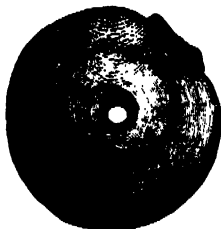

FIG. 5.—Clay Spindle Whorl (Scale  $\frac{1}{2}$ ).

$1\frac{1}{4}$  inch in diameter, and has a small round hole in the centre; the other has a diameter of  $1\frac{1}{2}$  inch, and is only partially perforated, just sufficiently to indicate that the act of perforation had been commenced, but not completed. The third object is a smooth, flat, circular bit of stone,  $1\frac{1}{2}$  inch in diameter and  $\frac{1}{2}$  inch thick, and is perforated in the centre like a large bead.

(To be continued.)

### NOTES

THE Royal Society of Edinburgh has awarded the Keith Medal for the biennial period 1877-79 to Prof. Fleming Jenkin for his paper on the application of graphic methods to the determination of the efficiency of machinery.

PROF. HENRY J. S. SMITH, F.R.S., Savilian Professor of Geometry in the University of Oxford, has been made a Corresponding Member of the Academy of Science of Berlin.

ON the 16th inst. the International Congress of Meteorology will meet at Vienna.

THE honorary degree of LL.D. has been conferred by the University of Glasgow on Mr. Edward John Routh, M.A., F.R.S., and Dr. Michael Foster, F.R.S.

PROF. W. H. FLOWER, LL.D., F.R.S., will give a discourse at the Royal Institution, on Fashion in Deformity, at the evening meeting on Friday, May 7.

PROF. HUXLEY will deliver the inaugural address at the opening of the Science College at Birmingham on October 1.

SIR WILLIAM THOMSON will preside at the meeting of the Physical Society on Saturday afternoon, and will make some brief communications to the Society.

PROF. HENRY TANNER, F.C.S., Senior Member of the Royal Agricultural College, and Examiner in the Principles of Agriculture under the Government Department of Science, has been appointed Professor of the Principles of Agriculture in the Royal Agricultural College, Cirencester.

THE fifty-first anniversary meeting of the Zoological Society was held last week. The report of the council was read by Mr. Sclater, F.R.S., the secretary. It stated that the number of Fellows on December 31, 1879, was 3,364 against 3,415 at the same date of the previous year, 145 new Fellows having been elected, and 189 removed by death or other causes during the year. In consequence of the bad weather, which had seriously affected the garden receipts, and of the general depression in business which had prevailed in 1879, the income of the society showed a falling off as compared with that of 1878, but not to any serious amount; the total receipts having been 26,463*l.* in place of 27,944 in 1878. The total assets of the society on December 31 last were estimated at 28,051*l.*, and the liabilities at 9,960*l.* The number of visitors to the gardens in 1879 had been 643,000, against 706,713 in 1878.

THE general meeting of the German Geometrical Society will be held at Cassel on July 4-7 next.

IN the last week of April an extraordinary fact was observed at Montsouris. We have stated already that the electrical observations are taken eight times daily with a Thomson electrometer and recorded; out of the eight readings registered on April 28 not less than six were negative, and on the following day seven were of the same sign. The occurrence is so extraordinary that it has been referred to in the papers as a fair characteristic of the season.

A LARGE and influential committee of shipbuilders and marine engineers has been formed in Glasgow for the purpose of promoting an exhibition of naval and marine engineering models in Glasgow. It is proposed that the exhibition shall be opened in the Corporation Galleries in November and remain open for six months. Mr. James Paton, the Superintendent of the Glasgow Museum and Galleries, has been appointed Secretary to the Committee.

AT the next meeting of the Society of Telegraph Engineers Dr. Siemens is going to bring forward his latest development of his dynamo machine, and of the influence of the electric light on vegetation.

THE Whit-Monday excursion of the Geologists' Association will be to Oxford, under the direction of Prof. Prestwich and Mr. James Parker. It will last over two days. The long excursion of the Association will be to Bristol on August 2 and following days.

FROM the Report of the New York Central Park Menagerie we learn that that establishment has now 423 mammals, representing 56 genera and 98 species; 753 birds, of 102 genera, 134 species; 30 reptiles, of 8 genera and 10 species; or 1,206 animals in all. The additions in 1879 numbered 668.

HEYWOOD of Manchester has issued, for the small price of sixpence, the eleventh series of the Manchester Science Lectures for the People, containing lectures on "Islands," by Mr. A. R. Wallace; "The Age of Dragons," by Mr. B. W. Hawkins; "Palestine in its Physical Aspects," by Canon Tristram; and

"Traps to Catch Sunbeams," by Capt. Abney. We are sorry to learn from Prof. Roscoe's preface that the interest in these lectures having died out, they are to be discontinued. Nevertheless, as he says, they have undoubtedly done great good both when delivered and in the remarkably cheap form in which they have been published. The series, as a whole, has been a genuine success.

WE understand that Dr. James Geikie, F.R.S., will shortly send to press a work entitled "Prehistoric Europe—a Geological Sketch," which treats of the principal climatic and geographical changes which have taken place in our continent since the commencement of the Pleistocene or Quaternary period. Mr. Stanford will be the publisher.

THE Council of the Society of Arts have decided to summon a public Conference to consider the question of supplying London with pure water. The date for the Conference has been fixed for Monday, May 24, and succeeding days. The arrangements for the Conference are now being considered by a committee, and full announcements will be made as early as possible.

SINCE November last, instruction by means of lectures and laboratory practice, in connection with the City and Guilds of London Institute for the Advancement of Technical Education, has been given during the evening in Chemistry and Physics as applied to the Arts and Manufactures, by Prof. Armstrong, Ph.D., F.R.S., and Prof. Ayrton, A.M. Inst. C.E., in rooms at the Cowper Street Schools, Finsbury. On and after May 10, day classes will also be established, adapted to the scientific requirements of persons partially engaged, or intending to engage, in the manufacturing industries. The object of these day classes is to afford such preliminary training as is necessary for those who may desire, later on, to study particular branches of Applied Chemistry or Physics, for which special accommodation will be provided in the new buildings. Two courses, each of twenty-four lectures, in Chemistry and Physics will be given on two afternoons per week during May, June, and July, for imparting such knowledge of the general principles as is necessary for the after-understanding of the various branches of Applied Chemistry and Physics:—Chemistry, Wednesdays and Fridays, at 3 to 4 o'clock; Physics, Wednesdays and Fridays, at 4 to 5 o'clock. Prof. Ayrton will also give a special laboratory and tutorial course in Electrical Engineering; and Prof. Armstrong will give a similar course for instruction in Photographic Chemistry. Students desirous of attending either of these courses are requested to communicate with the respective Professors at the present temporary laboratories, Cowper Street, Finsbury, E.C., before May 10, stating the times at which they could attend, and the maximum number of hours they could devote to the subject.

WE learn from Catania, under date April 26, that the inhabitants were apprehending an eruption of Etna. An immense cloud of smoke has been observed.

A PARISIAN speculator has inaugurated the aeronautical season by a private ascent on April 25 at La Villette gasworks. The balloon, of only 300 cubic meters capacity, bore one aeronaut, with 30 kilograms of handbills, which were distributed all over Paris. The wind being slight, with a favourable direction, thousands of these prospectuses were picked up by street passengers and largely read. The whole expense of the aerial expedition, gas and everything, did not exceed 10*l.* sterling.

THE phylloxera has made its appearance in the vineyards on Vesuvius and the opposite part of the Gulf at Puzzuoli and Pianura. Much alarm prevails. Precautionary measures are being taken. In Sicily the phylloxera, till now confined to Caltanissetta, is likewise reported near Messina.

AT the Annual Meeting of the Royal Institution on May 1, the Annual Report of the Committee of Visitors for the year 1879, testifying to the continued prosperity and efficient management of the Institution, was read and adopted. The real and funded property now amounts to nearly 85,000*l.*, entirely derived from the contributions and donations of the Members. Forty-nine new Members paid their admission fees in 1879.

THE *Japan Gazette* states that the line of railway which has been in contemplation for some time past between Tokio and Mayebashi will soon be commenced. The surveys are completed, and it is said that the line will traverse a rich district, and is expected to prove a great benefit to the country.

AN exhibition of apparatus and products relating to bee-culture will be held at Schwerin on August 28-30 next.

THE Electrotechnical Society at Berlin, which was founded on December 20, 1879, begins the second quarter of its existence with no less than 1,248 members.

THE Emperor of Austria has presented the large gold medal "for arts and sciences" to Dr. Karl Ritter von Scherzer in recognition of his latest work, "Die britischen Welt-Industrien."

THE *Report* of the Rugby School Natural History Society for 1879 is fairly encouraging. Several creditable papers are given by the members; we should like to see more papers of this class and fewer lectures by grown-up outsiders, some of which seem to us quite inappropriate in a *Report* of this kind.

"THE International Dictionary for Naturalists and Sportsmen in English, French, and German," by Mr. Simpson-Baillie (Trübner and Co.), is a very useful book of reference, and contains a good many scientific terms, especially connected with natural history.

"THE Sportsman's Guide" to the rivers, lochs, moors, and deer forests of Scotland comes once more to remind us of the hills and the heather, and to recall the memory of pleasant days spent on loch and river. It bears evidence of careful revision, and we are sure will prove useful to the tourist of scientific tastes, even if he be no disciple of the rod or gun.

IT is known that M. Jamin, member of the French Institute, has patented an electric lamp in which the light is directed by an electrical current. A public company has been formed with a capital of 8,000,000 francs for the working of the patent.

THE French Minister of Fine Arts has entered into an agreement with the Jablochhoff Electric Light Company to light the palace during the whole of the two months devoted to the exhibition. The number of lights fed by the machinery is about 400, and the motive power regarded at about 320 horses. The inauguration was to take place on May 1, and a large crowd had congregated to witness the process. But the crank of one of the principal engines broke, and it was necessary to postpone the opening for a few days. In spite of the growing opposition of the friends of the gas company, M. Garnier, the architect of the Paris Opera, will establish a trial of the principal electrical burners, to decide which is the more really fit for use in the house.

THE additions to the Zoological Society's Gardens during the past week include a Common Ocelot (*Felis pardalis*) from South America, presented by Mr. Stephenson Clarke; two Elliot's Guinea Fowls (*Numida ellioti*) from East Africa, presented by the Rev. Thos. Wakefield; two American Barn Owls (*Strix flammea*) from Jamaica, presented by Mr. G. E. Dobson, C.M.Z.S.; a Koala (*Phascolarctus cinereus*) from South-East Australia, a Grey Squirrel (*Sciurus cinereus*) from North America, two Blue-streaked Lorises (*Eos reticulata*) from Timor



Laut, two Prince Albert's Curassows (*Crax alberti*) from Columbia, purchased; two Common Foxes (*Canis vulpes*), four Chilian Pintails (*Dasyla spinicauda*), bred in the Gardens.

### OUR ASTRONOMICAL COLUMN

THE COMET OF 1106.—Amongst the comets which were thought to present certain indications of identity with the great comet of 1843 was that recorded by a large number of European historians, as well as in the Chinese Annals, in the year 1106. The circumstances of its appearance may be thus briefly stated: On the 4th of February, or, according to others, on the 5th, a star was seen which was distant from the sun "only a foot and a half"; it was observed from the third to the ninth hour of the day. Matthew Paris and Matthew of Westminster distinctly term it a comet. Pingré, not having the experience of the comet of 1843 as a precedent, questioned the possibility of seeing one of these bodies at so small a distance from the sun as the above expression may be taken to imply. Now, however, we are able to connect, with much probability, the star viewed in the day-time with the comet which on February 7 was discovered in Palestine about the commencement of the sign Pisces. On this day, we are told by three contemporary writers, a comet appeared in that quarter of the sky where the sun sets in winter, and occasioned great surprise; a white ray extended from it to a great distance. From the time of its first appearance "the comet itself and the ray, which had the whiteness of snow, diminished day by day." Others, on the contrary, say that the train, which had a more than milky whiteness, appeared to increase daily. In the west of Europe it does not seem to have been remarked till February 16 or 18. According to some writers it was visible only a fortnight, others say that it continued to shine for forty days, or during the whole of Lent, from February 7 to March 25; an eye-witness records that after fifty days the most acute vision only sufficed to distinguish it with difficulty. There is similar contradiction respecting the aspect of the comet, though most of the historians testify to its great brightness and apparent magnitude. On February 10, according to Gaubil's manuscript, used by Pingré for his "Cometographie," it was near the end of the sign Pisces, with a tail 60° in length. European chronicles mention that the tail extended to the beginning of the sign Gemini, under the constellation of Orion, whence, as Pingré points out, the latitude of the comet must have been south, while as the sun was in 25° of Aquarius, it could hardly be less advanced than 10° or 12° of Pisces to be seen in the evening after sunset. Thence, about February 16 or 18, it moved to the western quarter of the heavens, and after many days had elapsed, as Pingré records: "La comète parut du côté du septentrion vers l'occident: sa queue, semblable à une grand poutre, regardoit la partie du ciel qui est entre le septentrion et l'orient; on la voyoit jusque vers le milieu de la nuit. Durant vingt-cinq jours elle brilloit de la même manière à la même heure." Williams, in his account of comets mentioned in the Chinese annals, has a notice of the one in question. In the reign of Hwuy Tsung, the 5th year of the epoch Tsung Ning, the 1st moon, day Woo Seuh (1106, February 10), a comet appeared in the west. It was like a great Pei Kow (a kind of vessel or measure). It appeared like a broken-up star. It was 60 cubits in length and 3 cubits in breadth. Its direction was to the north-east: it passed the sidereal division Kwei (determined by  $\beta$ ,  $\delta$ ,  $\epsilon$  Andromedæ and stars in Pisces), and through the divisions Lew (determined by  $\alpha$ ,  $\beta$ ,  $\gamma$  Arietis), Wei (by the three stars of Musca), Maou (by the Pleiades), and Peih (by  $\alpha$ ,  $\gamma$ ,  $\delta$ , &c., Tauri). It then entered the clouds and was no more seen. Williams, doubtless influenced by this last expression, and the object having been said to resemble a broken-up star, and probably overlooking the presence of the comet recorded by the European historians in the same part of the sky, adds: "This appears to have been a large meteor, as it seems to have been seen for a short time only." But there can be little hesitation, we think, in identifying the body remarked in China with the European comet, its track through the constellations, as given by Williams, which agrees with Gaubil's manuscript, representing very satisfactorily the particulars found in the European chronicles.

In 1843 Laugier and Mauvais, reducing their elements of the great comet of that year to 1106, and assuming the perihelion passage to have taken place on February 3, found the following geocentric track.

Feb. 4, Long. 324, Lat. - 3	Feb. 16, Long. 4, Lat. - 23
7, " 335, " - 10	March 5, " 40, " - 28
10, " 345, " - 16	25, " 60, " - 27

And they conclude, "en admettant que la comète de 1106 est une apparition de la comète de 1843, toutes les observations sont satisfaites." It is not easy to see how such an inference can have been drawn in face of the circumstances mentioned by the historians during the later period of the comet's visibility, when it was seen to the north of west, with a tail extending towards the north-east; a condition wholly incompatible with the elements of the comet of 1843, which body did not remain on the northern side of the ecliptic so long as three hours. On reducing Hubbard's parabola of 1843 to 1106 we have the following positions, assuming perihelion passage February 3.5 G.M.T.:-

G.M.T.	h	Long.	Lat.	Log. $r$ .	Log. $\Delta$ .	Intensity of Light.
Feb. 4,	0 ...	322°9 ...	- 1°7 ...	8°8080 ...	9°9704 ...	277°6
	19, 8 ...	12°6 ...	- 25°1 ...	9°8377 ...	9°9543 ...	2°6
March 25,	12 ...	60°3 ...	- 27°3 ...	0°1725 ...	0°2019 ...	0°13

These places are in agreement with those found by Laugier and Mauvais; that for March 25 corresponds to R.A. 63°7, Decl. - 6°4.

It is well known that the comet of 1106, with better reason, was long supposed to be identical with the famous comet of 1680. That point has been discussed elsewhere. Our object now, since the possibility of the identity of the comet of 1106 with that of 1880 and 1843 has been again mooted, is to draw attention to the main difficulty that exists in the acceptance of the idea.

### PHYSICAL NOTES

M. ANTOINE BRÉGUET, at a lecture upon Recent Advances in Telegraphy, exhibited some ingenious apparatus illustrating the principles of the duplex and quadruplex telegraph, the actions of the electric currents being most successfully represented by the flow of water in tubes.

PROF. CARMICHAEL describes, in the *American Journal of Science*, a device for rendering the sonorous vibrations of a flame visible to a whole audience. He passes coal-gas through a König's manometric capsule, and then leads it by a tube into a burner enclosed in a small mica cylinder or lantern, which is rotated either in a vertical or a horizontal plane. The ring of light thus produced is broken up by the sonorous vibrations into a serrated form, the forms of the serrations varying with the nature of the sound. To increase the brilliancy of the light the gas is previously passed over a sponge soaked in some volatile hydrocarbon such as "gasoline" or "benzoline," and oxygen is also supplied into the mica lantern. A shrill whistle produces very fine serrations invisible thirty feet away. The human voice at ordinary loudness produces serrations two or three inches deep round the ring. A modified capsule placed upon the various parts of a vibrating body serves to investigate their modes of vibration, nodal points, &c.

SOME curious experiments on the magnetic behaviour of elder-pith have lately been made by M. Ader. Pith-balls placed in a powerful magnetic field are strongly attracted.

PROF. ROWLAND contributes a long and careful memoir upon thermometry and the mechanical equivalent of heat to the *Transactions of the American Academy of Arts and Sciences*. His results differ by about 25 per cent. from the accepted numerical determinations of Joule's equivalent. Amongst other matters noticed in this memoir is an alleged decrease in the specific heat of water at higher temperatures.

A CONTEMPORARY gives the following method of illustrating the indestructibility of matter:—Two sealed glass tubes of equal weight, one of them containing oxygen and a little powdered charcoal, are prepared. The charcoal may be caused to burn away completely by heating it by means of a small flame. On placing the two tubes on a balance it will be seen that there has been no variation in weight.

THE process of electrodeposition is now finding a useful application in the production of bronze statuary, where it promises to supersede the process of casting. The Electrometallurgical Company of Brussels have just produced a colossal statue of Van

Eyck by the deposition of copper electrically upon the clay model. The production of bronzes may be readily carried out on a small scale by the following process communicated to the *Natural History Journal*, and which possesses some elements of novelty. Take any plaster figure or group, boil in sterine, then blacklead and plunge in a copper bath. Attach a very weak battery, and deposit very slowly a thin coating of copper. Now remove from the bath, and bake in an oven until the plaster model shakes out in dust. You have now a very thin copper reproduction of your model. Varnish this outside so as to prevent the further deposition, and replace in the bath. The copper will now be deposited on the inside surface, and you can thicken up to any desired point. For this second process a much stronger battery may be used.

MM. LECLERC and Vincent have described to the Physical Society of Paris an electrical instrument which will automatically record the notes played upon a piano. It can be adapted to a piano of any construction.

CLÖE's thermoelectric pile has been recently improved by an addition which obviates the injurious effect of sudden and excessive heating of the junctions arising from alteration in the pressure of the gas. This safety-apparatus consists of a small glass vessel about half filled with water, and closed by a cork stopper, through which pass two tubes, one going to the bottom and being a branch of the tube by which the gas comes to the pile, while the other is shorter, and conducts any gas that may pass through it from the vessel to a gas-burner on another branch constantly lit. If the pressure of the gas is weak the water closes the mouth of the longer tube; if it increases the gas issues in bubbles in the liquid and rises through the shorter tube to the gas jet, where it is lit. The arrangement is a sort of safety-valve, and prevents the pressure from exceeding a certain amount, which is regulated at will.

M. MARCEL DEPREZ has devised an ingenious apparatus for transmitting a movement of rotation by electricity. The apparatus is composed of a transmitter and a receiver. The transmitter consists of two ordinary split-collar commutators set upon a common axis, but adjusted at right angles to each other. The receiver consists of two longitudinal armatures carrying coils of wire as employed in the earlier Siemens' magneto-electric machines. These also run on a common axis and in positions at right angles to one another; and they are placed in the magnetic field between the poles of a permanent magnet. Currents generated by a battery pass through the transmitter and are conveyed by wires to the receiver. For every position of the axis of the transmitter there is one position—and one only—of stable equilibrium for the axis of the receiver. Hence the axis of the receiver follows all the movements of the transmitter; turns at the same rate and in the same direction as the transmitter may be turned; and makes the same number of revolutions precisely to within a quarter of a revolution.

### GEOGRAPHICAL NOTES

THE new number of the Geographical Society's *Proceedings* is chiefly occupied with a narrative of Lieut. G. T. Temple's voyage on the coasts of Norway and Lapland, illustrated by a map on which the depths of the ocean are well shown in colour, and by Mr. E. Hutchinson's account of Mr. Ahcroft's ascent of the River Binué last August, with remarks on the systems of the Rivers Shary and Binué. With the latter paper is given a reduction of Mr. Flegel's map of the Upper Binué from his own surveys, recently issued by Hellfarth of Gotha. An interesting letter from Mr. Thomson is afterwards given, furnishing information as to the progress of the East African Expedition. Among the geographical notes may be mentioned a summary of the most recent rumours respecting Prejevalsky and a description of routes from Dzungaria into Tibet. There is also an account of a visit paid by Mr. Woolley, of the Consular service, to the Island of Tashima and Corea, and of the Rev. J. Chalmers's recent explorations in the interior of New Guinea, in the course of which he traversed a considerable extent of previously unknown country. The notes are followed by a communication on the "Tal-Chotiali Route from India to Fishin and Candahar," furnished by Mr. G. W. Vyse, who was attached to the Tal-Chotiali Field Force, in correction of previous statements made respecting this route.

By a note received on April 28 we learn that the Howgate Arctic Expedition Bill passed the House of Representatives at

Washington on the 15th inst., and has gone to the Senate for final action. "This is a great step in advance, and augurs well for Government aid to the Expedition."

UNDER the title of "La Exploradora" an association has been formed in Spain, through the instrumentality of Señor Don Manuel Iradier, for the exploration and civilisation of Central Africa, and in furtherance of its objects commenced the publication of a *Boletín* in March. This association proposes to despatch an expedition from the west coast with what appears to be a somewhat ambitious programme. Its starting-point would be the Bay of Corisco, whence it would traverse the Sierra de Cristal, and afterwards march by way of Mount Onschiko and the River Eyo towards Lake Albert. If successful so far, it would then visit Mount Gambaragara, in the Usongora range, to study the peculiar population said to be found there. Then, turning in a north-westerly direction, it would make its way back to the Gulf of Guinea by Lake Liba and the Cameroons River. It is proposed that this expedition should start at latest during the month of June, but we are not aware whether the necessary funds for its journey of fourteen months have been provided. In the course of their march it is intended that the members of this expedition should devote themselves to the study of all the important problems yet unsolved in the central region of the African continent, and especially whether there be any connection between Lake Liba and the rivers Shary and Binué.

It is stated that the Comte de Semellé is about to return to Africa, in order to undertake an exploring expedition up the river Binué.

DR. REGEL, director of the Imperial Botanical Garden of St. Petersburg, gave an account of the Flora of Turkestan at a recent meeting of the St. Petersburg Horticultural Society. Turkestan may be divided into two distinct parts—the west, with a very mild climate, and the east, the climate of which is almost that of St. Petersburg. The flora of Turkestan is exceedingly varied, much resembling that of Central Asia; plants proper to the climate of Europe grow there in small numbers. The eastern part abounds in Alpine specimens, and in general its vegetation approaches that of Europe, although quite as often plants are met with which are the sole product of Central Asia. Turkestan possesses neither lily nor tulip, and has very few conifers.

LAST week we referred to Mr. E. Whympers's mountaineering exploits in South America. Some further details are given by Mr. Whympers himself in a letter to Mr. F. F. Tuckett in *Tuesday's Times*. It is dated from Quito, March 18. He says:—"You will be glad to hear that I have succeeded in polishing off Chimborazo, Corazon, Sincholagna, and Antisana. We have also passed twenty-six consecutive hours on the top of Cotopaxi. This last I reckon a feat, and I am not aware that any one has ever before encamped at so great an altitude as 19,500 feet. Antisana is the most difficult of those we have been up, and few more difficult ascents have ever been made. We are now going off to Cayambe, the mountain on the Equator, and shall try on the same journey to polish off Saranen and Cotocachi. Cayambe is thought to be an active volcano, but it is not certain that this is the case, neither is its height well determined. The height of Saranen is not known, but it is high. Cotocachi is the volcano which destroyed Ibarra some years ago, and is reputed to be 16,300 feet high. We have grown out of being affected by rarefaction of the air, and can be quite gay and lively at 19,000 feet. At first I was fairly knocked over by it, and was rendered quite incapable. The Carrels also were nearly as bad. The climate of Ecuador is the most utterly abominable that can be imagined. We have not had one single day fine from beginning to end, and not one view from a mountain top. An hour of clear weather from 6 to 7 a.m. is the most you can reckon on, and after that everything is bottled up in a mist. We carry about mercurial barometers everywhere, and boil water to an extent that would delight your heart."

IN the May number of their *Chronicle* the London Missionary Society announce the departure, on April 16, of a new expedition for East Central Africa, to reinforce the weakened and scattered party now there. The Rev. A. J. Wookey goes to join Mr. Hore at Ujiji, the Rev. D. Williams to Urambo, where Dr. Southon now is, and Mr. W. S. Palmer, a medical missionary, to Uguha, where, we presume, he will be stationed at Mtowa, near the Lukuga Creek.

IN their just-issued eighty-eighth Report the Committee of the Baptist Missionary Society summarise the efforts of their

Congo Expedition to reach Stanley Pool by way of San Salvador and Makuta. Owing to tribal jealousies, the Makuta route has had to be given up, but fresh efforts are now being made to discover some other route to the Upper Congo by Zombo or Sanda; or should these prove unfavourable, to strike out an altogether new road, and so to reach Stanley Pool over hitherto untrodden ground. By latest advices it seems probable that they may be able to get there by Sanda (about two days' journey from Makuta), where Messrs. Comber and Crudgington have been well received, and have been allowed to establish a station.

A "THÜRINGER WALD" Club, similar to the various Alpine clubs, has recently been formed at Eisenach. An "Erzgebirge" Club is in course of formation at Joachimsthal (Bohemia). A Saxon Club for the closer investigation of the last-named mountain chain has existed for several years; also a "Rhöngebirge" Club. These clubs do great service to tourists and the general public, and would be well worth imitating in our own mountain districts.

MR. STANFORD has issued three nicely-printed maps in which the results of the recent elections are very clearly shown for England, Scotland, and Ireland. The maps have been designed by Miss E. Shaw-Lefevre.

MR. STANFORD has just published a "Geography for Little Children," by Mrs. Zimmern, which in a very simple and interesting way attempts to show the use of a map and teach some of the elementary points of physical geography. Its numerous attractive and quite original illustrations are an important feature. We have also received the forty-fifth edition of Cornwell's "Geography for Beginners."

### SCIENTIFIC SERIALS

THE *Journal of Anatomy and Physiology, Normal and Pathological*, vol. xiv. Part 3, April.—Prof. Turner, the structure of the comb-like branchial appendages, and of the teeth of the basking shark (*Selache maxima*) (with a plate).—Dr. G. Thin, on the ganglion-cells of the elephant's retina.—Dr. J. H. Scott, on the structure of the style in the tongue of the dog.—Dr. A. H. Young, on the anatomy of the Indian elephant.—Dr. C. Creighton, illustrations of the pathology of sarcoma, from cases of subcutaneous cystic tumours (three plates).—Dr. Dreschfeld, on a peculiar form of liver tumour (with a plate).—On a case of cerebellar tumour (with a plate).—Dr. T. Oliver, post-mortem in a case of extreme obesity.—Prof. J. Young, on the head of the lobster (with a plate).—W. S. Richmond, new abnormalities of the arteries of the upper extremity, with a plate.—Dr. R. J. Anderson, abnormal arrangement of the thyroid arteries (with a plate).—On a variety of the mylo-pharyngeus and other unusual muscular abnormalities.—Drs. P. M'Brice and A. Bruce, the pathology of a case of fatal ear-disease (with a plate).—Dr. F. Shepherd, notes on the dissection of a case of congenital dislocation of the head of the femur.—J. D. Brown, abnormal cystic artery.—Anatomical notes.

*Journal of the Royal Microscopical Society*, vol. iii. No. 2, April, 1880.—A. D. Michael, a further contribution to the knowledge of British Oribatida, Part 2, with the assistance of C. F. George (two plates).—Dr. Lionel S. Beale, annual address as president.—J. W. Groves, on a means of obviating the reflection from the inside of the body tubes of microscopes, with suggestions for standard gauges for the same and for sub-stage fittings.—A. Nachet, on a petrographical microscope.—The record of current researches relating to invertebrata, cryptogamia, microscopy, and bibliography.—Proceedings of the Society.

*Revue Internationale des Sciences*, April.—M. Gilkinet, on the development of the vegetable kingdom in geological times.—A. de Bary, on apogamous fungi, and on apogamy in general.—R. Blanchard, on striated muscles in the monomyary acephalous mollusks, and on the peritoneum of Seba's python.

THE *American Naturalist*, vol. xiv., No. 3, March.—G. Macloskie, the proboscis of the house-fly.—E. Coues, sketch of progress in mammalogy in the United States in 1879.—E. D. Cope, a review of the modern doctrine of evolution, being an abstract of a lecture delivered before the Californian Academy of Sciences (with several cuts of crania of Anura).—E. A. Smith, a paper concerning amber.—Notes on recent literature, General Notes, and Scientific News.

No. 4, April.—W. S. Barnard, protoplasmic dynamics (an

attempt to find a clue "to the mode in which molecular movement is transformed into the movement of masses").—C. S. Minot, a sketch of comparative embryology (II, the fertilisation of the ovum).—C. A. White, on the progress of invertebrate palæontology in the United States for the year 1879.—E. D. Cope, a review of the modern doctrine of evolution (concluded).—A. J. Cook, on the tongue of the honey-bee.—Notes on recent literature, General Notes, Proceedings of Scientific Societies.

*Verhandlungen der k. k. zoologisch-botanischen Gesellschaft in Wien*, vol. xxix. Part II, June to December, 1879, Vienna, 1880, contains, besides list of members and minutes of the Proceedings, the following memoirs:—Otto Bohatsch, supplement to the lepidopterous fauna of Syria.—H. Wichmann, the minute anatomy of the seeds of *Aletris triloba*, Forst. (two plates).—Dr. J. Csokor, on the pimple mite, and on a new variety of the same occurring in swine (*Demodex phylloides*), one plate.—H. Leder, contribution to the coleopterous fauna of the Caucasus.—S. Schulzer, mycological notes, iv.—E. Reitter, the synonymy of coleoptera; contributions to a knowledge of the European Pselaphida and Scydmanida; on new coleoptera from South-West Russia; on Spelæodytes, Mill.—Dr. H. Loew, analytical table to determine the North American species of Pachyrhina, a genus of Tipulida.—C. R. Osten-Sacken, the Tanyderina, a remarkable group of the Tipulida.—F. von Thümen, two new leaf-frequenting ascomycetes, from Vienna.—A. von Pelzeln, on a fifth package of birds from Ecuador; on Dr. Breitenstein's collection of beasts and birds from Borneo.—Dr. F. Löw, notes on Psylloida (with a plate); descriptions of new gall-insects, with notes on some species already known.—Dr. R. Bergh, contributions to a monograph of the Polycerida (with six plates).—W. Voss, materials towards a knowledge of the fungi of Carniola.—Dr. G. Mayr, on the ichneumon-wasp of the genus *Telenomus*.

THE *Zeitschrift für wissenschaftliche Zoologie*, xxxiv. Band, Heft 1, March.—Dr. Ernst Nauck, on the masticatory apparatus of the Brachyura, with a plate and woodcuts.—Dr. Hubert Ludwig, on *Asthenosoma varium*, Grube; and on a new organ in the Cidarida, with two plates and woodcut. Describes three specimens from the Museum Godeffroy, one possibly a variety of *A. varium*, or possibly a new species, and describes five sac-like organs which lie, like the radial Y-shaped manubria (Gabelsticke), in the plane of the ambulacra. These he calls the coecal sacs (Blindsacke) of the masticatory apparatus. Each coecal sac consists of a thin membrane, stiff with calcareous spicules; right and left of each of these there lie two other blind appendages, but very much smaller; they were first detected in *Cularis tribuloides*, but were also found in *C. metularia*, *Dorocidaris papillata*, and *Goniocidaris canaliculata*. A slight trace of their existence was found in *Diadema setosum*, but they were quite absent in the families Echinometrida and Arbaciada.—Prof. Dr. P. Langerhans, on the worm fauna of Madeira; part 3, with three plates (to the end of the Nemertean).—The same, on the Madeiran Appendicularia.—Dr. H. von Ihering, on *Graffilla muricicola*, a new parasitic Rhadocœlian, with a plate (found in the kidney of *Murex trunculus* and *M. brandaris*, both at Naples and Trieste).

THE *Revue des Sciences Naturelles*, 2e série, tome 1, No. 4, March 15.—Dr. A. Godron, on the axillary buds and branches in the Gramineæ.—L. Tillier, essay on the geographical distribution of marine fishes (conclusion).—S. Jourdain, on the morphology of the early stage of the generative organs of *Helix aspersa*, with a plate.—M. Leymerie, sketch of the Pyrenees of the department of Aude (in continuation), with a plate.—A. Sabatier, the law of the correlation of forms and intermediate types.—E. Dubruell, catalogue of the land and fluviatile mollusca of the department of Hérault (conclusion).—Review of recent French works on zoology by Messrs. Jourdain, Rouzaud, and Dubruell, and on botany and geology by M. Dubruell.

*Rivista Scientifico-Industriale*, March 15.—Note on electricity and earthquakes, by Prof. De Losis.—Researches on the diathermanous power of films of soapy water, by Prof. Marangone.

*Archives des Sciences Physiques et Naturelles*, March 15.—Swiss geological review for 1879 (continued), by M. Favre.—Enigmatical descriptions of natural groups, by M. de Candolle.—New observations on phillippium, by M. Delafontaine.—On decipium and its principal compounds, by the same.—Earthquakes and their scientific study, by M. Heim.—On the density of chlorine at high temperatures, by M. Crafts.

## SOCIETIES AND ACADEMIES

LONDON

**Royal Society, April 22.**—"Effects of Electric Currents on the Surfaces of Mutual Contact of Aqueous Solutions." By G. Gore, LL.D., F.R.S.

In the year 1859 I made the following experiments, for the purpose of ascertaining whether visible movements, similar to those obtained by passing an electric current through mercury and an aqueous solution, could be obtained by passing a current through the surface of mutual contact of two aqueous liquids alone:—**"1.** A definite layer of oil of vitriol was placed beneath a layer of distilled water weakly acidulated with sulphuric acid, and the terminal wires of a voltaic battery immersed in the upper liquid; no visible movements occurred at the boundary line of the two liquids.

**"2.** A dense solution of cyanide of potassium was placed in a small glass beaker, a few particles of charcoal sifted upon its surface, and a layer of aqueous ammonia, half an inch deep, carefully poured upon it. A vertical diaphragm of thin sheet gutta-percha was then fixed so as completely to divide the upper liquid into two equal parts; the vessel was placed in a strong light, and two horizontal platinum wire electrodes, from sixty-six freshly-charged Smee's cells, were immersed one-eighth of an inch deep in the liquid ammonia on each side of the diaphragm. A copious current of electricity circulated, but no movement of the liquids at their mutual boundary line could be detected" (see *Proc. Roy. Soc.*, vol. x., 1860, p. 235, par. 9).

Recently, also, I have made similar experiments, but in a much more searching manner, in order to ascertain whether an electric current, passing between two aqueous liquids, affects their diffusion into each other. The essential difference in the form of these experiments from that of the above-mentioned ones was to concentrate the action of the current upon a very much smaller surface of contact of the liquids, and thus render any visible effect upon their diffusion more manifest.

After making several forms of apparatus, in order to obviate certain difficulties of manipulation which arose and were fatal to success, I found that, when an electric current was passed between the surfaces of mutual contact of certain aqueous solutions of different specific gravities, the boundary line of contact of the two liquids became indefinite at the surface where the current passed from the lighter into the heavier solution, and became sharply defined where the current left the heavier liquid and re-entered the lighter one; and that on reversing the direction of the current several times in succession after suitable intervals of time, these effects were reversed with each such change. Also, in various cases in which the contiguous boundary layers of the two liquids had become mixed, the line of separation of the two solutions became, by the influence of the electric current, as perfect as that between strata of oil and water lying upon each other. In rarer cases two such distinct lines of stratification appeared. Other new phenomena were also observed.

As I have sought, without success, for any record of previous discovery of essentially similar effects, and as it is evident that those I have observed belong to a large class of similar phenomena, I beg leave to take the earliest opportunity of submitting this brief statement to the Royal Society.

**"Revision of the Atomic Weight and Valence of Aluminium,"** by J. W. Mallet, F.R.S.

The general mean from all the experiments, if all be included, is  $Al = 27.032$ , with a probable error for this mean of  $\pm .0045$ . If Series I, B, be excluded, the mean of all the remaining twenty-five experiments is  $Al = 27.019$ , with a probable error of  $\pm .0030$ .

The general result adds, the author hopes, aluminium to the, unfortunately still limited, list of those elementary substances whose atomic weights have been determined within the limits of precision attainable with our present means of experiment.

This result also adds one to the cases already on record of the numbers representing carefully determined atomic weights approaching closely to integers, and leads the author to say a word on the reconsideration of "Prout's Law." Taking the following eighteen elements as the only ones of which the atomic weights may be fairly considered as determined, with reference to hydrogen, with the greatest attainable precision, or a near approach thereto, namely, oxygen, nitrogen, chlorine, bromine, iodine, sulphur, potassium, sodium, lithium, silver, thallium, aluminium, carbon, phosphorus, barium, calcium, magnesium, and lead, and making a reasonable allowance for the errors of

the determinations, he calculates the probability that nine of those numbers should lie, as they are found to do, within 0.1 of integers, supposing the value of the true numbers to be determined by chance, and finds it only as 1 to 235.2. The exact figure for the chance will of course depend upon the limit of error taken; but the above example seems sufficient to show that not only is Prout's law not as yet absolutely overturned, but that a heavy and apparently increasing weight of probability in its favour, or in favour of some modification of it, exists, and demands consideration.

**Chemical Society, April 15.**—Prof. H. E. Roscoe, president, in the chair.—The following papers were read.—On the lecture illustration of chemical curves, by E. J. Mills. The author has contrived an apparatus for exhibiting the variations in the actions of sulphuric acid on zinc and sodic hydrate on aluminium, produced by alterations (1) in the strength of the solution, (2) in the time during which the action is allowed to proceed. The gas evolved is collected in a series of inverted glass cylinders filled with water, arranged at equal distances. The surfaces of the water levels after the gas has been collected form a curve.—On the analysis of organic bodies containing nitrogen, by W. H. Perkin (continued). The author finds that a mixture of precipitated manganic oxide and potassium chromate (containing 10 per cent. of bichromate) in about equal parts kept at a temperature of 200°–250° C. is preferable to the chromate alone for absorbing the oxides of nitrogen.—On the volatilisation of solids in vacuo, by W. D. Herman. The author has obtained adamantine colourless transparent crystals of phosphorus by volatilising ordinary phosphorus in vacuum glass tubes in the dark. The crystals may be as long as 8 mm.; they turn red in sunlight. Similar experiments have also been made with sulphur, selenium, &c.—On the determination of nitric acid as nitric oxide by means of its reaction with ferrous chloride, by R. Warrington. The author describes an apparatus for the above purpose. The air is expelled by carbon dioxide, the nitrate heated by a calcium chloride bath to 135° C., and the nitric oxide measured as gas; organic matter does not affect the results.—On the six possible isomeric dibromotoluols and other of the bromo- and bromonitro derivatives of toluol related thereto, by R. Neville and A. Winther. The authors criticise the results of Wrobleosky, *Jahr.*, 1870, 528, and 1871, 450, and establish the conclusion that in such bodies the bromine never occupies a position which is "meta" to the amido group.

**Zoological Society, April 20.**—Prof. W. H. Flower, F.R.S., president, in the chair.—Prof. Owen, C.B., read descriptions of some new and rare Cephalopoda, to which were added notes on the occurrence of gigantic species of this group.—A second paper was read by Prof. Owen on the external and structural characters of the male of *Spirula australis*.—Dr. M. Watson read a paper on some points in the anatomy of the Proboscidea, in which he described the structure of the female organs of the Indian elephant, as observed in a specimen recently dissected.—Lieut.-Col. H. H. Godwin-Austen read a paper on the land-mollusc genus *Girasia* of Gray, and made remarks on its anatomy and on the form of the "capreolus" of Lister or the spermatophore, as developed in species of this genus of Indian Helicidae.—A communication was read from Dr. Max Schmidt on the duration of life of the animals in the Zoological Garden of Frankfurt-on-the-Main.—A communication was read from the Rev. O. P. Cambridge, C.M.Z.S., containing descriptions of new or little-known spiders of the genus *Argyrodes*.—A communication was read from Mr. Edgar A. Smith containing an account of a collection of the shells of Lake Tanganyika, and of the neighbourhood of Ujiji, Central Africa, made by Mr. E. C. Hore, of the London Missionary Society. Twenty-one species were represented in this collection, amongst which were two new generic forms proposed to be called *Tiphobia horei* and *Neodaumia tanganyicensis*.

**Geological Society, April 14.**—Robert Etheridge, F.R.S., president, in the chair. Colville Brown, John N. Dufty, and George Benjamin Nichols were elected Fellows of the Society.—The following communication was read:—On a new Theriodont Reptile (*Chorhizodon orenburgensis*, Twelvetr.) from the Upper Permian Sandstone of Kargalinsk, near Orenburg, in South-Eastern Russia, by W. H. Twelvetrees, F.L.S. The above measures are cupriferous, and rest on limestone with Zechstein fossils. Associated with the remains of Saurians and Labyrinthodonts are *Calamites*, *Lepidodendron*, *Avoides crassispatha*, Conifers, and a *Unio*. The specimen noticed in this

paper is apparently the dentary part of the left mandibular ramus, with the crowns of a canine, an incisor, and ten of the molars. The author describes the characteristics of these and the mode of implantation in the jaw, which accords with that described by Prof Owen in *Titanosuchus jevox*. The characters of this specimen resemble those of the genus *Rhopalodon*; but as there are some marked differences, the author proposes to name it *Chlorhizodon orenburgensis*.—The classification of the Tertiary period by means of the mammalia, by Prof. W. Boyd Dawkins, F.R.S., Professor of Geology in Owens College. The author, after some introductory remarks on the value of vertebrata and invertebrata in classification, pointed out that the mammalia become of especial value in the Tertiary period as undergoing more rapid change than the other classes, from their being, as it is happily termed, *en pleine evolution*. He discussed the characteristics of each of the great periods, as defined and limited by their mammalia, pointing out that throughout the Eocene these frequently exhibit relations more or less marsupial. Indeed it is not till the close of the Lower Miocene that the traces of this relationship are lost. In the Middle Miocene, *Sus*, *Cervus*, *Antelope*, *Felis*, *Lutra*, and *Castor* appear for the first time, and the higher apes were present in European forests. In the Upper Miocene, *Camelopardalis*, *Gazella*, *Hyena*, and *Hystrix* appear. During the Pliocene several important genera disappear from the world or from Europe—among the latter the apes, at the close of the Upper Pliocene. Oxen, horses, bears, and elephants appear. Great changes took place in the Pleistocene; seven species survived into it which are now extinct, and of new-comers there were fourteen living and seven extinct species. *Cervus megaceros* is the sole survivor from the Pleistocene to the prehistoric period which has since become extinct. The paper concluded with some remarks on the latter part of the first and the second period, which, however, as forming the subject of previous notices, was treated more briefly. The author remarked that a study of the development of the mammalia renders it hopeless to expect to find man in the Eocene or Miocene, and improbable in the Pliocene.

**Anthropological Institute, April 13.**—Major-General A. Lane Fox, F.R.S., vice-president, in the chair.—The director read a paper on Fijian Burial Customs, by the Rev. Lorimer Fison. There is no uniformity of custom in Fiji, so that no description of what is done by any one tribe can be taken as applicable to all the others. The strangling of widows, however, that they might be buried with their dead husbands, seems to have been everywhere practised. The widow's brother performs the operation, and is thenceforward treated with marked respect by his brother-in-law's kinsfolk, who present him with a piece of land over which the strangling-cord is hung up. Should he, however, fail to strangle his sister, he is despised and ashamed to show his face. When a woman is about to be strangled she is made to kneel down, and the cord (a strip of native cloth) is put round her neck. She is then told to expel her breath as long as possible, and when she can endure no longer to stretch out her hand as a signal, whereupon the cord is tightened, and soon all is over. It is believed that, if this direction be followed insensibility ceases immediately on the tightening of the cord; whereas if inhalation has taken place, there is an interval of suffering. An excuse for the practice of widow-strangling may be found in the fact that according to Fijian belief, it is a needful precautionary measure, for at a certain place on the road to Mbulu (Hades) there lies in wait a terrible god, called Nangga-nangga, who is utterly implacable towards the ghosts of the unmarried. He is especially ruthless towards bachelors, among whom he persists in classing all male ghosts who come to him unaccompanied by their wives. Turning a deaf ear to their protestations, he seizes them, lifts them above his head, and breaks them in two by dashing them down on a projecting rock. Women are let off more easily. If the wife die before her husband, the widower cuts off his beard and puts it under her left armpit. This serves as her certificate of marriage; and, on her producing it to Nangga-nangga, he allows her to pass. On the island of Vanua Levu a noted "brave" is distinguished from the common herd after death by being buried with his right arm sticking out above the grave-mound, and passers-by exclaim with admiration as they look upon the fleshless arm, "O the hand that was the slayer of men!" For some days after the decease of a ruling chief, if his death be known to the people, the wildest anarchy prevails. The idea seems to be that not until decomposition may be supposed to have made considerable progress is the dead man fairly done with,

and his authority handed over to his successor. Hence the death of a ruling chief is studiously concealed for a period varying from four to ten days. By many tribes the burial-place of their chief is kept a profound secret, lest those whom he injured during his lifetime should revenge themselves by digging up and insulting, or even eating, his body. Hence the surface sods are raised with extreme care, in order that they may be replaced with as little derangement as possible. Cave burial is common in Fiji, although by no means universal; in some cases artificial caves are made, either in the side of a hill, or by sinking a perpendicular shaft, and then putting in a "side drive," as the Australian gold-diggers call it; this forms the grave, and here the chief lies with his strangled women under him. A stone closes the entrance of the chamber and excludes the earth when the shaft is filled up. On the death of the king of the Nakelo tribe three old men come, with fans in their hands, and conduct the spirit to the banks of the river. Here they call upon Themba—the Nakelo Charon—to bring over his canoe, and wait until they see a wave rolling in towards the shore, which they say is caused by the approach of the invisible canoe; they then avert their faces, point their fans suddenly to the river, cry aloud, "Go on board, sir," and forthwith run for their lives, for no eye of living man may look upon the embarkation. The grave is dug about hip-deep, the body laid in it, and an old coconut is broken by a blow with a stone, being so held that the milk runs down upon the head of the corpse. The meat of the nut is then eaten by the three elders, and the grave is filled up.—A paper on the Polynesian Race, by C. Staniland Wake, M.A., was read. The author proposed to show, first, that the Polynesian Islanders must be described as a bearded rather than a non-bearded race, and secondly, that, as a rule, they are well acquainted with the use of the bow and arrow, and quoted the observations of numerous travellers in support of his view.—Major-General A. Lane Fox, F.R.S., exhibited some paintings and bead mats, the work of Bushmen.

**Physical Society, April 24.**—Prof. W. G. Adams in the chair.—New members:—The Marquis of Blandford, Mr. J. Marshall.—Prof. G. C. Foster read a note by Prof. Rowland, of Baltimore, U.S., on the discovery of Mr. Hall that a magnet exercises an electromotive on a current in a conductor crossing its field, as well as a force on the conductor itself. This fact will render it necessary to apply a correction to equations which assume that only the latter force acts. The electromotive force in question is at right angles to the direction of the current and to the lines of magnetic force. Prof. Rowland expresses it mathematically in this note, and bases a new method of determining the value of  $v$ , the ratio of the electrostatic to the electromagnetic unit of electricity, which gives  $v$  almost identical with the velocity of light, thus confirming Clerk-Maxwell's theory of the nature of light. Dr. J. Hopkinson, F.R.S., suggested an expression for one of Prof. Rowland's results.—Prof. Foster also read a note by Prof. Wild, of the Central Russian Meteorological Observatory, on a mode of correcting the bifilar magnetometer for torsion of its fibres, &c., and a method for finding the horizontal component of the earth's magnetism by its aid.—Mr. Ridout, F.C.S., described an improved thermo electric apparatus of his construction. The author has followed the idea of combining the thermopile and galvanometer in one instrument on the same base-board. The defects of the apparatus as ordinarily made are a too great disparity between the resistance in the pile and in the galvanometer; the junctions of the pile are too deep, and short-circuit the current; the bars too long and resisting, as well as too numerous; the junctions too slender; the mass of matter to be heated too great. These defects are remedied by placing the bars in glass tubes connected with these plates of copper; making the bars half the usual length, and using only a single pair. The defects in the galvanometer are that the wire does not come near the needle; the needles are not of the best form, and the suspension is troublesome. Mr. Ridout makes the wire a flat ribbon mounted on one bobbin; the needles are flat oblong plates from the same piece of steel, and magnetised in one piece; they are mounted on a pivot turning in an agate cup. The several parts of the apparatus are mutually adapted to each other; and in using it the galvanometer is not joined to the pile till the latter has been exposed to the heat, so as to prevent the current generated abstracting heat from the hot side. As made by Mr. Browning, the pile consists of a pair of elements  $\frac{1}{2}$  in. long, the copper connections being circular plates  $\frac{1}{4}$  in. thick and  $\frac{3}{4}$  in. diameter. The pile is supported by thick copper terminals

above the galvanometer, which consists of a copper ribbon making some twenty turns round a pair of astatic needles 1m. long and  $\frac{1}{4}$  in. broad, pivoted in an agate cup. A contact-key is placed on one side, and the whole is inclosed in a glass shade perforated opposite the pile. A glass cone protects the front from extraneous heat, and a glass case the back. A directing magnet is fixed above the pile. Contact between the galvanometer and pile is made after (say) 30 seconds' exposure to the heat. The pile is affected by a person standing six feet from it, and the radiation from stellar space is evident in clear weather. Half a minute is sufficient to put the instrument ready for use.—Mr. Ridout also exhibited laboratory experiments showing cohesion in mercury by causing it to overflow up an inclined trough; electrolysis of water by a single Grove or bichromate cell, through diminishing the pressure in the flask containing the water by boiling it and condensing the vapour on cooling; a differential thermometer showing absorption of heat on liquefying solids; and the production of musical notes in glass tubes by contracting the bore smoothly to about  $\frac{1}{4}$  of the diameter at one part. Prof. Foster remarked that the cohesion experiment might show the surface-tension. Prof. Guthrie and Prof. Hughes offered remarks on the electrolytic experiment, the latter stating that he finds the resistance of an iron cell he has constructed to depend on the electrodes rather than the liquid; when the negative plate is tempered iron the resistance is low, when soft iron it is high.—Prof. Stone exhibited photographs of König's new tonometer described by him at the last meeting, and further mentioned that König had devised a thermometer based on the principle that changes of temperature produce corresponding changes in the vibration rate of a tuning-fork. The temperature is found from the rate of the fork by bringing it to a zero rate by means of a rider.—Prof. Michin then described his experiment to solve the problem of transmitting light by photo-electric action. Two years ago he conceived the idea of employing for this purpose the fact that light falling on a sensitised silver plate disengages electricity. He forms a sensitive cell composed of two silver plates immersed in a conducting solution; one plate is coated with a sensitive emulsion of chloride or bromide of silver. When chloride is used, a solution of salt in water forms the liquid; when bromide, a solution of bromide of potash. A current is set up in the cell even in the dark, but when exposed to the magnesium light the current is very powerful, and flows within the cell from the uncoated to the sensitised plate. Prof. Michin also conducted this current by wire to a second cell in a dark chamber, and found that it effected a decomposition of the sensitive plate in that cell, as shown by a distinct darkening of the plate when "developed" by pyrogallie acid. The same effect was produced whether the current was reversed or not. Prof. Michin is continuing his experiments, and has provided a cable containing a number of separate conductors insulated from each other, in order to convey the currents from several cells. Prof. Perry feared that the effect would not be strong enough; but Prof. Michin said the light of a match produced a decided photo-electric effect in the cell. Prof. Perry alluded to the selenium plan proposed by himself and Prof. Ayrton, and said that Mr. Willoughby Smith had observed selenium to be sensitive to the shadow of a flying swallow. Prof. Adams testified to the sensitiveness of selenium and its power of being directly excited by light, a fact first proved by the experiments of Mr. Day and himself.

Entomological Society, April 7.—H. T. Stainton, F.R.S., vice-president, in the chair.—Messrs. G. C. Bignell, W. D. Cansdale, Frank Crisp, and the Rev. W. Fowler, were elected Ordinary Members, and M. E. André a Foreign Member.—Mr. J. T. Carrington exhibited a pale variety of *Arctia caja* which was bred by a gentleman at Croydon, who had been experimenting upon the effects of the rays of light transmitted through glasses of various colours upon this species. The specimens exhibited had been reared under green glass, but there was no evidence to show that the variation was due to the green rays.—The Secretary read a communication from Mr. Rothney, of Calcutta, on insects destroyed by flowers, with reference to a note on this subject published in the *Proceedings* of last year by Mr. J. W. Slater.—The following papers were read:—Notes on the coloration and development of insects, by Peter Cameron; on two gynandromorphous specimens of *Cirrochroa aoris*, Dbl., an Indian species of nymphalideous butterflies; and on *Cetonia aurata* and *Protactia bensoni*, by Prof. Westwood. Specimens and drawings were exhibited in illustration of the last paper, showing the specific distinctness of the insects in question.

Meteorological Society, April 21.—Mr. G. J. Symons, F.R.S., president, in the chair.—Rev. J. O. Bevan, M.A., F. E. Cobb, E. Filliter, F.G.S., T. L. Gentles, W. A. Harrison, F.R.G.S., J. W. Peggs, F. Slade, and E. J. C. Smith, were elected Fellows of the Society.—The discussion on Mr. Ellis's paper, on the Greenwich sunshine records, 1876–80, was resumed and concluded.—The following papers were read:—On the rate at which barometric changes traverse the British Isles, by G. M. Whipple, B.Sc., F.R.A.S., F.M.S.—A new form of Six's self-registering thermometer, by J. W. Zambra, F.M.S.

## EDINBURGH

Royal Society, April 5.—Sir Wyville Thomson, vice-president, in the chair.—Mr. John Murray, of the *Challenger* Expedition, occupied the evening with an interesting and exhaustive paper on the structure and mode of origin of coral reefs and islands. After detailing the well-known and widely-accepted theory of Darwin, Mr. Murray proceeded to take exception to its general truth, and to substitute a new theory, which, in the light of the recent discoveries of the *Challenger* Expedition, appeared at once simpler and more consistent with the facts. The main features of this theory were as follows: The abundant pelagic life of the ocean was stated to be the chief food of the reef-building corals and of the deep-sea animals. Lime-secreting creatures were especially abundant in tropical oceanic waters. Tow-net experiments showed that in a cubic mass of the ocean one mile square by 100 fathoms, there were about sixteen tons of carbonate of lime in the form of calcareous Algae, Foraminifera, pelagic Molluscs, &c. Although so abundant on or near the surface the dead shells of these organisms were quite absent from by far the greater part of the floor of the ocean. In all the greater depths they were removed during their fall or shortly after reaching the bottom by the action of carbonic acid, which was especially abundant in deep sea water. Other things being equal, they were found at greater depths where they were most abundant at the surface. On submarine elevations (which were probably all of volcanic origin) these dead shells were met with in great abundance: when the depth was less than a mile the shells and skeletons of almost every surface creature were present in the deposit. Mixed up with these we had in these deposits the shells and skeletons of deep-sea animals, as Echinoderms, Annelids, Polyzoa, Foraminifera, Corals, &c. In these more or less shallow depths the accumulation was relatively rapid, and the solvent action of sea water had consequently little effect. Eventually this bank reached near enough the surface to serve as a foundation for reef-building corals. As these corals built up to the surface those situated towards the outer margin of the coral plantation had a great advantage in the more abundant supply of food, and reached the surface first. If the coral-field or plantation were small (less than a square mile) the periphery was relatively large over which food came from the ocean, and from which detritus was carried to the interior; hence the interior was filled up and no lagoon was formed. The same was the case when the coral plantation was long and narrow. In larger coral-fields—the area increasing as the square and the periphery only in an arithmetic progression—the interior parts of the coral plantation were at a relatively great disadvantage, less food and less detritus for filling up were supplied per square mile, and in consequence a lagoon was formed. The carbonic acid in the sea water removed in solution the lime of the dead coral and coral rock from the lagoon. As the atoll extended seawards the lagoon was widened and deepened by the solvent and disintegrating power of the sea water. The structure of upraised coral atolls were referred to as confirming these views. Barrier reefs were explained on the same principles. Fringing reefs built seawards on a talus formed of their own debris and of surface shells and deep-sea shells and skeletons. A lagoon-channel was gradually formed by the solvent action of the sea water thrown over the reef at each tide. In this way the fringing reef became a barrier reef. Numerous sections of the reefs at Tahiti, from the survey of Lieut. Swire, of the *Challenger*, were exhibited. The structure of the interior overhanging reefs, and of the steep exterior submarine talus, were especially pointed out and explained. The chief features of barrier reefs and atolls were quite independent of subsidence, and would exist alike in stationary areas or in areas either of slow elevation or of slow subsidence. Throughout the volcanic islands of the great oceans the evidence of recent elevation was everywhere conspicuous, and the same was the case in regions of barrier

reefs and atolls, as shown by Dana, Jukes, Couthouy, Semper, and others. He would expect to find local areas of subsidence in the great ocean basins on either side of volcanic islands and atolls, and this is what the soundings of the *Challenger* and *Tuscarora* seem to show. On the other hand the lines of volcanic islands and coral islands had probably always been the sites of a gradual elevation, for it must be remembered that these last have probably almost all a volcanic basis. In all cases the great agencies are the growth of the coral where most nourishment is to be had, and its death and disintegration by the action of the sea at those parts which cannot be, on account of their situation, sufficiently supplied with nourishment. In many cases, however, this disintegration, by breaking up the reef, serves to so alter conditions that decaying parts get a new lease of life, and growth begins afresh where decay was formerly manifest. Mr. Murray applied his theory with singular success to the discussion of particular cases of coral islands, such as the Maldive Islands, the Chagos Archipelago, and the great barrier reefs of Australia. The special merit of the theory is that it does away with the great and general subsidences which is the peculiar feature of Mr. Darwin's theory. Of such subsidences there is no other evidence. These views were also in harmony with Dana's as to the great antiquity of the ocean basins. In a previous paper he had shown that a study of deep-sea deposits also argued for the permanency and great antiquity of these great ocean depressions. The co-existence of fringing and barrier reefs and of atolls in close proximity (e.g. in the Fiji Islands), which is not easily explained by Darwin's theory, offers no difficulty whatever when looked at in the light of Mr. Murray's principles. In the criticism which followed, Sir Wyville Thomson and Prof. Geikie spoke in terms of high commendation of the thoroughness which characterised Mr. Murray's paper, and the success with which he had been able to do away with the assumption which was the basis of Darwin's theory, but for the truth of which there was no positive evidence.

PARIS

Academy of Sciences, April 26.—M. Edm. Becquerel in the chair.—The following papers were read:—On the inverse problem of the motion of a material point on a surface of revolution, by M. Resal.—On the law of distribution, according to altitude, of the substance in the atmosphere absorbing ultra-violet solar radiations, by M. Cornu. The identity of this law (which he is able to determine very definitely) with the barometric formula, shows that the absorption is exercised by the gaseous mass and not by aqueous vapour or dust, which leads to different progressions.—Study of the explosive properties of fulminate of mercury, by MM. Berthelot and Vieille. It is simply decomposed into carbonic oxide, nitrogen, and mercury. The authors furnish data of the heat liberated, the density, and the pressures developed in a closed vessel. The superior force of the fulminate is attributed to the almost instantaneous nature of its decomposition by simple inflammation, the almost total absence of dissociation of the products, and the great density of the matter.—On the cholera of fowls; studies of the conditions of non-recurrence of the malady, and some others of its characters, by M. Pasteur. The aliments suited to the life of the microbe in the fowl disappear in consequence of inoculation with attenuated virus.—Observations of Schaberle's comet at Marseilles Observatory, by M. Stephan.—On the meteorite which fell on May 10, 1879, near Estherville (Emmet Co., Iowa, U.S.), by Prof. J. Lawrence Smith. He thinks this meteorite should be placed apart for the phenomena of its fall, especially the force of penetration of its fragments into the ground, and for the mode of association of its mineral constituents.—On winter barley as forage, by MM. Pierre and Lemetayer. It is rather the abundance and precocity of this cereal which renders it in demand, than its richness in azotised matter.—On appointment of a scientific commission for the Panama scheme. M. de Lesseps specified documents he would give them. The work in hand came to this: 75,000,000 cubic metres to be excavated; 8,000 workmen for six years; 250 working days each year, or 1,500 days, during which 50,000 cubic metres should be done each day.—*Apropos* of M. Bouty's note on thermoelectric currents from a metal and a liquid, M. Du Moncel recalled former experiments by M. Hellesen and himself.—Some considerations in support of a note of March 29 on the impossibility of supposing in general a function of velocities in every question of hydraulics where frictions have a notable role, by M. Boussinesq.—On the dependence of two electromagnetic gyro-

scopes submitted to the same circuit of induction, by M. de Fonville. The velocity of each movable piece is diminished.—The death of M. de Luca was announced.—The surface of the wave considered as a limiting surface, by M. Mannheim.—On the numerical calculation of definite integrals, by M. Baillard.—On simultaneous linear equations and on a class of non-plane curves, by M. Picard.—On the series  $F_2(a, \alpha, \beta, \beta', \gamma, x, y)$ , by M. Appell.—Influence of temperature on the duration of period of a tuning-fork, by M. Mercadier. He corrects a numerical mistake in his memoir as quoted by Wiedemann (with whom he is in agreement).—On the theory of induction-currents, by M. Mascart.—On an experimental method fitted to determine the lines of surface in stationary flow of electricity through conducting surfaces, by M. Guébbard. At a short distance from a thin plate of metal in a mixed solution of acetate of lead and acetate of copper, are held the free ends of two conductors connected with a pile; thus a double system of Nobili's rings is produced of remarkable constancy and regularity, and in relation to the positions of the electrodes and the contour of the conducting surface.—Absolute measurement of Peltier's phenomenon on contact of a metal and its solution, by M. Bouty.—Measurement of the difference of potential of two metals in contact, by M. Fellat. The method (which has precision exceeding  $\frac{1}{100}$  Daniell) is one of compensation, and its principle is, that if two metals, A and B, are connected by a metallic wire they take the same difference of potential as if they had been put directly in contact. The author studies the effects of varied surfaces of metals, change of temperature, and influence of gases round the plates.—On the theory of double circular refraction, by M. Gouy.—Influence of temperature on the compressibility of gases under strong pressures, by M.

Amagat. When a gas is  $\left\{ \begin{matrix} \text{more} \\ \text{less} \end{matrix} \right\}$  compressible than according to Mariotte's law, its compressibility  $\left\{ \begin{matrix} \text{decreases} \\ \text{increases} \end{matrix} \right\}$  with the temperature.—Researches on the passivity of iron (second part), by M. Varenne. *Inter alia*, an iron rod may be made passive by immersion of only a fraction of it in concentrated nitric acid, and passivity may be produced by prolonged immersion of iron in compressed bixide of nitrogen.—On the proportion of iron in mineral waters of Rouen and Forges-les-Bains, by M. Houzeau.—Isomers of phloroglucine, by M. Gautier.—On the products contained in coke of petroleum, by MM. Prunier and Varenne.—On a singular explosion produced during heating of wine, and on a new mode of determination of alcohol, by M. Wartha. This explosion was probably caused by inflammation of a mixture of alcohol and air in the tun. M. Wartha is seeking to determine the limit of explosion of such mixtures.—Synthetic reproduction of the aluminous silicates and alkaline silico-aluminates of nature, by M. Meunier.—On the origin and development of the egg in the Medusa Eucopa before fecundation, by M. Merejkowsky.—On the apparent analogies between cholera of fowls and the malady of sleep (nelavan), by M. Talmay.

CONTENTS

PAGE

THE COMING OF AGE OF THE ORIGIN OF SPECIES. By Prof. T. H. HUXLEY, F.R.S. . . . . .	1
ON MULTIPLE SPECTRA. By J. NORMAN LOCKYER, F.R.S. . . . .	4
SCIENCE IN PARLIAMENT. . . . .	7
WURTZ'S "CHEMISTRY" . . . . .	8
OUR BOOK SHELF:—	
Goss's "Geological Antiquity of Insects" . . . . .	1
LETTERS TO THE EDITOR:—	
The Opportunities of Science Masters at Schools.—FRANCIS GALTON, F.R.S. . . . .	9
Museum Conference.—E. M. HOLMES . . . . .	10
Ural Crayfish.—W. H. TWELVETREES . . . . .	10
Protection against Mosquitos, Flies, and Blight.—WM. CHAPPELL, F.S.A. . . . .	11
Immersion of Iron and Steel in Acidulated Water.—WILLIAM H. JOHNSON . . . . .	11
Stone Arrow Heads.—W. L. DISTANT . . . . .	11
The Mode of Suckling of the Elephant Calf.—J. C. G. . . . .	12
The Tay Bridge Inquiry.—Q. C. . . . .	11
Yeast and Blackbeetles.—LONDON HOUSEHOLDER . . . . .	11
DECEASES AND BAILLON . . . . .	78
DR. RUDOLF SCHEFFER. By HENRY O. FORBES . . . . .	78
A SCOTTISH CRANNOG ( <i>With Illustrations</i> ) . . . . .	13
NOTES . . . . .	16
OUR ASTRONOMICAL COLUMN:—	
The Comet of 1106 . . . . .	18
PHYSICAL NOTES . . . . .	18
GEOGRAPHICAL NOTES . . . . .	19
SCIENTIFIC SERIALS . . . . .	20
SOCIETIES AND ACADEMIES . . . . .	21

THURSDAY, MAY 13, 1880

## MIGRATORY BIRDS AT LIGHTHOUSES

CONSIDERING the amount of nonsense that has been written and still continues to be written—in season and out of season—on the subject of the migration of birds, it is very refreshing to find two gentlemen in this country seriously setting to work to accumulate facts, which may in time be reasonably expected to enable ornithologists to arrive at an opinion, more decided than anybody can be said to possess at the present moment, with regard to that wonderful movement. It might be thought, perhaps, that we indeed had already enough and to spare of recorded observations, for lists of the arrival of migratory birds abound in most of our natural-history periodicals, to say nothing of provincial newspapers; but it does not require much study and comparison of those lists to perceive that, with some honourable exceptions, they are obviously the work of persons not at all fitted—whether by character, training, or opportunities it matters not—to be competent observers, and consequently the records of their observations have done uncommonly little to advance our knowledge of the subject. Every one who has tried anything of the sort must admit, if he speaks the truth, that the difficulties in the way of observing the movements of birds are much greater than at first sight would appear to be the case. To carry on this kind of systematic observation to any good purpose, a man, if he cannot make it his first object, must yet have such occupations as will not interfere with his being in the right place at the right moment, and of course the ordinary engagements of life are very apt to act as disturbing forces and to baffle his best intentions. Farmers, in the pursuit of their vocation, are perhaps of all professional men the most suited for the work; but the farmer may have to attend a couple of distant market-towns for as many days in the week, and unless his road thither and thence lies favourably, these will be *dies non* so far as his opportunities of observation are concerned. A very few years' experience will convince any sensible person that the first wheatear of the season is almost always to be seen on a certain down or heath, and the earliest swallow over a certain pool or reach of a river. Localities like these, once discovered, have to be watched daily by him who wishes to record faithfully the arrival in his district of those particular species, and the same is to be said of others. Even the most enthusiastic sportsman may be hindered by a score of circumstances over which he has no control from visiting for a week or more the particular spot in a copse or corner of a bog where, if there be a woodcock or a snipe in the country, he knows it is sure to be found. Seeing then that of the various kinds of outdoor observations few are more subject to the accidents which affect human actions and habits than those which relate to the movements of birds, the extremely unsatisfactory nature of records made in what is at best a casual way may be accounted for, and hitherto we have had scarcely any records of any other sort.

Some time ago it occurred to Mr. Cordeaux, author of that excellent little book "The Birds of the Humber District," noticed in these columns some seven or eight

VOL. XXII.—No. 550

years since (NATURE, vol. viii. p. 100), and to Mr. Harvie Brown, a gentleman not less well known by his ornithological writings, that a great increase in our knowledge of the subject would accrue if they could but get the keepers of the numerous lighthouses and lightships along our coast to assist in the work, and accordingly they set about enlisting these men in the service.\* We know not whether these gentlemen had fully appreciated the unsatisfactory nature of existing records, upon which we have just been dwelling, nor does it signify in the least. It was evident to them, and might have been to others, that men who were always on duty and always on the look-out would be able, if so minded and properly instructed, to give valuable aid, and that their observations would necessarily be of a kind that it was impossible for any other class of people to make, for they would be carried on at hours when nearly all the rest of the world was indoors, if not asleep, and at places at once the most favourable and the most inaccessible to any one else.

By what steps Messrs. Cordeaux and Brown proceeded, and how they overcame the scruples (if any were entertained) of the authorities of the Trinity House Board in England and of the Commissioners of Northern Lights in Scotland, we are not told; but these gentlemen have to be congratulated on the result they have attained, which appears in the form of a most instructive and interesting "Report"—the first, we hope, of a long series—"on the Migration of Birds in the Autumn of 1879," printed in the *Zoologist* for the current month, to which we beg leave to call our readers' best attention. It appears that forms of inquiry and letters of instruction were sent to various lighthouses and lightships. To begin with the east coast of Great Britain, it is said that such papers were forwarded to *twenty-six* Scottish lighthouses, from *thirteen*, or just one-half, of which returns have been received, the remaining thirteen having either sent back the forms blank, owing to the unusual scarcity of birds last autumn, or having taken no notice of the request to fill them up. The same course was pursued with respect to *thirty-seven* English stations, from *twenty-five* of which returns have been received. On the west coast appeal was made to *thirty-four* Scottish stations, *twenty-four* of which replied, and to three on the Isle of Man (the Manxmen were silent), but to none in England or Wales. So much willing co-operation, we confess, we could hardly have anticipated, especially on a first experiment, and it certainly appears from the intelligent remarks (of which specimens are occasionally given by the reporters), in addition to the mere filling up of the sheets supplied to them, that the men must have taken considerable interest in the inquiry, as well as have taken no common pains in giving the information sought.

To form any conclusions on insufficient premisses is a rank offence in science, and it would be absurd to suppose that this single report throws any light on the mysteries of migration. But we are greatly mistaken if

\* We give all credit to these gentlemen for the originality of action, but the conception of some such scheme had been taken up before. Among the numerous inquiries in which Mr. J. H. Gurney, jun., had engaged himself, he had already made some endeavours in this direction, and we are in a position to say that even prior to his time, though nothing came of it, the idea had been broached informally among some zoological members of the British Association for the Advancement of Science. Of this fact we, however, believe that Messrs. Brown and Cordeaux were not conscious, as indeed it could hardly happen that they should be.



some of them may not be cleared up by a series of such reports, and the chief value of the present successful attempt is, in our humble opinion, to show that the plan put into operation by Messrs. Cordeaux and Brown is workable, and we sincerely trust that they will continue their enterprising efforts. The amount of correspondence and trouble it must give them cannot fail to be very great, but they, as well as the lighthouse and lightship keepers, will have one kind of reward, and that, perhaps, one not altogether unsatisfactory. They will obtain the true gratitude of all ornithologists who believe in ornithology as a study of life, and we believe will receive from ornithologists without exception the credit and encouragement they so richly deserve. If the scheme can be kept going for half-a-dozen years we can scarcely fail to be in a position to know something worth knowing of the

“wild birds that change  
Their season in the night, and wail their way  
From cloud to cloud,”

whose movements at present give rise to so much speculation, and thereby, perhaps, penetrate another, and certainly one of the most interesting of nature's secrets.

#### THE RIVER OF GOLDEN SAND

*The River of Golden Sand.* By Capt. William Gill, R.E. With an Introductory Essay by Col. Henry Yule, C.B., R.E. (London: John Murray, Albemarle Street, 1880.)

“THE River of Golden Sand,” the narrative of a journey through China and Eastern Tibet to Burmah, is likely to prove one of the most valuable books of travel that have been published for a considerable time. It is prefaced by a long and able introductory essay by Col. Yule. In it are indicated many points of geographical interest in the country in which the River of Golden Sand is taken as the axis—the part of Eastern Tibet which intervenes between India and China—and the history sketched of explorations in this extent of country previous to Capt. Gill's. This essay is so full of interest and information that we shall try to give a summary of the facts detailed in it.

The first thing that strikes an observant eye in looking at a map of Asia is the number of great rivers that rush southward in parallel courses within a very narrow space of longitude. This forms the most striking characteristic of the country between India and China. The first of these rivers, beginning at the west, is the Subanshiri, coming from the Himalaya and entering the valley of Assam. The next is the Dihong, which joins the Lohit—Brahmaputra proper—at Sadiya. The third river is the Dibong, which joins the Dihong before its union with the Brahmaputra. It is now believed that this does not come from Tibet. The people of Upper Tibet say they have only two rivers coming from Tibet—the Dihong and the Brahmaputra. The Brahmaputra enters Assam at the Pool of Brahma. This, from a curious piece of evidence given by Col. Yule, is evidently identical with Kenpu of Chinese geographers. The Ku-ts-Kiang is almost certainly a source of the Irawadi. The remotest sources of this river do not lie further north than 30° at the utmost. Its length is considerably shorter than the River of Golden Sand. The Mekong has its source in the far north of Tibet. Its lower course has only been known accurately since

the French expedition. But the town of Tsiando, standing between its two main branches about latitude 30° 45', was visited by missionaries in 1866, so that its course is known as far north as this.

The Chin-Sha, from which Capt. Gill's book takes its name, is, if not the greatest river in Asia, the longest. Capt. Gill followed the windings of this river, with a few digressions, during twenty-four marches on his way from Bat'ang to Ta-li-fu. This great river has its source in about 90° longitude—almost as far west as Calcutta. At this part of its course its channel is 750 feet wide, and the whole river from bank to bank nearly a mile wide. Flowing into China, it receives the name of Kin-Sha-Kiang, which it retains until joined by the Min, coming from Ssu-ch'uan. There it becomes navigable to the sea. The navigation has often many hindrances in the way of rapids and gorges. Capt. Gill was the first to give us any accurate knowledge of the Yun-nan and Tibetan part of this great river.

The remaining two parallel rivers are the Ya-lung-Kiang and the Min-Kiang. Capt. Gill is the only traveller that has traced the latter river to the alpine highlands.

How to obtain direct communication between India and China has always been a difficult problem. India first became known to China not across the mountains and through the river valleys, but by the enormous circuit of Bactria and Kabul. In the year 127 B.C., Chang-Rien, a military leader, in exploring the country round the Oxus, brought back a report of a land called Shin-tu, *i.e.* Hindu, India. Attempts were made several times to penetrate by the Ssu-ch'uan frontier to India, but with little success. Two hundred years later, when communication opened with India, it was by way of Bactria, and went on so for centuries. In the “Periplus,” a work of the first century A.D., mention is made of trade in silk stuffs through Bactria to Bhröch. Marco Polo, when making his way to the frontier of Burma, went by the same route as Capt. Gill on his ninth march from Ch-eng-tu. Ta-li-fu, which is so often spoken of in Capt. Gill's book, is a central point on the Chinese frontier. For centuries it has been the centre of all military and commercial communication between China and Burmah.

By the treaty of Tien-ting British subjects received the right to travel in the interior of China. Modern exploration dates from this, and our knowledge of the physical geography, natural resources of the country, and characteristics of the people of China have been slowly growing. It must not be forgotten that the missionaries of the Roman Church travelled much over China and Tibet. Publicity would have been against their purpose, and geographical research was not their object, so that their journals came before a limited few. Abbé Huc, in his famous story of his journey with Gabet, gave the first picture of Eastern Tibet in modern times in 1850. Carl Ritter's great work, which appeared many years before Huc's, gives a great deal of information of the great road by Ch'eng-tu to Lhasa. Apart from the little known efforts of the Roman Catholic missionaries, no attempt was made to penetrate those regions until 1861. Blakiston's exploration of the Upper Yang-tzu, after the treaty of Tien-ting, was the first in this direction. In 1867 the great French expedition to Ta-li under Garnier was made. This was the first time that any European

traveller (not a priest) had seen the Yachi of Marco Polo since he himself was there in 1283. In 1860 Mr. Cooper traversed from Han-kow to Bat'ang over the high plateau, the scene of Capt. Gill's expedition afterwards. Cooper hoped to reach India by China, but on the Chinese frontier his party had to stop their journey owing to the disturbed state of the country. There was not much geographical information collected on this journey. In 1872, Baron Richthofen at Ch-eng-tu was on one of those important journeys which forms the groundwork of Capt. Gill's work. His project came to an untimely end. In speaking incidentally of the labours of the Roman Catholic missionaries, Abbé Desgodins must not be forgotten.

In 1873 Augustus Margary was appointed to explore the country between the Irawadi and China. He successfully reached Bhamo from China, but on his return journey he met his tragic end. Since that time there has been a more recent journey made by Mr. Baber by a new route to Ta-chien-lu.

Capt. Gill's first journey was through the north of Pe-chih-li to the sea terminus of the Great Wall. His ascent of the Yang-tzu is full of interest. The greatest importance attaches to his journeys when he commenced his excursion from Ching-tu to the Northern Alps, to where the Chinese Kiang flows southwards into Ssü-ch'uan. It was at this time that Capt. Gill came among highland tribes called Man-tzu and Si-fau. The people along the westward frontier are named by the Chinese Lolo, Man-tzu, Si-fu, and Tibetan. The Chinese look upon the Man-tzu as descendants of the old inhabitants of Ssü-ch'uan. Man-tzu and Si-fau are ambiguously used. Si-fau is used in Capt. Gill's book as applied to a Tibetan-speaking race in the north-east of Tibet.

Capt. Gill had meant to make a journey through Kansuh to Kashgaria, and from that through the Russian dominions to Europe. This plan was rendered impracticable by the unsettled state of affairs between England and Russia. His homeward route was the same that Cooper had tried nine years before by Lit'ang, Bat'ang, and Ta-li. He left Ch'eng for England by the Irawadi on July 10, 1877. The first important place reached was Ya-chau. It is here that the trade of Tibet begins, brick tea or cake tea being the staple of the trade. Capt. Gill gives interesting details about this, and also of a similar manufacture at Hankow for Mangolia. English rupees have become the currency in Tibet. They have superseded the tea bricks which were formerly used as money. The great drawback to the tea trade in Western Tibet does not lie in the Chinese being unwilling to open the landward frontier, but in the jealousy of the Lamas. Their chief desire is to monopolize power, enlightenment, and trade.

Capt. Gill's second place of landing was Ch-eng-tu, the Chinese gate of Tibet, on the Ssü-ch'uan frontier. Very little is known of the ethnography of the tribes on the mountain frontier of China, Burma, and Tibet. The two most prominent are the Mossos and the Lisus. They have some claims to civilisation. The men are quite Chinese in appearance, and have adopted the dress and the pigtail. The women retain a fashion analogous to the fashions of the Swiss and Pyrenean valleys. Their vocabularies have 70 per cent. words common to both, and show a connection with some of the Burmese.

Capt. Gill has given a remarkable manuscript to the British Museum. Its hieroglyphical characters are unknown. It consists of eighteen pages about 9½ inches by 3½, each page having three lines, and the characters reading from right to left. The groups of characters are divided by vertical lines. Some of them resemble the old Chinese characters called Chuen-tzu. M. Terrier has in his possession another manuscript resembling this one, but probably Capt. Gill's one is much older. Garnier, while in Hu-nan, was told that in some caves near that province were found chests containing books written in European characters. Probably they may have been books belonging to extinct aborigines in phonetic characters.

The introductory essay, written by so high an authority as Col. Yule, will greatly enhance the value of Capt. Gill's work.

The work is in the form of a journal, and is so graphically written that throughout the interest never flags. The account of the journey through the north of China is full of information regarding the physical aspect of the country and the many beautiful scenes Capt. Gill passed through. Peking, it appears, is much the same as in the time of Marco Polo, but a great deal of its former grandeur seems to have gone. That 300,000,000 of people should have remained unchanged for centuries seems a very extraordinary fact. Yet in whatever part of the world the Chinese are found they still retain the individuality of their race, and act in all things as their forefathers did hundreds of years before. Their lack of imagination and love of independence, Capt. Gill thinks, account greatly for their stagnation. If the Chinese ever had any originality, perhaps the worship of antiquity and the system of examination have had something to do with cradating it.

The voyage along the Chin-Sha-Chiang was full of surprises; the scenery was constantly changing. At one time the river went winding through "great plains where broad lagoons lay stretching out amongst fields that were protected from the summer floods by extensive dykes and embankments." Now the grand river, clear and almost green, rolled below cliffs of red sandstone. Beyond Ch'ang "the river narrows from 400 to 500 yards. Steep spurs from the mountains 3,000 feet high run down to the water's edge, their sides, wherever not absolutely perpendicular, covered with long, orange, brown grass, that seems to grow almost without soil. On the more gentle slopes terrace cultivation is carried on. Little patches of the most brilliant green, sometimes a thousand feet above the river, show the presence of some industrious farmer who will not leave a square yard uncultivated if he can help it." "The Chinese," Capt. Gill says, after speaking of their great industry, "plough about as well as the natives of India, doing little more than scratch the ground. It is true they raise two crops on the same field, as, for instance, when they plant opium under rape, or yams under millet. They have no knowledge of the modes of improvement practised in the various breeds of cattle; no instruments for breaking up and preparing waste land; no system for draining and reclaiming swamps and morasses." On the banks of this river Capt. Gill saw flowers being picked from a tree like an apricot-tree. The blossoms were like long conical-shaped pods; on their surface were numerous

small flowers full of pollen. The poor people make a drink from these instead of tea. This flower could not be identified, although high botanical authorities were consulted.

The Chinese could not understand why any one should travel in discomfort when he could stop at home in ease. They cherish the most profound respect for any literary person, so to explain his incomprehensible habit of looking at everything, Capt. Gill went about with a notebook in his hand, telling them he was going to write a book. He came on many villages whose original inhabitants had been expelled by the Chinese, who still continue their advance, stopping only where the soil and the climate refuse fruits to those industrious agriculturists. Ch'eng-tu, where Capt. Gill made some considerable halt, has changed much since Marco Polo wrote his description of it. The same river still runs by the city, but not through it, as it did then. The large plain that incloses the town has gradually been drained. At one time it must have been the bottom of a lake. Many insect-trees were met with on the way to Tibet. "It is on this tree that the insect is bred that produces the white wax of Ssü-Ch'uan. The trees are something like willows. Here the insect emerges from his egg, and the branch of the tree on which he is placed is soon covered with a kind of white wax secreted. It is this white wax that is so celebrated, and is one of the most valuable products of Ssü-Ch'uan. These eggs cannot be exposed to the heat of the sun, and whilst being carried from the breeding to the producing district the coolies travel only in the night, when the road is said to present a very remarkable appearance, as they all carry lanterns. Ordinarily in China no travelling is done at night, and as the gates of all towns and cities are closed at dusk, and are never opened for anybody, no matter who he may be, travelling at night is rendered impossible. But during the time for bringing the eggs to Kia-Ting-Fu all the city gates are open night and day—probably the only exception in China to the rule of shutting the gates at dusk. The one day it seemed to Capt. Gill as if "the happy valley of Rasselas had been in Tibet," the next day he was driving through piercing cold. On his way to Batang he had a glorious view of Mount Neu-Da. "No words can describe the majestic grandeur of that mighty peak, whose giant mass of eternal snow and ice raises its glorious head seven thousand feet above the wondering traveller, who yet stands within five miles of its summit. He can but gaze with admiration and appreciate the feelings of the Tibetans that have led them to call it Neu-Da, or the Sacred Mountain."

The Lamas seem to be the great curse of Tibet. The scapegrace of a family goes into a Lamassery, not, however, entirely for devotion, coming home at short intervals for amusement. "The Lamas assist in no way in the maintenance of the State; their lands are free from taxation, and they do not pay one iota towards the Government expenses." The customs of the people of Tibet seem to resemble those of the Israelites. They pray on the house-tops, pay their cattle-keepers as Jacob did, and set before strangers "butter in a lordly dish." The population is diminishing in Tibet by the oppression of the Lamas and emigration to Yun-Nan. The land that the emigrants leave behind them goes to the Lamasseries. "As

it cannot be taxed the burden of taxation becomes heavier on the remaining people, who still have to make up the same amount.

At Shin-Ku Capt. Gill bade adieu to the River of Golden Sand and continued his route to Bhamo, in the footsteps of Marco Polo and Augustus Margary. He came on the scene of Margary's death. The most fitting tribute that could be paid to this brave officer was "to establish in those border-lands the right of Englishmen to travel unmolested."

Instead of a gigantic river like the Chin-Kiang, the Irawady above Bhamo, though wide, is very shallow. The continual rain that falls over its basin is very great. At Bhamo Capt. Gill was welcomed by Mr. Cooper, who in all his dangerous wanderings had escaped with his life; when safety seemed to come he fell by the hand of an assassin under the British flag. Capt. Gill's homeward journey was through New Mandalay.

Capt. Gill's book will prove a valuable authority on the particular part of China through which he travelled. It does not represent the scientific results, which were published in the *Journal* of the Royal Geographical Society. His journey in Western China is one of the most successful that has been made, although it was achieved under a great drawback; he did not know the Chinese language. He was, however, very fortunate in his two interpreters, but his success was due to his great tact and perseverance. He tells his story with a brightness and impressiveness not common in modern books of travel, and his originality and independence of view are evident in every page. He has no very great opinion of the Chinese, and his remarks on their peculiar characteristics are well worth consideration. One sees the born traveller in every entry in his journal; nothing is thrown in for effect. A great deal of his journey was made in the dark, through fog and rain, yet he adhered strictly to his rule of writing the accounts of the day's doings every night. This had often to be done with the comforting thought that most probably the record would be lost.

The work is well supplied with maps and illustrations, the former especially being among the most valuable of recent contributions to the hydrography of Asia.

#### OUR BOOK SHELF

*The Geological Record for 1877. An Account of Works on Geology, Mineralogy, and Palæontology published during the Year, with Supplements for 1874-1876.* Edited by William Whitaker, B.A., F.G.S., of the Geological Survey of England. (London: Taylor and Francis, 1880.)

WE hail with pleasure the appearance of the fourth volume of this most valuable work. The indefatigable editor deserves all praise for the energy with which he has worked in getting together a staff of volunteers to compile the useful abstracts of contents of the numerous works and memoirs noticed in this volume of 432 pages. It is unfortunate that the work has now fallen two years into arrear, but, now that the staff of contributors seems to have fairly settled down to its work, we hope the editor will soon be able to recover lost time, and that each succeeding volume will appear within the year following that for which it is issued. The editor has been very happy in discovering a method by which the officers on the staff of the Geological Survey may

usefully employ their leisure, by contributing to geological literature, and we heartily wish him success in his work.

*Ensayo sobre una nueva enfermedad del Olivo.* Por Don Pablo Colvée. Publicado en la Gaceta Agrícola del Ministerio de Fomento. Pp. 43, pl. i-ii. (Madrid, 1880.)

It appears that the Spanish olive crop is being jeopardised in the neighbourhood of Valencia by an insect of the family *Coccidae*, distinct from *Lecanium oleæ*, already known as attacking the olive, and considered by Don Pablo Colvée to be a new species of the genus *Aspidiotus*, which he describes as *A. oleæ*. It apparently attacks the tree generally, but especially the fruit, causing the full development of the latter to be arrested. The greater part of Don Colvée's paper is occupied by considerations on the development of insects in general, and on those attacking the olive in particular. The author appears to suggest no special remedy, but judiciously invites investigations as to whether the attacks of the insect are the primary cause of the want of health in the trees, or whether the latter does not invite the attacks.

LETTERS TO THE EDITOR

[The Editor does not hold himself responsible for opinions expressed by his correspondents. Neither can he undertake to return, or to correspond with the writers of, rejected manuscripts. No notice is taken of anonymous communications.]

[The Editor urgently requests correspondents to keep their letters as short as possible. The pressure on his space is so great that it is impossible otherwise to ensure the appearance even of communications containing interesting and novel facts.]

Winter "Swallows"

SOME months ago I tried to investigate, so far as possible, the many recorded occurrences of swallows in this country in winter. As might be expected, a large proportion of them broke down on inquiry, but there was one which, for several reasons, I thought might be safely trusted. It appeared in the "Remarks on the Weather during the Quarter ending 31st of March, 1864" (p. 5), appended to the Registrar-General's Report for that period, and stands thus:—

"Swallows were seen on January 22d, three miles south of Grantham."

Through the kindness of Mr. Glaisher, F.R.S., and of Mr. Jeans of Grantham, I was at last put into communication with the original circulator of the statement, who obligingly wrote to me (omitting names) as follows:—

"—— Grantham, Sept. 23d, 1879

"SIR,—The information given to —— respecting the swallows, I discovered some time afterwards was not correct; what was taken to be swallows were the common bat. I much regret being instrumental in incorrect statements being published; it was an Irishman in my employ who told me of them; he some time afterwards showed me what he supposed to be swallows.

"I remain, sir,  
"Your obedient servant,  
"———"

I leave to others the moral that may be drawn from the above.  
ALFRED NEWTON  
Magdalene College, Cambridge, May 9

Does Chlorophyll Decompose Carbonic Acid?

I HAVE read with much interest in NATURE, vol. xxi. p. 557, Prof. Lankester's remarks on the question—Does Chlorophyll decompose Carbonic Acid? and having many years ago made experiments on that and kindred topics, should be much obliged if you will do me the favour to reprint the following extract from a paper I published in the *Philosophical Magazine* (December, 1872, p. 425, &c.). This is also in my scientific memoirs, p. 409, 410.

"The decomposition of carbonic acid by plants is undoubtedly the most important of all actino-chemical facts. The existence of the vegetable world, and, indeed, it may be said, the existence

of all living things, depends upon it. I first effected this decomposition on the solar spectrum, as may be found in a memoir in the *Philosophical Magazine* (September, 1843). The results ascertained by me at that time from the direct spectrum experiment, that the decomposition of carbonic acid is effected by the less, not by the more refrangible rays, have been confirmed by all recent experimenters, who differ only as regards the exact position of the maximum. In the discussions that have arisen, this decomposition has often been incorrectly referred to the green parts of plants. Plants which have been caused to germinate and grow to a certain stage in darkness are etiolated, yet these, when brought into the sunlight, decompose carbonic acid, and then turn green. The chlorophyll thus produced is the effect of the decomposition, not its cause. Facts derived from the visible absorptive action of chlorophyll do not necessarily apply to the decomposition of carbonic acid. The curve of the production of chlorophyll, the curve of the destruction of chlorophyll, the curve of the visible absorption of chlorophyll, and the curve of the decomposition of carbonic acid are not all necessarily coincident. To confound them together, as is too frequently done, is to be led to incorrect conclusions."

Nothing can act before it exists, nothing can originate itself. Chlorophyll is therefore the result, not the cause, of the decomposition. Its continual increase during the life of a plant is an effect of the same kind. The force decomposing carbonic acid does not reside in chlorophyll, but elsewhere in the structure of the leaf.

JOHN WILLIAM DRAPER  
University, New York, April 28

On a Point Relating to Brain Dynamics

ANY attempt to grapple with the doctrine of Free Will v. Necessity on the old lines would probably (and deservedly so) not attract much attention. The object of this paper is to place a consideration of extreme simplicity under critical notice, which would seem to be capable of affording a key to the complete reconciliation of the divergent views on a common basis; and since the matter to be dealt with will be strictly within the domain of natural science, a clear analysis will be rendered possible.

It is well known that the only attempt to harmonise the doctrine of Free Will with the principle of the Conservation of Energy consists in supposing that living creatures have a power, by the mere exercise of their "will," of deflecting particles of matter within their bodies from their natural paths, without thereby altering the total energy of the particles.<sup>1</sup> This, therefore, it will be observed in the first instance, assumes a peculiar physical state of things to exist within the body of an animal which does not prevail elsewhere, or it supposes that the laws of nature have not a general application, but that the animal world must be made an exception. This at the very outset evidently involves a very questionable admission. My purpose is simply to point out that by taking into account a special consideration based on the evidence of modern physiology as to the functions of the brain, such an assumption as the above is rendered entirely superfluous, and that even if it could be supported it would still miss the main object in view.

Whatever room for speculation there may be as to the exact nature of the mental faculties, it is at least very generally admitted that these faculties are most intimately connected with or dependent on brain structure. Modern physiological research has at least placed this fact beyond question, or it is allowed that the mental faculties have at all events a physical side. From this it must follow therefore that what we call "identity," character, or individuality (as involved in "mind") must be dependent on the special structure of the brain; indeed this view is so widely prevalent that it becomes almost superfluous to insist upon it. Now it may be safely assumed that no upholder of Free Will would wish for more than that a person should act in strict accordance with his identity or individuality, for the object of Free Will certainly is not to annihilate individuality (or those personal traits which constitute character). But is not this precisely what would occur if this contention for a mysterious power of deflecting particles within the body could be carried out? for the effect of this contention would be to make the brain superfluous as a directing mechanism, which would be tantamount to abolishing it (together with the individuality, of

<sup>1</sup> The necessity for this special assumption, in order to prevent Free Will from coming into direct collision with the principle of the Conservation of Energy, is so obvious that it will probably be regarded as superfluous to give references to particular authors.

which it is the seat). For where would be the use of the elaborate mechanism of the brain for directing the movements of the body by it?

This

identity is bound up, the empty nothing "volition." In that the brain directs the corporeal movements; the identity, or that which constitutes the very essence of individuality, thereby directs. What more would we have? Attempt to supplant the brain by the vague notion "volition," and the individuality ceases to exist; or that very end is attained which those who support Free Will most wish to avoid.

From the very fact that the brain is *known* to exist, it therefore should be perfectly conceivable (if not even *a priori* a natural conclusion) that the brain might be a mechanism competent to regulate all the motions of the corporeal system (for a set of dynamical conditions adapted to any effect is conceivable). In view of this, does not the assumption of this mysterious "deflecting power" seem all the more unwarrantable, or even absurd; as if it were imagined that the brain, being already there to direct the corporeal movements, something additional were necessary to direct the brain, or as if it were supposed that [the brain being the seat of the identity] something besides the identity were required to direct the actions of the body? This would seem to be no more than a specimen of the kind of incongruities which may be expected to present themselves by any attempt to evade physical principles.

It could not, however, be said that the opposite party were entirely free from error. For there appears to have been a notable oversight on the side of those who uphold strict Causal Sequence in nature (sometimes called "Necessity") in failing to appreciate adequately the important influence (on the question of Free Will) of the fact that the brain is the seat of individuality, as above insisted on. For the omission to give due import to this fact has naturally made strict Causal Sequence to appear as a sort of grinding process, whereby man's actions are determined *independently* of his individuality; a view which is no doubt repulsive, and may have served as some excuse for the invention of the curious device of deflecting particles by the "mind" or "will." It will be observed, however, that by simply substituting the word "brain" (which includes "mind") for the word "mind" in the foregoing sentence, a deflection of particles of matter (represented by the direction of material operations by the brain) then can take place in accordance with and not in opposition to the laws of nature. For from the very fact of the brain substance forming part of the material universe it must of course influence and direct material operations in conformity with natural causes.

Could it be justly said that there is any *compulsion* in this? Can there be compulsion in being obliged to act in accordance with one's individuality or identity (determined by brain structure), since the only conceivable escape from this would be to act *in opposition* to one's identity (scarcely a desirable end)? But, it may be argued, there is still some coercion left here, because, although brain structure may be the seat of individuality or "mind," nevertheless, since our brains were originally formed by the operation of causes beyond our control, there is coercion in this aspect of the case. But then do even the most ardent supporters of Free Will ever dream of upholding the expectation that an individual should have a control in the original formation of his brain? or do they not concede (and rightly) that the ideal of Free Will is that an individual should act in strict accordance with (and not in opposition to) his own identity? Yet this is precisely what the believer in strict Causal Sequence, who has a just appreciation of the functions of the brain, will maintain must necessarily occur. Solely in virtue of the fact that there is strict Causal Sequence in nature are the actions brought into strict conformity with individual brain structures (or with identity). If the principle of dynamics were not rigid, or if the laws of nature were liable to alteration, a man's actions might sometimes be in harmony with his brain structure, sometimes in discord with it; or any number of

<sup>1</sup> Does it not seem a violation of principle, or a kind of inconsistency, to recognise that the brain does, in fact, direct certain motions of the corporeal system (and even those of a complex character, such as the digestion of the food, the circulation, &c.), and yet to assume that the brain would be incompetent to direct *all* the motions of the body? It may be said that a reasoning process accompanies the direction of some of these motions, but not others. But then is not reasoning itself a brain process, or is it not universally admitted that the reasoning faculty (whatever its exact nature) is at least connected with the brain, or has a physical side, just as, indeed, the mental faculties generally (or "mind") could not exist without brain?

persons, though possessing totally different brain structures, might act identically. The questionable expediency of the proceeding of those who are disposed to grumble at what they term the "iron" laws of nature, becomes apparent here.

But is it not, after all, more satisfactory to look to a definite physical basis for identity or individuality, as dependent on the magnificent mechanism of the brain, in preference to the superficial view of ignoring all this? No doubt there have been misunderstandings on both sides of this Free Will *v.* Necessity question.—The Free Will party, failing to appreciate justly the sequence of cause and effect; the Necessitarians, on the other hand, omitting to realise fully the important bearing of the relation of individuality to brain-structure on this question. No logical ground could be given why a complete agreement should not be possible on this subject. For there can evidently be but *one* correct view on any subject or question whatever. Moreover, from the very fact of the fundamental character of this question, it would follow necessarily that the wrong view on this subject must involve a great error, which, therefore, could hardly escape detection under a careful analysis. The divergence of views here is, however, no doubt more apparent than real. For if Free Will may be justly regarded as the freedom to act in accordance with identity (or as the assertion of individuality), then such freedom of will actually exists, and moreover the very condition for its existence is seen to be the prevalence of that strict Causal Sequence in nature demanded by the Necessitarians. Thus the two views would show themselves capable of reconciliation on a common basis. That this fact should have apparently hitherto escaped appreciation may possibly be to some extent due to that spirit of partisanship which has so largely entered into this question, whereby the judgment may be allowed to be unconsciously biased, so that in some cases, instead of searching impartially as to what *is* truth, the inquiry has perhaps rather been as to what *ought* to be truth.

Londo.]

S. TOLVER PRESTON

#### Curious Botanical Phenomenon

ABOUT a fortnight ago I noticed a curious phenomenon in a wood near Leyland, Lancashire. The ground was strewn with a layer of about eight to ten inches of old sodden leaves, covered at the surface by dry withered ones. A quantity of hyacinths (not yet in flower) were growing on this ground, and many of the plants had pierced through the withered leaves to the extent of from half an inch to three inches, carrying them up above the general surface. Some of the hyacinths had in this way penetrated through more than half a dozen withered leaves, and here and there several plants were gathered together at their tops by a number of old leaves, through which they had conjointly grown.

The question arises as to whether the hyacinth shoots had pierced through the withered leaves on first issuing from the ground, when the dead leaves were soft and wet, and so lifted the latter to the surface where they became dried, or whether they had actually pierced through the dry leaves on the surface.

M. F.

#### Carboniferous Forest at Oldham

IT may perhaps be interesting to the readers of NATURE to know that here at Oldham we have recently laid bare a fine sample of a carboniferous forest. We are here, as you are aware, situated on the middle coal-measures, Oldham Edge (800 feet) being the highest outcrop of that series.

I have been watching with increasing interest during the past eighteen months the progress of disinterment. For some time at the commencement the trees occurred at considerable intervals of time, but of late they have turned up more frequently, scarcely a day now passing without one or more being unearthed. They are, I am sorry to say, highly perishable, and if the necessities of the works did not require their removal they would all disappear during a single winter if exposed to the weather.

The result of the combined action of the two great faults that cross Oldham in a direction parallel to each other has been to throw up to the surface several seams of coal and beds of shale and sandstone.

On the eastern escarpment of the "Edge" a quarry has been dug in the argillaceous shale above what is here known as the "Bent Mine," in order to make bricks of the extracted materials. In quarrying this bed the trees have been laid bare in considerable numbers. Some of them show the characteristic

markings of *Sigillarise*, longitudinal flutings and the usual leaf-scars, stigmarian roots and rootlets attached, &c., others not so well preserved, being of doubtful affinities. Of course they are now but casts, nothing remaining of the original trees except a thin film of coaly matter representing the bark. They measure in height from three to ten feet, and have a diameter of from one foot to two feet four inches. I think it may be safely stated that they were merely hollow stumps when finally submerged, fronds of ferns, lepidodendroid twigs and leaves, and other vegetable waifs having found their way into the hollow cylinders and left their impress on the inclosed matrix.

I may add that there are several horizons of growth, one forest having grown above another; stigmarian roots and rootlets, calamites, lepidodendroid stems and leaves, lepidostrophi, and masses of leaves of unascertained species being indiscriminately mixed throughout the whole section, the ferns, however, being met with in greatest numbers near the bases of the erect trees.

It is perhaps worthy of remark, too, that there is no accumulation of coaly matter in the section revealed, nor is there any of the usual "floor clay" about the roots of the trees.

29, Radcliffe Street, Oldham

JAS. NIELD

#### Fungus Inoculation for Insects

THE importance attributed by Dr. Lankester (*NATURE*, vol. xxi, p. 448) to "Prof. Metschnikoff's suggestion of a deliberate cultivation of an insect's-disease-producing fungus, and the application of the cultivated fungus in quantity to places infested by these insects," invites attention to the fact that the suggestion has been anticipated in a very serious and earnest way by my friend the distinguished entomologist, Dr. John L. Le Conte of Philadelphia, in his presidential address before the Portland meeting of the American Association for the Advancement of Science, in August, 1873.

His address concluded with ten suggestions for the promotion of economic entomology in the United States, and the seventh reads thus:—"Careful study of epidemic diseases of insects, especially those of a fungoid nature; and experiments on the most effective means of introducing and communicating such diseases at pleasure."

The reasons for making this suggestion are fully stated in the preceding paragraphs of the address, where the observations on which it is based are detailed.

Dr. Le Conte's first suggestion was, "Reorganisation of the Department of Agriculture [at Washington] on a scientific basis, for the proper protection and advancement of agricultural interests." Had this suggestion received the attention which has been given to many other subjects of less practical importance, the present reclamation for him of priority in the case of his seventh suggestion, would probably have been rendered unnecessary; and the credit of introducing a more reasonable method of extirpating insect-pests than the dangerous plan of distributing potent mineral poisons to careless or uneducated persons for use in the fields, would have been secured to the nation to which we have the honour to belong.

Dr. Le Conte's address may be found in the published volume of the *Proceedings* of the Portland meeting; but it was reprinted by him and extensively circulated and favourably commented upon at the time, his desire being precisely that so well expressed by Dr. Lankester "to do something to persuade 'practical' men that all science is deserving of their respect and encouragement." We all hoped that such earnest words from so high an authority would have their due effect upon Congress and inaugurate a long-desired reform of our Agricultural Bureau. But it has happened, as in so many other instances, that we have had to wait seven years before even an echo reaches us from a distant part of the world, where the labours of Prof. Metschnikoff have procured an intelligent appreciation of the value of Dr. Le Conte's suggestion, so little comprehended by the powers at home.

J. P. LESLEY

1,008, Clinton Street, Philadelphia, April 10

#### Carnivorous Wasps

A SERIES of letters, under the above heading, have appeared in *NATURE* for several weeks past. The facts they contain, although interesting in themselves, are nothing new to entomologists. That wasps are carnivorous, that they chase flies,

&c., was known long ago (compare Westwood's "Intro. to Entomol.," ii, p. 246). That wasps cut off the wings of flies before sucking them was observed by Dr. Erasmus Darwin in the last century (see J. H. Fabre, "Souvenirs Entomologiques," Paris, 1879). AN OLD ENTOMOLOGIST

Heidelberg, Germany, May 6

#### Seeing by Telegraphy

WE beg to thank Mr. Gordon for drawing attention to the fact that the principle of rotation of plane of polarisation of light in a magnetic field could not actually be employed with the form of receiver symbolically described by us in *NATURE*, vol. xxi, p. 589. Having satisfied ourselves that there could be no doubt of the feasibility of using the first form of apparatus, which we spoke of, as a receiver in a sight telegraph, we merely wished to point out, at the end of our letter, that other methods might perhaps be employed; and we still have no doubt that with a certain proper arrangement of the apparatus not only the effects observed by Dr. Kerr, but other of the Faraday polarisation of light effects might be practically made use of. For it must be remembered that the actual electric currents now used to transmit articulate speech are only one forty-millionth per cent. as strong as those necessary to work even a delicate telegraph relay, whereas it required several Grove's cells to show in a decided way the old experiment of the sound emitted by an iron bar on being magnetised.

And in fact we may go further, and mention that we have for the last year, or more, held the view that just as all electric conductors turn into heat energy a portion of the energy they transmit as electric current, so there must be some bodies, presumably of the sulphur selenium order, which, when properly employed, will convert a portion of the current energy into visible luminous vibrations, and may therefore be used as receivers in a sight telegraph.

As to the other objection that might have been made to the method as popularly described by us in consequence of the large number of wires, we need hardly mention that in practice a telegraph engineer would avail himself of the principles of multiple telegraphy.

May 3

JOHN PERRY  
W. E. AYRTON

#### Anchor-Ice

IN confirmation of Mr. Rac's views upon this subject, the following results of observations made upon the Charles River, Mass., may be of interest.

Anchor-ice is usually formed at night during a sudden "cold snap," when the river is not covered with surface-ice. It seems to consist of small masses of needle-like crystals grouped in stellate forms, and distributed pretty evenly throughout the body of water.

These adhere readily to any obstruction, and accumulate rapidly upon it. Thus the racks or strainers through which the water passes to the mills are covered and closed by it, so that the flow of the water is absolutely stopped, and the mills can only be kept running by constantly removing it with a rake.

It is very adhesive and tenacious. I have frequently seen it accumulate upon portions of the extreme edge of a mill dam (over which was pouring water a foot in depth) until it reached the surface, resisting for a considerable time the enormous pressure to which it was thus subjected. It usually disappears soon after sunrise.

Detached portions of the accumulated masses always rise to the surface, but the original crystals, if not heavier than water, seem to be at least as heavy. The general appearance of this ice when removed from the water resembles that of sherbet or "water ices." As these are frozen quickly while in motion, they are apparently formed under similar conditions. I have never seen anchor-ice except in rapid currents.

Boston, U.S.A., April 24

C. F. C.

SODIC CHLORIDE CRYSTALS.—Dr. Ord refers Dr. Ralton to Dr. Beale's book on "Kidney Diseases, Urinary Deposits, &c.," ed. 1869, p. 167, and the figure at p. 130; also Thudichum's "Pathology of the Urine."

OXONIENSIS.—Apply to the Secretary, British Association, Albemarle Street, W.

**FURTHER OBSERVATIONS AND RESEARCHES  
ON FLEUSS'S SYSTEM OF DIVING AND  
LIVING IN IRRESPIRABLE ATMOSPHERES<sup>1</sup>**

YOU will find in NATURE, vol. xxi. p. 62, the experiments I made in relation to the process of living under water by means of the Fleuss apparatus. I there related what I had observed after Mr. Fleuss had been under water at a very low temperature for the period of an hour. A few days later I made another observation on a different plan. I filled the large diving bell at the Polytechnic with carbonic acid gas, displacing every portion of air. I then let the bell go down ten inches under the water, so as to put the gas under pressure, and all the while I kept a stream of gas pouring into the bell, and causing a constant bubbling of gas out of the mouth of it into the water. This done, Mr. Fleuss put on his dress and helmet and entered the bell. He sat in it over the water for the period of twenty minutes, the pressure and constant stream of gas being maintained. At the end of twenty minutes I signalled to him to come out, and had the bell brought round to the side of the tank. He returned into the air quite unaffected. His pulse, which was beating at 72° in the minute when he went in, was at 68° when he came out, and quite steady. His temperature in the mouth, which was at 98·2° F. when he went in, was at 97·5° when he came out, and in a few minutes was at its natural standard. He said he had felt no oppression whatever, and would have remained an hour in the gas if I had allowed him.

While the diving-bell was still charged with a large volume of carbonic acid gas I got Mr. Fleuss to go into it again, and then volatised into the bell vapour of amyl hydride until I had made an utterly irrespirable atmosphere from that vapour alone. In this way I formed an atmosphere which closely resembled the atmosphere of the mine charged with choke-damp, except that the vapour I used is more determinate in its narcotising action than choke-damp. In this mixed atmosphere, in which a man unprotected would have been absolutely unconscious in less than a minute, Mr. Fleuss remained for twenty minutes. At that time he came out of the bell in the most perfect condition, in a word, altogether unaffected.

The principle of the Fleuss system is very simple. Within the helmet, which is of the usual shape of a diver's helmet, there is a space equal to a quarter of a cubic foot inclosed in metal. This space is charged with oxygen under pressure, the compression giving a supply of the gas sufficient to last for a period of five hours if necessary. As a rule Mr. Fleuss charges for three hours under a pressure of about eight atmospheres. This is his supply of vital air. In the cuirass, which is the next part of the apparatus to be described, he has two metal cases, one in front, the other at the back. These cases are filled with small pellets of porous india-rubber charged with caustic soda. Over this surface of soda he can exhale his breath with perfect freedom, and at the lower part of each case he has a small trough under a perforated bottom, in which the water of the breath, condensed in passing, is caught. Lastly, he has a double-valved mouthpiece, made almost exactly after the plan of the late Dr. Sibson's chloroform mouthpiece, to which is attached a large elastic artificial trachea, or windpipe.

These are the effective parts of the apparatus. The other parts, common to the diver's dress, are the waterproof jacket and leggings and weighted boots.

In preparing for his work Mr. Fleuss proceeds as you will see (for he will go step by step through the process of assuming his dress). He first charges his helmet with oxygen. He does this from one of Orchard's compressed oxygen bottles, measuring the pressure by a pressure-

gauge. This ready, he puts on the cuirass and the waterproof dress. Then he ties firmly over his mouth and nostrils the double-valved mouthpiece, and connects the free end of the artificial windpipe with a tube leading into the soda-chamber in front of the cuirass. Finally he assumes the helmet, and when that is on and closed he is complete.

The mode in which he lives in this closed dress is as follows:—By a valvular opening he lets into the helmet from the compressed store of oxygen a stream of oxygen, which diffuses into the space between the helmet and cuirass and his body—his breathing- or air-space. When he inhales through the mouthpiece he draws in the oxygen through the two side valves into his lungs. When he exhales, those valves close, and so his exhaled breath passes through the tube and over the soda in the soda-chambers, and down the chamber in front along a connecting tube into the lower part of the chamber at the back; then, ascending through that chamber, it escapes *in part* into the helmet by a tube from the back chamber near the shoulder. In its passage through these two chambers all the carbonic acid of the breath is fixed by the soda, and most of the water is condensed in the troughs. The return oxygen and the nitrogen of the expired breath passes over free and enters the helmet, where it meets and admixes, by diffusion, with the oxygen which is admitted from the oxygen reservoir.

Thus there is constantly being made within the dress a fresh supply of air for respiration, while the product of respiration and of animal combustion—carbonic acid—which would be dangerous if it were not removed, is removed and fixed by the soda.

Mr. Fleuss relies on two practical indications for supply of the oxygen from the reservoir. If he feels any undue pressure on the drums of his ears he knows that there is too much oxygen in the helmet. If he feels any sense of suffocation he knows that the oxygen is deficient. In the first instance he stops the entrance of oxygen for a short time; in the second case he lets in a further supply.

It must be admitted that this plan is not one that ensures a due admixture of oxygen and of nitrogen according to the atmospheric formula, and there can be no doubt that he is always breathing, while in his dress, an excess of oxygen. This fact opens up the question once more of pure oxygen as a supporter of natural life.

In my experiments on this subject reported to the British Association for the Advancement of Science in 1860, I showed that oxygen supplied in steady current from a fresh source, and not breathed many times over again, would support life readily enough for long periods of time—extending in one experiment to three weeks—at a medium temperature; but that at a low temperature, 35° F., it became negative, so that animals went to sleep in it and became cold; while at a high temperature, 75°, they became heated in it, underwent rapid wasting, and ate voraciously.

In another paper, published in 1869, I tried to prove that the use of nitrogen in the atmosphere is not to act as a mere diluent and economiser, but as an equaliser of the temperature, and so to make the combination of oxygen with the blood and the tissues equable in the different regions of the globe.

Mr. Fleuss's experiments are in entire accord with these views. He can live, with oxygen in excess, for long periods in medium temperatures. In a cold temperature his own heat goes down several degrees below the standard. In a high temperature he would become overheated. But between a range of 35° F. on the one side and 75° F. on the other he is, in my opinion, safe in his closed oxygenated chamber. Whether he can descend to the same depths as other divers—say to 86 feet—and remain there, has to be proved. Theoretically, he ought to be able to do so, but in this field of inquiry he must

<sup>1</sup> Abstracted from lecture delivered to the Society of Arts on Thursday, May 8.

win his spurs. The lowest depth to which he has descended is 25 feet. He has walked under water a distance of four hundred yards in a straight line.

Some improvements may be made in the arrangements. He might be supplied with a feeding-apparatus, and so remain under water several hours longer than he has done. At present he finds from two to three hours no difficulty.

The experiments I have made with the apparatus indicate that the dress and apparatus may be used for entering wells, burning houses, and mines that are charged with suffocating gases. In the mine the dress would be invaluable, and if a telephonic connection could be set up between the man in the dress and the outside world—an adaptation I believe to be quite possible—a remarkably useful advance would be made.

I will now ask Mr. Fleuss to make one experiment which will be a visible exposition of the perfection of his apparatus as he stands equipped in it. The directors of the Royal Institution have been so good as to lend me the glass chamber in which Prof. Tyndall experimented when he was demonstrating the mask he invented for breathing in an atmosphere charged with dense fumes of smoke. This chamber I have had charged with carbonic acid, so that it has in it an irrespirable atmosphere. In it, as you will see, a candle cannot be lighted, and a taper will be extinguished. Mr. Fleuss will go into the chamber, sit down in it, and wait there until the current of carbonic acid which is being admitted forms an absolute atmosphere of the gas to above the level of the top of his helmet, and there he will remain, if we like, until the supply of oxygen in the helmet is exhausted.

The next step onward will be to construct a small closed canoe, in which the apparatus can be fitted on a larger scale, and in which men, or those who are in the canoe, can rise or sink in the water and be propelled under the water. This is a certain extension of the system now under our consideration, and when it is completed, my idea that the next greatest geographical discoveries will be made on the floors of the great oceans may not be so far wide of the mark as was once supposed.

B. W. RICHARDSON

### THE AURORA BOREALIS<sup>1</sup>

OUR experiments on the electric discharge, which have been already published in the *Phil. Trans.* and the *Proceedings* of the Royal Society, enable us to state with some degree of probability the height of the aurora borealis when its display is of maximum brilliancy, and also the height at which this phenomenon could not occur on account of the great tenuity of the atmosphere.

In Part III. of our electric researches, *Phil. Trans.*, Part I. vol. 171, we have shown that the least resistance to the discharge in hydrogen is at a pressure of 0.642 millim., 845 M; after this degree of exhaustion has been reached a further reduction of pressure rapidly increases the resistance. When the exhaustion has reached 0.002 millim., 3 M, the discharge only just passes with a potential of 11,000 chloride of silver cells (11,330 volts); at the highest exhaust we have been able to obtain (and which we believe has not been surpassed), namely, 0.00055 millim., 0.066 M, not only did 11,000 cells fail to produce a discharge, but even a 1-inch spark from an induction-coil could not do so.

Although we have not experimentally determined the pressure of least resistance for air, we have ascertained that while the discharge occurs in hydrogen at atmospheric pressure between disks 0.22 inch distant, they

require to be approached to 0.13 inch to allow the discharge to take place in air. We may therefore assume that the pressure of least resistance for air is

$$\frac{0.642 \times 13}{22} = 0.379 \text{ millim., } 498.6 \text{ M.}$$

At a height of 37.67 miles above the sea level, the atmosphere would have this pressure (neglecting change of temperature), and therefore the display at this elevation would be of maximum brilliancy and would be visible at a distance of 585 miles.

The greatest exhaust that we have produced, 0.00055 millim., 0.066 M, corresponds to a height of 81.47 miles, and as 11,000 cells failed to produce a discharge in hydrogen at this low pressure, it may be assumed that at this height the discharge would be considerably less brilliant, especially in air, than that at 37.67 miles, the height of maximum brilliancy.

At a height of 124.15 miles the pressure would be only 0.0000001 millim., 0.00001 M, and it is scarcely probable that an electric discharge would occur with any potential conceivable at such a height.

The colour of the discharge varies greatly with the tenuity of air or other gas with the same potential. Thus in air at a pressure of 62 millim., 81579 M, the discharge has the carmine tint which is so frequently observed in the display of the aurora; this corresponds to an altitude 12.4 miles, and would be visible at a distance 336 miles. At a pressure of 1.5 millims., 1974 M, corresponding to a height of 30.86 miles, the discharge becomes salmon-coloured, having completely lost the carmine tint. At a pressure of 0.8 millim., corresponding to 33.96 miles, the tint of the discharge is of a paler salmon colour, and as the exhaust is carried further it becomes a pale milky white. The roseate and salmon-coloured tints are always in the vicinity of the positive source of the electric current, the positive luminosity fades away gradually, and frequently becomes almost invisible at some distance from its source; as, for instance, in the hydrogen discharge at a pressure of 2.3 millims., 3027 M, shown in the accompanying figure, H, which resembles in some



respects the phenomena of the aurora. The discharge at the negative terminal in air is always of a violet hue, and this tint in the aurora indicates a proximity to the negative source.

The following table, [with] the exception of pressure

<sup>1</sup> "On the Height of the Aurora Borealis." Paper read at the Royal Society. By Warren De La Rue, M.A., D.C.L., F.R.S., and Hugo W. Müller, Ph.D., F.R.S.



0'00000001 millim., exhibits deductions from actual observations:—

Pressure mm.	Pressure M.	Height miles.	Visible at miles.	Remarks.
0'00000001	0'00001	124'15	1061	No discharge could occur.
0'000055	0'066	81'47	860	Pale and faint.
0'379	499 0	37 67	585	Maximum brilliancy.
0'800	1053'0	33'96	555	Pale salmon.
1'000	1316'0	32'87	546	Salmon coloured.
1'500	1974'0	30'86	529	" "
3'000	3947'0	27'42	499	Carmine. "
20 660	27184'0	17'86	403	" "
62'000	81579'0	12'42	336	" "
118'700	156184'0	11'58	324	Full red.

It is conceivable that the aurora may occur at times at an altitude of a few thousand feet.

The following letter has been sent us in reference to the above paper:—

*Meteorological Office, 116, Victoria Street,  
London, S.W., May 1, 1880*

With reference to a paper at the Royal Society on the height of auroras by Dr. De la Rue and Dr. Müller, the following remarks in Müller's "Lehrbuch der kosmischen Physik," 2nd Edition, 1865, p. 558, may be of interest to your readers:—

"Hansteen finds for the aurora of January 7, 1831, a height of 26 geographical miles, by combining the height of the arch at Berlin and Christiansand in Norway, while Christie calculates the height of the same aurora at between 5 and 25 English miles, from observations made in England.

"The determinations of modern physicists place the aurora at a much lower level than was formerly assumed. Mairan gave the mean height at 120, Cavendish (1790) at 60, and Dalton (1828) at only 18 geographical miles.

"Farquharson makes it probable that the auroras, as was already said by Baron v. Wrangell, come down to the region of the clouds. He bases this, *inter alia*, upon the auroral observations of December 20, 1829. At Alford, in Aberdeenshire, he saw, from 8.30 to 11 o'clock in the evening, a very brilliant aurora over a thick mass of clouds which covered the hills lying to the north of his house. Although the sky was clear the aurora never rose higher than 20°. At the same time the Rev. Mr. Paull, at Tullynessle, lying two English miles north of Alford, in a narrow side valley of the hills above mentioned, saw a very brilliant aurora close to the zenith about 9.15. This would give the height of the aurora as not more than 4,000 feet. This opinion is confirmed by numerous observations made in the Polar regions by Parry, Franklin, Hood, and Richardson. Franklin observed auroras between the clouds and the earth, which lit up the lower surface of thick clouds.

"So much is certain, the phenomenon appears in various heights, but can hardly be seen higher than twenty miles. The auroras formed at low heights, which are often seen in the Polar regions, are only visible at short distances. Hood quotes an aurora on April 2, 1820, at Cumberland House, as a brilliant arch of 10° altitude. Fifty-five English miles to the south-west nothing was visible.

"Another aurora on April 6, which remained in the zenith for some hours over Cumberland House, appeared at the distance of 100 English miles to the south-west as a steady arch only 9° in height."

The observation of Mr. Smith of Jordan Hill, at Loch Scaivaig in Skye, of an aurora apparently emanating from a mountain there, will also be remembered.

ROBERT H. SCOTT

## A SCOTTISH CRANNOG<sup>1</sup>

### II.—Objects of Bone

UPWARDS of twenty implements made of bone have been added to the general collection, all of which were found either in the relic bed or refuse heap. The following are the most interesting.

1. Two chisels or spatulæ. One is made of a split portion of a shank bone, and measures 5½ inches long



FIG. 6.—Bone (Scale ¼.)

FIG. 7.—Bone (Scale ½)

and rather less than ½ inch broad. It is very hard, flat, and smoothly ground at one end, and has a sharp rounded edge, which extends farther on the left side, thus indicating that it was adapted for being used by the right hand. The other is a small leg bone obliquely cut so as to present a smooth polished surface. Its length is 4 inches, and its diameter ½ inch.

2. Five small objects presenting cut and polished surfaces, three of which are sharp and pointed; one



FIG. 8.—Horn (Scale 1).



FIG. 9.—Horn (Scale 1).

appears to have been notched at the end and there broken off; and the last, presenting well-cut facets, is fashioned into a neat little wedge.

3. Fig. 6 represents a tiny little spoon only ¾ inch in diameter, and worn into a hole in its centre. The handle portion is round and straight, and proportionately small,

<sup>1</sup> A full report of the Lechlee Crannog is given in vol. xiii. of the *Proceedings of the Society of Antiquaries of Scotland*, and in vol. ii. of the *Collections of the Ayrshire and Wigtownshire Archaeological Association*. Continued from p. 16.

being only 2 inches long, and about the thickness of a crow-quill.

4. Fig. 7 is a drawing of a neatly-formed needle-like instrument. It is flat on both sides, finely polished, and tapering into points at its extremities.

5. Two curious implements smoothly polished and forked at one end. They are both about 5½ inches long, and precisely similar to each other in every respect.

6. A great many small ribs, about 6 or 7 inches in length, and portions of others, were found to have the marks of a sharp cutting instrument by which they were pointed and smoothed along their edges. The use of these implements can only be conjectured.

7. Lastly, there are several portions of round bones

which appeared to have been used as handles for knives or such like instruments.

III.—Objects of Horn

About forty portions of horn, chiefly of the red-deer, bearing evidence of human workmanship were collected during the excavations. They consist of hammers or clubs, pointed tynes, spear-heads, &c. As illustrations of these implements, Figs. 8 and 9 are good representations of a club and a bodkin. The former is 11 inches long, and has about 3 inches of the brow branch of the horn projecting from it, round the root of which there is a groove, as if intended for a string. The markings on the back portion indicate very distinctly that it was used

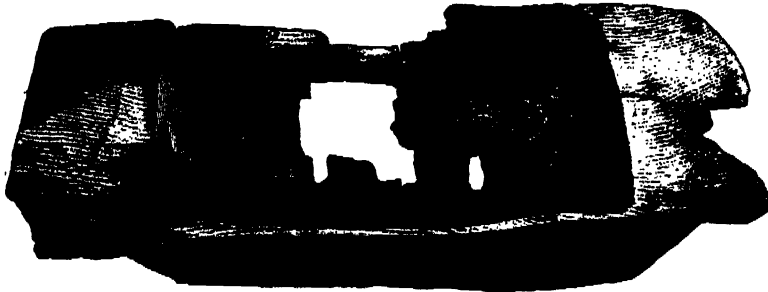

FIG. 10.—Wooden Vessel (Scale ½).

for hammering some hard substance; the latter is 8 inches long, finely polished all over, and pointed at the tip as if with a sharp knife.

IV.—Objects of Wood

A large assortment of wooden implements was found, chiefly in the refuse heap, and in the portion of *débris* corresponding to the area of the log pavement. Owing to the softness of the wood and the large amount of moisture contained in its fibres, most of these relics have already shrunk to less than half their original bulk, and become so changed, though they were kept in a solution of alum for several weeks, that I am doubtful of being able to preserve them at all. They consist of bowls, plates, ladles, a mallet, a hoc, clubs, pins, &c., together with many objects entirely new to me, but which apparently had been used for culinary or agricultural purposes.

Fig. 10 represents a trough cut out of a single block of wood. It was found about half way between the margin of the crannog and the circle of stakes surrounding the log pavement at a depth of 5 feet, amongst decayed brush-wood and chips of wood.

*Canoes.*—During the progress of the drainage a canoe, hollowed out of a single oak trunk, was found about 100 yards north of the crannog. Its depth in the cross was well ascertained, owing to the fact that, though lying at the bottom of one of the original drains, it presented no obstruction to the flow of water, and consequently was then undisturbed. During the recent drainage all the drains were made a foot deeper, and hence its discovery. It measures 10 feet long, 2 feet 6 inches broad (inside), and 1 foot 9 inches deep. The bottom is flat, 4 inches thick, and contains nine holes, arranged in two rows and about 15 inches apart, with the odd one at the prow. These holes are perfectly round and exactly 1 inch in diameter, and when the canoe was disinterred they were quite invisible, being all tightly plugged.

When the original drainage was made, some forty years ago, I understand that two canoes, each of which was about 12 feet long, were found in the bed of the lake on the south-west side of the crannog.

A double-bladed oak paddle, 4 feet 8 inches long and 5½ inches broad, and a large oar, together with the blade

portion of another, were found amongst the *débris* on the crannog.

—Objects of Metal

(a) The chief articles made of iron are the following:—

1. A gouge, 8 inches long.
2. A chisel, 10 inches long. Both these tools had remains of bone or horn handles containing beautiful green crystals of vivianite.
3. Two knives. One has a blade 6 inches long, and a pointed portion for being inserted into a handle. It was found on a level with, and close to, the lowest hearth, along with fragments of its handle made of stag's horn. The other, found by a farmer in the *débris* long after it was thrown out of the trenches, was hafted on a different

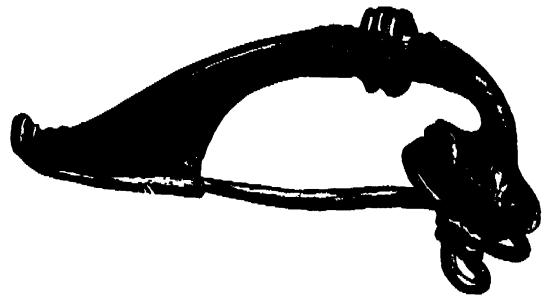

FIG. 11.—Fibula (Full size).

plan from the former, the end portion being broad, and riveted to its handle by four iron rivets, which still remain.

4. Two spear-heads, one prominently ridged, 13 and 9½ inches, with sockets for wooden handles, portions of which still remain in the sockets.

5. Five daggers. One has portion of a bone handle surrounded by a brass ferrule, and about an inch in front of this the corroded remains of a guard are seen.

6. A saw in three pieces, two of which were joined when found, and the third was lying a few feet apart. The length of the three portions together is 38 inches, and the average breadth is 3 inches.

7. A small corroded iron hatchet, with portion of a wooden handle in the socket.

8. A curious three-pronged implement was found, about 3 feet deep, in the large drain a few yards to the south of the crannog; the prongs are curved, very sharp at the points, and attached laterally; they are  $2\frac{1}{2}$  inches apart, and  $\frac{1}{4}$  inches long.

(b) Of articles made of bronze or brass, the following may be noted:—

1. Two fibulae—one of which is figured here (Fig. 11)—were found about the centre of the refuse heap, and a third, much more elaborately ornamented, was subsequently found in the *débris* when closing up the trenches.

2. A bronze ring pin, 6 inches long. The square-shaped portion of the top has a different device on each side, one of which is a fylfot (croix gammée or swastika), and the shank from its middle to the point is ornamented on both sides (Fig. 12).

3. A spatula or dagger-shaped implement with blunt edges, measuring  $11\frac{1}{4}$  inches long and  $1\frac{1}{2}$  inch broad.

4. A thin spiral finger-ring.



FIG. 12.—Bronze Ring Pin (Scale  $\frac{1}{2}$ ).

FIG. 13.— $\frac{1}{2}$  size. Made from stems of a moss (*Polytrichum commune*).

5. A bridle-bit. This consists of two large rings and a centre-piece. Its extreme length is  $10\frac{1}{2}$  inches; the outer diameter of the rings is rather less than 3 inches, and the centre-piece, which is entirely made of iron, is  $3\frac{3}{4}$  inches long. The rings are partly iron and partly bronze, the circular portion being iron, and the rest bronze. The bronze portion has two eyes or loops, one of which is attached to the centre-piece and the other free. This interesting relic was turned up by two visitors poking with a stick at the south-east corner of the refuse heap.

#### VI.—Miscellaneous Objects

1. *Carved Wood*.—Perhaps the most interesting of all the relics discovered on the crannog is a small piece of ash-wood, about 5 inches square, having curious diagrams carved on both sides. On one side three equidistant spiral grooves, with corresponding ridges between, start from near a common centre and radiate outwards till they join, at uniform distances, a common circle which surrounds the diagram. On the other side is a similar diagram, with this difference, that between the points of commencement of the spiral grooves there is a space left which is occupied by a small circular groove surrounding

the central depression or point. This figure is surmounted and overlapped by two convoluted and symmetrical grooves meeting each other in an elevated arch, with a small depression in its centre. The relic was found on the west side of the crannog, about 4 feet deep, and near the line of the horizontal raised beams.

2. *Fringe-like Objects*.—Another object which has excited considerable curiosity is an apparatus made like a fringe by simply plaiting together at one end the long stems of a kind of moss. Portions of similar articles were found in three different parts of the crannog, and all deeply buried. The one figured here, and the most neatly formed, was found in the relic bed near the hearths (Fig. 13).

3. Among the remaining articles under this head are to be found some portions of leather, one thick bit being pierced by stout copper nails; a few glass beads and small rings made of bone; some fragments of pottery, one being the bottom of a jar, said to be Samian ware; portions of three armlets made of jet or lignite, together with one or two other fragments of objects made of the same material.

According to a report by Prof. Rolleston of Oxford, who kindly undertook the examination of the bones and horns collected on the crannog, the following animals have their skeletons represented:—The ox (*Bos longifrons*); the pig (*Sus scrofa*, variety, *domestica*); the sheep, old dun-faced breed (*Ovis aries*, variety *brachyura*); the red-deer (*Cervus elaphus*), very abundantly; the roe-deer (*Cervus capreolus*), scantily, though unambiguously; the horse (*Equus caballus*) is represented by only one shoulder-blade; and the reindeer (*Cervus terandus*) by one or two fragmentary portions. Some of the bones and horns had their cavities filled with beautiful green crystals, which on analysis proved to be vivianite.

Among the specimens of wood used in the structure of the island Dr. Bayley Balfour has identified the following:—Birch, hazel, alder, willow, and oak. In addition to these some of the relics were found to be made of elm and ash.

ROBERT MUNRO

#### THE UNITED STATES WEATHER MAPS, AUGUST, 1878

THE most remarkable feature of the meteorology of the northern hemisphere for August, 1878, as compared with July preceding, was the enormous change which took place in the distribution of atmospheric pressure over the Atlantic as far as lat. N.  $60^{\circ}$ , the change being greatest in the region around Ireland and the south-west of England, where it amounted to a fall of about the third of an inch. Pressure was also still further reduced over nearly the whole of the United States, particularly in the north, the deficiency from the normal at New York being  $0.150$  inch. In Europe this lowering of the pressure extended eastward into Russia as far as long. E.  $40^{\circ}$ , where it rose to nearly the average. It again fell on advancing further eastwards to  $0.150$  inch below the normal in the valley of the Irish, rising however again to the normal over the western affluents of the Lena. Thus from the Rocky Mountains, across the United States, the Atlantic, Europe, and into Asia as far as the Lena, pressure was under the normal, in other words over a broad belt going half-way round the globe. This region of abnormally low pressure would appear to have stretched south-south-westward from Western Siberia, embracing the regions marked off by Syria, Egypt, Africa as far as Cape Colony, the Mauritius, Western India, and Turkistan. Also in Victoria, Tasmania, and New Zealand pressure was very low, being at Dunedin  $0.372$  inch less than the normal.

On the other hand, pressure was above the normal in the region of the Rocky Mountains, over South Greenland, Iceland, Farö, Shetland, and adjacent coasts of Norway;





about the normal over a limited patch of country lying to the north-west of the Caspian, and over the whole of Asia to the east of a line drawn through Ceylon, the Upper Ganges, and Lake Baikal, this latter area of high pressure extending as far south over Australia as Adelaide. Another area of high pressure spread from Central America eastwards across the West Indies, the north of South America, and the Atlantic to Africa.

In accordance with this distribution of pressure temperature was from one to two degrees above the normal in the United States, except in the north-east, where it fell to the average in the New England States, and fell still further to 1°6 below it at St. John's, Newfoundland. Under the influence of the low pressure around Ireland the Weather Map shows a prevalence of strong breezes from the Atlantic over Western, Central, and Eastern Europe as far as Kiev, and over the whole of this wide region temperature was above the normal, most notably so over Great Britain and the south of Norway, the mean at Mandal being 4°2 above the average.

Over England these Atlantic breezes were south-westerly, but in Scotland easterly. In England the month was one of the rainiest Augusts on record, and in the east of Scotland the rains were also unusually heavy. On the other hand, what invariably happens when the weather in the east of Scotland is characterised by rain and east winds, the weather of the West Highlands was dry and bright.

The comparatively insignificant region of higher pressure to the north-west of the Caspian, taken in connection with the markedly low pressure in Western and Central Siberia, exerted a striking influence on the weather of that region, since, owing to the northerly winds, which necessarily set in with stronger force than usual, temperatures fell to from two to three degrees below the normal from the Irish to the Dnieper. On the other hand, over Northern Asia, to the east of long. 75°, temperatures above the average prevailed, the excess at Irkutsk being 3°0. In Victoria, pressure being lower on the coast than in the interior, northerly winds set in, and under their influence the temperature of the colony rose generally to 1°5 above the normal. In New Zealand pressure was not only very low, but diminished greatly from west to east over the islands, and owing to the strong westerly winds which accompanied this distribution of the pressure, the temperature fell generally 2°5 below the average of this winter month.

THE IRON AND STEEL INSTITUTE

**F**OLLOWING close upon the Institution of Mechanical Engineers came the meeting of the Iron and Steel Institute. The bill of fare of the younger association was certainly longer, and will probably be found not less interesting, than that of its elder colleague. It contained eleven papers on subjects of practical importance connected with the nature and manufacture of iron and steel. All of these papers were valuable, five of them especially so, and they prove beyond a doubt that the Iron and Steel Institute is doing immense service to metallurgical science in collecting and systematising practical information, and in affording opportunities for the discussion of theoretical opinions.

It was naturally to be expected that the recent meeting would furnish some information as to the practical working and commercial success of the Thomas-Gilchrist process of producing Bessemer steel from inferior brands of pig-iron, and especially from those descriptions, like Cleveland pig, which are rich in the very deleterious ingredient, phosphorus. At the last spring meeting of the Institute this process was little more than an idea, but it was clearly seen that if it could be rendered a commercial success its influence on the future of the North-Eastern iron district of this country could not fail to be enormous.

Accordingly we are not surprised to find two papers on this subject, one by Messrs. Holland and Cooper, of Sheffield, entitled "On the Manufacture of Bessemer Steel and Ingot Iron from Phosphoric Pig," and the other by Mr. R. Pink, of the Hörde Works, Westphalia, "On the Dephosphorisation of Iron in the Bessemer Converter." From these two papers we learn the most recent results of British and German experience, and it must be deemed a matter of great congratulation that in both countries much good progress seems to have been made in the practical working of the new process.

The difficulties encountered were only such as are always encountered in the introduction of any new method. The first of these minor troubles experienced in Sheffield was to find out the right moment when to stop blowing. "It seemed doubtful whether it would be practicable (having no definite point at which we could safely stop blowing, corresponding to the drop of the carbon flame in the ordinary process) to burn out the whole of the phosphorus regularly, without sometimes carrying the process too far, and thereby oxygenating the charge. And this, as all steel makers will agree, is very apt to give trouble." However, by taking samples of the metal from the converter during the "after-blow," and testing them, it was found practicable to stop the process at the right time, and to remove the phosphorus in a very satisfactory manner. Here, however, a new difficulty arose. The time lost while the samples were being taken enable the slag and metal to accumulate at the "nose" of the converter, and partially choke the aperture, thus causing great inconvenience and loss of time in removing the obstruction. By reducing the area of the aperture, and thus retaining the heat better in the converter, and by lining the nose with fire-brick, this difficulty was partially got over, but the accumulations of slag still continued at the junction of the fire-brick and basic lining of the converter. Increased experience, however, soon enabled the Sheffield manufacturers to complete the blowing by timing with a watch, without the testing of samples, and as no time was given for the accumulation of slag, no further trouble was experienced. How completely the timing system answered may be judged from the following extract from Messrs. Holland and Cooper's paper:—"In the week ending April 17, when not a single sample was taken during the operation, except in the case of the experimental blow 748, the average amount of phosphorus contained in 36 blows, all of which were analysed, was '056 per cent., the highest being '101 per cent., and the lowest '019 per cent." The composition of this quality of steel has been in other respects very regular, the analyses and results of a test piece 2 inches long and '533 inches in diameter being as follows:—

Car- bon.	Sili- con.	Sul- phur.	Phos- phorus.	Man- ganese.	Breaking strain, tons	Elonga- tion per cent.	Reduc- tion of area per cent.
'40 ...	— ...	'040 ...	'085 ...	'662 ...	39'75 ...	20'25 ...	31'84

It has been found that since sampling has been dispensed with, that the wear of the lining of the converter is very uniform. As many as 630 tons of steel have been produced from one lining, without any repairs excepting a new fire-clay brick-lining for the nose; and 270 tons more were got from the same lining after renewing the front or blowing side, and putting in a new nose. This absence of difficulty about the renewal of the plant, coupled with the excellent quality of the metal produced, show that the process must now be pronounced a commercial success.

The experiences of the Sheffield manufacturers were amply borne out by the results arrived at at Hörde. Mr. Pink says in the beginning of his paper: "Without doubt we are on the verge of making from the very worst classes of pig iron a most reliable and remarkably cheap steel," and this assertion is amply borne out by the results of chemical analysis and mechanical testing which he

publishes. "In the softer qualities for plates, wire, &c., it is at times astonishing what results are obtained. With 37 to 40 kilogrammes of actual breaking weight, as much as 70 per cent., and in some cases even 75 per cent. of contraction has been reached. At the same time this ingot iron can take very high heats, forging and rolling without a flaw. The production of this especial quality is so simple, the cheapness of the raw material, the certainty in working, its softness, and its ductility, all point to its driving at no very distant date puddled iron plates out of the market. For wire even of the smallest gauges it has been declared better than that drawn from billets puddled from charcoal pig."

This is an extremely good result to have attained in the short space of less than a year, and gives good ground for the hope of further improvement in the future. The manufacturers do not appear as yet to have quite succeeded in producing a hard steel by this process.

The remainder of Mr. Pink's paper contains an account of very similar difficulties experienced and overcome to those described by Messrs. Holland and Cooper.

A paper of considerable practical interest was read by Mr. Henry Simon, C.E., of Manchester, "On an improved System for the Utilisation of Bye-Products in the Manufacture of Coke." It is well known that in the manufacture of gas for lighting purposes the sale of the bye-products, such as tar and ammoniacal liquor, which are obtained during the distillation of the coal, is one of the chief sources of profit. In the manufacture of coke it has hitherto been the practice in this country to allow the tar and ammoniacal liquor to run to waste. Such a course not only causes waste, but increases the great nuisance of coke ovens to the neighbourhood in which they are planted. The extent of the waste may be inferred when it is stated that at Manchester the gas-works obtain 38s. per ton for tar, and from 20s. to 25s. per ton for their ammoniacal liquor; and it has been found at Besseges, in France, where the bye-products are saved, that every ton of coke obtained gives nearly 3 cwts. of ammoniacal liquor, and 72½ lbs. of tar, worth together, at Manchester prices, about 4s. 6d. per ton of coke produced.

In this country over 7,000,000 tons of coke a year are produced for the manufacture of pig-iron alone, the value of the bye-products of which is about 1,350,000l., a sum which is annually lost to the nation. The demand for the ammoniacal liquor, both for agricultural purposes and for the manufacture of soda, is practically unlimited. As an instance of the truth of this statement it may be mentioned that one firm of soda-manufacturers, viz., Messrs. Solway, have contracted for the whole production of the Besseges Works, and transport it 300 miles by rail to their factory near Nancy.

By the new method of production nearly the whole of the noxious effect of the old "beehive" coking ovens is done away with. So great are these ill-effects that in the words of the Royal Commission on noxious vapours, which sat in 1877, "all vegetation near coke ovens, conducted on the older methods, suffers severely. The growth of trees is checked or destroyed, fences are killed, crops of every description are injured, cattle suffer, and upon many occasions the effect of the vapours emitted by coke ovens is terrible." In the counties of Durham and Northumberland alone 6,000,000 tons of coal are annually coked, and in the process give off 2,000,000 tons of vapours, which consist in great part of the valuable tars and nitrogenous compounds which might so easily be saved. The quantity of sulphurous acids which escape into the atmosphere every year in these districts is estimated to be about 70,000 tons.

In the process described by Mr. Simon "the coal is rapidly carbonised by subjecting a comparatively thin layer of it to a high temperature in a closed and retort-like vessel, and whilst in the beehive ovens the volatile products are burned inside, we burn them around the out-

side of this retort-like vessel, and only after they are deprived of the tar and ammoniacal liquor." Besides saving these products, the heat of the hot gases is utilised greatly for the production of steam. At Besseges about 45 pounds of water is evaporated into steam of 4½ atmospheres pressure per hour and per ton of coal coked; and it is said that under more favourable circumstances 50 pounds might be evaporated. The remainder of the paper contains a technical description of the new apparatus, the advantages of which are stated to be as follows:—

- "1. Greater yield of coke by about 10 per cent.
- "2. Greater purity of coke.
- "3. A yield of about 4s. worth of useful bye-products per ton of coke.
- "4. An almost entire absence of smoke or noxious vapours.
- "5. In comparison with any other existing system of coke ovens, equal facilities for utilising the heat, and a reduced cost for repairs."

Messrs. John Parry and Alexander Tucker read a joint paper "On the Application of the Spectroscope to the Analysis of Iron and Steel." They commenced by noticing that the analysis of iron and steel is usually summed up in percentages of iron, manganese, carbon, silicon, sulphur, and phosphorus, and perhaps copper, nickel, and cobalt, and suggested that other elements might also be at work, and that we ought not to remain satisfied with percentages of the above substances till we have proved the absence of others. It has, however, been found extremely difficult to prove the absence of the rarer elements, partly because the traces of these latter are apt to accompany the large mass of iron throughout the chemical processes. Under these circumstances it was thought that the spectroscope, which has done so much good work in other departments of chemistry, might be usefully employed.

"Theoretically a well-focussed photographed spectrum of a steel should be an unerring index to its composition; this is partly true in practice, but it is not in our experience absolutely so." "We have found the spectra of pure iron, Bessemer steel, tool steel, chrome steel, Siemens' steel, and pig iron to be decidedly different, and the differences would be characteristic, but they failed to show the presence of bodies which further experiment proved to exist." "There are several reasons why this should be the case.

- "1. The number of lines due to iron is so great (100-130) that they overlap in the small spectra the lines due to other bodies, and our apparatus does not readily allow of images larger than one or two inches being taken.
- "2. The intensity of light due to the traces of bodies may not be sufficient to record lines on the plate.
- "3. Because of the variation in the volatility of the elements, and therefore the necessity of variation in the intensity of the spark."

The authors therefore thought it important either to separate the iron or considerably lower its percentage, and the solution of this problem was their principal aim. The results of their experiments have led them to believe that as a rule the quantity of iron is much over-estimated. In confirmation of this opinion they also quote the fact that iron and steel are capable of absorbing twenty times their volume of hydrogen, a quantity which is always omitted in ordinary analysis, "which is probably due to the fact that a steel saturated with hydrogen must be less liable to oxidation in the heating furnace than one containing little or none. In order to eliminate the iron a method of digestion with various solvents was adopted. By this process much larger quantities can be operated on at a time than by the ordinary methods of precipitation. As much as 7,000 grains of Bessemer steel were dissolved in *aqua regia*. The solution was evaporated and heated in a paraffin bath till the acids were driven off. Ammonia

was then poured on and allowed to act under pressure for several hours. It was then filtered off and evaporated to dryness with nitric acid, so as to decompose any ammonia salts. The residue was then treated in three different ways, and the spectrum photographed in each case.

1. With excess of hydrochloric acid. 2. Water was added to the iron and boiled with it. 3. Acetic acid was added and boiled with the iron, some of which was dissolved, and the solution was therefore nearly neutralised with ammonia and boiled. Photographs were then taken of the spectra of the iron thus precipitated and the filtrate from it. The following is a summary of the results obtained :—

Ammonia	Water	Acetic Acid
Nickel ... ..	Calcium ... ..	Antimony
Cadmium ... ..	Manganese ... ..	Lead
Calcium ... ..	Copper ... ..	Aluminium
Manganese ... ..		Copper
Copper ... ..		Calcium
		Manganese

"The above experiments were made with 7° coils and dense prisms of 60° and 75°, with object-glasses of quartz. By using an electro-dynamic machine a greater dispersion might be used, and the length of the image increased. We think that it would then be found that the bodies which we have detected by indirect means would appear in the spectrum of the original metal."

In addition to the above Mr. Wrightson read a second paper "On some physical changes occurring in Iron and Steel at High Temperatures," which was a continuation of a paper read by him at the Liverpool meeting last year. Mr. Ackerman, of Stockholm, contributed a very lengthy memoir "On Hardening Iron and Steel; its Causes and Effects." There were also five other papers on subjects of importance, chiefly to those technically interested in the manufacture of iron and steel.

In conclusion the Institute must be congratulated not only on the importance and number of the papers produced, but also on the fact that it has succeeded in obtaining contributions from three foreign countries, viz., Germany, Russia, and Norway, a circumstance which will no doubt give to the proceedings of the association an international importance.

NOTES

MR. W. CHANDLER ROBERTS, F.R.S., Chemist of the Mint, has been appointed to the Lectureship of Metallurgy in the Royal School of Mines, rendered vacant by the resignation of Dr. Percy, F.R.S. Mr. Roberts will continue to hold his appointment at the Mint. Mr. Richard Smith, hitherto Assistant Metallurgist, has been appointed Instructor in Assaying.

THE following foreign men of science have recently (May 6) been elected Foreign Members of the Linnean Society :—M. C. J. de Maximowicz, Director of the Imperial Museum and Herbarium, St. Petersburg, author of many important memoirs on systematic botany; Dr. Edward Strasburger, Professor of Botany in the University of Jena, well known for his morphological and physiological researches among various groups of plants; and Prof. Elias Metschnikoff, Director of the Embryological and Zoological Institute, Odessa, whose investigations on the structure and development of the lower marine invertebrata are highly valued.

THE Municipality of Rome has just erected on the promenade of the Pincio a statue in honour of Father Secchi. The statue represents the great astronomer in the attire of a member of the Company of Jesus.

UNDER their present government the French are multiplying the statues erected to their men of science by means of public

subscription. Not less than three new schemes are on foot for that purpose in several parts of the country. A committee has been established at Montpellier for Auguste Comte; another at Blois, in honour of Denis Papin, a rival of the Marquis of Worcester, who, according to the French notion, invented the steam-engine; and a third at Bar-le Duc, on behalf of François Cugnot, an engineer born in the vicinity of that city, who in 1770 constructed a road-locomotive. This rudimentary steam-engine, which is exhibited just now at the Conservatoire des Arts et Métiers, was tried officially but unsuccessfully in the arsenal of Paris more than a century ago.

DR. NILS JOHANN ANDERSSON, the celebrated Swedish botanist and traveller, as the *Gardener's Chronicle* learns from the *Botanisches Centralblatt*, died after long suffering on March 27 at Stockholm. Andersson was born on February 20, 1821, studied at Upsal, graduated as Doctor of Philosophy in 1845, and resided at the University as Assistant Professor of Botany. Afterwards he took part in the expedition of the frigate *Eugenie* round the world, 1851-1853, the result of which he published in several treatises which were translated into various foreign languages. In 1855 he became Demonstrator of Botany at Lund, and in the following year was appointed permanent Professor of Botany, Director of the Bergianska 'schen Garten and Superintendent of the botanical division of the Royal Museum. There he worked with great success till the beginning of 1879. From here Andersson undertook numerous journeys in the cause of science to Lapland, Norway, Germany, France, England, &c. He also acquired scientific renown through his various treatises, books of travel, and text-books.

PROF. SILVESTRI, of Catania, reports as follows concerning the renewed activity of Etna, to which we referred last week :— "The eruption issues from the western side of the mountain, precisely the part which separates the central crater from the eruptive craters of last year. The situation indicated represents the principal part of the ravine which was then formed and remained opened, and which, beginning at the recent eruptive craters, finally crosses the great crater. This ravine, in which are many crater-caverns which opened last May but remained inactive, is now the scene of the present activity, limited as yet to a simple eruption of steam and ashes, such as has frequently taken place during the past months at the summit of the mountain. To-day (April 28), while the sky is cloudless, one sees from Catania the summit of Etna enveloped in clouds which, scattered by a rather strong north-east wind, have no resemblance to eruptive clouds, though they are formed by the steam issuing from the mountain. The eruption of mud at Paterno to the south still continues, and on certain days in some of the craters increases in energy, ejecting as abundant mud as during the first days after the appearance of the phenomena."

ON Tuesday evening a paper on the botanical enterprise of the empire was read to the Colonial Institute in St. James's Hall by Mr. Thiselton Dyer, assistant director of Kew Gardens. The lecturer gave a history of botanical gardens, which date from the middle of the sixteenth century, when Alfonso d'Este, Duke of Ferrara, the patron of Tasso, set the fashion of making collections of foreign plants and flowers. The earliest public botanic garden was founded by Cosmo de' Medici in 1544 for the University of Pisa. The following year one was founded at Padua. In France the earliest botanic garden was founded at Montpellier towards the end of the sixteenth century, and in Germany that of Giessen was established in 1614, and in the Low Countries that of Leyden dated from 1577. In England the Royal Garden at Hampton Court was founded by Queen Elizabeth, and supported by Charles II. and George III. Those which followed and still remain were Oxford, founded in 1632; Chelsea, in 1673; and Edinburgh, in 1680. The origin of Kew as a



scientific institution was entirely due to our Hanoverian princes. During the reigns of George IV. and William IV. Kew was much neglected; but since that date, owing to the efforts of Lindley and Sir W. Hooker, that state of things had been remedied. The lecturer gave a long and elaborate account of the methods pursued and the objects aimed at in the gardens at Kew. There was hardly any country of which a native would not recognise some types of vegetation with which he had been familiar. Plant distribution to all parts of the world was extensively carried out from the gardens, especially that of cinchona, caoutchouc, and Liberian coffee. The herbarium, which was the largest and best organised in the world, and the library, were important features in the gardens, and served to promote a scientific method of nomenclature, identification, and classification. In 1863 the Duke of Newcastle, then Colonial Secretary, instructed Sir W. Hooker to publish a series of colonial floras; and twenty-two volumes had been issued and others were in progress. The floras of Australia and British India were especially valuable. In the former there were 293 species of acacia and 135 of the eucalyptus. Floras had also been published of Hongkong, Mauritius, and the Seychelles, the British West Indies, and New Zealand. The example of Kew in the matter of museums and economic botany had been followed by Hamburg, Berlin, Ghent, Paris, Boston, and our own colonies. The whole vegetable collections of the India Museum had been recently transferred to Kew. One of the most striking features of the gardens was the enormous correspondence with the botanic establishments of the colonies. Mr. Dyer then indicated the principles which should guide the establishment of a colonial botanic garden; one of the chief of these was that it should be attractive and conveniently situated. It was also most important that it should be under competent management, and he was glad to see that the emoluments of directors had in some of our colonies been fixed on a liberal scale. Mr. Dyer concluded by reviewing the progress made by our colonies in botanical research.

In the first four months of 1880 the receipts for telegrams in France have been increased by 1,500,000 francs, but the postal department lost one-sixth of that amount. This result shows that owing to the low rate of telegrams in France ( $\frac{1}{2}d.$  per word) and the increased postage ( $1\frac{1}{2}d.$  per letter), telegraphy is gradually taking the place of ordinary letters.

MR. S. II. WINTLE contributes to the *Launceston Examiner* (Tasmania) of Feb. 20 some curious facts with regard to a "black snake" which he succeeded in capturing by pinning to the ground with a forked stick. In his haste Mr. Wintle pinned the snake to the ground by the middle of the body; what then occurred we give in his own words without comment:—"No sooner had I done so—for now his rage was at its highest pitch—than in an instant he buried his fangs in himself, making the spot wet either with viscid slime or the deadly poison. Now comes that which is of most interest from a scientific point of view. He had hardly unburied his fangs when his coils round the stick suddenly relaxed. A perceptible quiver ran through his body, and in much less time than it takes to write it he lay extended and almost motionless, with his mouth opening and shutting as if he were gasping, but no forked tongue thrust out. In less than three minutes from the time he bit himself he was perfectly dead. Here, then, was a striking example of the potency of the fang-poison of the snake upon itself." An hour after the death of the snake Mr. Wintle tried the effect of the poison in the fangs on a mouse, which died in five minutes, and on a lizard, which died in fourteen minutes. On a *post-mortem* examination of the snake the body was found almost bloodless, "as though the action of the poison had destroyed the colouring-matter of the blood."

MR. F. LEWIS, jun., of Ballangoda, Ceylon, sends us a snake

story in connection with the correspondence on intellect in brutes:—"A short time ago," he says, "I caught a common 'green snake,' and, anxious to try its power of intellect, I brought my finger close to its nose, and seeing that it seemed disposed to bite, I introduced the end of a match close to its mouth. This it did not seem to care about touching, so thinking perhaps that if I moved it about before the animal's eyes it might attract its attention, I did so, but without success. I then took the animal by the neck, and brought *its own tail* before its nose. This it grasped at immediately, and with considerable ardour, but still refused the match! Why should the snake prefer its own tail upon which to exercise its temper? I would suggest that if a few experiments were tried on animal instinct or intelligence some remarkable facts might be elicited, and probably some light thrown upon a subject at present so intricate and complex."

ON Tuesday next (May 18) at the Royal Institution Mr. J. Fiske will give the first of a course of three lectures on American Political Ideas viewed from the Standpoint of Universal History; on Thursday (May 20) Mr. T. W. Rhys Davids will give the first of a course of three lectures on the Sacred Books of the Early Buddhists. The following are the arrangements for the remaining Friday evenings: May 21, Mr. W. Spottiswoode, on Electricity *in transitu*; May 28, Mr. Francis Hueffer, on Musical Criticism; and June 4, Mr. H. H. Statham, an Analysis of Ornament.

M. W. DE FONVIELLE has discovered a very simple process for putting in rotation his newly invented electro-magnetic gyroscope. It is sufficient to connect one end of the frame with each part of the self-acting interrupter. The only difficulty is to place the magnets at a proper distance and not to use a stronger voltaic current than required. For this operation to succeed, it is desirable to understand well the manoeuvres of an instrument constructed on purpose. Some of the so-called electro-medical bobbins succeed remarkably well, either with the primary, the secondary, or a combination of the two working in tension.

A PART of the St. Gothard Tunnel, 6,300 metres from the south entrance, has fallen in, killing three workmen and injuring three others.

FIVE walled tombs, each containing a skeleton, have been discovered at Chamblandes, Canton Vaud. From the absence of metal ornaments and other indications, they are supposed to belong to an age prior to that of bronze.

ON May 9 a large number of officials and others assembled at Noailles to celebrate the completion of a rural railway with narrow gauge, of which we mentioned the inauguration a few months ago. The speculation is succeeding very well, and great improvements have been realised in all the surrounding country since the system has been in operation.

THE additions to the Zoological Society's Gardens during the past week include a Silver-backed Fox (*Canis chama*) from South Africa, presented by the Rev. G. II. R. Fisk, C.M.Z.S.; a Tayra (*Galictis barbara*) from South America, presented by Mr. G. A. Muhlhäuser; an Indian Chevrotain (*Tragulus meminna*) from Ceylon, presented by Mr. W. H. Ravenscroft; a Ruddy Ichneumon (*Herpestes smithi*) from India, presented by Mr. A. R. Lewis; two Slow-worms (*Anguis fragilis*), British, presented by Mr. O. Thomas; five Bosca's Mud Newts (*Pelomates boscai*) from North Spain, presented by Dr. A. Günther, F.Z.S.; an Indian Cobra (*Naja haje*) from India, presented by Mr. W. R. Higham; a Macaque Monkey (*Macacus cynomolgus*) from India, a Goffin's Cockatoo (*Cacatua goffini*) from Queensland, deposited; four Upland Geese (*Bernicla magellanica*) from Patagonia, purchased; an Axis Deer (*Cervus axis*), a Zebu (*Bos indicus*), born in the Gardens.

## GEOGRAPHICAL NOTES

It is a great relief to learn that a letter has been received at St. Petersburg through Peking from Col. Prejevalsky, dated from the town of Si-Ning, March 20, announcing that the expedition under his command is safe. He left the Nan Shian mountains in July, and entered Thibet through Shaidash. His party were attacked by Tanguts, of whom they killed four and put the remainder to flight. The Thibetian troops stopped the progress of the expedition 250 versts from Hlassa, and a messenger from the Grand Lama of Thibet brought the refusal of the Thibetian authorities to allow the Russians to proceed. The latter were, therefore, obliged to return, which they did with some difficulty through Northern Thibet, wintering at a height of 16,000 feet above the level of the sea. Col. Prejevalsky expects to reach Kiakhta in August by way of Alashan Uргу.

At the meeting of the Geographical Society on Monday last, Mr. Everard F. im Thurn, late of the Georgetown Museum, read a paper nominally descriptive of one of his journeys into the interior of British Guiana, but which also furnished much interesting information about that country generally. Mr. im Thurn first gave an account of the four tracts, parallel to the sea-coast, into which British Guiana may be divided, and afterwards of his journey up the Esequibo to the Savannah tract, over which he passed into Brazilian territory. At the Warraputa Cataracts he saw for the first time the rock-pictures which form so strange an addition to the landscape in parts not only of South, but of North America. The figures represent men, monkeys, snakes, &c., and are on a small scale. These pictures in Guiana are not of one kind, some being cut deeply into the rock, while others are merely scratched on the surface. Mr. im Thurn speaks well of the climate of British Guiana away from the coast, the chief drawbacks in the interior being fever, not of a dangerous kind, diarrhoea, and ophthalmia, the germs of the last being probably conveyed by the countless small flies with which the country is infested. His allusions to the flora of the region were particularly interesting, and from a remark which he made we are glad to believe that we shall have a book from his pen before long on this little understood colony. Mr. Flint, who had been Mr. im Thurn's companion, afterwards gave a brief description of an expedition he had made to the Roraima Mountain on the western frontier of British Guiana. He does not believe in the reported inaccessibility of this wonderful mountain, and roundly asserted that no serious attempt had yet been made to ascend it, previous travellers not having approached within a considerable distance of its base.

MR. DOUGLAS W. FRESHFIELD, writing to the *Times*, states that further letters have been received from Mr. E. Whympier, announcing his ascent of Pichincha and his meeting with M. Wiener, who is about to explore the Napo country. Fuller and more formal accounts of Mr. Whympier's exploits have been received, but by his request they will not be made public until after his return in June.

IN continuation of our note (*NATURE*, vol. xxi. p. 526) on Mr. Easton's journey in the extreme north-west of China, we learn from a further instalment of his diary some additional particulars respecting his travels. After leaving Shunhwa-tung on the upper waters of the Yellow River, he intersected at right angles the longitudinal range of mountains that runs along the north bank, and after a hard climb of fifteen miles he reached Ba-rung, a small mud-walled town under the jurisdiction of Sining. The hills are of mud, and landslips have split them in all directions; they are uncultivated, and scarcely a blade of grass is to be seen. An extensive view was obtained from the top, and far away on the western horizon were seen snow-capped peaks of high mountains. Sining-fu, where Col. Prejevalsky is believed to have fixed his head-quarters for the present, was afterwards visited, and this city is described as "rather large and oblong, but really a very shabby place;" it is stated to be 400 miles distant from Tsinchow-fu, the head-quarters of the China Inland Mission in the interior of the Kansu province. On his return to that place from Sining, Mr. Easton crossed the Yellow River near Sincêng, about 100 miles from Sining, and he describes its width at that point as about 100 yards, but further down it widens to about 150 yards. The river winds very much, and abounds in rapids.

WHERE at one time, says the *Eureka Leader*, was Ruby Lake, there is at present not a drop of water. This sheet of water, seven or eight years ago, was from eighteen to twenty

miles in length, and varied in breadth from half a mile to two or three miles, and was in a number of places very deep. It was fed by numberless springs along the foot of Ruby Mountain, and was the largest body of water in Eastern Nevada. For a number of years past it has been gradually drying up, until at last it has entirely disappeared. What has been the cause of this is a mystery. The Ruby range of mountains is considered the largest and finest between the Rockies and the Sierra Nevadas, and besides being well wooded, has been the best-watered range of mountains in Nevada.

A PARTY of United States engineers has recently taken soundings of the Niagara River below the falls. It was a work of great difficulty to approach the falls in a small boat. Great jets of water were thrown out from the falls far into the stream, and the roar was so terrible that no other sound could be heard. The leadsmen cast the line, which gave 83 feet. This was near the shore. Further down stream a second cast of the lead told off 100 feet, deepening to 192 feet at the inclined railway. The average depth of the Swift Drift, where the river suddenly becomes narrow with a velocity too great to be measured, was 153 feet. Immediately under the lower bridge the whirlpool rapids set in. Here the depth was computed to be 210 feet.

THE German African Society, in the last number of its *Mittheilungen*, publishes a list of all the scientific expeditions sent out by the (former) German Society for the Investigation of Equatorial Africa, and by the new Society (under its present title) during the years from 1873 to 1879. Altogether there were no less than eight expeditions, viz.:—1. The Loango-Expedition, and to the Chinchoxo Station, 1873-1876; cost 10,532*l.*, less 1,133*l.* realised from sale of specimens; leader, Dr. Paul Güssfeldt, not Prof. A. Bastian (who took part at his own expense in the preparatory steps for the establishment of the Chinchoxo Station). 2. The Ogowe-Expedition of Dr. Oscar Lenz, 1874-1876, cost 1,563*l.* 3. Cassange-Expedition, 1874-1876, cost 4,457*l.* Members: Capt. A. von Homeyer, Dr. Paul Pogge, Herm. Soyaux, Lieut. A. Lux. 4. Eduard Mohr's Expedition, 1876, cost 692*l.* 5. Engineer Schütt's Expedition, 1877-1879, cost 2,590*l.* 6. Dr. Max Buchner's Expedition, since 1878, cost (till October, 1879) 1,523*l.* 7. Rohlf's Expedition, since 1878, cost (till October, 1879) 2,255*l.* Members: Dr. Gerhard Rohlf's, Dr. Anton Stecker. 8. Dr. Oscar Lenz's Expedition to Morocco, since the end of 1879.

IN his just published report on Borneo H. M.'s Consul-General says that owing to its geological formation the soil of the island cannot be compared with that of Java, Sumatra, the Sulu Archipelago, and the Philippines, all islands of volcanic origin. Towards the north, however, and in the plains in the neighbourhood of the Great Kina Balu range, the soil is exceedingly good, as is shown by the success with which the natives grow in their rude manner rice, tapioca, indigo, &c. At present the greater part of the island is clothed with a dense primæval forest of lofty trees, many of which afford excellent timber, and until the virgin soil thus covered has been cleared it is useless to speculate on the mineral resources of the country, but there is no doubt of the existence of coal, antimony, ore, and gold in Northern Borneo. Mr. Treacher, we may add, accompanies his report with a useful sketch-map of this part of the island.

DR. DUTRIEUX, who until quite lately was on the staff of the first Belgian expedition to East Central Africa, has just published at Brussels (*Lebègue et Cic.*) some of the results of his observations in that country, under the title of "*La Question Africaine au point de vue Commerciale.*"

IN a communication, entitled "*Cimbébasie*," in the last number of *Les Missions Catholiques*, Père Duparquet furnishes a good deal of interesting information respecting Ovampo-land in Western Africa. Père Duparquet gives, in fact, a rapid sketch of his explorations from Olokonda to Quanhama in about 17° S. lat., 16° E. long. He has besides, however, collected a mass of notes about a large tract of country hitherto almost entirely unknown, and of which he expresses a high opinion.

THE new number of *Les Annales de l'Extrême Orient* is chiefly occupied with an instalment of Prof. P. J. Veth's notes on the languages and literature of Java, and the interminable question of M. J. Dupuis and Tongking.

IN the new number of the *Verhandlungen* of the Berlin Geographical Society (Band vii. No. 3) Herr Flegel gives an exceedingly interesting account of his residence in West Africa,

his visit to the Cameroon Mountains, and his ascent of the river Binué.

THE *Bolletino* of the Italian Geographical Society for April contains full details of the proposed Arctic Expedition under Lieut. Bove, with a carefully compiled map of the south polar regions so far as these have been hitherto explored.

M. DESIRÉ CHARNAY has left New York for Mexico for the purpose of carrying out a thorough exploration of the ancient remains that still exist in that country. It is expected that the work of exploration will last for two or three years.

ON ELECTRIC LIGHTING:

**DYNAMO-ELECTRIC MACHINES.**—Since the date of the author's former paper in April, 1879, other observers have published the results of experiments similar to those described by him. It may be well to exhibit some of these results reduced to the form he has adopted, viz., a curve, such as that shown in Fig. 4, *Proceedings*, 1879, Plate 29, and now reproduced, with slight alterations, in Fig. 1. Here any abscissa represents a current passing through the dynamo-electric machine,

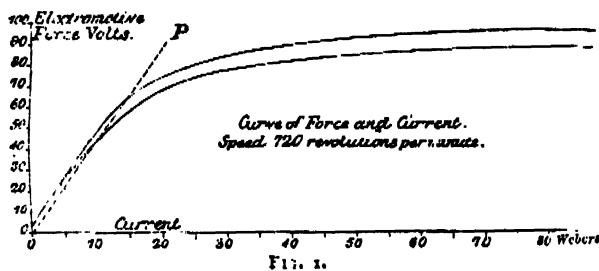

and the corresponding ordinate represents the electromotive force of the machine for a certain speed of revolution, when that current is passing through it. It will be found (1) that with varying speed the ordinate or electromotive force, corresponding to any abscissa or current, is proportional to the speed; (2) that the electromotive force does not increase indefinitely with increasing current, but that the curve approaches an asymptote; (3) that the earlier part of the curve is, roughly speaking, a straight line, until the current attains a certain value, and that at that point the electromotive force has reached about two-thirds of its maximum value. When the current is such that the electromotive force is not more than two-thirds of its maximum, a very small change in the resistance with speed of engine constant, or in the speed of the engine with resistance constant, causes a great change in the current. For this reason such a current, which is the same for all speeds of revolution, since the curves for different speeds differ only in the scale of ordinates, may be called the "critical current" of the machine. The effect of a change of speed is exhibited in Fig. 1, where the lower line represents a curve for a speed of 660 revolutions per minute, instead of 720. The resistance, varying as  $\frac{\text{electromotive force}}{\text{current}}$  is given by the slope of the line OP, which must therefore be constant; and it will be seen that this line cuts the upper curve at a point corresponding to a current of 15 webers, and the lower at a point corresponding to a current of 5 webers only.

In Germany, Auerbach and Meyer (*Wiedemann's Annalen*, November, 1879) have experimented fully on a Gramme machine at various speeds, and with various external resistances. The resistance of the machine was 0.97 ohms. Their results are summarised in a table at the end of their paper, which gives the current passing, with resistances in circuit from 1.75 to 200 Siemens units, and at speeds from 20 to 800 revolutions per minute. In the accompanying diagram, Fig. 2, curve No. 1, expresses the relation between electromotive force and current, as deduced from some of their observations, making allowance, where necessary, for difference in speed. The curve, as actually constructed, is for a speed of 800 revolutions; at this speed it will be seen that the maximum electromotive force is about 76 volts; the critical current, corresponding to a force of about 51 volts, is 6.5 webers, with a total resistance of 7.8 ohms. Up to this point there will be great instability, exactly as was the case in

the Siemens machine examined by the author, where the resistance was 4 ohms, and the speed 720 revolutions.

The results of an elaborate series of experiments on certain dynamo-electric machines have recently been presented to the Royal Society by Dr. Siemens. One of the machines examined was an ordinary medium-sized machine, substantially similar to that tried by the author in 1879. It is described as having 24 divisions of the commutator; 336 coils on the armature, with a resistance of 0.4014 Siemens units; and 512 coils on the magnets, with a resistance of 0.3065; making a total resistance of

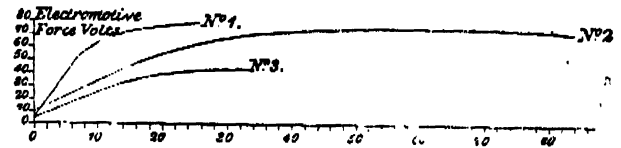

0.7079 Siemens units = 0.6654 ohms. Curve No. 2 gives the relation of electromotive force and current, reduced to a speed of 700 revolutions per minute, the actual speeds ranging from 450 to 800 revolutions. The maximum electromotive force appears to be probably 76 volts, and the critical current 15 webers, which is the same as in the author's first experiments on a similar machine.

In the summer of last year the author examined a Siemens machine of the smallest size. This machine is generally sold as an exciter for their alternate current machine. It has an internal resistance of 0.74 ohms, of which 0.395 is in the armature or helix. The machine is marked to run at 1,130 revolutions per minute. The following Table gives, for a speed of 1,000 revolutions, the total resistance, current, electromotive force, and horse-power developed as current. The horse-power expended was not determined:—

Experiments on smallest-sized Siemens Dynamo-Electric Machine

Resistance.	Electric current.	Electromotive force.	Horse-power developed as current.
Ohms.	Webers.	Volts.	H. P.
2.634	4.53	13.2	0.08
2.221	10.8	27.0	0.39
1.967	15.1	33.6	0.68
1.784	18.1		0.88
1.668	19.8		0.98
1.579	20.6		1.01
1.503	22.8	39.3	1.20
1.440	24.7	40.0	1.32
1.145	32.2	41.5	1.79

Curve No. 3 gives as usual the relations of electromotive force and current. From this curve it will be seen that the critical current is 11.2 webers, and the maximum electromotive force, at the speed of 1,000 revolutions, is about 42 volts. The determinations for this machine were made in exactly the same manner as in the experiments on the medium-sized machine, using the galvanometer, but omitting the experiment with the calorimeter (compare Table I., p. 249, *Proceedings*, April, 1879).

The time required to develop the current in a Gramme machine has been examined by Herwig (*Wiedemann*, June, 1879). He established the following facts for the machine he examined. A reversed current, having an electromotive force of 0.9 Grove cells, sufficed to destroy the residual magnetism of the electromagnets. If the residual magnetism was as far as possible reduced, it took a much longer time to get up the current than when the machine was in its usual state. A longer time was required to get up the current when the external resistance was great, than when it was small. With ordinary resistance the current required from  $\frac{1}{2}$  second to 1 second to attain its maximum.

**Brightness of the Electric Arc.**—The measurement of the light emitted by an electric arc presents certain peculiar difficulties. The light itself is of a different colour from that of a standard candle, in terms of which it is usual to express luminous intensities. The statement, without qualification, that a certain electric lamp and machine give a light of a specified number of candles, is therefore wanting in definite meaning. A red light cannot with propriety be said to be any particular multiple of a green light; nor can one light, which is a mixture of colours, be said with strictness to be a multiple of another, unless the proportions of the colours in the two cases are the same. Capt. Abney (the Royal Society, March, 1878) has given the

<sup>2</sup> Paper read at the Institution of Mechanical Engineers, by Dr. John Hopkinson, F.R.S.

results of measurements of the red, blue, and actinic light of electric arcs, in terms of the red, blue, and actinic light of a standard candle. The fact that the electric light is a very different mixture of rays from the light of gas or of a candle, has long been known, but has been ignored in statements intended for practical purposes.

Again, the emission of rays from the heated carbons and arc is by no means the same in all directions. Determinations have been made in Paris of the intensity in different directions, in particular cases. If the measurement is made in a horizontal



FIG. 3 (Scale about  $\frac{1}{2}$ ).

direction, a very small obliquity in the crater of the positive carbon will throw the light much more on one side than on the other, causing great discordance in the results obtained.

If the electric light be compared directly with a standard candle, a dark chamber of great length is needed—a convenience not always attainable. In the experiments made at the South Foreland by Dr. Tyndall and Mr. Douglass, an intermediate standard was employed; the electric light was measured in terms of a large oil lamp, and this latter was frequently compared with a standard candle.

Other engagements have prevented the author from fairly attacking these difficulties; but since May 1879 he has had in occasional use a photometer with which powerful lights can be measured in moderate space. This photometer is shown in Fig. 3, and an enlargement of the field-piece in Fig. 4. A lens

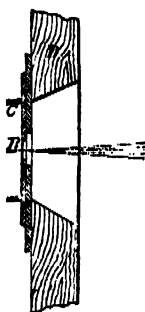

FIG. 4 (Scale about  $\frac{1}{4}$ ).

A, of short focus, forms an image at B of the powerful source of light which it is desired to examine. The intensity of the light from this image will be less than that of the actual source by a calculable amount; and when the distance of the lens from the light is suitable, the reduction is such that the reduced light becomes comparable with a candle or a carcel lamp. Diaphragms CC are arranged in the cell which contains the lens, to cut off stray light. One of these is placed at the focus of the lens, and has a small aperture. It is easy to see that this diaphragm will cut off all light entering from a direction other than that of the source; so effectually does it do so, that observations may be made in broad daylight on any source of light, if a dark screen be placed behind it. The long box DD, Fig. 3, of about 7 feet length, is lined with velvet—the old-fashioned dull velvet—not that now sold with a finish, which reflects a great deal of the light incident at a certain angle. This box serves as a dark chamber, in which the intensity of the image formed by the lens is compared with a standard light, by means of an ordinary Bunsen's photometer  $\alpha$ , sliding on a graduated bar.

Mr. Dallmeyer kindly had the lens made for the author: he can therefore rely upon the accuracy of its curvature and thickness; it is plano-convex, the convex side being towards the source of light. The curvature is exactly 1 inch radius, and the thickness is 0.04 inch; it is made of Chance's hard crown glass, of which the refractive index for the D line in the spectrum is 1.517. The focal length  $f$  is therefore 1.933 inch.

Let  $u$  denote the distance of the source of light from the curved surface of the lens, and  $v$  the distance of the image of the source B from the posterior focal plane. Neglecting for

the moment loss by reflection at the surface of the glass, the intensity of the source is reduced by the factor  $(\frac{v}{u})^2$ . But

$$\frac{1}{v} + \frac{1}{u} = \frac{1}{f} \text{ or } v = \frac{uf}{u-f}; \text{ hence the factor of reduction is } \left(\frac{f}{u-f}\right)^2.$$

The effect of absorption in so small a thickness of very pure glass may be neglected; but the reflection at the surfaces will cause a loss of 8.3 per cent. which must be allowed for. This percentage is calculated from Fresnel's formulae, which are certainly accurate for glasses of moderate refrangibility, and for moderate angles of incidence.

Suppose, for example, it is required to measure a light of 8,000 candles; if it be placed at a distance of 40 inches it will be reduced in the ratio 467 to 1, and becomes a conveniently measurable quantity. By transmitting through coloured glasses both the light from an electric lamp and that from the standard, a rough comparison may be made of the red or green in the electric light with the red or green in the standard.

A dispersive photometer, in which a lens is used in a somewhat similar manner, is described in Stevenson's "Lighthouse Illumination." Messrs. Ayrton and Perry described a dispersive photometer with a concave lens at the meeting of the Physical Society on December 13, 1879 (*Proc. of the Physical Society*, vol. iii, p. 184). The convex lens possesses however an obvious advantage in having a real focus, at which a diaphragm to cut off stray light may be placed.

*Efficiency of the Electric Arc.*—To define the electrical condition of an electric arc, two quantities must be stated: the current passing, and the difference of electric potential at the ends of the two carbons. Instead of either one of these, we may, if we please, state the ratio  $\frac{\text{difference of potential}}{\text{current}}$ , and call it the resistance of the arc, that is to say, the resistance

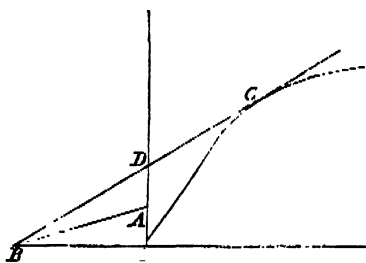

FIG. 5.

which would replace the arc without changing the current. But such a use of the term electric resistance is unscientific; for Ohm's law, on which the definition of electric resistance rests, is quite untrue of the electric arc; and, on the other hand, for a given material of the electrodes, a given distance between them, and a given atmospheric pressure, the difference of potential on the two sides of the arc is approximately constant. The product of the difference of potential and the current is of course equal to the work developed in the arc; and this, divided by the work expended in driving the machine, may be considered as the efficiency of the whole combination. It is a very easy matter to measure these quantities. The difference of potential on the two sides of the arc may be measured by the method given by the author in his previous paper, by an electrometer, or in other ways. The current may be measured by an Obach's galvanometer, by a suitable electro-dynamometer, or best of all, in the author's opinion, by passing the whole current, on its way to the arc, through a very small known resistance, which may be regarded as a shunt for a galvanometer of very high resistance, or to the circuit of which a very high resistance has been added.

It appears that with the ordinary carbons and at ordinary atmospheric pressure no arc can exist with a less difference of potential than about 20 volts; and that in ordinary work, with an arc about  $\frac{1}{4}$  inch long, the difference of potential is from 30 to 50 volts. Assuming the former result, about 20 volts, for the difference of potential, the use of the curve of electromotive forces may be illustrated by determining the lowest speed at which a given machine can run, and yet be capable of producing a short arc. Taking O as the origin of co-ordinates, Fig. 5, set off upon the axis of ordinates the distance OA equal to 20 volts; draw AB to intersect at B the negative prolongation of the axis

of abscissa, so that the ratio  $\frac{OA}{OB}$  may represent the necessary metallic resistance of the circuit. Through the point *B*, thus obtained, draw a tangent to the curve, touching it at *C*, and cutting *OA* in *D*. Then the speed of the machine, corresponding to the particular curve employed, must be diminished in the ratio  $\frac{OD}{OA}$ , in order that an exceedingly small arc may be just possible.

The curve may also be employed to put into a somewhat different form the explanation given by Dr. Siemens at the Royal Society respecting the occasional instability of the electric light as produced by ordinary dynamo-electric machines. The operation of all ordinary regulators is to part the carbons when the current is greater than a certain amount, and to close them when it is less; initially the carbons are in contact. Through the origin *O*, Fig. 6, draw the straight line *OA*, inclined at the angle

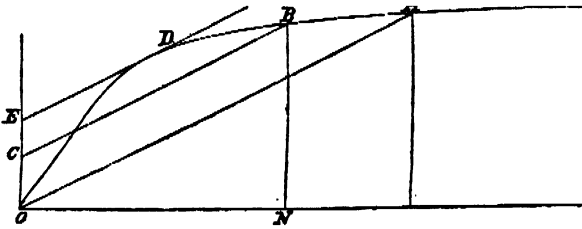

FIG. 6.

representing the resistances of the circuit other than the arc, and meeting the curve at *A*. The abscissa of the point *A* represents the current which will pass if the lamp be prevented from operating. Let *ON* represent the current to which the lamp is adjusted; then if the abscissa of *A* be greater than *ON*, the carbons will part. Through *N* draw the ordinate *BN*, meeting the curve in the point *B*; and parallel to *OA* draw a tangent *ED*, touching the curve at *D*. If the point *B* is to the right of *D*, or farther from the origin, the arc will persist; but if *B* is to the left of *D*, or nearer to the origin, the carbons will go on parting, till the current suddenly fails and the light goes out. If *B*, although to the right of *D*, is very near to it, a very small reduction in the speed of the machine will suffice to extinguish the light. Dr. Siemens gives greater stability to the light by exciting the electromagnets of the machine by a shunt circuit, instead of by the whole current.

The success of burning more than one regulating lamp in series depends on the use in the regulator of an electro-magnet, excited by a high-resistance wire connecting the two opposed carbons. The force of this magnet will depend upon the difference of potential in the arc, instead of depending, as in the ordinary lamp, upon the current passing. Such a shunt magnet has been employed in a variety of ways. The author has arranged it as an attachment to an ordinary regulator; the shunt magnet actuates a key, which short-circuits the magnet of the lamp when the carbons are too far parted, and so causes them to close.

In conclusion the author ventures to remind engineers of the following rule for determining the efficiency of any system of electric lighting in which the electric arc is used, the arc being neither exceptionally long nor exceptionally short. Measure the difference of potential of the arc, and also the current passing through it, in volts and webers respectively; then the product of these quantities, divided by 746, is the horse-power developed in that arc. It is then known that the difference between the horse-power developed in the arc and the horse-power expended to drive the machine must be absolutely wasted, and has been expended in heating either the iron of the machine or the copper conducting wires.

**PRELIMINARY REPORT BY THE COMMITTEE  
ON SOLAR PHYSICS APPOINTED BY THE  
LORDS OF THE COMMITTEE OF COUNCIL  
ON EDUCATION**

"SIR,—In reply to Mr. MacLeod's letter of November 20, 1879, calling upon us, pending the preparation of our General Report, to give a brief summary of the progress already made, and to state at the same time what work was in hand, and

such other facts as we might think it desirable to mention, to enable their Lordships to determine whether they shall apply to the Lords Commissioners of Her Majesty's Treasury for an extension of the vote for another year, we have the honour now to submit the following report.

"The Committee have had thirteen formal meetings. In addition to this several members of the Committee have carried out special branches of the inquiry; and Mr. Lockyer, as arranged when the Committee was appointed, has been charged with the general conduct of the observational and experimental work at South Kensington. The Committee consider that Mr. Lockyer by his laboratory work and comparison of the results with solar phenomena, has brought together a great body of evidence tending *prima facie* to conclusions of the utmost importance. The labour and difficulty of the research are, however, so great that much additional time and attention must continue to be bestowed on it before the questions thus raised can be considered as finally settled; and the Committee think it of much importance that the researches now being carried on should not be interrupted.

"The Committee have been in correspondence with the Indian Government, the Astronomer-Royal, the Directors of the Observatories at Wilna, Melbourne, Mauritius, Kew, Moscow, Toronto, Paris, Palermo, Princeton, and with Dr. Warren De la Rue. From all of these promises of valuable co-operation and assistance have been received. To the Astronomer-Royal our thanks are specially due for the manner in which he has met us in the matter, placing all the information bearing on the subject in the Royal Observatory at our service.

"A few months before the appointment of the Committee, daily photographs of the sun had been commenced by order of the Government of India under the Surveyor-General at Dehra, N.W. Provinces, the photographs being transmitted to Mr. Lockyer for reduction.

"Unfortunately the observer, Mr. Meins, late of the R.E., sent from this country, after having been trained at Chatham and South Kensington, died suddenly in the early part of the year, and the continuity of the daily record was thus broken. In August the Government of India requested to be informed as to the importance of the continuance of the records thus interrupted, and the following letter was sent in reply:—

"Science and Art Department, London, S.W.,  
"27th November, 1879

"SIR,—In reply to your letter dated August 10, 1879, inviting remarks relative to the importance of continuing certain solar observations which were recently instituted in India, and suggestions as to future arrangements if it should be decided that the observations are to be continued for an indefinite period, I beg leave to submit to you, for the information of Lord Cranbrook, the following explanation:—

"In their General Report the Science Commissioners recommended the establishment of a system of physical (as distinguished from astronomical) observations on the sun, and pointed out the advantages which Northern India offers for this study. A memorial was more recently presented to Government, signed by a number of our leading scientific men, urging the carrying out of this recommendation.

"In compliance with these recommendations the British Government as a preliminary step appointed a Committee on Solar Physics, whose duty it should be to make trial of methods of observation, collect observed results, &c., and who were specially charged with the reduction of such observations as should be made in India. As a consequence of this arrangement the Government of India authorised the employment of the late Mr. Meins for the purpose of taking photographs of the sun in India, and a series of such photographs was prepared by him and has been sent home to be dealt with. The following brief statement will show how superior the climate of India is to our own for observations of this kind. The Astronomer-Royal has been so kind as to furnish the Committee with a list of the solar photographs taken at the Royal Observatory during the period 21st July, 1873, to 18th July, 1879, over a part of which Mr. Meins' work extended. It should be mentioned that in both places alike the rule was to take three photographs daily, in the morning, about noon, in the afternoon, when clear views of the sun could be obtained. In the rare cases in which a fourth photograph was taken in the same day in India, it is not included in the following list:—

Total number of days during which both instruments were working simultaneously between February 11th, 1878, and March 31st, 1879...	384	
Total number of photographs. Reducing where four or more have been taken to three ...	207	872
Number of days on which one at least was taken ...	143	342
Number of days on which no photograph was taken ...	244	42

Greenwich. India.

"No correction has been made for the non-taking of photographs at Greenwich on Sundays.

"In the total number of photographs the maximum number taken on any one day has been taken as three.

"The actual returns are inclosed as an appendix B and C.<sup>1</sup>

"It so happens that for the last year or two the sun has been in a condition of unusual quiescence, so that in the whole series of photographs sent home by Mr. Meins there were only two or three small spots. But it is well established by previous experience that the sun passes alternately through a condition of few spots and many spots, the whole period of the change being about eleven years. We are now, according to the reckoning, entering on a period of solar activity, and already spots have begun to appear. The present time and the immediate future form therefore a period of special interest for the observation of solar phenomena. And though the immediate object of the memorialists in advocating a more active study of solar physics was an increase to our scientific knowledge, it is hard to say what bearings such an increase may not have upon the practical concerns of life. There is some reason to think that meteorological conditions bear traces of a period similar to that of solar activity as manifested by spots, and it has been conjectured that the droughts and consequent famines which from time to time have devastated portions of our Indian Empire show something of a similar period. Should a further study of solar phenomena lead to even an approximate forecast of the liability to such terrible visitations, it is needless to say of what practical importance it would thereby become.

"As has been already explained the Committee were appointed as a temporary measure to prepare the way for something of a more permanent and systematic nature, and it is to aid them in this work that the Indian observations have been asked for. What shape the research may permanently take it is impossible at the present time to predict.

"In view of these facts the Committee is of opinion that it is of special importance that the series of Indian sun photographs should be resumed as early as practicable, if, as is feared, they have been interrupted, and should be continued without break at all events for three or four years to come, the present period of increasing solar activity being one of peculiar scientific interest.

"The Committee further suggest that the Surveyor-General of India, under whom Sergeant White, the successor of Mr. Meins, will be employed, might usefully be instructed to cause one or more native employes of the Survey Department to be instructed in the process of solar photography, so that risk of interruption of the series from sickness, &c., of the European photographer may be guarded against in the future.

"It is believed that skill in the necessary manipulations for successful photography could be readily acquired by intelligent natives, and that when this had been done further assistance from this country for the supply of photographers would not be needed.

"I have the honour to be, Sir,

"Your obedient servant,

"(Signed)

"G. G. STOKES"

"Considerations in all respects identical with those which we thought of weight in regard to India are in our opinion generally applicable, and we have no hesitation in expressing our belief that the continued careful study of the class of phenomena in question will prove to be of the greatest scientific value, and that there is no reason for doubting that the advance of true knowledge in this direction will, in some form or other, and sooner or later, prove to be of real practical value also, as all experience has shown that it has been in other branches of human knowledge.

<sup>1</sup> It has not been considered necessary to reproduce these appendices in this place.

"Whether or not we shall ever possess the power of foreseeing the character of the seasons in this country, or to what extent they may in truth be related to those changes in the condition of the sun to which our attention is specially directed, it is of course impossible for us to say. But of the extreme importance of doing all that lies in our power to advance a sound knowledge of the laws of climate which so directly affect the well-being of the whole human race there can be no question.

"We append details of the work in which we have been engaged.

"G. G. STOKES

BALFOUR STEWART

RICHARD STRACHEY

J. NORMAN LOCKYER

W. DE W. ABNEY

J. F. D. DONNELLY

"The Secretary, Science and Art Department"

### UNIVERSITY AND EDUCATIONAL INTELLIGENCE

CAMBRIDGE.—It appears rather noteworthy that at a very recent debate in the Cambridge Union (May 4), a motion proposed by Mr. Theodore Beck, of Trinity College, affirming that the Tripos system of education here adopted is unfavourable to the interests of original research and individual culture, should have been lost by only three votes, after speeches in opposition to the motion in which more than one distinguished Tripos man took part. The votes were: For the motion, 51; against, 54.

Mr. E. Temperley, of Queen's College, and Mr. W. Burnside, of Pembroke College (on the nomination of Corpus Christi College), have been appointed Moderators for the next Mathematical Tripos.

It appears from the discussion on the subject of the exemption from Greek of honours students who desire exemption, and offer French and German, that there is much diversity of opinion on the subject, even among residents. How long will it be before the ideas of freedom have practical effect in Cambridge? Dr. Thompson, Master of Trinity, was strongly desirous that Greek should not be required of men coming to Cambridge as serious students of mathematics and natural science. He had no wish to weaken the position of Greek, but to allow men to come to the University and obtain distinction in their own line. Prof. Skeat wondered why a knowledge of English language and literature could not yet find a place in the course for the little-go; the University had very few studying or capable of teaching it in a scientific way. Mr. Henry Jackson said the present system put many boys through the drudgery of learning the rudiments to get the chance of making classical scholars of a few. Mr. Vansittart gave expression to the regret of many that it should be proposed to substitute two languages for Greek; he would give as alternatives natural sciences for mathematical men, and additional mathematics for natural science men, or he would leave the choice between English and natural sciences.

It is to be hoped that Cambridge University will cease from the fruitless attempt to find out one universal mode of culture and routine for schools. The Local Examinations Syndicate have already done this, not having to secure the approbation of the entire Senate for all the alternative subjects it offers. But the Public Schools follow too much the lead of the Pass Examinations in the Universities. The Syndicate, considering the question, have referred very much to the opinions of headmasters of public schools, and because they feel so much that their "craft" is in danger, the great need of gaining the mass who do not go to public schools may be lost sight of.

THE late Mr. John Henry Challis bequeathed 100,000*l.* to the University of Sydney. Its Parliamentary assistance is only 5,000*l.* per annum, a sum quite insufficient to secure as many Chairs in the different faculties as the name of University implies. The bequest of Mr. Challis, invested at 5 per cent., will add another 5,000*l.* per annum to the sum voted by Parliament, and will enable the faculties to enlarge their curriculum and extend their operations in a manner they have never yet had the means to attempt.

### SCIENTIFIC SERIALS

*American Journal of Science*, April.—Berthelot's thermochemistry, by J. P. Cooke.—History of the pre-cambrian rocks in America and Europe, by T. Sterry Hunt.—Synopsis of the

cephalopoda of the north-eastern coast of America, by A. E. Verrill.—Notices of recent American earthquakes, by C. J. Rockwood, jun.—Observations on the height of land and sea-breezes, taken at Coney Island, by O. T. Sherman.—New method of spectrum observation, by J. N. Lockyer.—Presentation of sonorous vibrations by means of a revolving lantern, by H. Carmichael.—Chemical composition of childrenite, by J. L. Penfield.—Observations on the planet Lilaea, by C. H. F. Peters.—Efficiency of Edison's electric light, by H. A. Rowland and G. F. Barker.

*Annalen der Physik und Chemie*, No. 3.—On the behaviour of carbonic acid in relation to pressure, volume, and temperature, by R. Clausius.—On a relation between pressure, temperature, and density of saturated vapours of water and some other liquids (continued), by A. Winkelmann.—Researches on the vibrations of a normal tuning-fork, by R. Koenig.—Researches on the equi-potential distribution of the magnetic fluids of cylindrical steel bars, by W. Schaper.—General theory of the deadening influence of a multiplier on a magnet (continued), by K. Schering.—On ultra-violet rays, by J. L. Schön.—On a spectroscope, by P. Glan.—On a new simple mode of streak observation, by V. Dvorak.—Contribution to a history of the mechanical theory of heat, by E. Oedler.

*Journal de Physique*, April.—On the measurement of wavelengths of infra-red radiations, by M. Mouton.—Solar spots and protuberances observed with a spectroscope having great dispersion, by M. Thollon.—Measurement of the electromotive force of contact of metals by the Peltier phenomenon, by M. Pellat.—Description and use of the telescope and scale of Edelmann, by M. Terquem.

*Journal of the Franklin Institute*, April.—Naval architecture, by Mr. Haswell.—Saws, by Dr. Grimshaw.—Engraving, by Mr. Sartain.—On D'Auria's engine-governor and the action of governors in general, by Prof. D'Auria.—A new hypothesis regarding comets and temporary stars, by Prof. Tubin.

*Rivista Scientifico-Industriale*, No. 6, March 31.—On a case of permanent polarity of steel opposite to that of the magnetising helix which produces it, by Prof. Righi.—Reflexions on an experimental and fundamental principle in hydrostatics, by Prof. Cantoni.—On Elban topaz, by S. Corsi.

No. 7, April 15.—Radiant matter and the theory of Crookes, by S. Piazzoli.—Pliocene fossils of the yellow sand found in the neighbourhood of Vigne, Schifanoia, and Montoro (Narni), with a suggestion as to the subapennine formation of these three places, by S. Terrenzi.

*Reale Istituto Lombardo di Scienze e Lettere. Rendiconti*, vol. xiii. fasc. iii.—On Garovaglinese, a new tribe of Collemaea, by S. Trevisan.—Comparison of the winter 1879-80 with the preceding one in Milan, by Prof. Hajech.—Diurnal oscillations of the declination-needle, in 1879, at the Brera Observatory, Milan, by Prof. Schiaparelli.—Transfusion of blood into the peritoneum in an oligocytic lunatic; effects on the circulation of blood and on the general state of the patient, by Profs. Golgi and Raggi.—The nephroscope, an instrument for determining the direction of motion of clouds, by Prof. Fomiori.

## SOCIETIES AND ACADEMIES

### LONDON

Royal Society, April 22.—“On the Critical State of Gases.” By William Ramsay, Ph.D., Professor of Chemistry in University College, Bristol.

It is well known that at temperatures above that which produces what is termed by Dr. Andrews the “critical point” of a liquid, the substance is supposed to exist in a peculiar condition, and Dr. Andrews purposely abstained from speculating on the nature of the matter, whether it be liquid or gaseous, or in an intermediate condition, to which no name has been given. As my observations bear directly on this point, it may be advisable first to describe the experiments I have made, and then to draw the deductions which appear to follow from them.

A piece of barometer tubing about three inches long was sealed at one end and drawn into a capillary tube at the other; after being filled with methyl formate it was exhausted, and after two-thirds of the ether had evaporated was sealed. By this means all air was removed from the tube, which contained merely the ether and its vapour.

1. On applying heat the temperature gradually rose to 221°5

(corr.); during the rise the meniscus of the liquid gradually became less curved, and at the above-mentioned temperature disappeared. On cooling to 218° a mist was seen at the point where the meniscus had disappeared, and the meniscus shortly afterwards became again visible.

2. Two similar tubes were prepared, one containing less and the other more of the same ether; the point at which the meniscus disappeared in the former was 228°, and in the latter 215°.

3. A tube of the shape shown was filled to the mark with methyl formate and heated in an inclined position, the portion containing the liquid being the lower. The liquid, as usual, expanded, and at the moment when the meniscus disappeared it nearly filled the lower half. The source of heat was then withdrawn, and on cooling the liquid all condensed in the lower half.

4. The last experiment was varied by tilting the tube after the meniscus of the liquid had disappeared, so that that half which had contained the liquid was uppermost. On cooling, the liquid condensed in the upper half of the tube.

5. The experiment was again varied by keeping the tube at a temperature a few degrees above the point where the meniscus vanished, for half an hour. On cooling, an almost equal quantity had condensed in each division of the tube. (During Experiments 3, 4, and 5, great care must be taken to keep the heater from draughts of cold air, otherwise unequal cooling results and distillation takes place.)

6. It was noticed that that half of the tube containing liquid, after the meniscus had vanished, appeared full, while the other half of the tube seemed to be empty. The refractive indices of the fluid contained in the tubes were therefore different. The portion of the tube containing liquid was shown to be a more powerful cylindrical lens than the empty portion, for on focussing a spot behind the tube with a microscope, the focus was shorter when the portion which had contained liquid was placed between the microscope and the spot than when the portion appearing empty was interposed.

7. From experiments on the expansion of liquids above their boiling-points, of which numerical details shall be given on a future occasion, it appears probable that the specific gravity of the hot liquid, at the temperature at which the meniscus vanishes, is identical with that of the compressed gas evolved from the liquid. This has also been noticed by Ansdell in two cases, viz., hydrogen chloride and acetylene.

8. From observations on the expansions of liquids at high temperatures it has been proved that liquids above the temperatures at which their menisci vanish are not uniformly compressible.

From these observations I would draw the following inferences:—When a liquid is heated under pressure it expands, and at the same time evolves vapour. The vapour gains in specific gravity, while the specific gravity of the liquid is rapidly diminishing. The critical point is that point at which the liquid, owing to expansion, and the gas, owing to compression, acquire the same specific gravity, and consequently mix with one another. From the first experiment it is seen that, on cooling, the liquid contracts more rapidly than the gas, and consequently separates as a mist through the whole of the tube, and, from its gravity, separates at the lower half. The second experiment shows that when the tube contains a small amount of liquid the space left for gas is larger, and consequently more vapour must be given off by the liquid before enough gas can be compressed till it acquires the same specific gravity as the liquid; the temperature at which the meniscus disappears is consequently higher. If the space left for gas be smaller, the opposite is the case. The fourth, fifth, sixth, and seventh experiments demonstrate that by suitable means it is possible to prevent, or rather to retard, the mixing of gas and liquid. They then retain their several refractive indices. If, however, time be allowed for diffusion through the capillary tube, the whole becomes homogeneous, and the refractive indices of the fluids contained in either portion of the tube are then identical.

So long as gas is being compressed, pressure rises gradually with decrease of volume, whereas, even above their critical points, liquids are comparatively incompressible.

In conclusion, let me refer to a paper communicated to the Society by Messrs. Hannay and Hogarth last October, entitled “On the Solubility of Solids in Gases.” Should the views of the subject suggested by the above experiments be correct, it follows that these gentlemen have observed nothing unusual, but

merely the ordinary phenomenon of solubility of a solid in a hot liquid. This view is borne out by their own experiments. They found that on reducing pressure, that is, on allowing the liquid to change to gas, the solid precipitated; and also on heating the tube containing the solution locally, that is, by converting the liquid near the heated point into gas, precipitation took place. I have taken the liberty of repeating one of their experiments with a slight modification.

A tube shaped like that used in Experiment 3, after a small fragment of potassium iodide had been placed in the lower compartment, was filled with nearly anhydrous alcohol; and after rather more than two-thirds of the alcohol had been evaporated under reduced pressure, the tube was sealed. The lower portion of the tube contained a strong alcoholic solution of potassium iodide, besides a small piece of undissolved salt. The upper portion of the tube was free from alcohol, but its walls were incrustated with a thin crystalline film of potassium iodide. The tube was heated in a sloping position, the liquid being in the lower half. After the meniscus had disappeared, the iodide in the lower half of the tube dissolved, while the film in the upper half, even in its thinnest portions, remained unchanged. On cooling, very sparkling crystals deposited in the lower half of the tube, but no glittering crystals in the upper half.

By repeated distillation the iodide in the upper portion of the tube was washed down into the lower half, and when dry the sides of the upper tube were quite bright and clean. The tube was again heated in the same position to 20° above the temperature at which the meniscus had disappeared. On cooling, the sparkling crystals again appeared in the lower tube, but not a trace in the upper tube. To eliminate all possibility of mistake the experiment was repeated five times with the same result, and finally the alcohol was distilled into the upper tube; it was then broken off, and its contents carefully tested for iodine with sodium hypochlorite and starch-paste. There was not the faintest blue colour, and it is therefore certain that potassium iodide is absolutely insoluble in alcohol vapour.

Messrs. Hannay and Hogarth also found that the absorption spectrum of coloured salts remains unaltered, even when the liquid in which they are dissolved loses its meniscus. Surely no clearer proof is needed to show that the solids are not present as gases, but are simply solutions in a liquid medium.

To eliminate any source of error dependent on the use of methyl formate, two other substances were employed, viz., carbon disulphide, CS<sub>2</sub>, and carbon tetrachloride, CCl<sub>4</sub>. The former of these liquids was rectified five times over sodium, and then boiled at 48.7 (corr.). The latter was rectified four times over phosphoric anhydride, and boiled constantly at 77.5 (corr.).

They yielded the following results:—

	Tube more than half full.	Tube less than half full.
CS <sub>2</sub> ... ..	282.7 ... ..	286.4 ... ..
CCl <sub>4</sub> ... ..	283.3 ... ..	288.4 ... ..

These readings are given for the first appearance of a cloud in the tube on cooling, and differ from the temperature at which the meniscus disappears by being about half a degree lower. They also do not represent extreme instances, for in the first cases the liquids do not entirely fill the tube, and in the second about half an inch of liquids remains in the tubes before it becomes impossible to distinguish liquid from gas.

The experiments described in a former part of this paper, relating to the difference of refraction shown by a liquid above its so-called critical point, and the gas evolved from it, were repeated with carbon tetrachloride and carbon disulphide, and held good in both cases. The phenomena observed differed in no particular from those already described.

In conclusion, a few remarks on the liquefaction of the so-called permanent gases may not be deemed out of place. If the deductions from the above experiments be correct, it follows that that form of matter which we call gas may be converted into liquid by pressure alone; but the meniscus will never become visible, for the process of change is a gradual one. To render the meniscus visible it is necessary to take advantage of the fact that liquids under such circumstances have a much greater coefficient of expansion by heat, and conversely, a much greater coefficient of contraction on withdrawal of heat, than gases. It therefore becomes necessary to lower the temperature until the liquid by contraction acquires a specific gravity greater than that of its gas, and then, and not till then, does the phenomenon of a meniscus become observable.

April 29.—“On the Diurnal Variation in the Amount of

Carbon Dioxide in the Air.” By George Frederick Armstrong, M.A., F.G.S., C.E., Professor of Engineering in the Yorkshire College, Leeds. Communicated by Prof. Thorpe, F.R.S.

Summarising the results contained in this communication, it may be stated—

1. That the normal amount of carbonic acid present in the air of the land is distinctly less than that usually stated, and that it does not exceed 3.5 vols. in 10,000 of air.
2. That plants absorb carbonic acid during the day and exhale it at night, and that vegetation therefore affects the quantity of carbonic acid present in the air, decreasing it by day and increasing it at night.
3. That from this cause there is, during that part of the year when vegetation is active, at least 10 per cent. more carbonic acid present in the air of the open country at night than during the day.

Chemical Society, May 6.—H. E. Roscoe, president, in the chair.—The following papers were read:—On the action of sodium on phenylic acetate, by W. H. Perkin, jun., and W. Hodgkinson. Hydrogen, acetic ether, phenol, acetic acid, salicylic acid, a white crystalline substance melting at 48° C., having the composition C<sub>15</sub>H<sub>12</sub>O<sub>8</sub>, and a yellow crystalline substance melting at 138°, having the composition C<sub>18</sub>H<sub>14</sub>O<sub>4</sub>, were obtained; by heating cresylic acetate and sodium, acetic ether and salicylic acid were formed.—Preliminary notice on the action of sodium on some ethereal salts of phenylacetic acid, by Dr. Hodgkinson. The first products of this action are the corresponding ethylic, &c., ethers of phenylacetic acid. The phenyl group being replaced by hydrogen, it reacts with sodium on another portion of the original ethereal salt, forming various liquid and solid bodies, which the author has investigated, but whose constitution is as yet undetermined.—On the determination of nitrogen in carbon compounds, by C. E. Groves. The author described and exhibited an improved and simple apparatus for facilitating the collection and measurement of the nitrogen evolved during the combustion of a substance according to Dumas' method.—On essential oil of sage, by M. M. P. Muir. The composition of this oil varies with its age, salvol and camphor being formed as it gets older. English sage-oil contains cedrene. The terpene of sage-oil is identical with that of French turpentine. The author has examined the action of oxidising agents, phosphorous pentachloride, and bromine.—On the presence of nitrogen in iron and steel, by A. H. Allen. By passing steam over iron at a red-heat, and also by dissolving iron in hydrochloric acid, the author has satisfactorily proved that ammonia is formed equal to 0.0041 to 0.0172 parts of nitrogen per hundred parts of iron and steel.—On the mode of application of Pettenkoffer's process for the determination of carbonic acid in expired air, by Dr. W. Marcat. The author describes and figures a portable apparatus which he has successfully used in upwards of 350 determinations of carbonic acid made during some investigations on the effect of altitude on the phenomena of respiration.—On an improved form of oven for heating sealed tubes and avoiding risks of explosions, by Watson Smith.—Note on a convenient form of lead-bath for Victor Meyer's apparatus for determining the vapour-densities of high boiling substances, by Watson Smith.

Anthropological Institute, April 27.—Major-General A. Pitt-Rivers, F.R.S., vice-president, in the chair.—Edward Tyrrell Leith, LL.M., was elected a new member.—A paper entitled “Further Notes on the Romano-British Cemetery at Seaford, Sussex,” by Mr. F. G. Hilton Price and Mr. John E. Price was read. It was a continuation of one read before the Institute by the same authors in November, 1876. During the summer of 1879 these gentlemen again visited Seaford, and made further excavations in the Roman Cemetery upon the Downs, in which they discovered several urns, a drinking cup of Durobrivian pottery, Samian patenæ, flint celts of the neolithic type, and many flint flakes. In one particular interment a large urn full of charred human bones was discovered, having a Samian cup in its mouth for the purpose of keeping out the earth, another cup of elegant form of Durobrivian ware was found on its left side, and a food vessel and patera of Upchurch pottery on the right side. In close proximity to this interment was a similar one; the urn was much crushed, but beneath a patera of Samian ware a coin of Faustina Junior, the daughter of Antoninus Pius and wife of Marcus Aurelius, was found. This was most important as giving an approximate date to the interments; they could not be earlier than between A.D. 161-180. In another



part of the Downs, in a place called the Little Bury, black patches were of frequent occurrence in the sand, which were composed of charcoal, fragments of burnt bone, a flint flake or two, and frequently iron nails. In one particular spot a batch of over ninety iron studs was found, mixed up with bone ashes and charcoal. The authors considered that the patches of charcoal without an urn indicated pauper burials, or the burials of soldiers, as this place was a military station. The pottery and other relics discovered were exhibited.—General A. Pitt-Rivers exhibited a series of plans and relics from Mount Caburn.

**Photographic Society, April 6.**—J. Glaisher, F.R.S., president, in the chair.—Mr. J. H. Dallmeyer, F.R.A.S., read a paper on principles of optics involved in lantern construction; and on a new enlarging lens especially designed for use with the magic lantern, in which he described all previous existing objective lenses and condensers and the scientific principles which ought to be observed in their construction, and then exhibited and described a new condenser he had constructed containing the essentials required, viz., quantity and quality of light; also a new objective lens which gave equal definition at the margin as well as at the centre of the picture, freedom from distortion, and perfect achromatism.—A paper was read by Capt. Abney, R.E., F.R.S., on the use of silver iodide in a gelatino-bromide emulsion, showing that the introduction of iodide into the ordinary gelatino-bromide emulsion did not decrease its sensitiveness, as also that it permitted the use of an ordinary yellow light to work in—same as for wet collodion.—Also a paper, by W. England, on a drying box for gelatine plates.

GÖTTINGEN

**Royal Society of Sciences, January 10 (continued).**—On horacite, by Herr Klein.

February 7.—The affinity-grouping of old German dialects, by Herr Buzzenberger.—On physiological retrogression of ovarian eggs in mammals, by Dr. Brunn.—On sexual propagation of *Dosidulus clavaformis*, Ag., by Herr Berthold.—The theory of numerical-theoretical functions, by Prof. Cantor.—On a class of functions of several variables which arise by inversion of the integral of solution of linear-differential equations with rational coefficients, by Herr Fuchs.

March 6.—On the theory of partial linear differential equations, by Dr. Krankenhagen.

VIENNA

**Imperial Academy of Sciences, January 22.**—The following papers, &c., were read:—The Diptera of the Imperial Museum in Vienna, by Prof. Brauer.—On projectivities and involutions in plane rational curves of the third order, by Prof. Weyr.—The periods of springs, by Herr Klönne.—On the behaviour of phenanthrenchinon towards ammonia, by Prof. Sommariva.—On chlorhydrate of morphin, by Herr Tausch.—The more recent deposits on the Belle-pont, by Prof. Neumayr and Herr Calvert.—Survey of the geological relations of a part of the Aegean coast lands, by Prof. Neumayr, Dr. Bittner, and Fr. Teller.

February 5.—Communications from the Embryological Institute of Vienna University, by Prof. Schenk.—The respiratory apertures of the Marchantiaceae, by Prof. Leitgeb.—On nectar-secreting trichomes of some species of *Melampyrum*, by Prof. Rathay.—On the yearly period of the insect-fauna of Austria-Hungary. V. Rhynchota, by Herr Fritsch.—Electric action on the formation of flames, by Herr Goldstein.—On the probable errors and the available results of calculation deduced from imperfect numbers, by Dr. Rotter.—Tables of observations at the Central Institute for Meteorology and Magnetism.

PARIS

**Academy of Sciences, May 3.**—M. Edm. Becquerel in the chair.—The following papers were read:—On the transcendents which play a fundamental part in the theory of planetary perturbations, by M. Tisserand.—On the gases retained by occlusion in aluminium and magnesium, by M. Dumas. While silver impregnates oxygen, aluminium and magnesium specially retain hydrogen. The substances were heated to a high temperature *in vacuo*. The 89.5 c.c. gas given off by 200 gr. aluminium (representing 80 c.c.) at 17° and 755 mm., contained 1.5 c.c. CO<sub>2</sub> and 88.0 c.c. H<sub>2</sub>; 20 gr. magnesium gave 12.3 c.c. H<sub>2</sub> and 4.1 c.c. CO. (In another case there was both CO and CO<sub>2</sub>.) The whole of the magnesium was volatilised and condensed in stalactites (in great purity) about the neck of the retort.—On the cholera of fowls; study of the conditions of non-recurrence of the malady, and of some others of its characters, by M. Pasteur. The extract

of a filtered culture-liquid of the microbe, when injected, produces sleep (for a time); the microbe seems to generate a narcotic during its life. This effect is independent of disorders produced by multiplication of the parasite in a fowl's body. The malady sometimes occurs in a chronic form.—On extension of the theory of germs to the etiology of some known maladies, by M. Pasteur. He shows reasons for attributing boils, osteomyelitis, and puerperal fever to the development of minute organisms.—On a letter of Admiral Cloué relative to water-pouls, by M. Faye.—Formation of leaves and appearance of their first vessels in Iris, Allium, Funkia, Hemerocallis, &c., by M. Trécul.—On the law of reciprocity in the theory of numbers, by Prof. Sylvester.—Experimental researches on the decomposition of some explosives in a closed vessel; composition of the gases formed, by MM. Sarran and Vieille. The products are indicated in the case (1) of pure gun-cotton (this gives, per kgm. of substance, 741 litres of gas made up of 234 CO, 234 CO<sub>2</sub>, 166 H<sub>2</sub>, and 107 N), (2) of a mixture in equal parts of gun-cotton and nitrate of potash, (3) of a mixture of 40 parts gun-cotton and 60 nitrate of ammonia, (4) of nitroglycerine, (5) of ordinary blasting-powder.—Cometary paraboloids, by Mr. Chase.—On simultaneous linear equations, and on a class of non-plane curves, by M. Picard.—On Gauss's formula of quadrature, by M. Callandreau.—Theorem on cubic and biquadratic equations, by M. Desboves.—General equation giving the relation which exists for all liquids between their temperature and the maximum tension of their vapours at this temperature, by M. Pictet.—Résumé of the laws which rule matter in the spheroidal state, by M. Boutigny. The fifth law, that of repulsive force at a sensible distance, is represented as the most important, because antagonistic to universal attraction. Non-volatile bodies (as pieces of wax, tallow, stearic or margarine acid, &c.), are suspended in a heated capsule, without vapour or gas arising from their decomposition. Water dropped, e.g., from the top of the Pantheon, 70 m. high, on a heated capsule at the bottom, is repelled instantaneously by the repulsive force generated by the heat in the capsule.—Dissociation of the hydrate of butyl-chloral, by MM. Engel and Moitessier. They find here a new confirmation of the law they formulated; the dissociation of a body whose two components are volatile does not take place in presence of the vapour of one of the components at a tension above that of dissociation of the compound.—On the determination of glycerine in wines, by M. Raynaud.—On legumine, by M. Bleunard.—On gelose, by M. Porambart.—Variations of temperature with the altitude for the great coldest of December, 1879, in the valley of the Seine, by M. Lemoine. The data agree with those lately given by M. Alluard.—On the variability of tests in the oviducts of the Lower Cevennes, by M. Taton.—On the structure of some Corallidæ, by M. Merejkowsky.—On the analogies which seem to exist between cholera of fowls and nelavan, or the malady of sleep, by M. Déclot.

CONTENTS

PAGE

MIGRATORY BIRDS AT LIGHTHOUSES . . . . .	25
THE RIVER OF GOLDEN SAND . . . . .	26
OUR BOOK SHELF:—	
"The Geological Record for 1877" . . . . .	28
Colvée's "Ensayo sobre una nueva enfermedad del Olivo" . . . . .	29
LETTERS TO THE EDITOR:—	
Winter "Swallows."—Prof. ALFRED NEWTON, F.R.S.	29
Does Chlorophyll Decompose Carbonic Acid?—Dr. JOHN WILLIAM DWAFER . . . . .	29
On a Point Relating to Brain Dynamics.—S. TOLVER PRISTON . . . . .	29
Curious Botanical Phenomenon.—M. F. . . . .	30
Carboniferous Forest at Oldham.—JAS. FIELD . . . . .	30
Fungus Inoculation for Insects.—J. P. LESLEY . . . . .	31
Carnivorous Wasps.—AN OLD ENTOMOLOGIST . . . . .	31
Seeing by Telegraphy.—JOHN PERRY; W. E. AYRTON . . . . .	31
Anchor-ice.—C. F. C. . . . .	31
FURTHER OBSERVATIONS AND RESEARCHES ON FLUSS'S SYSTEM OF DIVING AND LIVING IN IRRESPIRABLE ATMOSPHERES. By Dr. B. W. RICHARDSON, F.R.S. . . . .	32
THE AURORA BOREALIS. By WARREN DE LA KUR, M.A., D.C.L., F.R.S.; HUGO W. MÜLLER, Ph.D., F.R.S.; ROBERT H. SCOTT (With Illustrations) . . . . .	32
A SCOTTISH CRANNOG. By Dr. ROBERT MUNRO (With Illustrations) . . . . .	34
THE UNITED STATES WEATHER MAPS, AUGUST, 1878 . . . . .	35
THE IRON AND STEEL INSTITUTE . . . . .	35
NOTES . . . . .	37
GEOGRAPHICAL NOTES . . . . .	41
ON ELECTRIC LIGHTING. By Dr. JOHN HOPKINSON, F.R.S. (With Diagrams) . . . . .	4
PRELIMINARY REPORT BY THE COMMITTEE ON SOLAR PHYSICS APPOINTED BY THE LORDS OF THE COMMITTEE OF COUNCIL ON EDUCATION . . . . .	44
UNIVERSITY AND EDUCATIONAL INTELLIGENCE . . . . .	45
SCIENTIFIC SERIALS . . . . .	45
SCIENTIFIC AND ACADEMIC . . . . .	46

THURSDAY, MAY 20, 1880

## THE SCIENCE OF LANGUAGE

*Introduction to the Science of Language.* By A. H. Sayce, Deputy Professor of Comparative Philology in the University of Oxford. Two vols. (London: Kegan Paul and Co., 1880.)

THIS admirable treatise may be broadly described as the fitting complement and sequel to the author's "Principles of Comparative Philology." The method and theories of that work, as he is careful to remind us in the preface, form the solid basis of the present, and it is not saying too much to add that both together stand unrivalled as the most systematic and exhaustive treatise on the Science of Language in its present state that has yet appeared in our literature. At the same time the present work is sufficiently complete in itself to be read with pleasure and studied with profit by those who may be unacquainted with its forerunner, though this must still remain indispensable to a thorough grasp of the subject.

The author shrewdly remarks (i. 159) that "the comparative philologist should not introduce the frame of mind of the specialist into his comparative inquiries. The specialist who takes up comparative philology as a subsidiary pursuit is likely to spoil it in the taking." Being thus forewarned against an obvious danger, he has not yielded to the temptation of giving undue prominence to any particular branch, nor has he allowed his personal partiality for Assyrian studies in any way to interfere with the broad and catholic spirit pervading the whole work. This catholic spirit, constituting one of its special merits, is everywhere conspicuous, and nowhere more so than in his comprehensive classification of comparative philology into the three great divisions of phonology, sematology, and morphology (i., 141). This classification at once gives its due position to that more spiritual, though hitherto almost totally neglected, aspect of the subject which deals with the inner meaning, as phonology does with the outward or material sound of words. The difficulties associated with this branch, for which the happy term sematology is here adopted, are fully recognised; its somewhat vague and uncertain character, and the intricate psychological phenomena surrounding it, all receive due prominence. But a limit is assigned to the arbitrary and to the element of chance, and if a science of sematology is not already established on a solid basis, the course that research must take in this direction is at all events ably foreshadowed. The delicate modifications of meaning that words undergo in their historic life must be carefully noted, the general causes underlying them analysed and formulated, significant change reduced to definite principle and broadly generalised.

His philosophic classification of his subject enables the writer satisfactorily to settle a point still much discussed by philologists. Whether language is to be grouped with the natural or historical sciences is a question which, he justly remarks, has arisen from the partial views that have been taken of its true character. Speech is not mere sound, nor even articulate sound alone, for many animals can articulate, but articulate sound significant.

VOL. XXII.—No. 551

*Terminus*, said the schoolmen, *est vox significans*, and for Mr. Sayce the terminus or "word," as here used, is speech, for the isolated term has no independent or abstract existence, and the unit of speech is not the word, but the sentence. It thus becomes impossible to separate the sound from its meaning, phonology from sematology. But phonology, or the outward aspect of language, is confessedly physiological, and subject to purely physical or natural laws, while sematology is essentially historical. And so the whole difficulty is solved; for "if we claim for the science of language in general the rank of a historical science, it is only because the meaning, rather than the sound, is the essence of speech, and phonology the handmaid and instrument rather than the equivalent of glottology" (i. 165). But "the method pursued by the science of language is the method of physical science; and this, combined with the fact that the laws of sound are also physical . . . has occasioned the belief that the science of language is a physical science. But such a view results in identifying phonology and glottology, in making a subordinate science equivalent to the higher one, and in ignoring all those questions as to the nature and origin of language which are of supreme importance to the philosophy of speech" (*ib.*).

In the chapter devoted to the morphology of speech the attempt made by Hovelacque and some other recent writers to identify polysynthesis with agglutination receives no countenance. That attempt could obviously lead to nothing but hopeless confusion, for "the conception of the sentence that underlies the polysynthetic dialects is the precise converse of that which underlies the isolating or the agglutinative groups" (i. 126). This question has been elsewhere dealt with somewhat fully by this writer,<sup>1</sup> and it is to him a source of no little satisfaction to find his views here so fully endorsed. At the same time it seems difficult to accept the author's theory that polysynthesis is "the undeveloped sentence of primitive speech," and that "the polysynthetic languages of America preserve the beginnings of grammar, just as the Bushman dialects have preserved the beginnings of phonetic utterance" (ii. 216). For it is hard to believe that primeval man began to speak in "sesquipedalian verba," and in any case the presence of true pronouns in these lengthy sentence-words is alone sufficient to show that polysynthesis is itself a development, the outcome of slow fusion and of long ages of gradual phonetic decay. The Bushman clicks form very probably a connecting-link between articulate and inarticulate utterance. But the pronoun in all languages stands on a far higher relative level; it cannot be conceived as a primordial cut-and-dry invention, for it is an abstraction of a high order, whereas the first beginnings of speech must all have been made up of the crudest concrete concepts combined with involuntary or mechanical ejaculations.

But one of the peculiar charms of the present work is the extreme fairness of the author, who is always ready to recognise the cogency of objections to favourite theories, so that the reader feels that both sides of the question have been fairly placed before him. A good instance occurs at p. 209 of vol. i., where the weakness of Sagard's

<sup>1</sup> In Appendix to the "Central and South America" of "Stanford's Compendium."

testimony to the evanescent character of the Huron language is frankly acknowledged. Many other moot questions are touched with great impartiality, and it is well remarked that divergence of opinion is a healthy sign of life and scientific progress; for "it is only by the conflict and discussion of theories that truth can finally be reached, and the many controversies excited by the science of language show how broadly and deeply the foundations of the science are being laid" (i. 87).

A statement, however, is made a little further back which will perhaps cause some surprise, as tending to shake these very foundations and call in question conclusions that seemed almost universally accepted. The theory of evolution, which may be said to underlie all modern thought, and which has already passed almost beyond the pale of discussion, has naturally tended to remove much of the confusion previously associated with the various conflicting opinions entertained regarding the origin of human speech. For if true at all it is evident that this great principle must be of universal application, and when applied to language the inference was irresistible that there can be no immutable types of speech, any more than there are immutable animal and vegetable species. Hence the necessary conclusion that all present forms of speech are modifications of previously existing forms, that, however slowly, all are continually shifting, possibly retrograding under unfavourable conditions, but in the normal state advancing, for the history of evolution is on the whole the history of progress. A careful study of the texture of speech seemed fully to confirm these *à priori* deductions, and a general consensus was thus arrived at that there must have been some hypothetical root-state out of which language was slowly evolved, passing successively through lower to higher types, from the isolating to the polysynthetic, agglutinating, incorporating, inflectional, and analytic orders.

But in seeming opposition to these views the author holds that it cannot be proved that the primæval root-language ever existed, and that "equally unproved is the belief that isolating dialects develop into agglutinative, and agglutinative into inflectional" (p. 75). And at p. 131, while admitting the general doctrine of evolution, he seems still to argue for the immutability of linguistic types, though his language is here somewhat deficient in its usual clearness and point. "The Finnic idioms," he writes, "have become so nearly inflectional as to have led a recent scholar to suggest their relationship to our Aryan group; nevertheless they have never cleared the magical frontier between flexion and agglutination, hard as it may be to define, since to pass from agglutination to inflection is to revolutionise the whole system of thought and language and the basis on which it rests, and to break with the past psychological history and tendencies of a speech."

Here it should be observed that the author may not inconsistently deny the necessary development of agglutination into inflection, because he does not regard the latter as a higher type than the former, and because he takes, not the word or root, but the sentence, as the unit and starting-point of all speech. Now the sentence may have been originally cast in an agglutinative form, and if so agglutination would neither imply development in itself nor any necessary further evolu-

tion in a new direction. This, at least, we take to be the underlying argument, though it appears nowhere explicitly stated in this way. It is stated, however (p. 131), that by taking the sentence as the unit "there is no longer any difficulty in distinguishing between the several families of speech and assigning to each its character and place."

To all this many will of course reply that to take the sentence as the starting-point is to beg the whole question. It cannot, of course, be denied by the consistent evolutionist that there must have been a time when a single articulate utterance supplemented by tone and gesture, did duty for a whole sentence, and in this sense it may be admitted that the sentence is the starting-point of speech. But whether this incipient state can be regarded as constituting language, properly so called, is quite another matter, and in any case it could not be predicated of such language that it was either agglutinating or polysynthetic, or even isolating in the sense that Chinese or Annamese is isolating. Here we are, in fact, dealing rather with the germs of the plant than with the plant itself.

It will further be urged that if "the Finnic idioms have become so nearly inflectional," progress from agglutination in the direction of inflection is admitted, in which case the fact that "they have never cleared the magic frontier" becomes what the French would call a mere detail, a question of time or other circumstances. The Magyar has already developed an article, and the Dravidian tongues possess what look remarkably like true case-endings, while more than one language of the Caucasus, notably Georgian, Chechenez, and Lesghian, have apparently passed quite over to the inflecting state. The fact that this transition "revolutionises the whole system of thought and language" will not alarm those evolutionists who necessarily hold that revolution is the law of nature and the order of the universe. Only the great issues are worked out *sensim sine sensu*, and not by violent cataclysms and fresh creations, as was formerly supposed by unorthodox interpreters of a book which allows of but one creation and one partial cataclysm. Lastly, the critical analysis of agglutination, and still more of inflection, clearly shows that both are the result of sematological and phonetic decay continued over immense periods of time, during which numbers of concrete terms and notional words of all sorts gradually lost their independence, and thus became transformed to relational particles first loosely tacked on (agglutination), and then completely fused (inflection) with the theme. Thus it is that the passing vagaries of deep thinkers serve but to re-establish on firmer ground the very truths they seem to assail.

On other questions the work is equally suggestive, and there are some trenchant remarks at p. 349 of vol. i. which ought definitely to close the doors of the old school of etymologists. "The etymologist must be thoroughly trained in the principles of scientific philology. He must have mastered both phonology and sematology, and he must be well acquainted with more than one of the languages with which he deals. Then and then only can his labours be fruitful; then and then only will his work be a gain and not a hindrance. False etymologies stand in the way of true ones, and the charlatans who have brought the name of etymology into contempt have

discredited the labours of better men. There is much in etymology which must always defy analysis, there is much which will have to be corrected hereafter, but this will matter little if we have once learnt the lesson that change of sound and meaning can only take place in accordance with fixed and invariable law. Etymology is but a means to an end, and that end is partly the history of the development of thought and civilisation as reflected in the fossil records of speech, partly the discovery and illustration of the laws which govern the shifting and decay of sounds and the modifications of sense."

The whole subject of phonetics is of course treated in a masterly manner, and well illustrated with diagrams and useful tables of Lautverschiebung as applicable to the Semitic, Bantu, Finno-Tataric, and Aryan families. The last, especially, is very full, including the Oscan and Umbrian, the Old Welsh and Gaulish, besides those usually given. It need scarcely be added that this, like all other branches, is brought well up to date, a good instance of which is afforded by the reference to the use already made of the phonograph in the scientific treatment of phonetics. Most readers will here learn, probably for the first time, the curious fact that "all sounds may be reproduced backwards by simply beginning with the last forms indented on the tin-foil: *sociability*, for example, becoming *ytibilaishos*. Diphthongs and double consonants may be reversed with equal clearness and precision, so that *bite*, which the phonograph pronounces *bā-ect*, becomes *tee-ab*. In this way we have learnt that the *ch* of *cheque* is really a double letter, the reversed pronunciation of the word being *kesht*" (i. 335).

The question of mixed languages, that is, mixed in their structure, claims a good deal of attention, and is handled with considerable reserve. But the important truth is loudly proclaimed that the "physiological races of the modern world are far more mixed than the languages they speak; the physiologist has much more difficulty in distinguishing his races than has the glottologist in distinguishing his families of speech" (i. 366). This is perhaps as far as it is safe to go at present, and is sufficient for practical purposes. It points out that it is in the nature of ethnical groups to mix, and of linguistic groups to keep aloof, thus vindicating for language its rightful position in anthropological studies. It is not always or necessarily a test of race, but it is often an indispensable collateral agent of research, becomes under special circumstances, and with all due precaution, a final court of appeal, and in many cases bears witness to the presence of racial elements which would not otherwise be suspected. Its development also is extremely slow, slower even under certain conditions than that of physical types themselves, as shown, for instance, in the case of the Osmanli, Magyars, and many Finnish and Turkoman tribes, all of whom continue to speak purely agglutinating Finno-Tataric tongues, although through intermixture they have been largely assimilated to the Caucasian ethnical type.

The chapter on Roots (vol. ii.) is accompanied by a table of all known languages, for the classification of which Fr. Müller seems mainly responsible. The appended references to authorities will be found extremely useful, but the classification itself is defective in many

respects, and calls for revision in future editions. Sonrhay and Haussa, for instance, ought not to be grouped together, nor have Wakuafi (read Ki-Kwafi) and Masai anything in common with the Nuba and Fulah groups. It is not clear why Berber any more than Egyptian (both Hamitic) should be described as sub-Semitic; but it is still more startling to find Brahui amongst the neo-Sanskritic tongues in company with Siah-Pôsh, which latter would appear to belong rather to the Galcha or pre-Sanskritic of the Eastern Turkestan Highlands, and which is unaccountably excluded altogether from the table. Etruscan, in spite of Corssen, is grouped apart as agglutinating, though there are many good authorities for this view. But Horpa is not a Tibeto-Burman isolating tongue, nor are Lolo and Mautse properly linguistic terms, but rather collective Chinese names of hill-tribes, mostly probably of Caucasian stock and untuned speech. The "Mon-Annam" family has no existence, the Mon or Talain having little to do with the Annam, and nothing at all with Kambojan, which belongs to a totally different connection. The Miztec, Matlalzinca, Totonac, and other Mexican tongues are described as isolating, all being polysynthetic, some, such as the Miztec, in the very highest degree with "bunch-words" of fifteen and even seventeen syllables.

The second volume is largely occupied with some of the principal linguistic families typical of the several orders of speech, followed by concluding chapters on Comparative Mythology and the Origin of Language, all handled in a masterly manner, extremely suggestive even when somewhat heterodox, and accompanied by much incidental matter of great value and interest. The statement (p. 324) that "the characteristics of race were fixed before the invention of speech" is one of those astonishing paradoxes which seem inseparable from original thought, but which remain none the less paradoxes. It is scarcely conceivable that the yellow, black, fair, and other fundamental types of mankind should have become slowly differentiated before man had acquired the faculty of speech, that is, the very faculty by which the human is distinguished from all other species, and that the art was then "invented" in various independent centres. But though it cannot be argued on this ground that "the idioms of mankind have had many independent starting-points" (p. 323), few will probably question the conclusion that linguistic science "can throw no light on the ethnological problem of the original unity or diversity of the human race" (p. 324). Such questions are truly "the task of the ethnologist, not of the student of language" (*ib.*) And even should the hope have to be finally abandoned of ultimately establishing the original unity of human speech, no argument could thence be deduced in favour of the original diversity of the human species. Dispersions of babbling tribes, whether originally one or not, probably took place at various stages in the evolution of human speech, or at times while it was still in process of formation, or when little more than the faculty existed, so that it must needs have afterwards developed into types no longer reducible to one hypothetical primæval type. This hypothetical type becomes daily more shadowy, continually retreating to the background of an inconceivably remote past, according as the astonishing complexity and diversity of articulate speech is revealed to the earnest student of

language. But it seems obvious that this diversity and complexity must have been evolved in the natural course, whether starting from one or many original centres.

At p. 163 a view is taken of the Aryan suffixes which many will be inclined to regard as a retrogressive step rather than an advance in linguistic studies. "We must rid ourselves of the notion that suffixes were ever independent words like our 'if' or 'in'; so far back as our knowledge of Aryan speech extends they possessed no existence apart from the words to which they belonged, and which, again, only existed as words in so far as they possessed these suffixes. Suffixes became flexions through the help of analogy." The point would involve too much technical matter to be here adequately discussed, but it may be remarked that our knowledge of Aryan speech is as of yesterday compared with the many ages it must have taken to reach the highly-inflected state presented by the oldest known members of the family. If in a brief thousand years or thereabouts the Latin ablative *ment:* had time to become a Romance adverbial suffix, the verb *habeo* a verbal ending, and the adverb *inde* a pronoun with a genitival force, surely there was ample time in the ten, twenty, or fifty thousand years of the early lifetime of the organic Aryan speech for hundreds of independent words to pass from one part of speech to another, from the noun or verb to the particle, and thence to the relational suffix. And if "suffixes became flexions through the help of analogy," being hitherto "meaningless terminations" (*ih.*), it may be asked through the help of what analogy? At all events, the internal vowel change here taken as their pattern does not meet the case, for, if properly considered, all such internal vowel change must itself be regarded as primarily due to the influence of reduplication and flexion acting on the body of the word, and gradually becoming absorbed, often leaving no trace of its former presence beyond the very vowel change in question. Such seems undoubtedly to be the history of the strong Teutonic conjugation and of such Teutonic plurals as seem now to be effected by mere internal modification, just as we know that it is the history of such past tenses in Latin as *egi, feci*. Two things it seems impossible to admit—the development or invention of "meaningless terminations," that is, meaningless *ab initio*, and internal vowel change with flexional force, produced, as it were, by spontaneous effort independently of outward influence, the influence either of reduplication or of pre- or postfixes reacting on the theme.

The chapter on Comparative Mythology, as expounded in the light of comparative philology, is thoroughly satisfactory, and will be read with pleasure even by those unfamiliar with the technicalities of the subject. In the last chapter, also, on the Origin of Language and collateral subjects, much excellent advice is given touching spelling reform, the pronunciation of the classical tongues, the application of sound linguistic principles to the teaching of languages, and many other points of a more practical nature.

There is an excellent analytical index supplied by Mr. W. G. Hird, but it does not dispense with the necessity of a full alphabetical index, which is urgently needed in a work overflowing with matter of the most varied description, and which it may be hoped will be supplied in future editions. Some oversights and casual slips in minor

points should then also be rectified, and with that view a few of the more important may here be noted. The *ve* in the Italian compound *portandovelo* (ii. 210) is derived from the Latin adverb *ibi*, used pronominally instead of from the pronoun *vobis*. The particle *vi, ve* often, of course, represents *ibi*, as in the sentence *io v'era* (lit. *ego ibi eram*); but it equally represents the pronoun, as in the sentence *io vi dico* (lit. *ego vobis dico*), and obviously in the compound in question. The Nogais (properly Nogais) are described (ii. 199) as "Russian Cossacks" instead of Tatars. The Nogais are of Túrki stock, whereas all the Cossacks are of Slav stock, either Great Russians (Don Valley, Cis-Caucasia, &c.), or Little Russians (Ukrania). The Cossacks are often spoken of as Tatars by careless writers, confounding them with the *Cassaks*, who, being Kirghizes, are true Tatars. It seems scarcely accurate to say that in the Greek and Latin sentences *τίττει* and *amat* "the subject is not expressed" (ii. 329), seeing that *ei* (for *ēi*) and the *t* of *amat* are pronominal, though so old that they do not distinguish the gender of the subject referred to, and may possibly have originally been *objective* forms. The statement (i. 417) that "in Hindustani the genitive takes the marks of gender according to the words to which it refers," is apt to mislead the unwary, who might conclude from this that the Hindustani noun had cases, whereas there is nothing but a general oblique form followed by postpositions. One of these postpositions (*kā* = of) follows the gender of the noun of reference (*larke-kā, larke-ki* according to circumstances), but the noun remains unchanged. There is another reference (p. 423) to a point of Hindustani grammar, which as worded is unintelligible. The place of the definite article is not supplied "by a dative with the suffix *-ko*," for there are no datives, but by the postposition *ko*, which, though usually giving a dative force, often idiomatically emphasizes the objective noun and thus does duty as a sort of definite article. The reference to Voltaire (i. 60) should be emended by shifting the places of the words "consonants" and "vowels." No one who has ever heard a native of Northern India speak any of the current neo-Sanskritic tongues will hesitate to transcribe the sonant explosives with the rough breathing (*gha, dha, bha*) by the side of *kha, tha, pha*, though the point is treated as doubtful (i. 281). The *h* in such words as *ghora, bhā, dhōbi* is heard quite as distinctly as it is in the English word *mad-house*. Lastly, such terms as "Turanian" (i. 325), "Alfurian," and even Malayo-Polynesian might well be dispensed with in future editions of a work, which as it stands reflects lasting credit on English scholarship, and which all will accordingly be anxious to see rendered even in small details as perfect as possible.

A. H. KEANE

### STATICS

*Treatise on Statics.* By George Minchin, M.A. Second Edition. (Clarendon Press Series.)

SINCE the publication of Thomson and Tait's "Natural Philosophy," thirteen years ago, an important change in the treatment of the theory of dynamics has been making rapid progress. Previous to that time it was the almost universal practice to follow the French writers and to find a basis for the theory of the equilibrium of forces

frequent in the family. So constantly does the labellum appear to act as a resting-place for insects, that in trying to trace the probable manner in which they fertilise a species, you naturally look upon it as the platform of the operator; but in this case, should a tiny insect alight upon one of the lips which hang trembling from the flowers, it would meet with a projection resembling the column and in the same position usually occupied by it, but without anther or stigma, being in fact nothing more than the hinge from which the fringed lip depends. This baffling is caused by the flowers being inverted, and the drooping of the labellum in front of them. Such modifications as this are useful in checking the natural tendency to assume that a certain part of a flower is designed to act in a certain way simply because through a long series we find it performing that function, and to show us how a slight change may alter all the results. Here the labellum bars access from the ordinary direction; the lower sepal incloses the column from below; the petals and wings of the column intercept access from the sides, and a prolongation of the anther obstructs it from the end; so that a very small space is left open beneath the labellum in what would appear to be the least likely place for an insect to approach, though from the conformation of the column the intervention of insects seems to be a necessity. After a very careful examination, I came to the conclusion that the most probable method in which this interesting little orchid becomes impregnated is by a very minute insect alighting on the under surface of the labellum and following it up into the flower, the lip giving way to its pressure upwards (by being lifted on the hinge) should the visitor be slightly too large. Would not the chances of the reproduction of this species be improved by the removal of the labellum? This, then, is another instance of a part of a flower, generally of importance, becoming of very doubtful advantage, if not actually detrimental."

Hitherto Mr. Fitzgerald's studies have been confined to the orchids of Eastern Australia, but it is most earnestly to be desired that they will be extended to the southern and western species, as indeed the title of his work implies will be the case.

### LETTERS TO THE EDITOR

[The Editor does not hold himself responsible for opinions expressed by his correspondent. Neither can he undertake to return, or to correspond with the writers of, rejected manuscripts. No notice is taken of anonymous communications.]

[The Editor urgently requests correspondents to keep their letters as short as possible. The pressure on his space is so great that it is impossible otherwise to ensure the appearance even of communications containing interesting and novel facts.]

#### Ice-Crystals

SINCE the publication of the Duke of Argyll's first communication on "Ice-Crystals" (NATURE, vol. xxi, p. 274), I have been expecting that some of the physicists who have noticed similar phenomena would have looked up the literature of the subject.

About thirty years ago I made this class of phenomena the subject of a somewhat careful investigation, and published the results of my researches in the *Proc. Am. Assoc. for Adv. of Sci.*, third meeting, March, 1850, vol. iii, pp. 20-34; also in the *Phil. Mag.*, 3rd series, vol. xxxvi, pp. 329-342, May, 1850. The former article is illustrated by several engravings representing the appearances presented by the "exudation of ice" from the foot-stalks of the *Pluchea*. I think that my investigations show that the phenomenon in plants is purely physical, having no connection with the vitality of the stems; and that it is due to the same cause as the "protrusion of icy columns" from the ground in frosty weather.

In relation to the explanation of the phenomena, I have nothing to add to that given in the above mentioned paper, except in relation to two points, viz. (1), that I did not sufficiently

emphasise the importance of the fact that the water contained in the capillary tubes in the upper stratum of earth is cooled many degrees below the freezing temperature; and (2) that, consequently, the congelation would necessarily take place paroxysmally.

Berkeley, California, April 27

JOHN LE CONTE

#### Anchor-Ice

MY remarks on anchor-ice, published in NATURE, vol. xxi, p. 538, have called forth several letters to myself, in addition to the articles on this subject by Mr. Allan Macdougall and C. F. C. respectively, which have a place in vol. xxi, p. 612 and vol. xxii, p. 31 of your journal. I am happy to find that C. F. C. agrees generally with my views, but I regret to have to differ from him when he says that "the original (ice) crystals, if not heavier than water, are at least as heavy." Were this supposition true, anchor-ice might as readily form in one part of a stream as in another, and would not require the conditions which I believe to be necessary. These minute crystals have never been seen by me "distributed" pretty evenly throughout the body of water at rest, nor even where there was a smooth, slow, steady current, which would be the case if the specific gravity of the crystal and water were alike.

C. F. C. is right in saying that this ice resembles manufactured "water ices"; it is never, as far as I know, transparent. It also looks like salt-water-ice.

Mr. Macdougall tells us of anchor-ice in Georgian Bay. This at first sight would appear to be incompatible or at variance with my belief in the necessity of a "comparatively swifter current" being essential for this formation, but to those who are familiar with the large lakes of America, the apparent contradiction seems not difficult of explanation.

At Great Bear Lake inexplicable currents of several miles an hour, sometimes running against the wind, are found in many of the narrow and shallow channels separating islands from the shore, making agitation sufficient to disturb the equilibrium of the floating ice-crystals and surface cold water. The same condition of things doubtless obtains in the Georgian Bay, which is the most easterly portion of the extensive and irregularly-shaped Lake Huron.

One remark of Mr. Macdougall's, to the effect that "the anchor-ice in the great northern lakes floats at a considerable depth under the surface of the water, and that it seemed to be floating at various depths in water fourteen feet deep," is curious. One way of accounting for this peculiarity may be that when the air becomes detached from the bottom, it not improbably brings up with it stones or gravel; soon afterwards a part of the ice gets separated, thus diminishing the floating-power, until the specific gravity of the compound mass exactly equals that of water, in which condition it might, of course, be found "swimming" at any depth below the surface.

Mr. Macdougall asks, "Does the (anchor) ice form by action of the intense cold of the ground (meaning, I presume, the bottom of the lake or stream), favouring the formation of rasee?"

I do not think that as a rule the coldness of the ground has anything to do with this formation, except in so far as this coldness of the ground, *i.e.*, the stony bottom, is caused by contact with the ice-cold water and ice-crystals, as already mentioned. "Intense coldness" of the ground at the bottom of the middle of a stream can scarcely be caused by abstraction of caloric, through its connection with the supposed colder land on shore, which is usually covered and protected by snow from cold in early winter; also, were this the cause, or one of the causes, the part of the river nearest the shore would first show anchor-ice, which is not the case.

At Repulse Bay flooding of some of the rapids of North Pole River took place when the ice was forming. This we know could not be caused by a greater flow of water, as the lakes supplying the river and all the rivulets running into them were already firmly ice-bound.

These overflows were caused by barriers of anchor-ice, which dammed the water up to the height of two or three feet, until the pressure became so great as to force a passage through the soft but tenacious mass, the portion of which that remained unbroken being now, by the running off of the water, brought into contact with the cold air, soon became frozen hard and solid.

J. RAE

4, Addison Gardens, W., May 15

"Sarsens"

I SUPPOSE it is in the order of things that utility should be a prime consideration, but still one cannot but regret the wholesale destruction which is overtaking the picturesque stones which have given its name to the "Valley of Grey Wethers," near Marlborough.

This destruction has been going on for some years, as is witnessed by the cottages in the neighbourhood built of "sarsen," but has of late been vastly increased by the demand for this strong stone for the bridges on the railway now making between Swindon and Marlborough. Nearly all the large blocks have indeed already disappeared.

So far no attack has been made on the fine cromlech of the "Devil's Den," which lies at the foot of the valley. It has had a narrow escape before, for a weather-beaten shepherd told me some years back that he "minded" how when he was a boy the farmer there got all the horses and oxen and tackle he could in the parish and laid on to the capstone, and "they drawed 'un and drawed 'un, but it warn't to be moved."

The geological interest in these rugged stones is considerable. They are found, more or less, all over the chalk range, but always as scattered or isolated blocks. The temple at Avebury was constructed of monoliths of this stone, so is most part of Stonehenge. The cromlechs of "Kit's Cotty" and "Wayland Smith's Cave" are formed of it, and its curious mode of weathering is well shown by the "blowing stone" under Uffington Camp. There is hardly a village amongst the chalk hills in which a mass of this rugged stone may not be seen, but nowhere is it found in anything like the abundance which has characterised the "Valley of Grey Wethers."

It is, I believe, the generally-accepted view that these "sarsens" are the indurated remains of a tertiary stratum of sand with which the chalk was once overlaid. Perhaps some of your readers can inform me where these stones can be seen in their native sand. The circumstance of the fracture of some of the "grey wethers" near Marlborough disclosing imbedded in them what look to me like chalk flints possibly points to an earlier origin for them.

A. G. RENSHAW

May 19

AN ENTOMOSTRACON LIVING IN TREE-TOPS

IT is not to be wondered at that the moist and shady hiding-places between the leaves of the Bromeliads, filled as they are by food of various descriptions, should be occupied by all sorts of animals, and that some of these should have chosen them as their favourite abodes and should have exclusively deposited their eggs in them. And indeed, according to Fritz Muller's friend, Friedenreich, almost all the coleoptera peculiar to the Bromeliads have been for the last thirty years found by him exclusively in such places, and the same is probably true of the larvæ of very many species of insects, and for the tadpoles of the tree-frogs, which undergo their metamorphoses therein.

But for all this it is, as Fritz Muller, writing from Itajahy, November, 1879, says, a very astonishing thing that there should be found living among the aquatic animals in the tops of the woods a little crustacean whose relations one is accustomed to find among the sea-weeds. It is about one millimetre long, and is of the family of the Cytheridæ.

Of the two cosmopolitan genera, each rich in species, Cypris and Cythere, into which the untiring investigator of the salt and fresh waters of Denmark, Otto Friedrich Muller, divided the bivalved crustacea, those of the first (Cypris) live almost entirely in fresh, and those of the second (Cythere) almost entirely in salt, water. Only a very few isolated exceptions to this rule have as yet come to light, and in the Brazils Fritz Muller only knows Cythere as having marine species, while those of Cypris are from fresh water; and never would he have expected to meet with, on the trees of his wood at Itajahy, an old Baltic acquaintance which he erewhile had collected when wading bare-footed with Max Schultze in Greiswalder Bay. At the first glance he did not recognise the Cythere

of the Bromeliads as a relation of its recent marine cousins, because it differed a good deal in the shape of its bivalved shell from all known species of Cythere, and even from all known Entomostraca. These generally possess laterally-compressed valves, which are broader than they are long, and are commonly bean-shaped. In the Bromeliad-lodger the length of the valves is a good deal more than the breadth, and, in addition, the ventral surface is flattened, and has a longitudinal furrow, reminding one of a coffee-bean. In consequence of this, when this new form is out of the water, instead of falling on its side as the others would do, it falls upon its back, or upon its ventral surface. This is probably an adaptation to its place of abode. In the sea the species of Cythere climb up on the narrow filaments of the algæ; and in the Bromeliads they must move about on the flat surfaces of adjacent leaves.

While no recent entomostracon was known to Fritz Muller which this new form resembles, he was at once reminded of a species (*Elpe pinguis*) which occurs as one of the oldest fossil Cytheridæ, and which Barrande described from the Silurian strata of Bohemia. This the Bromeliad form very closely resembles, but it is just five times as small. Fritz Muller describes this new form as *Elpidium bromeliarum*, for though it possesses no very marked peculiarities in its feet, still it does not fit into even any of the genera into which the old genus Cythere has been of late subdivided.



*Elpidium bromeliarum*, Fr. Muller. 1, dorsal aspect; 2, ventral aspect; 3, side view, right valve removed; 4, anterior antenna; 5, 6, posterior antenna of male and of female; 7, mandible; 8, maxilla; 9, 10, 11, feet, of 1st, 2nd, and 3rd pairs; 12, last body segments; 13 and 14, egg and young, from the parent valves; 15, *Elpe pinguis*, Barr. Magnified 1 to 3 = 10:1; 4 to 12 = 71:1, and 13 and 14 = 35:1.

Everywhere that Fritz Muller has looked for this new form, from the sea-side to some hundred kilometres into the interior, he has found it common in the tree-frequenting Bromeliads of the primæval woods. As it cannot, like some other of the animals inhabiting such places, wander from tree to tree, or even from one plant of Bromelia to another, its distribution must be affected by beetles (Agabus, *Laccophilus*, *Hister*, &c.), or some other of the Bromelia investing forms. The young *Elpidia*, when they leave their mother, are only 0.2 mill. long, and doubtless they cling to some of the flying insects, and so are transported. As, however, the colonisation of the Bromeliads is thus seemingly entirely left to chance, it

is the more astonishing that these little crustacea are found in almost every Bromeliad.

It cannot but sometimes happen that a few specimens must be washed away into other waters, as on the contrary, one may sometimes meet with a stray entrapped Cyclops that has slipped into the Bromeliads. Yet Fritz Müller has hitherto searched in vain for Elpidium in running waters, which produce, among other species, Cypris, Cyclops, Canthocamptus, Chydorus, Alona, Campocercus, Pasiptea, Moina, Ceriodaphnia, Smocephalus, &c. It seems not to flourish outside the Bromeliads.

[Translated from *Kosmos*, February, 1880. *Elpidium* comes somewhat near to *Elpidia*, Theel. - E. P. W.]

#### ON THE PHYSICAL ASPECTS OF THE VORTEX-ATOM THEORY

IN all attempts to arrive at a satisfactory conception of the ultimate constitution of matter, the grand difficulty has hitherto been to reconcile the proved indestructibility of the atom with its capacity for executing vibrations, as demonstrated by the spectroscope. The ancients, by assuming the atom to be *infinitely hard*, attempted in this way to get over the difficulty of indestructibility (or indivisibility), but thereby debarred all means of conceiving the "elasticity" of atoms, or their known powers of taking up vibrations of different periods.

When we consider the immense difficulty that there must have been in conceiving how an atom could be elastic (*i.e.*, how its parts could be capable of free motion) and yet its parts be incapable of separation from each other, we may well excuse the attempt to explain indestructibility by the assumption of the quality of *infinite hardness*, unsatisfactory though it might be.

It is evident that if we are to renounce all idea of occult qualities of "elasticity," hardness, indivisibility, &c., and purpose to explain the facts without recourse to postulates, we must assume the material substance of which our atoms are to be formed, to be itself entirely without any positive qualities, *i.e.*, to be without elasticity, hardness, rigidity, &c., and therefore to be freely penetrable in all parts, or perfectly passive and inert. This is the perfect liquid of the vortex-atom theory. There may be some who would say that it is difficult to conceive of such a liquid. On the contrary, we venture to be able to prove that such a liquid *always is conceived* of whenever a liquid is thought of. Thus, does any one in conceiving of a liquid (water, for instance), regard the liquid as consisting of solid (*i.e.*, more or less rigid) portions of matter sliding over each other [as we might conceive solid masses sliding past or through each other on a magnified scale]; and yet this is truly what the liquid (composed of molecules) is in the actual fact. In short it is not a "liquid" at all. Yet we conceive of it as *liquid, i.e.*, freely penetrable in all parts. We therefore contend that a perfect liquid (or true liquid) is what is *always* conceived of, and therefore that there can be no difficulty in regard to the conception of the true liquid that forms the basis of the vortex-atom theory.

In the next place, it is an obvious condition to any consistent conception of matter that matter must possess *extension*,<sup>1</sup> or occupy space, *i.e.*, so that two portions of our liquid cannot occupy the same space at the same time. If, therefore, the liquid fills all space, it must be imcompressible. This is, therefore, not an arbitrary postulate.

The next question naturally suggesting itself would be, how are portions of such a liquid to attain the properties that we recognise in atoms? We venture to think it will be conceded as evident that the only *conceivable* way (if it be admitted that the result is attainable at all) is through *motion* [for this is the only conceivable way in which the liquid can be affected]. The further inquiry would there-

<sup>1</sup> The quality of extension may even be regarded as included in the definition of matter.

fore be, what would be the *character* of this motion? Now, in order to fulfil the condition that the atom itself can be brought to rest without losing its properties as an atom, it is evident that the motion of the material forming it must take place in such a way that the atom can remain in one spot, or be to our senses at rest, *i.e.*, the material of the atom, although in motion, must not deviate from one spot. We ask if there is any other *conceivable* form of motion than *rotary* motion that would fulfil this condition? Hence the necessity for looking to *rotary* motion as the basis of the properties of the atom. In the next place a portion of material in rotation must rotate about an *axis*. If the ends of this axis were exposed, we should have two points *at rest*, which would forfeit the condition of *motion* being the essential basis of the external qualities of our atom. The question is, therefore, how is a portion of material to be in rotation about an axis, and yet not expose the ends of the axis? The only *conceivable* answer (as we think will be admitted) is that the rotating portion of material must have the form of a closed ring, or complete circuit, so that the axis has no ends. We therefore think it may be said beforehand that conceding that the problem of the atom can be solved at all (or if it be conceded that a fact can exist solely in virtue of the explanation that underlies it) then the problem could only *conceivably* be solved under the fundamental conditions above developed, *i.e.*, under the condition of a portion of material (having no positive properties in itself) *rotating* in the form of a *closed circuit*.

This (as is well known) is what has been found to satisfy the conditions for the atom by the application of mathematical analysis (without, apparently, that object having been in view at all), and in a manner the most remarkable in its completeness. It appears possible, in view of the above considerations, that a profound and competent thinker who had devoted himself to the subject might have arrived, even before the mathematical analysis had been applied, at the *sole conceivable* physical conditions that in principle could satisfy the problem of the atom (admitting the *existence* of the 'solution'); but the mathematical analysis can of course alone make the fact of the solution apparent to us. It is related in the article on "The Atomic Theory of Lucretius" (*North British Review*, March, 1868) that Hobbes had arrived at the fundamental idea that the *rotation* of a portion of material must be the basis to the solution of the problem of the "elasticity" of the atom, without having applied any mathematics.

The difficulty of the mathematical side of the vortex-atom theory is curiously contrasted with the simplicity of the physical side of the theory. If we suppose a cylindrical bar of india-rubber to be rotated about its longitudinal axis, and the bar (still rotating) to be bent round into a ring shape and the ends joined (the rotation of the material of the ring being always continued), then this may serve to illustrate in a simple way the motion of the material forming the vortex-atom. It is here apparent that the material of the india-rubber ring (in our illustrative case) may be in rapid motion while the ring itself preserves a fixed position in space. It would seem to be a pity if a spurious mystery should be allowed to envelope this subject, which is unworthy of it, in view of the simplicity of its physical basis. No one doubts the difficulties that had to be surmounted on the mathematical side of the theory, but there is all the more reason on that account that the extreme simplicity of the physical side of the theory should be duly appreciated, and unnecessary obstacles not be thrown in the way of its adoption. The tendency to invest physical subjects with a halo of the occult [possibly partly attributable to the unfortunate introduction into physical science of the spiritualistic conception of "force"—in the sense of an action across space without the intervention of matter] has probably done more to hinder progress than any real difficulties.



We shall simply state the facts of the mathematical analysis here, our business being more particularly with the physical side of the theory. First it is shown by incontrovertible mathematical proof that a portion of material having the motion above described possesses all the qualities of a *solid*. It is at the same time "*elastic*," or capable of changes of form when acted on through impact by other atoms—always tending to return to its symmetrical form when removed from constraint. It is, moreover, proved to be competent to execute vibrations of definite periods which it is the function of the spectroscopist to measure. The atom thus constituted is demonstrated to be incapable of being divided or severed by the collisions of other similar atoms against it, and *since this is the sole means of acting upon it*, the long-standing riddle of indestructibility is thus simply solved, without the necessity for any postulate of *infinite* hardness. As the degree of hardness merely depends on the velocity of rotation of the material, it follows that the vortex-atom may possess any degree of hardness. Indeed, if we imagine the atom to be magnified up to visible scale, it might be conceived to be harder or more rigid than a ring of steel of the same dimensions, since the hardness of steel is limited by the resistance of the component atoms to displacement.

The centrifugal tendency of the rotating material of the vortex-atom is controlled by the exterior incompressible liquid, and as there is no friction [there being no ultimate solid parts in the rotating liquid to "catch" against the inclosing fluid walls], the rotating portion therefore glides smoothly over the incompressible liquid that surrounds it like a pipe. Indeed, if we leave out of our conceptions the portion of rotating liquid, then the surrounding liquid actually forms a complete pipe in the form of a closed ring. If the liquid in the pipe were to fly out, a temporary void would be formed in it, which is impossible in a liquid that already occupies all space. An idea of the resistance of such a rotating portion of material to bending may be got by attempting to deflect a gyroscope or spinning-top.

In the old idea of *infinitely* hard atoms there were difficulties in forming a satisfactory conception of what took place at the collision of two such atoms or how the rebound could effect itself (consistently with the conservation of energy). The following difficulty may also be mentioned:—Since two such atoms are supposed to be absolutely hard or unyielding, the area of contact at the collision would necessarily be merely a mathematical point. Now the intensity of a given pressure on a surface is inversely as its area; and accordingly, since the area is here a mathematical point (or infinitely small), the pressure attendant on the collision of the two atoms would require to be *infinitely* great. It may be a fair question how even an *infinitely* hard atom is to withstand the disintegrating influence of an *infinite* pressure.<sup>1</sup>

In the case of the vortex-atoms they yield somewhat at collision (without change of volume, of course), whereby the encounter takes place over a surface (not a point); and they rebound in virtue of their elasticity, due to the motion of the material forming them.<sup>2</sup>

There would seem to be a view to a certain extent prevalent that the vortex-atom theory essentially alters the basis of the old-established ideas of solid indestructible atoms surrounded by space in which they can freely move, to which so many have accustomed their conceptions, and worked upon to the successful discovery of new facts, and which ideas, therefore, they might be reluctant to abandon. This step, however, is not required at all. The main purpose of the vortex-atom theory is to explain the "*elasticity*"

<sup>1</sup> The fact of two such infinitely hard atoms being stopped in an infinitely short space at collision [for there is by hypothesis, no *gradual* yielding] would by itself entail an infinite pressure *in addition* to the infinite pressure due to touching at a mathematical point.

<sup>2</sup> The rebound of vortex-atoms may be illustrated (as is known) roughly by the rebound of two smoke-rings from each other, or by the rebound of vortex rings in an ordinary (imperfect) liquid.

of atoms, retaining substantially everything else appertaining to the old atomic theories, merely removing the unsatisfactory postulate of *infinite* hardness. For since the perfect liquid (outside the portions of it that form the atoms) opposes no resistance whatever to the passage of the atoms through it, or it is impossible to act on the exterior liquid, it is therefore in this respect as if a void existed outside the atoms. It is desirable, however, to note that the vortex-atom theory involves essentially the *existence* of the liquid outside the atoms, which performs important functions, but since this exterior liquid is proved to be incapable of appealing to our senses in any way, it therefore *in that respect* may be said to play the part of a void. The exterior liquid of the vortex-atom theory corresponds to the void space of the theory of Lucretius. With the above qualification, therefore, it may be allowable, when we are not specially dealing with the problem of the constitution of the atom itself, to leave out of our conceptions the presence of the exterior liquid: that which we call "matter" being the atoms, and not the exterior liquid. In all practical problems of physics, therefore (apart from the problem of the constitution of the atom), we may properly regard the atoms simply as *elastic* indestructible solids moving freely in space. Moreover, since the motion of rotation of the material of the atom is incapable of transference, and cannot appeal to our senses, and this motion does not in any way alter the position of the atom in space [but it is exactly as if the atom *itself* were at rest]; we can therefore, if we like, leave this rotatory motion out of our conceptions, merely keeping in view the result produced by the rotation, viz., the sharply-defined elastic indestructible solid thereby formed. The function of the modern theory is accordingly not to destroy the atomic theory of the ancients, but rather to support it, by explaining *how* such indestructible bodies can exist, without recourse to the unacceptable postulate of *infinite* hardness. This old theory of the atomic constitution of matter was really too firmly grounded on reason and observation, as that one should suppose that its very foundations could be shaken.

Broadly and generally, therefore, in practical problems of physics, the essential points to recognise are that atoms—or molecules—are elastic indestructible bodies, capable of rebounding from each other without loss of energy, and of executing vibrations of fixed periods. The existence of this *elasticity* is a fact so definitely proved by the spectroscopist, which actually measures the *number* of vibrations executed per second by molecules, that it would become a question to *explain* this fact, even if the vortex-atom theory had not been proved to be capable of affording a complete explanation of it. Indeed, not only is the theory *capable* of doing this, but the vibrating capacity possessed by molecules is shown to be a *necessary* consequence of the theory, so that, therefore, the fact might even have been deduced *a priori*. Considering how enormously difficult it appeared to account for this fact at one time, or how impossible it seemed to reconcile the mobility of the parts of a molecule with the inseparability of these parts by the most energetic collisions, and how an explanation of this fact was at one time sought after, it would appear not too much to expect that those who hesitate to accept the explanation given by the vortex-atom theory, should endeavour to define for themselves wherein their grounds of objection lie. For if the explanation of a fact be admitted to be substantially complete, it would be at least unreasonable to look for more. The question might also suggest itself as a fitting one to any impartial inquirer, whether any other solution to the problem of the constitution of the atom is in principle *conceivable*, or whether [as in the case of many other physical problems, the constitution of the ether, for instance] but *one* solution is conceivable (or we have no choice at all). It cannot be said at least that the theory of vortex-atoms, or its physical side, is not *simple*, dealing

as it does with the mere *rotation* of a portion of matter.<sup>1</sup> It is so far recognised that simplicity of the means to the end is a general characteristic of nature. No doubt there may be difficulties in the mathematical development of the subject; but if an atom be once proved to be elastic and indestructible, that fact surely goes very far to supply all we want for the practical applications of the theory. Of course there may be some refinements that may present great mathematical difficulties. For instance, Prof. Tait in his work, "Lectures on some Recent Advances in Physical Science," mentions a case where a vortex-ring is supposed to come into collision with another in such a way that the motion is not symmetrical in relation to the axis, and it is cited as an almost insurmountable difficulty to find what exactly takes place (in regard to particular vibrations or rotations developed, possibly). But one might ask, is it necessary to know this for practical problems of physics? We may know broadly that vibration or rotation is developed, and if so (apart from the abstract interest of the question), do we want to know precise quantitative details for practical purposes? It might for example be extremely difficult to determine mathematically the exact deformation or changes of form (vibrations, &c.) that a steel ring underwent when thrown against the hard surface of an anvil; but the practical question is, do we want to be acquainted with this for any ordinary problem that might occur, or in order to appreciate the general principles of impact, for instance? So in the case of vortex-atoms, no doubt many instances might be cited when it would be difficult to ascertain precise results, but the practical question is, Does this prevent our applying the theory to ordinary physical problems,<sup>2</sup> or to dynamical phenomena involving questions of principle? For possibly it may not be necessary to know the exact vibrations developed at a collision (for instance), provided we recognise the fundamental point that energy is conserved, and that the atoms can rebound from each other like perfectly elastic solids. It would be a pity if the mere *difficulty* of arriving at precise mathematical results of a refined character, should be mistaken by some for *mystery*, or it would be a thing to be regretted if there should be any tendency to throw a veil of the "occult" over what in its *physical basis* (at least) is very simple, this procedure only hindering progress and rendering a closed book what might be a most interesting branch of mechanics.

The investigations regarding the perfect liquid have already (as is known) thrown some important light on the important practical question of the resistance of ships. Mr. Froude has especially devoted himself to these inquiries. The old idea that a ship (or more correctly a

<sup>1</sup> It would seem to be thought by some that the primary ring form of the vortex-atom involves something complicated in it. I venture to think that this is only one of those first impressions, which will disappear on reflecting on the subject. First, many facts strongly indicate that matter possesses a more or less open structure (or is highly porous). These ring molecules would give matter an open structure. It would seem also independently probable that a molecule should have no more material in it than is essential to give it a certain amount of extension, or to make it occupy a certain range of space. Why should we suppose that waste or apparent superfluity of material in a molecule that a solid structure throughout would involve? Does not this violate one of the fundamental principles of large scale architecture, where superfluity of material is recognised as one of the worst faults, and mechanical principles are admittedly independent of scale? The ring shape for the atom is evidently the simplest elementary form to satisfy the condition for the minimum extension combined with the minimum waste or expenditure of these considerations, the ring shape, the primary vortex atom theory, may seem in itself independently probable.

<sup>2</sup> Indeed, it seems a remarkable fact that the main conditions, incontestably led up to by this theory by a rigid mathematical process, are precisely those that independent observations support, (1) the *indestructibility* of the atom, illustrated by chemistry and numerous facts, (2) the *elasticity* of the atom, proved by the spectroscopy, (3) the *open structure* of the atom, in harmony with the transparency of some bodies to light, the free passage of the magnetic disturbance through all bodies, and numerous other facts—not to mention the physical theory of gravity. In short, it would appear that it would be necessary to infer the *existence* of indestructible elastic atoms of open structure, even if the vortex atom theory (which explains this fact) had not been suggested.

<sup>3</sup> The writer himself has seen from German comments on Prof. Tait's work, that the passage above referred to (German translation) has been regarded by some as if the difficulty there mentioned were of such a nature as to prevent the practical adoption of the theory.

totally immersed body, such as a fish) encountered a mysterious resistance in addition to the mere friction of the molecules of water on its sides, is now known to have been a pure delusion. If it were not for the fact that the water consisted of molecules or ultimate rigid parts which are caught and put in motion by the rough sides of the ship, there would be demonstrably no resistance at all. Hence the absence of resistance in a true liquid (which is not formed of ultimate rigid parts or molecules). If the molecules or ultimate rigid parts of which an ordinary "liquid" consists, were to be liquefied, a being immersed in it would (if conscious) imagine he was surrounded by empty space.

The late Prof. Clerk Maxwell in a review of the theory of vortex-atoms in the "Encyclopædia Britannica" for 1875, under the word "Atom," makes the following remark on the theory:—

"But the greatest recommendation of this theory from a philosophical point of view, is that its success in explaining phenomena does not depend on the ingenuity with which its contrivers 'save appearances' by introducing first one hypothetical force and then another. When the vortex-atom is once set in motion, all its properties are absolutely fixed and determined by the laws of motion of the primitive fluid, which are fully expressed in the fundamental equations. The disciple of Lucretius may cut and carve his solid atoms in the hope of getting them to combine into worlds; the follower of Boscovich may imagine new laws of force to meet the requirements of each new phenomenon; but he who dares to plant his feet in the path opened out by Helmholtz and Thomson has no such resources. His primitive fluid has no other properties than inertia, invariable density, and perfect mobility, and the method by which the motion of this fluid is to be traced is pure mathematical analysis. The difficulties of this method are enormous, but the glory of surmounting them would be unique" [p. 45].

Much misapprehension would seem to exist in regard to the physical side of the theory, especially in Germany,<sup>1</sup> where the mathematical investigations out of which it sprung, had their origin. Some appear to be unable to conceive how motion should take place in a material substance continuously filling space, losing sight of the fact that the liquid outside the atoms plays the part of a void (in so far as it cannot appeal to our senses)—or it is only the atoms that affect our perceptions. (Others fail totally to appreciate the simplicity of the physical side of the theory, and seem to think it involves arbitrary postulates, whereas the main peculiarity of the theory is its freedom from positive assumptions, inasmuch as the theory evolves all the properties of matter out of the motion of a material substance, which without this motion has no positive qualities at all, and could not appeal to our senses. The fact seems to be overlooked that if we renounce the occult quality of *rigidity* in the atom, we have no other resource than a *liquid* (i.e., a substance without rigidity). Much of the misunderstanding on the subject may no doubt be due to the scarcity of the literature relating to it, and the extreme brevity and absence of detail or attempt to assist the conceptions regarding the physical side of the theory. This want the author himself has much felt, and having been at considerable trouble to render clear his own conceptions as far as he could, he has thought that the result of this analysis might not perhaps be unacceptable in the form of a paper on the *physical aspects* of the theory.<sup>2</sup> For there are no doubt

<sup>1</sup> The writer has had personal experience of this, partly through correspondence, and partly through the literature relating to the subject. Quotations from the writings of Prof. Zöllner especially seem to show a want of appreciation of the *physical* points of the theory at their true value and significance.

<sup>2</sup> As regards sources of information as to the vortex-atom theory, the following may be mentioned. Sir William Thomson, "On Vortex-Atoms," *Philosophical Magazine*, July, 1867. Prof. Clerk-Maxwell, article "Atom," *Encyclopædia Britannica*, 1875. The theory is dealt with to some extent in a popular manner in

many investigators in the paths of natural science who may find some difficulty in realising the physical basis and real bearings of the theory, and who nevertheless take a rational interest in the solution it is capable of affording to some of the greatest difficulties of molecular physics. The whole structure of physics may be said to rest upon a *molecular* basis, and therefore the importance of a right view of this basis cannot be over-estimated. The old theory of *perfectly rigid* molecules put an immense difficulty in the way of the development of physical results upon such a groundwork. A theory of *elastic* molecules therefore becomes of the utmost importance as a practical working hypothesis, and the accordance with observation of new results predicted from this hypothesis as a basis, will then form additional confirming illustrations of its truth. The removal of any misunderstandings that might be obstacles in the way of the use of the vortex-atom theory as a working hypothesis becomes, therefore, a point of considerable importance. Those more especially who have handled the spectroscope and viewed the exquisite precision of its results, become impressed with the *certainty* of the groundwork upon which their molecular studies are based, and no less imbued with the conviction of the existence of that *explanation* that forms the basis of the facts that are recorded with such unflinching accuracy.

S. TOLVER PRESTON

#### COMPARATIVE ANATOMY OF MAN<sup>1</sup>

##### I.

THE great scope and interest of the subject of anthropology, as well as its most convenient subdivisions, are well illustrated by the prospectus of the teaching at the Anthropological Institute of Paris. There are at present six chairs:—(1) Comparative Anatomy in Relation to Anthropology, by Broca; (2) Biological Anthropology, or the Application of Anatomy and Physiology to Anthropology, by Topinard; (3) Ethnology, or the Study of the Races of Man, by Dally; (4) Linguistic Anthropology, by Hovelacque; (5) Palæontological and Prehistoric Anthropology, by Mortillet; and (6) Demography, which includes what we commonly call social and vital statistics and Medical Anthropology, by Bertillon. These subjects are publicly taught in a school supplied with all necessary appliances, founded partly by private munificence, but also liberally subsidised by the Municipality of Paris and the Department of the Seine. There is also at Paris a complete course of general anthropology given yearly by M. de Quatrefages in connection with the magnificent museum at the Jardin des Plantes. To these institutions we have nothing comparable in England, and neither at our Universities or elsewhere is any branch of anthropological science systematically taught. The present lectures only embrace a small portion of one of the six subdivisions enumerated above, that of biological anthropology. This science is purely one of observation, and in proportion as the materials upon which our observations are founded are multiplied, so will the value of the observations be increased. These materials are collected in museums, which at present in this country are not so complete as might be desired. The largest public collection is that of the College of Surgeons, containing about 1,200 crania of different races; the largest private collection is that of Dr. Barnard Davis, of Shelton in Staffordshire, considerably exceeding that of the College both in number and variety of specimens. Happily these are about to be united, and, under the care of the Council of the College, will be made accessible to all who wish to pursue the study of anatomical anthropology.

<sup>1</sup> An article on "The Atomic Theory of Lucretius," *North British Review*, March, 1868, also by Prof. Tait, in his work "Lectures on Some Recent Advances in Physical Science."

<sup>2</sup> Abstract Report of Prof. Flower's lectures at the Royal College of Surgeons, March 1 to March 19, on the Comparative Anatomy of Man.

Besides the Barnard Davis collection, only a small portion of which has as yet been received, one of the most important additions to the museum since the last course of lectures is a series of skulls collected in the Fiji Islands in 1876 by Baron Anatole von Hügel, forming part of a donation made by Mr. Erasmus Wilson. They consist of sixteen crania of the *Kai Colos*, or mountaineers of the interior of the western portion of Viti Levu, and five crania from the eastern coast and small islands adjacent. The inhabitants of the Fiji group are generally described by ethnologists as a mixed race, compounded of Melanesians and of brown Polynesians, as the islands are situated on the confines of the territories inhabited mainly by these two races, and the few crania hitherto accessible have favoured this view. Those, however, of the *Kai Colos* brought home by Baron von Hügel, and which probably represent the most primitive native population of the islands, show all the characters of the purest Melanesian type, without the slightest trace of Polynesian mixture. Their purity is shown by their wonderful similarity, and by their very peculiar and strongly-marked characters, discernible with equal facility in both sexes and at all ages. They are large, the average capacity of eight adult males being 1,482 cubic centimetres; and with muscular ridges and impressions strongly developed. In proportion to their length, they are the narrowest crania known, having an average latitudinal index of only 66.3. Not one has the index so high as 70.0, and in one it descends as low as 61.9, which is below that of any other normal skull in the collection. The height in all very considerably exceeds the breadth, the average altitudinal index being 74.1. They thus belong to the most strongly marked *hypsiencephalic* type. The zygomatic arches are very wide compared with the cranium. The brow ridges are strongly marked, though less so than in the Australians. The orbits are low and quadrangular, the nasal bones short, though rather prominent, and the nasal aperture wide (index 57.1), the jaws prognathous, though not to an extreme degree, and the teeth large. The skeleton of the face thus conforms with what is generally found in the Melanesians or Oceanic negroes, but the features are on a larger scale and more strongly pronounced than in the inhabitants of many of the New Hebridean and Papuan islands. The skull of the Tongans and Samoans, living on islands scarcely 300 miles from the Fijis, presents the greatest possible contrast to that just described. It is short and round (latitudinal index 82.6), the orbits are round, the nasal bones long and flat, and the aperture narrow (index 44.3), and the jaws are not prognathous. It is well known that for a long time the Tongans have been in the habit of visiting the Fijis, especially the smaller islands to the east of the group, and that there is in the inhabitants of that region a considerable infusion of Tongan blood. Five skulls of natives of the small island of Vanua Balavu, where this influence is supposed to prevail, show a distinct deviation in every character from that of the *Kai Colos*, and these deviations are, without exception, in the direction of the Tongan or Polynesian type. The average latitudinal index is raised to 71.9; the nasal index is 50.0, the orbits intermediate in form, and the prognathism much reduced. No skulls have as yet been examined from the second large island, Vanua Levu, and the numbers of those just described are, perhaps, not sufficient to draw any great conclusions from, but, as far as they go, they tend to show that, so far from the Fijians generally being a mixed race, the mass of those that inhabit the interior of the large islands are remarkably pure, and of the Melanesian or Papuan type in its most characteristic, almost exaggerated, form, but that the natives of the coast districts and outlying islands to the east show certain tendencies towards the brown Polynesian type, and as these are the people with whom European visitors to the Fijis have mostly come

into contact, an undue impression has been created as to the extent of the mingling of the races. At all events, little countenance is given by these facts to the view, which rests chiefly in the interpretation of some ancient legends, that at a former time the Tongan influence was much greater in the Fiji Islands than it is at present.

*Races of America.*—Two extreme views have been held as to the unity or diversity of the races of man inhabiting the American continent. It has been said on the one hand that "when you have seen one Indian you have seen all," and on the other, that as much difference can be found in the native Americans, as among the inhabitants of the Old World. Both statements are exaggerations, the truth lying between the two. A source of difficulty in studying the cranial conformation of the Americans lies in the wide-spread practice of deforming the head artificially in infancy. This habit prevailed extensively but not uniformly throughout all the western parts of the continent, from Vancouver's Island down to the southern parts of Peru. It also occurred, though less generally, in the southern part of what is now the United States, and in the West India Islands. It was forbidden to the Peruvians in 1585 by the synod of Lima, and again with severe penalties in 1752. In British Columbia it has only recently fallen into disuse. The custom is, or perhaps we may almost say was, not confined to America. Hippocrates and various other writers of his age, speak of the *Macrocephali*, people who dwelt on the eastern shores of the Black Sea, who purposely altered the form of their children's heads. Skulls thus deformed have been found in ancient tombs in the Caucasus (especially near Tiflis) in the Crimea, and, though less numerous, at various places, along the course of the Danube, and extending as far as the south of France. These have been assigned to Avars, Huns, or Tartars, but more probably belong to the Cimmerians, who originally inhabited the region where they are now found most abundantly, and spread westward over Europe some centuries before the Christian era. The custom, though in a modified degree, is scarcely yet extinct in the south of France. Cranial deformation, though usually only of the simple occipital form, is also practised in many parts of Asia and Polynesia, though quite unknown in Africa or Australia.

Many attempts have been made to classify the various kinds of cranial deformation, but as they pass insensibly into one another, it is not very easy to do so. They may, however, for convenience of description be grouped thus: 1. Simple occipital flattening, often probably undesigned, being occasioned by the pressure of the board or hard pillow upon which the child is laid; this is very common among the ancient Peruvians and also among some Mongol tribes and Polynesians. 2. Simple frontal flattening, also common in Peru, though less so than some of the following forms; also among the Caribs and in the island of Mallicollo, in the new Hebrides. 3. Fronto-occipital flattening, with lateral (compensatory) expansion, usually unsymmetrical. This, which may be depressed or elevated according to the point at which the greatest occipital pressure is applied, is the commonest form among the Indians of British Columbia and Vancouver's Island, and is also met with in Peru. The head is compressed between pads of birch bark and moss from birth to the age of twelve months. During subsequent growth it recovers somewhat from the extremely flattened form that it usually presents at that age. 4. Elongation by lateral as well as frontal and occipital pressure. In this form the head is symmetrical, and the sides compressed. It is produced by bandages passing round the forehead, vertex, and occiput, and is variously modified, according to the mode in which these are disposed. The Aymara Indians of the neighbourhood of Lake Titicaca, in Peru, some of the tribes in Vancouver's Island, and the *Macro-*

*cephali* of the shores of the Euxine, present examples of this form.

As far as can be ascertained by observations upon the North American Indians, no impairment of the intellect is produced by these strange alterations of the form of the cranium, and consequently of the brain. The families of the chiefs, in which alone it is practised in many tribes, maintain their ascendancy over the lower orders and slaves with undeformed heads. Foville, however, appears to have traced numerous cerebral lesions among the peasant population of France to the custom of tightly bandaging the heads of infants.

No motive can be alleged for this singular and wide-spread practice, except blind obedience to custom or fashion, precisely as in many analogous cases of barbarous distortions or mutilations of parts of the body, the origin of which is lost in the depths of antiquity. Without looking as far off as China, very few men or women in England can boast of feet which are not quite as much altered by artificial compression in youth from the form given by nature as are the heads of the Chinook Indians. The far more injurious constriction of the waist, so commonly practised by women of nations which occupy the highest rank of civilisation yet attained by mankind, is only another example of the same strange propensity to tamper with a form which good sense as well as good taste ought to teach was the most perfect that could be designed.

The natural history of the population of the great American continent, as it existed before the changes wrought by the European conquest, which followed the adventurous voyage of Columbus, offers an interesting but difficult problem to the anthropologist. Do all the various tribes (1,700 are enumerated by Keane, and these must be but a small portion of those formerly existing), extending from the Polar Sea to Cape Horn, through such various climates, and inhabiting regions so diverse in their physical characters, belong, as many writers have averred, to one primary division of the human species, or are they capable of being divided into groups, having as strongly-pronounced distinctive characters as are to be found among the inhabitants of the old world, as has been stated by others? Again, if we find difficulty in dividing them into well-marked groups, do we find such uniformity of characters as to lead to the belief that they are all of common origin, or have we reason to think that they are the result of the mingling together in various proportions in different districts of two or more distinct sources of population? Furthermore, inquiry will naturally be directed to their relation with other people. Whether we consider them as one or as several people, we shall have to ask with which of the races of other parts of the world are they most nearly allied.

The views till lately held as to the peopling of America, though perhaps under various modifications and disguises, may be grouped under two heads:—(1) That the inhabitants of that continent were a distinct autochthonous or indigenous people, created in the country in which they were found, and therefore not related to those of any other land. This is the theory of the polygenistic school, but is probably not held by many scientific men of the present day. 2. The monogenists mostly believed that they are descended from an Asiatic people, who in comparatively recent times passed into America by way of Behring's Straits, and thence spread gradually over the whole continent, as far as Cape Horn, and that their nearest allies must therefore be looked for in the north-eastern regions of Asia. It has also been thought by those who have held the same general views, that at all events a partial peopling of the American continent may have occurred from Southern Asia, by way of the Polynesian Islands, or from North Africa, across the Atlantic. The discovery of the great antiquity of the human race in America, as well as in the Old World, has led to an

important modification of these theories. The proof of a very considerable antiquity rests upon the high and independent state of civilisation, which had been attained by the Mexicans and Peruvians at the time of the Spanish conquest, and the evidence that that civilisation had been preceded by several other stages of culture, following in succession through a great stretch of time, but the antiquity of the quasi-historical period thus brought out, is entirely thrown into the shade by the evidence now accumulating from various parts of the United States, Central America, and the Pampas, that man existed in those countries, and existed under much the same conditions of life, using precisely similar weapons and tools, as in Europe, during the pleistocene or quaternary geological period, and, perhaps, even further back in time. As in Europe his works are found associated with the remains of *Elephas primigenius*, and other extinct mammals, so in America are they found in contemporary deposits with those of *Elephas columbi*. If the inductions commonly made from these discoveries be accepted, and the fact admitted that men lived both in Europe and America before the surface of the earth had assumed its present geographical conformation, the data from which the problem of the peopling of America is to be solved are altogether changed. Recent palæontological investigations, especially those carried on with such great success in the neighbourhood of the Rocky Mountains, show that an immense number of forms of terrestrial animals that were formerly supposed to be peculiar to the Old World are abundant in the New; indeed many, such as the horses, rhinoceroses, camels, &c., are more numerous in species and varieties in the latter, and therefore the means of land communication between the two must have been very different to what it is now. Taking all circumstances into consideration, it is quite as likely that Asiatic man may have been derived from America, as the reverse, or both may have had their source in a common centre, in some region of the earth now covered with sea.

However this may be, the population of America has been for an immense period practically isolated from the rest of the world, except at the extreme north. Such visits as those of the early Norsemen to the coasts of Greenland, Labrador, and Nova Scotia, or the possible accidental stranding of a canoe containing survivors of a voyage across the Pacific or the Atlantic, can have had no appreciable effect upon the characteristics of the people.

The evidence derived from the study of the physical characters of the Americans shows that there is, considering the vast extent of the country they inhabit, and the great differences of climate and other surrounding conditions, a remarkable similarity in essential characters, with, at the same time much diversity in detail, and in other characters which perhaps are not of such primary importance as has often been thought. The construction of the numerous American languages, of which as many as 1,200 have been distinguished, is said to point to unity of origin, as, though widely different in many respects, they are all, or nearly all, constructed on the same general grammatical principle, that called *polysynthesis*, which differs from that of the languages of any of the Old World nations. In mental characteristics all the different American tribes have much that is in common, and the very different stages of culture to which they had attained at the time of the conquest, as that of the Incas and Aztecs, as contrasted with that of the hunting and fishing tribes, which has been quoted as evidence of diversity of race, were not greater than those between different nations of Europe, as Gauls and Germans, and Greeks and Romans in the time of Julius Cæsar; yet all these were Aryans, and in treating the Americans as one race, it is not intended that they are more closely allied than the different Aryan people of Europe and Asia.

The physical or anatomical characters of the American native people, taken as a whole (leaving out for the present the Eskimo), may be thus described:—In stature there is considerable variation. Among them are the tallest known people on the earth, the Tehuelches or Patagonians, who, though not the fabled giants of the early voyagers, appear, by all trustworthy accounts, to attain an average (for the men) of from 5 feet 10 inches to 6 feet, which exceeds that of any other race. Some of the North American Indians are also very tall, 381 Iroquois carefully measured during the late war giving a mean height of 5 feet 8·3 inches. On the other hand, the Fuegians, and especially the Peruvians, are small, the latter not averaging more than 5 feet 3 inches. There is, however, no pigmy race on the American continent, like the Bushmen, Negritos, and Lapps of the old world.

The hair, always a character of primary importance in zoological anthropology, is remarkably uniform. Its prevailing, if not universal, colour is black, or intensely dark brown. The pale and auburn colour of the hair of Peruvian mummies is probably due to accidental bleaching, and the fair hair, said occasionally to be met with in existing tribes, may be the result of European admixture. It is always straight and lank, though sometimes coarse and sometimes silky in texture, a variation dependant upon the thickness of the individual hairs. In transverse section it approaches the circular form, perhaps more nearly than in any other race, though in this and other characters it resembles that of the Asiatic Mongolian people. On the scalp the hair grows abundantly and often to a great length; in many North American Indians it has been known to trail upon the ground when standing upright. Not less characteristic is the rarity or absence of hair on the face and other parts of the body. The skin is smooth and soft, and of various shades of brown, though cinnamon (commonly called *copper* colour) is the most characteristic. Some Californian Indians and the now extinct Charruas of Uruguay were said to be nearly black; and some scattered tribes, both in North and South America, are described as being nearly as fair as Southern Europeans. The shade of the colour appears to have no relation to the external conditions, such as heat, moisture, &c. Though the features of various tribes, and of particular individuals in each tribe, show considerable diversity, a characteristic type prevails throughout the great majority of the whole people from north to south. The forehead is usually retreating; the face wide in the malar region, narrowing towards the chin; the brows prominent, overshadowing rather small, sleepy, half-closed eyes; the nose long from above downwards, and narrow; the dorsum, as seen in profile, usually arched, rather sunk at the root, then projecting somewhat horizontally, and making a tolerably sharp bend down to the tip, which is not produced down below the septum; though this form is very frequently met with among all tribes, there is some diversity, and the profile is sometimes simply arched and sometimes straight, but a broad flat nose is very rarely met with; the mouth is wide and prominent, the lips rather thin; the chin well formed, narrow, but prominent; the whole face below the eyes long and large, the malar bones projecting laterally, and the lower jaw large.

(To be continued.)

#### VARIATIONS FROM MARIOTTE'S LAW

THE universal application of the law enunciated by Mariotte and Boyle, that the "volume of an aëriiform body is inversely as the pressure to which it is exposed," was brought into question at an early date after the publication of the famous experiments on which the principle was based. Oersted and Schwendsen established in 1826 for easily liquefiable gases that the elasticity does not keep pace with the pressure. At about the same

time Despretz showed that notable variations took place in the case of air above a pressure of fifteen atmospheres. Arago and Dulong, intrusted by the French Academy with the verification of these observations, carried out a carefully conducted series of experiments on the compressibility of air extending up to twenty-seven atmospheres, but came, however, to the conclusion that Mariotte's law was correct. This opinion was strengthened by Pouillet's researches in so far as it related to the then so-called permanent gases, while confirmatory evidence was brought in favour of Oersted and Schwendsen's experiments on easily liquefiable gases. This view of the correctness of the law for a certain group of gases was held by the scientific world until 1845, when Regnault, by a brilliant series of experiments of the most exact kind, showed that

air, nitrogen, and carbonic acid experienced a constant decrease of elasticity when submitted to pressures rising to thirty atmospheres, while under the same conditions a regular increase of elasticity in the case of hydrogen occurred. A few years later Natterer of Vienna published some remarkable experiments on the compressibility of gases, making use for the first time of enormous pressures, reaching in several cases nearly 2,800 atmospheres. While Natterer's methods of measurement were by no means exact, the results of his experiments showed beyond doubt that for pressures above eighty atmospheres oxygen, nitrogen, and carbonic oxide possessed the same peculiar property manifested ordinarily by hydrogen, viz., the volume of the compressed gas being greater than that demanded by Mariotte's law. The verification of Natterer's

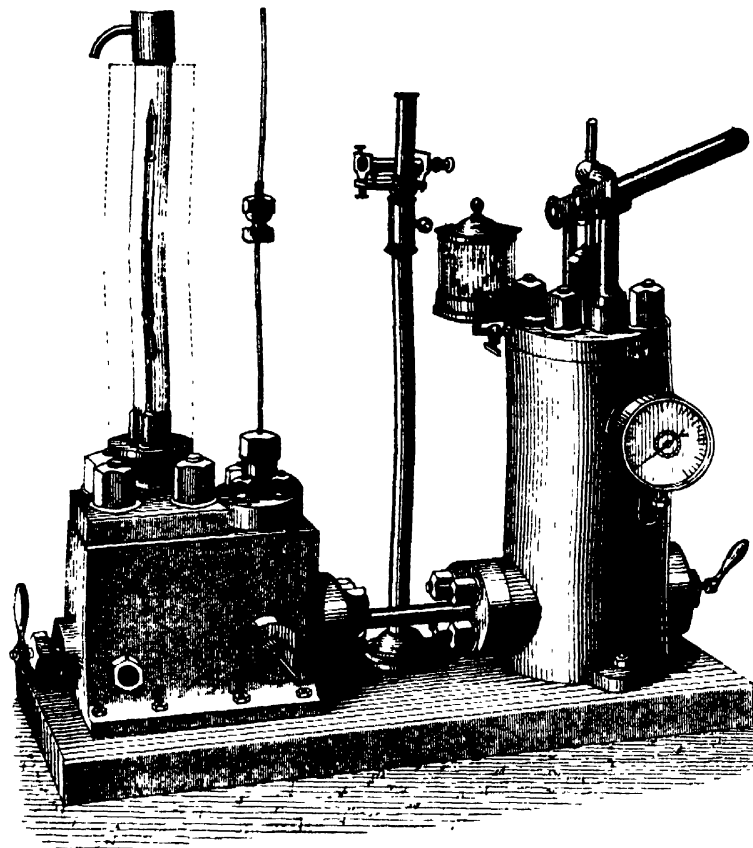

results was undertaken in 1870 by Cailletet, whose name has been so prominent of late years by his success in liquefying the so-called permanent gases. By making use of one of Desgoffe's manometers he experimented on air and hydrogen up to 600 atmospheres, and obtained figures comparing very closely with those published by Natterer.

So much for the data on this subject up to within a recent period. While the general truth of the results chronicled by Natterer and Cailletet was accepted by the physical world, it was still regarded as of prime importance to carry out the experiments under the influence of pressures with regard to the measurements of which there could be absolutely no doubt. The only practicable method of attaining this end was evidently to make use of enormously high columns of mercury. In 1875 Dr. Andrews attempted the solution of the problem in this manner, but was forced to succumb before the mechani-

cal difficulties attendant upon its execution. The French physicist M. E. H. Amagat, who has devoted his attention for a number of years past to the phenomena of compressibility, appears to have been more successful in overcoming the manifold obstacles in the way of accomplishing the task, and furnishes<sup>1</sup> an interesting account of what is certainly one of the most remarkable *tours de force* of modern experimental physics. It consisted in making exact measurements of the changes in volume of gases when submitted to the pressure of a column of mercury of over *one-fifth of a mile* in height. In order to give a correct idea of the conditions under which Amagat's important results have been obtained, we will describe briefly the three essential elements of the experiments: the locality, the column of mercury, and the apparatus for receiving the pressures, communicating them to the gases operated upon, and measuring the

<sup>1</sup> *Annales de Chimie et de Physique* [5], xix. 347. Mars, 1880.

changes in volume. The latter (Figs. 1 and 2) consisted of a massive block of cast iron containing two cavities; one (C) for the reception of the extremity of the column of mercury, the second (D) for the reception of the graduated tube (M) inclosing the gas to be experimented upon. A narrow passage connects the two with each other and (F) with the reservoir of a powerful pump, while conical screw-taps (P', P'') manipulated from the outside permit the openings into the cavity beneath the column of mercury or into the reservoir of the pump to be closed at will. The manometer (M) containing the gas to be compressed is of glass tubing, having an internal diameter of 1 millimetre and an external diameter of 10 millimetres, and is graduated for a distance of 50 centimetres. It is inserted hermetically into a massive bolt (B), which enters into the second cavity (D) of the apparatus. The free portion of the manometer is inclosed by a roomy glass tube, through which flowing water maintains a constant temperature, and that in turn by a copper cylinder, to guard against accidents. Mention can only be made

is broken off, and the bolt inclosing the manometer is screwed into its place. Sections of the steel tubing (c) are then screwed on, one above the other. After the addition of each section mercury is forced into the apparatus by the pump, and mounts to the top of the tube; the height of the column of mercury is measured, the volume of the compressed gas is read off by means of a cathetometer, and thus the series of observations proceeds slowly until the mouth of the pit is reached. As can easily be imagined, such experiments in the shaft of a coal-pit are by no means easy or pleasant to perform. We can here allude only to the numerous elaborate precautions taken by M. Amagat to insure accuracy in measurement and reduce all possible causes of error to a minimum. The divergences in corresponding series of observations never exceeded one-tenth of 1 per cent.

Coming now to the results of the experiments made on the compressibility of nitrogen at Verpilloux, we notice, firstly, that the compressibility increases slowly until it reaches a maximum at about 65 atmospheres; secondly, that it decreases equally slowly until it reaches a normal figure at about 91 atmospheres; and thirdly, that after passing this point it decreases rapidly until at 430 atmospheres the volume of compressed gas is five-fourths of what it would be if Mariotte's law were true. In the following table the first column contains the pressures in atmospheres of the column of mercury, the second those deduced according to Mariotte's law from the corresponding volumes of compressed nitrogen, and the third the differences between the two:—

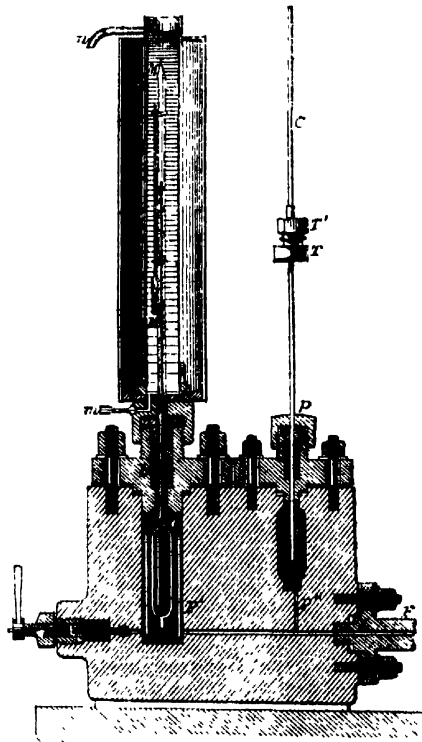

FIG. 2.

Pressures observed	Pressures calculated.	Differences.
27.289	27.289	0.000
46.496	46.580	+ 0.084
62.034	62.251	+ 0.217
73.001	73.181	+ 0.188
80.580	80.728	+ 0.140
90.975	90.978	+ 0.003
109.171	108.665	- 0.506
126.896	125.388	- 1.508
168.810	162.835	- 5.975
208.635	196.224	- 12.411
251.127	229.271	- 21.855
290.934	256.669	- 34.275
332.039	282.544	- 49.495
373.302	306.055	- 67.247
430.773	335.707	- 95.066

here of the ingenious devices for closing hermetically all the joints. The second important feature, the tube (C) for containing the column of mercury, is formed of pieces of steel tubing—internal diameter 2 millimetres, external 5 millimetres—united by specially prepared joints, which, while closing hermetically, are still easily attached or detached. The place chosen for the most noteworthy experiments was the coal-mine of Verpilloux, in the neighbourhood of St. Etienne. This pit reaches a depth of 327 metres, and a constant temperature prevails at the bottom.

After having established the above table of the changes in the compressibility of nitrogen, M. Amagat was in a position to study the analogous phenomena in the case of other gases with much greater ease. For this purpose it was simply necessary to replace the tube for the column of mercury in the apparatus just described by a manometer filled with nitrogen, the counterpart of that used for the gas under examination. By means of these modifications of his original apparatus M. Amagat has prepared very accurate tables for the changes in compressibility up to 400 atmospheres of air, oxygen, hydrogen, carbonic oxide, ethylene, and marsh gas. In M. Amagat's graphic delineation of the variations from Mariotte's law in the cases of the seven gases mentioned, the abscissæ correspond to the pressures in metres of mercury, while the ordinates correspond to the difference between the products of the pressures into the volumes and unity, *i.e.*, to the variations from Mariotte's law. They all start from a common point—a pressure of 24 metres. The curves of nitrogen and hydrogen are however continued to a minimal measure in accordance with Regnault's data. The minimum ordinate of the ethylene curve, which is 425, could not easily be given.

The experiments made here were confined to nitrogen gas. The chief features of an experiment are as follows:—A vessel containing warm, dry mercury is placed in the large cavity (D) of the apparatus. The manometer containing dry pure nitrogen and terminating in a capillary point is then introduced beneath the mercury, the point

is broken off, and the bolt inclosing the manometer is screwed into its place. Sections of the steel tubing (c) are then screwed on, one above the other. After the addition of each section mercury is forced into the apparatus by the pump, and mounts to the top of the tube; the height of the column of mercury is measured, the volume of the compressed gas is read off by means of a cathetometer, and thus the series of observations proceeds slowly until the mouth of the pit is reached. As can easily be imagined, such experiments in the shaft of a coal-pit are by no means easy or pleasant to perform. We can here allude only to the numerous elaborate precautions taken by M. Amagat to insure accuracy in measurement and reduce all possible causes of error to a minimum. The divergences in corresponding series of observations never exceeded one-tenth of 1 per cent.

marked than in that of nitrogen, while the curve of air lies between the two. Further, hydrogen is the only gas not exhibiting a minimum of the product of pressure and volume. As hydrogen is, so to say, the most perfect gas known, it would seem probable that on being forced to assume a state of tenuity allied to that of hydrogen, *i.e.*, by being exposed to elevated temperatures, the other gases experimented upon would yield curves resembling more and more that of hydrogen, until finally temperatures would be attained at which the convexity of the curves would totally disappear. The results chronicled by M. Amagat, taken in connection with those ascertained by other investigators in experimenting upon gases compressible at ordinary temperatures, would fairly allow the establishment of a law that when a gas on being compressed gives constantly increasing numbers for the product of the pressure by the volume—which according to Mariotte's law should remain unity—it is at a temperature above its critical point; or, to use Dr. Andrews' apt description, without actual liquefaction it can pass by means of pressure alone through all the intermediate stadia between the gaseous and the liquid states.

M. Amagat's interesting researches will, it is to be hoped, be followed by similar experiments executed under a wider range of temperature on the various gases; the results of which will, without doubt, throw much valuable light on the phenomena and conditions of liquefaction. Apart from their purely scientific interest, the tabulated records of his observations furnish to the engineer data of the greatest value, enabling him to construct manometers combining exactness and delicacy for the indication of high pressures, which hitherto have been measured with but a certain degree of approximation to the truth.

T. H. N.

#### NOTES

DR. M. TREUB has been appointed director of the Botanical Gardens at Buitenzorg, Java.

WE are glad to learn that the collections from Socotra, which Prof. Bayley Balfour was compelled to send by sea from Brindisi, have arrived safely at Kew Gardens.

AT Dorpat a monument is about to be erected to the memory of the celebrated naturalist, Karl Ernst von Baer, who died at Dorpat on November 28, 1876. The funds will be supplied by the Dorpat University and the Imperial Academy of Sciences at St. Petersburg. The eminent sculptor, Herr Franz von Villebois, has made two excellent sketches for the monument.

AT a recent meeting of the Court of Common Council, at which the Lord Mayor presided, it was resolved that the freedom of the City of London in a suitable gold casket be presented to Sir Henry Dessemer, F.R.S., M.I.C.E., in recognition of his valuable discoveries, which have so largely benefited the iron industries of this country, and of his scientific attainments, which are well known and appreciated throughout the world.

ON August 5, as we have already announced, the exhibition of anthropological and prehistoric objects found in Germany will be opened at Berlin. At the same time the general meeting of the German Anthropological Society will take place. No less than 114 archaeological, eight palaeontological, and sixteen craniological museums will send objects to this exhibition. The objects found in the Loess strata will be particularly interesting, and besides these we may point to the objects found in caves and in moors.

THE British Medical Association will be well received at Cambridge in August, not only by the University but in the town; the Town Council have granted the Guildhall free of cost. The president of the Physiological Section, Dr. Rutherford, will give his address on Wednesday, August 11, at 2 o'clock, and there will follow a discussion on the subject, "Is Urea

formed in the Liver?" to be opened by Prof. Gamgee, of Manchester; on August 12 Prof. W. Preyer, of Jena, will open a discussion on "Sleep and Hypnotism." Drs. Gaskell (Cambridge) and Stirling (Aberdeen) are the secretaries of this Section.

PROF. MILNE, of Tokei, Japan, who has made a trial of almost every seismoscope in existence, and has devoted all his leisure to seismometry for several years, has exerted himself successfully to interest the Japanese officials in establishing a suitable system of earthquake observation, as well as the Europeans in Japan, who have lately formed a society for the purpose of systematically studying seismic phenomena. Mr. Milne has obtained the assistance of the Government in having immediate telegraphic communication concerning earthquakes, and he aims at getting from telegraph operators throughout the country information concerning earth-currents during earthquakes. If we consider the importance of studying the matter systematically in a country where small earthquakes occur every few days, and where the people are all greatly interested, it must be evident that this society will have a promising future.

A CONGRESS of the Members of the Royal Agricultural College, Cirencester, of former Students and Professors of the College, and of others interested in Agriculture, will be held in the College on Friday, June 4, 1880, under the Presidency of the Principal. At the Morning Session at 10 a.m. the subject for discussion will be—"Diseases in Cattle and Sheep, with especial reference to recent outbreaks," introduced by a paper by Prof. Buckman, F.G.S., F.L.S., on "The Natural History of Meadow and Pasture, in connection with such Diseases." At the afternoon session at 3 p.m. the subject for discussion will be—"Agricultural Research and Experimental Stations," introduced by Prof. Henry Tanner, M.R.A.C., F.C.S.

IN connection with the subject of "Fungus Inoculation of Insects," a Heidelberg correspondent, "O. S.," sends us for publication the following beautiful and little-known poem, by Goethe (1810, Poems, vol. ii.) :—

#### DER FLIEGENTOD

"Sie saugt mit Gier verräthrisches Getranke  
 Unabgesetzt, vom ersten Zug verführt;  
 Sie fühlt sich wohl, und langst sind die Gelenke  
 Der zarten Beinchen schon paralytirt;  
 Nicht mehr gewandt, die Flügelchen zu putzen,  
 Nicht mehr geschickt, das Köpfchen aufzustutzen—  
 Das Leben so sich im Genuss verliert.  
 Zum Stehen kaum wird noch das Füsschen taugen;  
 So schlurft sie fort und, mitten unterm Saugen,  
 Umhelt ihr der Tod die tausend Augen."

DR. WERNER SIEMENS, the well-known German electrician, had been instructed, a few years ago, to manufacture a series of standard weights on behalf of the Egyptian Government, which wished to adopt the German system; but as the Egyptian Government did not fulfil its financial obligations Dr. Siemens kept the set of weights in his workshop, where they were used for various purposes. On the occasion of the visit of the weights and measures inspector these weights were discovered, and Dr. Siemens summoned before the police. The case has been tried with some solemnity, and Dr. Siemens fined 2 marks.

A REMARKABLE phenomenon was observed at Kattenau, near Trakehnen (Germany), and in the surrounding district, on March 22. About half an hour before sunrise an enormous number of luminous bodies rose from the horizon and passed in a horizontal direction from east to west. Some of them seemed of the size of a walnut, others resembled the sparks flying from a chimney. They moved through space like a string of beads, and shone with a remarkably brilliant light. The belt containing them appeared about 3 metres in length and  $\frac{1}{2}$  metre in breadth.



THE Mitchell Library of Glasgow, which was opened in 1877, has already attained considerable dimensions, and under the careful organisation of the principal librarian, Mr. Barrett, promises to be of great service as a consulting library. It now possesses 16,828 works, or 27,982 volumes, a large proportion of which are scientific. Of the volumes issued in 1879 19½ per cent. belonged to the division of "Arts, Sciences, and Natural History"—rather a curious division, by the by. This percentage was excelled only by History, Biography and Travel, and "Miscellaneous."

THE eminent physicist, Dr. Rudolf Clausius, of Bonn, has been elected a member of the Roman Academy "dei Lincei."

THE Secretary of State for Foreign Affairs of the Republic of San Domingo has issued a circular to the Ministers of England, America, France, Italy, Spain, Holland, and Denmark, soliciting their co-operation in the erection of a monument to Christopher Columbus in the city of San Domingo.

THE Lisbon Academy has decided to ask the consent of the Government to transfer the bones of Vasco da Gama from Vidigueira Alem<sup>o</sup> to the church of the Jeronimites, Belem. It is proposed that a deputation of the Academy should accompany the remains of Vasco da Gama, and a war ship convey them from Barceira, on the banks of the Tagus, to the Lisbon Arsenal.

ADMIRAL MOUCHEZ, the Director of the Paris Observatory, has published a pamphlet on the work executed in this establishment during the year 1879. A new decree quoted by M. Mouchez arranges that the several *employés* of the Observatory, when not too old, can be admitted to follow the course of lectures given at the School of Astronomy recently created, and are fit to be appointed astronomers if successful in their examinations. The establishment is to be enlarged in the vicinity of Boulevard Arago, the admission of the public to be more frequent, and the magnetical observations to be resumed. The meteorological observations have been continued, and are to be in some respects enlarged, although no change is contemplated in the organisation of the Bureau Centrale and the Service d'Avvertisements, which will continue for ever independent of the astronomical observations.

THE *Sydney Morning Herald* records the death of Mr. Edward Smith Hill on March 17, sixty-one years of age. He was a native of Sydney, and after retiring from business devoted his time to scientific investigations for the last eighteen years. He made a voyage to the South Sea Islands, and wrote some valuable papers and pamphlets on their flora. He wrote for the New South Wales Government a report on the flora of Lord Howe Island, and the condition of its European inhabitants. Among his contributions to Sydney journals was a series of articles describing the fishes found in the harbours and rivers of New South Wales and along the coast.

THE work of examining the 5,000 *employés* of the Pennsylvania Railroad Company as to their power of distinguishing colours and forms was begun in Jersey City on April 1. Acuteness of vision was tested by means of printed cards placed at a distance of twenty feet; also by means of small openings in a screen illuminated on the further side. Many who successfully passed these ordeals failed signally in the colour tests. Three skeins of woollen yarn were used, one being light green, the second rose, and the third red. Each of these was placed on a table in front of the person examined, at a distance of three feet, and, with the vision of either eye obstructed by a spectacle frame, the man was requested to name the colours, also to pick out a similar shade to one or other of the three specified from different skeins of woollen yarn numbered from 1 to 36. One young man correctly designated the test skein as red, but on being told to select a similar shade from the skeins before him, he picked

three shades of blue, two of yellow, and one of red. He could distinguish no difference; and the same thing happened to half-a-dozen others who followed him. The skeins in the row were then divided into three sets with twelve numbers in each. Some men proved able to distinguish all the shades of green, but failed lamentably in picking out the different shades of red. The officers of the road were greatly impressed, it is said, by the results obtained.

ON April 1 a "Society for Zoology" was formed at Berlin, with a view of furthering zoological science and zoological research in all its branches. The president is Dr. Eduard Kaiser (27, Friedrich Strasse), who will furnish all particulars to intending members.

AT Paris a Society "contre l'abus du tabac" has been formed, which intends to combat the excessive indulgence in smoking which has of late become the fashion in almost the whole of Europe. The Society offers various prizes for treatises on the human health and the dangers it is subject to from excessive use of tobacco.

THE *Times* Geneva correspondent writes, under date May 12, that a few days before, during a violent thunderstorm, a tall poplar on the Cour de Rive, a street in the upper part of Geneva, was struck by lightning. Directly after the occurrence Prof. Colladon made a minute examination of the tree. The Professor states that it is not true, as has been commonly supposed, that the gashes (*plaies*) found in the trunk of a tree which has been struck by lightning are the parts with which the lightning first came into contact. The parts first struck are the highest branches, especially those most exposed to the rain. Thence it runs down the smaller branches—affecting almost the whole of them—to the larger ones, until it reaches the trunk. These larger branches, and above all the trunk, being much worse conductor than the small branches, the passage through them of the electricity produces heat and "repulsive effects," whereby the bark and sometimes the wood are torn in pieces, the bits being thrown a considerable distance, occasionally more than 50 metres. It not infrequently happens that the upper branches and their leaves are destroyed—this is generally the case with oaks, which are often struck—but the leaves and young shoots of poplars and many other trees are such excellent conductors that they do not appear when struck to suffer any notable injury. This finds full confirmation in the condition of the poplar on the Cour de Rive. In this instance the principal and highest branch of the tree on its south-western side was the first with which the lightning came in contact. Its leaves and twigs, neither withered nor tarnished, were torn into minute fragments and scattered about on the ground. This was the effect, not of the lightning, but of the concussion of air, exactly as if there had been an explosion of dynamite or gunpowder; and the windows of two houses close by were broken in the same manner and by the same cause. The presence of water near the root of a tree is often the determining cause of its attraction for the electric fluid; and the Professor found, 5 metres from the poplar, on its north side, a leaden water-pipe, and close to it a drain filled with waste water from a laundry. The principal fissure in the tree was also on the north side; and half-way between it and the water-pipe a plank lying on the ground had been pierced by a concentrated jet of the electricity as it flashed towards the pipe by the shortest route. Large trees, especially tall poplars, placed near a house, may serve as very efficient lightning conductors, but always on the indispensable condition that there is no well or running water on the opposite side of the house, for in that case the lightning, if it struck the tree, might pass through the building on its way to the water. In erecting lightning conductors it is desirable that their lower extremities should terminate in a stream, a well, or a piece of

damp ground. The plant most sensible to electricity is the vine. When a stroke of lightning falls in a vineyard the leaves affected are turned red-brown or deep green, a circumstance which shows, in the opinion of Prof. Colladon, that the electricity descends in a sheet or shower, and not in a single point, the number of vines touched—sometimes several hundred—by a single *coup* proving that the lightning has covered a wide area.

THE oldest librarian of the Royal Library at Berlin, Dr. Buschmann, died recently at the advanced age of seventy-five years.

A NEW "Illustrirte Naturgeschichte der Thiere," by Philipp Leopold Martin, with numerous illustrations by F. Specht, K. Friese, R. Kretschmer, A. Goring, and I. Martin, jun., will soon be published in two volumes (or fifty parts), by F. A. Brockhaus, of Leipzig. The first volume will contain the chapters on mammals and birds; the second the remaining vertebrates and the whole of the invertebrates.

THE Archæological Society of Athens has purchased about half the village which stands upon the ruins of the Temple of Eleusis. The Society intends building new dwelling-houses in another part, and to begin with excavations as soon as the present inmates of the village have moved.

THE astronomer, Herr Rudolf Falb, well known through his theory of earthquakes, has returned from his South American exploring tour, which extended over a period of more than two years. In his researches he was led in the direction of ethnography and linguistics, and believes that he has made interesting discoveries regarding "the original language of the human race."

In the vicinity of Milan pile-dwellings have been discovered in a peat-moor, and the foundations of a Roman theatre in the city itself.

"DIE deutsche Arbeit in fremden Erdtheilen" is the title of an interesting lecture recently delivered by Dr. Karl von Scherzer at the Leipzig Gemeinnützige Gesellschaft. It is published by Rossberg, of Leipzig.

THE new Indian Section of the South Kensington Museum, formed from the late India Museum, was opened to the public on Monday.

It has been resolved to establish a Museum of Science and Art in Aberdeen.

AN experimental department has been established at the Conservatoire des Arts et Metiers in the large hall, where the engines are set in operation every Sunday and Thursday from eleven to six o'clock. Advantage has been taken of the motive power to put in operation a number of Gramme and Alliance machines. After having been exhibited during a fortnight, the instruments will be replaced by others, and so on indefinitely.

DR. JAMES GEIKIE, F.R.S., has been elected President of the Perthshire Society of Natural History, in succession to the late Sir Thomas Moncrieffe. From his address at the annual meeting of the Society we are pleased to see that the local museum to be established by this enterprising Society is making good progress, and promises very soon to be a *fait accompli*. Dr. Geikie gave expression to some wholesome truths as to the functions of such a local museum, the great purpose of which ought to be to fully illustrate the natural history, geology, and antiquities of the surrounding region. This, we are glad to think, is what the Perth Museum promises to be, and it ought, therefore, to prove one of the best local museums in the kingdom, seeing that all in all, from a scientific point of view, Perth is probably the most comprehensive and representative county, as it is among the largest, in our islands.

IN a gravel pit near the town of Posen a mammoth-skull has been discovered, but unfortunately in pieces. Most of the pieces, however, are well preserved—the facial bones alone weigh 28 lbs.

AN earthquake, accompanied by a loud subterranean noise, is reported from Ilanz, in the Swiss canton of Graubünden. It occurred on April 27 at 3.30 a.m. A smart earthquake shock, coinciding with that at Villeneuve, and accompanied by subterranean noises, was felt at Jarasp and Ardez, in the Engadine, on the 7th inst.

THE centenary of the birth of Gotthilf Heinrich von Schubert, the celebrated naturalist, was celebrated at Hohenstein on April 26. A monument of Schubert was unveiled, and some 5000 have been collected for the foundation of a preparatory school for little children, under the name of Schubert-Stift.

A NEW French Society of Agriculture, "The National Society for the Encouragement of Agriculture," held its first meeting on May 15 at the Hotel Continental, Paris, M. Fouche de Careilles, Senateur, in the chair. The President of the Republic and the most prominent members of the French Government are said to take interest in the new society.

AN ostrich, long on exhibition at Rome, having been suffocated by thrusting its neck between the bars, there were found in its stomach four large stones, eleven smaller ones, seven nails, a necktie pin, an envelope, thirteen copper coins, fourteen beads, one French franc, two small keys, a piece of a handkerchief, a silver medal of the Pope, and the cross of an Italian order.

A REMARKABLE discovery has recently been made near Hirschberg, in the Riesengebirge (Silesia). In a locality called Weltende, at the entry into the narrow rocky mountain ravine through which the Bober flows, a large heap of bones of diluvial mammal was found, such as pieces of reindeer horns and bones of *Elephas primigenius*, prehistoric ox, &c. The discovery is important, because it proves the former occurrence of the large mammals of the diluvial period even in this elevated valley of the Sudeten mountain-chain.

DR. BECLARD has introduced at Paris, in the buildings where the old Rollin College has been so long established, a new mode of demonstration for physiological experiments on living animals. A circular barrier has been erected round a space where a movable table is arranged on rails. The animal being placed on the table, it is easy to understand that the experiments can be witnessed by each pupil consecutively.

NEAR Bautzen (Saxony) an ancient burial-ground has been discovered. Up to the present not less than 400 antique objects, such as urns, well-preserved "tear-vases," sixteen bronze and iron rings, a head ornament, needles, and buttons were found.

THE additions to the Zoological Society's Gardens during the past week include a Pig-tailed Monkey (*Macacus nemestrinus*) from Sumatra, presented by Mr. J. M. Donovan; a Bennett's Gazelle (*Gazella bennetti*) from India, presented by Mr. Harvey Chevallier; four Rose-coloured Pastors (*Pastor roseus*) from Smyrna, presented by Mr. M. S. Bayliss, C.M.Z.S.; six Paradise Whydah Birds (*Vidua principalis*), two Yellow-backed Whydah Birds (*Coliopasser macrurus*), a White-winged Whydah Bird (*Urobrachya albonotata*), twelve Red-beaked Weaver Birds (*Quelea sanguivostris*) from West Africa, presented by Mr. J. Colman, C.M.Z.S.; a Goffin's Cockatoo (*Cacatua goffini*) from Queensland, presented by Mr. W. T. Green; three Young Lions (*Felis leo*) from Africa, a Grey-cheeked Monkey (*Cercocebus albigena*) from West Africa, a Red-throated Amazon (*Chrysotis collaria*) from Jamaica, deposited; two Common Bluebirds (*Sialia wilsonii*), two Yellow-legged Herring Gulls (*Larus cachinnans*), bred in the Gardens.

OUR ASTRONOMICAL COLUMN

THE TRANSIT OF MERCURY, MAY 5-6, 1878.—An Appendix to the "Washington Observations, 1876," is devoted to reports on telescopic observations of this transit and discussions of them. There are individual reports from Professors Asaph Hall, Harkness, Eastman, and Holden, and from Dr. Henry Draper and Mr. H. M. Paul. Probably no other phenomenon of the kind has been watched by so large a number of observers, 109 names appearing in the general record. They were, with very few exceptions, stationed at different points in United States territory. The observations have been calculated by Prof. Eastman and Mr. Paul: the former, attaching greater weight to a certain number made by more experienced observers, finds for the Washington geocentric times those given in the second column below; Mr. Paul deduces for the most probable values those given in the third column (the time of first external contact depending on only two or three observations being omitted; the other contacts depend on 57, 52, and 8 observations respectively):—

	EASTMAN.			PAUL.		
	h.	m.	s.	h.	m.	s.
First external contact	22	4	42.0	22	7	42.1
First internal "	22	7	42.1	22	7	40.61 ± 0.45
Second internal "	5	35	27.8	5	35	28.83 ± 0.48
Second external "	5	38	25.7	5	38	29.52 ± 1.18

If the first series of times are compared with the figures in the *American Ephemeris*, which depend upon the earlier theory of Mercury of Leverrier, the errors of prediction are respectively + 77s., + 84s., + 110s., and + 119s. These differences are greatly diminished if the times are compared with those resulting from Leverrier's later theory involved in the tables in the *Paris Annales*, vol. v., as used in the *Nautical Almanac*, more especially if the solar semi-diameter employed is diminished by 2".0, so as to make the results more strictly comparable with those of the *American Ephemeris*: we have then for the errors of computation, + 2s., + 9s., + 25s., + 34s. The superiority of the later theory is thus evident, and it will be remembered that this theory involves the increased motion of the perihelion of mercury, which induced Leverrier to suspect the existence of one or more planetary bodies, or of matter in some form between Mercury and the Sun.

We may add that if the positions of the planet in the *Nautical Almanac* are combined with the semi-diameters of sun and planet inferred by Leverrier from the transits, the computed time of the internal contacts exhibit differences of + 19.8s. and + 16.4s., the first agreeing closely with the corresponding one deduced from observations in Europe.

THE SECOND COMET OF 1880 (SCHABERLE, APRIL 6).—On the evening of May 8 this comet passed nearly over a star of the eighth magnitude, No. 6815-6 of Oeltzen's Argelander (= 901 of Fedorenko), and Major Tupman, R.M.A., availed himself of this somewhat unusual opportunity for fixing the place of a comet with great precision. By twenty comparisons, ten before and ten after the conjunction in declination, it was found that at 10h. 16m. 17s. Greenwich mean time, the comet followed the star 2.80s. and was 2".2 south of it.

The following ephemeris, for Greenwich midnight, is derived from elements which represent the observations pretty accurately up to May 8:—

	Right Ascension.		Declination.	Log. distance from the Earth. Sun.	
	h.	m.	s.	...	...
May 20	6	22	53	+ 56 43.7	0.38965 ... 0.27695
22	6	23	57	55 49.4	
24	6	25	3	54 56.6	0.39725 ... 0.27379
26	6	26	10	54 5.2	
28	6	27	17	53 15.1	0.40432 ... 0.27090
30	6	28	24	52 26.4	
June 1	6	29	32	+ 51 38.8	0.41084 ... 0.26829

It appears not improbable that this comet may be observed until towards the end of the year, arriving at its least distance from the earth early in November, and at the same time attaining its greatest intensity of light. It will be lost from proximity to the sun's place for several weeks about the perihelion passage, which is likely to occur about July 1, becoming visible again at the beginning of August in the morning sky. The orbit upon which the above places are calculated gives for the position on August 5 at 12h. G.M.T., right ascension 6h. 58.7m., declination +

31° 52'. The intensity of light on May 8 was about one-third less than is assigned for the first week in November.

PROF. C. A. F. PETERS.—We regret to have to record the death of Prof. Christian August Friedrich Peters, formerly of the Russian Central Observatory at Pulkowa, subsequently Professor of Astronomy in the University of Königsberg, and Director of the Royal Observatory at Kiel, and for upwards of twenty-five years editor of the *Astronomische Nachrichten*. After a long illness he died on the 8th of the present month, in his seventy-fourth year. We reserve a notice of Prof. Peters' principal astronomical work until next week.

GEOGRAPHICAL NOTES

BEFORE starting on his journey from Lake Nyanza to Lake Tanganyika, which we have previously referred to, Mr. J. Stewart, of Livingstonia, spent some time in examining the country on the west of the upper portion of the former lake. He started from Kaningina, and crossed the mountain of the same name at an elevation of about 5,000 feet. After a visit to Chipatula's village he entered Mombera's territory in the Kasitu Valley, and shortly reached the junction of the Kasitu with the Rikuru, which comes from the west through a wild and mountainous country. The valley of the Rikuru north of the junction is called Ntanta, and is exceedingly fertile; the elevation is about 3,700 feet, and the climate is cool and pleasant. Here Mr. Stewart noticed an important change in the geological formation, the granite and quartz giving place to soft shale and clay schists; and he is of opinion that the Kasitu forms the geological boundary, and that it runs in the trough of some great fault or nonconformity in the formation. Ten miles further north regularly stratified beds of hard, dark grey sandstone were met with. The Rikuru Valley, which Mr. Stewart thought would have taken him gradually down to the lake-level, is at its north end blocked by hills forming the lake coast, and the river flows through winding precipitous valleys, falling 2,000 feet in the last fifteen miles. The water enters the gorge clear and sparkling, and leaves it heavily laden with bluish clay silt, which is visible far into the lake. Mr. Stewart reached the lake at the mouth of this river in S. lat. 10° 45' 15". Marching northwards, he visited Mount Waller, which he examined thoroughly, and then, after keeping inland for four days, arrived at the Kambwe lagoon, his starting-point for Lake Tanganyika. The country from Mount Waller to this place is very poor, consisting of swamp and hard clay plain, broken here and there by dry gravel ridges, and occupied chiefly by large game.

THE International African Association have just issued the third part of their periodical publication, which contains extracts from the reports of their travellers in East Africa. M. Cambier gives an account of recent earthquakes on Lake Tanganyika and some details of the work at the station at Karema, the position of which he has fixed as in S. lat. 6° 47' 50". M. Popelin narrates the particulars of his journey from Tabora to Karema, and some of the plans for the future. There are also other letters from them, as well as from Mr. Carter and M. van den Heuvel and a medical report by Dr. Dutrieux. M. Burdo, the leader of the third expedition, announces his arrival at Mpwapwa on February 18, and sends a report on the route followed from Saadani. His caravan consists of 108 persons and fourteen asses.

THE German branch of the International African Society intends establishing the first German station at the southern extremity of Lake Tanganyika. The expedition, in which Capt. Scholler, the well-known zoologist, Herr Boehm, and Dr. Kaiser take part, has already left Berlin. Dr. Nachtigal made several communications on the subject at the last meeting of the Berlin Geographical Society.

NEWS has been received concerning the expedition of Dr. Mook and Herr von Holzhausen to the Pettit and Atbara rivers. The travellers left Kassala on January 9, and reached Tomat on the 16th, after crossing the Pettit and the Atbara. Tomat is the winter camp of the Sheikh of Dabanya bedouins. Here they were detained for eight days. Then they proceeded along the left bank of the Atbara as far as the mouth of the Bachar Salam River, but were then compelled to return on account of the absolute uncertainty of the country, and the indisposition of Herr von Holzhausen. The country near the Bachar Salam is completely deserted on account of hordes of Abyssinian brigands.

The travellers were robbed, and owe their lives simply to forced night-marches, gun in hand. They reached Kassala on February 12. Dr. Mook gives a sad account of the deplorable condition of the Soudan, where, as it seems, complete anarchy prevails.

THE United States Government is fitting out an expedition at San Francisco to search for the Arctic exploring vessel *Jeannette*, which has now been some months out. The revenue cutter *Corwin* has been selected for the duty, and she will start with one year's provisions. Her instructions are to search for two missing whalers also. The *Jeannette* went by what is called the eastern passage by Behring's Straits, and Capt. Markham, formerly of Her Majesty's ship *Alert*, of Polar fame, suggested that every year during the *Jeannette's* absence a vessel like the *Corwin* should be sent into the Arctic region to save her or to learn, as the case may be, of her progress.

AN Austrian expedition, under the guidance of Dr. Otto Benndorf, Professor of Classical Archaeology at the Vienna University, is about to start for Olympia. Besides Dr. Benndorf, Prof. E. Petersen (Prague), Dr. W. Gurlitt (Graz), some other member of the Vienna University, and an architect, will take part in the expedition. Dr. Wilhelm Klein, who has already started for Greece, will meet the expedition at Olympia. Another authority in archaeology, Prof. Ernst Curtius, has also started for Olympia.

THE Dutch ship *Willem Barends* is being equipped for a third North Polar Expedition.

HERR ROBERT VON SCHLAGINTWEIT, the well-known traveller, has arrived at New York, whence he will proceed to Washington. He then intends to go on a scientific tour to the West of North America.

THE first sheet of a large prehistoric map of Bavaria, by Prof. H. Ohlenschläger, has recently been published. It comprises the district where, in the present day, Munich, Rosenheim, and Kempten are situated. The whole map will consist of fifteen sheets.

No. 4 of Band xxiii. of the *Mittheilungen* of the Vienna Geographical Society contains the first part of an account of a botanical excursion to the Kasbeck (Caucasus) in the summer of 1871, by Peter Muromtzoff. At the monthly meeting of the Society, on April 27, a letter was read from Dr. Oskar Lenz from Tarudent, describing his passage of the Moroccan Atlas, in which he gives some interesting observations on the mountains and the people. Another letter was from Lieut. Kreitner, who accompanied Count Széchenyi in his attempt to penetrate Tibet through China. Lieut. Kreitner states that he plotted carefully the whole route of the party and took many observations, while his companion, Herr von Loewy, took as careful note of the geological features of the region traversed.

*L'Exploration* for May 13 has the second of a series of articles on Central Japan, Yeddo being the subject of the present instalment; there is also a translation of Lieut. Bove's project of Antarctic exploration, the main points of which we have already given; the number also contains reports of the geographical societies of Quebec and the Argentine Republic, and numerous notes and news, the sources of which, we regret to see, are seldom acknowledged, their value thereby being much decreased. Under the editorship of M. Tournafond this journal is improving, though we think there is still much to be done ere it can be regarded as occupying a first place among geographical journals.

DR. HOLUB, the well-known African traveller, has opened an interesting exhibition at Vienna, which contains thousands of objects brought by him from the South African tribes. They are arranged in various groups, and are classified as zoological, botanical, mineralogical, archaeological, ethnographical, and commercial objects.

### THE PARALLEL ROADS OF LOCHABER—THE PROBLEM AND ITS VARIOUS SOLUTIONS<sup>1</sup>

AT a recent meeting of the Inverness Scientific Society and Field Club, and again at Fort William, in the immediate neighbourhood of the phenomena, a lecture was given on the above subject by Mr. William Jolly, H.M. Inspector of Schools, who has, for more than ten years, devoted great attention to the

<sup>1</sup> By William Jolly, F.R.S.E., H.M. Inspector of Schools, Inverness.

subject, and will shortly publish the results of his investigations.

Mr. Jolly thought the subject peculiarly appropriate for their Society, both on account of its intrinsic interest and the eminent men who had written of it, and the proximity of the Club to the locality exhibiting these singular and attractive phenomena. His aim was to state the problem, to explain the solutions offered, give its bibliography, criticise the theories, and develop more fully the one he adopted. He first described the locality of the roads in Glen Roy, Glen Spean, Glen Gluoy, and Glen Laggan, all at the south end of the Great Glen; and their unique and striking aspect, such as to draw the attention of the primitive Celts. They had received several names, being known in Gaelic as *An Casan*, literally the feet, hence footpaths, of which *Parallel Roads* was a literal translation. Campbell of Islay's rendering, "The Bends," the Rev. Mr. McGregor, of Inverness, the Gaelic scholar, thought fanciful, and without foundation. They were also variously called "lines," "shelves," &c. The highest recognised is in Glen Gluoy at 1,172 feet, another existing there at 964; the three chief in Glen Roy stand at 1,148, 1,067, and 855; the lowest sweeping round into Glen Spean at the same level. A possible road, discovered by Darwin in 1838, in Glen Laggan, above the Loch Laggan Locks, is 1,300 feet high. Their breadth varies from 40 to 70 feet, giving an average of 60. They slope towards the valley at an angle of from 5 deg. to 30 deg., the hill face being inclined from 25 deg. to 40 deg.

Mr. Jolly then, by means of a printed diagram, which enhanced the clearness of the exposition, explained the Conditions of the problem, all of which must be satisfied by any theory claiming to be the true solution. These conditions were the following:—

#### I.—THE CONDITIONS OF THE PROBLEM

##### I.—The Peculiar Form and Character of the Roads

1. Their general horizontality and parallelism.
2. Their general equality of width (*a*) in the course of the same line, and (*b*) in relation to each other.
3. Their general continuity.
4. Their stair-like form, as of parallel layers laid successively on each other on the hill-side.
5. Their sloping towards the valley.
6. Their being proportionately narrower where they are steeper.
7. Their general absence where solid rock protrudes, and where the slope is exceptionally flat.
8. The *débris* of the hill above and below the Roads sloping more or less at the angle of repose.

##### II.—Their Composition

9. The absence of rounded, water-worn stones along them, and the general greater or less angularity of these.
10. Their consisting of the same *débris* as the rest of the hill-face, and not of transported matter.
11. The absence of cliffs, caves, and rock-notching, or any deep erosion, along their course.

##### III.—Their Distribution

12. Their sudden endings in all cases, without greater accumulations of *débris* or other indications of the cause of the same.
13. The symmetrical disappearance of the same lines at points opposite each other, in the same and contiguous valleys.
14. The outward extension of the roads, according to their lesser altitude.
15. Their occasional disappearance for considerable distances.
16. Their different altitudes in different glens, and the absence of the same lines in neighbouring glens.
17. Their being confined to Glen Roy and neighbourhood.

##### IV.—Their Relations

18. The existence of cols in connection with and slightly lower than each of the main roads.
19. The existence of other lines of a different character, above and below the roads. (Dwelt much on by Chambers.)
20. The existence of much terraced *débris*, below the roads, in the bottoms of the valleys containing them.
21. The relation of the roads to the glaciation of the district and its remains.

#### II.—THE SOLUTIONS OF THE PROBLEM

Mr. Jolly then expounded, by means of another diagram, the various theories proposed to satisfy these Conditions, and account for the Roads, naming the writers advocating them, with their

dates, and the various works which they had written. All these are given here in the following table:—

	THEORIES	WRITERS.	WORKS.
By man —Human.	Fingal ... ..	Old inhabitants.	
	Hunting roads of kings ... ..	{ Pennant ... .. 1763	Pennant's "Tour," 1771.
By a flood —Diluvial.	Aqueducts for irrigation ... ..	{ Playfair ... .. 1816	Proc. Roy. Soc. Edin., 1816
		{ Sir Geo. S. Mackenzie 1848	Edin. Phil. Jour., Jan., 1848
		{ Prof. Rogers ... .. 1861	Lect. Roy. Inst., Lond., March, 1861.
By the sea —Marine.		{ Darwin ... .. 1839	London Phil. Trans., 1839
		{ Lyell (visited 1825) ... .. 1841	"Elements of Geology"
		{ Chambers ... .. 1843	"Ancient Sea Margins"
		{ Rev. R. Boog Watson 1856	Geol. Soc. Lond. Jour., February, 1856
		{ Prof. Nicol ... .. 1863	Geol. Soc. Lond. Jour., August, 1863.
		{ Campbell of Islay ... .. 1877	"Parallel Roads of Glen-Roy," printed privately.
		{ Macculloch ... .. 1817	Geol. Soc. Lond., 1st series, vol. iv.
		{ Lubbock ... .. 1868	Geol. Soc. Lond. Jour., May, 1868.
	Nature of dam doubtful ... ..	{ Babbage ... .. 1868	Geol. Soc. Lond. Jour., August, 1868.
		{ Rev. T. Brown ... .. 1876	Proc. Roy. Soc. Edin., vol. viii. March, 1876.
Dam of <i>débris</i> —detrital dam.	{ Dakyns ... .. 1879	Geol. Mag., Dec., 1879	
	{ Dick-Lauder ... .. 1823	Trans. Roy. Soc. Edin., vol. ix.	
	{ Milne-Home ... .. 1847	Proc. Roy. Soc. Edin., 1847	
	{ Do. ... .. 1879	Trans. Roy. Soc., vol. xxvii., 1876.	
	{ Do. ... .. 1877	Trans. Roy. Soc., vol. xxviii., part 1, 1877.	
By a lake—Lacustrine.		{ Agassiz (visited 1840) 1842	Geol. Soc. Lond. Jour., vol. iii. 1842, "Atlantic Buckland (do.)" 1842
		{ James Thompson ... .. 1848	Edin. New Phil. Jour., vol. xlv.
		{ Jamieson ... .. 1863	Geol. Soc. Lond., vol. xix., January, 1863
		{ Darwin ... .. 1863	In private letters, &c.
		{ Lyell ... .. 1863	"Antiquity of Man."
		{ Archibald Geikie ... .. 1865	"Scenery and Geology of Scotland."
	Dam of ice— glacial dam...	{ Jolly ... .. 1873	Trans. Geol. Soc. Edin., April, 1873.
		{ James Geikie ... .. 1873	"The Great Ice Age."
		{ Sir Henry James ... .. 1874	"Parallel Roads of Lochaber," Ord. Sur. Off.
		{ Tyndal ... .. 1876	Roy. Inst., June, 1876; "Pop. Science Review," October, 1876.
	{ Prestwich ... .. 1875	Roy. Soc. Lond., NATURE, May 23, 1875, in abstract; Lond. Phil. Trans., 1880, in full	

III.—THE SOLUTIONS EXAMINED

After referring to the Traditional theories of Fingal and the Hunting Roads, adopted by Pennant in his remarkable "Tour," published in 1771, he told how Playfair had seen similar appearances exhibited by irrigation works at Brieg, in the Valais, which suggested to him his curious solution.

The Diluvial theory held that they were caused by an immense flood from the Atlantic, through a sinking of the West Coast, rushing impetuously along these valleys. There was no use seriously criticising this theory, though adopted in 1861 by Prof. Rogers, of Glasgow.

The Marine theory had had many able supporters, from its first suggestion by Darwin, in 1839, to Campbell of Islay, so recently as 1877. The greatest exponent of this theory was Robert Chambers, in his "Ancient Sea Margins," published in 1848. He held that these lines were nothing but sea beaches, similar to those found so plentifully all over the country. He contended that other lines in these same glens were of the same kind; but these had been shown by Mr. Jolly, in 1873, to be entirely different in character, outline, and composition, and were probably moraines. Mr. Jolly then traversed the Conditions of the problem laid down on the diagram above, and showed how this theory violated, or failed satisfactorily to account for, Nos. 1, 4, 5, 7, 9, 11, 12, 13, 14, 15, 16, 17, 18, 19, and 21, each of which may be tested by the reader.

The Lacustrine theory would be found not open to the same objections. The great difficulty here was the nature of the dam, or barrier, that confined the waters of the lakes, of which the famous Roads were the successive shores or beaches. This theory was propounded, in 1817, by the far-seeing Macculloch, the eminent

geologist, and early delineator of Highland scenery and geology; but he, along with others, had not condescended on the kind of barrier required. Two styles of dam had been contended for, the one of detritus, the other of ice. The Detrital dam, first suggested by Dick-Lauder in 1823, had been adopted by Milne-Home, who accompanied Robert Chambers to the region in 1847, and had written of it then, and twice since, with an amount of observation and detail that were of great and permanent value. These writers held that the lakes were contained by huge banks of *débris*, deposited by the sea and other causes, similar to that existing abundantly in many parts of the country. There was no doubt whatever that a large number of lakes, past and present, had been dammed back by such a barrier in many places; but if the roads were so formed, why were not such remarkable lines (whose character was unique) found elsewhere? Mr. Jolly here examined this theory in detail, in connection with the requisite Conditions, and held that it failed to satisfy many of them. How were these barriers so conveniently deposited at the required points, when the Great Glen, and the other valleys were, according to Milne-Home, filled with similar detritus? In the other lakes adduced by him, the outlets were *over the débris*, gradually wearing it away, while here they existed at the upper ends, flowing over hard rock. The roads ended abruptly on the hill face, with no remains of the asserted barriers, heaped up *at their extremities*, as might be expected, and was almost universal. How were the requisite great accumulations so effectively removed, reaching, as these must have done, to above 1,300 feet? The successive roads were on the same hill-face; so that the damming *débris* must have been wholly removed between the lines at their lower ends, before the new beaches were laid down. Mr. Jolly entered into other difficulties attending this theory, and finally concluded against it.

IV.—THE GLACIAL THEORY, AS ADOPTED

The Glacial theory was started by Agassiz, the great Swiss, who had been accustomed to the work of glaciers, after a visit paid to Lochaber in company with Buckland, in 1840. It has had the greatest number of adherents, Darwin and Lyell having also given up the Marine theory for it. Its chief exponent was Jamieson of Ellon, in an admirable paper published in 1863. Mr. Jolly, by means of a large survey map, variously coloured, entered into a careful explanation of the glaciation of the region. He held that the roads were produced by lakes dammed back by glacial ice, filling the lower parts of the valleys up to the ends of the roads, and gradually retreating with the ameliorating climate, *at the last stage of the second portion* of the Glacial epoch, immediately before the final disappearance of local glaciers from Scotland. The abundant rolled *débris* at the bottom of these valleys was laid down by former glaciers, and by the sea during the great depression in the *middle* of the Glacial period. He described the peculiar configuration of the Ben Nevis Range, with its parallel system of valleys opening out, on the south, to the close, deep Glen Nevis and its eastern continuation, and, on the north, to the broad Glen Spean and broader Glen More. The peculiarity of Glen Spean was that it would receive not only the abundant ice from the glens opening directly on it on the south, but also the greater part of the ice accumulated in Glen Nevis and its continuation, by the two outlets of Loch Treig and Glen Nevis itself. By this means, and by its special relation to the highest mountains in Scotland, it would receive an unusual supply of ice, equalled by no other valley in the country. This was proved not only by its geographical conformation, but by the superabundant glacial remains in the district, of which Mr. Jolly gave full details. During the first period of greater glaciation, the ice from Loch Treig, after entering Glen Spean, turned east down Loch Laggan, and west down the Spean; while Glen Roy itself was filled with an ice-stream from the same valley, which *quered out at its head, down the Spey*, as shown convincingly by the ice-markings there; and the Great Glen and its side valleys were also swathed in ice. As the climate improved at the *close* of the ice period, the glaciers gradually shrank backwards to their sources in the high Nevis glens, which, from their altitude and neighbourhood to the vapour-feeding Atlantic, would be the last in the country to preserve local glaciers. At that time, from its peculiar relations to these glens, Glen Spean would be filled from its head to the sea with a great ice-stream, resting on the *débris* already deposited by the sea, &c., and moving slowly downwards. This stream, entering the south end of Glen Roy, dammed back a lake there, fed by its tributary torrents, which has left its traces in the roads. As the ice gradually shrank in successive steps, the water subsided and the lake extended, as shown by these

lines. Mr. Jolly here pointed out the position of the successive contractions of the ice required to dam the lake, and described the abundant evidences of this last stage of the glaciers there, in scratchings, carried blocks, boulder clay, &c., and in the splendid horse-shoe moraines of the Treig glacier, lying intact across and along Glen Spean. He held that the lowest road extended up Loch Treig only a short distance, suddenly ceasing there, and not round the whole lake—an additional remarkable proof in favour of a glacier then filling that basin down to the ends of the roads, where a dam was necessary. Similar remarks were made regarding the Glen Gluoy and Glen Laggan parallels.

By means of coloured additions laid over the map, the state of the ice at this period, necessary to fulfil the requisite conditions, was graphically exhibited. Mr. Jolly concluded with an appeal to the Society to study the fascinating problem on the ground itself, so as to help to a final settlement of the much-debated question. Inverness had already done honourable work in connection with it, for the height of the lowest road had been first determined by an Inverness man, Mr. Wm. Paterson, sent there for the purpose in 1847 by Mr. Joseph Mitchell, at the request of Mr. Robert Chambers.

Mr. Horne, of the Geological Survey, Banff, and others, afterwards spoke on the subject, and a cordial vote of thanks was awarded to Mr. Jolly.

The reader may consult with advantage, for the better understanding of the subject, the admirable maps of the district of the Ordnance Survey, both the six- and one inch, in which the Roads and the related phenomena are accurately and fully laid down; or the special Ordnance selected map of the locality, appended to the paper of Sir Henry James, mentioned above.

### UNIVERSITY AND EDUCATIONAL INTELLIGENCE

CAMBRIDGE.—The authorities of both Girton and Newnham Colleges have supported the general memorial of 8,500 persons in favour of the admission of women to academical degrees and examinations, by informing the Senate in detail of their past proceedings, the number of their students who have been examined informally, none of whom have failed to attain Tripos standards; and both colleges believe that they will be able to offer sufficient guarantees of stability and good administration, so that the University can admit their students to full academical privileges.

Newnham College has now been fully constituted, with Prof. Cayley as president. Prof. Adams has ably aided the Women's Educational Association during the last seven years as president, and now retires, on the amalgamation of Newnham Hall with it, retaining his place on the Council.

Mr. K. C. Rowe, of Trinity College, is appointed an Examiner in the next Mathematical Tripos, and Mr. A. G. Greenhill Additional Examiner.

Dr. Alexander Dickson has been appointed Regius Professor of Botany in the University of Edinburgh and Keeper of the Royal Botanic Garden of that city in succession to Dr. Balfour, who resigned some time ago.

The new representative Council of Education in France has been completed by the appointment of a number of official members. M. Berthelot has been nominated President by the Ministry. A number of sections and special commissions have been established, amongst which we must direct attention to the Commission for Reforming Secondary Instruction. One of the principal features of the intended reform is to divide secondary instruction into three different courses, so that any pupil leaving the school after having gone through the elementary course might have a general knowledge of the principal subjects which are to be investigated more fully in the other two courses.

The University of the City of Pesh celebrated its hundredth anniversary in presence of the Emperor on the 13th inst.

### SCIENTIFIC SERIALS

*Annalen der Physik und Chemie*, No. 4.—On the propagation of electricity through current water in tubes, and allied phenomena, by L. Dorn.—Thermic theory of the galvanic current, by J. L. Horweg.—On the cause of excitation of electricity in contact of heterogeneous metals, by F. Exner.—On diffusion of salts in aqueous solution, by J. H. Long.—On the relation between propagation of light and the density of bodies, by H. A.

Lorenz.—On Stokes's law, by O. Lubarsch.—On after images of motion, by G. Zehfuss.—Supplementary note to the paper on currents of the Gramme machine, by O. E. Meyer and F. Auerbach.

### SOCIETIES AND ACADEMIES

LONDON

Royal Society, April 29.—"Measurement of the Actinism of the Sun's Rays and of Daylight." By Dr. R. Angus Smith, F.R.S.

When examining the air of towns and the effect of smoke and fog, I have often wished for a very simple chemical method of measuring the total light absorbed by these gases, vapours, and floating solids. I do not undervalue the work of others, but I think I have obtained a process promising good results with great simplicity, although I daresay it introduces its own class of difficulties.

1. The fundamental fact is that when iodide of potassium in solution is treated with nitric acid, so small in quantity as to cause no change of colour in dull diffused light, a change takes place when the same mixture is brought into clear light; iodine is set free and the solution becomes yellow.

2. The amount of iodine freed can be titrated with great exactness by the use of hyposulphite, as is well known.

In these two facts lies the whole process: the first is the new part, the second makes the first quantitative, and its use is of course part of the novelty.

3. It is known that strong acid liberates iodine. Weak acid does so after a long time, but the process is hastened by light.

4. Heat even to the boiling point does not act so well as light (experiments being made in sealed tubes to prevent loss of iodine, and with a considerable volume of air).

5. Heat assists the action of light.

6. A solution may be exposed day after day so as to give the accumulated effect of sunlight, in a measurable condition at the end of the time.

7. The solution of iodide of potassium as hitherto obtained is subject to change. An old solution, that is, one nearly a month old, was found more sensitive than a new one in all cases tried.

8. The result of No. 7 is, that a certain allowance may require to be made for this, in those cases where the periods of observation with one solution are long.

9. The amount of allowance to be made for temperature is not made out. It is not certain that any is required in the cases when weak acid is used. The weather has not allowed any combined action of great light and heat, but with heat and light in the rays from an electric light with a parabolic reflector, the action was very rapid.

10. Specimens of experiments (prospective at first). It was found convenient to use a solution of 2 grms. of iodide of potassium, afterwards changed to 1 grm., in 100 of water, and to use half of this for an experiment, i.e., 50 cub. centims. of the solution, which may be called A.

A nitric acid solution having an acidity equal to 1 per cent. of sulphuric anhydride was made; this may be called B. Only very small portions of B were added to A.

Examples in which the decomposition was measured by a solution of hyposulphite of sodium, which may be called solution C = 0.1 grm. per litre of iodine (or as convenient). I shall extract experiments made with B solution 0.8 cub. centim., because it is an intermediate one (.2, .4, .8, 1.6, and 3.2 have hitherto been the favourites).

Date	Description	B sol.	Time	Measurement by C solution (hyposulphite)
Mar. 3	Sunshine and cloud alternately	0.8	After 2 1/2 hours	21. First colour in 20
" 4	Sunshine ... ..	0.8	—	First colour in 30
" 5	Dull all day ... ..	0.8	" 4 "	0.9
" 8	Sunshine ... ..	0.8	" 2 1/2 "	7.5 Colour in 20
" 9	A little sunshine ... ..	0.8	" 2 1/2 "	4.8
" 10	Foggy, with a gleam of sunshine	0.8	" 6 "	1.5
" 11	Bright ... ..	0.8	" 2 1/2 "	7.2
" 12	Dull and wet ... ..	0.8	" 3 "	0.6
" 13	Dark and dull ... ..	0.8	" 2 1/2 "	Faint trace
" 15	Changeable ... ..	0.8	" 2 1/2 "	1.2
" 16	Changeable ... ..	0.8	" 2 1/2 "	1.6
" 17	Sun through haze ... ..	0.8	" 2 1/2 "	5.8
" 19	Bright ... ..	0.8	" 2 1/2 "	11.5
" 20	Fog till 11.30 ... ..	0.8	" 2 1/2 "	3.2
April 1	Sun and showers ... ..	0.8	" 2 1/2 "	1.6

(a) 2½ hours' exposure to not very bright clouds; (b) in dark:—

(a) Temp 12° C. in light.				(b) Temp 20° C. in dark.			
Sulphuric acid used, same acidity.		C. sol. required.		Sulphuric acid.		C. sol. required.	
0.4	...	0.5	...	0.4	...	0	...
0.8	...	3.9	...	0.8	...	0	...
1.6	...	4.9	...	1.6	...	0	...
3.2	...	6.1	...	3.2	...	0	...

11. There seems, therefore, no reason to doubt that this is a true photometric process, with special capacities to be developed in time. I may add that I did obtain better results at the window of my house than at the laboratory at the same time, the latter being nearer the centre of the town; thus the process has done the duty it was intended for, although only once tried for this special purpose. I am looking to it as an agent specially for the examination of climate, but of course it may have many uses. This process does not aim at delicacy, but at accumulation of effect. I have not spoken of a standard; the results are only comparative, but the process may be made to supply its own standard.

12. Since writing the above it appears that by using sulphuric acid some of the fears at first entertained may be avoided, as is shown by the following extract:—

B. sol.	C. sol. required after 2½ hours' exposure of A to light.	C. sol. required after 50 hours' exposure of A to darkness.
0.2	...	7.0
0.5	...	15.1
1.0	...	23.4
2.0	...	30.4
4.0	...	43.6
6.0	...	53.8

The temperature of the solutions exposed to light = 13° C., kept in darkness = 22° C. The iodine volatilized by heat was found so little that it might be neglected here.

The strength of solutions and the kind of acid to be used may vary. Similar results may be got by using bromide of potassium, but it is less delicate. The surface exposed and other questions require attention.

**Mathematical Society, May 13.**—C. W. Merrifield, F.R.S., president, in the chair.—The following communications were made:—On Cremonian congruences, by Dr. Hirst, F.R.S.; on some statical and kinematical theorems, by Prof. Minchin; on a class of analytical problems, by Prof. Cayley, F.R.S.

**Linnean Society, May 6.**—H. T. Stanton, F.R.S., in the chair.—Three Foreign Members were elected.—Mr. T. Christy read a letter from Mr. Blacklaw, of St. Pauls, Brazil, intimating that his experiments to rear the Liberian coffee-plant had all failed, though different seasons, altitudes, and other conditions, without and indoors, had been tried.—The abstract of a paper by Prof. G. Dickie, notes on algae from the Amazon, was read by the Secretary. This collection was made by Prof. J. W. H. Trail, and consists of 288 species, whereof 190 are diatoms, 31 desmids, and 67 other algae, 9 of the latter being new forms.—Prof. P. M. Duncan orally communicated the substance of a paper on an unusual form of the genus *Hemiphysalis*, Agass. This was dredged by Dr. Wallich off the Algulhas Bank, S.W. of the Cape of Good Hope. Its zoological position may be doubtful, for the classification of the Ophiuroidea is at present full of anomalies; but the specimen itself nevertheless possesses unusual interest from the nature of the so-called dental or chewing apparatus. These peculiar dental structures and other points were elucidated by the author.—Mr. G. T. Bettany gave some remarks on the vocabulary of botanical terms in use in the description of flowering plants. The author advocated making a distinction between terms used in elementary descriptions in educational works and those used in the terse and complete floras. Under evolution there was much chance of botanical progress if terms were simplified and made such as children could comprehend; but almost every book aiming at comprehensiveness became obscure. Thinking it necessary to give every possible variety of terms and to add to them, it repelled, instead of aiding in the wide diffusion of knowledge. For these and other reasons the author strongly objected to the now too frequent use of tri- and polysyllabic terms.—Prof. Ray Lankester read a paper on the tusks of the fossil walrus found in the red crag of Suffolk. He withdraws the generic name of *Tricheodon*, instituted by him in 1865, and refers a series of later-discovered large tusks in the Ipswich Museum, as also his formerly-

described specimens, to the living genus *Trichechus*, but specifically distinguished in this case as *T. fluxleyi*. He is inclined to think there is insufficient ground for the generic subdivisions *Alachtherium* and *Tricheodon*, as used by Van Beneden, and moreover signifies his opinion that there is yet no good evidence in support of the association of the Suffolk and Antwerp tusks.—A short communication, on an irregular species of *Amblypneustes*, by Mr. Chas. Stewart, was taken as read.

**Zoological Society, May 4.**—Prof. W. H. Flower, F.R.S., president, in the chair.—Mr. Sclater exhibited a specimen of the Ibis (*Geronticus comatus*), lately obtained at Biledjik, on the Euphrates, by Mr. Danford, and made some remarks on its previously-known distribution.—Dr. A. Günther read a note correcting the statement made by him at the meeting of the Society on January 20 last respecting the occurrence of *Holocentrus tricolor* on the British coast. Further particulars received by Dr. Günther had led him to decide that this fish could not be considered as having been caught on the British coast.—Mr. W. A. Forbes read a note on the cause of death of a leopard in the Society's menagerie.—Mr. Dobson exhibited and made remarks on some bones of the Dodo which had been transmitted from Mauritius in 1847–50 by Dr. F. Reid to Sir James Macgregor, and having been deposited at Fort Pitt, Chatham, were afterwards removed to Netley Museum.—Mr. F. Jeffrey Bell exhibited the immature specimen of *Echinolampas*, referred to by him in his communication on *Puleolampas*, pointing out its more differentiated characters, and suggested the possibility of its being an example of *E. oxyformis*.—Prof. Flower called the attention of the meeting to the fact that a young specimen of the Lesser Fin Whale (*Baleonoptera rostrata*), fifteen feet long, which had been taken off the coast of Cornwall, was now being exhibited in London.—A communication was read from Prof. J. O. Westwood, containing an account of the species of Sawflies composing the Australian genus *Perga* of Leach.—A communication was read from Dr. W. J. Hoffman on a supposed instance of hybridisation between a cat and a lynx.—Mr. W. A. Forbes read the second and third parts of his series of papers on the anatomy of Passerine birds. The communications related to the syrinx and other points in the anatomy of the *Eurostamida*, and to the structure of *Philopitta*, and its position among the Passeres.—A communication was read from Mr. F. Day, in which he gave the description of a new Entomostracoon from Afghanistan.—Mr. Oldfield Thomas read a paper on a collection of mammal brought from Ecuador by Mr. Clarence Buckley. Among these was a new species of *Nassaricyon*, proposed to be called *N. alleni*.—Mr. A. G. Butler read a paper containing descriptions of a collection of Lepidoptera made by Major Howland Roberts at Rokeran, near Kandahar, on the River Urgundab.—Mr. G. French Angus read a paper containing further additions to the marine molluscan fauna of South Australia, with descriptions of six new species.—A second paper by Mr. Angus contained the descriptions of three species of marine shells from Port Darwin, Torres Straits, discovered by Mr. W. J. Bednall, and of a new *Ilelix* from Kangaroo Island, South Australia.

**Geological Society, April 28.**—Robert Etheridge, F.R.S., president, in the chair.—Rev. James Oliver Bevan, M.A., Arnold Hague, Augustus Constable Maybury, Henry Peter Meaden, William Peregrine Probert, and Francis Randell were elected Fellows of the Society.—The following communications were read:—Description of parts of the skeleton of an anomodont reptile (*Platypodocaurus robustus*, Ow.) from the trias of Graaff Reinet, South Africa, by Prof. Owen, C.B., F.R.S. The author referred to certain triassic reptiles from South Africa, already described by him, as showing certain resemblances to implacental mammals. Another still more interesting indication of such resemblances is furnished by some remains from Graaff Reinet received from Mr. E. J. Dunn. These consist of some thoracic vertebrae with portions of ribs, a sternal bone, a scapula, and a right humerus, found imbedded in one mass of rock, and of a femur and phalanges, and a pelvis in another mass. The author described these bones in detail. The vertebrae were said to agree most nearly with those of *Dicynodon* and *Oudenodon*. The supposed sternal bone is of a rounded hexagonal form, and is regarded by the author as the anterior bone of the sternum proper, which is usually unossified in recent lizards, but well ossified in *Ornithorhynchus*. In the scapula, also, the author pointed out resemblances to that bone in *Ornithorhynchus*. The humerus in its general proportions, and

especially in the great development of its ridges, was also shown to resemble the same bone in the Monotremes. The ungual phalanges were described as broad and obtuse, probably constructed to bear claws adapted for digging, as in *Echidna*; the femur also resembles that of the last-named animal. The author remarked upon the approximations to the monotrematous mammalia, in allusion to which he proposed the name of *Platy-solosaurus robustus* for this animal, the humerus of which was 10½ inches long and nearly 6 inches broad at the distal end. He also alluded to the interesting problems opened up by the study of these South-African reptiles in connection with their possible relationships to the low implantal mammalia of New Guinea, Australia, and Tasmania.—Note on the occurrence of a new species of *Iguanodon* in the Kimmeridge clay at Cumnor Hurst, three miles west of Oxford, by Prof. J. Prestwich, F.R.S. The one in which the occurrence of *Iguanodon* was discovered was worked in Kimmeridge clay at the foot of an outlying mass of Lower Greensand forming an isolated hill. The Portland beds, which occur at Shotover, are here wanting. The bones were found in a thin sandy seam intercalated in the clay, and traversing the hill at least fifteen feet below the greensand. The skeleton was probably almost entire; but, as attention was not directed to it until nearly all the clay had been removed, many bones were lost and others injured. Several vertebrae of *Tachysaurus* were found in the same seam, and the characteristic *Gryphaea virgata* occurred in profusion. The clay above and below contained fossils of Kimmeridge types. The author stated his opinion that land probably lay to the south-west of the Oxford district.—On *Iguanodon pristichii*, a new species from the Kimmeridge clay, by J. W. Hulke, F.R.S. In this paper the author described in detail the remains of *Iguanodon* found at Cumnor Hurst in the Kimmeridge clay, as described in the preceding paper. They illustrated nearly every part of the skeleton of an immature individual, adding greatly to our knowledge of the variation of the vertebrae in the several regions of the vertebral column, and of the structure of the head and hind limbs. In the latter both the tibia and the fibula articulate (as in embryo birds) with the *os calcis*, which bone is now first identified in *Iguanodon*. The sacral vertebrae were only four in number, and the species further differed from the Wealden *Iguanodon mantelli* in the simpler character of the serration of the teeth, of which the lamellae are not mammillated, and in having the vertebrae of the trunk and sacrum not so compressed. The author named the species *Iguanodon pristichii*.

**Institution of Civil Engineers, May 11.**—Mr. W. H. Barlow, F.R.S., president, in the chair.—On the manufacture and testing of Portland cement, by Major-General H. V. D. Scott, F.R.S., and Mr. Gilbert R. Redgrave.—On Portland concrete, and some of its applications, by Mr. E. A. ...—On Portland cement: its nature, test, and ...

**Anthropological Institute, May 11.**—A. L. Lewis in the chair.—The following papers were read:—Notes on prehistoric di coveries in Central Russia, by C. H. E. Carmichael, M.A.—Notes on the occurrence of stone implements of the surface ... South Russia, by W. D. Gooch.—Notes on the ... Regions, by A. Wyhe.—On jade implements in ... and, by Hodder M. Westropp.—Flint implements from the Valley of the Banu, by W. J. Knole

PARIS

**Academy of Sciences, May 10.**—M. Edm. Becquerel in the chair.—The following papers were read:—On the transcendents which play a fundamental part in the theory of planetary perturbations, by M. Tisserand.—On a proposition of the theory of elliptic functions, by M. Hermite.—On a rain of dust observed from April 21 to 25, 1880, in the departments of Basen-Alpes, Here, and Am, by M. Daubrée. This dust gave a reddish tinge to snow on the mountains at Barcelonnette, up to 2,800 and 3,000 m. (snow further up remaining white). Its chief mineralogical characters were: effervescence with acids, mixture of hydrated peroxide of iron, presence of spangles of mica, residue of fusible acids, principally feldspathic. The dust is thought to be of terrestrial origin, but not volcanic, nor Saharan. (Somewhat similar showers fell in France in October, 1846, and May, 1863.) The same phenomenon seems (from another note) to have been experienced at Autun (Saône-et-Loire) on April 15, 1860, ten days before.—On the crystalline form of magnesium, by M. Des Cloizeaux. Having examined the fine magnesium crystals lately obtained by M. Dumas, he finds that among the rhombohedral metals magnesium is that which, after zinc, pre-

sents the most acute primitive rhombohedron. The crystals in question are very malleable and sectile; no cleavage was observed.—On a Cicadella (*Hysteropterum apterum*) which attacks the vines in the department of the Gironde, by M. Blanchard.—On the law of reciprocity in the theory of numbers, by Prof. Sylvester.—On the new siphon established over the Canal Saint Martin, and on the works of sanitation of the Bercy quarter, by M. Levy. The sewers of Bercy (which formerly discharged into the Seine) are in some parts lower than the collector designed for them, and had to cross the Canal Saint Martin to reach this. An ingenious system of siphons and trompes was devised to

prevent ... the explosives liberate dioxide of hydrogen and carbonic oxide. It is important, then, in mining operations to avoid with all care failure of detonation.—On the determination of algebraic integrals of algebraic differentials, by M. Zeuthen.—On simultaneous linear equations and on a class of non-plane curves, by M. Picard.—On a class of functions of two independent variables, by M. Picard.—On the theory of phenomena of interference where rotatory polarization intervenes, by M. Gouy. He takes a point of view of interference phenomena different from that of Fresnel, and superior in simplicity.—On the equipotential lines of a plane formed of two halves unequally inductive, by M. Guéhard.—On the mutual actions of magnetic needles plunged in liquids, by M. Obalski. Two magnetic needles are hung opposite each other (and a little beyond the range of attraction) by two unlike poles from very fine threads over water in a vessel, which water can be raised gradually over them (by means of a connected tube of caoutchouc). When immersion begins, the needles draw near each other by their immersed parts, and when the immersion has reached the third or fourth of the needles' length, they go together. This is probably due to the separating force of gravity being weakened by immersion.—Analysis by the graphic method of movements produced by excitations of the brain, by MM. François Franck and Pitres. To the detached tendon of a limb muscle they attached the transmitting myograph; an electro-magnetic signal (of M. Deprez) registered the time on the drum, and another signal the excitation. The character of movement caused by various electrical excitations is described. As to retardation of the movement on the instant of cortical excitation, this is found constant for a given muscular group in the same animal, whatever the form or intensity of the electric excitant. A notable part of it is due to physiological resistance of the grey cortical substance. Beyond a certain intensity of stimulation movements are produced on the same side of the body as the part of brain stimulated, as well as on the opposite, and the retardation for these movements is greater. The retardation is greater for hind than for fore limbs.—On a rain of dust at Autun, by M. De Jussieu (see above).—M. De Lesepès presented specimens of ... from California, and gave some information about Mr. Mackay's mines at Virginia City, the galleries of which have been ... about 1,000 metres, a depth hardly exceeded in Europe (Bod ... Descent is by means of hydraulic motors.

CONTENTS

By A. H. KEANI

LETTERS TO THE EDITOR:—  
Ice Crystals.—JOHN LE CO  
Anchor-Ice.—J. RAY  
"SARCONS."—A. G. RENSHEAW  
AN ENTOMOSTRACON LIVING IN THREE JOBS (*With Ill.*)  
ON THE PHYSICAL ASPECTS OF THE VORTEN-ATOM  
TOIVER PRESSION  
COMPARATIVE ANATOMY OF MAN, I. By PROF. I. LOWRY, F.R.S. . . . 5  
VARIATIONS FROM MARIOTTE'S LAW (*With Illustrations*) . . . 6  
OUR ASTRONOMICAL COLUMN—  
The Transit of Mercury, May 5-6, 1878 . . . 67  
The Second Comet of 1880 (Schaberle, April 6) . . . 67  
Prof. C. A. F. Peters . . . 67  
GEOGRAPHICAL NOTES  
THE PARALLEL ROADS OF LOCHABER.—THE PROBLEM AND ITS VARIOUS SOLUTIONS. By WILLIAM JOLLY, F.R.S.E. . . . 68  
UNIVERSITY AND EDUCATIONAL INTELLIGENCE . . . 70  
SCIENTIFIC SERIALS . . . 70  
SOCIETIES AND ACADEMIES . . . 70

ERRATA.—Vol. xxi p. 202, col. 2, line 5 from bottom, for "Lethô" read "Pethô"; p. 220, col. 2, line 22 from bottom, for "Letho" read "Pethô."



THURSDAY, MAY 27, 1880.

MATHEMATICAL JOURNALS

*American Journal of Mathematics, Pure and Applied.*  
Published under the auspices of the Johns Hopkins University. Vols. i., ii. (Baltimore: John Murphy and Co.)

THE *American Journal of Mathematics* has now completed its second volume, and has obtained an established place among the leading mathematical journals. Thanks to the Johns Hopkins University at Baltimore, America possesses, what has never been attempted in England, a *quarto* journal entirely devoted to mathematics.

Perhaps in no branch of science is the literature of the subject so exclusively confined to periodical publications as in mathematics. The books that are written are merely text-books and, in this country, generally have reference to certain special examinations. Of course there are exceptions which will immediately occur to mathematicians, such as Salmon's treatises and Todhunter's histories, and the exceptions are more numerous in Germany; but, even when all the books published in all languages which are above the rank of school-books are included, they bear an extremely insignificant proportion to the amount of original mathematical literature contained in periodical publications; in fact it would be impossible to form any idea of the present state and extent of mathematical science from any study of the books upon the subject. The same is to some extent true of all branches of science; but the want of treatises is greatest in mathematics on account of the smallness of the audience addressed and the impossibility of expressing even the results in a manner intelligible to the non-mathematical reader.

As a consequence of the scarcity of treatises there are many extensive branches of mathematics (such as, for example, the Partition of Numbers) which exist only in the periodicals; and the contents of the latter are therefore less transitory, so to speak, than in other sciences, *i.e.*, the papers are less liable to be superseded by subsequent writings and to become only of historical interest.

A journal devoted to a special subject always promotes activity in that subject, as one paper gives rise to another; but, besides this, it collects in one place many researches which would otherwise be widely scattered in the publications of different societies; and this latter advantage is much more apparent when, as in the case of the *American Journal*, its extent is sufficient to enable it to receive elaborate memoirs. Thus M. Lucas' "Théorie des Fonctions simplement périodiques" occupies 90 pages, and Mr. McClintock's "Essay on the Calculus of Enlargement" 61 pages. There is no reason to suppose that the majority of the papers contained in the *American Journal* would not have been written and printed, if the latter had not existed, but it is a real gain to the mathematician to have them all united in a single periodical.

The great increase in the number of mathematical journals in the last few years is very remarkable. The following is, we believe, a complete list of all the journals now in existence which are exclusively devoted to mathe-

atics, with place of publication and date of foundation. An asterisk denotes that the journal to which it is prefixed admits problems for solution:—

AMERICA	
* <i>Analyst</i> ... ..	[Des Moines, 1874], 8vo.
<i>American Journal</i> ...	[Baltimore, 1878], 4to.
ENGLAND	
<i>Quarterly Journal</i> ...	[Cambridge, 1839], 8vo.
<i>Messenger</i> ... ..	[Cambridge, 1862], 8vo.
FRANCE	
<i>Journal (Liouville)</i> ...	[Paris, 1836], 4to.
* <i>Nouvelles Annales</i> ...	[Paris, 1842], 8vo.
<i>Bulletin</i> ... ..	[Paris, 1870], 8vo.
GERMANY	
<i>Journal (Crelle)</i> ... ..	Berlin, 1826], 4to.
<i>Archiv (Grunert)</i> ... ..	Greifswald, 1841], 8vo.
<i>Zeitschrift (Schlomilch)</i> ...	Leipzig, 1856], 8vo.
<i>Annalen (Leibsch)</i> ... ..	Leipzig, 1869], 8vo.
<i>Fortschritte</i> ... ..	Berlin, 1871], 8vo.
<i>Repertorium</i> ... ..	Leipzig, 1877], 8vo.
ITALY	
<i>Annali (Tortolini)</i> ...	[Rome, 1850], 4to.
<i>Giornale (Battaglini)</i> ...	[Naples, 1863], 8vo.
<i>Bullettino (Boncompagni)</i> .	[Rome, 1868], 4to.
BELGIUM	
* <i>Nouvelle Correspondance</i> .	[Mons, 1874], 8vo.
HOLLAND	
<i>Nieuw Archief</i> ... ..	[Amsterdam, 1878], 8vo.
DENMARK	
* <i>Tidsskrift</i> ... ..	[Copenhagen, 1859], 8vo.

To these may be added the \**Reprint* [London, 1864] from the *Educational Times*, consisting almost entirely of problems and solutions; and also, although not strictly journals, the *Proceedings* of the London Mathematical Society [London, 1865] and the *Bulletin* of the French Mathematical Society [Paris, 1872]. The object of two of the journals, the *Fortschritte* and the *Repertorium*, is to give *résumés* of papers published elsewhere. It may be observed that all the journals included in the above list are strictly mathematical, although in the titles of some of them mathematics is coupled with physics or astronomy. A few minor periodicals, appearing at long intervals, have been omitted.

Thus of the nineteen journals included in the above list no less than seven have been founded in the last ten years, while four were founded in the preceding decade, 1860-70, so that only eight date from farther back than 1860. The oldest and by far the most celebrated journal is *Crelle*, which has now reached its eighty-ninth volume; many of the most important mathematical discoveries of the present century are contained in its pages.

The publication of problems and solutions in a mathematical journal is always to be regretted, as it is impossible not to feel that the space might be better occupied, and that the presence of mere exercises in a periodical which should be devoted to the advance of the science is undesirable. Their insertion in several cases is doubtless due to a wish to increase the number of readers by including a class who would take but little interest in, or be unable to follow, original mathematical researches; but the "problem for solution" may even be defended on scientific grounds, as it is a well-known historical fact that not a few of the greatest mathematicians were first led

to take a strong interest in mathematics by being tempted in their younger days to attack such questions. It may be remarked also that the mathematical problem has itself undergone great improvement since the days of the *Ladies' Diary*, when the problems usually appeared by the side of the enigmas, charades, &c. These problems were generally merely made-up exercises or puzzles—such as are to be found now only in examination papers—in which the data were wholly fictitious or even ridiculous; the modern problem, especially in pure mathematics, is often a theorem, or a particular case of a theorem, of very considerable intrinsic interest. It is right to mention that the *Nowvelles Annales* is really intended mainly for purposes of instruction, and that apparently a Continental student derives from this publication very much the same kind of practice and skill in the treatment of problems which at Cambridge he would obtain from his private tutor.

The history of mathematical journalism in all countries seems very similar: first, there is the Annual or other periodical, containing at the end puzzles, problems for solution, &c., the best solutions and the names of those who sent in correct solutions being given in the following number; at length these are supplemented by short articles on particular subjects—frequently suggested by the problems—by the leading contributors. The next step is the mathematical journal, consisting of two parts, the one containing original papers, and the other—quite distinct—containing a limited number of problems and solutions. Finally we have the strictly scientific journal, differing in no essential respect from the *Transactions* of a society; and, it is scarcely necessary to remark that, on account of the length of many of the formulae, a quarto journal is preferable to one of octavo size.

From an interesting account of American mathematical periodicals by Mr. David S. Hart, which was published in the *Analyst* for September, 1875, it appears that the first mathematical journal published in America was the *Mathematical Correspondent*, which was issued at New York on May 1, 1804, and of which eight quarterly numbers only were published. The next periodical was the *Analyst, or Mathematical Museum*, of which the first number was published in 1808; five numbers only appeared. In January, 1825, the first number was issued of the *Mathematical Diary*, which continued till March, 1832; for the first two years it was published quarterly, and for the remaining five years annually, thirteen numbers in all being issued; this journal, Mr. Hart remarks, "contained besides solutions of problems many important and valuable essays on the various branches of exact science, and was the best mathematical serial that had as yet appeared." The next periodical was the *Mathematical Miscellany*, which lasted from 1836 to 1839; it had a junior and senior department, the former for young students and the latter for mathematicians; eight numbers were issued. In 1842 the first number appeared of the *Cambridge Miscellany of Mathematics, Physics, and Astronomy*, edited by Professors Benjamin Peirce and Joseph Lovering, but only four quarterly numbers were issued.

In October, 1858, Mr. J. D. Runkle published the first number of the *Mathematical Monthly*, which is by far the best known of the journals which appeared previously to

those now in existence; it contained papers not exceeding eight pages in length, notes and queries, and five problems in each number intended for students, with solutions in a subsequent number. This journal, which seemed to be filling a want, unfortunately had to be discontinued in 1861 in consequence of the war. No further attempt was made to establish a mathematical journal till January, 1874, when Dr. J. E. Hendricks established the *Analyst*, which for the first year was issued monthly and has since appeared bi-monthly. This journal, in spite of many serious disadvantages due to difficulties of printing, &c., has done good service to mathematics in America. It is not to be compared to the *American Journal* as regards the importance of its papers, and a considerable portion of each number is devoted to problems; but the editor may fairly claim to have done for the encouragement of the science not less than have the editors of the *Journal*, to which the *Analyst* may now be regarded as a valuable supplement.

Soon after the foundation of the Johns Hopkins University, the *American Journal* was issued (in 1878) under its auspices, with Prof. Sylvester as chief editor and Mr. W. E. Story as acting editor, assisted by Professors Benjamin Peirce, Simon Newcomb, and H. A. Rowland. The contents of the journal have been worthy of the reputation of the editors, and as regards printing, &c., there is nothing to be desired. Among the papers may be noticed, besides the numerous and important investigations of Prof. Sylvester himself, those by Mr. G. W. Hill on the lunar theory, by Mr. G. B. Halstead on the bibliography of hyperspace and non-Euclidean geometry, and by Mr. Story on the elastic potential of a crystal. There are also contributions from Prof. Newcomb, Prof. W. W. Johnson, Mr. C. S. Peirce, &c., and from European mathematicians, Professors Cayley, Clifford, Lipschitz, &c.

It will be generally admitted that Prof. Sylvester's researches are amongst the most valuable contained in the *Journal*; one of the most elaborate of these, which occupies 60 pages, relates to an application of the new atomic theory to the graphical representation of the invariants and covariants of binary quantics. Most of the others also have reference to invariants or covariants or cognate branches of the modern higher algebra, and the great amount of space devoted to this important subject is very noticeable. There is a paper by Prof. Cayley on the calculation of the minimum numerical generating function of the binary seventhic, and Prof. Sylvester is now publishing his valuable tables of the generating functions and groundforms for binary quantics and systems of binary quantics, which he has calculated with the assistance of his pupil, Mr. F. Franklin.

There are other well-known American mathematicians, Asaph Hall, Artemas Martin, E. B. Seitz, C. H. Kummell, &c., who do not as yet appear to have contributed to the *Journal*, although their names are familiar to readers of the *Analyst*, and when these are added to the already considerable number of American authors of papers in the *Journal*, it is clear that the mathematicians in America are sufficiently numerous to support permanently such a journal as that over which Prof. Sylvester presides. The *American Journal* has started well, and there is no reason to suppose that it has not as great a

future before it as awaited *Crelle's Journal* half a century ago.

The only method of "endowing the research" of the pure mathematician is to give him a journal, and this the Johns Hopkins University has done for America. Two years ago it seemed a question whether it was worth while to apply to the Cambridge Commissioners to endow mathematics in a similar manner in England. On the whole it seemed better not to make such an application, as the obvious difficulties in the way of the editorship, &c., of a subsidised journal would be considerable, and the existing journals, which support themselves, seem to fairly meet the demand. But for the foundation of the London Mathematical Society in 1865 the want of a large mathematical journal would have become pressing; as it is, the *Proceedings* of this Society may now be regarded as taking the place of a leading English journal. The journal, however, has two important advantages over the publications of a society: (1) the printing of the papers is unaccompanied by the formalities of reading, being reported on by referees, &c.; (2) the journal is much the more procurable, especially if separate numbers be required; it also affords more rapid publication.

J. W. L. GLAISHER

OUR BOOK SHELF

*Six Life Studies of Famous Women.* By M. Betham Edwards. (London: Griffith and Farran, 1880.)

THIS is a readable and instructive collection of studies, containing, among others, notices of two women notable in their different ways in the history of science—Caroline Herschel and Alexandrine Tinné, the famous African explorer. The studies are marked by care and neatness, and are on the whole fair estimates of the work and life of the subjects. They are accompanied by six well-executed steel portraits.

LETTERS TO THE EDITOR

[The Editor does not hold himself responsible for opinions expressed by his correspondents. Neither can he undertake to return, or to correspond with the writers of, rejected manuscripts. No notice is taken of anonymous communications.]

[The Editor urgently requests correspondents to keep their letters as short as possible. The pressure on his space is so great that it is impossible otherwise to ensure the appearance even of communications containing interesting and novel facts.]

Lord Rosse's Telescope.

IN an article in the *Times* newspaper there occurs the passage—"With regard to the mighty mirror of the Parsonstown reflector M. Struve has spoken in no very complimentary terms. It was said of Sir W. Herschel's four-feet reflector that it 'bunched a star into a cocked hat;' but even this is scarcely less satisfactory than M. Struve's remark that at Parsonstown 'they showed me something which they said was Saturn, and I believed them.'" This revival of the statement attributed by Mr. Proctor in *Fraser's Magazine* for December, 1869, to "a distinguishing (*sic*) astronomer," has called forth the appended letter from the Imperial Astronomer of Russia. It is satisfactory to receive direct from M. Struve a statement of his experience of the performance of the six-foot instrument.

ROSSE

25, Chesham Place, S.W., May 26, 1880.

"MY DEAR LORD ROSSE.—Yesterday evening a friend conveyed to me a note, inserted in the *Times* of April 3, under the title 'Three Giant Telescopes,' in which I am told of having expressed myself in a very uncourteous manner on the optical qualities of the great reflector constructed by your late father. I beg leave to say that those expressions are altogether invented

by the anonymous author of the note, or, at least, quite a voluntary and thoroughly wrong interpretation of what I may have said. I am sorry my name is abused in such a manner by people who probably have a design of their own in depreciating the performances of the instrument, the construction of which marked in itself a high progress in optics and mechanics, and which in its space-penetrating power has not had any rival until now, though certainly with regard to definition (particularity when the mirror is considerably out of horizontal position) there are other instruments superior to it.

"OTTO STRUVE

"Pulkova, April 14"

Brain Dynamics

IN his clearly-written letter on this subject Mr. Tolver Preston seems to think that the reconciliation which he offers between Free Will and Necessity is a novel one. In this, however, he is mistaken, as the supposed reconciliation was very distinctly stated by the late Prof. Clifford in his lecture at St. George's Hall on "Body and Mind." But of more importance than the novelty of the reconciliation is the question as to its validity, and it is on this question that I shall make a few remarks.

The suggested reconciliation is as follows:—No upholder of Free Will can desire to maintain that a man may act, or desire and will to act, otherwise than in conformity with his character; for to maintain this would be to maintain that a man may act at random, without reference to any fixed principles of action, and that the Will is free only in the sense of being erratic. But if it is admitted that by freedom of the Will is meant freedom to choose within the lines laid down by previous character, and freedom, therefore, to shape future character by present volitions, it follows that upholders of the Free Will doctrine ought not to quarrel with those who uphold the doctrine of Necessity as due to "brain dynamics"; for the latter doctrine supplies the very basis which the former doctrine requires. It shows *why* the Will always acts in accordance with previous character; it shows that the Will can never be free in the sense of being lawless, or not determined by adequate causes; and it shows that the Will must be free in the sense of being able to choose between motives supplied by the structure of pre-formed character. Thus, it is represented, believer in Free Will ought to welcome modern physiology with all its "materialistic" deductions from "brain dynamics" to mental changes. For, unless these persons desire to land themselves in that quagmire of hopeless nonsense—the conclusion that volitions are uncaused—they have no alternative but to conclude that volitions are determined by motives, which are themselves determined by previous character. But if once volitions are thus conceded to enter the stream of causation, the more rigid the causation, the better for such freedom as remains, seeing that the latter, if always strictly determined, can never be lawless or erratic. Now of all things rigid, that which is least open to any suspicion of laxity is physical causation. Consequently, if the Determinism of Psychology admits of being resolved into the Neurality of Physiology, believers in the Freedom of the Will ought to re-peacefully satisfied that while they are free to act within the limits prescribed by their own characters, they have the sure and certain guarantee of physical causation that their volitions can never break out into activity at random. Or, as Mr. Tolver Preston puts it: "Solely in virtue of the fact that there is strict Causal Sequence in nature are the actions brought into strict conformity with individual brain structures (or with character). If the principles of dynamics were not rigid, or if the laws of nature were liable to alteration, a man's actions might sometimes be in harmony with his brain structure [character], sometimes in discord with it; or any number of persons, though possessing totally different brain-structures [characters], might act identically. The questionable expediency of the proceedings of those who are disposed to grumble at what they term the 'iron' law of nature becomes apparent here."

Such, I think, is a full statement of the suggested reconciliation. I shall now proceed to show that as a reconciliation it is utterly futile.

There is nothing to be said against the reasoning as far as it goes; but it is curious, if not unsatisfactory, that both Prof. Clifford and Mr. Preston should have performed their little play without letting us know that the Prince of Denmark has been omitted. His name in this case is Responsibility. No doubt it is perfectly true that the suggested reconciliation shows to all believers in Free Will that their belief ought only to include freedom "as freedom to act in accordance with" character:

that "such freedom actually exists;" and that "the very condition for its existence is seen to be the prevalence of that strict causal sequence in nature demanded by the Necessitarians." But although the suggested reconciliation shows all this, it fails to extend to the upholders of Free Will the relief which they most require, for the procuring of which their doctrine was conceived, and for the continuance of which their doctrine is continued, notwithstanding the manifest and manifold absurdities which it involves. That the supposed reconciliation here fails, seems almost too obvious to require showing. The more certainly it can be proved that every volition is the result of definite causes, and therefore that the character—even in that part of it which is formed by all previous volition—is also the result of definite cause, the less possibility is there of justifying the sense of Responsibility.

Unless it can be shown that a man is responsible for the character of his character it is non-sense to speak of him as responsible for his actions, when the actions are determined by his volitions, which, in turn, are determined by his character. Can it, then, be shown that a man is responsible for the character of his character? Obviously not, either upon Clifford's view or any other. It is futile to speak of a man as "the architect of his own character"; for, according to the hypothesis before us, he is nothing of the kind: his character has been built up stage by stage, first by hereditary transmission, next by numberless unintentional influences acting both from within and from without, and lastly by numberless acts of volition, every one of which was strictly determined by causes, and therefore was what it was by way of inevitable necessity. It follows, therefore, that the supposed reconciliation between Free Will and Necessity tends rather to emphasise than to diminish the difficulty; it shows more clearly than ever that the sense of Responsibility, and the correlative sense of Praise or Blame, are alike incapable of any logical justification. No doubt the sense of Responsibility, the love of Praise, and the dread of Blame act as powerful motives to volition; but this fact clearly does not justify either the feeling of responsibility in him who acts, or the feeling of approval or disapproval in him who observes.

But it is of importance also to see that it is quite as impossible to justify these feelings by the doctrine of Free Will as it is by the doctrine of Necessity. For if volitions are uncaused, or but partly and irregularly caused, it is clear that neither moral responsibility, nor praise, nor blame can attach to the unfortunate man whose actions are not guided even by the hand of Providence, but occur by way of inexplicable caprice.

What, then, it cannot but be asked, is the psychological explanation of these deeply-rooted feelings of Responsibility, Praise, and Blame, which can never be eradicated by any evidence of their irrationality? To me it appears the only answer is that these feelings have been gradually formed as instincts, which, while undoubtedly of much benefit to the race, are destitute of any rational justification. GEORGE J. ROMANES

### The Inevitable Test for Aurora

IN NATURE, vol. xxii. p. 33, is an implication, if not also a declaration, that the limits of height in the atmosphere, at which the *Aurora Borealis* both can, and cannot, appear, have been ascertained by those world-respected scientists, Messrs. Warren De La Rue and Hugo W. Muller, F.R.S.S. both. The skill of their experiment, the sufficiency of their exhausting apparatus, and the power of their unequalled chloride of silver battery are beyond all question; and they did, without doubt, ascertain in a very complete manner at what particular degrees of rarefaction of certain glass vessels, their electric discharges therein, took such and such appearances.

But what proof do they give that these appearances were aurora?

They mention carmine-coloured discharges in the denser air, salmon-coloured in more rarefied, and pale milky white in the highest rarefaction of all. But those colours, as judged of merely by the eye, are little proof in themselves of the presence of one and one only out of a number, of different things, elements, or manifestations somewhat similarly coloured. So that although I would not presume to be too confident of the sufficiency of the test I am about to set before those eminent men, still, as I was obliged to have the honour of presenting it to that admirable electric philosopher, M. Gaston de Planté, of Paris, three years ago, when he described with his equally wondrous collection of "secondary" galvanic-battery pots and

currents of terrific intensity, the *aurora-like* effects it produced—impartial justice demands the same test to be presented now to our best physicists on the west of the British Channel.

Now the test is simply this: did the F.R.S.S. gentlemen see in their electric lights the late M. Angstrom's one citron line of aurora?—that line being so invaluable an indication of aurora's presence, though hitherto uninterpreted (see Rand Capron's laborious book of *Aurora*!); and without which strange linear hieroglyph written from Creation most legibly on its forehead, no aurora has ever yet been seen by mortal man properly equipped for the occasion. And, inasmuch as the learned F.R.S.S. speak of so many variations of red—as carmine, rose, and salmon colours of various kind—while I had the opportunity of calling attention in NATURE in 1872 to the remarkable fact that *mauve* all the violent variations of auroral red to the eye on that occasion, there was only one and the same red line in the spectroscope through every one of them—did the London scientists see that unique red auroral line manifesting itself through all their various artificial reddish tints; or, had each tint a line or lines peculiar to itself; or was there no red line whatever to be seen, though they looked for it never so earnestly; or is that crucial part of their experiment described elsewhere than in NATURE, vol. xxii. p. 33?

PIAZZI SMYTH

15, Royal Terrace, Edinburgh, May 17

### Variability of 60 Cancri

I FOUND the above to be a red star in 1874, and the Rev. Mr. Webb, in the same year, made independently a similar observation. It appeared to me of 8 magnitude, as it did also to Mr. Webb. It is numbered 212 in my *Red Star Catalogue*, where, considering Argelander's previous estimate of about 6 mag., I remarked that it might be variable. This appears now certain, as on April 27 of the present year, and again on May 17, I found the star to be 5 mag. and red-orange in colour. Dr. Copeland, of Dunecht, replying to a letter on the subject, informs me that on referring to various authorities, he finds estimates of the star's magnitude from 5 by Lalande to 7 by Bessel, and in W. B. it is marked 8. As I have seen it in both extremes, the recorded differences cannot be ascribed to inaccuracies in different observers, and I must regard the star as a remarkable variable well worth special notice. It is now passing away from us, but I saw it so late as May 17 in very bright twilight, and its proximity to *Alpha* gives facilities for estimations of colour and magnitude.

Millbrook, Tuam, May 21

JOHN BIRMINGHAM

### Notes of the Cuckoo

I REMARK that all the cuckoos here intone in a minor key, except one, who alone does not flatten the 3rd of the tonic. The key is in all cases precisely D of concert pitch, as proved by a tuning-fork, and the first note is F on the fifth line. In quality of voice *the Major* is not equal to the others, while he affects a certain jerkiness of style that in no small degree deteriorates his performance. It also wants the plaintive effect of the minor key. I confess I am not very learned in these matters, and a major cuckoo may not be so rare a bird on the earth after all; but I do not recollect ever having noticed one before. All the other cuckoos that I have remarked were *minors*, and, whatever may be the reason of the distinction, I cannot, at least, regard it as connected with difference of sex.

Some years ago I wrote to NATURE concerning a cuckoo who used to surprise me with a third note interposed between the median and the key-note.

JOHN BIRMINGHAM

Millbrook, Tuam, May 21

### Fall of Dust

EXTRACT from a letter to Sir D. C. Bricie, dated May 1:—

*Campagny, Montfeld, Mustapha Supérieur, Alger*

I WRITE to-day just to enclose you some curious red dust which fell all over Algiers last Saturday (April 24), the air quite still, and sky of a curious orange colour, everything looking as though seen through a yellow glass. The next morning this powder was swept up in large quantities in our court, all the flat roofs being also covered, and the flowers quite spoiled. It fell again the two following days, but rain followed and turned it

"Aurora and their Spectra," by J. Rand Capron, F.R.A.S. (London: E. and F. Spon, 46, Charing Cross, 1879)

into mud, which stained our whitewashed walls a reddish brown. I see that it fell in Sicily on March 29 and 30. . . . It is quite a different colour from the dust the sirocco occasionally brings us.

**Monkeys in the West Indies**

YOU have recently had communications in NATURE (vol. xxi. p. 131 and 371) from two gentlemen residing in the Island of Dominica, in the West Indies, Messrs. Edmund Watt and John Imray, on the incorrectness of Prof. Mivart's statement, in his paper on "Tails," regarding the non-existence of monkeys in these islands.

These gentlemen are quite as much in error as Prof. Mivart in asserting that the only islands where monkeys are to be found are St. Christopher and Nevis, and Mr. Imray especially, who says, "It certainly appears remarkable that no species of monkey should exist in the wild state in any of these islands along the whole range from Grenada to Jamaica," with the exception of the two already named.

Not only are there monkeys in the Island of Grenada, but they exist in large numbers, and enjoy all the wildness that the deep forests of the mountains secure to them.

Riding across the country over the mountain ridges, these animals are frequently to be seen skipping amongst the branches of the surrounding trees, and they have often been shot by sportsmen who have ventured into the "high woods."

Exciting *rencontres* have been met with by those who have gone in pursuit of the monkeys. When one is shot at it sets up a "houp, houp," that, like the whistle of Roderick Dhu,—

". . . garrisons the glen,  
As if the yawning hill to heaven  
A subterraneous host had given,"

and from all sides you are pelted with nuts and seeds and boughs gathered from the trees by the offended tribe. Should you succeed in maiming or killing one of them, the survivors assume so threatening an attitude that, being as a rule singlehanded, you are quite content to retire from the scene of the contest, consoling yourself with the reflection that discretion is the better part of valour.

It is even difficult to secure the skin of one of these animals, for if there are numbers present, when one is shot the others bear away their injured brother beyond your reach.

It can therefore be readily understood how difficult it is to obtain one alive. Not long ago, however, I thought I had secured a prize. One of these "natives" was brought into the town for sale. He was such a handsome fellow, and looked so interesting, that I determined to purchase him. What I was particularly struck with was his being so tame, as he allowed me, without moving a muscle, to place my hand upon his head and about his face. Having been called away for an instant, I missed my opportunity, as he was taken by another gentleman who had come up in my absence. That same evening I saw him again, and on a closer examination I discovered the cause of his docility. He was blind! That was the reason he had been caught so easily.

It is not at all to be wondered at that neither Rochefort, Du Tertse, nor La Bat, the three earliest writers on these islands quoted by Mr. Imray, mention the existence of monkeys in Grenada. They had no opportunities of knowing it. La Bat alone travelled about the island a little, but this was only on our western coast, and the Caribs, who might have informed them on this subject and on many others, had been most carefully exterminated by their countrymen.

D. G. G.

Grenada, April 27

IN a letter that appeared in NATURE, vol. xxi. p. 371, on "Monkeys in the West Indies," I observed that it seemed remarkable "that no species of monkey should exist in the wild state in any of the West India Islands along the whole range from Grenada to Jamaica," &c. Since writing the above I have discovered that monkeys are abundant in Grenada in the wild state, and that they are very destructive to the growing crops. Mr. Watt (now at Cape Coast Castle), who took exception to Prof. Mivart's statement in regard to the existence of monkeys in the West Indies, called my attention also to this fact.

Have these Grenada apes been introduced, or are they indigenous? is the question, if indeed it be a question. The historic evidence points, I think, conclusively to their introduction, though I have not been able to ascertain the when and the how,

as in the case of St. Kitts. The two old French authors quoted in my former letter—Rochefort, 1665, and Du Tertse, 1667—enumerate the mammalia at that time existing in the Antilles as known to them, and Du Tertse was well acquainted with Grenada; but no species of ape is amongst the number.

A letter from Mr. Sclater in NATURE, vol. xx. p. 153, proved that the St. Kitts Monkeys were referable to the green monkey (*Cercopithecus callitrichus*, Geoffr.) of Western Africa. Can Mr. Sclater or any of your readers give similar information regarding the species of the Grenada ape?

I have been informed that apes are also to be found wild in Montserrat.

Sir Robert Schomburgk, in his "History of Barbados," says, with reference to the *Quadrumana*: "The most interesting [of the mammalia] is the Barbados monkey, now nearly extinct, although formerly so frequent that the Legislature set a price upon its head. I have much to regret, on account of natural history, that my endeavours to procure a specimen for the purpose of determining the species have entirely failed. From the outer appearance of a living specimen I consider it to be *Cepus* [*Cebus*?] *capucinus*, Geoffr., the Say, or Weeper, or a very closely-allied species. It is not likely that it was introduced, as the first settlers found it in large numbers on their arrival."

Prof. St. George Mivart, who stands in the foremost rank as an authority on all such matters, in an article on "The Geography of Living Creatures," in the *Contemporary Review* for February last, makes the following remarks:—"The West Indian Islands, again, are admirably suited for such creatures as apes, yet none are indigenous to that region, though they rapidly increase when they have been introduced." He says in a note: "Trinidad is really a detached part of the continent of South America."

As all the historic facts go to prove that no species of the *Quadrumana* existed in the Lesser Antilles when first settled, it certainly does appear much more probable that the apes stated to have been found in Barbados by the first settlers had been introduced from Trinidad or the South American continent than that they existed as native to the island.

JOHN IMRAY

Dominica, April 24

**The Recent Volcanic Eruption in Dominica**

I AM indebted to Mr. Thomas Raine, of the Colonial Bank, Barbados, for the following analysis of the volcanic dust which fell in Roseau—the capital of that island—and the surrounding country during the eruption from the crater of the "Boiling Lake" on January 11 in the present year. The analysis was made in the Analytical Laboratory, Barbados, on January 19, by Mr. George Hughes, formerly senior assistant to Dr. A. Voelker, F.R.S., the sample of volcanic dust having been collected during the eruption and forwarded immediately afterwards to Barbados. Mr. Hughes thinks that the dust "has not been exposed directly to the action of fire to any extent, or the percentage of oxide of iron would have been higher and the pyrites less—oxide of iron being one of the products from the combustion of pyrites."

Alumina	...	...	...	...	...	64
Moisture	...	...	...	...	...	3.26
Oxide of iron	...	...	...	...	...	45
Sulphate of iron	...	...	...	...	...	14.46
Sulphate of lime	...	...	...	...	...	1.42
Carbonate of lime	...	...	...	...	...	39
Magnesia	...	...	...	...	...	32
Alkaline salts, loss in analysis, &c.	...	...	...	...	...	47
Insoluble siliceous matters	...	...	...	...	...	78.59

100.00

EDMUND WATT

Government House, Cape Coast, West Africa, April 23

**Cup Stones, Cup-Marked Stones, or Cups and Rings**

THE interesting paper on "A Scottish Crannog" in NATURE, vol. xxii. p. 13, is illustrated on p. 16 by an engraving (Fig. 3) which exactly represents the "Cups and Rings" that have long excited the curiosity of anthropologists on Rombald's Moor, near Ilkley, West Yorkshire. These markings, which I have examined within the past week, are on detached flatish rocks of millstone grit, immediately to the south-west of the village of Ilkley, and near to what are known as the Panorama Rocks.

On one piece of rock there are at least thirteen of the markings visible, and the rings or grooves round the central depression vary in numbers from one to six. Mr. Joseph Lund, of Overdale, Ilkley, who most politely guided me to the stones in question, also showed me, in his own garden, a large block of grit, bearing some of these markings, from each of which is a district channel cut to the edge of the rock. There have been many theories as to the significance of these markings. Has their use been yet ascertained?

R. MORTON MIDDLETON, Jun.

West Hartlepool, May 15

### A Double Egg

THE other day on opening an egg, certainly a fine one, I found inside another perfect egg, so far as shell and the white part are concerned, but with only a faint streak of yellow for yolk. Double yolks are common, but I never saw, or read of, a perfectly formed shell inside an ordinary one before. If you think it worth notice, I send it for that purpose. T. ALLWOOD  
Stafford, May 14

## COMPARATIVE ANATOMY OF MAN<sup>1</sup>

### II.

WITH regard to the cranial characters of the Americans the same difference of statement is met with as in respect to their external appearance. Morton's assertion of the general sameness in the skulls from all parts of the continent has been contested by others. But the controversies relating to this subject have nearly all turned upon one character alone, that is, the relative breadth of the cranium compared to its length, to the neglect of many others probably of equal importance. The prevalence of artificial cranial deformity, spoken of in a previous lecture, causes some difficulty by limiting the number of crania possessing their natural form at our disposal; but still there is sufficient evidence to show great variation in the cephalic index of American skulls. Although such extreme dolichocephaly as is met with among the Eskimo is very rare among true Americans, the larger number of crania of Indians, excepting those inhabiting the west coast of North America, and the region west of the Andes in South America (Peru and Bolivia), as well as Patagonia, in all of which regions brachycephaly prevails, are either mesocephalic or moderately dolichocephalic. But the two forms are curiously intermixed, or at all events found in different tribes inhabiting contiguous regions, much, in fact, as they are in Europe. As the inhabitants of the two extreme ends of the continent, the Eskimo and the Fuegians, are both dolichocephalic (though in the case of the latter the evidence of cranial form is not yet so complete as might be wished), and as certain skulls, apparently of great antiquity, which have been discovered in Patagonia and Brazil are of the same form, it has been conjectured that the primitive inhabitants of the continent were a race with long and narrow heads, and that the brachycephalic race are later intruders.

The characters of the skeleton of the face exhibit, as is so often the case, greater uniformity than those of the cranium proper. The frontal region is almost universally low and retreating, and the supraciliary ridges generally well developed in the males. This and the form of the nose distinguish them from the majority of Asiatic Mongols. Nasal bones, compressed laterally, hollowed near their upper end, and forming a salient projection forwards at the lower end, giving the characteristic high bridge to the nose of the living face, are found in the great majority of American skulls from all parts of the continent. The tendency to a narrow form of nasal aperture (so very marked in the Eskimo) prevails throughout the American continent, the average index of 123 specimens being 47.2, which is

<sup>1</sup> Abstract Report of Prof. Flower's lectures at the Royal College of Surgeons, March 1 to March 19, on the Comparative Anatomy of Man. Continued from p. 61.

almost as low as that of Europeans, while a really platyrrhine nose, such as is the rule among negroes and Australians, is rarely, if ever, met with. The form of the orbit is also characteristic, being almost invariably large, round, and high, having an average index in 129 examples of 91.5. In the artificially-flattened heads this index is greatly increased, as the depression of the forehead drags the superior margin of the orbit upwards, often so much as to cause the vertical height to exceed the horizontal diameter. The malar bones are always full, and project laterally, and the nasi-malar angle, though somewhat diminished by the saliency of the nose, approaches to that characteristic of the Mongolian races. In the projection of the jaws forwards the skeleton of the face holds an intermediate position between the orthognathous white and the prognathous black races, in a great many cases inclining towards the latter. The lower jaw is large and the chin fairly prominent; the teeth are of moderate size and vertically implanted. Morton found the average cranial capacity of 155 ancient Peruvian skulls to be as low as 75 cubic inches, less than that of almost any other known race. It has been thought that some error may have crept into his method of measurement, but his estimate is probably not far wrong, as the average of 47 male skulls in the College collection is 1,345 cubic centimetres, or 82 inches, and of 50 females, 1,194 c.c., or 73 inches, giving a mean for both sexes of 77 cubic inches. On the other hand the barbarous tribes of Indians of both North and South America gave, in Morton's hands, an average capacity (for both sexes) of 84 cubic inches, and the Chinooks, from the mouth of the Columbia River, have remarkably capacious skulls, the average of 7 males in the College being 1,589 c.c. (97 inches), larger than those of any other race, but these may be rather exceptional specimens. It is, however, perfectly certain that the crania of the comparatively civilised Peruvians were much smaller than those of either the Indians of the North-West, or the Patagonians, or even Fuegians; but, as Morton remarks, the former, living under a thoroughly organised paternal despotism, seem neither to have thought nor acted except at the dictation of a master, while the brain of the savage was always in a state of activity to provide against the necessities and dangers of his daily life. But it must be recollected that the stature of the Peruvians was much less than that of the hunting tribes, and it is also possible that the difference may depend partly upon some general law connecting the size of the brain with the prevailing temperature, as inhabitants of cold regions have usually a larger brain capacity than those who dwell within the tropics.

The general characters of the American cranium are thus rather negative than positive, but on comparing it with the cranium of other races, it will be seen that it has no affinity whatever with that of any of the negroid people, Australians, Melanesians, or true negroes. From these it differs in every essential character, but with the Mongolian cranium it presents many affinities, especially in the form of the orbit, the narrowness of the nose, and the great size and forward projection of the malar bones. It is by the latter character especially that it differs from the European cranium. The prominence of the nasal bones is sometimes the only distinction to be found between American and North Asiatic skulls. Although Mongolian in the general type of face, it never presents such an extreme exaggeration of that type as is to be seen in the Eskimo, from which it can always be readily distinguished. The best argument for the unity of the American race (using the word in a broad sense) is the great difficulty of forming any natural divisions founded upon physical characters. Although certain special modifications prevail in different districts, and the Mongolian resemblance is greatest on the north-western coast, the same form constantly reappears at widely separated parts of the continent. Skulls from Vancouver's Island, from Peru,

and from Patagonia, can be shown which are almost undistinguishable from one another, but the materials at hand, at all events in European collections, are not yet sufficient for following out this interesting investigation to a satisfactory conclusion.

*Races of Africa.*—Of the great primary divisions of the human species no one is more distinctly characterised than the Negroid race, if under this term we include the whole of the dark-coloured, frizzly-haired people who inhabit considerable portions of the equatorial region of the so-called Old World, from the West Coast of Africa eastward to the middle of the Pacific. The oceanic branches of the group are not at present under consideration, but only those which inhabit the continent of Africa. The physical features of the Ethiopian negroes have remained unchanged since the earliest historic period, as they are depicted in ancient Egyptian drawings much as we see them now, but geographical and geological considerations tend to indicate a much vaster antiquity for the race. The present northern limit of the negro population of Africa, extending from the River Senegal on the west across the continent in a nearly due easterly direction, corresponds with the Ethiopian region of zoologists, characterised by a fauna altogether different from that of the more northern parts of the continent. The cause of this difference is accounted for by the undoubted fact that at a comparatively recent geological epoch the Sahara was covered with sea, and the portion of Africa lying to the south of it was isolated from the great continental track composed of Europe, North Africa, and Asia. The distribution of the races of man so closely coincides with that of the remainder of the fauna that it is natural to suppose that it must arise from the same cause, and we may thus attribute to the long separation of the races north and south of the Sahara, during the period in which the waters of the Atlantic flowed over it, their strongly opposed physical characteristics. Since the two races have come in contact by the drying up of these waters much intermingling has taken place along the frontier line, but, considering the immense period of this stage of their existence, it is remarkable how little the original geographical boundary has been shifted.

The physical characters of the negro, in his most typical form, as found in the equatorial regions of Africa, have attracted much attention from anatomical anthropologists. In discussing the possible range of differences between different members of the human species the African negro has, on account of his structure being better known than that of any other of the lower races, always been taken as the antithesis of the white man of Europe, and in numerous treatises on the subject the differences between them have often been either exaggerated or softened down, according to the bias of the writer. The black colour of the skin of the negro, due to an increased number of pigment granules in the cells of the epidermis, is proverbial, but very few negroes, if any, are really black. The Jollofs of Senegambia are described as being "jet black," or even "blue black," but various shades of brown, or even yellow, are more common. The iris is dark brown and the conjunctiva yellowish. The hair is always black, except in the not unfrequent case of albinism. Its peculiar character, its flattened elliptical section, and tendency to assume very close spiral coils, giving the general effect commonly called "woolly," or more properly "frizzly," are well known. The division of the negro races into two distinct groups, those in which the hair grows evenly scattered over the scalp (*eriacomi*) and those in which it grows in distinct tufts, with bare intervals between (*lophocomi*), though often demonstrated to have been based upon fallacious observations, holds its ground with great tenacity, and is still adopted in most treatises on anthropology. The report of a committee of the Paris Anthropological Society on the growth of the hair of a negro in one of the hospitals

of that city, published last year in the *Bulletin* of the Society, ought to set the question at rest for ever.

The features of the negro are so well known as scarcely to need description. Their chief characteristics are, a narrow but rather vertical forehead, small but rather prominent eyes, full cheek bones (intermediate between those of European and Mongolian), flat broad nose, prognathous mouth, with very full and everted lips, often projecting beyond the level of the nose, large white teeth, and a small chin. In stature there is considerable variation, some tribes being equal or even above the average of Europeans, others much smaller, and there is some evidence of the existence of a true race of pygmy negroes in the interior of Africa. Two thousand black soldiers of African descent in the United States of America, carefully measured during the war, gave an average of 66.21 inches, or nearly one inch below the average of whites (67.15). The difference in the proportions of the different parts of the body in different races have received much attention from anatomists, and comparison between the negro and the standard European is more completely elaborated than that between any other races; but owing to the paucity of skeletons, on which alone perfect accuracy of measurement can be obtained, much still remains to be done. As regards the length of the clavicle, Broca and Pasteau find that this bone is slightly longer in the negro than in the European, that is as compared with the humerus; but the comparison is not a satisfactory one, the latter bone being, as will be shown, peculiarly short. Compared with the femur, which is a better standard, as its proportionate size to the height is nearly the same in the two races, the clavicle (as far as the materials available permit the comparison) appears to be shorter than in the European, as was shown last year to be the case with the Andaman Islanders. The differences in the form of the scapula have been fully described by Broca and Livon of Paris. All observers agree that the arms of the negro are longer in proportion to the height than are those of Europeans. This is illustrated by the measurements taken in the American war, which show that when standing upright the mean distance between the tips of the fingers and the upper end of the patella was 2.88 inches in the negro, and as much as 5 inches in the white. The legs are also longer in proportion to the height, though to a less extent. The arms, compared to the legs, are slightly shorter than in Europeans. This is caused by the shortness of the humerus, its length as compared with the femur being as 69 to 100 in the negro and 73 to 100 in the European. The radius is longer even as compared with the femur or with the height, and *à fortiori* as compared with the humerus. The humero-radial index is therefore one of the most characteristic distinctions between the two races. In Europeans it averages 74 (the humerus being 100), in negroes 80. The femoro-tibial index presents a similar but less striking difference, being in Europeans 82, in negroes 85. Some of these characters, as the humero-radial index, approximate the proportions of the negro to those of lower forms, but others, as the shortness of the humerus and the greater length of the lower limbs as compared with the height, do not do so, and only present signs of divergence from the European standard, but not of inferiority. The other black races agree generally with the typical African negro in such proportions as he differs from the European, and hence these might be used as valuable distinctive characters in the classification of man; but difficulties arise when the negro is compared, not only with the European, but with other races generally held to be distinct. Although very few of them have been measured in sufficient numbers to give reliable averages, the indications already obtained show that in many points the proportions, though they may distinguish the negro from the European, do not separate him from others, which in many respects are most dissimilar. In the humero-radial index, for instance, the Peruvian and

the Malay (judging by the skeletons in the College Museum) agree with the negro rather than with some other branches of the so-called Mongoloid races, as the Eskimo and the Samoyede. But this is a subject for further observation rather than hasty generalisation.

The difference between the pelvis of the African negro and that of the European has been pointed out by Vrolik and others. It consists mainly in the increase of the antero-posterior diameter as compared with the transverse, expressed by the pelvic index, or ratio between these diameters, the latter being taken as 100. In the European male the average index is 80, in negroes, according to various observers, from 90 to 100. As in the proportions of the limbs, many of the Mongoloid races conform in the characters of the pelvis rather with the negro than with the European.

In the cranial characters the distinctions between the negro and the white races are strongly marked. The average capacity of the cerebral cavity is undoubtedly smaller in the former, even in individuals of approximately the same height. It is, however, considerably higher than in the Australian. The difference between the average capacity of English and negro crania in the College Museum is 123 cubic centimetres, between the latter and the Australian 80 c.c. Broca's totally independent measurements of skulls at Paris give a difference in the former case (Parisians being substituted for English) of 128 c.c., and in the latter of 83 c.c., so that the results are substantially identical. The general form of the cranium is expressed by the cephalic or latitudinal index, or relation of breadth to length, the latter taken as 100. The average index of forty-two negroes of various tribes in the College Museum is 73.6. Of these more than half are between 70 and 75, or dolichocephalic; less than half are above 75, or mesocephalic; but very few are either below 70 or above 80. The average index of eighty-five negroes from the West Coast of Africa, measured by Broca, is 73.4, and of fifty-three from East Africa, measured by Lederle, is 73.9. These remarkable agreements with our own measurements show that between 73 and 74 may be fairly taken as a general average of the cephalic index of the African negro, and that he belongs, therefore, to the moderately dolichocephalic races. The height, measured from the basion to the bregma, is almost identical with the breadth, the average of the forty-two College specimens giving 73.5. The negro skull in these proportions differs greatly from that of the Fiji Islanders previously described. Differences in the position of the foramen magnum, in the angle formed by its plane, with the horizontal of the skull, and in the various facial angles, which have been pointed out as characterising the negro skull as compared with that of the European, can only be explained by means of diagrams. The facial characters are generally eminently characteristic. The forehead, though narrow, is not retreating. The glabella and supra-orbital ridges are sometimes well developed, but more usually this region is smooth and flat. The orbits have a moderate index, 85.5 (Broca), or 86.3 according to measurements of the College collection. The nose is distinctively platyrrhine, the average index being 55 or 56. The nasal bones are small and flat, their external surfaces directed forwards, the two meeting in front at a very open angle, instead of a narrow one as in Europeans. The lower margin of the nasal aperture is usually rounded off instead of sharp and strongly defined. Equally characteristic is the prognathism, which is very rarely absent. The measurement from the basion to the middle of the alveolar border is greater than that from the basion to the nasofrontal suture, whereas in Europeans the reverse is almost always the case.

The teeth are regular, well developed, and generally free from caries. The third molars (wisdom teeth) appear to be always in their place before the closure of the basilar suture, whereas among Europeans they are often

much later in coming into place. The size of the teeth varies in different races, but hitherto no accurate measurements have been made to express their difference. The length of the molar series, in a straight line between the anterior edge of the first premolar and the posterior edge of the third molar, may be conveniently used to indicate the size of the teeth, and called  $d$ . This may be compared with the length of the cranio-facial axis, or basi-nasal length (BN), and a dental index formed from  $\frac{d \times 100}{BN}$ . This will give at all

events a fair approximation to the relative size of the teeth compared with the skull, as the length BN is one of the least liable to variation of any in the cranium. Unfortunately for the investigation, in a large proportion of the crania in Museums the teeth are wholly or partially lost, and a larger number of specimens must be measured than are at present available. The following indices (which must be regarded as provisional) are however of considerable interest. In the first place it must be observed that the teeth of women, though smaller absolutely, are larger relatively to the cranio-facial axis than those of men. For instance, in Europeans the dental index of males is 40.5, of females 42.0. In Australians the disproportion is greater still, being 45.7 for the males, and 48.4 for the females examined. In the following table males only will be included. Europeans 40.5, Ancient Egyptians 40.8, Hindoos 41.2, American Indians 42.5, Chinese 43.8, African Negroes 43.9, Andamanese 44.2, Fijians 45.4, Australians 45.7. It will thus be seen that in the size of the molar teeth the negroes hold an intermediate position between Europeans and Australians, but approaching nearer to the latter. The actual average length of the molar series in European males is 40.8 millimetres, in Africans 45.4, in Australians 46.7. The anthropoid apes give a higher index than that of any of the races of man.

(To be continued.)

#### ON SYSTEMATIC SUN-SPOT PERIODICITY

AT the present moment, when a good deal of attention is being directed to sun-spots and their possible influences, it may not be amiss to discuss the question of their systematic periodicity.

We have to ask ourselves whether we can by a limited application of labour so disentangle the apparently complicated and capricious phenomena of sun-spots as to exhibit certain well-defined recurring periods, the superposition of which upon each other may ultimately explain the march of these phenomena. It will be apparent that such an analysis of the past is the first and indispensable step towards any prediction for the future. I will now bring before the readers of NATURE the first results of an attempt of this kind. As the subject will be more fully discussed in another place, I will in the meantime mainly exhibit the results obtained, referring as briefly as may be to the method used in procuring them. The method is that which (in conjunction with Mr. Dodgson) I have already brought before the notice of the Solar Physics Committee and of the Royal Society. It has been applied to thirty-six years of sun-spot observations, beginning with 1832 and ending with 1867. The first portion of these has been derived from the records of Hofrath Schwabe, the second from those of Carrington, while the latter portion has been derived from De la Rue's Kew series. My first object has been to ascertain to what extent these records exhibit indications of certain systematic inequalities having periods not far differing from twenty-four days. I will limit the present communication wholly to this issue.

These thirty-six years have been split up into three series of twelve years each, and treated after the manner



TABLE I.—EXHIBITING A SUN-SPOT INEQUALITY OF PERIOD 24 022 DAYS FOR EVERY FOUR YEARS FROM 1832 TO 1867, AND ALSO FOR EVERY TWELVE YEARS

(1) Every Four Years

Table with 20 columns and 10 rows. Columns represent years from 1832 to 1867. Rows show data for every four years and every twelve years. Includes sub-headers (2) Every Twelve Years and (3) Whole Series.

TABLE II.—EXHIBITING A SUN-SPOT INEQUALITY OF PERIOD 24 329 DAYS FOR EVERY FOUR YEARS FROM 1832 TO 1867, AND ALSO FOR EVERY TWELVE YEARS

(1) Every Four Years

Table with 20 columns and 10 rows. Columns represent years from 1832 to 1867. Rows show data for every four years and every twelve years. Includes sub-headers (2) Every Twelve Years and (3) Whole Series.

which is fully described in the communications already alluded to. By this means the positions of the various inequalities around twenty-four days have been indicated on the time-scale. I have next taken two of these and attempted to eliminate from them the influence of all neighbouring inequalities, in order to see with what success it is possible to disentangle the various periods from each other. In order to test this success I have exhibited in the tables on p. 81 the result of this elimination applied to each four years of sun-spot records, and I think it will be manifest to every one that there is such evidence of repetition, that one cannot doubt the reality of the periods therein indicated. I have likewise begun to apply to these records Gen. Strachey's test, and with a good result so far as I have yet gone.

No kind of smoothing or equalisation has been applied, and the elimination has been carried on only to the first stage, so that more accurate determinations will probably result from a further application of labour.

BALFOUR STEWART

### PRIMITIVE MAN<sup>1</sup>

IT is a familiar fact that from time to time wrong-headed but enthusiastic persons appear in the scientific arena boldly challenging the truth of some one or other of the most firmly-established and essential doctrines of the scientific creed. Sometimes a clever investigator discovers that we moderns are all in the wrong, and that the sun after all goes round the earth; another will have it that the moon does not revolve on its axis; a third disputes the correctness of the theory of gravitation; whilst a fourth finds no difficulty whatever in squaring the circle. Such men have cropped up at intervals throughout the historical period. They are not without their usefulness in their generation, for they afford some little mirth, and give an opportunity sometimes to men of science to reconsider their standpoints and settle themselves more firmly upon them. It seems uncertain whether Prof. Dawson, of McGill College, Montreal, is to be classed with these malcontents, or whether his scientific heresies are to be explained as conforming to the general law that superstitions generally survive and even thrive in colonies long after they have died out in their mother country.

No greater contrast could well be conceived than is presented by the two works on Primitive Man which have just appeared, and which form the subject of the present article.

Prof. Boyd Dawkins, in accordance with the teachings set forth in his "Cave Hunting" and all other works which have proceeded from his pen, treats his subject in a thoroughly scientific and unprejudiced manner, and the results which he lays before his readers are in keeping with the conclusions now fully accepted by all anthropologists and admitted by educated persons generally. Prof. Dawson, on the other hand, has actually written a book at this present time, the object of which is to attempt to show that mankind first made its appearance on the earth not more than 6,000 or 8,000 years ago. He sums up thus:—"What evidence the future may bring forth I do not know, but that available at present points to the appearance of man with all his powers and properties in the Post-glacial age of geology, and not more than 6,000 to 8,000 years ago." His book is described as "an attempt to illustrate the characters and condition of prehistoric men in Europe by those of the American races." His arguments are old stagers long ago upset. Such, for example, as that because some savages, such as the Veddahs of Ceylon, who are degraded Singhalese, are degenerate, therefore

all savages are the degenerate offspring of highly-cultivated races. On similar grounds we might infer that because barnacles and ascidians can be shown to be degenerate animals, therefore all lower animals have undergone "degeneration," to use Prof. Ray Lankester's term, and all monkeys are degenerate men.

The main argument of the book is however apparently that derived from the results of excavations made on the site of Montreal. On this site, as we know from Cartier's narrative, stood in 1535 the native town of Hochelaga, which was fortified, as shown in the plan of the town at the end of the third volume of Ramusio's collection of Voyages and Travels, by means of a circular triple wall of wooden beams, the outer of which were inclined to meet one another at the summit. The native town, its huts and walls, naturally disappeared within a century, and all that now remains of it are the implements and bones which are to be dug out on its site, and of which Prof. Dawson gives an interesting account. There are tobacco pipes of various kinds, stone weapons, pottery, and bones of animals and men. If it had not been for Cartier's visit and published narrative antiquarians might have ascribed a very early date to these remains, argues the author, therefore in all cases where a very early date has been assigned to human remains of the palæolithic age in Europe a similar error has been committed. We cannot follow Prof. Dawson through his attempts to contort the data of modern science into accordance with Chaldean cosmogonies and mythology as familiar to us in Jewish dress. He gravely refers the remains found at the camping ground at Solutre which, according to M. de Mortillet, mark a special epoch (the Solutrian) in the palæolithic age, to the *antediluvian* epoch, and reminds us how Jabal, before the flood, according to Genesis, initiated the nomadic mode of life, suggesting that the old inhabitants of Solutre who hunted the mammoth, the cave lion and cave bear, were Jabalites. It is delightful to find how beautifully everything fits into its place when freely interpreted by Prof. Dawson. The results of his ethnographical and antiquarian researches appear to be more or less summed up in the biblical text, "God shall enlarge Japhet, and he shall dwell in the tents of Shem, and Canaan shall be his servant." This means, as he aptly explains, that the Aryan or Japetic races were to be endowed with "the higher control of the physical forces and the greater power of expansion and propagandism," in short, amongst other exploits, to exterminate the Redskins and colonise America; whilst the Semitic races were to receive historical and spiritual revelations, and Canaan in the text represents unprogressive humanity generally.

Prof. Dawson's intimate acquaintance with the details of prehistoric religion is most startling. He holds up the faith of palæolithic, or *palæocosmic*, man, as he prefers to call him, as a warning and a pattern to the degraded Ritualist, at whom he cannot help having a dig even with palæolithic weapons, being evidently a staunch Protestant. He slays evolutionists with the same thrust. It is an unexpected honour for them to die in such company. No doubt the association is meant to give the Ritualists the hardest dig. He wishes "distinctly to affirm that the prehistoric religions, and what we call heathenism or animism of untaught tribes, were nearer to God and truth than are either the ritualisms and idolatries or the materialistic scepticisms of more civilised times, when men, 'professing themselves to be wise, become fools.'" Till we read this passage it seemed to us that Prof. Dawson professed himself throughout his book to be very wise indeed, but of course he cannot have intended to pose in that attitude. The chapter concludes by calling on "all men everywhere to repent," and so we do heartily of having followed so far Prof. Dawson's, shall we call it "wisdom"?

We turn with relief to Prof. Boyd Dawkins's fine volume. It is sumptuously printed, and contains 168

<sup>1</sup> "Early Man in Britain and His Place in the Tertiary Period." By W. Boyd Dawkins, M.A., F.R.S., &c. (London: Macmillan and Co., 1880.)  
<sup>2</sup> "Fossil Men and their Modern Representatives." By J. W. Dawson, LL.D., F.R.S., &c., McGill College, Montreal. (London: Hodder and Stoughton, 1880.)

excellent illustrations, the sources of which are given in a table at the commencement of the work, a detail of importance often omitted.

The first chapter deals with the relation of geology to archæology and history, these three sciences all contributing to the building up of the account of early man in Britain. There appears to be a slip in the table showing the specialisation of mammalia in the tertiary period,

and the successive faunas and floras of preceding geological periods in Britain, the account of the miocene age is concluded with a paragraph headed "No Proof of Man in Europe in the Miocene Age." High authorities such as Dr. Hamy and M. de Mortillet have maintained that man did exist in France as early as the middle of the miocene age, basing their conclusions on the evidence given by splinters of flint found in mid-miocene strata at

Thenay by the Abbé Bourgeois, and by a notched fragment of a rib found at Pounce by M. Delauny. The author seems a little in doubt whether these flakes and notches are in reality artificial, but if they be so he prefers to conclude, with Prof. Gaudry, that they were made by the anthropomorphous apes then inhabiting France rather than by man. This appears to be a somewhat wild suggestion, and the author is evidently led to it by considerations which are set forth in the same paragraph, and which seem to him to prove that from zoological grounds man could not have existed in the miocene age, as to the cogency of which considerations we cannot at all agree with him. His argument is that because no other living species of land mammal has been met with in the miocene fauna, therefore man could not have formed an exception to this supposed rule, and "had no place in a fauna which is conspicuous by the absence of all the mammalia now associated with him." "If miocene man had existed it is incredible that he alone of all the mammalia living in these times in Europe should not have perished or have changed into some other form in the lapse of ages." The author adds: "Those who believe in the doctrine of evolution will see the full force of this argument against the presence of man in the miocene fauna not merely of Europe but of the whole world." Now we, we hope in common with all the readers of NATURE, are thorough-paced evolutionists, but we should have said rather that those who understand the doctrine of evolution would consider this argument as completely unsound. Evolution, wherever variedly manifested in its action, does not produce any comprehensive similar effect on any group of different objects on which it acts. According to the varying conditions partly surrounding, partly embodied in each object, evolution singles out certain of the objects for higher specialisation, others for degradation, others again for extinction; whilst others again it, as it were, leaves alone to survive unchanged through ages amongst hosts of modified descendants of their near relatives. The survival of some form, larval or adult,



FIG. 1.—Flint River Drift Implement, Gray's Inn Lane, {.

where the period is divided into the eocene, miocene, pleiocene, pleistocene, prehistoric, and historic stages. The latter stage is said to be characterised by living species of mammalia and no extinct species, which is rather misleading, since Steller's sea-cow is almost certainly extinct, and several other mammalia are verging on extinction.

After an interesting sketch of the physical conditions

or of some organ of great antiquity in unchanged condition, where all the concomitants have become profoundly modified, is one of the most familiar facts explained by the evolution theory. How is it else that the brachiopod *Lingula* has survived in nearly identical form to the present day from the earliest geological times, whilst all its then contemporaries are extinct or have changed? How is it else that the vertebrate structure survives in

only one or two of the degenerate Ascidians? How is it else that some savages are still in their stone age, and that Prof. Dawson still believes that mankind is only 6,000 years old?

We see no reason whatever, from evolutionary grounds, why man should not have existed in the miocene times. Anthropomorphic apes were already in those times abundant and varied, and comparative anatomy points to the progenitor of man having been an ancestor of the present existing anthropomorphs, combining many of their several characters. At the same time we do not wish to appear to assert that man did then exist, but we think it rather a pity that the author did not give good illustrations of the miocene flint flakes and the notched rib if only to show, as we believe is the case, that they

do not exhibit any very definite traces of handiwork, and has not formed a more certain judgment as to whether the objects are artificial or not.

We have dwelt upon this matter at some length, because an important question of principle is involved in which we are at variance with the author. With regard to everything else in the book we cannot but offer our best thanks to him. His extended experience in cave-hunting, his critical knowledge of geology and of the later tertiary mammalia, have long rendered him an authority of first rank on the subject of which he treats, and he has in the present volume combined with great care all available published information with the results of his own investigations. The book represents with great clearness the present state of our knowledge with regard to the antiquity of

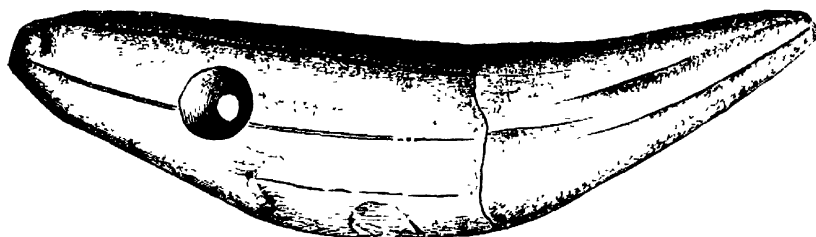

FIG. 2.—Tooth of Cave lion, Duruthy Cave, 1.

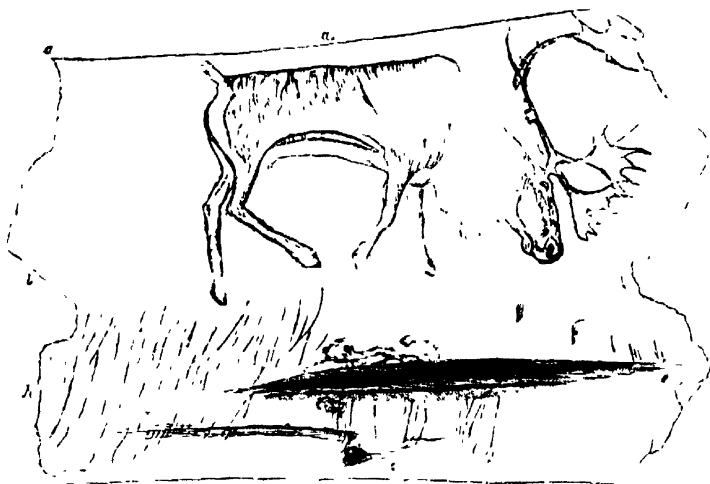

FIG. 3.—Reindeer incised on antler, Kesslerloch, 2.



FIG. 4.—Stone hatchet, Robenhausen.

man, for though it treats principally of Early Man in Britain, no details of importance with regard to discoveries bearing on the subject on the Continent or elsewhere are omitted.

The whole account is most clearly and logically arranged, and written in a very readable and entertaining style. It is popular as well as scientific.

The author considers the evidence of man in early pleistocene strata as doubtful. It is in the mid-pleistocene deposits that man first appears without any doubt, as proved by flint implements found in the lower brick-earths at Crayford by the author himself. Man was at that period associated in the Thames valley with six extinct species of mammalia, viz., three species of rhinoceros, *R. megarhinus*, *tichorhinus*, and *leptorhinus*, the mammoth and *Elephas antiquus*, and the Irish elk. Large herds of

horses, stags, and bison frequented the open country, the hippopotamus floated about lazily in the Thames, whilst the thickets were inhabited by wolves, foxes, brown and grisly bears, huge lions, hyænas, and wild boars.

We cannot here follow the author throughout his well-told story, but can only dip here and there into his work to give our readers a sample of its qualities. Most interesting is a palæolithic implement discovered in England so long ago as the year 1690. It was found with the remains of an elephant in the heart of London in the gravel at Gray's Inn Lane, and having been preserved in the Sloane collection in the British Museum for more than 150 years, was ultimately recognised by Mr. A. W. Franks as identical with those discovered so long afterwards in the gravels of Amiens and Abbeville. It belongs to the late pleistocene river deposits. The accompanying

figure of it is taken from Mr. John Evans's "Ancient Stone Implements."

The author carefully considers, as far as the evidence will permit, the question of the range of the Cave men as compared with the River-drift men. The remains of the "Cave men," who are characterised by the use of certain peculiar implements, are found throughout the whole of France, and are remarkably abundant in the caverns of the Pyrenees. They occur also in Switzerland, Germany, Belgium, and England, but are limited in range, being unknown as yet in the caves south of the Alps and Pyrenees, and north of a line passing east and west from Derbyshire through Belgium. The Cave men differed in race from the River-drift men. They were ignorant of pottery, but they had a varied assortment of implements and weapons of bone, ivory, and stone. They prized ornaments, and in the cave at Duruthy forty canine teeth of the bear and the lion were found perforated to form a necklace, "a magnificent trophy of the chase."

The Cave men were also artists, and engraved drawings of very considerable artistic merit on bones, ivory, and antlers. Their drawings of the mammoth on its own ivory are familiarly known. We reproduce here a figure of a reindeer incised on an antler from the Kesserloch, near Thaynigen.

Drawings of the great Irish elk, bisons, the ibex, and bears have also been discovered, but those of

man are extremely rare, and comparatively badly executed. Mr. John Evans is inclined to hold that the River-drift and Cave men belonged to the same age and the same race, but the author concludes that they must be referred either to two distinct races or to two sections of the same race which found their way into Europe at widely different times; the River-drift men being of far higher antiquity in Europe, and probably having lived for countless generations before the arrival of the Cave men and the appearance of higher culture. "The discoveries of the last twenty years have tended to confirm the identification of the Cave men with the Eskimos."

The account of the Cave men is followed by that of the prehistoric period, of the neolithic civilisation, the age of polished stone implements and of the prehistoric farmer and herdsman. Wild boars, the great wild ox, the urus, the Irish elk, the reindeer, the brown and grizzly bear still inhabited Britain during that period. The Irish elk is remarkable for being the sole survivor amongst land mammalia from the pleistocene to the prehistoric age which has since become extinct. Its rarity in Britain forms a marked contrast with its abundance in Ireland. It has been found in England, near Newbury in Berkshire, and at Maybole in Ayrshire. In the neolithic period the dog, horse, sheep, goat, shorthorn, and hog were already domesticated.

"Of all the neolithic implements the axe was by far

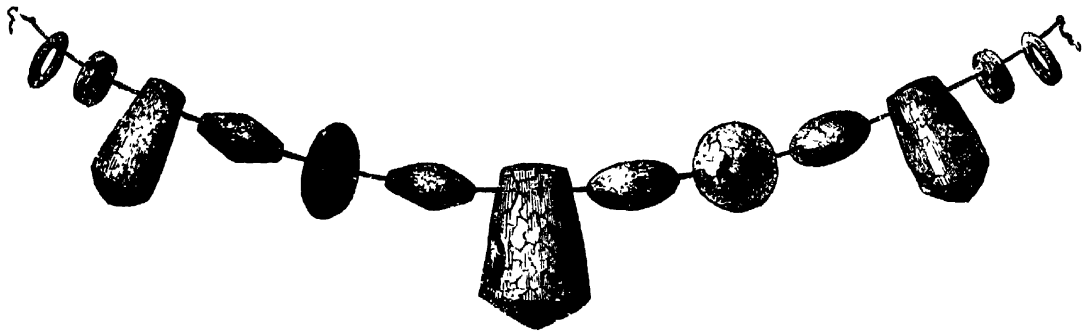

FIG. 5.—Amber necklace Lake, Wilts, q

the most important. It was by the axe that man achieved his greatest victory over nature, by clearing the land of forest. It was immeasurably superior to the rude flint *hache* of the palæolithic hunter, which could not make a straight cut in wood, and which was very generally intended for use in the hand, without a handle. It is therefore chosen as the symbol of the neolithic culture."

In New Guinea and its neighbourhood land is still cleared of forest by the natives for culture by the aid of fire and the stone hatchet.

Chapter X. treats of the further development of culture, the Bronze age, and the invasion of the British Isles by the Celts, who are proved by their tombs, scattered over the face of the country, alike in England, Scotland, Wales, and Ireland, to have conquered nearly every part of the British Isles. In the Bronze age the number and variety of the weapons, implements, and ornaments belonging to the men of the period become greatly increased, and their culture presents a far more complicated problem for study than that of their simpler predecessors. Mr. John Evans, who, as the highest authority on early bronzes, is followed by the author, divides the Bronze age into two periods—the Early and the Late; the first of these was a period of transition, when the use of bronze was superseding that of stone, and is characterised by the presence of bronze daggers and plain wedge-shaped axes, originally modelled from stone prototypes. The later division of the Bronze age is characterised by the appearance of swords, spears, palstaves, and socketed celts. Already in the

early Bronze age such articles of advanced development as tweezers and combs of bone, amber and glass beads, jet buttons, and bronze finger-rings and ear-rings were in use. The accompanying woodcut represents an amber necklace of the Bronze period found at Lake, in Wiltshire. Even gold is found amongst the remains of this age.

We cannot follow the author in his account of the temples of the Bronze age, Avebury and Stonehenge, nor



FIG. 6.—Golden cap. Devil's Bit, Tipperary.

in his description of the methods by which the bronze was worked, of the artistic designs of the period, and of the curious hoards of bronze merchandise which have been found in France, and the pick of which has, we believe, found its way into Mr. John Evans' hoard. The twelfth chapter deals with the prehistoric iron age north of the Alps, the arms and equipage, personal ornaments, late Celtic art, Etruscan influence on art, &c. Arts in

this period reached a very advanced development indeed, as may be seen from the appended figure of a golden cap found in Tipperary. It is most beautifully ornamented in *reposé*.

Silver and gold ornaments in this age became abundant. The concluding chapters in the book are on the Overlap of History (the Egyptian, Assyrian, Phœnician, and Greek Influences) and on Britain in the Historic Period (the Exploration of the British Coasts, and Roman Britain). We cannot follow the author further, but commend his book to our readers as one that will well repay perusal throughout.

#### THE HYDROGRAPHIC DEPARTMENT

WE observe that some of our contemporaries have opened their columns to certain strictures upon a public department standing well, and to our knowledge deservedly so, in the estimation of scientific circles in this and other countries.

It would appear that a Lieutenant of the Royal Navy, unknown, as we are informed, in his profession from the fact of his having retired from its active service at an early age, amused himself some few years back by a yachting excursion on the shores of Norway, in a small and crazy decked boat, undergoing, as might have been anticipated, some hardships in this excursion, which extended into the rigorous winter of that region. Gaining thus some knowledge of the coast traversed—but necessarily, from its great extent and intricate character, knowledge of a very superficial kind—the Lieutenant's experiences have recently formed the subject of an evening's entertainment at the Royal Geographical Society. Somewhat unfortunately for the ends of science and navigation, this adventurous cruise in a crazy barque has been in consequence dignified into a hydrographical survey, an appellation ludicrously inapplicable from the conditions under which the cruise was made, as related by the adventurer himself.

The ambitious *voyageur*, now extending his operations, under the leadership of an official of the Royal Geographical Society, has just addressed an audience at the Society of Arts on the "Trade Routes between England, Norway, and Siberia." We had expected at least some shreds of information on this topic, but find ourselves treated instead to a rude and ungenerous attack on the Hydrographic Department of the Admiralty, for some supposed shortcomings in its dealings with the officer, to whom the department had confided—mistakenly it seems—the revision of the sailing directions of that part of Norway on which the Lieutenant claimed to be an authority.

The Society of Arts commends itself to all reasonable men for the breadth and strength of its operations; we regret that it should in this instance have been exploited and made the arena, under cover of a legitimate object, for an attack, from personal motives, on a public department which has done and is doing good and honest service for the seamen of all nations. We believe we are only performing an act of merited justice in directing attention to the endeavours of a small, obscure, but self-asserting clique, bent apparently on discrediting a valuable and efficient department, affiliated in many ways to science, and well known to many of its ablest workers.

#### NOTES

PROF. W. H. MILLER died at Cambridge on Thursday, May 20, in his eightieth year. He graduated in 1826, being Fifth Wrangler, and shortly afterwards became a Fellow of St. John's College. He served his college as tutor during several years. On the resignation of Dr. Whewell in 1832 he became Professor of Mineralogy. He published his celebrated "Treatise on Crystallography" in 1838. This work was at once adopted by

some of the most eminent foreign crystallographers, and may now be said to be universally accepted. It was translated into German and French. His "Manual of Mineralogy" appeared in 1854, and, like the former book, forms an era in the history of the science. It is full of the results of his own careful research. He is the author of several other books, and of numerous memoirs published in the various scientific journals. The memoir on the standards of weights is a classical research on the subject of weights, and is a monument of delicate and careful research. He was Foreign Secretary of the Royal Society, and was presented with the Society's gold medal in 1870 for his numerous contributions to science. Cambridge has especial cause to be grateful to him for the very splendid collection he has brought together. The collection consists almost entirely of donations; and the two noble gifts of the Hume and Brooke collections mark in a striking manner the appreciation in which Prof. Miller was held by lovers of minerals.

ON the same day as Prof. Miller died Prof. David Thomas Ansted, F.R.S., at the age of sixty-six years. Prof. Ansted was born in London in the year 1814. He graduated at Jesus College, Cambridge, was a Wrangler in 1836, and was elected in due course a Fellow of his college. In 1840 he was appointed to the Professorship of Geology in King's College, London. Five years later he became lecturer on geology at Addiscombe College, and also at the Civil Engineering College at Putney. About the same time he was made assistant secretary to the Geological Society, whose quarterly journal he edited for many years. From about 1850 down to a very recent date he was extensively engaged in the application of geology to the engineer's work, in mining, and in various other departments of industry. He has also been frequently employed as an examiner in physical geography under the officers of the Government Department of Science and Art. Prof. Ansted's works are very numerous; among them may be mentioned—besides his contributions to the transactions of learned and scientific societies—his "Application of Geology to the Arts and Manufactures," his "Physical Geography," his "Elementary Course of Geology and Mineralogy," and "The World we live in." Prof. Ansted was elected a Fellow of the Royal Society in 1844.

GENERAL MYER has sent a letter to his numerous correspondents, requesting, on behalf of the United States, that the hour for taking the simultaneous meteorological observations, from which are constructed the U. S. Weather Maps, be changed to a time thirty-five minutes earlier than at present; in other words, as regards the British islands, that the observations be made at oh. 5m. p.m., instead of oh. 43m. p.m. Greenwich mean time, and that the change be made to take effect on September 1, 1880. The proposed change being rendered necessary by the exigencies of the Signal Office, the request will doubtless be gladly acceded to.

THE second example of *Archæopteryx* is, we are informed, at present merely *on deposit* in the Geological Museum of Berlin, under the care of Dr. Beyrich, although it is expected that arrangements will shortly be made for its purchase by the authorities of that institution. It was bought from Dr. Haeberlein, of Pappenheim, by Herr Siemens, of Berlin, for the sum of 20,000 marks (1,000*l.*), in order to save it from an impending transfer to America, and to secure this valuable specimen for German science.

THE "Leopoldinische-Carolinische" Academy of Naturalists at Halle has presented this year's Cothenius medal to Dr. A. Michaelis, Professor of Chemistry at the Polytechnic High School of Karlsruhe, in recognition of his valuable researches in organic substances containing phosphorus.

AMONG the names mentioned for the honour of D.C.L. at the approaching Oxford Encenia is that of Prof. Sylvester.

WE regret to announce the death of Dr. Richard Biedermann, editor of the *Centralblatt für Agricultur-Chemie*. He died at Leipzig on May 10, at the early age of thirty-seven years.

IT is a fact worth noting that M. Chevreul, who is now in his ninety-fifth year, has begun his course on Chemistry at the Paris Museum of Natural History, with as much apparent zest and energy as he did fifty years ago when he first entered on his duties of that chair. The programme of his course, *Les Mondes* informs us, is beautifully and firmly written in his own hand. Notwithstanding his approach to the centenary, he still looks young and fresh.

A CORRESPONDENT, writing from Cherry Hill, Arnold, near Nottingham, informs us that he brought home from the Geisberg, in the autumn of 1877, a few specimens of the Edelweis, which he planted amongst some rock-plants in his pleasure-grounds situated on an eminence. It disappeared gradually altogether until last spring, when it came out to perfection. Towards the autumn he lost sight of it again, but a fortnight since signs of its reappearance were so developed that no doubt exists of its full growth, and in greater perfection than ever.

THE two first parts of a new botanical work by Dr. Dodel-Port, of Zürich, have just been published by Herr Cæsar Schmidt of that city. The title of the work is "Illustrirtes Pflanzenleben," and it promises to become one of unusual interest. In part I the lower fungi are described in a popular manner. The author undertakes to popularise the results hitherto attained in our knowledge of putrefaction and contagion-fungi. He describes their forms, their size, and their manner of propagation; introduces the reader to their mode of life, and points out the danger arising to the human race from these minute organisms. The description is accompanied by two excellent plates, in one of which we recognise a reproduction on a small scale of a plate from the same author's famous "Atlas der Botanik für Hoch und Mittelschulen." Another chapter treats of miasma and contagions, and gives a complete account of the present state of our knowledge of infection-fungi. Part 2 is devoted to carnivorous plants, and is even more generally interesting perhaps than the first. The work is profusely illustrated with the author's original drawings. Altogether it is sure to form a very welcome and valuable addition to botanical literature.

THE death is announced of Dr. J. G. Mulder, Professor of Chemistry at Utrecht University. Dr. Mulder's name was well known in the scientific world; he died at the age of seventy-seven years.

THE Iron and Steel Institute holds its autumn meeting this year at Düsseldorf, by invitation of the German iron trade, on August 25 and four following days. An extremely interesting programme of excursions and meetings has been arranged.

AN interesting Report on the Meteorology of the Italian Mountains has been presented by the Rev. Prof. F. Denza to the International Congress of Alpine Clubs at Geneva. It appears that observations are regularly made at 113 mountain stations, the names, elevation, and geographical position of which are given in the report. Some of these stations, from their altitude and position, are of the greatest importance for the study of meteorology in the higher regions of the atmosphere. Three of them are specially worthy of notice, viz., Stelvio (2,543 metres), Valdobbia (2,548 metres), and Piccolo S. Bernardo. All stations are provided with good instruments, and meteorological observations are taken at some stations every three hours from 6 a.m. until 9 p.m. The results of the observations are carefully printed and circulated by Prof. Denza.

A GENERAL MEETING of the Mineralogical Society of Great Britain and Ireland will be held at the Meteorological Office, 116, Victoria Street, London, S.W., on Tuesday evening, June 1. The chair will be taken by Prof. T. G. Bonney, F.R.S., vice-president, at 8 p.m. The following papers will be read:—"On a New Face on Crystals of Stilbite, from Scotland and Western Australia," by the president; "On a Portable Chemical Cabinet for Quantitative Work," by A. E. Arnold (communicated by J. H. Collins); "On Kaolinite and Kaolin," by J. H. Collins. Other communications intended to be read at this meeting should be sent to J. H. Collins, Hon. Sec., care of Mr. R. H. Scott, at the above address.

THE Society of Telegraph Engineers have done valuable service to science by publishing the "Catalogue of Books and Papers relating to Electricity, Magnetism, the Electric Telegraph, &c.," including the Ronalds Library," compiled by the late Sir Francis Ronalds, F.R.S. Some idea of the extent and value of this catalogue may be obtained from the fact that it occupies 560 pages. The work of editing has been carefully and judiciously done by Mr. A. J. Frost, who has prepared a useful memoir of Sir Francis Ronalds. The Catalogue contains 13,000 entries, though we regret that, by the conditions of the trust, the Society were not permitted to bring it up to date. They will, however, be glad to learn, at no distant date, publish a supplement to the Catalogue, which will remedy this defect. The two together will form an invaluable reference-book in the subjects included in it.

IN reference to a note in NATURE, vol. xxi. p. 525, taken from the *Journal of Applied Science*, on the composition of the well-known Vevey cigars, Messrs. Grant, Chambers and Co., of Fenchurch Street, send us a letter from Ormond and Co., of Geneva, the manufacturers, in which they state that if such cigars exist as we referred to, "it can only be with the object of fraudulently taking advantage of the name of the goods we make, which have enjoyed an increasing reputation for more than thirty years past. The Vevey cigars manufactured by us are composed entirely of selected North and South American tobaccos, without any mixture or adulteration whatever."

A NEW scientific paper now appears at Leipzig every three weeks. It is called *Centralzeitung für Optik und Mechanik*. Dr. O. Schneider is the editor. The avowed object of the paper is to report on the progress in the manufacture of scientific instruments and apparatus, and in the scientific domain where such instruments and apparatus are employed.

A PROPOSAL has been set on foot for lighting the Sheldonian Theatre, Oxford, and the Camera of the Radcliffe Library with the electric light. In a circular addressed to the curators of the Theatre and of the Bodleian Library and to the visitors of the Ashmolean Museum by those interested in the question, it is stated that it has long been regretted by many members of the University that the Sheldonian Theatre is not available in the evening for any purposes of public interest, however great, for want of lighting. The neighbourhood of the Bodleian Library has, however, been a bar to any proposal for lighting by means of gas or any ordinary method. The care with which the heating apparatus of the Theatre has been inclosed within a fire-proof chamber is sufficient evidence of the importance attached by the curators of the Theatre to absolute security in this respect. The development of the electric light has now rendered it possible to illuminate public rooms by a process absolutely free from danger of fire. It has been adopted largely in the reading-rooms of our public libraries, and notably in the reading-room of the British Museum. The security is absolute and unquestionable, provided that the motive power is external to the building: the boon to readers in such reading-rooms is enormous. After dis-

curring the question of the motive power and deciding in favour of a gas-engine, the memorial goes on to state:—"It is suggested that Dr. Siemens, F.R.S., D.C.L., to whom the electric light owes much of its recent development, might with advantage be consulted in connection with this proposal. Whether a permanent institution or an experimental trial is in question, all parties concerned can have the most perfect confidence that everything will be done as it should be in his hands. It is suggested that an experimental trial should be first made, which could be done at comparatively little expense. The memorialists feel confident that if this is conceded the permanent adoption of the light will follow." The memorial is already signed by Professors Henry S. Smith, W. Acland, H. Nettleship, Sayce, Sir Gore Ouseley, and Mr. Warren De la Rue.

THE enterprising Naturalists Society of Dundee had a very successful dredging excursion off the mouth of the Tay and in St. Andrew's Bay on Wednesday last week. Considerable hauls were obtained of familiar denizens of the coast waters, though we regret to learn that under the influence of the gentle swell in St. Andrew's Bay several of the budding naturalists suffered some disturbance of their equanimity, and we fear were not able to do perfect justice to the dinner and tea which were liberally provided on board. At the annual meeting of this Society a satisfactory report was presented, though we do not altogether approve of the movement for the publication of abstracts of the proceedings of the Society in the form of a journal. Such publications, we are inclined to believe, are more gratifying to the vanity of provincial societies than conducive to the promotion of science in any way. We see the Society is uniting with several other Scotch societies to endeavour to obtain the benefit of the Gilchrist Lecture Trust; why do they not take a hint from the line of action in reference to a journal, and endeavour to bring about a union of the various Scottish natural history societies for this and other purposes?

A CORRESPONDENT of the *Scotsman* writes that a colony of rooks has taken possession of a garden which is next to St. Magnus Cathedral, Kirkwall, and built about a score of nests. It is only two or three seasons since rooks made their first appearance in Orkney, and it is supposed the absence of trees in the country districts has caused them to take up their abode in the centre of the town.

*Cotton* is the title of a new weekly journal for manufacturers and planters.

AN important discovery is stated to have been made in the neighbourhood of Sydney, New South Wales. Boring for coal has been going on in Moore Park for ten months, and about the middle of March a quantity of oily matter was observed to come up, one gush lasting half an hour. This liquid is believed to be crude kerosene, but the analysis was not complete when the last mail left.

THE *Reale Istituto Lombardo di Scienze e Lettere* at Milan offers the following prizes:—For a treatise on Miasma and Contagions (Term May 31, 1881), a prize of 1,500 lire and a gold medal worth 500 lire. For determining by experiments whether the virulent principle of hydrophobia is an organised germ or not, a prize of 6,000 lire (Term February 28, 1882). For a descriptive treatise on the Motor-centres of the Periphery of the Brain, the sum of 2,000 lire (Term April 1, 1881). For the illustration by new research of the aetiology of cretinism and idiotism, 2,000 lire (Term May 31, 1882). Further details can be obtained by application to the Secretary of the Institution.

THE *Forester* is the title of a magazine published in connection with Nottingham High School, No. 7 of which has been sent us. The contents are varied, one paper being on the "Origin of Sandstones."

M. DEHAIRAN has opened the course of lectures that he is to deliver at the Museum d'Histoire Naturelle, on Vegetable Physiology. This chair has been recently created by M. Jules Ferry.

A SCIENTIFIC examination of the Ibaraki mountain range in Japan has resulted in the discovery of marble of different colours. One mountain is believed to be a mass of white statuary marble, and in another place black marble of the finest description was found.

THE additions to the Zoological Society's Gardens during the past week include a Black-faced Kangaroo (*Macropus melanops*) from South Australia, four Short-tailed Wallabys (*Halmaturus brachyurus*), three Vulpine Phalangiers (*Phalangista vulpina*), three white-backed Piping Crows (*Gymnorhina leuconota*) from West Australia, presented by Sir Harry St. George Ord, C.B., F.Z.S.; a Javan Chevrotain (*Tragulus javanicus*) from Java, presented by Mrs. L. Dudfield; a Brown Capuchin (*Cebus fatuellus*) from Guiana, an Ocelot (*Felis pardalis*) from South America, a Ring-tailed Lemur (*Lemur catta*) from Madagascar, presented by Mr. Chas. A. Craven; a Pinche Monkey (*Midas adippus*) from New Granada, presented by Mrs. Henry Druman Macaulay; a Long-eared Owl (*Asio otus*), British, presented by Mr. G. E. Dobson, C.M.Z.S.; an Eyed Lizard (*Zacerta ocellata*), an Aesculapian Snake (*Coluber asculapii*), six Viperine Snakes (*Tropidonotus viperinus*) from San Remo, North Italy, presented by Lieut. L. L. Fenton; two Toco Toucans (*Ramphastos toco*) from Guiana, a Brown Passerine Owl (*Glaucidium phalaenoides*), a Rusty Urubitinga (*Urubitinga meridionalis*), a Downy Owl (*Pulsatrix torquata*) from South America, deposited; two Guilding's Amazons (*Chrysotis guildingi*) from St. Vincent, West Indies, two Black-tailed Hawkfinches (*Coccothraustes melanurus*) from Japan, four Golden Sparrows (*Auripasser euchlorus*) from Abyssinia, four Blood-breasted Pigeons (*Phlogoenas cruentata*) from the Philippine Isles, two Nightingales (*Daulias luscinia*), a Canary Finch (*Serinus canarius*), a Gannet (*Sula bassana*), British, purchased; a Black Wallaby (*Halmaturus ualabatus*), born in the Gardens.

#### OUR ASTRONOMICAL COLUMN

THE LATE PROF. PETERS.—Prof. Christian August Friedrich Peters, whose death was mentioned last week, was the son of a merchant at Hamburg, and was born on September 7, 1806. His father's fortunes suffered in the war times, and his son's education was attended with difficulties, though he endeavoured to cultivate to the best of his power the natural bent for mathematical studies which was very early evinced. After some years the attention of Schumacher was drawn to the young Peters, and he employed him in various calculations for his ephemerides and geodetical works, and in 1826, and for several years subsequently, he was actively engaged in such operations at Hamburg and in Holstein, at the same time pursuing his studies and incidental employment under Schumacher. He then became for a time a pupil of Bessel, and in 1834 was appointed assistant in the observatory at Hamburg, whence in 1839 he was promoted to a position in the newly-founded Central Russian Observatory at Pulkowa, where he worked in theoretical and practical astronomy for ten years. In 1849 he was named Professor of Astronomy in the University of Königsberg, where he remained until 1854, in which year he was appointed to succeed Petersen in the direction of the observatory at Altona, and at the same time editor of the *Astronomische Nachrichten*, which he conducted up to the period of his decease. He removed to Kiel when the observatory at Altona was transferred to that place, and died there on the 8th inst., after a severe illness of many months' duration.

The works by which Prof. Peters was perhaps more widely known were his "Numerus constans Nutationis ex Ascensionibus Rectis Stellae Polaris in Specula Dorpatensi Annis 1822 ad 1838 observatis deductus," which appeared in the *Transactions* of the Imperial Academy of Sciences of St. Petersburg in 1842, and the "Recherches sur la Parallaxe des Etoiles Fixes," printed in the same *Transactions* in 1846. For these important



memoirs he received the gold medal of the Royal Astronomical Society at the hands of Prof. J. C. Adams in 1852. His researches on the proper motion of Sirius also attracted much attention, and many other papers on various astronomical and mathematical subjects were contributed by him to the *Altona journal*. His later work at Altona and Kiel chiefly bore upon the determination of differences of longitude; the last, "*Altona Göttingen*," is to be detailed in a memoir to be published in a few weeks.

**MINOR PLANETS.**—Circular No. 136 of the *Berliner Astronomisches Jahrbuch* notifies the re-observation of *Hilda*, the most distant of the group of small planets yet known to us, and one which, with *Ismene* No. 190, must at times experience considerable perturbations from the action of Jupiter. It has been found at Pola as an object of 13.5 m., many degrees from the position assigned in the ephemeris last published, but there seems reason to suspect error of calculation. Thus if the elements of Dr. Kühnert in the *Berliner Jahrbuch* for 1880 are employed, though there is a later orbit, the error of the computed place is much less than that shown by the ephemeris in the Berlin Circular, No. 135. The difference of positions appears to indicate that the true period of revolution is even longer than has yet been calculated.

In the same Circular, No. 136, are new elements of *Philomela*, attributing to that planet an almost circular orbit, the angle of eccentricity being only  $0^{\circ} 18' 36'' \cdot 8$ , so that  $e = 0.005414$ , which is less than in the case of *Venus*.

*Medusa*, to which has been assigned the shortest period of any of the minor planet group, has apparently passed the last opposition without being re-observed, but in addition to much uncertainty as to position, it was likely to fall in a region of the sky which is crowded with small stars, and therefore a search would be attended with much trouble and difficulty.

*Vesta* should now be well discernible without the telescope, being in opposition and perihelion this year nearly at the same time, as we have before remarked, magnitude 5.9. The planet is in perihelion on May 28.

**COMET 1880, II.**—The following ephemeris is calculated from elements depending upon observations to May 8:—

12h. G.M.T.	R.A.			Decl.	Log. distance from the	
	h	m.	s.		Earth.	Sun.
June 1 ...	6	29	32 ...	+ 51 38.8 ...	0.4108 ...	0.2683
3 ...	30	41 ...	50 52.4			
5 ...	31	49 ...	50 7.0 ..	0.4168 ...	0.2660	
7 ...	32	57 ...	49 22.7			
9 ...	34	5 ...	48 39.4 ...	0.4221 ...	0.2640	
11 ...	35	13 ...	47 57.0			
13 ...	36	20 ...	47 15.6	0.4267 ...	0.2623	
15 ...	37	27 ...	46 35.0			
17 ...	38	33 ...	45 55.2 ...	0.4307 ...	0.2609	
19 ...	39	38 ...	45 16.1			
21 ...	6	40 43 ...	+ 44 37.7 ...	0.4340 ...	0.2599	

**PHYSICAL NOTES**

PROF. LEMSTRÖM, of Helingsfors, has recently described to the Physical Society of St. Petersburg a singular experiment which, unless otherwise explained by some of the circumstances of the experiment not yet published, must be regarded as a fundamental fact in the physical theory of electricity. He finds that a ring of insulating material when rotated about its axis of symmetry with a high velocity acts like a galvanic circuit, and produces a magnetic "field" in the space within it. Prof. Lemström is a disciple of Edlund, and regards this experiment as confirmatory of Edlund's theoretical views on the nature of electricity. According to Lemström, the ether in the inductor, being dragged along by the ring, produces vortical motion of the ether in the central space, which vortical motion he conceives to be the essential condition of a magnetic field. Arguing from the premises, Lemström proceeds to build up an ingenious theory of terrestrial magnetism. The converse operation of rotating an iron bar within a hollow insulating body or insulating medium ought also to produce magnetism in the bar. The earth being a magnetic body rotating in an insulating medium, ought to be magnetised by rotation about its axis, the axis being the axis also of magnetisation, unless the irregular internal disposition of the magnetic constituents produced an irregular distribution of the magnetism, or unless the distribution were affected by the induced magnetism due to movements of electricity in the atmo-

sphere, as in the *aurora*, or by the magnetism which would, on Lemström's theory, be generated by the revolution of the earth round the sun, and by the motion of the solar system through space.

M. DUMAS, who has been examining the property of certain metals in occluding gases, has found that aluminium may occlude as much as one and a half times its bulk of hydrogen gas, and also shows traces of carbonic acid. The gases were given up when the metal was heated to redness under exhaustion. Magnesium behaves similarly. Were these metals distilled *in vacuo* they could probably be obtained pure. It is possible that these observations may throw some light on the anomalous behaviour of aluminium when used as an electrode in the voltameter.

THE cone of rays entering the eye from a peripheric point is never again united to one point, but it must present somewhere a minimum of cross section. The geometrical place of this minimum of cross section Herr Matthiessen (*Arch. f. Ophthalm.* (4) 25, 1879) designates the "theoretic retina." He finds that it is a spherical surface, the middle point of which coincides with the middle point of the corneal ellipsoid. To a distance of 75° from the fovea centralis the theoretical retina corresponds very exactly to the actual (according to the determinations of Arlt and Helmholtz). At greater distances the retina is formed hypermetropically, and so is within the "theoretic retina."

THE influence of magnetisation on the tenacity of iron has been lately studied by Signor Piazzoli (of the Catanian Academy of Sciences). Iron wires were hung between two hooks and ruptured by pouring water into a vessel suspended from them. They were about 350 mm. long, and were inclosed in a spiral with four windings one over another, which were either all traversed by a current in one direction, or two by a current in one direction, and two by an equal opposite current, so that in both cases the wires were equally strongly heated by the spiral, but in one case they were magnetised, in the other not. The weights required to break wires annealed in charcoal (weight of one metre,  $G = 0.299$ ) were, during magnetisation,  $P = 1260-1306$ ; without magnetisation,  $P' = 1213-1270$ . In the case of wires annealed in carbonic oxide (where  $G = 0.46$  g.),  $P = 1732.4 - 1742.7$ ;  $P' = 1703.62 - 1719.87$ . In the case of wires annealed in hydrogen  $P = 1289.5 - 1310.1$ ;  $P' = 1263 - 1299.7$ . In each separate series, accordingly, the difference  $P - P'$  was frequently less than the difference between the highest and lowest weights required for rupture of apparently identical wires; still, the mean values in each of the (14) series, were from about 1 to 3 per cent. greater for the magnetised than for the unmagnetised wires, showing that the tenacity of iron increases on magnetisation. This, it is remarked, need not be attributed to a change of cohesion of the iron, but may be due to ordinary magnetic attraction of the successive parts of the wires. In eleven out of fourteen cases the relative elongation of the magnetised wires at rupture was greater than that of the unmagnetised, in three cases less.

IN a recent note to the Vienna Academy, Prof. Ludwig gives the results of the first of a series of observations on the decomposition of organic compounds by zinc powder. This relates to alcohols, and it is stated that in distillation of these over zinc powder heated to 300 - 350° C., the higher ones—from ethylic alcohol upwards—are split up into the corresponding olefine and hydrogen. Under the same conditions methylic alcohol is decomposed simply (if the small quantities of marsh gas be neglected) into carbonic oxide and hydrogen. The similar decomposition of ethylic alcohol into marsh-gas, carbonic oxide and hydrogen, only occurs at a considerably higher temperature—with dark red glow. On the ground of these decompositions, which indicate that the combination of the carbon and the oxygen must be a very strong one, it is supposed that the decomposition of the higher alcohols is no simple reduction to the saturated hydrocarbon, from which, then, by separation of hydrogen, the olefines might arise, but that in the first phase of the process the alcohol is split up into the olefine and water, and that the hydrogen concentrated in the gases is due to a reduction of the generated steam by the zinc powder.

PROF. RIGHI has recently described to the Bologna Academy an arrangement of Holtz's electric machine, in which the whole machine except the handle and the electrodes is inclosed, along with a small friction machine for excitation, in a glass case tightly

closed by means of strips of fur, and dried interiorly with chloride of calcium, so that in all weathers the machine acts well.

HERR ZEHFUSS has lately given (*Wied. Ann.*, 4) some personal experiences of the phenomenon of "after images of motion" (about which Plateau and Oppel have before written). These after images may be had, e.g., in a train, if one look at a point on the horizon for a little, then turn to look at (say) a horizontal fibre in the wood of the carriage, or close one's eyes. Motions then seem to be still perceived; in the latter case, e.g., a stream of sparks seems to be moving to the right (or if the point originally looked at have been between the observer and the horizon, there is a stream of sparks above going to the right and one below to the left). Herr Zehfuss offers a physiological explanation, in preference to the partly psychical ones proposed by Plateau and Oppel. Each individual nerve rod, he supposes, has special blood-vessels, which, when the original image of a moved object goes to the right, directs the course of the blood to that side, just as in ordinary light the decomposed blood is promptly replaced by fresh. By this preponderant direction of blood to the right a heaping up occurs in each retinal element on the right, which gives rise to return currents as soon as the outer cause has ceased to act. As the blood flows back there arise, in consequence of the specific excitability of the rods, those spark-streams, which are projected as elementary motions to the right.

In a recent number of *Wiedemann's Annalen* (3) Herr Schonn describes a method of making visible ultra-violet prismatically decomposed light in such a way that exact measurements can be made. One feature of it is the use of a disk of fine calking paper saturated with sulphate of quinine, and contained in a small cell which is brought close before the Ramsden ocular, which can be directed at once on the disk and on a luminous line (its axis is not inclined like that of Soret's, but coincides with the axis of the telescope). The author gives measurements of the ultra-violet spectrum of cadmium, zinc, and thallium.—In the same number Herr Glan describes a "spectro-tele-cope," with which objects can be seen in any homogeneous colour at will. The instrument has various applications, especially in astrophysics.

In a paper on the thermic theory of the galvanic current (*Wied. Ann.*, No. 4) Herr Hoorweg lays down the following propositions:—Wherever two conductors come into contact, motion of heat results in development of electricity; therefore a constant electric difference arises between the two substances. 2. If in a closed circuit, the total sum of the differences of potential be different from zero, there arises in this circuit a continuous electric current. 3. This current exists at the cost of the heat at one part of the point of contact, and has heat-production in the other for a result. 4. All voltaic currents are thermo-currents. 5. The chemical action in the battery and the decomposition apparatuses is a result of the galvanic current.

An interesting series of experiments has been recently made by Dr. König on the vibrations of a normal tuning-fork (*Wied. Ann.*, No. 3). He finds that, practically, at least to 50° to 60° of heat, the influence of heat on a tuning-fork may be regarded as constant. Thick tuning-forks are more affected by heat than thin ones of the same pitch, indicating (it is remarked) that change of elasticity, and not change of the length of the arms, is the primary cause of the change of pitch. The influence of heat on tuning-forks of different pitch, and of not very different thickness, is proportional to their number of vibrations. Generally the period of vibration of a tuning-fork is increased or diminished  $\frac{1}{273}$  by a difference of temperature of 1° centigrade. The general change in pitch of the normal fork  $U_3 = 512$  vibrations per second at 20°, through the temperature difference of 1° C. is 0.0572 vibrations per second. Dr. König has constructed a fork which, at any temperature, will exactly give 512 vibrations.

SOME quotations by Herr Oehler (*Wied. Ann.*, No. 3) from Jacob Hermann's work, "Phoronomia sive de Viribus," &c., published in 1716, have a curious significance in relation to the history of the mechanical theory of heat. In the twenty-fourth chapter, "De motu intestino fluidorum," the following paragraph occurs:—"Hoc nomine non intelligitur hoc loco internus molecularum motus fluidi cujuscunque in suo statu naturali consistentis, sed is particularum motus, qui in fluidis a causis externis et accidentalibus excitari solet, quo calor præsertim est referendus, qui dubio procul ex concitatore particularum motu

in corpore calido a causis externis producitur. Utut vero ejusmodi motus intestinus admodum perturbatus sit, nihilo tamen minus regula physice satis accurata pro ejus mensura media tradi potest. In another place Hermann offers a demonstration of the theorem that "Calor, cæteris paribus, est in composita ratione ex densitate corporis calidi, et duplicata ratione agitationis particularum ejusdem."

### GEOGRAPHICAL NOTES

LIEUT. A. LOUIS PALANDER, of the Swedish Royal Navy, was last week elected a Corresponding Member of the French Geographical Society, in acknowledgment of his brilliant services to geography as commander of the *Vega* during the late Arctic Expedition. We understand that the Swedish Royal Academy of Sciences have just caused a handsome bronze medal to be struck in commemoration of the successful accomplishment of this enterprise. This medal shows on one side the heads of Prof. Nordenskjöld and Lieut. Palander, and on the other a well-executed representation of the *Vega* surrounded by ice.

AT the Anniversary Meeting of the Geographical Society, on Monday next, the Earl of Northbrook will take the chair for the last time, and will deliver an address on recent geographical progress. The formal presentation of the Royal Medals will also take place at this meeting, though neither of the recipients (Lieut. Palander and Mr. Ernest Giles) can be present. The Duke of Edinburgh, Honorary President of the Society, will preside at the Anniversary Dinner in the evening, which will be held, as usual, at Willis's Rooms.

LORD ABERDARE, it is understood, will succeed the Earl of Northbrook as President of the Geographical Society.

A BEGINNING is about to be made to carry out Lieut. Weyprecht's proposal for a circle of observing stations around the North Polar region. The Danish Government has resolved to establish a station at Upernivik, in West Greenland; the Russian Government has granted a subsidy for an observatory at the mouth of the Lena, and another on the new Siberian Islands; Count Wilczek is to defray the expenses of a station on Novaya Zemlya under the direction of Lieut. Weyprecht; the U.S. Signal Service, under General Myer, has received permission to plant an observatory at Point Barrow, in Alaska; and it is expected that Canada will have a similar establishment on some point of her Arctic coast. At the Hamburg Conference it was announced that Holland would furnish the funds for a station in Spitzbergen; and it is expected that Norway will have an observing post on the extremity of the Province of Finnmark. This is a good beginning, and we hope that some sort of agreement will be established to have all the observations made after a uniform method, otherwise their value will be greatly decreased.

BARON EGGERS, of St. Thomas, West Indies, sends us a prospectus of a plan for the scientific exploration of the West Indies, especially as regards their natural history, his main purpose evidently being to make complete collections of plants, insects, and shells. Such collections he offers at certain rates to all who express their wish to become subscribers, the subscription to be paid on delivery of the collections. Details may be obtained from Baron Eggers or from his agent in Europe, Dr. Eug. Warming, Copenhagen.

M. PAUL SOLEILLET, who was compelled to return to Senegal in his attempt to reach Timbuctoo, is now in Paris, and expresses his determination to embark again in July, to make another attempt.

A SOCIETY of Geography for the north of France has been established at Douai.

### UNIVERSITY AND EDUCATIONAL INTELLIGENCE

CAMBRIDGE.—The election to the Professorship of Mineralogy, vacant by the death of Dr. W. H. Miller, F.R.S., will be held in the Senate House on June 12.

In the fourteenth Annual Report of the Museums and Lecture-Room Syndicate, Lord Rayleigh, the recently-appointed Professor of Experimental Physics, says:—"On visiting the Cavendish Laboratory in December last, after my appointment to the Professorship of Experimental Physics, I was at once struck with the

great deficiency of apparatus. The building itself appears to me to be very convenient and adequate to its purpose, but the advantages which it should afford cannot be fully realised without a large addition to the existing stock of apparatus. Even with an adequate outfit, a considerable annual expenditure is necessary for renewals and to meet the wants of students engaged in original research. Knowing that the University is not likely for several years to be in a position to meet the want, and feeling that Cambridge ought not to remain in this respect behind several Continental and American Universities, I have been endeavouring to raise an apparatus fund, to be spent in eight or ten years at the discretion of the Professor, by inviting contributions from persons interested in Cambridge and in science. I have been fortunate enough to secure the co-operation of the Chancellor, to whom the University is already indebted for the building and for most of our existing apparatus; and the proposal has met with such a degree of support from others that it may be considered to be already a partial success. It is difficult to form an exact estimate beforehand, but I should suppose that 2,500*l.* will be required during the next ten years to put the institution upon a proper footing." Lord Rayleigh announces that he has received promises and donations amounting to 1,825*l.*

In connection with the Science and Art Department at South Kensington the following courses of instruction for science teachers will probably be organised this summer:—(1) Chemistry, from July 7 to 29, Dr. W. R. Hodgkinson. (2) Light, from June 29 to July 14; (3) Magnetism and Frictional Electricity, from July 15 to 30, Prof. Guthrie, F.R.S. (4) Applied Mechanics, from June 30 to July 22, Prof. Goodeve, M.A. (5) Geology, from June 30 to July 22, Prof. Iudd, F.R.S. (6) Botany, from July 7 to July 29, Prof. W. T. Thiselton Dyer, F.R.S.

## SOCIETIES AND ACADEMIES

### LONDON

**Royal Society, May 13.**—Abstract of paper "On the Chemical Composition of Aleurone-Grains," by Dr. Vines.

This paper continues the account of this investigation, which appeared in the *Proceedings* for 1878. It was therein shown that the aleurone-grains of the Lupin consist of three proteid substances, namely, of two globulins—the one belonging to the myosin group, the other to the vitellin group—and of a substance, allied to the peptones, provisionally termed hemialbumose. In the present communication the results of the investigation of the grains of the peony and of the castor-oil plant (*Ricinus*) are given. The grains of the peony are found to be readily soluble in distilled water. Treatment with 10 per cent. NaCl solution, however, proves the existence of a myosin-globulin. Apparently no vitellin-globulin is present. The grains contain hemialbumose in considerable quantity. The grains of *Ricinus* present a complex structure. They consist of a mass of ground-substance of proteid nature, inclosing a crystalloid of proteid substance and a globoid which consists of inorganic matter. The ground-substance is found to be composed, like the grain of the Lupin, of the two globulins and of hemialbumose. The chemical nature of the crystalloid is not so clearly made out. It is slowly soluble in 10 per cent. NaCl solution, and readily soluble in 20 per cent. or in saturated NaCl solution after treatment with alcohol. The crystalloids of several plants were investigated with the view of ascertaining their relative solubility in solutions of this salt. Those of *Viola elatior* and of *Linum usitatissimum* were found to resemble those of *Ricinus* in this respect; those of *Bertholletia* and of *Cucurbita* are readily soluble in 10 per cent., and saturated NaCl solutions; those of *Musa esculenta* and *hillsii* and those of *Sparganium ramosum* are either insoluble or only partially soluble in these solutions.

The points of more general interest are the action of alcohol in promoting the solution of the crystalloids of *Ricinus* in 20 per cent. and in saturated solutions of NaCl, and the fact that long-continued exposure to alcohol does not render the vegetable globulins insoluble in these solutions.

The author finally expresses his opinion that the caseins which Ritthausen has extracted from various seeds consist to a considerable extent of precipitated hemialbumose.

**Physical Society, May 8.**—Sir William Thomson, president, in the chair.—New Members: E. F. Bamber, Dr. E. Obach, R. D. Turner, E. Woods, H. E. Roscoe, H. Watts.—Prof.

Minchin, of Cooper's Hill Engineering College, described his further researches on the subject of photoelectricity, brought by him before the last meeting of the Society. He has found that the current in a sensitive silver cell does not always flow from the uncoated to the coated plate. It does when chloride or bromide of silver is used, but when the sensitive emulsion is iodide of silver and the liquid water tintured with iodide of potash, the current is from the coated to the uncoated plate. He demonstrated that the current set up by the fall of light on the cell could be sent by wire to a receiving cell, and made to produce a local effect on the sensitive plate therein. He also proved that electricity is developed in fluorescent bodies by the action of light, and hopes to show that it is also developed in phosphorescent bodies. Neither heat nor the red rays produce this electricity, but it is the blue and violet rays which do so. The fluorescent silver plates he employed were coated with an emulsion of eosine and gelatin, and had been kept sensitive for twelve days. They would thus be a permanent source of photoelectricity, did the eosine not tend to leave the gelatin. Mr. Wilson had suggested naphthaline red for eosine, as not apt to leave the gelatin, and he had found it give good results.—Dr. O. S. Lodge described certain improvements which he had made in his electrometer key designed for delicate electrical and especially electrostatic experiments. Assisted by the British Association, he had made it more convenient, and fitted it into an air-tight case which could be artificially dried. The contact-pins were now of phosphor-bronze gilt instead of platinum, and the contacts were made by press-pins from the outside. Dr. Lodge also exhibited a new inductometer or modified form of Prof. Hughes's induction balance, combining a Wheatstone balance, and expressly designed for comparing capacities and resistances, especially the resistances of coils having no self-induction. A telephone takes the place of a galvanometer in the bridge, and the current in the primary coil is interrupted by a clockwork make and break. There is one primary coil of fine wire 3½ ohms in resistance and two secondaries, one on each side of it, of fine wire, each about 270 ohms. These are fixed, but the primary is adjustable by a screw. Prof. Hughes remarked that he had pointed out in his paper to the Royal Society that the induction-balance could be used in this way; and Dr. Lodge disclaimed any novelty in the apparatus beyond its arrangement. Sir W. Thomson added that it was satisfactory to see so serviceable an adaptation of the induction-balance to research.—Dr. Hopkinson, Prof. Perry, and Sir W. Thomson offered remarks on the element of time in comparing discharges from condensers of different dielectrics. Sir William said that, in 1864, he had made experiments on air and glass dielectrics, and found the discharge about the same for the first quarter-second.—Prof. Adams then took the chair, and Sir W. Thomson made a communication on the elimination of air from a water steam-pressure thermometer, and on the construction of a water steam-pressure thermometer. He said it was a mistake to suppose that air was expelled by boiling water, because the water dissolved less air when warm than when cold. The fact was due to the relations between the density of air in water and the density of air in water vapour. There was fifty times more air in the water vapour over water in a sealed tube than in the water below. If this air could be suddenly expelled only 1/10th part of air would remain, and of this only 1/2500th in the water, the rest being in the vapour. This suggested a means of eliminating air from water, which he had employed with success. It consisted in boiling the water in a tube, and by means of a fluid mercury valve allowing a puff of the vapour to escape at intervals. Sir W. Thomson also described his new water-steam thermometer now being made by Mr. Casella. It is based on the relations of temperature and pressure in water-steam as furnished by Regnault's or other tables, and will consist of a glass tube with two terminal bulbs, like a cryophorus, part containing water, part water-steam, and the stem inclosed in a jacket of ice-cold water. Similar vapour-thermometers will be formed, in which sulphurous acid and mercury will be used in place of water, or in conjunction with it. For low or ordinary temperatures they will be more accurate than ordinary thermometers.

**Geological Society, May 12.**—Robert Etheridge, F.R.S., president, in the chair.—Rev. Samuel Gasking, Thos. J. George, and Cuthbert Chapman Gibbes, M.D., were elected Fellows of the Society.—The following communications were read:—On the structure and affinities of the genus *Protospongia*, Salter, by W. J. Sollas, F.G.S.—Note on *Psephophorus polygonus*, von Meyer, a new type of Chelonian reptile allied to the leathery

turtles, by Prof. H. G. Seeley, F.R.S.—On the occurrence of the Glutton (*Gulo luscus*, Inn.) in the forest-bed of Norfolk, by E. T. Newton, F.G.S. Remains of the Glutton have hitherto been obtained only from cave-deposits. The author has lately received from Mr. R. Fitch, of Norwich, a portion of the lower jaw of this animal obtained from the forest-bed of Mundesley, Norfolk. The specimen consists of about two inches of the left ramus, bearing the first true molar and the hinder half of the fourth premolar in place. The jaw is smaller than in average specimens of the recent Glutton, but presents all the characters of the species as described in detail by the author.—A review of the family Diastoporidae, for the purpose of classification, by George Robert Vine. Communicated by Prof. Duncan, F.R.S.—On annelid jaws from the Wenlock and Ludlow formations of the West of England, by G. J. Hinde, F.G.S.

Entomological Society, May 5.—H. T. Stainton, F.R.S., vice-president, in the chair.—Mr. Peter Inghball, of Hovingham, York, was elected a member of the Society.—Mr. W. C. Boyd exhibited a very ripe specimen of *Nyssia hispidaria*, taken at Cheshunt.—Mr. M. J. Walsome exhibited some Geodephagous beetles, which were found only on the summits of some of the highest mountains in India.—Mr. W. L. Distant exhibited a long series of specimens of the Madagascar hemipteron *Ptyelus goudoti*, Benth., to illustrate the extreme variability of the species. The series showed a gradation from melanic to albino forms, and one specimen was asymmetrical in the marking of the tegmina, thus exhibiting the characters of two varietal forms, an occurrence which Mr. Distant stated was not altogether exceptional in extremely variable species of the order Rhynchota.—Mr. T. R. Hillips exhibited two living specimens of *Carabus auratus*, which had been found in the Borough Market. In reference to a prediction by Mr. Wallace that a sphinx moth would be found in Malaga ear with a proboscis of sufficient length to reach into the nectary of *Antirrhinum squibbale*, Mr. Pascoe stated that he had heard a rumour that such an insect had been discovered, and endeavoured without success to find any corroboration of the statement from members of the Society.—Miss E. O. Ormerod made some remarks as to the contents of a work which she had edited and presented to the Society, and which contained the meteorological observations taken by Miss Molesworth for a period of forty-four years. Some attempt was made to contrast the meteorological conditions with the dominant phases of plant and animal life during that period.

Victoria (Philosophical) Institute, May 10.—A paper upon the data of ethics, with special reference to Mr. Herbert Spencer's views, was read by Prof. Wace.

PARIS

Academy of Sciences, May 17.—M. Edm. Becquerel in the chair.—The President presented the new edition of the works of Laplace, with letter from Laplace's granddaughter.—The following papers were read:—Meridian observations of small planets at the Greenwich and Paris observatories during the first quarter of 1880; communicated by M. Mouchez.—On saccharine, by M. Peligot. It is dextrogyrous, like ordinary sugar; its rotatory power, in Laurent's polarimeter, represented by 93° 5' (sugar, 66° 18'). Saccharine from starch-glucose, and that from crystallised levulose of lime, showed the same rotatory power. The essential character of saccharine is its relative stability and its inertia towards agents which act on other matters of the sugar group. It is much more easily got from crystallised levulose of lime than from inverted sugar or starch-glucose.—Researches on the proportion of carbonic acid in the air; second note by M. Reiset. He made (ninety-one) fresh experiments in the country from June to November last year, day and night, and the average obtained was 29.78 CO<sub>2</sub> in volume, for 100,000 dry atmospheric air at 0° and 760 mm.; (this closely agrees with the figure 29.42 he got in 1872-73). He describes a new absorption apparatus, with the aid of which six or seven hours was sufficient to ascertain the yield of 600 litres of air. 28.91 was the average proportion of CO<sub>2</sub> for the day, 30.84 for the night. The maxima were in times of fog and mist; the average of twelve such cases was 31.66; the absolute maximum, 34.15, in a dense fog on September 3. He questions the accuracy of the method by which MM. Levy and Allaire found variations last year ranging from 22 to 36.—On the Furens dam, by M. de Lesseps. The dam of the Chagres (40 m. high) should be built on this type, and not cost over 25,000,000 fr.—M. Peters' death was announced.—On some nutritive effects of alkaline substances in moderate dose, from experimentation on man in good health, by MM. Martin Damourette and Hyades. The

substances tried were bicarbonate of soda (3 gr. daily) and Vichy water from the spring Elizabeth de Cnaset (0.5 to 1 lit. a day). So taken, they are trophic agents, and they diminish uric acid largely (though the former causes gastric disorders).—Position of the comet *b* of 1880, determined at Bordeaux Observatory, by M. Rayet.—On the transcendents which play a fundamental rôle in the theory of planetary perturbations, by M. Callandreau.—On the number of cyclic groups in a transformation of space, by M. Kantor.—The tensions of saturated vapours have different modes of variation according as they are emitted above or below the point of fusion, by M. de Mondesir. The passage through the point of fusion always gives a variation at least four or five times greater than that found in two liquids in an equal thermometric range.—On the interversion of temperatures of the air with the height, by M. André. This is shown to occur (under like conditions) within much shorter vertical distances than those indicated by M. Alluard.—On the freezing mixtures formed of an acid and a hydrated salt, by M. Ditté. In such a mixture the cooling is not due to simple dissolution of the salt; there is always a double decomposition, conformably to the law of maximum work. The salt containing much water, this separates out, and the change of state absorbs the heat liberated by the reaction, borrowing from the liquid itself the surplus of energy necessary to its complete accomplishment. Hence results a considerable lowering of temperature.—Influence of alkaline or acid media on the life of crayfish, by M. Richet. Acid or basic liquids are not poisonous in the direct ratio of their acidity or basicity. With equal weight nitric acid is five times more toxic than sulphuric acid, and twenty-five times more than acetic acid. Generally bases have a more lufitful action than acids. The least toxic is baryta; a crayfish will live two or three hours in water containing 3 grs. of it per litre. Soda and lime are fatal in two or three hours in proportion of 1.5 grs. per litre; potash in one of 1 gr. Ammonia, however, is the most poisonous of all; in the proportion of 0.8 gr. per litre, its action is almost instantaneously fatal. It is thirty times more toxic than baryta, and fifteen than soda.—On some of the conditions of cortical excitability, by M. Couty. The movements caused by faradisation of the brain seem to vary like the less complex contractions caused by faradisation of the central end of the sciatic, pointing to a common origin of the two orders of movements in the same bulbo-medullary elements.—Local and general anæsthesia produced by bromide of ethyl, by M. Terrillon. The substance seems especially suited for short operations not requiring complete muscular resolution. It acts rapidly, is less dangerous than chloroform, and the awaking is not disagreeable.—Variations of urea in poisoning by phosphorus, by M. Thibaut.—Influence of the fattening of animals on the constitution of fats formed in their tissues, by M. Muntz. In animals submitted to a fattening process the fat is always poorer in solid fatty matters.—On the fixity of composition of plants; analysis of *Soya hispida*, or Chinese oleaginous pea, by M. Pellet.—On the respiratory and circulatory apparatus of some larvæ of diptera, by M. Viallanes. The heart of insects is at first a simple tube open only at its two ends. So long as it has no lateral orifices it is completely arterial.

CONTENTS

	PAGE
MATHEMATICAL JOURNALS. By J. W. L. GLAISHER, F.R.S. . . . .	73
OUR BOOK SHELF:—	
Edwards's "Six Life Studies of Famous Women" . . . . .	75
LETTERS TO THE EDITOR:—	
Lord Rosse's Telescope.—Lord Rosse, F.R.S.; OTTO STRUVE . . . . .	75
Brain Dynamics.—GEORGE J. ROMANES, F.R.S. . . . .	75
The Inevitable Test for Aurora.—PIAZZI SANTI . . . . .	76
Variability of 60 Cancri.—JOHN BIRMINGHAM . . . . .	76
Notes of the Cuckoo.—JOHN BIRMINGHAM . . . . .	76
Fall of Dust . . . . .	76
Monkeys in the West Indies.—D. G. G.; JOHN IMRAY . . . . .	77
The Recent Volcanic Eruption in Dominica.—EDMUND WATT . . . . .	77
Cup Stones, Cup-Marked Stones, or Cups and Rings.—R. MORTON MIDDLETON, JUN. . . . .	77
A Double Egg.—T. ALLWOOD . . . . .	78
COMPARATIVE ANATOMY OF MAN, II. By Prof. FLOWER, F.R.S. . . . .	78
ON SYSTEMATIC SUN-SPOT PERIODICITY. By Prof. BALFOUR STEWART, F.R.S. . . . .	80
PRIMITIVE MAN (With Illustrations) . . . . .	82
THE HYDROGRAPHIC DEPARTMENT . . . . .	86
NOTES . . . . .	86
OUR ASTRONOMICAL COLUMN:—	
The Late Prof. Peters . . . . .	88
Minor Planets . . . . .	89
Comet 1880, II. . . . .	89
PHYSICAL NOTES . . . . .	89
GEOGRAPHICAL NOTES . . . . .	90
UNIVERSITY AND EDUCATIONAL INTELLIGENCE . . . . .	90
SOCIETIES AND ACADEMIES . . . . .	91

THURSDAY, JUNE 3, 1880

## SIGN LANGUAGE AMONG THE AMERICAN INDIANS

*Introduction to the Study of Sign-Language among the North American Indians, as Illustrating the Gesture-Speech of Mankind.* By Garrick Mallery. (Washington: Government Printing Office, 1880.)

UNDER this modest title another of those valuable contributions, which we owe to the Smithsonian Institution, has been made to science. Researches into the ethnography of the North American Indians have been going on for the last eleven years under the superintendence of Mr. J. W. Powell, and a series of compact and beautifully-printed monographs has lately been started for the purpose of aiding and directing them. The monograph just issued forms the second of the series hitherto published, and in spite of its title is full of new and interesting matter. It will be appreciated not only by those who are actually engaged in observing the life and manners of barbarous tribes, but also by every student of language and anthropology.

The evidence that has been accumulating for some time past makes it probable that the most important part of language, its grammatical machinery, originated in gestures and signs. These were the means whereby sense and meaning were imported into spoken words. As Col. Mallery remarks: "A child employs intelligent gestures long in advance of speech, although very early and persistent attempts are made to give it instruction in the latter but none in the former; it learns language only through the medium of signs; and long after familiarity with speech, consults the gestures and facial expressions of its parents and nurses as if to translate or explain their words." An examination of the sign-language or languages of mankind consequently becomes of high importance, and it is strange that no thorough and scientific attempt to undertake it has hitherto been made. Leibnitz indeed, with the instinct of genius, pointed out the need and importance of such an investigation (in his "Collectanea Etymologica," ch. 9), but his words met with no response. It is therefore all the more satisfactory to find that the subject has at last been taken up in America, where special opportunities still exist for collecting materials, notwithstanding the rapid decrease in the native population that seems to have been going on of late years. North America has always been the country where a language of signs was pre-eminently in vogue. Col. Mallery says with justice that "the words of an Indian tongue, being synthetic or undifferentiated parts of speech, are in this respect strictly analogous to the gesture elements which enter into a sign-language." Just as a single idea or mental picture is represented by a connected group of individual gestures, so too it is expressed in the polysynthetic speech of the Red Indian by a group of individual syllables which form but one word.

The first question we have to ask ourselves is whether sign-languages are the same all over the world, whether each idea or group of ideas has a fixed and natural gesture or sign corresponding to it everywhere. To this

question the researches made among the American Indians furnish a conclusive reply. "The alleged existence of *one* universal and *absolute* sign-language is, in its terms of general assertion, one of the many popular errors prevailing about our aborigines." Many signs are purely conventional, while many ideas or objects may be denoted by more than one sign. The signs used by the different Indian tribes to indicate the same ideas by no means agree together, nor do they always agree, so far as I know, with the signs employed for the same ideas in the Old World, whether by savages or by deaf-mutes. The curious language of signs employed in monasteries where the rule of silence was strictly observed, which is given by Leibnitz, if compared with the lists of signs furnished by American explorers, is a good example of the fact.

At the same time no signs can be so arbitrary and conventional as spoken words, nor can an idea be expressed by so many different signs as it can be by different sounds. Col. Mallery observes that "further evidence of the unconscious survival of gesture-language is afforded by the ready and involuntary response made in signs to signs when a man with the speech and habits of civilisation is brought into close contact with Indians or deaf-mutes. Without having ever seen or made one of their signs, he will soon not only catch the meaning of theirs, but produce his own, which they will likewise comprehend, the power seemingly remaining latent in him until called forth by necessity. The signs used by uninstructed congenital deaf-mutes and the facial expressions and gestures of the congenitally blind also present considerations under the heads of 'heredity' and 'atavism,' of some weight when the subjects are descended from and dwell among people who had disused gestures for generations, but of less consequence in cases such as that mentioned by Cardinal Wiseman of an Italian blind man who, curiously enough, used the precise signs made by his neighbours."

But care must be taken to distinguish between two things which are frequently confused together. Gestures and signs are wholly different, gestures being natural signs more or less conventional. A gesticulation is a gesture which has become a sign, and the nearer signs approach to gesticulations the more readily and instinctively they will be understood.

Those who wish to know what the Indian sign-language is will find plenty of interesting and suggestive examples in Col. Mallery's *Introduction*. He has added a list of his authorities as well as a speech in signs addressed by a medicine-man of the Wichitas to Mr. A. J. Holt, and a story in signs told by Natshes, the Pah-Ute chief, to Dr. W. J. Hoffman. These curious specimens of sign-language will show what it is more effectually than any description could do, and will justify the analysis and classification of the signs proposed by Col. Mallery.

In conclusion, aid and suggestions are asked from all interested in the subject, or who are in actual contact with savage and barbarous tribes. A list of words is appended for which the corresponding signs are wanted, those of chief importance being marked by an asterisk. We hope that the ethnographical department of the Smithsonian Institution will meet with all the assistance in this undertaking to which it is entitled. There must be many observers among the uncivilised races of the Old World

or in schools for deaf-mutes who have many facts of interest and value to contribute. It is only when these facts have all been gathered in that it will be possible to reconstruct that primitive speech of mankind which preceded articulate utterance, which formed the bridge to spoken language and expressed the earliest thought of the human race.

A. H. SAYCE

### TESTING TELEGRAPH LINES

*Instructions for Testing Telegraph Lines and the Technical Arrangement of Offices.* By Louis Schwendler. Vol. ii. Second Edition. (London: Trubner and Co., 1880.)

THE second volume of this useful work is free from the defects which disfigured the first volume, and which we were bound to find fault with (*NATURE*, vol. xix, p. 192). This is doubtless due to the watchful eye and careful hand of Prof. McLeod, who has nursed it through the press and added some useful notes. It contains a very full and clear description of Mr. Schwendler's modification of the tangent galvanometer, by which quantitative electrical measurements of batteries, lines, and apparatus are more rapidly though more roughly made than with bridges and coils. Such an instrument is very extensively employed in England and America, but Mr. Schwendler has certainly improved its efficiency by combining certain resistances with it and making it more portable. It is remarkable what a handy and useful instrument this becomes, and what a valuable help it is to the telegraph engineer. Mr. Preece mentioned at the Society of Telegraph Engineers the other evening that it frequently happened over the extensive system of the Post Office—120,000 miles of wire and 12,000 instruments—that the daily bill of health showed not one single fault existing, and this he attributed principally to that accurate system of testing which has been in use in England for nearly twenty years. Mr. Varley introduced this system in England and in America also, where it is very extensively employed. It is a pity that Mr. Schwendler has not made himself better acquainted with the systems in use in other countries, for the perusal of his book leaves the impression that he thinks he has inaugurated a new system in India, whereas he has only modified existing systems to suit the requirements of the Indian service. Again this desire to be individual is shown by the adoption of that most unnecessary nomenclature of unit current, the "Oersted." Unit current is now universally known as the "Weber," and though some confusion has occurred as to whether unit current should be "webers per second," or simply "weber," nevertheless "webers" and that useful sub-multiple "milliwebers" are now used all over the world, except in India. Custom only has forced the terms *volt*, *ohm*, *farad*, *weber* into use. He would be a bold man who would attempt to convert "Ohm" into "Schwend," yet Mr. Schwendler would convert "Weber" into "Oersted." There is no doubt that Mr. Latimer Clark, who is the author of the recognised nomenclature, proposed the term "weber" for unit quantity, but as any term applied to unit quantity, excepting that based on unit capacity or "farad," is not wanted, and unit current is unit quantity per unit time, "webers per second" has rapidly, by the silent linguistic

process of abbreviation, subsided into "webers," and webers it will remain. This strange habit of ignoring existing terms is shown in the definition of "intensity" (p. 40) as applied to a battery which is said to be the maximum current which a battery produces on short circuit. Now there is scarcely an English-speaking country where this property is not known as "quantity," though this term is carefully excluded from all books from its eminently unscientific character. Nevertheless it is so rooted in telegraphic circles that there is scarcely a line-man in all England that does not use it. Again, those currents which every one knows as "earth currents" are called in India "natural currents" (p. 53). Moreover we have the strange anomaly that sometimes the author uses *Siemen's units*, sometimes *ohms*, sometimes *S.U.*, and sometimes *B.A.U.*, to designate units of resistance.

The battery used in India is the Minotto form of Daniell—a very wasteful cell, and giving for line purposes an internal resistance of 30 ohms! In dry climates where the circuits are long such a battery may be useful, but in damp climates, like England, where the circuits are comparatively short, such a battery is impossible. The Minotto cell is, however, very constant in its electromotive force; and Mr. Schwendler's instructions for its maintenance are very clear and complete.

The principal portion of the book is devoted to a description and mode of construction and examination of the instruments in use in India and their connections. Mr. Schwendler has introduced a useful test called the "range test," by which those currents are recorded between which the instrument will work without any re-adjustment. Thus the range test of a Siemen's relay is 25. In other words, whether the current used be '001 or '025 weber, or any current of intermediate strength, the relay will equally work. An instrument that will stand such a test must be quite free from friction in its points or from residual magnetism in its iron core. The working currents in India never exceed 8 milliwebers nor fall below 2 milliwebers. Hence if a relay fulfil the above test it never wants adjustment. This is certainly "a consummation devoutly to be wished" by all telegraphists.

We observe the following interesting instruction: "On no account are relays to be exposed to the direct rays of an Indian sun. The permanent magnet is sure to lose its magnetism perceptibly, and consequently the relay will become insensitive." Is this due to the light or to the heat of the sun? His notions of the efficiency of lightning protectors are rather heterodox. "All," says he (p. 195), "that can be said of them at present is, that if they are kept clean they do no harm;" yet he gives a very clear description of those in use. He attributes to Steinheil, in 1846, the first lightning discharger; but Highton, on the London and North-Western Railway, before this, rapt the wire for eight inches on each side of the instrument in fibulous paper and surrounded it with a mass of metallic filings placed in a tin lined box in connection with the earth.

Very excellent descriptions are given of different forms of relays and of various plans devised for reducing the effects of induction, notably Mr. W. P. Johnston's electromagnetic shunt. Indeed the work is an admirable description of telegraphy in India, and it is one which should be in every electrician's library. There are

many telegraph administrations which would be benefited by its clear practical character. But it is not immaculate. The chief defect of the book is the absence of recognition of what has been done elsewhere and the negation of existing literature dealing with the same subject. Mr. Latimer Clark's book on "Electrical Measurement" (published in 1868) was written especially for use in India. His "Electrical Tables and Formulae," written in conjunction with Mr. Sabine and published in 1871, contains nearly all that is known of testing. Culley's "Handbook," first published in 1866, has run through six editions. Hoskier's "Guide to Electric Testing" was published in 1873, and has reached a second edition. Prece and Sivewright's "Text-book of Telegraphy" was published in 1876, and has also reached a second edition. Kempe's "Handbook of Electric Testing" (a most useful and valuable little work) was also published in 1876. Papers by Fleming Jenkin, Siemens, F. C. Webb, Hockin, Heaviside, &c., are scattered everywhere; yet the impression left on the mind after perusing Mr. Schwendler's book is that, according to him, there is but one system of testing, and that is to be found in India; and there is but one book on the subject, and here it is!

#### OUR BOOK SHELF

*A Physical, Historical, Political, and Descriptive Geography.* By Keith Johnston, F.R.G.S. Maps and Illustrations. (London: Stanford, 1880.)

THIS work is in every way creditable to its unfortunate young author, who, our readers may remember, succumbed some months ago to the hardships of African travel while leading an expedition from the West Coast towards Lake Tanganyika. Mr. Johnston has not sought to enter into that minute and often painful detail with which we are familiar in most text-books of geography. His object has been to record in each of the great departments of geography the results of the latest research, leaving it to the teacher or to special text-books to fill up with details. After a brief sketch of some of the main points in mathematical geography, a clear and sufficiently full sketch of historical geography is given, treating not merely of the progress of discovery, but of the various movements of peoples and nations which have led up to the political divisions of the earth as they are at present; this we think a useful introduction of scientific method into history. Then follows a section on physical geography, in which the most trustworthy results of research in the various departments of this subject are stated with clearness and accuracy. The remaining two-thirds of the work is devoted to the special geography of the various continents and countries—their physical features, natural history, products, industries, peoples, and political and social conditions. The same method is followed throughout of dwelling only upon the important features. The work is amply illustrated by useful and beautifully executed maps, and is one of the best general handbooks of geography that we know.

*Zeitschrift für das chemische Grossgewerbe.* iv. Jahrgang. Von Jul. Post. Fortgesetzt von Arthur Lehmann. (Berlin: Oppenheim, 1880.)

WE have already had occasion to draw attention to the merits of this publication, and the present issue of the work is in no way inferior to its predecessors. It constitutes a complete compendium of the progress of chemical technology during the past year, and as such must be of great service to our manufacturers. The various articles are contributed by acknowledged authorities, and the whole is preceded by a short review indicating the more

striking improvements which have been introduced into the chemical arts since the publication of the last issue of the work.

#### LETTERS TO THE EDITOR

[The Editor does not hold himself responsible for opinions expressed by his correspondents. Neither can he undertake to return, or to correspond with the writers of, rejected manuscripts. No notice is taken of anonymous communications.]

[The Editor urgently requests correspondents to keep their letters as short as possible. The pressure on his space is so great that it is impossible otherwise to ensure the appearance even of communications containing interesting and novel facts.]

#### The Lesser Spotted Woodpecker

I HAVE had an opportunity lately of observing closely the habits of the Lesser Spotted Woodpecker (*Picus minor*) as regards the very peculiar sound which it makes upon trees by the action of its bill.

It is quite certain that this habit has nothing whatever to do with the quest for food. The bird selects one particular spot upon the trunk or bough of a tree, which spot is naturally sonorous from the wood being more or less hollowed by decay. The bird returns to this precise spot continually during the day and produces the sound by striking the wood on the spot with its bill, the stroke being repeated with a rapidity which is really incomprehensible; for it quite eludes the eye. It is effected by a vibratory motion of the head; but the vibrations are so quick that the action looks like a single stroke. After short pauses this stroke is again and again renewed, sometimes for several minutes together. During each interval the woodpecker looks round it and below it with evident delight and with an apparent challenge of admiration. The beautiful crimson crest is more or less erected.

The whole performance evidently takes the place of the vernal song in other birds; and so far as I know it is the only case among the feathered tribes in which vocal is replaced by instrumental music.

The nest does not appear to be in the same tree; but similar spots are selected on several trees in the neighbourhood, and as the sound is very loud and is heard a long way off, the hen bird when sitting is serenaded from different directions.

I have not seen or heard any attempt to vary the note produced by variations either in the strength or in the rapidity of the stroke, or by changing the point of percussion; but I have observed that the note varies more or less with the tree on which it is produced.

During about six weeks the performance has been frequent every day, and early in the mornings during part of this time it was almost constant. Of late it has been discontinued. In all probability this is parallel to the well-known fact that singing birds cease to sing after the eggs are hatched.

This instrumental substitute for singing among the woodpeckers is extremely curious.

ARGYLL

May 29

#### Mr. Preston on Vortex Atoms

SOME passages in an article in *NATURE*, vol. xxii. p. 56, on Sir William Thomson's theory of vortex atoms, seem to show that the author, Mr. Preston, has not perfectly apprehended the nature of vortex motion. On p. 57 he says that "the rotating portion" of the liquid "therefore glides smoothly over the incompressible liquid that surrounds it like a pipe." From this it appears that the vortically-moving fluid is conceived by him as slipping with reference to the rest of the fluid. This is, however, an incorrect view of the nature of the motion. If there be an infinite mass of fluid, then the stable existence of a vortex filament at any part necessitates motion throughout the whole, and there is, at the surface bounding the filament, no discontinuity of the kind apparently conceived by Mr. Preston.

Two vortices exercise very remarkable influences on one another, which are due to the irrotational motion of the parts of the fluid outside the vortices.

The existence of surfaces of finite slip in the hydrodynamics of an ideal perfect fluid is not precluded by any quality attributed to the fluid, but I do not think that the behaviour of vortices bounded by surfaces of slipping has been hitherto treated by any mathematician.

It does not seem likely, however, that the investigation would lead to interesting physical results, because this kind of motion is essentially dynamically unstable.

Towards the end of the same article there occurs the following passage:—

"The old idea that a ship (or more correctly a totally immersed body, such as a fish) encountered a mysterious resistance in addition to the mere friction of the molecules on its sides, is now known to have been a pure delusion."

This statement appears to me either erroneous or very misleading. The resistances to the motion of a ship have been classified under three heads, viz., wave-making resistance, eddy-making resistance, and surface-friction.<sup>1</sup> For a totally-immersed body the wave making resistance is non-existent, but Mr. Preston would appear only to take notice of the last of the three. Now whilst for a body with "fair lines," such as a fish, the eddy-making resistance may be small, yet if the lines are not fair it may be very large. Thus a fish leaves scarcely any wake, whilst an oar leaves a very great amount of disturbance.

Helmholtz, Kirchhoff,<sup>2</sup> and Lord Rayleigh<sup>3</sup> have made some interesting hydrodynamical investigations on the resistance suffered by a vane exposed to a current, on the hypothesis that in the wake of the vane there is dead water, separated from the moving water by surfaces of finite slip.

It has been already noticed that such a motion is dynamically unstable, but there is in many respects a remarkable accordance between the resistance as determined by this theory and that found experimentally,<sup>4</sup> so that it seems probable that the actual stable motion of flow, with eddies in the wake, does not differ very much from the theoretically unstable motion, with dead water in the wake. It will be noticed that this theory of resistance, which gives approximate results for bodies with very bad lines, such as flat vanes, actually entirely neglects surface-friction, to which Mr. Preston's statement would seem to refer the whole resistance. G. H. DARWIN.

Trinity College, Cambridge, May 27

#### The Inevitable Test for Aurora

IN reference to Prof. Hazzi Smyth's courteous criticism of our communication to the Royal Society on the aurora borealis, we regret that we are unable to say whether the critical citation line, to which he directs attention, was present or not in the spectra of the electric discharges in atmospheric air from which we deduced the probable heights of auroral displays. The experiments quoted were made without reference to the aurora, and this particular line was consequently not sought for, nor indeed have many measurements been made of the spectra of discharge in atmospheric air, on account of the time required and consequent great consumption of the life of the battery which such observation entail.

73, Portland Place, W., May 29

WARREN DE LA RUE  
HUGO MÜLLER

#### Cloud Classification

THERE is a proverbial objection to "looking a gift-horse in the mouth," and M. Poey's Cloud Book is such a valuable addition to the scanty literature on the subject that it would be highly ungracious to make captious objections to his views. On the other hand, M. Poey, when he differs from others, puts forward his views with such fairness and courtesy that I believe he would be the last man to deprecate full discussion.

Allow me then to put in a plea for certain old public servants, that they should neither be cashiered altogether, nor transported to strange regions, without full examination into their character and their merits.

First, then, for the *stratus*.

M. Poey—happy man!—has carried on his observations under tropical skies, and in the clear atmosphere of Paris. Had his lot been cast on the clays and gravels of the London basin I venture to think that he would have regarded the "stratus" with more respect, if with no increase of affection. He would have had frequent opportunities of observing it—at times resting entirely on the ground,<sup>5</sup> at others rising with a clearly

<sup>1</sup> Froude, *Proc. of Roy. Inst.*, December, 1876.

<sup>2</sup> "Math. Vorlesungen," 21st and 22nd lectures.

<sup>3</sup> "Mag." December, 1876.

<sup>4</sup> In particular Lord Rayleigh's investigation throws light on the theory of the balanced rudder.

<sup>5</sup> Howard's L'Isle says, "its inferior surface commonly" (not "invariably" or "necessarily") "rests on the earth or water." P. 7, Edit. 1823.

defined lower and upper surface, a few feet (or even inches) from the earth, cutting the taller trees in a horizontal line, leaving their tops and bottoms free, and then being gradually dissipated, to be absorbed in the warmer air or to form *cumulû* at a higher elevation. He could hardly have failed to recognise it as a clear and distinct variety of cloud, the lowest in altitude of all the family, but none the less a member of it. If every cloud which has contact with our baser earth is to be cashiered on that account, what will become of M. Poey's own cumulus on Plate XV. ? Every mountaineer knows to his cost that if he happens to be on the mountain where such a cumulus is resting, he will be enveloped in a fog undistinguishable from what he finds on the Thames marshes.

Whether, on the other hand, it is desirable to use the term "stratus" for clouds in a totally different sky-region, which differ both in their origin and their nature from the true "stratus," is a question too long to be fully discussed here.

Next with regard to the *nimbus*.

M. Poey's view appears to be that Howard's term applies to an isolated shower-cloud, and is unsuitable for a rain-cloud over-spreading the sky. After careful reading of M. Poey's remarks on the "pallium," and comparing them with Howard's description of the "nimbus," I entirely fail to see where lies sufficient difference to consign the "nimbus" to oblivion; and I can only imagine that M. Poey has taken his idea of what Howard meant almost entirely from the illustration, without noticing that Howard first describes the forming and behaviour of the cloud overhead in words curiously similar to those which Poey himself uses for his "pallium," and then says, "But we see the nature of this process more perfectly in viewing a distant shower in profile." This clearly shows that the illustration was only chosen as the easiest form in which the cloud, *vel nubium conjeries*, could be depicted, while the context guards completely against the name being limited to an isolated shower-cloud.

It would occupy too much space to place the descriptions of the two *servants* side by side, but I think that any one who will take the trouble to read the two together can hardly fail to see that Howard's "nimbus" fulfils all that Poey describes as the rain-discharging cloud, including the upper "veil," or pallium of cirrus, the lower "sheet," or "pallium" of cumulus, and the "lower clouds arriving from the windward," which "move under this sheet and are successively lost in it" (Howard, p. 11; compare Poey, Plate XII.). In fact, to use an expression frequently employed in the discussion of patents, you can take the description of the one inventor and "read it on to" the drawing of the other, or *vice versa*.

M. Poey's term "pallium" is certainly expressive, and will probably make itself a home in cloud terminology; but it appears after all only to mean that a certain modification over-spreads the whole or a large part of the sky (compare Howard, p. 11), and does not by any means cover that combination of cloud which produces rain ("nimbus.")

I must leave it to a future time or to other pens to discuss the merits of the "cumulo-stratus," and pass on to examine shortly M. Poey's views about the "cumulus." The Rev. W. C. Ley, in his review of M. Poey's work, in your pages, has already pointed out the illogical nature of the author's repeated remark that the "cumulus" only exists in the horizon, forgetting that a cloud which is on the horizon of one place must be in the zenith of another. Now I venture to suggest that this curiously-distorted mental view affects M. Poey's classification far more than appears at first sight. If clouds are considered not objectively according to their whole form and structure, but subjectively as they present themselves to an individual observer, we naturally need new modifications as the cloud are viewed in different positions. Are not many of the clouds which M. Poey calls "fracto-cumulus" simply "cumuli" viewed from beneath? Just as (to borrow a simile from Mr. Ley) an elm-tree seen from beneath presents a spreading, ragged edge, and shows the blue sky through its interstices, whereas on the horizon it appears compact, rounded, and sharply defined.

May I add a practical suggestion as to the popular terms proposed by M. Poey on p. 39? These terms are put forward as an alternative to the scientific Latin names, for the use of non-scientific observers, who may be of great service in collecting information at out-stations where no trained meteorologist is at hand. It is therefore all-important that they should be as short,

<sup>1</sup> See Poey, p. 33.

<sup>2</sup> "At a greater altitude a thin light veil," &c., Howard, p. 11, and again, "supreme cirrata," p. 4.

<sup>3</sup> "The lower clouds . . . form one uniform sheet," p. 1.



plain, and simple as possible, conforming as nearly as may be to the popular terms in use, and above all that there should be nothing to mislead an ignorant person. Now I would ask what idea is conveyed to an ordinary unscientific mind by the term "snow-sheet"? The name is perfectly correct if read in the light of M. Poey's explanation; but to an average lighthouse-keeper or coastguard it would certainly convey the idea of a so-called "pallio cumulus," ready to discharge snow, and would be used accordingly.

"Wind cloud" appears also distinctly misleading. To most minds it would, I believe, imply a cirrus or cirro-cumulus, as being the harbinger of wind. We have two excellent names in common use—"scud" and "rack,"—either of which would serve.

"Stratified cloud" is a very vague term, applicable to many varieties besides "cirro-stratus."<sup>1</sup>

Objections might also fairly be raised against "Belt cloud," as compared with the familiar "Noah's ark" which Poey himself quotes elsewhere, and to the "Globular tempestuous cloud," as a very cumbersome term, although a correct one.

It is to be hoped that all these details will be fully discussed before M. Poey's suggestions are either admitted into general use, or, on the other hand, too readily rejected. E. II.

Waltham-tow, Essex

NOTE.—The references are to Howard's *Essay on the Modifications of Clouds*, third edition, Churchill, 1865, and to Poey's *Comment on observe les Nuages*, Paris, 1879.

#### "Chipped Arrow heads"

IN a number of NATURE (vol. xx. p. 483) which only lately reached us here I read an interesting account of Mr. Cushing's researches into the manufacture of flint weapons as practised by aboriginal tribes; and as I have had many opportunities of observing the method by which the Fuegians of Magellan's Straits fashion their glass arrow-heads, a few words on the matter may not be without interest to some of your readers.

One of the indications of the increase of traffic through these Straits which has of late years taken place is that empty bottles are now to be found about the shores of those anchorages which are used by passing vessels as stopping-places for the night; and bottle-glass is consequently the material used by the Fuegians of the present day, to the exclusion of obsidian, quartz, or flint. The following is the process:—A fragment somewhat approaching to the shape of the intended arrow-head is grasped firmly in the left hand, while in the right hand is held an old iron nail stuck into a short wooden handle. The fingers of the closed right hand are turned upwards, and the point of the nail is directed towards the operator's breast. He then presses with great force the blunt point of the nail obliquely against the edge of the piece of glass, when a thin scale flies off towards him. One side of the edge having been bevelled in this way, the glass is turned round, and the opposite edge flaked off in a similar manner. Working the edges alternately in this way, the glass is readily brought to the required shape. The fashioning of the point is the most difficult part of the process, the formation of the barbs being easily effected.

I have seen a native thus make a large arrow-head out of a piece of broken pickle bottle in about half an hour. The glass is never struck, but is fashioned entirely by pressure. After a little practice I succeeded in making fair imitations.

I find, moreover, that the iron tool above mentioned can be dispensed with, and that the flaking may be effected by pressing with an angular flint or with a piece of bone, which were probably the methods used by the Fuegians before they possessed any iron implements.

K. W. COPPINGER

H.M. Surveying Ship *Aleri*, Swallow Bay, Straits of Magellan, March 21

#### Cup and Ring Stones

IN reply to Mr. Middleton's letter I beg to say that the Ilkley cup and ring stones have been carefully described and illustrated in a paper read by me before the Brit. Archæolog. Assoc. (see *Journal B. A. A.* for 1879, p. 93).

Further information will be found in Sir Jas. Simpson's work on the subject, which forms the appendix to vol. vi. of the *Proc.*

<sup>1</sup> I am not aware whether *Geschichtete Wolken* is an accepted term in Germany. In the Bernese Oberland a very expressive name is used, *Gestreifte Wolken*, only too well known to mountaineers.

Soc. Ant. Scot., and in Prof. Boyd Dawkins' "Early Man," p. 338.

In a large number of instances cup and ring marks have been found on the stones of cists, stone circles, and menhirs. It would therefore appear that they are connected with sepulchral rites. Cup marks are found in Scotland, Ireland, Wales, Northumberland, Yorkshire, Cumberland, Lancashire, Switzerland, Sweden, and India (see Rivett Carnac's papers in *Journal of Asiatic Society of Bengal*, 1878-9). I should be glad of evidence of their existence in Derbyshire and elsewhere in the South of England.

J. ROMILLY ALLEN

23, Maitland Street, Edinburgh

#### Songs of Birds

CAN any musical reader of NATURE transcribe for me the notes of the king lorry (*Aprosinectus scapulatus*)? May not the *major* and *minor* keys of the cuckoos noticed by John Birmingham be sexual characteristics? The males are believed to exceed the females in number in the proportion of four or five to one, and, if this be so, the male note must be heard more often than the female. The "jerkiness of style" in the *major* cuckoo, as described, suggests that the performer is a female. A. N.

C. W. HARDING.—The teeth belong to a young horse—not yet "in mark" (*Equus caballus*). Their geological horizon appears uncertain, and they are as likely to be historic or prehistoric as pleistocene.

#### COMPARATIVE ANATOMY OF MAN<sup>1</sup>

##### III.

*Modifications of the Negro type.*—At several parts of the equatorial region of Africa, from the Gulf of Guinea to the White Nile, indications have been met with of a small race of negroes, sometimes so small that the name of pygmy may truly be applied to them, differing from the ordinary negro in the short rounded form of the head. These bear some resemblance to the diminutive members of the oceanic black races who inhabit some parts of the East Indian Archipelago, especially the Andaman Islands, and to whom the name *Negrillo* is now generally applied, and Dr. Hamy, who has collected together all the evidence at present accessible as to their existence, has proposed to distinguish them by the term *Negrillo*. The Akkas of Schweinfurth appear to belong to this race. In many districts they are more or less mixed with the ordinary negroes, and their physical characters are therefore obscured, but some skulls from the West Coast of Africa in the collection of Dr. Barnard Davis bear a striking resemblance to those of the Andamanese, and have a cephalic index of 80 or upwards.

The greater part of Africa, between the equator and the most southern parts, where the Hottentots and Bushmen dwell, is inhabited by negroes, who for linguistic reasons are grouped together, and separated from the more northern tribes, and are now generally known to ethnologists by the name of *Bantu*. Their range seems to have extended southwards in comparatively recent times, encroaching upon that of the original inhabitants. They are a pastoral people, warlike, energetic, and intelligent, owning large herds of cattle, and living in villages composed of a number of beehive-like huts. The southern Bantu, who at present are the best known, from their vicinity to the British and Dutch settlements of South Africa, are divided by Fritsch into 1. The Ama-Xosa, who inhabit at present the south-east portions of the Bantu territory, adjoining the sea, between the Cape Colony and Natal. To these the name *Kaafir*, derived from an Arabic word applied to them as unbelievers or heathens, is commonly given, but the name is sometimes used in a wider sense for the Bantu negroes generally. The Ama-Xosa include the well-known tribes of Gaikas and Galeikas, with whom we were at war in 1877. 2. The Ama-Zulu,

<sup>1</sup> Abstract Report of Prof. Flower's lectures at the Royal College of Surgeons, March 1 to March 19, on the Comparative Anatomy of Man. Continued from p. 80.

situated to the north of these, in Natal and Zululand. 3. The Bechuanas, occupying the central or inland country; and 4. The Ova-hereros, or Damaras, of the western coast-lands. Each of these divisions is composed of numerous small tribes, frequently at war with each other, and constantly changing in relative importance and even locality. The growth of the Zulu nation is a striking example of the mutable character of native African political combinations. At the commencement of the present century they were an extremely insignificant tribe, but by the military and political genius of their chief, Chaka, who conquered and absorbed all the neighbouring tribes, a powerful kingdom was formed, which was consolidated by his successors, Dingaan, Panda, and Ketchwhy, under whom, however, it has been destroyed by the superiority of European weapons and organisation, at what cost we know too well. Five crania of Zulus who were killed in the fatal battle of Isandhlwana, on January 22 of last year, have already reached the museum, through the kindness of Mr. Fynn, a magistrate in Natal, Col. Mitchell, the Colonial Secretary, and Dr. R. J. Mann, and their uniformity of characters is such that they probably are very fair average specimens of the race. They are the skulls of large, powerful men in the prime of life. The capacity of their cranial cavity is remarkable, far above that of the ordinary negro, even above that of the lower class of Englishmen, the average of the five being 1,580 cubic centimetres. One measures as much as 1,745. Their average latitudinal index is 75.1, their altitudinal index 76.6. Their orbits are remarkably small and low; index 81.7. The form of the nasal bones and nasal index (60.7) is characteristically negroid, but they differ from ordinary negroes in two important points. They are not truly prognathous, but mesognathous, the alveolar index (100.4) being intermediate between that of the negro and the European, and their teeth are small, the index being only 40.7. The crania of other Zulu and Kafir tribes previously examined give similar results, especially a larger cranial capacity and a less degree of prognathism than is found in the equatorial negro.

Another great division of South African people comprises those popularly known as Hottentots and Bushmen, or in their own language Koi-Koin. They formerly inhabited a much larger district than at present; but, encroached upon by the Bantu from the north and by the Dutch and English from the south, they are greatly reduced in numbers, and indeed threatened with speedy extinction. The Hottentots are at present divided into three principal groups—the Namaquas, Korannas, and the Griquas. The latter especially are much mixed up with other races, and, under the influence of a civilisation which has done little to improve their moral condition, they have lost most of their distinctive peculiarities. The pure-bred Hottentot is of moderate stature, has a yellowish-brown complexion, very frizzly hair, which, being less abundant than that of the ordinary negro, has the appearance of growing in separate tufts. The forehead and chin are narrow and the cheek-bones wide, giving a lozenge-shaped visage. The nose is very flat and the lips prominent. The women are often remarkable for immense accumulation of fat upon the nates, called *steatopygy*, and also of great elongation of the nymphæ and of the *preputium clitoridis*. In these anatomical peculiarities, and in almost everything else except size, the Bushmen agree with the Hottentots. In fact they appear to be a stunted, outcast branch of the same race living the life of the most degraded of savages among the rocky caves and mountains of the lands where the comparatively civilised and pastoral Hottentots dwell in the plains. Their usual appellation is derived from the Dutch *Bosjesman*, or "man of the woods," and they have been regarded both by Kafirs and Boers as something only half human, and have been treated accordingly,

and nearly exterminated. Notwithstanding their generally low condition of culture, they show remarkable pictorial power, drawing animals especially with life-like accuracy. The osteological characters of the Bushmen are tolerably well illustrated in the museum both by skeletons and crania. Their average height would appear to be from 4 feet 6 to 4 feet 8 inches, and there is very little, if any, difference between the men and women in this respect. The form of the skull is extremely characteristic, and could scarcely be mistaken for that of any other race. It has generally a very feminine, almost infantile appearance; though the capacity of the cranial cavity is not the smallest, exceeding that of the Andamanese and the Veddahs of Ceylon. In general form the cranium is rather oblong than oval, having straight sides, a flat top, and especially a vertical forehead, which rises straight up from the root of the nose. The lower occipital region is greatly developed, in marked contrast to that of the Andaman islanders. They are moderately dolichocephalic or mesocephalic, the average of ten specimens being 75.4. The height is in all considerably less than the breadth, the average index being 71.1, so that they are decidedly low skulls. The zygomata are little developed, the malars project forwards about as much as in the Mongolian races, giving a nasi-malar angle of 140°. The glabella and supra-orbital ridges are little developed except in the oldest males. The orbits are elongated and low (average index 81.4), the space between the orbits very wide and flat, there being no depression at the root of the nose. A large portion of the ascending process of the maxilla is visible on each side of the nasals. The nasal bones are extremely small and flat, and the aperture wide; the average nasal index being 60.8, so that they are the most platyrhine of all races. On the other hand they are rarely prognathous. In this, and some other characters, there is much that recalls the infantine condition of the true negro.

*Inhabitants of North Africa.*—The whole of the various populations inhabiting the portion of Africa north of the Sahara Desert, from the Atlantic coasts as far south as the River Senegal on the west to the Red Sea on the east, belong to a completely different type of mankind from that which we have been last considering, and, as before mentioned, the boundaries between the two types coincide remarkably with those of zoological regions, as indicated by distinct characters of the fauna. As must naturally have happened during the vast length of time during which the people of Northern Africa and the negroes have occupied contiguous regions since the drying up of the Sahara Sea, with absolutely no physical barrier between them, considerable intermixture has taken place along the frontier line, and even for some distance into the territories of each at certain points. In the east, especially, the superior northern race has encroached far southwards, and the practice, which has existed from the most ancient times down to our own, of importing the negroes into the northern country as slaves and soldiers, has given rise to a considerable modification of the type in certain districts.

Besides the negro element which has thus partially and locally modified the characters of the inhabitants of Northern Africa, at least two other adventitious elements, although with differences small compared with those last named, appear to have come into the district and assisted to diversify the physical type. The evidence on which the first of these rests is rather shadowy; but to account for the considerable number of individuals especially in Morocco, who depart at least in colour from the prevailing North African type, and have fair complexions, eyes, and hair, an immigration of a northern race is supposed; and as all such immigrations within the strictly historic period, such as that of the Vandals (A.D. 500) have been on too small a scale or too temporary to effect such a permanent change in a considerable portion of the

population, and as there is evidence from Egyptian monuments of fair people (the Tamahou) inhabiting North Africa, to the west of Egypt, at least 1500 years B.C., this race has been associated with the builders of the megalithic monuments found scattered over the west of Europe and the north-west of Africa, who are supposed to have invaded Africa by way of Spain and Tangiers. The invasion of the country by Semitic races from the East, the Phœnicians and Carthaginians, and more recently the Arabs, who overspread North Africa by way of the Isthmus of Suez in the seventh and tenth centuries, and impressed the Mohammedan religion upon all these regions, rests upon surer historical evidence. The basis of the population of Morocco, Algiers, and Tunis are the Berbers, descendants of the Libyans or *Lebou* of the ancient Egyptians. An important section of them are the Kabyles of the French. They are mostly a settled and pastoral people. The Moors are mixed descendants of Arabs and Berbers, residing in towns. The Bedouins are the Arabs who still lead a nomadic life in the desert. There is much in common in the physical characters of all these people, and indeed with those of the South of Europe and South-West of Asia. They belong mainly to the group called *Melanochroi* by Prof. Huxley.

The Berber type, which perhaps forms the basis of the population of North Africa, is thus described by Topinard, by whom it has been carefully studied. The height is slightly above the mean, 1.68m. *i.e.*, 5 feet 6.1 inches. The skin, white in infancy, quickly becomes brown by contact with the air; hair black, straight, and abundant; eyes dark brown; skull dolichocephalic (index 74.4), leptorhine (44.3), and moderately orthognathous. The face is less elongated and of a less regular oval contour than in the Arab. The straight forehead presents at the base a transverse depression; the superciliary crests are well developed; the nose is sunken at the base, often arched without being aquiline. The moral and social qualities of the Berbers are contrasted with those of the Arabs, considerably to the disadvantage of the latter.

The enterprising and commercial spirit of the Arabs has led to their extension over a very considerable part of Africa, along the north as far as Morocco, and down the east coast beyond Zanzibar, and once, in association with Berbers, and under the name of Moors, they effected a lodgment for a considerable period in Spain and the south of France. Physically they are a fine race. Their skull, seen from above, forms a perfectly regular oval. Their face, long and thin, forms another oval, with a not less regular contour, pointed below. Their colour is perfectly white until subjected to the action of the air, when it bronzes with facility. The hair and beard are smooth, and black as jet, the limits of their implantation are clearly marked: eyes black, the palpebral openings elongated, almond-shaped, and bordered with long black eyelashes; forehead not much elevated. The curve of the nose and retreating chin give to the profile a form rather rounded than straight. The superciliary arches and glabella little developed; the root of the nose is little hollowed, so that the forehead and the dorsum of the nose are almost in a straight line. The nose is aquiline, and its point detaches itself from the alæ and descends downwards, recurved like the beak of an eagle. The cheek-bones do not project; the mouth is small, the teeth white and vertical, the ears well made and rather small, and close to the head. The skull is subdolichocephalic (index 74.0), and the nose leptorhine, 45.5.

A branch of the North African people which has received much attention from anthropologists is that called Guanche, which formerly inhabited the Canary Islands, and which previous to the discovery and conquest of the islands by the Spaniards in the fourteenth century had long been isolated from all other people, and had attained to a peculiar civilisation of its own, preserving somewhat of the purity of type generally found

under such circumstances. The custom of embalming their dead in a mummified condition in rock sepulchres has permitted us to become acquainted with their physical characters. They were of small stature, and rather resembled the Berbers of the adjoining coast than any of the negro races. Their skull was of the mesaticephalic form, having an average cephalic index of 76.5, and was considerably lower than it was broad. The face was not prognathous, the nose was leptorhine, and at least those inhabiting the island of Teneriffe, who are best known to us, are remarkable for the low and elongated orbits, having, according to Broca, the lowest orbital index (77) of any race. In this respect and some others they resemble the ancient skulls of the reindeer period found in the cave of Cro-Magnon in the South of France, and it has been thought that they may be related to that race. It should be mentioned, however, that the Guanche skulls from Teneriffe in the collection of Dr. Barnard Davis do not altogether bear out this view, as they have a considerably higher orbital index than those measured at Paris.

Of all the people of North Africa the Egyptians are undoubtedly the most interesting. "When history begins to dawn, the first object the light strikes upon, and which for a long time alone rears its form above the general gloom, is the civilisation of ancient Egypt. On inquiry we find this thoroughly organised civilisation, fully supplied with all the necessaries and many of the embellishments of life, and which is alone visible in the dawning light, must have existed through ages long prior to the dawn. It recedes into the unfathomable depth of time far beyond the monuments and traditions." The valley of the Nile has been for thousands of years the scene of many events which have affected the ethnological characters of its population. Invasions and conquests more or less complete from the east, the north, the west, and the south; importation to its interior from all the regions around of prisoners and slaves in enormous numbers, many of whom have become permanent settlers and integral parts of the population: yet through all the lapse of years since the period from which the first evidence of the condition of man in that region has come down to us to the present day the mass of the population, through all the political vicissitudes which they have undergone, have presented the same general physical type. Notwithstanding the mixture of Semitic or Syro-Arabian nations, as in the Hyksos, who ruled in the Delta for nearly 500 years, and the Arabs of later times, the less important Phœnician, Jewish, and Greek immigration in the north, that of the Persians from the east, and Lybians from the west, and the Ethiopians from the south, the Copts and Fellahs of modern Egypt are the little changed lineal descendants of the subjects of the Pharaohs of the early empire. The physical characters of these are preserved to us fortunately by artistic representations, graphic and sculptural, and the still more trustworthy evidence of mummified bodies. Although there are considerable signs, as might be expected, of admixture with other races here and there, the general uniformity is striking, especially as it extends through so long a period of time. If variations appear at particular epochs the original type constantly reasserts itself, almost, if not quite, in its primitive purity.

In size the ancient Egyptians were not large, and rather delicately built; their hair was long, soft, straight, or wavy, and black; their cranium oval in form, and the average cephalic index is on the borders between mesaticephaly and dolichocephaly, and tolerably uniform in different series, collected and measured by different observers. Thus Morton gives the average of 43 specimens in American museums as nearly 75; Broca that of 81 crania at Paris as 75.58; while the average of 33 in the College museum is 75.4. Of the latter but one is as high as 80.7, and one as low as 69.6. Of the others, 20 are

above 75°0, or belonging to the mesaticephalic class, and 11 below 75°0, or dolichocephalic. The average altitudinal index is below that of the latitudinal, viz., 73°1. The average cranial capacity of the males is 1,454 cubic centimetres. They are almost as orthognathous as Europeans, and have teeth of the same comparatively small size, the dental index being in 7 male skulls 40·8, and in 8 females 41·2. The nasal index of 81 measured by Broca was 47·88, and this was found to be tolerably constant in mummies of different historical periods. The average nasal index of 25 in the College collection is rather higher, viz., 48·7. The orbital index of the same crania is 86·2. Of modern Copts unfortunately but few crania have been hitherto available for examination; but Broca gives the latitudinal index of 12 at 76°39, and the nasal index at 47°15.

The cranial and other characters of the Egyptians correspond in the main with those of the Berbers and other inhabitants of North Africa, and they must be placed in the same general category in any classification of the human race founded on anatomical characters. They have no affinities with the negroes, except such as may easily be accounted for by the occasional admixture of negro blood. Indeed it is almost remarkable that there are not more signs of this having taken place. Some authors have supposed a Turanian origin for the Egyptians, but if this term is to be taken in any sense as equivalent to Mongolians, there is absolutely no support for it in their osteological characters; all the characteristics of the Mongolian races are entirely absent in the Egyptian skull. Still less can any resemblance be seen to the Australian, whose skull, compared with that of an Egyptian, presents almost as great a contrast as can be found within the limits of variation of the human cranium. The angular form, limited capacity, wide zygomatic, projecting supraorbital ridges, short flattened nasals, wide nasal aperture with rounded inferior border, great alveolar prognathism, retreating chin, and immense teeth, characteristic of the Australian, are all wanting in the Egyptian. In fact the Egyptian belongs by all his anatomical characters to the type called by Blumenbach Caucasian. The much vexed questions, Who were the Egyptians? and Where did they come from? receive no answer from anatomical investigations, beyond the very simple one that they are one of several modifications of the great group of races which inhabit all the lands surrounding the Mediterranean Sea; that they here lived in their own land far beyond all periods of time measured by historical events, and that in all probability it was there that they gradually developed that marvellous civilisation which has exercised such a powerful influence over the arts, the sciences, and the religion of the whole of the Western world.

#### THE UNITED STATES WEATHER MAPS, SEPTEMBER, 1877

IN Canada and the United States during September, 1877, atmospheric pressure was everywhere above the normal except over a small triangular patch bounded by the Gulf of Fundy, Chesapeake Bay, and the entrance to Lake Superior. The deficiency was greatest in the North-Western States from Leavenworth to Lake Winnipeg, where it amounted to nearly the tenth of an inch, and on the coasts of the Gulf of Mexico, the deficiency at Mobile being 0·074 inch. Pressure was also under the normal over Greenland, the Atlantic, the Spanish Peninsula, Italy, nearly all Austria and Prussia, the whole of Russia and Siberia, except a patch stretching in a N.N.E. and S.S.W. direction about Lake Baikal. The centres of greatest depression were in the Atlantic between Greenland and the Azores, over a rather broad region

extending eastwards from Moscow to the Obi, and from Pekin northwards to Nertschinsk, the greatest depressions below the normals of these regions for September being respectively 0·112 inch, 0·130 inch, and 0·051 inch.

Pressures were above the normal over the whole of North-Western Europe, including Iceland, Sweden, Norway, Denmark, the Netherlands, France, and Germany as far as Pressburg, the greatest excess, 0·303 inch, occurring in the extreme north-west of the British Islands. But the most extensive region of unusually high pressure embraced the whole of Southern Asia, including Japan, China, except the extreme north, India, Syria, and also Egypt; and the whole of Australia, Tasmania, and New Zealand was also above the normal, and very considerably so, the excess at Devilquin, on the Murray River, reaching 0·265 inch.

The most remarkable disturbance in the temperature arising out of this abnormal distribution of pressure and the winds necessarily resulting therefrom, occurred over the whole of Europe, except Italy and the Spanish Peninsula. If the Weather Map be examined, it will be seen that from the west of the British Islands pressures steadily diminished on proceeding eastward over Europe, and along with this diminution of pressure pretty strong northerly winds prevailed, except in the two peninsulas already referred to, where winds were southerly and the temperatures consequently above the normal. Under the influence of these northerly winds the temperature of Europe from the North Cape southwards fell greatly below the average, a deficiency of 5°0 or upwards being experienced at the North Cape, Christiania, Memel, Gulyнки, Warsaw, and Prague. In Siberia, to the east of this cold region, southerly winds prevailed and high temperatures consequently ruled, the excess above the normal temperature being 6°·3 at Taschkent, 4°0 at Semipalatinsk, and 2°·5 at Jenisseisk and Irkutsk. Southerly winds also prevailed over Iceland and Greenland, raising the temperature above the normal, the excess on the west of Greenland being about 4°0, and in the north-west of Iceland 5°0. The Weather Map shows strong southerly winds also over Canada and the northern half of the United States, where consequently the temperature was high for the season, the excess being from 2°0 to 3°0, rising even at some places to nearly 4°0. Further south the excess was much less; and in some cases there was even a deficiency, as about Cape Hatteras, where northerly winds will be seen from the Map to have swept over that coast, and the temperature fell a degree and a half below the average; and along the upper reaches of the Arkansas and Red rivers, or to westward of the region of lowest pressure, where, winds being north-westerly, the temperature fell nearly a degree below the normal.

In India, pressure was unusually and continuously high from the beginning of the year, except in August, when it fell below the average over the region of the Lower Ganges and Assam. In September, however, pressure again became unusually high over all India, the excess being greatest along the northern coasts of the Bay of Bengal and the central districts from Visagapatam to Ajmere. In Assam the excess was considerable and the rainfall exceeded the average, whereas in Orissa, Western Bengal, and Berhar the rainfall was scanty. The excess above the normal pressure was also considerably less over Southern India and Ceylon than it was to northward; and with this distribution of the pressure occurred the memorable feature of the meteorology of India for the month, viz., an unusual strength of the south-west monsoon over the west of India from Goa southward, accompanied with an abnormally heavy rainfall on that coast, which extended eastward over the Deccan and the greater part of the Madras Presidency, and thus terminated the disastrous famine which had wasted Mysore and a large portion of the Madras Presidency during the previous two years.





CONTRIBUTIONS TO MOLECULAR PHYSICS IN HIGH VACUA<sup>1</sup>

THIS paper is a continuation of the Bakerian Lecture "On the Illumination of Lines of Molecular Pressure and the Trajectory of Molecules," read before the Royal Society, December 5, 1878. Phenomena there briefly referred to have since been more fully examined; new facts have been observed, and their theoretical bearings discussed; and numerous experiments suggested by Prof. Stokes and others have been tried, with the result of acquiring much information which cannot fail to be of value in assisting to evolve a theory capable of embracing all the phenomena under discussion.

Experiments previously described have shown that the molecular stream hypothesis is the correct one. According to this, the molecules of the residual gas, coming in contact with the negative pole, acquire a negative charge, and immediately fly off by reason of the mutual repulsion exerted by similarly electrified bodies. Were the individual molecules solely acted on by the initial impulse from the negative pole, they would take a direction accurately normal to the surface repelling them, and would start with their full velocity. But the molecules, being all negatively electrified, exert mutual repulsion, and therefore diverge laterally. The negative pole, likewise, not only gives an initial impulse to the molecules, but it also continues to act on them by repulsion, the result being that the molecules move with an accelerating velocity the further they get from the pole. The lateral divergence of the molecules, owing to their negative electricity, will naturally increase with the amount of charge they carry; the greater the number of collisions

the more the molecules lose negative charge, and the less divergent the stream becomes. This hypothesis is borne out by facts. When the vacuum is just good enough to allow the shadow to be seen, it is very faint (owing to few molecular rays), but is quite sharp (owing to the divergence of the molecules laterally). The variation in mutual repulsion is shown by the fact that the focus projected from a concave pole falls beyond the centre of curvature, and varies in position with the exhaustion, being longer at high than at low exhaustions.

Assuming that the phosphorescence is due, either directly or indirectly, to the impact of the molecules on the phosphorescent surface, it is reasonable to suppose that a certain velocity is required to produce the effect. Within the dark space, at a moderate exhaustion, the velocity does not accumulate to a sufficient extent to produce phosphorescence; but at higher exhaustions the mean free path is long enough to allow the molecules to get up speed sufficient to cause phosphorescence. At a very high exhaustion the phosphorescence takes place nearer the negative pole than at lower exhaustions; this I consider results from the initial velocity of the molecules being sufficient to produce phosphorescence, their greater speed being due to the fewer collisions near the negative pole.

The luminous boundary to the dark space round the negative pole is probably due to the impact of molecule against molecule, producing phosphorescence of the gas in the same way as the impact of molecules against German glass produces phosphorescence of the glass.

The following experiments were commenced at the suggestion of Prof. Maxwell:—

A tube was made as shown in Fig. 1. The terminal *a*

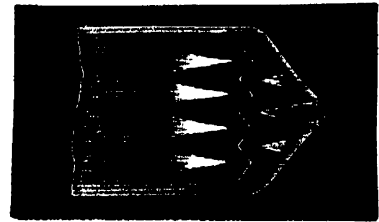
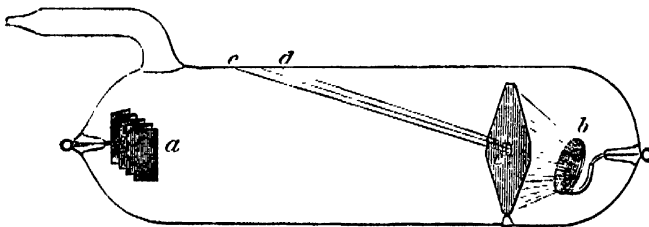

is a rectangular plate of aluminium, folded as shown in section Fig. 2; the other terminal *b* is a flat disk of aluminium set obliquely to the axis of the tube. In front of the pole *b* is fixed a screen of mica, with a small hole in it, as shown at *c*; this hole is not in the axis of the tube, but a little to one side of it, so that rays starting normally from the centre of the pole *b* may pass through it and strike the glass at *d*, whilst at the same time rays passing direct between the poles *a* and *b* can also pass through the hole.

The questions which this apparatus was to answer are: (1) Will there be molecular projections from the negative pole, *a*, in two series of plane strata normal to the sides of the individual furrows, or will the projection be perpendicular to the electrode as a whole, *i.e.*, along the axis of the tube? and (2), Will the molecular rays from the pole *b*, when it is made negative, issue through the aperture of the screen, along the axis of the tube, *i.e.*, direct to the positive pole, or will they leave the pole normal to its surface and strike the glass as shown at *d*?

The tube was exhausted and connected with an induction coil; the following results were obtained:—At a moderate exhaustion, the corrugated pole being made

negative, the dark space entirely surrounds it, slight indentations being visible opposite each hollow, where there also is a linear concentration of blue light. The appearance is in section as shown in Fig. 2. At higher exhaustions the luminous margin disappears and the rays which previously formed the blue foci are now projected on the inner surface of the tube, where they make themselves evident in green phosphorescent light as portions of ellipses formed by the intersection of the several sheets

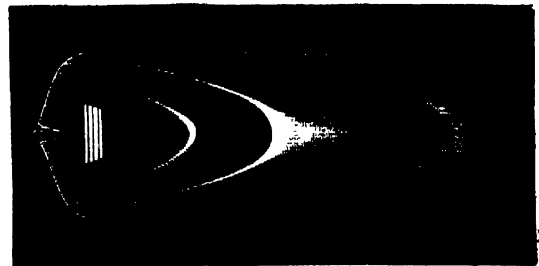

FIG. 3.

of molecular rays with the cylindrical tube. Fig. 3 shows this appearance.

When the other pole was made negative, and the

<sup>1</sup> "Contributions to Molecular Physics in High Vacua. Magnetic Deflection of Molecular Trajectory; Laws of Magnetic Rotation in High Vacuum; Phosphorogenic Properties of Molecular Discharge." By William Stokes, F.R.S. (Extracts from a paper in the *Philosophical Transactions of the Royal Society*, Part 2, 1879)

exhaustion was such that the dark space extended about 8 millims. from the pole, the first appearance noticed was that of a ray of dark blue light issuing through the hole in the mica screen, and shooting upwards towards the side of the tube, but not reaching it. Fig. 4 shows the

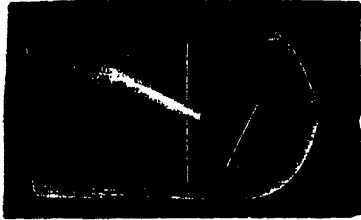

FIG. 4.

dark space round the pole, and the ray of blue light. On increasing the exhaustion this blue line of light, and the luminous boundary to the dark space, disappeared, and presently a green oval spot appeared on the side of the tube, exactly on the place previously marked where the rays issuing normal from the surface of the pole should fall.

It happened that this oval spot fell on a portion of the tube where one of the elliptical projections from the opposite (corrugated) pole also fell when that was made negative. Thus by reversing the commutator I could get a narrow band of green phosphorescent light from one pole, or a wider oval of green light from the other pole, to fall alternately on the same portion of the glass. Fig. 5 shows these effects, which, however, did not occur together as represented in the figure, but alternately.

The narrow band shone very brightly with green phosphorescence, but on reversing the commutator and obtaining the oval spot, this was seen to be cut across the middle by a darker band where the phosphorescence was much less intense. The light of the band was always more intense than that from the spot; the impacts from the one being more concentrated than from the other, owing to the shape and position of the poles; moreover the experiments had been first tried with the corrugated pole negative. The glass along the band gradually becomes deadened by repeated impacts, and will not readily phosphoresce in reply to the weaker blows from the flat plate, although it still responds to the more energetic bombardment from the corrugated pole. This phenomenon almost disappears at very high exhaustions, or if the tube is allowed to rest for some time. The tired glass then recovers its phosphorescent power to some extent, but not completely.



FIG. 5.

To obtain this action in a more striking manner, a tube was made having a metal cross on a hinge opposite the negative pole. The sharp image of the cross was projected on the phosphorescent end of the bulb, where it appeared black on a green ground. After the coil had been playing for some time a sudden blow caused the cross to fall down, when immediately there appeared on the glass a bright green cross on a darker background. The part of the glass formerly occupied by the shadow, having been protected from bombardment, now shone out with full intensity, whilst the adjacent parts of the glass

had lost some of their sensitiveness, owing to previous bombardment.

This effect of deadening produced on glass by long-continued phosphorescence was shown in a very striking manner at a lecture delivered at the Royal Institution on April 4, 1879, when the image of a cross was stencilled on the end of a large pear-shaped bulb.

I subsequently experimented further with this bulb, and found that the image of the cross remained firmly stencilled on the glass. The bulb was then opened and the wide end heated in the blowpipe flame till it was quite soft and melted out of shape. It was then blown out again into its original shape, and re-exhausted; on connecting it with the induction coil, the metal cross being down out of the line of discharge, the original ghost of the cross was seen to be still there, showing that the deadening of the phosphorescing powers the glass produced by the first experiment at the Royal Institution had survived the melting-up and re-blowing out of the bulb.

When experimenting with this apparatus a shifting of the line of molecular discharge was noticed when the current was first turned on. The flat pole *b* (Fig. 6) being



negative and the line *cd* being normal to its surface, the spot of light falls accurately on *d*, when the exhaustion is sufficiently good to give a sharp oval image of the hole *c*. But at higher exhaustions, when the outline of the image of *c* becomes irregular and continually changing, the patch of light at the moment of making contact is sometimes seen at *e*, and then almost instantly travels from *e* to *d*, where it remains as long as the current passes. The passage of the spot from *e* to *d* is very rapid, and requires close attention to observe it. If the coil is now stopped for a longer or shorter time, and contact is again made the same way as before (*b* being negative), the spot does not now start from position *e*, but falls on *d*, in the first instance. This can be repeated any number of times.

If now the pole *b* be made positive even for the shortest possible interval, and it then be made negative, the original phenomenon occurs, and the spot of light starts from *e* and rapidly travels to *d*. After this it again falls on *d*, *ab initio*, each time contact is made, so long as *b* is kept the negative pole. There seems no limit to the number of times these experiments can be repeated. The explanation of this result appears to depend on a temporary change in the condition of the wall of the glass tube when positively electrified molecules beat against it, a change which is undone by subsequent impact from negative molecules. This phenomenon is closely connected with some shadow and penumbra experiments described further on, and as the same explanation will apply to both I will defer any theoretical remarks for the present.

A suggestion was made by Prof. Maxwell that I should introduce a third, idle, electrode in a tube between the positive and negative electrodes so that the molecular stream might beat upon it, so as to see if the molecules gave up any electrical charge when impinging on an obstacle. A tube was therefore made as shown in Fig. 7; *a* and *b* are the ordinary terminals; *c* and *d* are large aluminium disks nearly the diameter of the tube, con-



ected with outer terminals. The poles *a* and *b* were connected with the induction coil, an earth wire was brought near the idle pole *c*, and a gold leaf electroscope was brought near *d*.

On passing the current at inferior exhaustions, when the dark space is about 8 millims. from the negative pole,

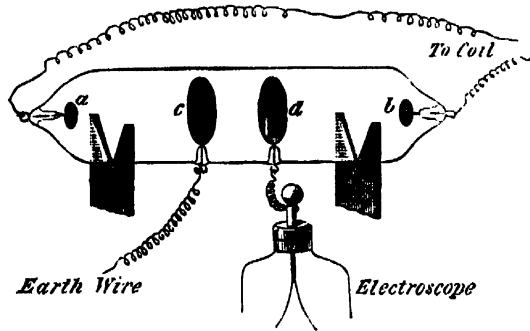

FIG. 7.

no movement of the gold leaves takes place whether *a* or *b* is negative, and whether *c* is connected with earth or is insulated.

At a good exhaustion, when the green phosphorescence of the glass is strong, the gold leaves are only slightly affected whichever way the current passes.

On increasing the exhaustion to a very high point, so that the green phosphorescence gets weaker and the spark has a difficulty in passing, the gold leaves are violently affected. When the pole *a* is negative and *b* positive, the leaves diverge to their fullest extent. On examining their potential it is found to be positive. The coil was stopped and the gold leaves remained open. A touch with the finger caused them to collapse. They then gradually opened again, but not to the original extent. The finger again discharged them, when they reopened slightly a third time. Experiment showed that the electrical excitement took many minutes to recover equilibrium. A Leyden jar put to the idle pole *d* was charged positively.

The earth wire and electroscope remaining, as shown in the figure, the direction of current was reversed so as to make *a* positive and *b* negative. The gold leaves were now less strongly affected; they opened a little, and remained quivering, as if under the influence of rapidly-alternating currents.

The wires were rearranged as shown in Fig. 8, *b* and *d*

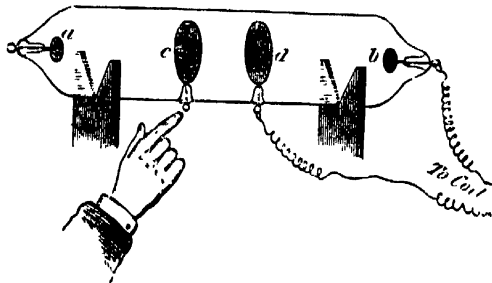

FIG. 8.

being connected with the coil. When *d* was made negative, faint sparks about 1 millim. long could be drawn by the finger from *c*; but when *d* was made positive the sparks from *c* were 10 millims. long. The same results are obtained when the finger is brought near *a*, so long as *c* remains insulated. If, however, *c* be connected with earth by a wire, no sparks can be got from *a*, whichever way the current passes between *b* and *d*. Connecting *a*

with earth diminishes the length of the sparks, which can be drawn from *c* by about one-half.

The poles *a* and *b* being connected with the coil and the idle poles *c* and *d* having loose wires hanging from them, the wires were strongly repelled from each other.

The above experiments show that an idle pole in the direct line between the positive and the negative poles, and consequently receiving the full impact of the molecules driven from the negative pole, has a strong positive charge.

It now became of interest to ascertain whether the trajectory of the molecules suffered any deflection in passing an idle pole when it was suddenly uninsulated by an earth contact. For this purpose I used the tube described in a former paper,<sup>1</sup> where the shadow of an aluminium star was projected on a plate of phosphorescent glass. So long as the aluminium star is insulated, the shadow is sharp, as already described; but on touching the star to earth, the shadow widens out, forming a tolerably well-defined penumbra outside the original shadow, which can still be seen unchanged in size and intensity. On removing the earth connection, the penumbra disappears, the umbra remaining as before. The same penumbra is produced by connecting the idle pole with the negative pole through a very high resistance, such as a piece of wet string, instead of connecting it with earth. On bringing a magnet near the negative pole, the shadow of the (insulated) star is much increased in definition, the adjacent luminous parts of the screen becoming more luminous. Touching the star now brings a large, somewhat blurred, penumbra round the original image. The penumbra obeys the magnet the same as the umbra.

The aluminium star was now made the positive pole, the other pole remaining unchanged. The shadow of the star was projected on the phosphorescent plate of the same sharpness and almost the same intensity of light and shade as if the positive pole had been the one ordinarily used as such. The image obeyed the magnet as usual. With this arrangement the penumbral action could not be tested.

This, therefore, confirms the above-described results—that the idle pole, the shadow of which is cast by the negative pole, has strong positive charge. Now the stream of molecules must be assumed to carry negative electricity; when they actually strike the idle pole they are arrested, but those which graze the edge are attracted inwards by the positive electricity, and form the shadow. When the idle pole is connected with earth its potential would become zero were the discharge to cease; but, inasmuch as a constant positive charge is kept up from the passage of the current through the tube, we must assume that the potential of the uninsulated idle pole is still sufficiently positive to neutralise the negative charge which the impinging molecules would give it, and leave some surplus of positive. The effect of alternately uninsulating and insulating the idle pole is therefore to vary its positive electricity between considerable limits, and consequently its attractive action on the molecules which graze its edge.<sup>2</sup>

Experiments were tried with an idle pole and shadow tube whilst the exhaustion was going on. At such a rarefaction that the shadow can just be made out, it is quite sharp; touching the idle pole causes a small penumbra to appear round its shadow. When the exhaustion is at the best point for obtaining the green phosphorescence on the glass, the shadow is very sharp and well defined; and connecting the idle pole with earth gives a much wider penumbra, the width of the penumbra increasing with the degree of rarefaction. When the

<sup>1</sup> *Phil. Trans.*, 1879, vol. 170, p. 147.

<sup>2</sup> I am aware that the theory which makes these effects of deflection depend on electrostatic attractions and repulsions is open to some grave objections; still it was that which in a great measure guided me in my experiments, and it could not well be omitted without reducing the description of them to a dry record of apparently unconnected facts.

vacuum is so high that the spark has difficulty in passing, the penumbra (which becomes visible on insulating the idle pole) is much wider than before, and apparently eight or ten times as wide as it was at the lowest exhaustion at which observations were taken.

If the object whose shadow is cast on the screen is a non-conductor (such as a piece of glass rod), its shadow remains constant at all exhaustions, no penumbra being visible, as it cannot be uninsulated.

Prof. Stokes, whose suggestions throughout the course of this research have been most valuable, considered that much information might be gained by experimenting with an apparatus constructed in the following manner: the two poles of the tube (Fig. 9) are at *a* and *b*. At *c* is a

interfered with. That is to say, the shadows followed the successive positions between those shown in Figs. 9B and 9C almost as if they had been cast by a luminous point in place of the negative pole. As the shadow of the swinging pendulum came very near that of the bar, the latter shadow seemed to shrink away, showing that the pendulum itself exerted slight repulsion on the molecules which passed close to its edge.

The pendulum was again set stationary, as shown on the plan (Fig. 10), the line of light separating the two



being at *f*, so that the appearance on the screen was as shown at Fig. 9A. The pendulum pole was then connected with earth, and instantly the line of light which separated the poles moved from *f* to *g* through an angle, measured from *c*, of about 30°, the shadow widening out and getting indistinct at the same time.

When the pole *a* was negative and *b* positive, the bar *d* and pendulum *e* were each found to be positively electrified. The outside of the glass tube, both near the negative pole and near the positive pole, was also positively electrified.

The above experiments were tried with 6300 cells, a resistance equal to 800,000 ohms being interposed. The current through the tube was 0.00383 weber. These measurements were taken by Mr. De La Rue, to whom I am greatly indebted for permission to experiment with his magnificent battery, and who himself kindly assisted me in making the arrangements. WILLIAM CROOKES

(To be continued.)

Elevation.



Plan.

FIG. 9.



FIG. 9A.

FIG. 9B.

FIG. 9C.

fluorescent screen; *d* is a fixed bar of aluminium, and *e* is another aluminium bar hanging from a platinum pole *f*, by a metal chain. The bar and pendulum are on opposite sides of the horizontal axis of the tube, as shown in the plan, so that when properly exhausted and the pole *a* made negative, the shadows of bar and pendulum shall fall side by side on the screen, as shown in Fig. 9A. On swinging the pendulum, the shadow alternately overlaps and recedes from the shadow of the bar (Figs. 9B and 9C).

This apparatus was tried many times with an induction coil, and also with a Holtz machine; but the results were not sufficiently definite to render it safe to draw any inference from them. By the kindness of Mr. De La Rue I have lately had the opportunity of experimenting with his large chloride of silver battery, and the results now come out with great sharpness and with none of the flickering and indecision met with when working with an induction-coil.

The tube was so adjusted that the pendulum hung free, and a narrow line of molecular discharge passed between the edges of the bar and the pendulum, forming a line of light between the two shadows on the screen (Fig. 9A). When the pendulum was set swinging, and the idle pole *f* connected with it was kept insulated, the regular appearance of the moving and fixed shadows was very slightly

### ROCK-WEATHERING, AS ILLUSTRATED IN CHURCHYARDS<sup>1</sup>

COMPARATIVELY little has yet been done in the way of precise measurement of the rate at which the exposed surfaces of different kinds of rock are removed in the processes of weathering. A few years ago some experiments were instituted by Prof. Pfaff of Erlangen to obtain more definite information on this subject. He exposed to ordinary atmospheric influences carefully measured and weighed pieces of Solenhofen limestone, syenite, granite (both rough and polished), and bone. At the end of three years he found that the loss from the limestone was equivalent to the removal of a uniform layer 0.04 mm in thickness from its general surface. The stone had become quite dull and earthy, while on parts of its surface fine cracks and incipient exfoliation had appeared.<sup>2</sup> The time during which the observations were continued is however too brief to allow any general deductions to be drawn from them as to the real average rate of disintegration. Prof. Pfaff relates that during the period a severe hailstorm broke one of the plates of stone. An exceptionally powerful cause of this nature might make the loss during a short interval considerably greater than the true average of a longer period.

It occurred to me recently that data of at least a provisional value might be obtained from an examination of tombstones freely exposed to the air in graveyards in cases where their dates remained still legible or might be otherwise ascertained. I have accordingly paid attention to the older burial-grounds in Edinburgh, and have gathered together some facts which have perhaps sufficient interest and novelty to be communicated to the Society.

At the outset it is of course obvious that in seeking for

<sup>1</sup> A Paper read to the Royal Society of Edinburgh, on April 19, by Prof. Geikie, F.R.S.

<sup>2</sup> "Allgemeine Geologie als exacte Wissenschaft," p. 317.

data bearing on the general question of rock-weathering we must admit the kind and amount of such weathering visible in a town to be in some measure different from what is normal in nature. So far as the disintegration of rock-surfaces is effected by mineral acids, for example, there must be a good deal more of such chemical change where sulphuric acid is copiously evolved into the atmosphere from thousands of chimneys than in the pure air of country districts. In these respects we may regard the disintegration in towns as an exaggeration of the normal rate. Still the difference between town and country may be less than might be supposed. Surfaces of stone are apt to get begrimed with dust and smoke, and the crust of organic and inorganic matter deposited upon them may in no small measure protect them from the greater chemical activity of the more acid town rain. In regard to the effect of daily or seasonal changes of temperature, on the other hand, any difference between town and country may not improbably be on the side of the town. Owing probably to the influence of smoke in retarding radiation, thermometers placed in open spaces in town commonly mark an extreme nocturnal temperature not quite so low as those similarly placed in the suburbs, while they show a maximum day temperature not quite so high.

The illustrations of rock-weathering presented by city graveyards are necessarily limited to the few kinds of rock employed for monumental purposes. In this district the materials used are of three kinds: 1st, Calcareous, including marbles and limestones; 2nd, Sandstones and flagstones; 3rd, Granites.

I. CALCAREOUS.—With extremely rare exceptions, the calcareous tombstones in our graveyards are constructed of ordinary white saccharoid Italian marble. I have also observed a pink Italian shell-marble and a finely fossiliferous limestone containing fragments of shells, foraminifera, &c.

In a few cases the white marble has been employed by itself as a monolith in the shape of an obelisk, urn, or other device; but most commonly it occurs in slabs which have been tightly fixed in a framework of sandstone. These slabs, from less than one to fully two inches thick, are generally placed vertically; in one or two examples they have been inserted in large horizontal sandstone slabs or "through-stanes." The form into which it has been cut and the position in which it has been erected have had considerable influence on the weathering of the stone.

A specimen of the common white marble employed for monumental purposes was obtained from one of the marble works of the city, and examined microscopically. It presented the well-known granular character of true saccharoid marble, consisting of rounded granules of clear transparent calcite, averaging about  $\frac{1}{100}$  inch in diameter. Each granule has its own system of twin lamellations, and not unfrequently gives interference colours. The fundamental rhombohedral cleavage is everywhere well developed. Not a trace exists of any amorphous granular matrix or base holding the crystalline grains together. These seem moulded into each other, but have evidently no extraordinary cohesion. A small fragment placed in dilute acid was entirely dissolved. There can be no doubt that this marble must be very nearly pure carbonate of lime.

The process of weathering in the case of this white marble presents three phases, sometimes to be observed on the same slab, viz., Superficial Solution, Internal Disintegration, and Curvature with Fracture.

(1) *Superficial solution* is effected by the carbonic acid and partly by the sulphuric acid of town rain. When the marble is first erected it possesses a well-polished surface capable of affording a distinct reflection of objects placed in front of it. Exposure for not more than a year or two to our prevalent westerly rains suffices to remove this polish, and to give the surface a rough granular character.

The granules which have been cut across or bruised in the cutting and polishing process are first attacked, and removed in solution or drop out of the stone. An obelisk in Greyfriars churchyard erected in memory of a lady who died in 1864 has so rough and granular a surface that it might readily be taken for a sandstone. So loosely are the grains held together that a slight motion of the finger will rub them off. In the course of solution and removal the internal structure of the marble begins to reveal itself. Its harder nests and veinings of calcite and other minerals project above the surrounding surface, and may be traced as prominent ribs and excrescences running across the faint or illegible inscriptions. On the other hand some portions of the marble are more rapidly removed than others. Irregular channels, dependent partly on the direction given to trickling rain by the form of the monumental carving, but chiefly on original differences in the internal structure of the stone, are gradually hollowed out. In this way the former artificial surface of the marble disappears, and is changed into one that rather recalls the bare, bleached rocks of some mountain side.

The rate at which this transformation takes place seems to depend primarily on the extent to which the marble is exposed to rain. Slabs which have been placed facing to north-east, and with a sufficiently projecting architrave to keep off much of the rainfall, retain their inscriptions legible for a century or longer. But even in these cases the progress of internal disintegration is distinctly visible. Where the marble has been less screened from rain the rapidity of waste has been sometimes very marked. A good illustration is supplied by the tablet of G— G—, on the south side of Greyfriars Churchyard, who died in 1785. This monument had become so far decayed as to require restoration in 1803. It is now, and has been for some years, for the most part utterly illegible. The marble has been dissolved away over the centre of the slab to a depth of about a quarter of an inch. Yet this monument is by no means in an exposed situation. It faces eastward in a rather sheltered corner, where, however, the wind eddies in such a way as to throw the rain against the part of the stone which has been most corroded.

In the majority of cases superficial solution has been retarded by the formation of a peculiar grey or begrimed crust, to be immediately described. The marble employed here for monumental slabs appears to be peculiarly liable to the development of this crust. Another kind of white marble, sometimes employed for sculptured ornaments on tombstones, dissolves without crust. It is snowy white, and more translucent than the ordinary marble. So far as the few weathered specimens I have seen enable me to judge, it appears to be either Carrara marble or one of the strongly saccharoid, somewhat translucent varieties employed instead of it. This stone, however, though it forms no crust, suffers marked superficial solution. But it escapes the internal disintegration which, so far as I have observed, is always an accompaniment of the crust. But the few examples of it I have met with hardly suffice for any comparison between the varieties.

(2) *Internal Disintegration*.—Many of the marble monuments in our older churchyards are covered with a dirty crust, beneath which the stone is found on examination to be merely a loose crumbling sand. This crust seems to form chiefly where superficial solution is feeble. It may be observed to crack into a polygonal network, the individual polygons occasionally curling up so as to reveal the yellowish white crumbling material underneath. It also rises in blisters, which, when they break, expose the interior to rapid disintegration.

So long as this begrimed film lasts unbroken the smooth face of the marble slab remains with apparently little modification. The inscription may be perfectly

\* For obvious reasons I withhold the names carved on the tombstones referred to in this communication.

legible; the moment the crust is broken up, however, the decay of the stone is rapid. For we then see that the cohesion of the individual crystalline granules of the marble has already been destroyed, and that the merest touch causes them to crumble into a loose sand.

It appears therefore that two changes take place in upright marble slabs freely exposed to rain in our burial-grounds—a superficial, more or less firm crust is formed, and the cohesion of the particles beneath is destroyed.

The crust varies in colour from a dirty grey to a deep brown black, and in thickness from that of writing-paper up to sometimes at least a millimetre. One of the most characteristic examples of it was obtained from an utterly decayed tomb (erected in the year 1792), on the east side of Canongate Churchyard. No one would suppose that the pieces of flat dark stone lying there on the sandstone plinth were once portions of white marble. Yet a mere touch suffices to break the black crust, and the stone at once crumbles to powder. Nevertheless the two opposite faces of the original polished slab have been preserved, and I even found the sharply-chiselled socket-hole of one of the retaining nails. The specimen was carefully removed and soaked in a solution of gum, so as to preserve it from disintegration. On submitting the crust of the marble to microscopic investigation, I found it to consist of particles of coal, grains of quartz sand, angular pieces of broken glass, fragments of red brick or tile, and organic fibres. This miscellaneous collection of town dust was held together by some amorphous cement which was not dissolved by hydrochloric acid. At my request my friend Mr. B. N. Peach tested it with soda on charcoal, and at once obtained a strong sulphur reaction. There can be little doubt that it is mainly sulphate of lime. The crust which forms upon our marble tombstones is thus a product of the reaction of the sulphuric acid of the town rain upon the carbonate of lime. A pellicle of amorphous gypsum is deposited upon the marble and incloses the particles of dust which give the characteristic sooty aspect to the stone. This pellicle, of course, when once formed, is comparatively little affected by the chemical activity of rain-water. Hence the conservation of the even surface of the marble. It is liable, however, to be cracked by an internal expansion of the stone to which I shall immediately refer, and also to rise in small blisters, and as I have said, its rupture leads at once to the rapid disintegration of the monument.

The cause of this disintegration is the next point for consideration. Chemical examination revealed the presence of a slight amount of sulphate in the heart of the crumbling marble; but the quantity appeared to me to be too small seriously to affect the cohesion of the stone. I submitted to microscopic examination a portion of a crumbling urn of white marble in Canongate Churchyard. The tomb bears a perfectly fresh date of "1792" cut in sandstone over the top; but the marble portions are crumbling into sand, though the structure faces the east, and is protected from vertical rain by arching mason-work. A small portion of the marble retaining its crust was boiled in Canada balsam, and was then sliced at right angles to its original polished surface. By this means a section of the crumbled marble was obtained which could be compared with one of the perfectly fresh stone. From the dark outer amorphous crust with the carbonaceous and other miscellaneous particles fine rifts could be seen passing down between the separated calcite granules, which in many cases were quite isolated. The black crust descends into these rifts, and likewise passes along the cleavage planes of the granules. Towards the outer surface of the stone immediately beneath the crust the fissures are chiefly filled with a yellowish, structureless substance, which gave a feeble glimmering reaction with polarised light, and inclosed minute amorphous aggregates like portions of the crust. It probably consists chiefly of sulphate of lime. But the most

remarkable feature in the slide was the way in which the calcite granules had been corroded. Seen with reflected light, they resembled those surfaces of spar which have been placed in weak hydrochloric acid to lay bare inclosed crystals and zeolites. The solution had taken place partly along the outer surfaces, so as to produce the fine passage or rifts, and partly along the cleavage. Deep cavities, defined by intersecting cleavage planes, appeared to descend into the heart of some of the granules. In no case did I observe any white pellicle such as might indicate a redeposit of lime from the dissolved carbonate. Except for the veining of probable sulphate just referred to, the lime when once dissolved had apparently been wholly removed in solution. There was further to be observed a certain dirtiness, so to speak, which at the first glance distinguished the section of crumbled marble from the fresh stone. This was due partly to corrosion, but chiefly to the introduction of particles of soot and dust, which could be traced among the interstices and cleavage lamellæ of the crystalline granules, for some distance back from the crust.

It may be inferred, therefore, that the disintegration of the marble is mainly due to the action of carbonic acid in the permeating rain-water, whereby the component crystalline granules of the stone are partially dissolved and their mutual adhesion is destroyed. This process goes on in all exposures, and with every variety in the thickness of the outer crust. It is distinctly traceable in tombstones that have not been erected for more than twenty years. In those which have been standing for a century it is, save in exceptionally sheltered positions, so far advanced that a very slight pressure suffices to crumble the stone into powder. But with this internal disintegration we have to take into consideration the third phase of weathering to which I have alluded. In the upright marble slabs it is the union of the two kinds of decay which leads to so rapid an effacement of the monuments.

3. *Curvature and Fracture.*—This most remarkable phase of rock-weathering is only to be observed in the slabs of marble which have been firmly inserted into a solid framework of sandstone and placed in an erect or horizontal position. It consists in the bulging out of the marble, accompanied with a series of fractures. The change cannot be explained as mere sagging by gravitation, for it usually appears as a swelling up of the centre of the slab, which continues until the large, blister-like expansion is disrupted. Nor is it by any means exceptional; it occurs as a rule on all the older upright marble tablets, and is only found to be wanting in those cases where the marble has evidently not been fitted tightly into its sandstone frame. Wherever there has been little or no room for expansion, protuberance of the marble may be observed. Successive stages may be seen, from the first gentle uprise to an unsightly swelling of the whole stone. This change is accompanied by fracture of the marble. The rents in some cases proceed from the margin inwards, more particularly from the upper and under edges of the stone, pointing unmistakably to an increase in volume as the cause of fracture. In other cases the rents appear in the central part of the swelling, where the tension from curvature has been greatest.

Some exceedingly interesting examples of this singular process of weathering are to be seen in Greyfriars Churchyard. On the south wall, in the inclosure of a well-known rouny family, there is an oblong upright marble slab measuring 30½ inches in height by 22½ inches in breadth, and 1½ inch in thickness, facing west. The last inscription on it bears the date 1838, at which time it was no doubt still smooth and upright. Since then, however, it has escaped from its fastenings on either side, though still held firmly at the top and bottom. It consequently projects from the wall like a well-filled sail. The axis of curvature is of course parallel to the upper and lower margins, and the

amount of curvature from the original vertical line is fully  $2\frac{1}{2}$  inches, so that the hand and arm can be inserted between the curved marble and the perfectly vertical and undisturbed wall to which it was fixed. At the lower end of this slab a minor curvature, to the extent of  $\frac{1}{2}$  inch, is observable coincident with the longer axes of the stone. In both cases the direction of the bending has been determined by the position of the inclosing solid frame of sandstone which resisted the internal expansion of the marble. Freed from its fastenings at either side, the stone has assumed a simple wave-like curve. But the tension has become so great that a series of rents has appeared along the crest of the fold. One of these has a breadth of  $\frac{1}{16}$  inch at its opening.<sup>1</sup> Not only has the slab been ruptured, but its crust has likewise yielded to the strain, and has broken up into a network of cracks, and some of the isolated portions are beginning to curl up at the edges, exposing the crumbling, decayed marble below. I should add that such has been the expansive force of the marble that the part of the sandstone block in the upper part of the frame exposed to the direct pressure has begun to exfoliate, though elsewhere the stone is quite sound.

More advanced stages of curvature and fracture may be noticed on many other tombstones in the same burying-place. One of the most conspicuous of these has a peculiar interest from the fact that it occurs on the tablet erected to the memory of one of the most illustrious dead whose dust lies within the precincts of the Greyfriars—the great Joseph Black. He died in 1799. In the centre of the sumptuous tomb raised over his grave is inserted a large upright slab of white marble, which, facing south, is protected from the weather partly by heavy overhanging masonry, and partly by a high stone wall immediately to the west. On this slab a Latin inscription records with pious reverence the genius and achievements of the discoverer of carbonic acid and latent heat, and adds that his friends wished to mark his resting-place by the marble whilst it should last. Less than eighty years, however, have sufficed to render the inscription already partly illegible. The stone, still firmly held all round its margin, has bulged out considerably in the centre, and on the blister-like expansion has been rent by numerous cracks which run on the whole in the direction of the length of the stone.

A further stage of decay is exhibited by a remarkable tomb on the west wall of the Greyfriars Churchyard. The marble slab, bearing a now almost wholly effaced inscription, on which the date 1779 can be seen, is still held tightly within its inclosing frame of sandstone slabs, which are firmly built into the wall. But it has swollen out into a ghastly protuberance in the centre, and is moreover seamed with rents which strike inwards from the margins. In this and in some other examples the marble seems to have undergone most change on the top of the swelling, partly from the system of fine fissures by which it is broken up, and partly from more direct and effective access of rain. Eventually the cohesion of the stone at that part is destroyed, and the crumbling marble falls out, leaving a hole in the middle of the slab. When this takes place disintegration proceeds rapidly. Three years ago I sketched a tomb in this stage on the east wall of Canongate Churchyard. In a recent visit to the place I found that the whole of the marble had since fallen out.

The first cause that naturally suggests itself in explanation of this remarkable change in the structure of a substance usually regarded as so inelastic is the action of frost. White statuary marble is naturally porous. It is rendered still more so by that internal solution which I have described. The marble tombstones in our graveyards are therefore capable of imbibing a relatively large

<sup>1</sup> It is a further curious fact that the slab measures half an inch more in breadth across the centre where it has had room to expand than at the top where it has been tightly jammed between the sandstone slabs.

amount of moisture. When this interstitial water is frozen its expansive force as it passes into the solid state must increase the isolation of the granules and augment the dimensions of a marble block. I am inclined to believe that this must be the principal cause of the change. Whatever may be the nature of the process, it is evidently one which acts from within the marble itself. Microscopic examination fails to discover any chemical transformation which would account for the expansion. Dr. Angus Smith has pointed out that in towns the mortar of walls may be observed to swell up and lose cohesion from a conversion of its lime into the condition of sulphate. I have already mentioned that sulphate does exist within the substance of the marble, but that its quantity so far as I have observed is too small to be taken into account in this question. The expansive power is exerted in such a way as not sensibly to affect the internal structure and composition of the stone, and this I imagine is most probably the work of frost.

The results of my observations among our burial grounds show that, save in exceptionally sheltered situations, slabs of marble exposed to the weather in such a climate and atmosphere as that of Edinburgh are entirely destroyed in less than a century. When this destruction takes place by simple comparatively rapid superficial solution and removal of the stone, the rate of lowering of the surface amounts sometimes to about a third of an inch (or roughly nine millimetres) in a century. Where it is effected by internal displacement, a curvature of two and a half inches with abundant rents, a partial effacement of the inscription and a reduction of the marble to a pulverulent condition may be produced in about forty years, and a total disruption and effacement of the stone within one hundred. It is evident that white marble is here utterly unsuited for out-of-door use, and that its employment for really fine works of art which are meant to stand in the open air in such a climate ought to be strenuously resisted. Of course I am now referring not to the durability of marble generally, but to its behaviour in a large town with a moist climate and plenty of coal smoke.

II. SANDSTONES AND FLAGSTONES.—These, being the common building materials of the country, are of most frequent occurrence as monumental stones. When properly selected, they are remarkably durable. By far the best varieties are those which consist of a nearly pure fine siliceous sand, with little or no iron or lime, and without trace of bedding structure. Some of our sandstones contain 98 per cent. of silica. A good illustration of their power of resisting the weather is supplied by Alexander Henderson's tomb in Greyfriars Churchyard. He died in 1646, and a few years afterwards the present tombstone, in the form of a solid square block of freestone, was erected at his grave. It was ordered to be defaced in 1662 by command of the Scottish Parliament, but after 1688 it was repaired. Certain bullet marks upon the stone are pointed out as those of the soldiery sent to execute the order. Be this as it may, the original chisel marks on the polished surface of the stone are still perfectly distinct, and the incised lettering remains quite sharp. Two hundred years have effected hardly any change upon the stone, save that on the west and south sides, which are those most exposed to wind and rain, the surface is somewhat roughened, and an internal fine parallel jointing begins to show itself.

Three obvious causes of decay in arenaceous rocks may be traced among our monuments. In the first place, the presence of a soluble or easily removable matrix in which the sand grains are embedded. The most common kinds of matrix are clay, carbonates of lime and iron, and the anhydrous and hydrous peroxides of iron. The presence of the iron reveals itself by its yellow, brown, or red colour. So rapid is disintegration from this cause, that the sharply-incised date of a monument

erected in Greyfriars Church to an officer who died only in 1863 is no longer legible. At least  $\frac{1}{4}$ th of an inch of surface has here been removed from a portion of the slab in sixteen years, or at the rate of about  $\frac{1}{4}$  inch in a century.

In the second place, where a sandstone is marked by distinct laminæ of stratification, it is nearly certain to split up along these lines under the action of the weather if the surface of the bedding planes is directly exposed. This is well known to builders, who are quite aware of the importance of "laying a stone on its bed." Examples may be observed in our churchyards, where sandstones of this character have been used for pilasters and ornamental work, and where the stone set on its edge has peeled off in successive layers. In flagstones, which are merely thinly-bedded sandstones, this minuter lamination is fatal to durability. These stones, from the large size in which slabs of them can be obtained and from the ease with which they can be worked, form a tempting material for monumental inscriptions. The melancholy result of trusting to their permanence is strikingly shown by a tombstone at the end of the South Burying Ground in Greyfriars Churchyard. The date inscribed on it is 1841, and the lettering that remains is as sharp as if cut only recently. The stone weathers very little by surface disintegration. It is a laminated flagstone set on edge, and large portions have scaled off, leaving a rough, raw surface where the inscription once ran. In this instance a thickness of about  $\frac{1}{4}$  inch has been removed in forty years.

In the third place, where a sandstone contains concretionary masses of different composition or texture from the main portion of the stone, these are apt to weather at a different rate. Sometimes they resist destruction better than the surrounding sandstone, so as to be left as prominent excrescences. More commonly they present less resistance, and are therefore hollowed out into irregular and often exceedingly fantastic shapes. Examples of this kind of weathering abound in our neighbourhood. Perhaps the most curious to which a date can be assigned are to be found in the two sandstone pillars which until recently flanked the tomb of Principal Carstares in Greyfriars Churchyard. They were erected some time after the year 1715. Each of them is formed of a single block of stone about 8 feet long. Exposure to the air for about 150 years has allowed the original differences of texture or composition to make their influence apparent. Each is hollowed out for almost its entire length on the exposed side into a trough 4 to 6 inches deep and 6 to 8 inches broad. As they lean against the wall beneath the new pillars which have supplanted them, they suggest some rude form of canoe rather than portions of a sepulchral monument.

Where concretions are of a pyritous kind, their decomposition gives rise to sulphuric acid, some of which combines with the iron and gives rise to dark stains upon the corroded surface of the stone. Some of the sandstones of this district, full of such impurities, ought never to be employed for architectural purposes. Every block of stone in which they occur should be unhesitatingly condemned. Want of attention to this obvious rule has led to the unsightly disfigurement of public buildings.

III. GRANITES.—In Prof. Pfaff's experiments, to which I have already referred, he employed plates of syenite and granite, both rough and polished. He found that they had all lost slightly in weight at the end of a year. The annual rate of loss was estimated by him as equal to 0.0076 mm. from the unpolished and 0.0085 from the polished granite. That a polished surface of granite should weather more rapidly than a rough one is perhaps hardly what might have been expected. The same observer remarks that though the polished surface of syenite was still bright at the end of not more than three years, it was less so than at first, and in particular that some

figures indicating the date which he had written on it with a diamond had become entirely effaced. Granite has been employed for too short a time as a monumental stone in our cemeteries to afford any ready means of measuring even approximately its rate of weathering. Traces of decay in some of its felspar crystals may be detected, yet in no case that I have seen is the decay of a polished granite surface sensibly apparent after exposure for fifteen or twenty years. That the polish will disappear, and the surface will gradually roughen as the individual component crystals are more or less easily attacked by the weather, is of course sufficiently evident. Even the most durable granite will probably be far surpassed in permanence by the best of our siliceous sandstones. But as yet the data do not exist for making any satisfactory comparison between them.

#### GERHARD JOHANNES MULDER

IN the death of Prof. G. J. Mulder, to which we briefly alluded in our last number, Holland has been called upon to mourn the loss of her leading chemist. Gerhard Johannes Mulder was born at Utrecht, December 27, 1802. His studies were completed at the university of his native city, and embraced especially mathematics, the natural sciences, and medicine. In 1825 he established himself as physician at Amsterdam. His inclination towards a more purely scientific career caused him however in the year following to accept a position as teacher of physics at Rotterdam under the auspices of the Batavian Society. This proved but the stepping-stone to the Professorship of Botany and Chemistry at the Rotterdam Medical School, to which he was appointed in 1827. In 1841 he accepted a call to the Chair of Chemistry at Utrecht, and returned to the place of his birth, to add to its fame by making it the scene of a long-continued series of valuable chemical researches.

Mulder's tastes lay almost entirely in the department of organic chemistry, and more especially in those branches connected with the phenomena of vegetable and animal life. In mineral chemistry his researches were confined to careful studies on the chemical composition of white lead and red lead (1839)—two of the important technical products of Holland—and to the establishment of the atomic weight of tin (1849) by means of numerous analyses. He also modified or perfected a number of analytical methods, such as those for the determination of silver, phosphorus, carbonic acid, &c., and contributed a large variety of analytical data on various technical and scientific compounds. In 1864 he made an elaborate investigation on the phenomena of solution of salts in water, establishing several of the now generally accepted laws with regard to the solubility of mixtures of salts, among others the interesting fact that in saturated solutions of mixtures the relations between the respective quantities of the salts is expressed in multipla of their molecular weights. The varied experimental data resulting from his own researches were grouped, together with the contributions of other chemists on this subject, in the form of a monograph of over 300 pages, which forms the most important work extant on solubility.

In physiological chemistry Mulder has conducted a large variety of investigations. The most important are those connected with the study of the albuminoids, which were commenced in 1838 and extended over a period of twenty years. In the course of these investigations he exposed albumin, fibrine, caseine, &c., to the action of a variety of chemical agents, obtaining the products of oxidation, chlorination, nitrification, &c. At an early date he obtained, by the action of alkaline solutions on the albuminoids, the so-called *protein*, which he regarded as the primary albuminoid matter, the various members of the group consisting of this radical in union with small quantities of sulphur, phosphorus, and oxygen. This

ingenious hypothesis, while being a fruitful cause of research, was ultimately found to be untenable. It involved the author in a somewhat bitter discussion with Liebig and his school, who finally proved protein to be by no means a homogeneous body, and to contain a notable quantity of sulphur, in opposition to Mulder's opinion. While failing to solve the problem of the constitution of this group of compounds, a problem which, even despite Schützenberger's remarkable experiments during the past few years, is but half-way toward solution, Mulder vastly increased our knowledge of the proteïds by numerous analytical results and thorough studies of the chemical properties of the different members of the group and of their derivatives. As especially interesting papers in this connection should be mentioned his research on the nature of the albuminoid forming the crystalline lens of the eye (1839), and that on the natural and artificial formation of peptone from the albuminoids (1858). Closely allied to this subject were the important researches on chondrine and other gelatinous bodies carried out in 1839. From this same year dates also his extended investigation of the chemical properties of hematin, the colouring matter of the blood. The examination of blood enlisted his attention at various intervals, and led to numerous analytical tests, to one of which we owe the proof of the presence of carbonic acid as a normal constituent of the blood. In addition to the topics alluded to, Mulder has contributed to physiological chemistry a large variety of minor isolated observations and numerous analyses of various products of the animal economy.

In the chemistry of vegetable physiology he developed a scarcely less noteworthy activity and diversity. In 1839 and 1840 were published important papers on inulin and starch, and on pectin and pectic acid. At the same time appeared his analytical investigations on the composition of silk, of gum arabic and other gums, of the poison of the upas, of various sorts of tea and coffee, of tannic acid, of numerous ethereal oils, of the resinous matter in turf, of salicin and phlorizin, and of the compounds rufin and rutilene, derived from them, and of gluten. In 1839 he published an extensive research on cassia-oil and cinnamon-oil, and on benzene, in which numerous derivatives of these bodies are described. In the year following he completed an elaborate investigation on the ulmic bodies, which forms the chief basis of our knowledge in this still comparatively obscure field. This was followed by interesting researches on yeast (1844), on chlorophyll, on the presence of waxy constituents in many ordinary plants (1844), on the action of acids on woody fibre (1846), on chrysanonic acid and other derivatives from aloes. In 1865 he published a very complete and valuable study on drying oils and their chemical properties, based on a wide range of experimental observation. Mulder made two important contributions to the special chemistry of the aromatic compounds by his discovery in 1839 of meta-nitro-benzoic acid—one of the earliest representatives of the nitro acids—and by his study in 1858 on the formation of picric acid from indigo, in which he advanced the now generally accepted opinion of a transition, by means of isatin and nitrosalicylic acid, from one compound to the other. Organic chemistry is likewise indebted to him for several improvements in analytical methods, and he was one of the first to devise gas furnaces for use in organic combustions.

As an author and editor Prof. Mulder was scarcely less active than as an investigator. His principal works, which are better known in their German translations, are:—"Proeve eener algemeene physiologische Scheikunde" (1843), translated into German by Prof. Kolbe, under the title of "Versuch einer allgemeinen physiologischen Chemie"; "Die Ernährung in ihrem Zusammenhang mit dem Volkgeist" (1847); "Die Chemie des Weins" (1856); "Die Chemie des Biers" (1858); "Die Silberprobirmethode" (1859); "Die Chemie der

Ackerkrume," 3 vols. (1864); "Beiträge zur Geschichte des chemisch gebundenen Wassers" (1864); "Die Chemie der austrocknenden Oele" (1867). As an editor he published, in connection with Van Hall and Vrolik, the "Bijdragen tot de natuurkundige wetenschappen" from 1826 to 1832. During the six years following he edited the "Natuur-en scheikundige Archief." After uniting for several years with Miquel and Wenckeback in the editorship of the "Bulletin des Sciences physiques et naturelles en Néerlande," he has issued since 1842 the "Scheikundige Verhandelingen en Onderzoekingen" (Rotterdam), the only chemical journal of Holland.

Prof. Mulder was frequently intrusted by his Government with important commissions, and has contributed greatly by his pen and speech to the cultivation of chemistry in Holland. In 1860 he was elected an honorary member of the London Chemical Society. T. H. N.

### NOTES

A CONSIDERABLE number of the Fellows of the Royal Society have decided to add a portrait of Sir Joseph Hooker to the valuable collection of historical portraits belonging to the Society, and they invite others to join in the subscription. Cheques crossed "Barclay and Co., for the Sir J. Hooker Portrait Fund," to be paid to Messrs. Barclay and Co., 54, Lombard Street, E. C.

AT the last meeting of the Chemical Society it was announced that the Longstaff Medal had been awarded to Prof. Thorpe, of the Yorkshire College, Leeds. Prof. Thorpe is the first recipient of the medal.

ON Sunday, May 23, M. Dumas was presented by the Société d'Encouragement with a civic crown, in acknowledgment of the services rendered to science and to France during more than half a century.

THE Emperor of Germany has appointed Prof. Baron von Nordenskjöld a foreign Knight of the Ordre pour le Mérite for Arts and Sciences.

THE Visitation of the Royal Observatory takes place on Saturday.

THE funds for the erection of a monument in memory of the great philosopher, Leibnitz, at Leipzig, have now reached the sum considered necessary, and Prof. Hanel of Dresden is about to execute the monument. It will be erected on the southern side of the St. Thomas Churchyard. The statue of Leibnitz will be of bronze, and will measure  $3\frac{1}{2}$  metres in height. The pedestal will have the same height, and will be adorned by four bas-reliefs.

WE have to record the death of Mr. Alfred Swaine Taylor, F.R.S., the physician and toxicologist. He was born at Northfleet, Kent, in December, 1806. He was a pupil of Sir Astley Cooper and Mr. J. H. Green at Guy's Hospital, and afterwards studied in the leading medical schools of France, Germany, and Italy. In 1830 he entered the Royal College of Surgeons, was admitted a Licentiate of the Royal College of Physicians in 1848, and was elected a Fellow of the same five years later. In 1845 he was chosen a Fellow of the Royal Society. He was the first holder of the chair of Medical Jurisprudence in Guy's Hospital, and was for many years joint-Professor, and subsequently sole Professor, of Chemistry. Dr. Swaine Taylor was the author of several professional treatises, more especially on the subjects of poisons and poisonings, chemistry, and medical jurisprudence; and he had received the honorary degree of M.D. from the University of St. Andrew's.

ON May 15 the Congress of Bohemian Naturalists was opened at Prague. Dr. Albert, of Innsbruck University, was elected

president. Prof. Krejci, a geologist of repute, delivered an address in which he pointed out the importance of German natural science, rather a bold, and certainly commendable, thing to do in the somewhat narrow-minded Czech capital.

THE Swiss Natural History Society will hold its general meeting on September 12-15 next, in the small town of Brieg, in the canton Vaud, at the foot of the Simplon.

WE are pleased to hear that negotiations are in progress for the transfer of the Museum Godeffroy to the City of Hamburg. In it are to be found by far the finest series of the zoological and ethnographical products of the Pacific Islands yet assembled together, including, we believe, all the types of the new species described in the thirteen "Hefts" of the *Journal des Muséum Godeffroy*. It would be a great misfortune to science if these were distributed all over the world by the auctioneer's hammer, so that it is much to be hoped that a satisfactory arrangement will be come to between the liquidators of the "Maison Godeffroy" and the citizens of Hamburg.

THE Emperor of Russia has conferred the Grand Cross of the Order of Stanislaus upon Dr. Hermann Obst, the director of the Ethnographical Museum of Leipzig.

WE would earnestly draw the attention of our readers to the fact that the Secretary of the Smithsonian Institution, Washington, U.S., of which Mr. James Smithson was the founder, is desirous of obtaining information respecting that gentleman to assist in the preparation of a memoir. James Smithson, F.R.S., was the son of Hugh, first Duke of Northumberland, and Elizabeth, heiress of the Hungerfords of Audley, and niece of Charles, Duke of Somerset. In 1826 he resided at Bentinck Street, Cavendish Square. He died in 1829. The following are some of the points on which information is desired:—"John Fitall, a trusted servant of Mr. James Smithson, died June 14, 1834, at Bush House, Wanstead, Essex, England. Have his heirs any relics or mementoes of Mr. Smithson—any notes, letters, &c.? Mr. Charles Drummond, a London banker, was the executor of Mr. Smithson. Can we procure originals or copies of any letters of Mr. Smithson from him? What do the records of the Royal Society say as to the election of James Lewis Macie as a Fellow? Perhaps a report was made to the Council as to his qualifications? What can be learned of the disagreement between Mr. Smithson and the Council of the Royal Society? Mr. Wheatstone knew of it. Do any of the surviving Members remember the circumstances? Information relative to Henry Louis Dickinson (half-brother of James Smithson), Colonel of the 84th Regiment of Foot. Information relative to the college life of James Lewis Macie, a graduate of May 26, 1786, of Pembroke College, Oxford University. Letters from James Smithson to Sir Humphrey Davy, Sir Davies Gilbert, Hon. Henry Cavendish, Dr. W. H. Wollaston, Mr. Smithson Tennant, Dr. Joseph Black, Dr. Hutton, M. Arago, M. Gay Lussac, M. Cordier, M. Haüy, M. Klaproth, M. A. C. Becquerel, M. Fanjas de St. Fond, Mr. Thornton, Mr. Macaire, Mr. Wm. Thomson; or any original letters of Mr. Smithson. Can the original manuscripts be found of Mr. Smithson's communications to the Royal Society or to Thomson's "Annals of Philosophy"? Can Mr. Smithson's authorship of papers or articles in any scientific journals be identified? What can be learned of Mr. Smithson's mother, Mrs. Macie? or of Col. Henry Louis Dickinson's mother, Mrs. Mary Ann Coates? At what number in Bentinck Street did Mr. Smithson reside? (He held apartments, was not a householder.) Had he at any time any other residence; if so, where?" Any information on the above points should be addressed to Prof. Spencer F. Baird, care of William Wesley, 28, Essex Street, Strand, London, the agent of the Smithsonian Institution.

MR. STORY MASKELYNE put his maiden question in Parliament the other evening very appropriately in connection with

the Natural History Museum. Mr. Adam, in reply, stated that the trustees of the British Museum had been informed that they may now proceed to remove their collections to the new Natural History Museum. The question of providing residences for the officers of the museum was considered by the late Government, who did not see their way to comply with the request. At present, therefore, it is not contemplated that any such residences should be erected.

A DIFFICULTY has supervened in the St. Gothard tunnel, which, according to the *Times* correspondent, threatens seriously to retard the completion of the undertaking. In a part of it where the formation is a porous white stone the vaulting has already given way two or three times, and it has required the greatest care and constant staying with timber to prevent the passage thereabouts from completely collapsing. It was thought, however, that a granite wall 6 feet thick would be sufficiently strong to support the superincumbent mass of white stone and keep the tunnel permanently open. A wall of this thickness has just been finished, but it too has begun to give way, and the engineers are at their wits end how to overcome the difficulty. In the opinion of Dr. Stapf, the geologist of the tunnel, it can be overcome only by making a wide curve so as to get round the white stone instead of going through it. This would involve the entire reconstruction of that part of the tunnel, in which case it will probably not be ready for traffic before the time fixed for the completion of the lines of approach, two years hence.

MR. SETH GREEN, writing to the *New York World* of May 14, says that one morning when he was watching a spider's nest a wasp alighted within an inch or two of the nest, on the side opposite the opening. Creeping noiselessly around towards the entrance of the nest the wasp stopped a little short of it and for a moment remained perfectly quiet; then reaching out one of his antennæ he wiggled it before the opening and withdrew it. This overture had the desired effect, for the boss of the nest, as large a spider as one ordinarily sees, came out to see what was wrong and to set it to rights. No sooner had the spider emerged to that point at which he was at the worst disadvantage than the wasp, with a quick movement, thrust his sting into the body of his foe, killing him easily and almost instantly. The experiment was repeated on the part of the wasp, and when there was no response from the inside he became satisfied, probably, that he held the fort. At all events he proceeded to enter the nest and slaughter the young spiders, which were afterwards lugged off one at a time.

IN a series of papers on the northern part of the continent, contributed to an Australian paper under the somewhat odd title of "Northern Lights," the writer mentions a curious feature of the creeks and lagoons in the north of Queensland. This is what is called "floating grass." It is a tall aquatic grass, which, while growing in the mud when within reach, is quite independent in that respect, and extends its creeping stems into the deepest water; and by the interweaving of these, and of the roots emitted from every joint, makes a dense mat of verdure, which, at first sight, seems to have its origin on solid ground. It is however quite possible to walk on it without risk of entanglement. The method is to keep going, lifting the feet well, and with the body in as flat a position as possible. Horses and cattle are fond of this grass, and it is said that the masses of it are sometimes so dense, although with twenty feet of water underneath, that horses have been known to cross on them.

ON the French Eastern Railway Achard electric brakes are being tried, and are said to work satisfactorily. The electricity is not supplied by ordinary cells, but by Planté's accumulating battery.

A MEETING of the Epping Forest and County of Essex Naturalists' Field Club was held on Saturday, May 29, at Buck-



hurst Hill, when a lecture was delivered by Mr. Henry Walker, F.G.S., entitled "A Day's Elephant Hunting in Essex." At the conclusion of the lecture Sir Antonio Brady, who has taken an active interest in the formation of the Club, gave a detailed account of his method of removing and subsequently preserving the mammalian remains from the brick-earth pits at Ilford.

MR. C. S. SARGENT, Harvard Professor of Arboriculture, has published, in his capacity of special agent of the approaching United States census, a "Catalogue of the Forest Trees of North America," preliminary to one which will be added to the census report on the forest wealth of the United States. He desires information concerning the geographical range of any species, the most favourable region and elevation and geographical formation for its multiplication and perfection, its exceptionally large dimensions, its common or local name, and its products and uses.

THE number of persons who die from small pox is increasing daily in Paris. Statistics prove that 858 died in 1879, and not less than 1,038 in the four first months of 1880. This circumstance has created a great impression, and Dr. Liouville, in the Chamber of Deputies, has proposed a law to render vaccination compulsory. It has been reported upon favourably by the committee, and will accordingly in all probability soon become a part of the law of the land.

SEVERAL papers have stated that an official commission will be appointed in France to witness the crossing of the British Channel by a balloon travelling from France to England (weather permitting). The fact is that the experiment is to be made from Boulogne by M. Javis, with his own balloon and at his own risk. But the port authorities have agreed to send M. Javis such information as will enable him to select for starting a time when the wind is blowing with some sufficient prospect of reaching England. M. Javis will keep watch from June 1 to 20. A steamer will follow as far as possible the hardy aeronaut on his adventurous trip.

A BRANCH of the recently-founded Thüringer-Wald Club has been formed at Leipzig. A similar club, at present numbering twenty-five members, has been opened at Plauen (Saxony) with a view of promoting and furthering visits of tourists to the so-called Voigtland. The club will improve the roads, undertake excursions on a larger scale, see to the fixing of proper sign-posts, &c.

ON the shores of the Lake of Constance the rare phenomenon of a perfect solar halo was noticed on May 4 at noon. The large ring, which from time to time assumed splendid rainbow tints, remained visible for more than two hours. At Berlin the phenomenon of mock suns was observed on the 9th inst. at 8 a.m.

INTERESTING discoveries are reported from Italy. Near Este, in the Veneto, at the foot of the Eugancian Mountains, Prof. Prosdocimi discovered a prehistoric burial-ground with many bronze and clay vessels. Eighty-two tombs were found, of which forty four seemed to have been opened already by the Romans, while the contents of the others seemed untouched. The urns belong to three different periods, some are stained black with linear ornaments, others are striped red and black. Some vases are of such exquisite workmanship that they could even to-day serve as patterns. A small case of bronze is adorned with human and animal figures.

M. VAROY, French Minister of Public Works, has visited in state the regional competition of Bar-le-Duc, and gave an address at a banquet. In this competition the most notable feature was the work done on a large field by a Gramme machine and a Fowler plough before the Minister and an immense crowd on

May 23. The electric current also gave motion to some agricultural machines at a distance. This remarkable experiment was conducted by M. Felix, of Germase, a country place in the vicinity of Bar-le-Duc, where similar experiments on a smaller scale were made last year.

THE Twelfth and Thirteenth Annual Reports of American Archæology and Ethnology contain, as usual, several papers of great ethnological interest. From the Report of the curator, Mr. F. W. Putnam, it is evident that much excellent work continues to be done in the museum, which is rapidly becoming one of the most valuable repositories of ethnology in the world. The papers are all connected with American ethnology, the most important probably being that of Mr. Bandelier, on the Social Organisation and Mode of Government of the Ancient Mexicans.

THE *Proceedings* of the Davenport (U.S.) Academy of Natural Sciences, vol. i. part 2, while it contains a number of papers in natural history, is noteworthy mainly for the large number of papers on subjects connected with American ethnology, and chiefly on various mound explorations. We are pleased to see that this society continues to prosper; it had the originality to elect as its president for 1879 Mrs. Mary L. D. Putnam.

NO. 4 of the Columbia College *School of Mines Quarterly* is better than ever, and we are glad to learn that it has successfully passed its brief probationary period, and is now regarded as an assured and unexpected success. Among the articles in this number are "Sanitary Problems of New York City," by Prof. Trowbridge; "Artificial Diamonds," by Mr. Lucius Pitkin; "Volumetric Analysis of Sulphuric Acid," by Mr. A. H. Elliott; "A New Planometer," by Mr. L. M. Hooper.

IN the *Transactions* of the Academy of Science of St. Louis, vol. iv. No. 1, are several papers deserving attention. Mr. N. Holmes has a specially interesting paper on the "Geological and Geographical Distribution of the Human Race," and students of the science of language will be interested in M. Corona y Coludo's account of the Zoque language, spoken in the State of Chiapas, Mexico. There are two magnetic papers by Prof. Nipher, a paper on *Pentremites* by Dr. G. Hambach; on the genus *Pinus* by M. G. Engelmann, who has also a short paper on acorns and their germination.

AS one of their "Occasional Papers" the Boston Society of Natural History have published a volume of great value on the "Geology of Eastern Massachusetts," by Mr. W. O. Crosby. It is evidently the result of long and competent investigation, is well illustrated, and contains a large and well-printed geological map of the region treated of.

THE additions to the Zoological Society's Gardens during the past week include a Grey-cheeked Monkey (*Cercocebus albigena*) from West Africa, presented by the Earl of Lonsdale, F.Z.S.; a Vervet Monkey (*Cercopithecus lalandii*) from South Africa, a Balearic Crowned Crane (*Balarica pavonina*) from West Africa, presented by Mr. Frank Simpson; two Cashmere Shawl Goats (*Capra hircus*) from India, presented by Dr. W. Taylor; an Alexandrine Parrakeet (*Palæornis alexandria*) from India, two West African Love Birds (*Agapornis pullaria*) from West Africa, a Common Raven (*Corvus corax*), European, a Crimson-eared Waxbill (*Estrellda phainotis*) from West Africa, presented by Mr. C. Williams; a South American Rat Snake (*Spilotes variabilis*) from Demerara, presented by Mr. G. H. Hawtayne, C.M.Z.S.; three Cashmere Shawl Goats (*Capra hircus*) from India, a Malbrouck Monkey (*Cercopithecus cynosurus*) from East Africa, a Philippine Paradoxure (*Paradoxurus philippensis*) from the Philippine Isles, three Black Tortoises (*Testudo carbonaria*) from Demerara, deposited; two Purple-faced Monkeys (*Semnopithecus leucopymnus*) from Ceylon, a Ludio Monkey (*Cerco-*

*pithecus India*), an African Brush-tailed Porcupine (*Atherura africana*) from West Africa, three Indian Tantal (*Tantalus leucoccephalus*) from India, an American Bison (*Bison americanus*) from North America, a Schomburgk's Deer (*Cervus schomburgki*) from Siam, two Side-striped Jackals (*Canis lateralis*) from West Africa, two Spotted Hyenas (*Hyana crocuta*) from South Africa, two Crested Screamers (*Chauna chavaria*) from Buenos Ayres, five Black-necked Swans (*Cygnus nigricollis*) from Antarctic America, purchased; an Axis Deer (*Cervus axis*), born in the Gardens.

### OUR ASTRONOMICAL COLUMN

**OCCULTATION OF A FIXED STAR BY SATURN.**—It is recorded by Whiston, in his life of Dr. Clarke, that the father of the latter once saw a star in the dark space between the ring and the ball, though, so far as we are aware, no date for the observation or other particulars have been preserved. Gottfried Kirch, the discoverer of the great comet of 1680, appears to have been very nearly a witness of a similar phenomenon, if indeed his telescope had been equal to the occasion. Observing Saturn at Leipsic on the evening of January 16, 1679, he remarked, about 10h., that the star  $\alpha$  Tauri of Bayer (114 Tauri FL), of the sixth magnitude, was distant only one diameter from the extremity of the ring. The night was changeable, and clouds subsequently interfered, but two hours after midnight he found the star "quartâ forsan parte diametri Saturni, a Saturno distantem." A quarter of an hour later he saw that the distance had sensibly diminished, and in another half hour the star had become so small "adeo ut fermè conspectum fugeret. Neque procul aberat a Saturno, ut spatium inter Saturnum et stellulam, ipsius stellæ magnitudinem non superare videretur;" and he continues: "Stellula postea tangebatur fermè extremum Saturni." An accompanying rough figure shows the star very nearly in contact with the extremity of the ring. Further we read: "Inter primum et secundum quadrantem post horam tertiam nihil dignoscere poteram, primo stellula Saturno adhæsisse mihi videbatur, de quo tamen nihil certi dicere possum, ipse enim dubito; deinde nihil videndum sese offerabat." But although he saw no more, Kirch states that Saturn would necessarily shortly occult the star. On the following evening, at 8h. 30m., the star was distant about a diameter of the planet, or rather, as the figure shows, of the ring. He considered from these observations that the star was in contact at 3 a.m. on January 17, and that the egress took place about 11 a.m. It will be found that Saturn did not set at Leipsic on this morning until nearly 5h. 30m., and by the track of the planet the central distance at conjunction was less than a third of the semi-diameter of the shorter axis of the ring, thus the star might be within the dark space between the ring and the globe before setting. The planet was then about 83' from the node of the ring, which must therefore have been nearly as open as we can see it. Kirch seems to have been well aware of the rarity of such an observation. It was first published in his Ephemerides for 1683.

**THE POLAR COMPRESSION OF MARS.**—In November last Prof. Young made a numerous series of measures of the diameters of Mars with a filar-micrometer attached to the 9.5-inch equatorial of the School of Science Observatory at Princeton, New Jersey, U.S., the object-glass of which is stated to be of the highest excellence, having repeatedly shown both satellites of Mars, the two outer satellites of Uranus, and, it is said, the Saturnian satellite Mimas. Although measures with the wire-micrometer have been found liable to considerable constant error, it was thought they might safely be used in determining a difference of diameter. Mr. Marth's ephemeris was employed in setting the position-circle and in computing the minute corrections for phase. The total number of micrometer-readings was 1,140. The results applicable to November 12, 1879, are as follow:—

Equatorial diameter	...	...	20'634 ± 0'034
Polar diameter	...	...	20'552 ± 0'043
Mean	...	...	20'593 ± 0'035

These absolute values Prof. Young considered not very reliable, being subject to the considerable constant error referred to above.

Dr. Hartwig's determination of the mean diameter of Mars, by combining all the double-image measures at Königsberg,

Leiden, Oxford, Berlin, Paris, and Strassburg, gives for the opposition-diameter in 1879, 19'128, which differs from Prof. Young's result by 1''46, which he says is a difference "rather unexpectedly large, but not unprecedented." As regards the compression, the immediate object of the Princeton measure, the final result comes out  $\frac{11}{17}$ , the limits of probable error extending from  $\frac{11}{17}$  to  $\frac{11}{17}$ . The discussion of the measures was nearly finished, when Prof. J. C. Adams's paper upon the orbits of the satellites of Mars was published; he there gives  $\frac{11}{17}$  as the ellipticity of the planet, if it follows the same law of central density as the earth. This near agreement is probably to a considerable extent an accidental one.

Dr. Hartwig's value for the polar diameter of Mars at distance unity is 9''352, corresponding, with Leverrier's solar parallax, to a real diameter of 4,180 miles.

**THE NEXT TOTAL SOLAR ECLIPSE.**—At the recent annual meeting of the National Academy of Sciences at Washington, Mr. D. P. Todd, of the office of the *American Ephemeris*, communicated a paper "On the Use of the Electric Telegraph during Total Eclipses applied to the Search for Intra-Mercurial Planets," with the view to illustrate in what manner the rare moments of total eclipses may be utilised to their utmost extent, "the method consisting in the electro-telegraphic transmission of important observations made at western stations to observers at eastern stations, with due speed for their verification or rejection when the lunar shadow reaches the latter stations." Taking as an example the next total eclipse of the sun, on May 16, 1882, it is remarked that the path of totality lies almost wholly on land; commencing in Western Africa, with a north-easterly direction, it crosses Upper Egypt and the Red Sea, passing a few miles south of Bagdad and Teheran, and thence traversing Central Asia, it leaves that continent near Shanghai. Thus several widely-separated regions, connected by telegraphic cables and land lines, are upon the track of the central eclipse. Mr. Todd remarks that from El-Akhmym, on the Nile, a line runs north to Alexandria, from which place Teheran is directly accessible by telegraph. From Teheran a land-line runs south-east through Beluchistan and Hindostan to Madras, which is connected by cable-lines with Singapore, Hong-kong, and Shanghai. He points out that an additional advantage attaches to this eclipse from the circumstance that there is a duplicate line of telegraphic connection between Egypt and Shanghai by way of Constantinople, Vienna, and Moscow, and thence by the Russian line through Siberia to Wladivostok, and thence to Shanghai. Supposing, then, that an intra-Mercurial planet were discovered during totality in Egypt, a duplicate message might be sent, to insure beyond doubt that the discovery should be known to observers at Shanghai; if a planet were observed at El-Akhmym, 45 minutes of absolute time elapsing before the shadow reaches Teheran, the position might be telegraphed to the latter station so as to give the observer abundant time to verify the discovery, while observations at both places might be telegraphed to Shanghai, which the shadow will not reach until more than two hours after leaving Teheran. Mr. Todd thinks that the telegraph companies, with the courtesy they have always shown in scientific undertakings, would render every assistance in carrying out such a scheme.

We take this outline from a report of his communication to the American Academy, received from Mr. Todd.

### BIOLOGICAL NOTES

**CHINESE ALLIGATORS.**—Two fine examples of the alligator of the Yang-tse-kiang, of the discovery of which we spoke in our issue of February 13, 1879 (vol. xix. p. 351), have recently been received by Dr. Peters for the Zoological Museum of Berlin. There can be no doubt, we understand, that M. Fauvel is quite right, and that this crocodilian is an undoubted *alligator*—being the first of this genus which has been found to occur in the Old World. It will be recollected that of the remarkable Chondrosteian genus of fishes, *Polyodon*, one of the two known species is also found in the Yang-tse, while the other is confined to the Mississippi.

**FOSSIL CORALS.**—The Cyathocrinidae, as one of the largest and most ancient groups of fossils, appear to belong to a type worthy of attracting continual study. Wachsmuth and Springer (*Proc. Acad. Nat. Sci., Philad., 1879*) unite the genera *Poterocrinus* and *Cyathocrinus* into one family, finding them agreeing in having large oral plates supporting the ambulacral grooves and covering the

ventral disk, but leaving an opening at the oral centre, which is perfectly covered by the apical dome plates. Food-grooves along the vault, closed by two rows of alternating pieces; in the presence of a porous ventral sac, located posteriorly, and closed at the top, in which the anal funtions were subordinate to other offices; in having the calyx constructed of only three rings of plates alternating with each other, proximal plates sometimes imperfectly developed; no interradians. The extreme genera are very distinct, but there are intermediate forms which render it impossible to make a completely satisfactory distinction between successive genera. It is best, no doubt, to recognise (1) the earlier or embryonic types, including *Heterocerinus*; (2) the typical *Cyathocrinidae*, (3) the *Poteriocrinus* type, (4) the *Teacrinus* type, including *Woodocrinus*, (5) and transitional forms towards *Eucrinus*, such as *Eopachycrinus*. Little difficulty is found in referring all *Cyathocrinidae* from the upper Silurian to the close of the carboniferous to one of the groups *Poteriocrinus* or *Cyathocrinus*, although the anal plates vary much in form. In the lower Silurian members of the family this is more difficult, yet careful study gives rise to the idea that the later were probably developed from the earlier Silurian types.

**CIRCULATION IN WORMS.**—The existence of a double circulatory apparatus in a certain number of types belonging to the class of worms has been known; it consists of a closed vascular apparatus containing a red blood without corpuscles, and of the connected lacunæ of the body (not properly a distinct organic apparatus), containing colourless blood with white corpuscles. From a sealed packet lately opened in the Belgian Academy it appears that M. van Beneden had discovered in 1871 a double apparatus and two sanguineous liquids in the lower Arthropoda; this is found in the genera *Clavella*, *Congericola*, and *Lernanthropus*. The vascular apparatus with red blood and contractile walls, very simple in the two former, becomes very complex in *Lernanthropus*. The foliaceous lamellæ fixed to the posterior part of the body are true branchiæ, organised exactly like those of annelids. There is no central organ of circulation; the circulation of the two liquids is caused by contractions of the body. In *Lernanthropus* the branchiæ, abdomen, and cephalothorax contract and spread alternately.

**LARGE CUTTLE FISH.**—All exact information about gigantic Cephalopoda is of interest not only as showing what immense marine creatures do exist, but as preparing us for the possibility of meeting with still greater. Prof. Verrill has collected a great deal of accurate and recent information as to the North American species, of which he publishes a list in the April number of the *American Journal of Science*, from which we cull the following:—On November 2, 1878, a fisherman was out in a boat with two other men near Leith Bay Copper Mine, Notre Dame Bay, when they observed some bulky object not far from shore, which they approached, thinking it might be part of a wreck. To their horror they found themselves close to a large fish having big glassy eyes. It was making desperate efforts to escape, and was churning the water into foam by the motion of its immense arms and tail. Finding it partially disabled, they plucked up courage and threw the boat's grapnel, which sank into its soft body. By means of the stout rope attached to the grapnel and tied to a tree the fish was prevented going out with the tide; its struggles were terrific as, in a dying agony, it flung its great arms about. At length it became exhausted, and as the water receded it expired. Its body, from the beak of the mouth to the extremity of the tail, measured twenty feet, and one of the tentacles, or arms, measured thirty-five feet. This is the largest specimen yet measured of *Architeuthis princeps*. Prof. Verrill mentions eighteen species as now known on the north-eastern coast of America.

**STERNUM IN DINOSAURS.**—Prof. O. C. Marsh describes, in the *American Journal of Science* for May, 1880, the sternum in *Brontosaurus excelsus*. The Yale Museum has recently received a nearly complete skeleton of this, one of the largest known Dinosaurs. This huge skeleton lay nearly in the position in which the bones would naturally fall after death, and fortunately the entire scapular arch was in excellent preservation. The coracoids were in apposition with their respective scapulae on each side, and between them lay two flat bones that clearly belong to the sternum. This discovery, as interesting as it was unexpected, removes the main uncertainty about the scapular arch of Dinosaurs, and likewise indicates a new stage in the development of this structure, not before seen in adult animals. These two sternal bones are suboval in outline, concave above and convex

below. They are parial, and in position nearly or quite joined each other on the median line. The anterior end of each bone is considerably thickened, and there is a distinct facet for union with the coracoid. The posterior end is thin and irregular. The inner anterior margin of each bone is smooth and rounded, and gives no evidence of union with an episternal element, which the vacancy there suggests. The amount of cartilage between these two sternal bones or posterior to them is not indicated by the present specimens. They were evidently separated by cartilage from the coracoids. The nearest analogy among living forms to this double sternum may perhaps be found in immature birds. A close resemblance is apparent in the scapular arch of the young American ostrich. If the ossification of the sternum were permanently arrested at this stage it would afford almost precisely the structure seen in the genus *Brontosaurus*; and this is evidently the true explanation of the fossil specimens. It is more than probable that in many Dinosaurs the sternum long remained cartilaginous, or so imperfectly solidified that it is not usually preserved. Several specimens of the genus *Camptonotus*, found nearly in their natural position, were apparently destitute of an ossified sternum. The large size, and doubtless great age, of the specimen of *Brontosaurus* above mentioned may perhaps have been the cause of its more perfectly developed sternum.

**ANTIPATHARIA OF THE "BLAKE" EXPEDITION.**—In vol. iv. No. 4 of the *Bulletin of the Museum of Comparative Zoology* at Harvard College, Cambridge, Mass. (February), L. F. Pourtales describes twelve species of this interesting group taken in the Caribbean Sea (1878-79). In determining the species an attempt has been made to use the differences in the shape of the polyps, as well as the disposition and form of the spines to draw characters for a much-needed revision of their classification. It would seem as if there were at least two different types of spines: the triangular compressed and the more cylindrical. These latter are generally more densely set, even assuming sometimes a brush-like appearance, as in *Antipathes humilis*, a new and wonderfully spinous species, figured but not described by Pourtales. These cylindrical spines are also unequal on the two sides of the pinnules, being longer on the side occupied by the polyps, with a few very much longer around the polyps. The triangular spines are disposed regularly in a quincuncial order around the pinnules, and in a cleaned specimen nothing indicates the place formerly occupied by the polyps. In one species, however, *A. desbonni*, the spines are in regular verticils. There would appear to be a connection between the shape of the polyps and the shape and disposition of the spines. Those species with triangular spines have polyps with longer tentacles than those with cylindrical spines, and the tentacles have a greater tendency to become regular in shape. In many species the tentacles are simply contracted; in a very few they were found retracted, as figured by Lacaze-Duthiers; and in some they are probably not retractile at all. Eight out of the twelve named are either described or figured as new species. *A. spiralis* is a very interesting species, formerly referred to *A. desbonni*, D. and M. The polyps are alternately large and small, with very large digitiform tentacles, much longer than have been figured of any antipathes before. In the spaces between successive polyps the canosarc shows transverse canals, and those on the back part of the branch are more transparent than the rest.

**AMERICAN (EAST COAST) SIPHONOPHORA.**—In the March and April *Bulletin of the Museum of Comparative Zoology* at Harvard College, Cambridge, Mass. (vol. vi. 5-7), Mr. J. Walter Fewkes gives a sketch of the development of the tentacular knob of *Physophora hydrostatica*; he describes the mantle-tubes of *Apoletmia wvaria* and *Gleba hippopus*, the tubes in the larger necto-calyx of *Abyla pentagona*; he adds some critical remarks on the genera *Halistemma*, *Agalma*, and *Agalmopsis*, and he concludes with a notice of the forms of Siphonophora and Velellidae, to be met with on the eastern coast of the United States. Up to the present few forms of either of these groups have been described from American waters. They seem to be only occasional visitors blown into the neighbourhood from mid-ocean, and brought there from the tropics by the Gulf Stream. The wealth of such species that one meets with in the Mediterranean is unknown on the New England coast; while, as the author says, in one day at Nice he has taken eight different genera of Siphonophora, yet at Newport he has but rarely taken as many as two genera in the length of a summer's day, and a whole summer once passed, during most of which he was almost daily on the water without one species being seen. One

or two species of Physalia are, however, more common on the United States coasts than in the Mediterranean. The only member of the long-stemmed Siphonophoræ provided with a float or air-bladder found heretofore on the New England waters is *Agalmopsis cara*. Mr. Fewkes can now add *A. elegans*, and he thinks that extended observation in the southern bays of the country will bring to light some of the well known forms common to all oceans, such as *Apolesia*, *Abyla*, *Physophora*, and *Gleba*. Some of these have already been taken in the Gulf of Mexico and the Caribbean Sea. *Rhizophysa*, found in the same localities, might also be expected to be brought to the Eastern American coasts by oceanic currents.

**PARASITE ON THE AMERICAN BLUE PIKE.**—In the *American Journal of Microscopy* for March, Prof. D. S. Kellicott describes a new species of *Argulus* found on the blue pike (*Stizostethium salmoneum*, Jord.). The fishermen of the Niagara River at Buffalo say that when the water becomes warm the fish gets too lazy to take food, that it then loses flesh, and through its inertness becomes infested with these lice. Having given this subject especial attention, Prof. Kellicott is inclined to think the account of the fishermen is correct. The parasite occurs usually on the top of the head of the fish. When there are several they are, as a rule, huddled together often in heaps, so that the knife may remove a number at once; it occurs also on the fins. None were found in the mouth cavity. As many as twenty were taken from one lean fish. When living specimens of the *Argulus* were placed in a tank with a small specimen of *Lepidosteus osseus* and some minnows, they shortly fixed on them, and the minnows soon died, apparently killed by the parasites. When first put in, the fish would pursue and catch them, but would eject them with a suddenness and a queer expression that was most amusing. In a few moments they were left unnoticed by the minnows. The gar recoiled in evident fear when one would be seen approaching. A large female once fastened on to the end of the long nose of the gar, where it clung for several days, despite the vigorous efforts of the fish to dislodge it. Cold weather seemed to destroy them: the fishermen assert that after frost the blue pike become fat, and then no lice are found on them. The species is called *A. stizostethii*. The author believes—against the assertion of Leydig—that the abdominal lobes have a function of respiration above all other parts of the body, and he describes with a good deal of detail the appendages to the several legs.

**MOTION IN ALGÆ.**—From some interesting observations recently made by Herr Stahl, as to the influence of light on the motions of algae (*Verhandl. der phys.-medic. Gesellsch. in Würzburg*, Bd. xiv.) it appears that light has a directive influence on *Closterium moniliferum*, the cell of which tends to place its longitudinal axis in the direction of the light rays, and a certain opposition appears in the two halves of the cell, such that one half is attracted to the light and the other half repelled. Further observation showed that the closteria underwent periodic changes, in virtue of which the two halves alternately at successive intervals turned towards the light. These experiments were made with diffuse daylight of little intensity. When the intensity of the light was increased, the orientation of the closteria was changed; the position parallel to the light rays was given up, and the cells placed themselves at right angles to the incident light. This cross position could be again exchanged for the parallel one by deadening the light. Whether temperature has much to do with these positions of closteria has not yet been determined; the temperature of the minimum seems to be not without action on the period between two reversals. The foregoing experiments should be made with quite healthy vigorous closteria. Some other phenomena of orientation were observed by Herr Stahl in *Micrasterias rotata* and in a species of *Mesocarpus*.

### GEOGRAPHICAL NOTES

THE fiftieth anniversary meeting of the Geographical Society was held on Monday afternoon, the Earl of Northbrook presiding. Apart from the flourishing condition of the Society, both numerically and financially, the most interesting feature in the Council's Report was the part relating to the annual grant for scientific purposes. During the past year a plan was put into operation for giving practical instruction to intending travellers in the use of instruments for astronomical observations to fix positions, in surveying, and in the measurement of heights by barometric and hypsometrical methods. This attempt to improve the scientific training of our travellers has already met with

considerable success, and several of the pupils who have received instruction have left for China, Afghanistan, Central Africa, Central Asia, &c. In order to facilitate the instruction in astronomical work, an observatory has been built on the roof of the Society's house. The medals and other awards were afterwards distributed by the President, Count Piper, the Swedish Minister, receiving for Prof. Nordenskjöld a copy of a special vote of thanks and his diploma as Honorary Corresponding Member, as well as the royal medal for Lieut. Palander. Mr. W. Giles received the other royal medal for his cousin, Mr. Ernest Giles, and Mr. R. N. Cust the gold watch awarded to Bishop Crowther for his services on the Niger. A copy of a resolution of the Council, eulogistic of his "History of Ancient Geography," was also read and handed to Mr. E. H. Bunbury. The gold and silver medals having been given to the successful candidates in the recent public schools prize examination, the ballot was taken for the new council, resulting in the election of Lord Aberdare as President, and Mr. John Ball, F.R.S., Sir Fowell Buxton, Mr. J. K. Laughton, Sir George Nares, Lord Reay, and Sir Richard Temple, in the place of the retiring members of council. In the course of his annual address Lord Northbrook summed up the results of recent explorations in the Arctic regions, in Asia, and in Africa, as well as of Admiralty surveys in various parts of the world.

HERR VON BOGUSLAWSKI publishes, in the *Annalen der Hydrographie*, the conclusions to which he has been led by recent observations on ocean temperatures:—1. The waters of the North Pacific are in general colder than those of the North Atlantic. 2. The waters of the South Pacific are warmer than those of the South Atlantic, to a depth of 1,300 metres; beyond that they are colder. 3. The bottom temperatures are generally lower in the Pacific than in the Atlantic at an equal depth and in the same degree of latitude; but we do not find any part of the temperature in the former as low as those of the Antarctic part of the South Atlantic between 36° and 38° S. lat. and 48° and 30° W. long., where in seven places temperatures of -0°·3 to -0°·6 were found. 4. In the west part of the Pacific and in the neighbourhood of the Indian Archipelago, the temperature of the water reaches its minimum at depths which vary from 550 to 2,750 metres, and remains the same from that depth downwards. In all the Atlantic the temperature from 2,750 metres lowers slowly but regularly.

THE Council of the German African Society has now arranged with the King of Belgium, as president of the International African Association, that, instead of carrying out their former intention of establishing a German station on the southern bank of Lake Tanganyika, their expedition, which is now at Zanzibar, preparing for their tour into the interior, shall first establish a station at Mangasa; that, however, the right to found a second station near Lake Tanganyika shall be reserved to them. Dr. Pogge of Mecklenburg, already well known through his African travels, will become the director of this second station, which will now perhaps be established at Musumba, the capital of Muata Tamwo. This station will form a link in a complete chain of small settlements which are to extend all over the Dark Continent.

A LETTER in the *Deutsche Zeitung* announces that, after five months of unremitting toil, the Austrian African traveller Marno has been able to break through the obstacles on the White Nile caused by the unchecked growth of twenty months, and has re-opened the navigation for trade and passenger traffic. Accompanied by the photographer Buchta, also an Austrian subject, Marno had made a trial trip on a small steamer belonging to the Egyptian Government, penetrating as far as Ladova, and returning safely.

A LIST of 25,000 geographical terms in most frequent use has been drawn up in Chinese by Li Fêngpao, Chinese Minister at Berlin, with the assistance of Dr. Kreyer and Dr. Allen. This list is the basis upon which a large atlas of the world on Mercator's projection has been prepared and photolithographed at Berlin. It also represents the nomenclature employed by Dr. Kreyer in a translation of Daniel's Geography, a large standard work in sixteen Chinese volumes.

WE regret to learn that Père Horner, who has been a true friend to many an African explorer, died at Bordeaux on May 20. He had but recently returned from Zanzibar, where he had resided for many years, and had taken an active interest in all attempts to put down the slave-trade in Eastern Africa, and in

this connection we believe that he rendered valuable service to Sir Bartle Frere during his mission to Zanzibar.

THE *New York Herald* of May 14 says:—The evidences multiply which go to show that there has been an early and exceptionally large break-up of the ice-fields within the Arctic basin since the sun crossed the Equator. The extraordinary mildness of the last winter was universally marked east of the Rocky Mountains, and it would seem the abnormally high temperature extended far to the north and made its impression on the icy seas. Off the coast of Newfoundland the recently reported ice drift will be memorable not only for the magnitude, but also for the multitude of the icebergs and the ice-fields. On the western side of the continent the winter reports indicated a milder season in the vicinity of Behring Sea and its Polar approaches. It is not improbable, therefore, that the steamer *Corwin*, about to sail for the relief of the missing whalers and to communicate with the American Arctic expedition in the *Jeannette*, will find that the premature development of the spring has already loosened their icy bonds, and that they are preparing to pursue their respective routes. The sun's power may be insufficient to dissolve the *Jeannette's* solid moorings, but the mighty agency of winds and waves attending the storms that sweep the ocean north of Behring Strait in May and early June may be expected to break up the ice off Wrangell Island and accomplish her release sooner than if she had wintered on the north-east side of Arctic America.

### UNIVERSITY AND EDUCATIONAL INTELLIGENCE

CAMBRIDGE.—Prof. Humphry's Rede Lecture on man was interesting and eloquent, if on the whole rather depressing. He pleaded for long and patient investigation, especially in coming to the discovery or comprehension of any process, whether of natural selection or any other, by which the large cranial cavity of man can have been evolved in early men. He gave full weight to the argument from the size of the brain at birth, and the perfection of the lungs at the same period. At any rate the brain of primitive man appeared to have been structurally fitted for higher duties than they were ever called upon to perform. His brain was prophetic of his future. Ability is to be measured by the power to deal with the material before us; and thus it is doubtful whether the ability of the present was greater than that of preceding generations, prehistoric or historic. Progress did not necessarily imply improvement, and increased means did not imply greater power, however they might enable power to be wielded with better effect. The physical capability, he thought, long preceded functional activity; and man's advance to civilisation was the result of the response of his nature to his conditions. He believed in the great value of contact and blending of varieties, and attributed the stationary condition of certain races partly to their early progress keeping them exclusive, and to the physical conditions which had walled them in. The climate of the temperate portions of the Eurasian Continent proved favourable to the development of the energies of mammals and men, and the configuration of the northern continent was especially favourable to migration. Thus there had nowhere been through any long period the still dulness of pure blood or the cramping domination of one power. The mingling of races in Britain, in a land of great natural advantages and resources, had led to the development of ability in the people to work out freedom, to invent, to adopt international conventions, and to free others. But he perceived dangers in the increased sensitiveness accompanying the great subdivision of labour nowadays. Of the two evils, learned feebleness was a greater evil than ignorant strength. The preservation of the weak and sick did not make the mass of people stronger and healthier; thus there must be sterner sanitary precautions as a foremost question. Would that some of the time spent on Burials Bills could have been spent in considering the dying needs of the health of the living. This misapplication of energy, said the Professor, had its parallel in the mistaken efforts to prevent the investigations by which physiology might be advanced and the laws of health educed. Few things would tend to the improvement of the race so much as judicious matrimonial selection, and he hinted at the importance of providing a healthy race for the future. Finally, as to man's body at least, and its future, he felt compelled to say that we found ourselves floating on the stream of time; the barque, we suppose, moves on. Sufficient for the day must be

the knowledge thereof. Whether we peer fore or aft, it is obscurity.

SIR GEORGE JESSEL, the Master of the Rolls, has been elected Vice-Chancellor of London University, in place of Sir John Lubbock, who resigned on his becoming a candidate for the representation of the University in Parliament. The election is not likely to be contested.

### SOCIETIES AND ACADEMIES LONDON

Linnean Society, May 24. Anniversary Meeting.—Prof. Allman, F.R.S., president, in the chair.—At this, the ninety-second annual general meeting, there was a large attendance of the Fellows. The President, after a few introductory remarks of congratulation on the prospects of the Society generally, referred to the obituary, pointing out that several of the oldest members would now no longer appear on the list. Among others, Prof. T. Bell (*at. 87*), J. Miers (*at. 91*), Gen. Munro, Dr. David Moore, Wilson Sanders, E. W. Cooke, R.A., Fellows, and T. Atthey, Associate, besides Foreign Members of high standing, showed a heavy death-roll. The Secretaries and Treasurer, after full term of service, had proposed to resign, and as a matter of form this had been acceded to by the Council. The Secretary (Mr. F. Currey) then read his report. Since the last anniversary the Society had lost by death ten Fellows, three Foreign Members, and one Associate; and three Fellows had withdrawn. On the other hand, there had been an accession by election of twenty-eight new Fellows, three Foreign Members, and four Associates. The library showed a marked increase and improvement, by additions obtained by purchase, exchange, and donations, and had been amply used in biological reference and loan of books. The scientific communications and exhibitions at the meetings during the session had kept pace with the march of science, and the attendance of the Fellows bore witness to the active interest taken in the proceedings generally.—The Treasurer (Dr. J. Gwyn Jeffreys) then read his report. In resigning office he congratulated the Society on its increasing prosperity in a financial point of view. Notwithstanding the late depression of commerce, which had to a greater or less extent injuriously affected other scientific societies, as well as the additional yearly expenditure consequent on the removal to Burlington House, and the greater amount of salaries paid, the publications had not been restricted; considerably more having been spent on the library than formerly. The Society is quite free from debt; has an invested capital of £3730 12s. 8d., and the balance at bankers and on hand at this date is £522 18s. 2d. Twelve months ago, owing to the unfortunate and long illness of the Librarian, his accounts became confused, and the Asst.-Secretary had since undertaken the receipts and payments, and had the books thoroughly balanced. A Special Committee had also been appointed by the Council for investigating the financial position of the Society, and their valuable suggestions had been adopted, especially as to the reasonable limitation of the publication expenses, which had increased from £796 14s. in 1876 to £1100 5s. 1d. in 1879. With respect to the compositions, which, even if they were altogether invested, must seriously diminish the income of the Society, the Treasurer stated that during his five years of office he had received £1968, and invested £920 15s. During the previous five years no part of the compositions appear to have been invested. He had also received and invested £840 for legacies. The Society's capital had been doubled; it was in 1875 £1860, and is now £3730 12s. 8d. The annual contributions received in 1876 amounted to £694 13s., and last year to £948 12s. The ballot for Council and Officers having been proceeded with, the following gentlemen retired from the Council:—Messrs. J. Ball, W. Carruthers, F. DuCane Godman, Dr. A. Günther, and the Rev. G. Henslow. In their places were elected:—Messrs. E. R. Alston, G. Bentham, G. Busk, Dr. M. Foster, and B. D. Jackson. For the Officers, Prof. G. J. Allman was re-elected President; Mr. Fredk. Currey (the outgoing Secretary), Treasurer; Mr. B. Daydon Jackson, Botanical Secretary; and Mr. Edward R. Alston, Zoological Secretary.—Prof. Allman thereafter gave his usual annual address, taking for his subject "The Vegetation of the Riviera, a Chapter in the Physiognomy and Distribution of Plants." In this address (not well adapted for brief abstract), by a few broad outlines, a sketch of the most striking features of the vegetation and its peculiarities as derived from the physical contour of the country, geographical position, and climate, was given. The phenomena extant are of high interest

to the botanist, for though belonging to the European area, the Riviera exhibits in climate and character of vegetation an obvious link between the temperate and tropical zones. Its accessibility and singular flora, with scenes of unrivalled beauty, offer ample material for study.

Statistical Society, May 11.—Dr. W. A. Guy, F.R.S., in the chair.—Two papers were read: the first by Capt. P. G. Craigie, Secretary of the Central Chamber of Agriculture, on ten years' statistics of British agriculture, 1870-79, and the second by Messrs. J. B. Lawes and J. H. Gilbert, on the home produce, imports, consumption, and price of wheat, over twenty-eight harvest years, 1852-53, to 1879-80, inclusive. Messrs. Lawes and Gilbert in their paper arrived at the following conclusions:—The area under wheat was about 20 per cent. less over the last three than over the first eight years of the twenty-seven. The average produce per acre over the United Kingdom amounted to only 27½ bushels over the whole twenty-seven years as compared with 28½ bushels which we had previously assumed to represent the average produce per acre of the country at large. The annual imports averaged about three times as much over the last three as over the first eight of the twenty-seven years. The total consumption of wheat per annum had increased from an average of about 18 million quarters over the first eight years to nearly 24 million quarters over the last three years. The price of wheat per quarter had declined from an average of 57s. 8d. over the first eight years (including the period of the Crimean war) to 49s. over the last three years. The annual value of the home produce available for consumption had declined from an average of nearly 38,000,000l. over the first eight years, to less than 25,000,000l. over the last three years. The annual value of the imported wheat had increased from an average of little more than 13,000,000l. over the first eight years, to more than 33,000,000l. over the last three years. Over the whole period of twenty-seven years, 40·4 per cent. of the wheat consumed had been derived from imports; and the amount supplied from foreign sources had increased from an average of 26·5 per cent. of the total over the first eight years, to 57·4 per cent. of the total consumed over the last three years of the twenty-seven.

PHILADELPHIA

Academy of Natural Sciences, January 6.—On the nudibranchiate gastropod mollusca of the Northern Pacific Ocean, with especial reference to those of Alaska, by Dr. R. Bergh, Copenhagen (Part 2).—The terrestrial mollusca inhabiting Cook's Islands, by Andrew Garrett.

January 27.—Carcinological notes: Revision of the *Gelasini*, by J. S. Kingsley.—On the Pacific species of *Caulolatilus*, by W. N. Lockington.

PARIS

Academy of Sciences, May 24.—M. Edm. Becquerel in the chair.—The following papers were read:—On the secular variations of the mathematical figure of the earth, by M. Faye. Regarding the anomaly of the small action of such masses as the Himalayas on the pendulum, and the great attractive force often found at sea, he points out that under seas the cooling of the globe proceeds more quickly and deeply than under continents. The bottom of the first seas would thicken in advance of the dry crust, and would press increasingly on the liquid nucleus, raising the weak parts of the first crust, which were mostly round the North Pole. The water level would rise on our hemisphere and fall on the southern, and the ellipsoid of revolution become a simple spheroid. With further cooling the basins of the southern seas would have increasing attraction and the waters would gradually rise in the southern hemisphere, their surface of level returning to the ellipsoidal form, which, M. Faye thinks, is slightly exceeded at present. Thus the earth's crust shows an alternate balancing movement determined by excess of weight of maritime crusts and the points of less resistance (in the heart of continents).—On the refrigerating mixtures formed by an acid and a hydrated salt, by M. Berthelot. The chemical energies act according to the principle of maximum work, giving a first exothermic reaction; then the calorific energies act inversely, causing absorption of heat under the four-fold form of dissociation, disaggregation by the solvent, dissolution, and liquefaction.—Action of acids on alloys of rhodium with lead and zinc, by M. Debray. He describes a peculiar substance (decolorizing at about 400° with heat and light) obtained from treating the rhodium-lead alloy with nitric acid. Rhodium forms, with zinc, alloys which may exist in two isomeric states, giving very different

reactions.—Determination of the position of a bridge to be constructed over the Danube, near Siliustria, by M. Laligère.—On the transcendents which play a fundamental part in the theory of planetary perturbations, by M. Callandrea.—On the theory of ideal complex numbers, by M. Dedekind.—Integration of certain differential equations with the aid of functions  $\Theta$ , by M. Appell.—On elimination, by M. Le Paige.—Industrial utilisation of solar heat, by M. Mouchot. He has been experimenting near Algiers since May last year. He specifies improvements (e.g., an arrangement for keeping the liquid to be vaporised in contact with the whole heated surface), and indicates results. *Inter alia*, since March the receiver has actuated a horizontal engine (without expansion or condensation) at the rate of 120 revolutions a minute with constant pressure of 3·5 atm.; the disposable work being about 8 kgm. he set it to work a pump giving 6 litres per minute at 3·50 m., or 1,200 litres per hour at 1 m., and to throw a jet 12 m. This goes on from 8 a.m. to 4 p.m.—Combinations of alcohols with baryta and lime; products of decomposition, by heat, of these combinations, by M. Destrem.—Reactions produced between ammoniacal salts and carbonates of lime, by M. Nivet. A double decomposition is shown to occur in the ground and in water, the result being a loss of ammonia, which is greater, the less absorbed the soil, or the less the quantities of CO<sub>2</sub> formed in it.—On the formation of callosity, by MM. Rigal and Vignal.—Experiments relative to peritoneal shock, by MM. Reynier and Richet.—On the form and the seat of movements produced by cortical excitation of the brain, by M. Couty. There is no relation between the cortical region excited and the form or the place of the motions. Explanation of the phenomena is possible only by admission of the theory that the cortical white fibres are conductors of bulbo-medullary excitations, and comparable to the peripheric conductors, notwithstanding their course and their much more complicated connections.—On the fixing power of certain organs for alkaloids introduced into the blood which traverses them, by M. Héger. The hepatic tissue retains most; the lungs absorb very little.—Discovery of horse-pox vaccination, by M. De Pietrasanta. Several heifers were successively (and with effect) inoculated in Paris with lymph from a young blood horse which had come from Germany, and had horse-pox.—On a phenomenon of sensibility observed in acacia, by Mr. Phipson. He obtained this by striking the terminal leaflet several times with his finger.—On the tertiary strata of Brittany; envisions of Saffré (Loire-Inférieure), by M. Vasseur.—M. Dubrunfaut returned several pieces (letters, memoirs, and reports) belonging to the Archives of the Academy.

CONTENTS

	PAGE
SIGN LANGUAGE AMONG THE AMERICAN INDIANS. By Prof. A. H. SAYCE . . . . .	93
TESTING TELEGRAPH LINES . . . . .	94
OUR BOOK SHELF:—	
Johnston's "Physical, Historical, Political, and Descriptive Geography" . . . . .	95
"Zeitschrift für das chemische Grossgewerbe" . . . . .	95
LETTERS TO THE EDITOR:—	
The Lesser Spotted Woodpecker.—THE DUKE OF ARQUEL . . . . .	95
Mr. Preston on Vortex Atoms.—G. H. DARWIN, F.R.S. . . . .	95
The Inevitable Test for Auriferous.—DR. WARREN DE LA RUE, F.R.S.; DR. HUGO MÜLLER . . . . .	96
Cloud Classification.—E. H. . . . .	96
"Chipped Arrow-Heads."—DR. R. W. CORPINGER . . . . .	97
Cup and Ring Stones.—J. ROMILLY ALLEN . . . . .	97
Songs of Birds.—A. N. . . . .	97
COMPARATIVE ANATOMY OF MAN, III. By Prof. FLOWER, F. THE UNITED STATES WEATHER MAPS, SEPTEMBER, 1877. . . . .	100
CONTRIBUTIONS TO MOLECULAR PHYSICS IN HIGH VACUUM. WILLIAM CROOKES, F.R.S. (With Illustrations) . . . . .	103
ROCK-WEATHERING, AS ILLUSTRATED IN CHURCHYARDS. I. GEIKIE, F.R.S. . . . .	104
GERHARD JOHANNES MULDER . . . . .	105
NOTES . . . . .	105
OUR ASTRONOMICAL COLUMN:—	
Occultation of a Fixed Star by Saturn . . . . .	111
The Polar Compression of Mars . . . . .	111
The Next Total Solar Eclipse . . . . .	111
BIOLOGICAL NOTES:—	
Chinese Alligators . . . . .	11
Fossil Corals . . . . .	11
Circulation in Worms . . . . .	11
Large Cuttle Fish . . . . .	11
Sternum in Dinosaurs . . . . .	11
Antipatharia of the <i>Blake Expedition</i> . . . . .	11
American (East Coast) Siphonophora . . . . .	11
Parasite on the American Blue Elk . . . . .	11
Motion in Algae . . . . .	11
GEOGRAPHICAL NOTES . . . . .	11
UNIVERSITY AND EDUCATIONAL INTELLIGENCE . . . . .	11
SOCIETIES AND ACADEMIES . . . . .	11

THURSDAY, JUNE 10, 1880

## "OLD NORWAY"

*Die Geologie des südlichen und mittleren Norwegen.*  
Herausgegeben von Dr. Theodor Kjerulf; autorisirte  
deutsche Aufgabe von Dr. Adolf Gurlt. (Bonn: Max  
Cohen und Sohn, 1880.)

IN that rugged northern land where the mingled Atlantic and Arctic tides course round a network of islands, and lave the shores of deep lonely fjords, sending their waters far inland to the very base of snowfield and glacier, the people, with the patriotism of mountaineers, sing enthusiastically of "Gamle Norge"—Old Norway. And well may they sing of a land that by its scenery and climate has moulded their habits of thought, their traditions, their literature, and has knit their bodily frames into that muscular type for which the hardy Norsemen have been famous from time immemorial. Dear Gamle Norge! The sound of its praise awakens a responsive chord in the breast of many a Briton, leading him to reflect how much of the vigour and success of his own countrymen may be due to the fresh blood which came to them from the robust north, and reminding him of the wild creed and spirit-stirring songs which his ancestors shared with their kinsmen of the northern fjords. Well may men speak of "old" Norway. Even as regards human records, its antiquity goes back far enough to merit that appellation. But if we pass to the earlier history of Europe the fitness of the epithet becomes singularly impressive. To that northern region of tableland and valley the geologist looks as the cradle of this continent. The plains of Russia and Germany are formations but of yesterday. The Urals, the Alps, the Pyrenees, the high grounds of Bohemia, Saxony, and Central France have appeared at various widely separated epochs, and have undergone many vicissitudes in a long course of ages. But the uplands of Scandinavia, though they too have not been without their mutations, already existed as land almost at the beginning of those ages which are chronicled in the rocky records of the earth's crust. From the sand and mud washed down from these uplands the formations have been derived out of which, for example, most of the highlands of Scotland, Wales, and Ireland have been built up. So far as we can tell, the earliest land of Europe rose in the north and north-west. The subsequent growth of the continent has been over the tract of shallow sea by which the first land was bounded.

There is thus a peculiar interest in the study of the geological structure and history of Scandinavia. It is in that region that by far the largest fragment of archæan Europe exists and that the data are chiefly to be sought from which the earliest chapters of European geological history must be written. Most cordially, therefore, will all geologists welcome the volume which Dr. Kjerulf has just published for their information. It is by much the most important summary of Norwegian geology which has yet appeared.

In an interesting preface a sketch is given of the progress of geological inquiry in Norway. After numerous private and unconnected researches by natives and

foreigners in different parts of the country, a systematic geological survey of the country was in 1858 projected by Dr. Kjerulf and Bergmeister Tellef Dahll, and on the approval of the plan by the Norwegian Government, was commenced at the national expense. Its main object was to make a geological map of the country with the requisite sections. The Survey was organised very economically under Kjerulf and Dahll, with no special office, no place to store specimens, no laboratory, and no official channel of publication for its memoirs. With praiseworthy enthusiasm the two geologists continued for ten years to work in the field during the brief Norwegian summers, either together or singly, taking with them as volunteer assistants such students of mining and others as chose to accompany them. In 1866 Dahll undertook the investigation of Northern Norway, so that the charge of the Central and Southern provinces then fell to Kjerulf. The latter geologist, with the assistance of other observers, whose share in the work is duly chronicled, has at intervals published maps and sections of the area under his control, and in particular a general map on the scale of one-millionth. As a fit conclusion to the labours of a quarter of a century among the geological formations of Norway, he has published at Christiania a quarto volume with an atlas of plates, giving a concise account of the geological features of the central and southern part of the country.<sup>1</sup> This work is in Norse; but the author, with the view of making it more widely known, has intrusted it to Dr. Gurlt, who has rendered it successfully into German, and has had it republished in a convenient form.

Every student of metamorphism and the crystalline schists must procure Dr. Kjerulf's work. It contains a store of facts of the utmost importance for all theoretical questions in this most interesting and difficult department of geology. At the same time the superficial geology is not neglected. The first part of the volume treats of the loose surface formations—especially of the erratic blocks, moraines, and glacial striae. These phenomena are illustrated by maps, on one of which—that of the striated rock-surfaces—an explanatory remark affords a characteristic sample of the author's cautious spirit of observation:—"The directions of the striae are expressed on the map, as in nature, by lines; the observer must himself judge whence they come and whither they go." The second part, devoted to a summary of the geology of the Christiania district, contains a table of fossiliferous deposits, which, extending from the base of the Primordial zone to the top of the Upper Silurian formations, are shown to attain there a thickness of 2,700 feet. There is likewise an important tabular statement of the horizons of the leading organic remains of these older palæozoic deposits. In Part III. a description is given of the "Grundgebirge," or fundamental rocks of Southern Norway. The author shows that though these have sometimes been classed under the general term gneiss, they contain other rocks, especially various schists, quartzites, conglomerates, and limestones, and that gneiss is rather a structure belonging to rocks of different ages than a formation of one geological date. He regards the bottom gneiss as a metamorphic representative of ordinary sedimentary formations, in

<sup>1</sup> "Udsigt over det Sydlige Norges Geologi" (Christiania, 1879).

particular of the so-called "Sparagmite" or fragmental accumulations below the Primordial zone. He believes that the older gneiss may include metamorphosed portions of younger formations, in particular considerable masses of the Primordial rocks. This question in another form is discussed in Part IV., which treats of the geology of Central Norway. To the oldest sedimentary formations, termed the Sparagmite series, a thickness of 2,300 Norwegian feet is there assigned. They consist of sandstones, conglomerates, schists, slates, and limestones. Above them lie the Primordial beds, 2,900 feet thick, composed of quartz-schists, mica-schists, "blue-quartz," sandstones, clay-slates, and limestones, among which are found the earliest fossils (*Dictyonema*, *Olenellus*, &c.). Above these rocks the unfossiliferous red sandstones and conglomerates of the west coast (? Old Red Sandstone), long since described by Naumann, close the geological record until the deposits of the Glacial period. Dr. Kjerulf brings forward many facts regarding the metamorphism of the older palæozoic rocks in Central Norway, and traces with clearness the passage of these rocks into schistose and gneissose masses as they approach the larger areas of granite. Part V. is devoted to a brief exposition of the geology of the Trondhjem district. Part VI. discusses the lithology of the eruptive rocks. The various species and varieties of granite, syenite, porphyry, gabbro, greenstone, olivine-rocks, &c., are here described with remarkable succinctness alike as to their composition and geological relations. Considering the meagreness of the official equipment of the Geological Survey, this portion of their work must be admitted to be specially creditable to the Norwegian geologists. In Parts VII. and VIII. information is given regarding the structure of rocks and mineral veins. Some nature-printed illustrations of rock-structure here inserted are interesting. Slices of foliated, graphic, and porphyritic granite, etched with hydrofluoric acid, have allowed the more durable quartz to print its figure upon paper, and the impression has then been photographed on wood and cut into a woodcut. Some figures are also added to show the coexistence of organic remains (graptolites, corals) with crystals of chialtolite, vesuvianite, and other minerals in metamorphosed Silurian rocks.

A useful feature in the German translation is the addition of an index, which is wanting in the original, but which would have been still more acceptable had it been even fuller than it is. The numerous woodcut sections enable a reader to follow the local descriptions in the text. But the addition of a good geological index-map, such as that which accompanies the Norwegian volume, would have been of much service, and might perhaps have been given without any very serious increase of price. But this is a defect which every geological reader, at a little cost to himself, can remedy by obtaining the general map. He will find in Dr. Gurlt's version of Dr. Kjerulf's memoir an invaluable compendium of Norwegian geology, and will probably be induced to set out himself to make a personal exploration of the sections which are therein described. Should he be induced so to do he will doubtless come to look back on his tour in Norway as one of the most instructive as well as delightful of all his geological rambles.

ARCH. GEIKIE

## EUCALYPTOGRAPHIA

*Eucalyptographia; being a Descriptive Atlas of the Eucalypts of Australia and the Adjoining Islands.*  
By Baron F. von Mueller, K.C.M.G., M. and Ph.D., F.R.S., Government Botanist for the Colony of Victoria. Decades 1 and 2. (Melbourne and London, 1879.)

MATERIAL for the issue of this atlas was accumulated at Melbourne now over thirty years ago, and the study of this fine group of the myrtles has been carried on ever since, as opportunities presented themselves by Dr. Mueller. Still the subject was so large and the perplexities surrounding it so many that even now he offers his observations in these decades as only fragments toward a some day complete monograph. The difficulties surrounding the study of this group are many. There is the large number of species, the genus *Eucalyptus* being surpassed in this respect only by *Acacia*. The resemblance of many specific forms is apt to deceive one; the fruits, and more especially the flowers, are often far out of the reach of the ordinary traveller, even though he might in his enthusiasm not object to climb for a considerable height into the trees; and then the species themselves are widely distributed over the whole of the Australian continent and Tasmania, some even extending to the Indian Ocean Islands, though, it may be added, none occur in New Zealand.

Mr. Bentham's grouping of the species has been, with some trifling modifications, adopted by the author, and the Government of West Australia has borne the expense of issuing these two decades, which contain descriptions of some of the most important timber trees of the great western colony. It is to be hoped that some of the other colonial governments may follow this good example, and so help on the publication of the work. Perhaps even our own Royal Society might see their way to help it by a grant in aid out of the fund placed at their disposal by Parliament for promoting scientific research.

The economic value of these eucalypts needs scarcely to be insisted on. Not only do they yield excellent hard timber, but as products we find enumerated oils, tars, acids, dyes, tan, and potash. What magnificent forest trees are to be found among them will appear from the description of some of the species figured in these parts. One (*E. gonicalyx*) is mentioned as growing on low or hilly woodlands up to about 3,000 feet, and attaining in some of the forest valleys a height of 300 feet, with a stem diameter of not rarely six feet, and sometimes even ten. The timber of this species is described as hard and tough, exceedingly durable, lasting well when buried underground, not warping, and difficult to split. Another species (*E. leucoxyton*) known as the iron bark tree, or white gum tree, grows to a height of 200 feet, has a timber of great hardness, durability, and of extraordinary strength. On being burnt for charcoal it yielded 28 per cent. of superior stuff, 45 per cent. of crude pyroligneous acid, and 6 per cent. of tar. An excellent packing paper has been prepared from the inner layers of the bark, as can indeed be done from the inner bark of most eucalypts, and the leaves yield a volatile oil to the extent of about 1 per cent.

The genus thus abounding in useful products is no



lected in 1853, but even in good soil it retains a dwarf bushy habit, having in a quarter of a century not grown over a dozen feet in height, and showing little tendency to form a distinct stem. This species offers, perhaps, the most remarkable example of limited geographical distribution in the group. The Honey-scented Eucalypt (*E. melliodora*) is what is called, among such giants, a middle-sized tree, exceptionally attaining a height of some 200 feet; it will live on poor soil. In an official report presented in 1869 to the Victorian Parliament, Dr. Mueller pointed out that one ton weight of its branches and leaves, if gathered fresh, would yield about 2 lb. 12 oz. of pure potash, and a much larger quantity of crude pearl-ash. Another species, known from its odour as the "peppermint tree" (*E. odorata*), would seem to be a great favourite with a destructive nocturnal cockchafer. Through the immense clearings effected for agricultural settlements, the number of insect-eating birds has greatly diminished, and the increase of this species of *Melolontha* is not properly kept in check. They prey on the foliage of this Eucalypt, and Mr. Otto Tepper, writing in the *Transactions* of the Philosophical Society of Adelaide (February, 1878), states that it is being extensively destroyed from this fact.

The plates accompanying the descriptions of the species published in these decades give ample details of the leaves, flowers, and fruits of the species; they appear, so far as the stems with inflorescences are concerned, to be perhaps a little too stiff and formal. Sometimes details of the peculiar wood structures are added, and on one special plate transverse sections of the anthers of some fifty-eight species are figured. The London agents for this work are Messrs. Trübner and Co.

#### OUR BOOK SHELF

*A Short Geography of the British Islands.* By John Richard Green, M.A., LL.D., and Alice Stopford Green. (London: Macmillan and Co., 1879.)

"GEOGRAPHY, as its name implies, is an 'earth-picturing,' a presentment of earth, or a portion of earth's surface in its actual form, and an indication of the influences which that form has exerted on human history or human society. To give such a picture as this of our own country, in however short and simple a fashion, is the aim of the present work." Mr. and Mrs. Green have carried out the task they have here indicated in a masterly manner. The method they have adopted is the only scientific method on which a text-book of geography of this class can be constructed. Mr. Green, in his preface, speaks with just horror of the majority of text-books, with their dreary array of tables and "facts" and figures, which makes what ought to be one of the most interesting of lessons a burdensome and unprofitable penance.

In the first seven chapters the authors give a clear, instructive, and completely interesting sketch of the great physical features of our islands, and of their relation to the continent of Europe. The mountain groups, the uplands, the plains, and the rivers are brought before the student in

social, and industrial features have come to be developed as we find them at the present day. "Facts" enough to satisfy any humane examiner are given, and the principal data and figures are collected in a few well-arranged tables. Great care has evidently been taken to obtain accurate and recent information both with regard to physical geography and topographical, industrial, and other statistics. Besides four coloured maps, there are twenty-four special sectional maps appropriately introduced throughout the book, which must prove of great use in impressing the facts upon the mind of the learner. We trust the Geography will be largely introduced into our schools; we are sure that the scholar at least would welcome it. Its style and method, moreover, render it attractive and instructive reading to those who have long left the school of their childhood behind.

#### LETTERS TO THE EDITOR

[The Editor does not hold himself responsible for opinions expressed by his correspondents. Neither can he undertake to return, or to correspond with the writers of, rejected manuscripts. No notice is taken of anonymous communications.]

[The Editor urgently requests correspondents to keep their letters as short as possible. The pressure on his space is so great that it is impossible otherwise to ensure the appearance even of communications containing interesting and novel facts.]

#### The Visibility of Mercury to the Naked Eye

IN NATURE, vol. xxi. p. 474, I find the following: "Mercury was seen at Paris on May (meant for March) 10 and 11 with the naked eye, owing to the transparency of the atmosphere and the great elongation of the planet. . . . The observation was made by MM. Henry brothers at the Paris Observatory."

Must not "the transparency of the atmosphere" have more to do with the visibility of this planet than is usually supposed? The leading circumstances affecting the question, the amount of the planet's elongation, the inclination of the ecliptic in which it is situated to the horizon, heliocentric latitude, &c., being of course the same at each apparition in England, on the Continent, and in North America, how shall we otherwise account for some of the facts of the case? The remark is current respecting Copernicus that he never obtained a view of Mercury. And perhaps the general impression as to its visibility—that it can be seen only at the most favourable junctures, and for but a few days at a time—is reflected in the quotation above.

As a contribution to the question as it may be affected by the variable element of *climate, atmosphere*, I tabulate herewith the results of several years' careful though not thoroughly systematic observation of the planet at this geographical position, latitude 44° 53' N., longitude 93° 05' W., elevation 800 feet above sea-level:—

Year.	Time observed.	Days.	G. Elong.	Date.
1877	April 29 to May 11	13	21 5	May 3
1878	Sept.-Oct.	—	17 53	Sept. 26
1879	Jan. 7 to Jan. 29	22	24 03	Jan. 16
1880	Feb. 29 to March 19	20	18 22	March 10

It will be observed from the table that I followed Mercury with the naked eye at its last appearance in the west (when it was seen in Paris), from February 29 to March 19. I had intended to look for it a day sooner, February 28, as a crucial test as to how early it could be seen at that apparition, for it came into conjunction with Jupiter that day and would be approximately pointed out by the latter planet. But the state of the sky would not permit. Looking for Jupiter the next evening, so as to take bearings from him, I saw Mercury first, over a degree to the north-east of where Jupiter was when found. So I am confident that Mercury was within reach of the naked

eye the evening before at conjunction, save that clouds intervened. And this one day added to the twenty days actually recorded would make the period of visibility on this occasion three full weeks.

At the brightest the planet was fully equal to a 1st magnitude star, and for more than a week as bright as  $\alpha$  Arietis, two hours to the east of it, with which I frequently compared it. It was brighter than Saturn (also in the twilight) for several evenings, and was seen casually, as any other star would be seen, as I came up town from business, for more than a week. As a friend of mine remarked, "it could be seen with half an eye."

As regards the earlier observations of the table, it will be noted that the planet was seen for thirteen days in the spring of 1877, though first looked for only five days before it reached its greatest eastern elongation. It was again beautifully seen several mornings near the close of September, 1878, coming twice into conjunction with Venus during that time, though the observations were not continued so as to try how long it could be followed.

Finally, in January, 1879, though the position of the ecliptic was not favourable, an elongation of over  $24^\circ$  and splendid skies enabled me to follow Mercury for twenty-two days in succession, or while he made a full one-fourth of a revolution round the sun!

If any interest attaches to this communication it will surely not be from a superfluous attempt to show that Mercury at special times becomes visible to the naked eye; but rather from its giving certain definite facts as to the exact length of time the planet has been observed, at the several apparitions indicated. The astronomical conditions of these returns of the planet may be made out with the help of an ephemeris and a celestial globe. I need only add that the observations were made in a climate where hours favourable for astronomical work may frequently be numbered by the hundred monthly, and own that the conditions of sky and atmosphere under which they were made were generally favourable to the best results. T. D. SIMONTON  
St. Paul, Minnesota, U.S.A., May 1

### Specialised and United Palæontological Research

In your report of Prof. Huxley's lecture on "The Coming of Age of the Origin of Species" there was one sentence, which was pregnant with import to every true devotee of natural history and to every believer in the doctrine of evolution, to wit, that "primary and direct evidence in favour of evolution can be furnished only by palæontology."

Knowing that this is so, I ask, Do there exist amongst all our scientific associations delegated committees whose function it is to watch and foster palæontological research by every possible means? Seeing that so much depends on this kind of evidence, it is surprising that we hear so little of the results of any united efforts in this direction. What we generally hear of are the outcome mostly of private and individual inquiry. And since so much has already been done in this field of investigation by mere individual effort that the "missing links" between widely separated groups of the higher mammalia (not including man) have been discovered so abundantly that it can be said with respect to these, in the words of Prof. Huxley, "Evolution is no longer a speculation, but a statement of historical fact"—since this is the result of private and individual effort, what might not be achieved by united and organised research!

It is a truism that division of labour is the best means of specialising and perfecting any work, and an equally trite saying, that "union is strength;" yet in this, one of the most important of all the fields of biological study, we do not hear of a palæontological society or committee.

What could such a society or committee effect? it may be asked. Would it be expected to take hammer, pickaxe and spade in hand and wander over the wide world in exploration? Certainly not. But remaining at home, it could direct the efforts of private explorers, delegate officers of its own, equipped with the means of questioning the geological record in different parts of the globe, unite with kindred associations in solving problems too arduous for the single resources of one society, dividing alike the expenses and the spoil. Surely it would gratify the heart of every naturalist to learn if palæontological research had assumed this serious and energetic form.

How many opportunities are allowed to slip that might be turned to excellent account! Wars are carried on in countries as yet geologically unexplored, and for want of such a society as I have named there has been no one employed to accompany our

armies in the cause of this branch of science. Railways and other engineering works have been carried out in such regions, but no one has been employed to watch the operations in the name of palæontology. Travellers go and return without having been furnished with data to guide researches that might have been intelligently prosecuted in the cause of science.

Will not our leaders in natural science arouse themselves to organised and specialised research in this all-important field of palæontology?

W. S. DUNCAN  
Stafford, May 29

### The Meteorology of South Australia

[We have been asked to publish the following correspondence on an article on this subject in NATURE, vol. xxi. p. 281.]

South Australia, the Treasury, Adelaide,  
April 15, 1880

SIR,—I have to thank you for the extract from NATURE inclosed in your despatch No. 7,842, dated January 31 last which was duly referred to the Honorable the Minister of Education, and has been perused by the Postmaster-General, &c. and observer, Mr. Todd, C.M.G., a copy of whose observations and remarks upon this subject I now forward for your information and that of the Editor of NATURE. I am, sir, your obedient servant,  
(Signed) C. MANN

Sir Arthur Blyth, K.C.M.G., Agent-General for  
South Australia, London

Post and Telegraph Department

Memo. on Letter from Agent-General

METEOROLOGICAL OBSERVATIONS

The writer of the article in NATURE had evidently not received the volume for 1878, but only the monthly numbers. In the volume, as the Agent-General, to whom I have sent a copy, will see, I have given the results of the observations at Port Darwin, Alice Springs, Eucla, Cape Borda, Mount Gambier, and Cape Northumberland. As the Minister is aware, I have recommended that instruments should be supplied to several additional places, which will really give effect to what the writer in NATURE very properly urges. The extent and form in which the observations made at our institutions should be published require consideration on the score of economy of printing; and, as the Minister is aware, the observatory is altogether undermanned for the work now done, and if it were not for my own personal exertions in doing that which might be intrusted to assistants, we could not do what is done. With regard to the other suggestion, I had previously decided on correlating the rainfall and wheat-yield in different districts, in addition to the table, which takes the colony as a whole, now given.

The form in which our observations are published and discussed appears to give general satisfaction, and this will be greatly increased when we have the continuous self-recording instruments I have recommended should be obtained.

April 4

(Signed) C. TODD

P. M. G. and Supt. T.

[Mr. Todd is correct in supposing that the volume for 1877 was not before us—not having been then received—in writing the article on the "Meteorology of South Australia" in NATURE vol. xxi. p. 281, but only the monthly numbers. The volume has, however, been received quite recently, which, in view of the highly important additions it contains, referred to by Mr. Todd, we shall take an early opportunity of noticing. It gives us the highest satisfaction to learn that of the two points we drew attention to half a year ago, the one relating to the establishment of additional stations had not only been resolved on but actually carried out in the beginning of 1878, and as regards the other one, referring to the correlating of the rainfall and wheat-yield in different districts, in addition to the table which deals with the colony as a whole, it had previously been decided by Mr. Todd to discuss the data in the manner suggested.—ED

### Comparative Curves in Terrestrial Magnetism

As the comparison of curves obtained at distant stations is present one of the most important desiderata for the study of terrestrial magnetism, I forward to you traces of two photographs obtained on March 17 last at Vienna and at Stonyhurst. The storm is a remarkable one, and the curves offer a striking illustration of the simultaneous action of the disturbing force—

two magnets many miles apart. The action of the force appears to have been somewhat more vigorous at Stonyhurst than at Vienna, yet not only the great inflections, but even the slight irregularities of the curves were synchronous.

The trace of the Vienna magnetograph is taken from the May number of the *Zeitschrift der österreichischen Gesellschaft für Meteorologie*, kindly forwarded by Dr. Hann.

The range between the maximum and primary minimum at 5h. 45m. p.m. G.M.T. was 33'7 at Vienna, and 42'1 at Stonyhurst; and between the same maximum and the secondary minimum at 10h. 45m. p.m. was 24'1 at Vienna, and 34'0 at Stonyhurst.

Both the self-recording magnetographs were made by Adie, and the time-scale is the same for both curves; it is therefore very easy to identify the synchronous movements.

At Stonyhurst G.M.T. is adopted, and the longitude of Vienna is 1h. 5m. 31'3s. E. of Greenwich. S. J. PERRY  
Stonyhurst Observatory, May 27

### Luminous Painting

*Nisi novum sub sole.*—The Japanese, nine hundred years ago, seem to have been practically acquainted with the art of luminous painting, and thus to have anticipated Mr. Balmain. In looking through the article "ye" (pictures) in the Sino-Japanese Encyclopædia, "Wakan san sai dzu-ye" (illustrated Description of the Three Powers, i.e., Heaven, Earth, and Man), I recently came upon a passage, of which the following slightly condensed rendering may perhaps be of some interest to your readers:—

"In the Rui-yuen (Lei-yuen, Garden of Sundries—a sort of Chinese Collectanea) we read of one Sü Nghoh, who had a picture of an ox. Every day the ox left the picture-frame to graze, and returned to sleep within it at night. This picture came into the possession of the Emperor T'ai Tsung, of the Sung dynasty (A.D. 976-998), who showed it to his courtiers, and asked them for an explanation, which none of them, however, could give. At last a certain Buddhist priest said that the Japanese found some nacreous substance within the flesh of a kind of oyster they picked up when the rocks were bared at low tide, and that they ground this into colour-material, and then painted pictures with it which were invisible by day and luminous by night."

"No doubt," adds the author of the Encyclopædia, "when it is said that the ox left the picture-frame during the day to go a-grazing, it is meant simply that during the day the figure of the ox was not visible."

FREDK. V. DICKINS

Arts Club, June 1

### Brain Dynamics

THERE are probably among the readers of NATURE some believers in the Freedom of Volition, to whom the discussion on the above subject has not hitherto appeared to reach the knottiest point of the controversy.

The more old-fashioned supporters of the doctrine of Free Will frequently insisted on the sense of Responsibility as the crucial proof that the will is free, probably because few of their opponents were ready to face the possible, or supposed, moral consequences of the denial of responsibility. The proof is essentially weak, and Mr. Romanes has well exhibited its weakness in NATURE, vol. xxii. p. 76. His "Prince of Denmark" has indeed so little of method in his madness that I am not disposed to think it curious that both Prof. Clifford and Mr. Tolver Preston should have left him out of their play. He may well exclaim: "What should such fellows as I do, crawling between earth and heaven? We are arrant knaves all; believe none of us." Surely the sense of Responsibility is not the origin, but is one of the results of the Sense of Freedom. Logically the Sense of Freedom is the justification of the sense of responsibility. Historically it is, no doubt, its antecedent; for while both are, as much as any other faculties of brute and man, results of evolution, the refinement of the conception of morality, and therefore probably the conception itself, has evidently originated long after the consciousness of volition. Experimentally the sense of responsibility is weakened or destroyed, either psychologically, as where the freedom of the actor is controlled, or physiologically, as where volition is suspended in sleep, or is impaired by lesion of the anterior lobes of the brain, in all which cases the sense of responsibility suffers corresponding loss. It seems to me strange

that Mr. Romanes should suppose the doctrine of Free Will to have been conceived and continued in order to justify that Moral Sense which is essentially a consequence of it (though capable finally of being presented as one among other motives in certain acts of volition). It lies with those who think, with Mr. Romanes to account, on their own hypothesis, for the development of so universal, obtrusive, irrational, and indeed "nonsensical" an instinct as, according to that hypothesis, the sense of responsibility is. Others will see in it a result of the Sense of Freedom of Volition, when combined with the intellectual perception of the consequences, to the individual or to the race, of human acts (the latter perception being the cumulative result of inherited experiences). This Sense of Freedom of Volition is the real Hamlet.

We possess, or appear to ourselves to possess, the consciousness of the power of choosing between alternative motives. It is unsafe merely to give the lie direct to this consciousness, lest we thereby destroy the validity of the evidence, also derived through consciousness, of all those facts on which any law of nature, and Causal Sequence itself, is based. The consciousness of power is derived from the sense of work done, as against resistance, e.g., the consciousness of muscular power is derived from a class of sensations produced on the organism by resistance, these sensations being created by, and consequently associated with, the conversion of potential energy stored up in the brain into kinetic energy transmitted through the nerves and muscles, and it bears no psychological resemblance to the consciousness of sensations of which the brain is the passive recipient. Similarly, the consciousness of the power of volition is derived from the sense of work done, in this case wholly within the brain, in the selection between alternative motives, and it bears no psychological resemblance to the consciousness of the motives themselves. And so, too, just as the sense of lassitude is produced by excess of work done as against physical resistance, so is a sense of discomfort produced by expenditure of potential energy, when acts of volition are performed against powerful emotions.

It appears to me that the Necessitarian should be able on his part to show that this sense of work performed in choosing between motives is fictitious, or that the energy above mentioned has no existence. This will not be done solely by holding even the errors of omnipotent Causal Sequence over the head of the advocate of Free Will. The latter considers volitions to be, not indeed "uncaused" in the sense of occurring without antecedent emotions, or without expenditure of energy in choosing between the emotions, yet not to be rigidly determined by those emotions. He need not inquire whether a man be "unfortunate" in the capricious character of human acts as compared with other phenomena. But he on his part has to show (and certainly no scientific mind will underrate the magnitude of the task) that phenomena of volition (so paradoxical as it may seem, constitute a class by themselves, their relation to physical causation being perhaps comparable to that in which the phenomena of life stand to the laws of inorganic chemistry, a relation of addition, not of contradiction.

W. CLEMENT LEE

I SHOULD like to state, in reply to Mr. George Romanes' letter (NATURE, vol. xxii. p. 75), that the question of "Responsibility" was left out of my letter (NATURE, vol. xxii. p. 29) partly because it seemed to me a separate or somewhat distinct subject, and partly from the fact that this matter had been already considered by me in connection with a paper on "Natural Science and Morality," to be published in the *Journal of Science* for July next; and to this, therefore, I would venture to refer those who may be interested in this question.

I may merely conclude by saying that, while otherwise fully endorsing Mr. Romanes' letter, there is only one point on which I should be disposed to disagree with him, viz., in regard to his suggested view that the doctrine of strict causal sequence in nature would tend to show the feelings of Responsibility, Praise, and Blame to be "destitute of any rational justification." For there appear to me to be grounds for believing that a scientific and rational explanation of these feelings exists.

London, June

S. TOLVER PRESTON

### Vortex Atoms

WHILE thanking Mr. G. H. Darwin for his observations on one or two passages in my paper "On the Physical Aspects of the Vortex-Atom Theory," which, as they stand, may no doubt tend to convey an inexact impression, I may state that the illus-

tration of a pipe was used with the endeavour to aid the conceptions in some respects, rather than for rigid accuracy of comparison. The idea of the exterior fluid being *at rest* was subsequently guarded against by stating that it had "important functions" to perform. In regard to the fact of only mentioning "friction" as an element of resistance in a totally immersed body, I wished rather to convey the general idea that if no energy were given to the molecules of the surrounding liquid at the passage of the immersed body, there would be no "resistance." The object of the article was, however, not so much to lay stress on these points as to notice certain, perhaps less appreciated (*a priori*), aspects of the problem.

S. TOLVER PRESTON

### Songs of Birds

YOUR correspondent "A. N." (*anted*, p. 97) does not seem to be aware that the best observers are nowadays agreed in believing that the hen cuckoo does not sing. Hence his suggestion in regard to the difference of note observed by Mr. Birmingham (*anted*, p. 76) hardly applies to the case in question.

ALFRED NEWTON

Magdalene College, Cambridge, June 6

I HAVE been in the habit of observing the notes of cuckoos, and have noticed that the musical interval is very variable. It is not always, or even often, amenable to our tempered scale, but may lie anywhere between a major 2nd and a 4th. The major 3rd seems to be about as frequent as the minor. The interval may vary in the same bird, as it is well known that the cuckoo's song alters greatly with the approach of summer.

FRANK J. ALLEN

St. John's College, Cambridge, June 6

### Cup-marked Stones

ON a large block of fine-grained hard whitish sandstone near Rnrghhead, Elgin, are forty-four cup-marks of various sizes, but all very finely formed. Four of the cups have channels or grooves of various lengths and running in different directions, but none to the edge of the stone. Five have one ring, and channels of various lengths, and in different directions. Four have got two rings and channels, and one has three rings and a channel. In some cases the rings are not complete, that is, they stop short on either side of the channel, but close to it. One cup has a simple ring.

From this example, and if I recollect the figures in Sir J. Y. Simpson's work, there seems to be but few cases in which the channels run to the edge of the stone.

Out of a considerable number of cup-marked stones partly on finely ice-polished rock surfaces and partly on detached blocks large and small, in Elginshire, this is the only one that has rings and grooves. A full description of these, with plans, I have nearly ready to lay before the Society of Antiquaries at one of their early meetings of next session.

JAMES LINN

Keith, June 2

THE DUMAS NUMBER.—In reply to numerous inquiries we may state that the portrait of M. Dumas should form the frontispiece to vol. xxi., and the article by Dr. Hofmann be placed after the index in the beginning of the volume.

### ENERGY AND FORCE<sup>1</sup>

↓ March 28, 1873, Clifford delivered a Friday evening discourse on this subject at the Royal Institution. By some accident no trace of it, not even the date or title, appears in the printed *Proceedings*. Thus the lecture escaped notice when Clifford's literary and scientific remains were collected in the summer of last year. A few weeks ago I lighted on my own rough notes of it taken down at the time, probably the only record now in existence. These I have written out, with only so much alteration and addition (indicated by square brackets) as necessary to make them intelligible. The

<sup>1</sup>discourse by the late Prof. Clifford. With an introduction by Moulton.

paper thus produced has been seen by Clifford's friend and mine, Mr. J. F. Moulton, who (besides his general competence in mathematical physics) was thoroughly acquainted with Clifford's mathematical work and ideas. Mr. Moulton has added, by way of introduction, some remarks founded on this intimate knowledge, which will explain the aims of the discourse and supplement the too meagre report which is all that I am able to reconstruct from my notes.—F. POLLOCK.]

This lecture was, I think, written as a protest against certain loose ideas that had become prevalent relating to energy, motion, and force. The discoveries as to the equivalence of the many forms of energy and the invariability of the total of energy in any system not operated on by external forces (one case of which is the whole material universe), had led philosophical writers and others to treat force as an entity with a separate existence like matter, and also, like it, indestructible. The error of thus treating force as an entity with a separate existence was not an unnatural one in those who had not much acquaintance with the theories of physics. No idea is more consonant with the ordinary modes of thought than that force is a something operating from without on a body, and producing effects thereupon in the shape of an alteration of its motion, so that the quasi-personification of force contained in the above does not appear to be in any way an unwarranted conception. The further step, which ascribes to force an indestructibility as absolute as that of matter, is due to a confusion in the terms used by mathematicians themselves in speaking of these subjects, for which they are to blame. Before the conservation of energy was fully formulated, mathematicians were acquainted with a particular case of the general principle, and it had received the name of conservation of force. This unfortunate appellation, with all its misleading tendencies, was often applied to the general principle when the latter first became known, and hence unscientific writers naturally assumed that force and energy were convertible terms and that they were alike indestructible. These erroneous conceptions had attracted Prof. Clifford's attention, and with his usual zeal for preserving scientific ideas from all taint, he set about correcting them. His mode of doing so is highly characteristic. He strikes straight at the root of the matter, and would have us at once cease to think of force as an entity at all. Indeed he goes so far as almost to warn us against tolerating the conception of a cause as distinguished from its effects.

All we know as to force and motion, he says, is that a certain arrangement of surrounding bodies produces a certain alteration in the motion of a body. It has been usual to say that this arrangement of surrounding bodies produces a certain force, and that it is the action of this force that produces the alteration of the motion. Why have this intermediate term at all? Why should we not go at once from the surrounding circumstances to the alteration of motion which follows? The intermediate term is only a mental inference either from the existence of the surrounding circumstances or from the occurrence of the alteration in the motion; and if we only accustom ourselves to pass from one to the other without its assistance, it will cease to be necessary, and like other useless mental conceptions, be gradually forgotten. And with it will pass all tendency to give to this useless mental phantom any such real and material qualities as indestructibility.

I was not present when the lecture was given, nor do I know otherwise than from these notes how Prof. Clifford carried out these ideas. But in conversation he had often discussed the matter with me, and made me fully acquainted with his views on the subject, so that I am able thus far to confirm the accuracy and completeness of these notes. It will be seen that he defines force as

"the change of momentum of a body considered as depending upon its position relative to other bodies," thus bringing into direct connection the surrounding bodies and the consequent alteration of motion and rendering the conception of force a superfluous one. In his concluding remarks as to whether we are directly conscious of force, there is the same tendency. He is well aware that such an attempt as his will be viewed with very little favour by the not unimportant school of philosophers who conceive that force is the only thing that we are directly conscious of, and thus he takes the opportunity to combat this idea.

The part of the lecture that refers to energy needs no special remark. He shows, in his usual clear style, at once how much and how little is contained in the law of the conservation of energy. So far from containing in itself the solution of all the changes in the universe, it tells us only one of the conditions that these must obey, and gives us very little information, if any, as to the particular results that follow from the causes that are at work. It is invaluable as a negative law. It enables us to reject with absolute certainty countless hypotheses that would otherwise be temptingly appropriate to elucidate the complexities of nature. But further than that it cannot go. It cannot distinguish between the innumerable hypotheses that satisfy it, of which, after all, only one can be true. J. F. M.

No mathematician can give any meaning to the language about matter, force, inertia, used in current text-books of mechanics.

The old definition of *force* contains the word cause. In the older writers this is a mere manner of speaking; thus Maclaurin defines velocity as the cause of a body changing its position. We now define it as the rate of change of position.

Causation is defined by some modern philosophers as unconditional uniformity of succession, *e.g.*, existence of fire follows from putting a lighted match to the fuel.

This idea must be got rid of to understand force. All universally true laws of nature are laws of co-existence, not succession. Thus, I want to move a thing and I push it, and motion follows. This suggests at first sight the conception of cause and effect being related in succession. But really you change the rate of motion of a thing *at the time* when you push it, not afterwards. So if you drop a thing from your hand, the letting go and the falling down are really simultaneous. Again, the change of motion of a terrestrial body is at every instant dependent on its distance from the earth's centre (though in practice this is neglected for small distances). In every case the law at work is seen to be a law of co-existence, not succession.

*Momentum* may be roughly described as quantity of motion. A body moving at a speed of say twenty miles an hour, has a certain quantity of motion. If the same body goes forty miles an hour there is twice as much motion; or if twice as much matter goes twenty miles an hour, there is also twice as much motion. Momentum is measured by the quantity of matter moving at a given rate (mass  $\times$  velocity).

How is the quantity of matter measured if we compare bodies of different substances, such as wood and lead? Not by size: there is another scale by which the quantity of matter in a given body, without regard to the kind of matter, can be measured. [The existence of such a scale and the possibility of applying it are involved in the idea of *mass*.] The simplest method of applying that scale in practice is to weigh the two bodies to be compared at the same place.

Force cannot be explained without stating a law of nature concerning momentum, viz. —

Suppose a body with a certain momentum to be the only body in the universe; it will go on with the same momentum.

If there is any change, there is another body, and the change depends on the position of that body.

The case of bodies in contact is no exception to this law, but only a particular case. Here the change of motion is called *pressure*. The case of bodies not in contact is illustrated by the motion of the earth about the sun [under the force of gravitation, as we call it].

In all cases change of motion is connected by invariable laws with the position of surrounding bodies. Force, then, has a definite direction [at every instant] at any point in space, and depends on the position of surrounding bodies, and may be described as the change of momentum of a body considered as depending upon its position relative to other things. It embodies the quality of direction as well as magnitude. In other words, it is a *quantity having direction*.

Force, defined as above, is not conserved at all. It may appear and disappear; it is continually being created and destroyed. "Conservation of force" is, mathematically speaking, a contradiction in terms.

*Energy* [is of two kinds: 1. Energy of motion; 2. Energy of position].

1. In a moving body we have a certain *quantity of motion* [as explained above under the head of momentum]. Thus in a moving railway train let the unit of motion be one carriage going at the rate of one mile per hour; then ten carriages going at the rate of twenty miles per hour have 200 units of motion. [The quantity of motion or momentum in a body may be regarded as travelling with the body, and] energy of motion is the *rate at which momentum is carried along*. [It depends on momentum and velocity jointly, and the energy of motion of a given body] is known when the velocity is known. In practice it is convenient to call the actual amount of energy of motion half this rate. It is expressed by  $\frac{1}{2} m v^2$  [*i.e.*,  $m v \times v$ , not  $m \times v^2$ : Clifford, in conversation].

2. Energy of position is quite a different thing. If I take a book lying on the table and lift it up, and put it on the desk above the table, it acquires energy of position, and the energy acquired is measured by the weight [assuming gravity to be constant] of the book multiplied by the difference of height between the two positions. [Energy of position, like force, may be said to exist at any point of space, whether a body is there or not.] The difference of energy between two positions is the quantity of work that must be done to remove a body of unit mass from one position to the other.

When a body is let fall from a higher position to a lower one, it has, at the instant when it is let go, no energy of motion; but it gains, in falling, as much energy of motion as it loses energy of position. It is found that the *sum of energy of motion and energy of position is always constant*.

Force, we have seen, is a quantity which has direction. Energy is a quantity which can be greater or less, but has no direction. The name Energy is applied to two different quantities, of which we find the sum to be constant. This constancy is expressed by including them in the common name of Energy, and saying that energy is conserved, or is indestructible. This form of speech might be applied to other cases of alternate immortality, where one of two things comes into existence on the disappearance of the other.

Does the law of persistence of energy mean no more than this? Yes, [it means more when it is used to include the "correlation of physical forces"]. Other qualities of bodies are connected with simple energy of motion and energy of position. Such is heat, which we find by experiment can be turned into work. Finding it convertible with energy, we call it a form of energy.

Here we have [it seems] three different things included: energy of motion, energy of position, heat. But as to

heat, it is further established by experiment that in this case the energy of motion does really persist as such. Thus a gas consists of molecules flying about with great velocity, rotating and vibrating, and so having energy of motion. All this energy of motion is what we call heat, and thus heat is a repetition of a known meaning of energy. Again, heat exists between a radiating body and the thing it warms; now the intermediate space is filled by the luminiferous ether, which, being elastic, has in its ultimate parts both energy of motion and energy of position. In these forms the heat exists in the space in question.

In the cases of heat and electricity the form of the persisting energy is pretty well ascertained. But there are cases in which we do not know if it is energy of motion or energy of position, such as that of *chemical energy*. In the burning of coal there is a falling together of carbon and oxygen [and heat is produced]; but we do not know in which of the two forms, if either, the energy which comes out as heat existed in the chemical process. For such a case the conservation of energy is only a probable statement (though of great probability) to the effect that in all cases where a physical quality is convertible with energy, that quality is itself either energy of motion or energy of position.

*General Results.*—Force is a quality of position, definite in magnitude and direction at any point; not constant.

Energy is the name of two different quantities.

1. Energy of motion, half the rate at which a body carries momentum.

2. Energy of position, defined by the statement of the law that the work done in getting from one position to another is the same by whatever path the change of position is made.

[The definition of these conceptions helps to clear up sundry questions of mixed physics and metaphysics.]

1. Is a physical force, such as the attraction of the earth, analogous to our "exertion of force" in muscular work? No, for the sensation of muscular effort is very complicated. It involves nerve and muscle, which we know not to be present in the simpler cases, *e.g.*, the motion of a stone let fall. To talk of *pushing* or *pulling* in such a case is a personification of external nature.

2. Are we directly conscious of force? It is often said in physical and metaphysical works that we are. It may be true, but it is at least premature. We do not *know* that the chemical changes in nerve-matter corresponding to consciousness are energy [only that they are *convertible with dynamical energy*]; much less do we know that they are force. If they are energy, it is energy of motion, not energy of position, since consciousness does not depend on the position of the nerve-matter [so my notes: *sed quare*].

3. Is mind a force? It is held by some that the will acts as the match to gunpowder, by setting loose a store of energy, the matter of the brain being in unstable equilibrium. But you cannot have in nature an absolutely unstable equilibrium [*i.e.*, an equilibrium capable of being upset by an infinitesimal force], because the universe is not at rest [and every motion in the universe produces a finite change, however small, in the resultant force at every point of space]. Therefore if mind is force, operating in the way suggested, it must be able to create a determinate quantity of energy. This is a supposition which, if true, would destroy its own evidence; for it would destroy the uniformity of nature, on which all possibility of inference ultimately rests.

[The discourse concluded by pointing out that even from a purely scientific point of view, metaphysical speculation is to be encouraged as a spur to science.]

#### ECHIS CARINATA

THOSE who are interested in the poisonous snakes of India may have an opportunity of seeing one of the most interesting and destructive of these reptiles,

now in the Zoological Society's Gardens in Regent's Park.

The snake I refer to is a fine specimen of the *Echis carinata*, which has recently arrived from India, and is the first of its kind, I am told, that has been received alive in this collection. I think it is probable, however, that a snake so common in some parts of India must have been brought alive to England before; but at any rate it is rare, and sufficiently interesting to claim attention, especially as it is healthy, vigorous, and active, and readily shows its peculiar habits, in the attitude it assumes and the rustling sound it gives rise to by the friction of the carinated scales of one fold of its body against those of the other when alarmed, and in the aggressive position which it takes up when prepared to strike, which it does most viciously by launching out its head and the anterior part of its body from the centre of the convoluted folds into which it has arranged itself. There are, I believe, only two true vipers in India (though there are several Crotalidæ), the *Daboia russellii*, or chain viper, or tiepolonga, and the *Echis carinata*. The daboia is well known here, and there are, and have been lately, fine specimens in the Society's collection; but the echis is not so well known, though common enough in India.

It is much smaller than the Daboia, and is very active and dangerous. It is known in Sind as the "kuppur"; in other parts of the country as "phoorsa"; about Delhi it is "afae," or "afai" (a word of Arabic origin). Russell calls it "horatta pam." It seldom attains more than the length of 20 to 22 or 23 inches; probably 15 or 16 inches is more common, and is from 2 to 2½ or 3 inches in circumference at the thickest part of the body.

It is very fierce and aggressive, always ready to attack. It throws itself into a double coil, the folds of which are in perpetual motion; the whole body does not necessarily change its place, and as they rub against each other they make a loud rustling sound, which may be mistaken for hissing. This is produced by the three or four outer rows of carinated scales, which are prominent and point downwards at a different angle to the rest; their friction against each other causes the loud rustling sound which gives notice of the presence of the echis, as does the rattle of the crotalus.

I have never heard this viper hiss; though the daboia does so loudly. It is of a brownish-grey colour, with white and dark spots, and a waving whitish band on either side of the body. On the head there is a peculiar mark something like a cross. Its fangs are very long and mobile, and its poison very active, destroying a fowl in two or three minutes. In Sind, and some other parts of India where it is very common, it causes considerable loss of human life, though I believe it is not so destructive on the whole as either the cobra or *Bungarus caruleus* (Krait), which are more generally distributed over the peninsula. I have not seen it in Bengal, but it is common in the North-West Provinces, Punjab, Sind, and Central Provinces, and Southern India in the Carnatic, and about Madras.

Its aggressive aspect when roused, the vicious eye, its peculiar method of folding itself, the rustling of its scales, and the rapidity with which it strikes, make it, when living, an object of considerable interest.

In the same collection there is a fine specimen of another very rare colubrine venous snake, the *Ophiophagus elaps*, which gives an opportunity not often available even in India, where the snake is found only in certain localities, of studying its peculiar habits and food, which consists of other snakes. It is as deadly as the cobra, to which it is nearly allied; but from its comparative rarity and the nature of its habitat it does not contribute so largely to the death-rate as that snake or even as the little echis.

J. FAYRER

CONTRIBUTIONS TO MOLECULAR PHYSICS  
IN HIGH VACUA<sup>1</sup>

## II.

IT has been shown that the stream of molecules are shot off from the negative pole in a negatively charged condition, and their velocity is owing to the mutual repulsion between the similarly electrified pole and molecules. It became of interest to ascertain whether lateral repulsion was exerted between the molecules themselves. If the stream of molecules coming from the negative pole carried an electric current, two parallel rays should exert mutual attraction; but if nothing of the nature of an electric current was carried by the stream, it was likely that the two parallel rays would act simply as negatively electrified bodies and exert lateral repulsion. This was not difficult to put to the test of experiment.

A tube was made with two flat aluminium terminals, *a b*, close together at one end, and one terminal, *c*, at the other, as shown in Fig. 11. Along the centre of the tube, cutting the axis obliquely, is a screen of mica, painted over with a phosphorescent powder, and between the screen and the double poles, *a b*, is a disk of mica crossing the axis of the tube, and therefore nearly at right angles

to the phosphorescent screen. In this mica disk are two slits—one opposite each pole *a* and *b*—running in such a direction that the molecular streams emanating from *a* and *b* when made negative shall pass through the slits, forming two horizontal sheets. These sheets striking against the oblique screen will be made evident as two horizontal lines of light. The poles *a* and *b* were somewhat bent, so that the lines of light were not quite parallel, but slightly converged. The tube being properly exhausted, the pole *a* was made negative, and *c* positive, the lower pole *b* being left idle. A sharp ray of phosphorescent light shot across the screen along the line *d f*. The negative wire was now transferred from *a* to *b*, when a ray of light shot along the screen from *e* to *f*. The two poles *a* and *b* were now connected by a wire, and the two together were made the negative pole. Two lines of light now shone on the screen, but their positions, instead of being, as before, *d f* and *e f*, were now *d g* and *e h*, as shown by the dotted lines. The wire joining the poles *a b* was removed, and the pole *a* made negative; the ray from it followed the line *d f* as before. While the coil was working, another wire hanging loose from the pole *b* was brought up to *a*, so as to make them both negative. Instantly the ray *e h* shot across the screen, and simul-

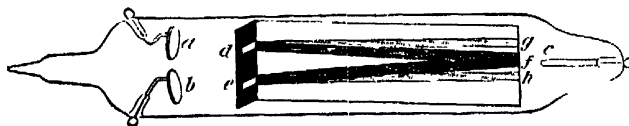

FIG. 11.

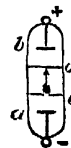

FIG. 12.

taneously the ray *d f* shifted its position up to *d g*. The same phenomena were observed when the pole *b* was connected with the coil, and contact was alternately made and broken with *a*; as the ray *d g* shot across, the ray *e f* dipped to *e h*.

These experiments show that two parallel rays of molecules issuing from the negative pole exert lateral repulsion, acting like adjacent streams of similarly-electrified bodies. Had they carried an electric current they should have attracted each other, unless, indeed, the attraction in this case was not strong enough to overcome the repulsion.

Many experiments have been made to ascertain the law of the action of magnets and of wires carrying currents, on the stream of molecules.

As an indicator, a small tube, as shown in Fig. 12, was employed. The two poles are at *a* and *b*, *a* being the negative. At *c* is a plate of mica with a hole in its centre, and at *d* is a phosphorescent screen. A sharp image of the hole in the mica is projected on the centre of *d*, and the approach of a magnet causes this bright spot to move to different parts of the phosphorescent screen.

A large electro-magnet was used, actuated by two Grove's cells, and the indicator tube was carried round the magnet in different positions and the results noted. The molecular stream when under no magnetic influence passes along the axis of the tube, as shown by the small arrow (Fig. 12). It will be seen that the indicator can occupy three different directions in respect to the magnet. The magnet being held horizontally, the direction of the molecular stream may be parallel to the axis, tangential to it, or at right angles to it. In either of these positions, also, the stream may be directed one way or the other (by turning the tube round endwise). In these different positions various results are obtained which are easily illustrated with a solid model, but are

somewhat complicated to explain by means of flat drawings. They are fully described in the paper.

A long tube was made similar to the small indicator shown in Fig. 12, but having a molecular trajectory six inches long. It was only exhausted to the point at which the image of the spot was just seen sharply defined on the screen, as at higher exhaustions the action of magnetism is less. The phosphorescent screen was divided into squares for convenience of noting the deflection of the spot of light. So sensitive was this to magnetic influence, that when the tube was placed parallel to the earth's equator the earth's magnetism was sufficient to cause the spot to move 5 millims. away from the position it occupied when parallel to the dipping needle (in which position the earth's magnetism did not appear to act). When held equatorially and rotated on its axis, the spot of light, being always driven in one direction independent of the rotation of the tube, appeared to travel round its normal position in a circle of 10 millims. diameter.

I have long tried to obtain continuous rotation of the molecular rays under magnetic influence, analogous to the well-known rotation obtained at lower exhaustions. Many circumstances had led me to think that such rotation could be effected. After many failures an apparatus was constructed as follows, which gave the desired results:—

A bulb (Fig. 13) was blown of German glass, and a smaller bulb was connected to each end of the larger bulb by an open, very short neck. At each extremity was a long aluminium pole projecting partly into the large bulb and turned conical at the end. After good exhaustion the passage of an induction current through this apparatus fills the centre bulb with a very fine green light, whilst the neck surrounding the pole which happens to be negative is covered with two or three dark and bright patches in constant motion, following each other round first one way and then the other, constantly changing direction and velocity, sometimes dividing into other patches, and at others fusing together into one. After a

<sup>1</sup> "Contributions to Molecular Physics in High Vacua. Magnetic Deflection of Molecular Trajectory; Laws of Magnetic Rotation in High and Low Vacua; Phosphorogenic Properties of Molecular Discharge." By William Crookes, F.R.S. (Extracts from a paper in the *Philosophical Transactions of the Royal Society*, Part 2, 1879.) Continued from p. 104.

little time, probably owing to the magnetism of the earth, or that of the core of the induction coil not far off, the movements sometimes become more regular, and slow rotation takes place. The patches of light concentrate into two or three, and the green light in the bulb gets more intense along two opposite lines joining the poles forming two faintly outlined patches, which slowly move

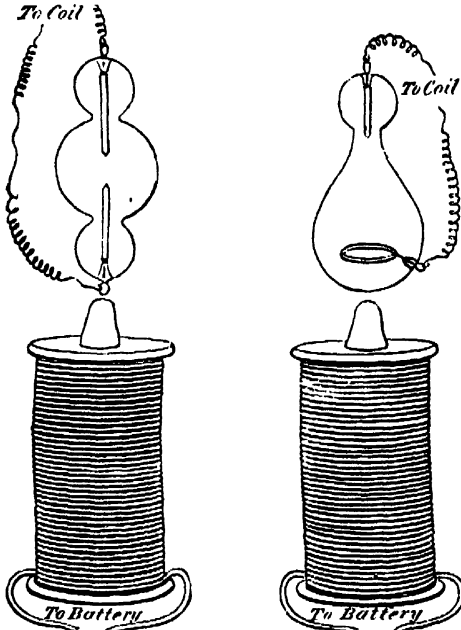

FIG. 13.

FIG. 14

round the bulb equatorially, following each other a semi-circumference apart.

An electro-magnet placed beneath in a line with the terminals (Fig. 13) converts these undecided movements into one of orderly rotation, which keeps up as long as the coil and magnet are at work.

In order to compare accurately the behaviour of the molecular streams at high exhaustions with that of the ordinary discharge through a moderately rarefied gas, another tube was taken having the upper pole an aluminium wire, and the lower one a ring, Fig. 14. It was only exhausted to such a point that the induction spark should pass freely from one pole to the other in the form of a luminous band of light, this being the form of discharge usually considered most sensitive to magnetic influence. This tube was also mounted over an electro-

looking vertically down on the tube, his eye being in a line with the terminals and with the axis of the magnet. When the rotation thus viewed is in the direction of the hands of a watch, it is called *direct*; the opposite movement being called *reverse*. To facilitate a clear appreciation of the actions, an outline sketch (Fig. 15) accompanies each experiment. The shape of the tube shows whether it is the high or low vacuum tube, and the letter D or R shows the direction of rotation.

- a. Upper pole of electro-magnets north.  
Induction current passing through tubes so as to make the top electrode *positive*.  
Rotation in the high vacuum *direct*.  
Rotation in the low vacuum *direct*.
- b. Upper pole of magnets north.  
Top electrode of tubes *negative*.  
Rotation in high vacuum *direct*.  
Rotation in low vacuum *reverse*.
- c. Upper pole of magnets south.  
Top electrode of tubes *positive*.  
Rotation in high vacuum *reverse*.  
Rotation in low vacuum *reverse*.
- d. Upper pole of magnet south.  
Top electrode of tubes *negative*.  
Rotation in high vacuum *reverse*.  
Rotation in low vacuum *direct*.

These experiments show that the law is not the same at high as at low exhaustions. At high exhaustions the magnet acts the same on the molecules whether they are coming to the magnet or going from it, the direction of rotation being entirely governed by the magnetic pole presented to them, as shown in cases *a* and *b* where the north pole rotates the molecular stream in a *direct* sense, although in one case the top electrode is positive and in the other negative. Cases *c* and *d* are similar; here the magnetic pole being changed, the direction of rotation changes also. The direction of rotation impressed on the molecules by a magnetic pole is opposite to the direction of the electric current circulating round the magnet.

The magnetic rotations in low vacua are not only fainter than in high vacua, but they depend as much on the direction in which the induction spark passes through the rarefied atmosphere, as upon the pole of the magnet presented to it. The luminous discharge connecting the positive and negative electrode carries a current, and the rotation is governed by the mutual action of the magnet on the perfectly flexible conductor formed by the discharge.

In high vacua, however, the law is not the same, for in cases *b* and *d* similar arrangements produce opposite rotations in high and in low vacua. The deflection exerted by a magnet on the molecular stream in a high vacuum may be compared to the action of a strong wind blowing across the line of fire from a mitrailleuse. The deflection is independent of the to-and-fro direction of the bullets, and depends entirely upon the direction of the wind.

I have already mentioned that platinum will fuse in the focus of converging molecular rays projected from a concave pole. If a brush of very fine iridio-platinum wire, which has a much higher fusing point than platinum, be used to receive the molecular bombardment, a brilliant light is produced, which might perhaps be utilised.

A piece of apparatus was constructed in which a plate of German glass was held in the focus of the molecular bombardment. The vacuum was so good that no hydrogen or other lines could be seen in the spectrum of the emitted light. The focus was now allowed to play on the glass, when the glass soon became red hot. Gas appeared in the tube, and hydrogen lines now were visible in the spectrum. The gas was pumped out until hydrogen disappeared from the spectrum. It was now possible to heat the glass to dull redness without hydrogen coming in the tube; but as soon as the heat approached the fusing point

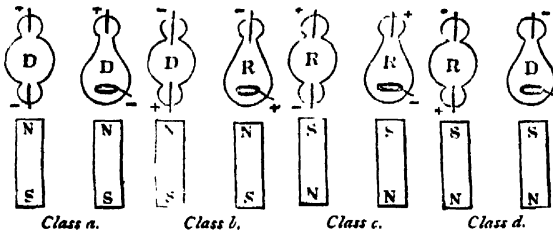

FIG. 15.

magnet, and the two sets of apparatus being actuated successively with the same coil and battery, the following observations were made.

The tubes will be distinguished by the terms "high vacuum" (Fig. 13) and "low vacuum" (Fig. 14). The rotation produced in each tube will be recorded in the direction in which it would be seen by an observer above,



the characteristic lines appeared. It was found that however highly I heated the glass and then pumped the tube free from hydrogen, I had only to heat the glass to a still higher temperature to get a hydrogen spectrum in the tube. I consider the hydrogen comes from vapour of water, which is obstinately held in the superficial pores, and which is not entirely driven off by anything short of actual fusion of the glass. The bubbles noticed when the disintegrated and fused surface of the tube was examined under the microscope are probably caused by escaping vapour of water.

When the negative discharge has been playing for some time on German glass, so as to render it strongly phosphorescent, the intensity of glow gradually diminishes. Some of this decline is due to the heating of the glass or to some other temporary action, for the glass partially recovers its property after rest; some is due to a superficial change of the surface of the glass; but part of the diminished sensitiveness is due to the surface of the glass becoming coated with this brown stain.

The luminous image of a hole in a plate of mica was projected from a *platinum* plate used as a negative pole, to the side of a glass bulb. The coil was kept playing for some time until the inside of the bulb was thoroughly darkened by projected platinum. Although a bundle of molecular rays could be seen all the time passing from the platinum through the hole in the mica to the glass, where it shone with a bright green light, I could detect no trace of extra darkening when the part of the glass formerly occupied by the green spot was carefully examined. Platinum is a metal which flies off in a remarkable manner when it forms the negative pole. It therefore appears from this experiment that the molecular stream does not consist of particles of the negative pole shot off from it.

One of the most striking of the phenomena attending this research has been the remarkable power which the molecular rays in a high vacuum possess of causing phosphorescence in bodies on which they fall. Substances known to be phosphorescent under ordinary circumstances shine with great splendour when subjected to the negative discharge in a high vacuum. Thus, a preparation of sulphide of calcium, much used now in Paris for coating clock faces which remain luminous after dark, is invaluable in these researches for the preparation of phosphorescent screens whereon to trace the paths and trajectories of the molecules. It shines with a bright blue-violet light, and when on a surface of several square inches is sufficient to light up a room. Modifications of these phosphorescent sulphides shine with a yellow, orange, and green light.

The only body I have yet met with which surpasses the luminous sulphides both in brilliancy and variety of colour is the diamond. Most of these gems, whether cut or in the rough, when coming from the South African fields, phosphoresce of a brilliant light blue colour. Diamonds from other localities shine with different colours, such as bright blue, pale blue, apricot, red, yellowish-green, orange, and bright green. One beautiful green diamond in my collection when phosphorescing in a good vacuum gives almost as much light as a candle; the light is pale green—almost white. A beautiful collection of diamond crystals kindly lent me by Prof. Maskelyne phosphoresce with nearly all the colours of the rainbow, the different faces glowing with different shades of colour.

Next to the diamond, alumina in the form of ruby is perhaps the most strikingly phosphorescent stone I have examined. It glows with a rich, full red; and a remarkable feature is that it is of little consequence what degree of colour the earth or stone possesses naturally, the colour of the phosphorescence is nearly the same in all cases; chemically precipitated amorphous alumina, rubies of a pale reddish-yellow, and gems of the prized "pigeon's blood" colour, glowing alike in the vacuum,

thus corroborating E. Becquerel's results on the action of light on alumina and its compounds in the phosphoscope (*Annales de Chimie et de Physique*, sér. 3, vol. lvii.). Nothing can be more beautiful than the effect presented by a mass of rough rubies when the molecular discharge plays on them in a high vacuum. They glow as if they were red hot, and the illuminating effect is almost equal to that of the diamond under similar circumstances.

By the kindness of M. Ch. Feil, who has placed large masses of his artificial ruby crystals at my service, I have been enabled to compare the behaviour of the artificially formed crystals with that of the natural ruby. In the vacuum there is no difference whatever; the colour of the phosphorescence emitted by M. Feil's crystals is of just as an intense a colour, and quite as pure in character, as that given by the natural stone. This affords another proof, if one were needed, that Messrs. Fremy and Feil have actually succeeded in the artificial formation of the veritable ruby, and have not simply obtained crystals which imitate it in hardness and colour.

The appearance of the alumina glow in the spectroscope is remarkable. There is a faint continuous spectrum ending in the red somewhere near the line B; then a black space, and next an intensely brilliant and sharp red line to which nearly the whole of the intensity of the coloured glow is due. The wave-length of this red line, which appears characteristic of this form of alumina, is 689.5 m.m.m., as near as I can measure in my spectroscope; the maximum probable error being about  $\pm .3$ .

This line coincides with the one described by E. Becquerel as being the most brilliant of the lines in the spectrum of the light of alumina, in its various forms, when glowing in the phosphoscope.

This coincidence affords a good proof of the identity of the phosphorescent light, whether the phosphorescence be produced by radiation, as in Becquerel's experiments, or by molecular impact in a high vacuum.

I have been favoured by my friend Prof. Maskelyne with the following notes of results obtained on submitting to the molecular discharge various crystals which he lent me for the purpose of these experiments:—

"Diamond crystals. A very small crystal, exhibiting large cube faces with the edges and angles truncated, was of a rich apricot colour, the dodecahedral faces of a clear yellow, and the octahedral of another yellow tint. No polarisation of the light was detected. Some were opaque; some gave a bluish hazy light.

"Emerald. A small hexagonal prism gave out a fine crimson-red colour. The light was polarised, apparently completely, in a plane perpendicular to the axis; this would correspond therefore to extraordinary rays which in emerald, as a negative crystal, represent the quicker rays vibrating presumably parallel to the optic axis of the crystal.

"Other emeralds behaved in the same way, though the illumination in two others experimented with appeared confined more particularly to one end—the end opposite to that at which the crystals presented some (in one instance fine) terminal faces.

"Beryls exhibited no corresponding phenomena.

"Sapphires gave out a bluish-grey light, distinctly polarised in a plane perpendicular to the axis. In this case, again, the ray developed corresponds to the extraordinary or quicker ray.

"Ruby gives out a transcendently fine crimson colour, exhibiting no marked distinction in the plane of its polarisation, though in one part of a stone the colour was extinguished by a Nicol prism with its long diagonal parallel to the axis of the crystal. Here, therefore, also the light was that of the extraordinary ray.

"It seemed desirable to determine the nature of the phenomena in the case of positive crystals, and accord-

ingly crystals of quartz, phenakite, tinstone, and hyacinth (zircon), were placed in a tube and experimented on.

"The only crystals that gave definite results were tinstone and hyacinth. A small crystal of the former mineral glowed with a fine yellow light, which was extinguished almost entirely when the long diagonal of the Nicol was perpendicular to the axis of the crystal.

"Here, therefore, the plane of polarisation of the emitted light was parallel to the axis of the crystal, and here it is again the quicker, though in this case (of an optically positive crystal) it is the ordinary ray which corresponds to the light evoked by the electric stream.

"So far, then, the experiments accord with the quicker vibrations being called into play, and therefore in a negative crystal the extraordinary and in a positive crystal the ordinary is the ray evoked.

"A crystal of hyacinth, however, introduced a new phenomenon. In this optically positive crystal the ordinary ray was of a pale pink hue, the extraordinary of a very beautiful lavender-blue colour. In another crystal, like the former from Expailly, the ordinary ray was of a pale blue, the extraordinary of a deep violet. A large crystal from Ceylon gave the ordinary ray of a yellow colour, the extraordinary ray of a deep violet hue.

"Several other substances were experimented on, including some that are remarkable for optical properties, among which were tourmaline, andalusite, enstatite, minerals of the augite class, apatite, topaz, chrysoberyl, peridot, garnets of various kinds, and parisite. So far, however, these minerals have given no result, and it will be seen that the crystals which have thus far given out light in any remarkable degree are, besides diamond, uniaxial crystals (an anomaly not likely to be sustained by further experiment); and the only conclusion arrived at is, that the rays whose direction of vibration corresponds to the direction of maximum optical elasticity in the crystal are always originated where any light is given out. As yet, however, the induction on which so remarkable a principle is suggested cannot be considered sufficiently extended to justify that principle being accepted as other than probable."

WILLIAM CROOKES

ON THE LAW OF FATIGUE IN THE WORK DONE BY MEN OR ANIMALS

THE Rev. Dr. Haughton, of Trinity College, Dublin, has recently brought to a conclusion a series of papers on Animal Mechanics published in the *Proceedings of the Royal Society*. The ninth of these papers was appointed the Croonian Lecture for the present year, and the tenth paper closes the series.

The most important subject involved in these papers is the experimental determination of the law that regulates fatigue in men and animals, when work is done, so as to bring on fatigue.

Many writers, such as Bouguer, Euler, and others, have laid down mathematical formulæ, connecting the force overcome with the velocity of the movement; but these theoretical speculations have never received the assent of practical engineers.

Venturoli points out a method of observations and experiments which would serve to determine the form of the function which expresses the force in terms of the velocity, after which a few carefully planned experiments would determine the constant coefficients; and he adds that "such a discovery would be of the greatest usefulness to the science of mechanics, upon which it depends, how to employ, to the greatest possible advantage, the force of animal agents."

Dr. Haughton believes that he has found the proper form of this function, by means of experiments, and sums it up in what he calls the *Law of Fatigue*, which he thus expresses:—

The product of the total work done by the rate of work is constant, at the time when fatigue stops the work.

If *W* denote the total work done, the law of fatigue gives us—

$$W \frac{dW}{dt} = \text{const.}$$

or

$$\frac{W^2}{T} = \text{const.} \dots \dots (1)$$

The experiments made by Dr. Haughton from 1875 to 1880 consisted chiefly in lifting or holding various weights by means of the arms; the law of fatigue giving, in each case, an appropriate equation, with which the results of the experiments were compared. When the experiments consisted in raising weights on the outstretched arms, at fixed rates, the law of fatigue gave the following expression—

$$(w + a)^2 n = A \dots \dots (2)$$

where *w*, *n*, are the weight held in the hand, and the number of times it is lifted, *A* is a constant to be determined by experiment, and *a* another constant depending on the weight of the limb and its appendages.

The equation (2) represents a cubical hyperbola.

The useful work done is represented by the equation—

$$w n = \frac{A w}{(w + a)^2} \dots \dots (3)$$

This denotes a cuspidal cubic, and the useful work is a maximum, when *w* = *a*, or the weight used is equal to the constant depending on the weight of the limb and its appendages.

When the weights were lowered as well as raised at fixed rates, and no rest at all permitted, the law of fatigue became—

$$\frac{n(1 + \beta^2 t^2)}{t} = A \dots \dots (4)$$

where *n*, *t*, are the number and time of lift, *A* is a constant depending on experiment, and *β* is a constant involving the time of lift (*t*) at which the maximum work is done.

Equation (4) denotes a cuspidal cubic.

When the weights are held on the palms of the outstretched hands, until the experiment is stopped by fatigue, the law becomes—

$$(w + a)^2 t = A \dots \dots (5)$$

where *t* is the whole time of holding out.

This equation denotes a cubical hyperbola.

The *Law of Fatigue* seems, in itself, probable enough, but of course its real value depends on its agreement with the results of experiment.

If *W* denote the total work done and *R* the rate of work, the law becomes, simply—

$$W \times R = \text{const.} \dots \dots (6)$$

If different limbs, or animals were used, each working in its own way, and under its own conditions, the *Law of Fatigue* would become—

$$WR = W_1 R_1 + W_2 R_2 + W_3 R_3 + \&c \dots (7)$$

and the problem for the engineer would be, so to arrange the work and rate of work of each agent employed, as to make the useful work a maximum, the work both useful and not useful, in all its parts, remaining subject to the conditions imposed by equation (7).

In using equation (5) in his concluding paper, detailing the results of experiments made on Dr. Alexander Macalister, Dr. Haughton treats *a* as an unknown quantity, and finds from all the observations its most probable value to be—

$$a = 5.68 \text{ lbs.}$$

This result was compared with that of direct measurements made on Dr. Macalister himself, and indirect measurements made on the dead subject, from all of which Dr. Haughton concluded the value of *a* to be—

$a = 5.56 \text{ lbs.} \pm 0.125$  (possible error).  
This result agrees closely with that calculated from the law of fatigue.

It should be added that a proposal was made by Dr. Houghton to Dr. Macalister to make the experiment conclusive by direct amputation of his scapula, a course which he, unreasonably, objected to, as he draws the line of "vivisection" at frogs.

*A LACUSTRINE VOLCANO*

IN a recent number of *La Nature* further details, furnished by the French Consul of San Salvador, M. Laferrière, are given concerning the recent volcanic phenomenon in Lake Ilopango in that State. The accompanying illustration, from a photograph, will show the nature of the crater which has risen in the midst of the

lake. Earthquakes were felt in San Salvador in the first half of January of this year; there were shocks, less violent, however, than those of 1876. These earthquakes had their centre in the vicinity of Lake Ilopango, in the midst of which rose three volcanic openings connected with each other. This new crater, which, seen from a distance as in the illustration, appears a small islet, rises above the surface of the water, however, about twenty metres. An attempt was made to approach it in a boat, but the waters were all in a state of ebullition from contact with the burning rock, and gave off torrents of steam. An abundant column of smoke rose in the air, assuming the aspect of an immense cloud, which was seen from a great distance, and formed an imposing spectacle. The phenomenon was preceded by an exceptional rising of the lake, increased by the abundant winter rains. According to an old tradition the

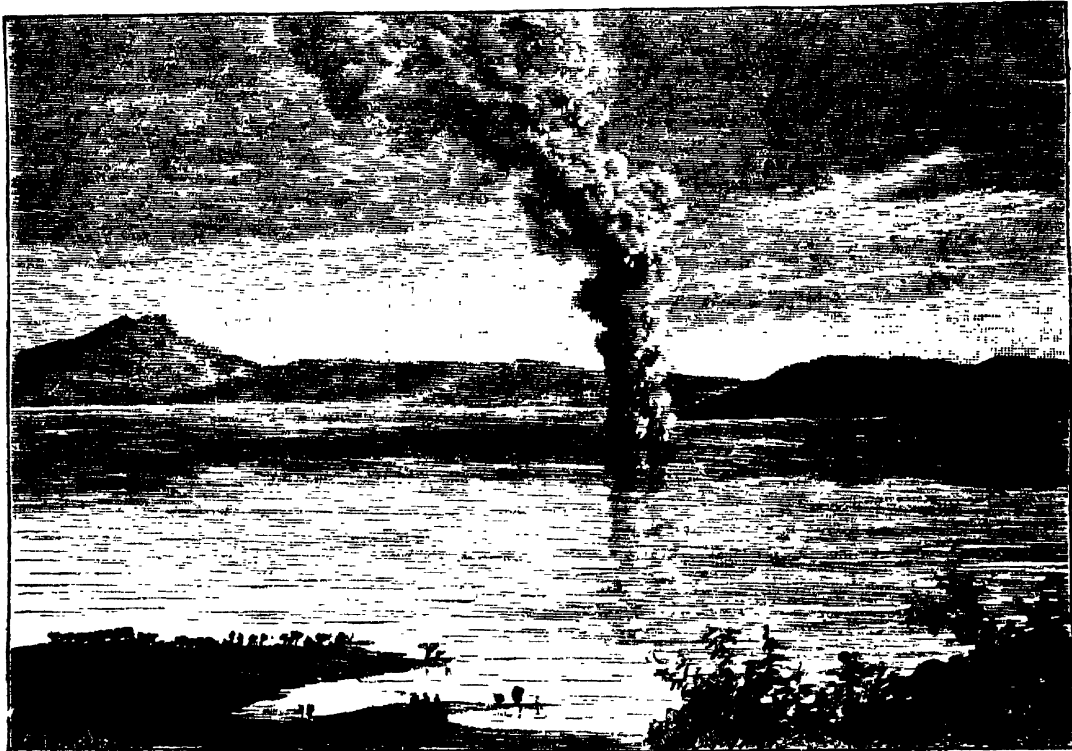

Aspect of the Volcano in Lake Ilopango. (From a Photograph.)

Spaniards maintain that when the lake rises earthquakes are to be feared. Formerly, also, it was the custom to dig trenches to facilitate the escape of the waters. This practice was followed without intermission for a century, and volcanic phenomena did not appear during all that time. The present phenomena seem to justify this tradition.

If it is difficult to explain the fact it is still interesting to remember that a great number of volcanoes are submarine, that others are found for the most part in islands or in maritime regions, and that water may be one of the feeders of volcanic fires. Lake Ilopango, also known as Lake Cojutepec, is, according to M. Laferrière, a sunk crater. It is in the volcanic line, and it is a general fact in Central America that lakes alternate with volcanic cones. The water of this lake is brackish, very bitter, and almost viscous. It gives off sometimes, here and there, bubbles of sulphohydric acid gas. The lake is about 12 kilometres long by 16 broad; the depth is

unknown. It is about 12 kilometres from the city of San Salvador. The Consul of France in Guatemala, M. de Thiersant, states that Lake Ilopango has now a temperature of 38° C. on its shore, and is in complete ebullition round the volcano. All the fishes are cooked and float upon the surface, with a great number of shellfish and other aquatic animals. The volcano continues to rise, and the level of the lake is being gradually lowered.

NOTES

THE candidates whose names we gave in a recent number (vol. xxi. p. 616) were elected Fellows of the Royal Society at the meeting of last Thursday. They are:—Dr. Clifford Allbutt, Prof. J. Attfield, Mr. H. E. Blanford, the Rev. W. H. Dallinger, Mr. Threlton Dyer, Lieut.-Col. Godwin-Austen, the Bishop of Limerick, Prof. D. E. Hughes, Mr. H. M. Jeffery,

Prof. F. M'Coy, Mr. J. F. Moulton, Prof. C. Niven, Dr. J. Rae, Prof. J. E. Reynolds, Dr. W. A. Tilden.

IN the last number of the Berlin Chemical Society's *Journal* Prof. V. Meyer announces that he has been able to determine the density of iodine vapour at a considerably higher temperature than before, and that he has obtained values closely approximating to those required on the assumption that the gas then consists of monatomic iodine molecules. He proposes to extend his observations, if possible, to still higher temperatures, in order to ascertain whether the dissociation can be carried further; for this purpose he proposes to employ the recently described oil furnace of Deville and Troost, which is capable of fusing porcelain, and he hopes to be able to make use of vessels of graphite if those of porcelain are not sufficiently refractory.

FROM a copy of some correspondence which has passed between Sir Joseph Whitworth and Lord Beaconsfield, we see that Sir Joseph wrote to his Lordship on February 21, calling this Lordship's attention to what he had done so far back as twenty-four years since to the improvement of rifled arms.

"By means of elaborate and careful experiments I obtained facts, and established certain laws, both with regard to artillery and small arms. These laws have never been invalidated. Some, though denied and disregarded at the time, are now accepted without question by all who have studied the subject, not only in this country but abroad; while others, equally important, have not yet been acted upon." Sir Joseph, after stating that he is anxious to point out the very unsatisfactory nature of the present system of determining questions, or rather of advising the responsible Minister on subjects which require a knowledge of mechanics and metallurgy, says: "I believe I am not doing any injustice to the officer or officers who have, or who have had, for years past, to advise the Secretary of State for War in these matters, when I say they have no such knowledge—they cannot have it. The very fact that they are able and distinguished soldiers precludes it. Nor, as far as I am aware, has the possession of mechanical knowledge, or of what I may term a mechanical instinct, any bearing on their election for a post for which administrative ability is necessarily a first qualification. Further, the War Office has no such skilled technical advisers as the Admiralty has in naval architects and naval engineers. It is to this that I attribute the deficiency in our artillery and small arms. Instead of being, as we might be, in advance of other nations, it is a question whether we are on a level with some of them." Sir Joseph then asks the favour of an interview, in order to bring this matter more clearly before Lord Beaconsfield, who received the request very favourably. Unfortunately, before Sir Joseph was able to carry out his disinterested intentions, he was compelled to leave the country on account of his health.

A NEW skating surface called "crystal ice" has been invented by Dr. Calantarients of Scarborough. Considering that after all ice is merely a crystalline substance, and that there is no lack of substances that are crystalline at ordinary temperatures, Dr. Calantarients experimented with a variety of salts, and after a time succeeded in making a mixture consisting mainly of carbonate and sulphate of soda, which, when laid as a floor by his plan, can be skated on with ordinary ice-skates; the resistance of the surface is just equal to that of ice, it looks like ice, and indeed when it has been skated on, and got "cut up" a little the deception is quite astonishing; a small experimental floor has been laid in the skating rink at Prince's, and has proved so successful that no doubt a large floor will be laid there or at some other convenient place in the autumn. This floor will obviously have great advantages, both over artificial ice floors, which are very expensive indeed, and over floors for roller-skating. The surface can at any time be made smooth again by

steaming with an apparatus for the purpose, and the floor itself when once laid will last for many years. It is interesting to observe that the mixture of salts used contains about 60 per cent. of water of crystallisation, so that after all the floor consists chiefly of solidified water.

MEMBERS of the General Committee and others who have not yet paid their subscriptions to the Clifford Testimonial Fund are requested to forward them to Messrs. Roberts, Lubbock, and Co., or to either of the honorary secretaries, Dr. Corfield, No. 10, Bolton Row, Mayfair, W., and Dr. Lee, No. 6, Savile Row, W.

IN our next number we shall give the first instalment of a paper by Dra. De La Rue and H. W. Müller, on some of their most recent Experimental Researches in Electricity. The second instalment of this paper will be accompanied by a fine plate illustrating the experiments, kindly furnished to us by Dr. De La Rue.

WE understand that a most interesting entomological problem has been solved. The singular aquatic animal originally described by Latreille as a crustacean under the name *Prosopistoma*, and which the French entomologists have affirmed to be the aquatic condition of an insect of the family *Ephemeride*, has been traced through all its transformations by M. Vayssière, and the result is such as to entirely confirm their belief.

THE Annual Visitation of the Royal Observatory was made on Saturday, when the Astronomer-Royal presented his usual report.

THE first of the Davis Lectures for 1880, on "Teeth," by Prof. Flower, was given in the lecture-room in the Zoological Society's Gardens, in the Regent's Park, on Thursday last week. The other lectures are as follows, the hour of lecture being 5 p.m.—June 10, "Cats," by Prof. Mivart, F.R.S.; June 17, "Tadpoles," by Prof. Parker, F.R.S.; June 24, "Hawks and Hawking," by J. E. Harting, F.Z.S.; July 1, "Cuttle-fishes and Squids," by Prof. Huxley, F.R.S.; July 8, "Waterfowl," by P. L. Sclater, F.R.S.; July 15, "Birds," by W. A. Forbes, F.Z.S. These lectures will be free to Fellows of the Society and their friends, and to other visitors to the Gardens.

AS we announced last week, the annual meeting of the Helvetic Society of Natural Science will be held at Brieg (Canton Valais), at the foot of the Simplon, on September 12 to 15. The great building of the college and the palace of Baron Stockalper are at the disposal of the Society. The committee speak in glowing terms of the various attractions which will be found in this locality by geologists, mineralogists, and entomologists, the "generous wine of Valais" being not the least among the attractions promised to botanists.

THE twelfth meeting of the Scandinavian Naturalists and Physicians will take place at Stockholm on July 7 to 14 inclusive. A numerous attendance is expected from Denmark and Norway, as well as from other countries.

A LARGE German Horticultural Exhibition is planned for the summer of 1882. It will be held at Bremen in connection with the twenty-fifth anniversary of the foundation of the Horticultural Society of that city.

IT is believed that the engineers of the St. Gothard Tunnel will be able to overcome the difficulty arising from the threatened collapse of the passage in the part known as the "Windy Stretch." According to Prof. Colladon, the strata in this section are composed of a calcareous aluminous schist, which has a great affinity for moisture, and swells enormously on exposure to the air. If a tunnel were made through Mont Blanc, 3,000 metres of similar material would have to be pierced and vaulted.

M. BRESSE has been elected to fill the place vacated by the death of General Morin in the Section of Mechanics of the Paris Academy of Sciences.

THE Vesuvius railway was opened on the 6th inst. with much ceremony. It was found to work with perfect satisfaction.

AN experiment with Jamin's electric candle was made on a large scale at the works of the Compagnie Générale d'Electricité, 67, Avenue du Marine, Paris, on June 3. About 1,900 people had been invited, amongst them the principal authorities of the French Republic. The light was found steady, but it remains to be seen whether the expense is smaller than with other systems, and the apparatus can work during a series of days. The candles are moved by a combination analogous to Wild's patent. The weight of wire utilised for each of these frames is 600 to 700 grammes, which shows a length of about 80 metres. M. Jamin wants tension for working his candles, and his Gramme machines rotated with a very great velocity. The scene was very picturesque and the general impression was good, although not enthusiastic, as has been reported in several political papers.

THE Swiss Naturalists Association have decided to erect the Meteorological Observatory, the establishment of which was recommended to them by the International Meteorological Congress which met at Rome last year, upon the Säntis Mountain, in the canton of Appenzell. This peak is better adapted for the purposes of meteorological observation than any other one in Switzerland, on account of its comparatively isolated position. The observatory will cost about 320%, besides which 360% will be spent annually for its maintenance and staff.

MR. G. H. KJNAHAN writes us that a wooden hut has been discovered lately under sixteen feet of bog by Thos. Plunkett, M.R.I.A., of Enniskillen. It is remarkable that this structure is at the same depth as the similar structure found at Drunkelin, and described by Wilde in the Catalogue of the Royal Irish Academy.

A LARGE crowd is attracted every night to the Palais de l'Industrie, Paris, where are burning regularly 400 Jablockhoff lights, on the occasion of the Exposition des Beaux Arts, a floral exhibition having taken place in the nave from June 1 to 10, the scene in the nave surpassing description.

ELECTRIC light experiments on a large scale will be conducted with Wild candles at the Universal Exhibition of Melun. The gardens will be opened every night and lighted by electricity.

AN international exhibition was opened at Brussels on June 1 by the king. It is a private speculation, which must not be confounded with the national exhibition which will be opened on June 19, and is the only official display in the capital of Belgium.

M. MARCHE has invented in Paris a new telephone, which he calls electrophone, and which works with an induction coil. The induction current is sent from a distance which is said to be very large, and the hearing is said to be satisfactory.

M. CAILLERET, a telegraphist of Lille (Nord), discovered a new method of rotating the electro-magnetic gyroscope with any induction coil. It is to employ the thin wire as an inductor, and the thick one for sending the induction current to the coil.

A PROSPECTING party, despatched by the Queensland Government, is stated to have discovered a very rich gold-field on the Sefton River in the north of the colony. An examination of the country along the east coast of Cape York Peninsula has not, however, proved successful.

It is stated that at Wickham, about 100 miles south of Sydney, New South Wales, two surface bands of metallic stone of considerable width have just been discovered. On analysis it is found that there is a large amount of gold and silver in one of these, while the other contains over 60 per cent. of iron with traces only of gold. A large and enormously valuable diamond is also said to have been discovered in the same locality.

THE Naples correspondent of the *Daily News* states that twelve miles south of Sciacca, on the coast of Sicily, an exceedingly rich bank of corals has been discovered, which is even more important than the one found in 1876 in the same waters.

MR. DAVID BOGUE has now at press and will shortly publish a new work, viz., "Birds, Fishes, and Cetacea of Belfast Lough," by Mr. R. Lloyd Patterson, vice-president of Belfast Natural History Society, and president of Belfast Chamber of Commerce, son of the late Robert Patterson, F.R.S. The book will form an interesting and valuable addition to this branch of natural history.

A TERRIBLE forest fire took place in the Harz Mountains on May 27 last. The whole forest of the Great Jügelberg, near Goslar, is destroyed.

THE forty-fourth general meeting of the Saxon and Thuringian Natural History Society took place at Nordhausen on May 18 and 19 last. The Society numbers between 300 and 400 members.

THE nights of May 18 and 19 were fatal to almost all vineyards on the banks of the Rhine and its tributaries. The young shoots on most of the vines were killed by the frost, which was intense.

AN interesting novelty in the German book-market is "Upilio Faimali, Memoiren eines Thierbändigers," collected by Paul Mantegazza. It is published by Winter, of Heidelberg. Faimali was one of the few tamers of wild animals who gained universal reputation. The book contains interesting narratives of his numerous adventures with various beasts.

ON MAY 11 last the statue of the late M. Quetelet was unveiled in the gardens of the Brussels Academy buildings. He is represented in a sitting posture, his left hand rests upon a large celestial globe, and he holds a pen in his right. The expressive features are said to be an excellent likeness.

A CURIOUS survival of mediæval superstition has cropped up in a rumour which obtains credence in the West of England, that Balmain's luminous paint is prepared with *human fat*, in order to give it its phosphorescent properties!

ON the Schleswig coast in the Little Belt the establishment of oyster beds is engaging the active attention of the authorities. One million and a half of small oysters have been "sown out" between the Gjenner Bay and the Danish frontier near Heilsuminde.

#### OUR ASTRONOMICAL COLUMN

WINNECKE'S COMET.—In No. 2,314 of the *Astronomische Nachrichten* Prof. v. Oppolzer has a note of more than ordinary interest on the motion of this body as investigated by his own calculations. He states that it results from his computation of the perturbations with the object of connecting the three appearances of 1858, 1869, and 1875 that a satisfactory agreement cannot be found without one of two hypotheses; either the mass of Jupiter must be diminished to  $\frac{1}{10}$ , or there is a necessity of admitting the existence of a similar extraordinary influence upon the motion of this comet to that first pointed out by Encke in the motion of the comet which bears his name. Prof. Oppolzer finds an acceleration in the mean daily sidereal motion of  $0^{\circ}.01439$  after one revolution, a result which, he remarks, is in close accordance with his earlier one, deduced by a provisional calculation of

the perturbations, from the observations made at the comet's<sup>8</sup> appearance in the summer of 1819. He infers from his researches<sup>8</sup> upon Winnecke's comet a value for Encke's force designated by  $U$ , differing little from that assigned by Encke from his discussion of the motion of his comet, the more satisfactory considering that much latitude must be allowed in this direction. He further observes that with  $U = \frac{1}{117}$  the effect upon the motion of Faye's comet would be so small that it is necessarily mixed up with uncertainty in the values of the perturbations; it will be remembered that Prof. Axel-Möller, who has laboured so admirably to follow up with every precision the motion of Faye's comet, has not, since his computations assumed their present refined form, been able to detect any abnormal effect upon it.

With regard to a diminution in the mass of Jupiter it is to be remarked that all the newer reliable determinations have confirmed the value deduced by Bessel from the elongations of the satellites, including that inferred by Prof. Krueger from the perturbations of Themis, and that which Dr. Axel-Möller has found from his researches on the motion of Faye's comet. Such diminution, therefore, appears inadmissible.

THE IMPERIAL OBSERVATORY, STRASSBURG.—In a communication to the *Astronomisches Gesellschaft* Prof. Winnecke has given details of the construction and instrumental equipment of this new establishment, which we cannot doubt, under his skillful and energetic direction, is destined to take its place amongst the most prominent of astronomical institutions. The principal instruments are—(1) the meridian circle, with object-glass of 6'4 inches aperture, which has been constructed by Repsold and was completed several years since; (2) the alt-azimuth, of 5'35 inches aperture and 4'9 feet focal length, also by Repsold; (3) the refractor, of 19'2 inches aperture and 23 feet focal length, by Merz, but mounted by Repsold, the object-glass being found to be of great excellence; (4) an "orbit-sweeper," constructed according to the design of Sir George Airy, as explained in the *Monthly Notices of the Royal Astronomical Society*, vol. xxi. p. 158; this is, so far as we know, the only instrument of the kind yet mounted, and has been used for some time by Prof. Winnecke in the provisional observatory at Strassburg; the aperture of the object-glass is 6'4 inches, which is not greater than it is essential to provide for the advantageous use of the peculiar mounting. We may hear of the application of the "orbit-sweeper" to the search (which it is not too soon to commence) for the comet of 1812, and later on for Olbers' comet of 1815, neither of which bodies will admit of accurate prediction. A plan of the buildings and grounds accompanies Prof. Winnecke's notice in the *Vierteljahrsschrift*.

THE COMPANION OF SIRIUS.—Mr. Burnham publishes mean results of numerous measures of the small companion of Sirius made with the 18-inch refractor at Chicago in the years 1877-80. We subjoin them with the errors indicated for Prof. Auwers' ephemeris in his *Untersuchungen über veränderliche Eigenbewegungen*:—

Epoch.	Position.	Error of ephemeris.	Distance.	Error of ephemeris.
1878'01	52'4	+6'0	10'83	-0'78
1879'13	50'7	+5'5	10'44	-0'77
1880'11	48'3	+5'7	10'00	-0'72

### METEOROLOGICAL NOTES

AMONG the interesting papers which appear in the *Annales du Bureau Central Météorologique de France* for 1878 there is one by Prof. Hildebrandsson, of peculiar value, On the Freezing and Breaking-up of the Ice on the Lakes, the Epochs of Vegetation, and the Migration of Birds in Sweden, based on the observations made by a numerous staff of observers scattered over the country. The paper is illustrated by a diagram showing the seasonal distribution of temperature for ten of the more typical climates of Sweden, and by twelve maps indicating the geographical distribution of the physical and biological phenomena under discussion. Since the lakes of Sweden, which occupy a twelfth part of its entire superficies, exert powerful and diverse influences on plant and animal life, according as they are frozen or open, special attention has been directed to their examination. The results show that while the lakes in the extreme south are covered with ice on an average of ninety days in the year, those in the extreme north are 230 days bound with ice. The average date of the freezing of the lakes in the north is October 10, whereas in the south

this does not take place till December 10. On the other hand, the ice breaks up in the southern lakes on April 1, but in the north not until the first week of June. The maps show the decided manner in which the curves are deflected and modified by such extensive sheets of water as are presented by Lakes Wener, Wetter, and Maelar, by height above the sea, and by the Atlantic in different seasons. During the freezing of the lakes the south-west winds of the Atlantic attain a maximum force and frequency, and under this influence the high lakes to westward of, the head of the Gulf of Bothnia do not freeze till November 30, or six weeks later than the lakes in the same latitude near Haparanda. On the contrary, at the time of the breaking-up of the ice in spring, easterly winds are prevalent, and the ice on the lakes near the head of the Gulf of Bothnia breaks up four weeks earlier than that of the more elevated lakes to westward. An interesting examination is made of the dates of the breaking-up of the ice on Lake Maelar at Westerås from 1712 to 1871, and from a comparison of the averages of each of the ten-year periods it is seen that the earliest was April 14 for the decade 1722-31, and the latest, May 5, for 1802-11. Whilst the results for these 160 years indicate considerable fluctuations, they give no countenance to the idea that any permanent change has taken place in the climate of Sweden. Three maps show the number of days in which the plants that flower in the extreme south in April, and those in May, come successively into bloom, and the leafing of trees occurs at different places on advancing northward. As regards the plants which come into bloom in the south in April, their time of flowering is forty-five days later at the head of the Gulf of Bothnia, and sixty days later in the elevated districts to westward, but as regards the plants which bloom in the south in May, the times are only twenty-five and thirty-five days. The curves of the May flowers are closely coincident with the curves representing the breaking-up of the ice of the lakes. The time taken for the advance northward from the south to the head of the Gulf of Bothnia is twenty-three days for the leafing of trees and the flowers of May, whereas the time taken by the April flowers is forty-three days. The curves showing the times of arrival of four of the more marked of the migratory birds differ much from each other. The lark arrives in the south on March 1, and in the north on May 1, and the arrangement of the curves of arrival closely agrees with the curves showing the breaking-up of the ice of the lakes but a month earlier. As regards however the wild goose, the cuckoo, and the woodcock, the curves showing their arrival assume a different form, and point to an intimate connection subsisting between the arrivals and the temperature of the place at which they arrive.

To mark the high value they set on carefully-made observations, the Council of the Scientific Association of France have awarded medals to Lieut. Pouvreau, serving on the line from Havre to New York, Lieut. Benoît, of the *Yang-Tse*, plying between Marseilles and Shanghai, and Captain Corenwinder, of the *Grenadier*, Dunkirk, for the meteorological observations made by them, these comprising, in addition to the usual observations, numerous and elaborate notes on whirlwinds and other special phenomena. At the same time a medal was awarded to M. Vidal, schoolmaster at Fraisse, Hérault, for a peculiarly interesting series of observations made by him during the past fifteen years, regularly in winter as well as in summer, at a height of 3,150 feet above the sea. M. Vidal has also, from his wide and varied knowledge of the natural sciences, rendered effective service to scientific men in their excursions into the higher districts of that part of France.

PROF. FORNIONI has recently described to the Istituto Lombardo (*Rendiconti*, vol. xiii. fasc. 3) a simple nefoscope, or instrument for measuring the direction of motion of clouds (the instrument of the kind known as that of Braun being thought expensive and inconvenient to use). It consists of a flat compass case with pivoted needle, above which is fixed horizontally a plane mirror occupying the whole of the case. On the surface of the glass are drawn diagonal lines corresponding to the rise of winds. The amalgam is removed in a narrow arc extending from north to north-west, so that the end of the needle may be seen for the purpose of orientation, and this transparent arc is graduated. A rod with terminal eye, freely pivoted on the edge of the case, completes the instrument. When the direction of a given cloud is to be determined, the nefoscope is placed in a horizontal plane and properly oriented. The rod

is then moved to such a position that the observer's eye sees three points in a straight line, viz., the eye of the rod, the centre of the mirror, and the reflected image of a selected point of the cloud. The direction of the displacement which the latter undergoes after a time, proportional to the velocity of the cloud and inversely as its distance, is the required direction.

THE Report of the Royal Society of Tasmania for 1878 includes the tri-daily meteorological observations made at Hobart Town by Mr. Francis Abbott, so long an enthusiastic observer there, together with the annual abstract of his observations, and also an annual abstract of observations made by Mr. W. E. Shoobridge at New Norfolk, situated about fifteen miles from Hobart Town, higher up the Derwent. Observations were formerly made at Port Arthur, Swansea, Swan Island, and Kent's Group, viz., from 1861 to 1866, but at present Hobart Town and New Norfolk appear to be the only meteorological stations in the colony, the observations at Hobart Town dating from 1841, and those at New Norfolk from 1874. Mr. Abbott prints also his daily observations made at 10.33 P.M. in connection with Gen. Myer's international synchronous observations, the importance of which we have several times had occasion to refer to in describing the United States weather maps. The regular hours of observation are 7.30 A.M. and 4.30 P.M., these hours having been adopted since 1876, as stated in the Report, with the view of assimilating the records more closely with those of stations in Europe, America, &c., in order to co-operate in a system of international meteorology. These hours have not been happily chosen for general meteorological purposes, particularly since it is the practice to adopt as the mean temperatures of the separate months simply the mean of the observations at the above hours, which, whilst only very slightly below the true mean during the winter months, are from 1°·5 to 2°·8 too high for the four warmest months of the year.

#### PHYSICAL NOTES

AT the last meeting of the Physical Society of Paris some new and curious experiments upon the so-called magic mirrors of Japan were shown by M. Dubosq and discoursed upon by M. Bertin. Mirrors having a sufficiently true surface to give a fairly good virtual image of an object held near to them may yet be very irregular in the actual curvature of the surface and produce a very irregular real image of a luminous point reflected by the mirror upon a screen. If such a mirror be warmed the thinner portions change their curvature, becoming flatter, and yield dark corresponding patches in the disk of reflected light. A mirror which gives very imperfect effects when cold will give very good ones when heated. If, by means of a condensing pump, a uniform pressure is exerted against the back of the mirror, the thinner portions are more affected than the thick portions, and therefore, as viewed from the front, become less concave than the rest of the surface, the result upon the reflected beam being that the pattern of the thicker parts comes out bright on the darker ground of the image. Lastly, if a mirror be cast upon the face of the original mirror, and then polished, it will when warmed become a "magic" mirror, though when cold it yields only a uniformly illuminated disk upon the screen. This last experiment alone suffices to show that the cause of the reputed magical property is to be sought not in any difference of reflective power in different parts of the surface, but in slight differences of curvature of the surface.

A NEW zinc-carbon battery, the patent of Mr. R. Anderson, is announced. The exciting liquid is a mixture of hydrochloric acid, bichromate of potash, and of certain other "salts" in a mixture, for the composition of which Mr. Anderson claims the protection of the patent. The battery may be used either with or without a porous cell. It is stated that the E.M.F. of this battery is as high as 2·15 volts, that it is remarkably free from local action and internal resistance, and that it is very constant, one cell having twelve square inches of effective surface of the zinc, giving for seventy hours a constant current.

MR. A. A. MICHELSON, of the U.S. Navy, has communicated to the New York Academy of Sciences some interesting observations upon the diffraction and polarisation effects produced by passing light through a narrow slit. If a fine adjustable slit be narrowed down very greatly, the coloured diffraction fringes widen out until when the width of the slit is reduced to less than one-fiftieth of a millimetre, the central space only is seen, and appears of a faint bluish tint. Moreover, the

light so transmitted exhibits traces of polarisation when regarded through a Nicol prism. If the slit is still further narrowed, the depth of the tint and the amount of polarisation increase, until, when a width of only one-thousandth of a millimetre is reached, the colour becomes a deep violet and is perfectly polarised. In this experiment the Nicol prism may be used either as polariser or as analyser. Slits of iron, brass, and obsidian produce identical results, though with the latter material, which can probably be more finely worked, the effects are the most pronounced. The polarisation is in a plane at right angles to the length of the slit. The phenomenon is best observed by using direct sunlight, placing the slit as near the eye as possible, and analysing with a double-image prism, thus enabling the delicate changes of tint to be observed by comparison. The possible explanation that the light which thus comes through the slit is reflected at its edges accords with the direction of the plane of polarisation; but there remains the difficulty that these effects should take place with all widths of slit and vary with the nature of the materials. One important point is that a slit of this degree of fineness admits the shorter waves of light more freely than the longer waves.

LORD RAYLEIGH showed a curious experiment in colour-combinations to the Physical Society, when he produced a yellow liquid by mixing a blue solution of litmus with a red solution of bichromate of potash. We recollect a kindred experiment which is even more curious, namely, the production of white by the mixture of crimson and green. An aqueous solution of cuprous chloride and a solution of rosaniline acetate in amyl alcohol are placed in a bottle in certain relative quantities. The crimson solution floats upon the green solution. But when shaken up together both colours disappear, and the mixture is simply a turbid greyish white.

MR. PREECE's new microphone or telephone transmitter has at least the merit that it surpasses all others for simplicity. A very thin wire stretched between two points forms part of a circuit containing a Bell telephone and a small battery. When it is set vibrating by sounds, the vibrations, by varying the strain to which it is subjected, alter its conductivity, probably by producing alterations in its temperature.

M. OBALSKI describes a pretty magnetic curiosity to the Académie des Sciences. Two magnetic needles are hung vertically by fine threads, their unlike poles being opposite one another. Below them is a vessel containing water, its surface not quite touching the needles. They are hung so far apart as not to move towards one another. The level of the water is now quietly raised by letting a further quantity flow in from below. As soon as the water covers the lower ends of the needles they begin to approach one another, and when they are nearly immersed they rush together. The effect appears to be due to the fact that when the gravitation force downwards is partly counteracted by the upward hydrostatic force due to immersion, the magnetic force, being relatively greater, is able to assert itself.

THE phenomenon of luminosity of a (especially) negative electrode of small surface used in electrolysis of, e.g., acidulated water, has been investigated by Prof. Colley of Kasan (*Jour. de Phys.*, May). Examining the light (which Slouguinoff found associated with an intermittence of the current) with a rotating mirror, he saw on a weakly luminous ground a multitude of bright star-like points, each appearing only an instant, and distributed without apparent regularity. The spectrum of the negative electrode was found to be composed of bright lines, determined both by the liquid and the substance of the electrode. Some physicists have thought that the electrode is considerably heated, and that the liquid round it assumes the spheroidal state, being separated by a layer of vapour. M. Colley finds that with a very strong current the electrode indeed becomes incandescent, and the liquid ceases to moisten it. He shows, however, that the illumination may be produced on an electrode quite cold, and he seeks the cause of production of vapour (of which he supposes the isolating layer to consist) in the high temperature of the liquid immediately surrounding the electrode (not in that of the electrode itself), heat being developed by reason of the small surface and small conductivity of a thin sheath of liquid. With a pile of 100 Bunsen couples, water containing 5 per cent. of sulphuric acid, and an electrode of 10 sq. mm. surface, 1·3 seconds would suffice to raise the layer next the electrode from 20° to 100° C. The sheath of gas

formed round the electrode may serve as germ for formation of a layer of vapours, and this being once formed, the discharges occur by sparks.

### GEOGRAPHICAL NOTES

We are delighted to find that our good neighbours, the French, will not be behind the rest of the scientific world in exploring the depths of the sea. A large Government steamer, the *Travailleur*, will be at Bayonne on the 15th of next month to undertake a dredging expedition along the Atlantic coasts of Spain, under the charge of Prof. Milne-Edwards and the Marquis de Folin. Dr. Gwyn Jeffreys and the Rev. Mr. Norman have been officially invited to take part in this expedition. The Dutch are also making arrangements for a dredging expedition in the West Indies.

FROM a note in the June number of the *American Naturalist* it seems extremely likely that the U.S. Senate will endorse the approval given to the Howgate Polar Expedition by the House of Representatives. The steamer *Gulnare*, 230 tons burden, is being fitted up, and will have a crew of fifteen officers and men. The observing party, which will be left at the station as near Lady Franklin Bay as possible, will consist of twenty-five men, including the necessary scientific corps. A house of wood is being fitted up for the men to winter in on the shores of Discovery Bay, and a steam launch will form part of the expedition. "In making this report the committee respectfully state and report that the object of the bill, as is shown by its terms, is to authorise a temporary station to be selected within the Arctic circle, for the purpose of making scientific discoveries, explorations, and observations, obtaining all possible facts and knowledge in relation to the magnetic currents of the earth, the influence of ice-floes therefrom upon the winds and seasons, and upon the currents of the ocean, as well as other matters incidental thereto, developing and discovering at the same time other and new whale-fisheries, now so material in many respects to this country. It is, again, the object of this bill that this expedition, having such scientific observations in view, shall be regularly made for a series of years under such restrictions of military discipline as will insure regularity and accuracy, and give the fullest possible return for the necessary expenditure; and again, in view of the fact that either the governments directly, or scientific corps under their authority, of Germany, Holland, Norway, Sweden, Austria, Denmark, and Russia, have concurrently agreed to establish similar stations, with like object, during the year 1880, it is believed that the interests and policy of our people concur in demanding that the United States should co-operate in the grand efforts to be thus made in the solution of the mysteries and secrets of the North Polar seas, upon which, in the opinion of scientists, depends so much that affects the health and wealth of the human race." This station will form one of the series of International Arctic Observatories to which we have already referred.

DURING the past year H.M.S. *Alert*, first under Sir G. S. Nares, and afterwards under Capt. Maclcar, was engaged in very useful service on the west coast of South America, chiefly in examining the channels in about 50° S. lat. Trinidad Channel, which opens out a clear passage to the Pacific 160 miles north of Magellan Strait, has been carefully surveyed, together with its various ports and anchorages. This channel forms a valuable addition to our knowledge of these waters, as it will enable vessels bound westward to avoid the heavy sea often met with in the higher south latitude. Its southern shores are bounded by bold rugged mountains rising abruptly from the sea, and on the north side a low wooded country lies between the sea and the snow-clad mountains in the distance. The *Alert* also visited St. Felix and St. Ambrose Islands, which, owing to the depth of the soundings obtained, are thought to be unconnected with both the South American continent and the San Juan Fernandez group. Capt. Maclcar describes St. Ambrose Island as volcanic, composed of lava in horizontal strata, intersected vertically by masses of basalt. Vegetation is scant, and the island is without water; though frequented by sea-birds, its sides are too steep and rugged for guano to collect. From the soundings it would seem that this, as well as the other islands, rises as an isolated mountain from a submarine plateau.

At the meeting of the Paris Geographical Society of May 7 a Greek physician, Dr. Panagiotis Potagos, was introduced by MM. Ujfalvy and Duveyrier as one of the most extensive tra-

vellers of our time. M. Potagos, we are told, has since 1867, beginning at Tripoli in Asia Minor, visited Teheran, skirted the Paropamisus on his way to Medjid, Herat, Kandahar and Kabul; crossed the Hindu Kush by one of the most difficult passes, traversed Badakshan, Wakhan, and all Kashgaria, arriving at Hami in 1871. Thence he went to Ulussutai in the heart of Mongolia, returning to Hami, where all his notes and collections were destroyed, and he himself kept prisoner for more than a year. Thence continuing his journey, he reached Kulja, and returned to Europe by Sempalatinsk, Omsk, Moscow, and St. Petersburg. After staying at Salonica for two years, he went to Bombay and Peshawur, descended the Indus to Karachi, thence to Bunder-Abbas in Persia, crossed the mountains of Laristan, and made his way to Kabul, reaching India again by the Kurrum Valley, meeting Major Cavagnari on his way. From Bombay he went to East Africa, and penetrated into the interior farther than Schweinfurth. The principal sphere of his African journeys seems to have been in the region of the River Beré, which M. Deveyrier is of opinion is the Wellé of Schweinfurth, but which, according to M. Potagos, cannot be connected with the Aruwimi of Stanley, but rather with the basin of the Shari. The observations of M. Potagos are, however, too vague to be of much scientific value, unless, indeed, further details be forthcoming.

MR. LAURENCE OLIPHANT has lately returned to England from a journey of exploration on the eastern side of the River Jordan, and is, we believe, engaged in preparing for publication an account of the results of his investigations.

THE map of Equatorial Africa, on the scale of 15.8 miles to one inch, on which Mr. E. G. Ravenstein has for some time been engaged for the Geographical Society, is stated to be approaching completion, and it is expected that the lithographed sheets will be ready during the summer. An analytical catalogue of works on African travel and geography, including papers in periodicals, is being compiled at the same time.

MR. STANFORD has just published a fine new wall map of New Zealand, on the scale of seventeen miles to an inch. The whole of the coast line, together with the details of harbours and banks of these islands, has been carefully reduced from the most recent Admiralty Charts. The interior details of rivers and mountains, roads and railways, towns and villages, have been plotted in from the various Government surveys and partly from private sources. Although not over-crowded with names, it contains, besides the chief physical features, the names of all villages and other centres of population, together with the names of many places of interest, such as the geysers or hot springs and the boiling lakes of the North Island. The principal Maori tribal names are also given over the areas once occupied by them. The map is coloured to show the boundaries of the new administrative divisions, all of which are named. The large size, accuracy, and clearness of this map render it eminently useful for teaching purposes.

THE annual address of Chief Justice Daly, President of the American Geographical Society, on the Geographical Work of the World in 1878 and 1879, is as usual, remarkably comprehensive and well arranged; indeed it is the best summary of the subject we have seen.

*L'Exploration* of June 2 contains an interesting article on the various explorations of M. Paul Soleillet in Africa. There is also a map of the French possessions and factories on the coast of Guinea.

"ANGLO-CANADIAN" sends us the draught of a scheme for reaching the North Pole by balloon in comparatively few days, at a cost which must take the gas completely out of the elaborate and expensive scheme of Commander Cheyne. Our correspondent has patented a directable balloon, which he maintains is capable of being moved at a rapid rate in any direction. We need not enter into the details of his plan, which reads very glibly, but which we should like to see subjected to rigid scientific tests. The whole scheme is to cost only 2,000*l.*, including a steamer to be chartered to Spitzbergen to take the necessary compressed gas which "Anglo-Canadian" would use as fuel. We do not attach much importance to the attainment of the Pole, and should prefer to see any money that can be raised for Arctic exploration in this country devoted to the founding of one of those international series of Arctic observations from which England is conspicuously absent.



It may interest such of our readers as are conversant with the German language to know that in the course of the present month Dr. Ernst von Hesse Wartegg will deliver a lecture at the German Athenæum (93, Mortimer Street, W.), entitled "Das Leben der Bedämen." The secretary of the institution will furnish all particulars regarding exact date and admission to the lecture on application by letter.

AFTER the example of the German and Austrian Alpine Clubs, a Bohemian Mountain Club is now in course of formation.

THE authors of Sweden and Finland have edited a festive paper, "Nordostpassagen," in honour of Prof. Nordenkjöld's return, which deserves high commendation, both with regard to text and illustrations. It is published by C. E. Fritze, of Stockholm.

IN a letter from M. Berlioux, read at the Paris Academy of Sciences on May 31, the writer attempts to prove from the last expedition of Dr. Rohlfs in the Eastern Sahara the marvellous correctness of Ptolemy's Tables.

IT is stated that Col. Gordon, who has resigned his post on the staff of Lord Ripon, is to proceed to Zanzibar to join the Belgian African exploring expedition.

THE question of the speedy completion of the Ordnance Survey came up in the House of Commons last Friday, when there was an almost unanimous consensus of opinion that Government ought at once to advance as much money as was necessary to complete the work. The reply of Mr. Adam and Mr. Gladstone was virtually a *non possumus*. It was not so much the difficulty of advancing the money as of obtaining the necessary amount of skilled labour to carry on the work under pressure. At the present rate the survey cannot be completed for eighteen years.

#### DR. SIEMENS' NEWEST ELECTRICAL RESULTS

A PAPER was read on Thursday last before the Society of Telegraph Engineers by Dr. Siemens, F.R.S., upon "Recent Applications of the Dynamo-Electric Current to Metallurgy, Horticulture, and the Transmission of Power." The author first referred to the inaugural address which he had given before the Society on his election to his second presidency, wherein he drew attention to the applicability of the dynamo-electric current to purposes beyond the range of what electricity had theretofore been employed in effecting. On the present occasion he corroborated his statements by a reference to recent experimental results of his own.

The first part of the paper had reference to an electric furnace. This furnace consists of any ordinary crucible of plumbago or other highly refractory material, which is placed in a metallic jacket or outer casing, the intervening space being filled up with pounded charcoal or other bad conductor of heat. A hole is pierced through the bottom of the crucible for the admission of a rod of iron, platinum, or dense carbon, such as is used in electric illumination. The cover of the crucible is also pierced for the reception of the negative electrode, by preference a cylinder of compressed carbon of comparatively large dimensions. At the end of a beam supported at its centre is suspended the negative electrode by means of a strip of copper, or other good conductor of electricity, the other end of the beam being attached to a hollow cylinder of iron free to move vertically within a solenoid coil of wire, presenting a total resistance of about fifty units or ohms. By means of a sliding weight the preponderance of weight of the beam in the direction of the solenoid can be varied so as to balance the magnetic force with which the hollow iron cylinder is drawn into the coil. One end of the solenoid coil is connected with the positive, and the other with the negative pole of the electric arc, and, being a coil of high resistance, its attractive force on the iron cylinder is proportional to the electromotive force between the two electrodes, or, in other words, to the electrical resistance of the arc itself.

An automatic adjustment of the arc thus arises of great importance to the attainment of advantageous results in the process of electric fusion; without it the resistance of the arc would rapidly diminish with increase of temperature of the heated atmosphere within the crucible, and heat would be developed in the dynamo-electric machine to the prejudice of the electric furnace. The sudden sinking or change in electrical resistance of the material undergoing fusion would, on the other hand,

cause sudden increase in the resistance of the arc, with a likelihood of its extinction, if such self-adjusting action did not take place.

Another important element of success in electric fusion consists in constituting the material to be fused the positive pole of the electric arc. It is well known that it is at the positive pole that the heat is principally developed, and fusion of the material constituting the positive pole takes place even before the crucible itself is heated up to the same degree. This principle of action is of course applicable only to the melting of metals and other electrical conductors, such as metallic oxides, which constitute the materials generally operated upon in metallurgical processes. In operating upon non-conductive earth or upon gases it becomes necessary to provide a non-destructible positive pole, such as platinum or iridium, which may, however, undergo fusion and form a little pool at the bottom of the crucible.

In this electrical furnace some time, of course, is occupied to bring the temperature of the crucible itself up to a considerable degree, but it is surprising how rapidly an accumulation of heat takes place. In working with the modified medium-sized dynamo machine, capable of producing thirty-six webers of current with an expenditure of four horse-power, and which, if used for illuminating purposes, produces a light equal to 6,000 candles, I find that a crucible of about twenty centimetres in depth, immersed in a non-conductive material, is raised up to a white heat in less than  $\frac{1}{2}$  an hour, and the fusion of one kilogram of steel is effected within, say, another  $\frac{1}{2}$ -hour, successive fusions being effected in somewhat diminishing intervals of time. It is quite feasible to carry on this process upon a still larger scale by increasing the power of the dynamo-electric machine and the size of the crucibles.

It was shown by means of a calculation that this furnace utilises  $\frac{1}{3}$  of the horse-power actually expended, and as the efficiency of a good steam-engine is  $\frac{1}{3}$ , that of the electric furnace is  $\frac{1}{3} \times \frac{1}{3} = \frac{1}{9}$ . Now as it takes theoretically 450 heat units to melt 1 lb. of steel, there will be required actually  $450 \times 15 = 6,750$  units in working with the electric furnace, or about the heat-energy residing in a pound of ordinary coal. To melt a ton of steel in crucibles in the ordinary air-furnace as practised at Sheffield,  $2\frac{1}{2}$  to 3 tons of best Durham coke are consumed. A ton of coal is consumed per ton of steel produced if the regenerative gas furnace is used for heating the crucibles, whilst to produce steel in large quantities on the open hearth of this furnace about 12 cwt. of coal per ton of steel suffice. The electric furnace may therefore be considered as economically superior to the ordinary air-furnace, and, barring some incidental losses not included in the calculation, is nearly equal to the regenerative gas-furnace as far as economy of fuel is concerned. In favour of the electric furnace is an almost unlimited temperature, easy application, a neutral atmosphere within the crucible, and the circumstance that the heat within the crucible is greater than that external to it, whereas in ordinary fusion the temperature of the crucible is higher than that of metal within.

On the occasion of reading the paper a pound of broken files was melted in a cold crucible by means of a current of 72 webers in fifteen minutes, and cast in a liquid state, a second casting being effected in eight minutes. These and other brilliant successes of the new apparatus were hailed with ringing cheers.

In the second portion of the paper, referring to electro-horticulture, the author explained the experiments by means of which he has come to the conclusion that electric light produces the colouring matter chlorophyll in the leaves of plants, that it aids their growth, counteracts the effects of night frosts, and promotes the setting and ripening of fruit in the open air. It appears, further, that, at all events for certain short periods, plants do not require a period of rest during the twenty-four hours, but make increased and vigorous progress if subjected during daytime to sunlight and to electric light at night. These observations on combined sun and electric light agree with those made by Dr. Schubeler of Christiania, who found as the result of continued experiment in the north of Europe, during an Arctic summer, that plants, when thus continuously growing, develop more brilliant flowers and larger and more aromatic fruit than when under the alternating influence of light and darkness. As Dr. Siemens has found that under the influence of electric light plants can sustain increased stove heat without collapsing, he is of opinion that forcing may be effected in an electric stove or enclosure containing an electric light, and that horticulturists may thus grow fruit of excellent aroma and flowers of great brilliancy without immediate solar aid. To test what

can be done practically the author has put down a steam-engine and boiler at his country residence near Tunbridge Wells, and intends to test the principles involved upon a working scale during the winter. The steam-engine which drives the dynamo-electric machine during the night for the purpose of giving light is to be employed during the day in transmitting power through an electric conductor to the farm for the purpose of carrying on small farming operations such as turnip, chaff, and wood-cutting, &c. Another interesting question which Dr. Siemens has set himself to answer is to determine which portion of the rays constituting white light is efficacious in producing chlorophyll, starch, and woody fibre, and which in effecting the ripening of fruit. For this purpose arrangements are in preparation to distribute the spectrum of a powerful electric light in a darkened chamber over a series of similar plants exposed *seriatim* to the actinic, light-giving, and thermal portions of the spectrum. Some experiments have been made with solar light in this direction, but no very conclusive results could be obtained, because the short periods of time during which the solar spectrum can be maintained steadily in the same place are so short that the effects produced upon vegetation have not been of a sufficiently decided character; whereas, with the aid of electric light, the same spectrum may be kept on steadily for a series of days without intermission. The author referred shortly to the lamp which he designed for this purpose, having a focus unchangeable in space, and without obstruction to the rays of light falling downward. There is no clockwork; the carbons are pressed forward either by their own weight or by the force of springs, the motion being checked by an abutment against which the carbon presses at the junction of its cylindrical with its conical portion. This is at a distance of  $\frac{1}{4}$  inch to  $\frac{1}{2}$  inch from the arc centre, when the heat is sufficient to cause the gradual decomposition of the carbon, without being high enough to fuse or injure the metal abutment.

In the third portion of the paper the author refers to the application of electricity as a means of mechanical propulsion. He described the electric railway designed by Dr. Werner Siemens, of Berlin, and tried at a local exhibition held in that city. The rails were insulated from the earth by wooden sleepers, and were in electrical connection with a dynamo-electric machine worked by steam power at the station. A magneto-electric machine on the driving carriage was so fixed and connected with the axle of one pair of wheels as to give motion to the same, the driving axle being severed electrically by the introduction of an insulated washer. A current of electricity is thus passed along one rail to work the magneto-electric machine on the driving carriage, and back by the other rail to the stationary machine on the ground. The author anticipates a large application of the electric railway to adits in mines, to locomotives between neighbouring places, and to tunnels. In fact it is seriously contemplated to apply this system at the St. Gothard tunnel, where the large turbines are available which have been employed in the boring operations.

### UNIVERSITY AND EDUCATIONAL INTELLIGENCE

CAMBRIDGE.—In their latest-issued series of statutes for the University of Cambridge, the Commissioners maintain Easter as the boundary between the University Lent and Easter terms, and require three-fourths of each term to be kept by residence. The degree of Bachelor in Surgery is added to the list; but the permission to give degrees to peers and sons of peers who come to the University in youth is limited to the B.A. degree, and the University may prescribe for their examinations and residence by grace. Titular degrees in any of the seven faculties of Arts, Law, Medicine, Surgery, Science, Letters, or Music may be granted to foreigners of distinction and to British subjects who are of conspicuous merit, or who have done good service to the State or to the University. Complete honorary degrees, with right of voting, may be given to those who obtain some University office after residing three terms in the University.

The Demonstrator of Anatomy will superintend a class for Practical Histology during the next long vacation, beginning July 1; another class will be held for Human Osteology. The Cavendish Laboratory also will be open for practical work.

Notice has been given by the Board of Natural Science Studies that next June (1881) there will be a practical examination in all the subjects of the examination in the first part of the Natural Sciences Tripos.

The recent memorials concerning the academical encouragement of the higher education of women are to be considered and reported on by a syndicate consisting of the Vice-Chancellor, Drs. Bateson, Phear, Westcott, and E. C. Clark, Professors Cayley, Adams, Living, and Stuart, Messrs. G. F. Browne, Ferraers, E. W. Blore, R. Burn, H. Sidgwick, J. Pelle, A. Austen-Leigh, and G. W. Prothero, to report before the end of Lent Term next.

The Sedgwick prize, given every third year for the best essay on some subject in geology or the kindred sciences, open to the competition of all graduates of the University who have resided sixty days during the twelvemonth preceding the day on which the essay must be sent in, has been awarded to Walter Keeping, Inceptor in Arts, of Christ's College. The subject of the essay is, "On the Fossils and Palæontological Affinities of the Neocomian Beds of Upware, Wicken, and Brickhill."

SIR JOHN LUBBOCK has been elected without opposition to represent London University in Parliament.

PROF. HENRICI, F.R.S., has been appointed to the Professorship of Applied Mathematics in University College, London.

GREAT importance has been given to the first session of the Superior Council of Instruction of France, composed of about fifty members, of whom forty have been nominated by the different classes of French teachers, from the Sorbonne to the humblest village school. A decree has granted to each of them a sum of 20 francs a day for the duration of the session, and travelling expenses. M. Jules Ferry opened the session by a speech in which he explained his views, and submitted to the new organisation a programme of reforms. This programme has been sent by the General Assembly to a special commission composed of fifty members appointed to report on it. M. Jules Simon has been appointed president of that commission. It is said that, although approving the general tendency of these reforms, the commission is resolved to protect Greek studies, which had been sacrificed in the Ministerial project. But it agrees to render the study of either the English or the German language an obligation from the admission to the school up to the end of the course of studies. The commission has held already three long sittings for determining these points. The discussion will be long in general sitting. For the first time in the history of France the University has her own parliament to deliberate on all the subjects relating to public instruction. None of these deliberations are to be binding on the Government. All the provisions of the laws are to be voted as formerly by the French Chamber of Deputies and Senate.

### SCIENTIFIC SERIALS

THE *Bulletin of the Torrey Botanical Club* is now published in regular monthly parts, instead of at irregular intervals. The papers are of course chiefly of local interest, and that is especially the case with the three numbers which we have received for the current year, though now and then morphological notes by Mr. Meehan and others are of a wider scope. At all events the *Bulletin* gives us in this country a lively idea of the activity of botanical research on the other side of the Atlantic. Mr. W. R. Gerard gives a description and drawing of a fungus new to science, *Sinidium rubescens*, belonging to the Phalloidei.

UNDER the new editorship of Mr. James Britten the *Journal of Botany* loses none of its interest. In addition to contributions to phyto-geography, and smaller articles of special interest to the workers in the critical botany of British plants, the following, which have appeared in recent numbers, may be mentioned as being of a wider scope:—Mr. J. G. Baker's Synopsis of the species of *Isolles*, a useful contribution to our knowledge of vascular cryptogams; a much-needed review of the British Characeæ (not yet completed), by H. and J. Groves; and the botany of the British Polar Expedition of 1875-6, by Mr. H. C. Hart, the naturalist to the expedition.

THE *Nuovo Giornale Botanico Italiano* continues to be supplied with good and useful papers in the various departments of botany. In the two numbers already published during the present year (vol. xii. Nos. 1 and 2) there are articles by several of the leading Italian botanists. The editor, Prof. Casati, gives a list of fifty false genera or species of plants founded on teratological or pathological circumstances. In an article on the parasitism of fungi by A. Bertoloni, he divides the class of fungi into two great divisions, according to their mode of life. The

first are true parasites, the mycelium of which, living on the tissues of the host, frequently kills it; the second are false parasites (saprophytes), deriving their nourishment from vegetable substances in various stages of decomposition. The genus *Polyporus* he considers to belong to the first, *Agaricus* to the second of these classes. The common disease of the mulberry-tree he attributes to *Polyporus mori*, not to *Agaricus melleus*, as suggested by Piccone.—A. Mori discusses the old statement of Gasparrini, recently revived by Licopoli, that beneath the stomata of the leaves are cavities, to which Gasparrini gave the name *cistoma*, which are clothed by a continuation of the cuticle. His observations do not lead him to confirm this statement, but rather to the conclusion that the walls of the cavity beneath the stoma consist of ordinary cellulose.

IN the number of the *Scottish Naturalist* for April is the commencement of a suggestive article by the Rev. A. Milroy on the value of the names of places in indicating the ancient surface-features of the country. He takes as an example the country on the banks of the Tay below Perth, and shows the light that is thrown by the Saxon and Celtic local names, not only on the ethnological history of the district, but also on the changes which have taken place in its physical features.

*The American Naturalist*, May, contains:—Edward Burgess, the structure and action of a butterfly's trunk.—J. S. Lippincott, the critics of evolution.—E. H. Yarnall, Hall's second Arctic expedition.—O. T. Mason, sketch of North American anthropology in 1879.—The editor's table, on the Academy of Natural Sciences, Philadelphia.—On the proposed exploration of the ruins of Mexico and Central America.—Recent literature.—General notes.—Scientific news.

*Journal of the Franklin Institute*, May.—Naval architecture, by Mr. Haswell.—Table and diagram for determining the diameters of speed cones when connected by an open belt of constant length, by Mr. Klein.—Experiments with a steam cutter, by Mr. Isherwood.—Eye memory, by Mr. Leland.

**SOCIETIES AND ACADEMIES**  
**LONDON**

**Royal Society, May 13.**—"Notice of Further Experimental Researches on the Time Relations of the Excitatory Process in the Ventricle of the Heart of the Frog," by J. Burdon Sanderson, M.D., and F. J. M. Page, B.Sc.

The present paper is a continuation of one previously published by the authors (*Roy. Soc. Proc.*, xxvii, 410). The excitatory state, *i.e.*, the condition produced in any excitable structure, vegetable or animal, by excitation, is characterised (1) by the appearance of electromotive properties in the excited part which did not exist before excitation and cease to exist as soon as its effect is over; (2) by diminished excitability; (3) by the fact that it is propagated from the part first excited to contiguous parts at a rate which is different in different structures and in the same structure at different temperatures. These three conditions are important as being the only characteristics by which the hidden process of excitation constantly reveals itself. By means of the rheotome described by one of the authors, exact measurements have been made of the time relations of the above conditions. The results obtained by Engelmann (*Pflüg. Arch.*, xvii, 68) are then discussed. In forty-seven out of seventy-eight preparations of the ventricle of the frog made by this observer, the leading-off contact nearest the point of excitation became first negative, then positive to the other leading-off contact; in the remaining thirty-one the positive deflection was absent. In the case in which the deflection was of a double character (*Doppelschwankung*), the first phase began 0''06 after excitation, and rapidly attained its maximum; the reversal of sign took place at 0''26, and the contacts became equipotential at 0''5. He estimated the rate of propagation at 50 mm. per second. It will be noticed that these researches of Engelmann refer exclusively to the first half second after excitation, and therefore correspond to what has been termed by the authors of the present paper "the initial phase," and that the "terminal phase" escaped the notice of Engelmann. The method employed in the investigation of the above phenomena, with the aid of the rheotome, is then briefly described. The heart was carefully maintained at a constant temperature by being placed on a lacquered brass box, through which flowed a stream of water at the desired temperature. The following table gives

Time after excitation, at which galvanometric circuit was opened, the period of closure being 0''1 ...	0''1	0''2	0''3	0''4	0''5	0''6	0''7	0''8	0''9	1''0
	-48	-3	0	0	0	0	0	0	0	0
Time after excitation, at which galvanometric circuit was opened, the period of closure being 0''1 ...	1''1	1''2	1''3	1''4	1''5	1''6	1''7	1''8	1''9	2''0
	0	0	0	0	0	+3	+30	+12	+1	0

the results obtained in a typical experiment at 10° C., with the ventricle of the frog. The preparation was led off at apex and base, and excited close to the apex. The deflections represent the relative changes of potential at the apex contact. The authors reiterate the statement contained in their previous paper, that the electrical effect of excitation manifests itself in two phases, an initial and a terminal one, which have opposite signs, and further conclude that these two phases are separated by a relatively prolonged state of equipotentiality of the two apex contacts. These statements agree with those of Engelmann as far as they relate to the same period; but as the whole of the phenomena recorded by him belong to the beginning of the first second, the commencement of the period of equipotentiality is regarded by him as the end of the excitatory effect; but to the authors the absence of galvanometric effect during this isoelectrical interval is the expression of the fact that both contacts are in the same degree of excitation. The proof that this period of equipotentiality is one of balanced activities is obtained by subjecting the two led-off surfaces to different temperatures. If the apex be warmed the deflections of the terminal phase are increased, and commence at an earlier period; if the apex be cooled they are diminished. This is illustrated by the following table:—

Time after excitation, at which the galvanometer circuit was closed ...			
Preliminary observation before warming ...			+ 5
Immediately after warming	-24	+17	
18 seconds later...			
24 seconds later... ..			50 + 9
36 seconds later... ..			+ 7 + 34 + 14
48 seconds later... ..			+ 5 + 24 + 16

Slight injuries, such as those produced by an application of a minute quantity of 10 per cent. salt-solution, resemble those effected by slight warming. If the injury is more complete, such as is produced by touching the surface momentarily by a red hot wire, the isoelectrical interval is as it were filled up; large deflections in which the warmed surface appears to be positive being obtained throughout the whole of the excitatory period excepting the first tenth. This is seen in the following table:—

Time after excitation of opening of galvanometer period of closure being 0''18.	0''6	0''8
	Deflection	82'3

As regards the period of diminished excitability, the experiments of Marey (*Physiol. Exp.* ii, 1876, 85) are first discussed, some experiments are then given which establish—(1) That the duration of the period of diminished excitability agrees pretty closely with that of electrical activity, and (2) that it is similarly affected by changes of temperature.

The rate of propagation of the excitatory wave in a fresh preparation is about 130 mm. per second.

The facts above stated are consistent with the following theories:—1. Every excited part is negative to every unexcited part so long as the state of excitation lasts. 2. The local duration of the excitatory state, *i.e.* the time it lasts in each structural element, is measured by the time interval between the beginning of the initial and the beginning of the terminal phase of the variation. 3. When both contacts are at the same temperature and in all other respects under the same conditions, the local duration of the excitatory state is the same at both, consequently it begins and ends earlier at the leading-off contact first excited than at the other, the initial and terminal differences expressing

themselves in the initial and terminal phases of the normal variation. 4. When one contact is warmer than the other the local duration of the excitatory state is less in the warmed than in the unwarmed surface. 5. If the surface near one contact is slightly injured, the local duration at the injured surface is diminished in the same way as when the temperature is increased, but if the injury is of such intensity as to destroy its surface, its most prominent effect is to diminish its electromotive activity.

In an appendix the authors briefly consider the results of slight inequalities produced by mechanical, chemical, or thermal conditions on the potential of the surface of the ventricle in the resting heart, and the influence of temperature on the excitability of the resting heart.

A full account of the experiments, the results of which were communicated to the Society, will be published in the *Journal of Physiology*.

May 27.—“On some Thermal Effects of Electric Currents,” by William Henry Preece, General Post Office. Communicated by Prof. Stokes, Sec. R.S.

I have been engaged for some time past in experimenting on the thermal effects of electric currents, but the final results of those experiments are not sufficiently ripe at present to justify my bringing them before the Royal Society. I have, however, obtained one result which I believe to be sufficiently novel to justify a short preliminary note.

The most striking facts elicited by these experiments are :

1. The extreme rapidity with which thin wires acquire and lose their increased temperature.

2. The excessive sensibility to linear expansion which fine wires of high resistance evince.

Now as the rate of heating, and therefore of expansion and contraction, varies very nearly directly as the increment or decrement of the currents when these variations are very small, it occurred to me that if a long wire of small diameter and high resistance were attached to a sounding board or to the centre of a disk (such as one of those used for telephones and phonographs) and it formed part of a circuit conveying telephonic currents, sonorous vibrations ought to be reproduced.

The sketch shows the arrangement of the apparatus used for the experiment.

A was a stout base of mahogany, on which a brass support C was attached so that it could slide and be fixed at any distance from D.

D was at first a disk of thin paper, and then of thin iron.

P was the wire experimented upon whose loose ends were connected to terminals on the wooden base, so as to be inserted in the circuit containing a microphone transmitter M and a battery B of six bichromate of potash cells in another room out of hearing.

A platinum wire of 0.003 inch diameter and 6 inches long from *p* to *p'* was first used, and the sonorous effects were most marked and encouraging when the microphone transmitter M

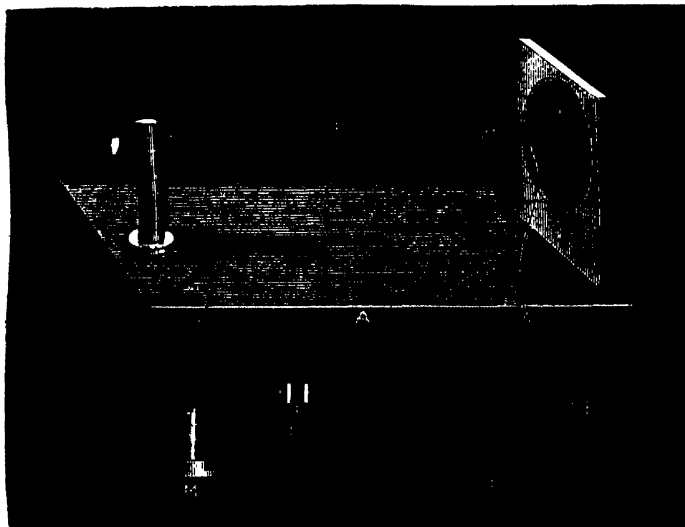

was spoken into. The articulation, though muffled, was clear, and words could easily be heard.

1. Experiments were first made to determine the length which gave the loudest sound and the clearest articulation, and, after repeated trials with every variation of length from 1 inch to 6 feet, it was found that a wire 6 inches long gave the maximum effect.

2. Experiments were then made to determine the diameter of the wire that gave the best effect, and after repeated trials with every gauge drawn from 0.0005 inch to 0.005 inch, it was found that wire of the diameter 0.001 inch gave the best effect.

3. Experiments were then tried with wires 6 inches in length and 0.001 inch diameter of different materials, viz., gold, iron, aluminium, silver, copper, palladium, and platinum, and they came out in the following order of merit :—

Platinum	...	...	...	Very clear.
Aluminium	...	...	...	Very variable.
Palladium	...	...	...	Clear.
Iron	...	...	...	Clear.
Copper	...	...	...	Faint.
Silver	...	...	...	Faint.
Gold	...	...	...	Very poor.

4. The effect of mechanical strain was tried. It was found not to vary the effect. When once the requisite tension, which varied with each metal, was obtained, further tightening up did not vary the clearness or loudness of articulation.

Gold would scarcely bear the tension required to reproduce sonorous vibrations, hence its low position.

5. Very thin carbon pencil, 0.025 inch diameter, was tried under compression and under tension, but no effect whatever was experienced unless a bad joint was made, when at once a faint microphonic effect was apparent.

6. No sibilant sounds whatever could be reproduced.

7. That the effect was due to heating and cooling was shown by the fact that it was possible to increase the current to such a strength as to render the temperature of the wire sensible to the touch, and then to make its elongation and contraction by low sounds evident to the eye.

It therefore appears from these experiments that wires conveying those currents of electricity which are required for telephonic purposes expand and contract as they are heated and cooled, and as the variations in the strength of the current are small compared with the strength of the current itself, the expansion and contraction vary in the same ratio as the condensation and rarefaction of the air particles conveying the sonorous vibrations which produced these vibrations.

The mechanical changes, or molecular vibrations in the wire, due directly or indirectly to telephonic currents, which result in the reproduction of sound, bear a close analogy to the mechanical changes due to the direct transmission of sound, but with this important difference, that while the vibrations due to sound are progressive along the wire, and their velocity is low and easily

measured, those due to thermal effects are practically instantaneous, and therefore affect simultaneously the whole length of the wire.

NOTE.—De la Rive, in 1843 (*vide* "Electricity," vol. i. p. 304), observed that an iron wire emitted sounds when rapid discontinuous currents were passed through it; but he attributed the effect to magnetism, for he failed to obtain the same effect in non-magnetic wires like platinum or silver.

Graham Bell found, in 1874, that a simple helix without an iron core emitted sounds, and (in 1876) that very distinct sounds proceed from straight pieces of iron, steel, retort carbon, and plumbago, when conveying currents.

Prof. Hughes showed that his microphone was reversible, that is, that it could receive as well as transmit sonorous vibrations.

Mr. Weisendanger (*Telegraphic Journal*, October 1, 1878) reproduced sounds on a microphonic receiver which he called a thermophone, and attributed the effect to its true cause, viz., the expansion of bodies under the influence of heat, which, in fact, is the explanation of all microphone receivers.

Ader reproduced speech by the vibrations of a wire conveying currents of electricity, but he found that only magnetic metals were effective, and therefore, like De la Rive, he attributed the result to magnetic agencies (*vide* Count du Moncel, *Telegraphic Journal*, March 1, 1879).

These and many other sonorous effects of currents on wires may be really due to such heat-effects as I have described.

Chemical Society, May 20.—Prof. H. E. Roscoe, president, in the chair.—The first paper was entitled, "On the Action of Air upon Peaty Water," by Miss Lucy Halcrow and Dr. Frankland. In consequence of the statements of Dr. Tidy in his paper on river-water, as to the rapid oxidation of peaty matter in running water, the authors have studied upon an experimental scale the action of exceptionally strong peaty water upon atmospheric air. The peaty water was exposed to air and light with and without agitation; the organic matter in the water and the oxygen in the inclosed air were determined before and after each experiment. It was found that minute quantities of oxygen were absorbed by the peaty water, but even when some water was shaken for ten and a half hours in a bottle fixed on the connecting-rod of a steam-engine making 100 strokes per minute, only 2½ per cent. of the organic matter was oxidised, assuming that all the oxygen taken up was employed in the oxidation of organic matter. The authors therefore conclude that if peaty matter is oxidised the process takes place with extreme slowness.—Dr. Frankland then read a paper on the spontaneous oxidation of organic matter. This was practically a criticism of the conclusions drawn by Prof. Tidy in his paper alluded to above. The author first referred to the belief so prevalent twelve years ago that water polluted with sewage quickly regains its original purity by spontaneous oxidation, and explained how this belief was upset by the quantitative evidence obtained by the Second Rivers Pollution Commissioners in 1868. He then criticised the results of Prof. Tidy, and pointed out some grave inconsistencies therein. Thus the Shannon, after flowing twenty-three miles through Loch Derg, has its organic elements diminished about 18 per cent., whilst the next flow of a mile effects a diminution of 38 per cent. A sample taken four miles lower down showed an increase of 75 per cent., &c. These inconsistencies could only be explained by want of care in taking and securing an average sample of the river at the different points. The artificial purification of mixtures of sewage and water effected by Prof. Tidy by running water through a series of shallow troughs was then considered, and the chief cause of the diminution of organic carbon and nitrogen attributed to the decomposition of the urea into ammonium carbonate. The author concludes that there is no evidence whatever of the destruction by oxidation of the dead organic matter of sewage by a flow of a dozen miles or so in a river, still less is there any ground for assuming that the organised or living matter of sewage is destroyed under like circumstances. The paper concludes with some statistics as to the effect of the water-supply on the spread of epidemics of cholera, &c. Prof. Huxley pointed out that all diseases which are caused by so-called germs are caused by bodies of the nature of bacteria, and that these organisms were plants, and were therefore extremely unlikely to be oxidised or destroyed by endosmose, as suggested by Prof. Tidy, and that it was quite conceivable that a water containing such bodies might be perfectly pure from a chemical point of view, and yet be as deadly as prussic acid. Prof. Tidy, in reply, pointed to the statistics of the last ten years, which proved

that many towns which derived their water-supply from river-water which had been polluted with sewage were as free from fever, &c., as other towns supplied by deep-well water.

Physical Society, May 22.—The annual holiday meeting of this Society was held at Cambridge. On arrival there the party partook of luncheon in a hall of St. John's College, which had been kindly arranged for the purpose by the College authorities. Prof. W. G. Adams occupied the chair, and Mr. Warren De la Rue proposed a vote of thanks to the Master and Senior Fellows of the College for providing the hall. The vote was heartily accorded by the members, and after some remarks from Prof. Adams the party proceeded to the Cavendish Laboratory, where Lord Rayleigh, as vice-president of the Society, presided. The routine business of the meeting being waived, Lord Rayleigh described a plan for limiting the slit of a telescope so as to alter the angular interval with which it can deal. The interval is measured by means of a grating formed by winding a fine wire round two parallel screws of very fine thread.—Mr. Shaw exhibited a modification of Veinholdt's apparatus for distilling mercury, by which a kilogram of mercury can be distilled per hour.—Mr. Sydney Taylor exhibited a device for showing the motion of the particles of water in the transmission of a surface-wave. Sixteen disks were arranged in single file, each having a white spot on its face, and on turning a handle the disks rotated so that the spots, which represented particles of water, moved so as to present a wave-motion to the eye. Mr. Taylor also showed a manometric flame apparatus for exhibiting to the eye the difference of phase between two musical notes. This consisted in two bent tubes, into which the notes were sounded, and capable of being lengthened or shortened by hand like the pipes of a trombone. Opposite the ends of each of these tubes a sensitive flame was placed, and a rotating mirror showed the disturbance produced in the flames by the two different notes. A third flame exhibited the joint effect of the two notes. When the tubes were silent, the images of the flames on the revolving mirror were seen as plane bands; but when notes were sounded into the tubes they became serrated, and the serrations were like or unlike according as the phases of the notes were like or unlike.—Mr. Poynting exhibited a plan for altering the plane of polarisation of the two halves of a pencil of rays from the polariser, so that half the field may be made to appear dark when the other is bright, or both of equal brightness, at will.—Mr. Glazebrook described a method of measuring the rotation of the plane of polarisation of light by means of two spectra giving dark lines made to coincide.—Lord Rayleigh described a plan for demonstrating that yellow colour can be formed by combining red and blue together. He mixes a red solution of chromate of potash with a blue solution of litmus, and on pouring it into a glass cell of a certain thickness, the light transmitted through it is seen to be yellow. Plates of glass coated with gelatin impregnated with litmus and gelatin impregnated with chromate of potash and placed side by side also transmit yellow light. Lord Rayleigh finds, however, that the eyes of different persons vary considerably in their power of appreciating the tinge of the transmitted yellow, one deeming it greenish, another reddish, while a third considers it pure yellow. This peculiarity is not to be confounded with "colour-blindness," since all three persons would distinguish the red and green components accurately. Lord Rayleigh also exhibited a colour-box based on the Newtonian principle, first carried out by the late Prof. Clerk Maxwell, but of a small size.—Sir W. Thomson then proposed a vote of thanks to Lord Rayleigh, which was seconded by Prof. W. G. Adams, and the meeting then dispersed to examine the apparatus and appointments of the Cavendish Laboratory.

Meteorological Society, May 19.—Mr. G. J. Symons, F.R.S., president, in the chair.—Messrs. T. H. Edmonds, F. Ekless, A. H. Taylor, and T. Turner were elected Fellows of the Society.—The following papers were read:—Variations in the barometric weight of the lower atmospheric strata in India, by Prof. E. Douglas Archibald, M.A., F.M.S.—A sketch of the winds and weather experienced in the North Atlantic between lat. 30° and 50° during February and March, 1880, by Charles Harding, F.M.S. The period embraced in this paper includes the time during which H.M.S. *Atalanta* was on her homeward passage, as she left Bermuda on January 31. From the data collected it is shown that a gale blew in the Atlantic every day throughout the two months, excepting on February 21 and 24 to 27. With especial reference to H.M.S. *Atalanta* it appears probable that she would not have met with any exceptionally

severe weather earlier than about February 12 or 13, and allowing that she had averaged from five to six knots per hour on her homeward course, she would at that date have inevitably encountered a severe hurricane. A heavy gale is noted on the 12th in 38° N. and 45° W., which is in the direct homeward-bound track from Bermuda, and if the *Atalanta* had only averaged four knots per hour on her homeward course she would have fallen in with this gale. The storm of the 12th and 13th may fairly be considered as about the most severe during the two months here dealt with. It may be remarked that the Norwegian barque *Caspaei* was north of Bermuda on the 3rd, and was in the full force of the gale on the 12th; her distance made shows that the winds were favourable for a homeward passage from Bermuda. The correspondence from H.M.S. *Salamis*, published in the *Times* of May 6, states, on the authority of the captain of the *Caspaei*, "on February 12, in lat. 42° 43' N., long. 39° 25' W., while running before the wind, encountered the severest gale he had ever experienced. The ship would not steer, and could not be prevented from broaching to. She was thrown on her beam ends, and remained so for nineteen hours, the cargo of cotton keeping her afloat. Several ships were in sight at the time of the commencement of the gale, and were unable to lay to on account of its suddenness."—On the meteorology of Mozufferpore, Tirhoot, for the year 1879, by Charles N. Pearson, F.M.S.—Mr. D. Winstanley also exhibited his solar radiometer.

**Mineralogical Society of Great Britain and Ireland, June 1.—General Meeting.**—Prof. T. G. Bonney, F.R.S., vice-president, in the chair.—Messrs. G. Neist Walker, F.G.S., Alex. Murray, F.G.S., director of the Geological Survey of Newfoundland, Geo. S. Mackenzie, Ph.D., and Hjalmar Furuhielm, Government Inspector of Mines, Helsingfors, were elected as Ordinary Members, and Mr. Robert M. Heddle was elected as an Associate.—The following papers were read and discussed:—On a new face on crystals of stilbite from Scotland and Western Australia, by Prof. M. F. Heddle, F.R.S.E.—On a portable chemical apparatus for quantitative work, by A. E. Arnold.—On kaolinite and kaolin, by J. I. Collins.—On new Scottish minerals, by Prof. Heddle.—Further notes on mineral growth, by T. A. Readwin.—Interesting specimens of minerals were exhibited by Messrs. F. W. Rudler, T. A. Readwin, J. R. Gregory, and Wm. Summers.—The next meeting of the Society will be held at Swansen in August, during the "British Association" week.

## PARIS

**Academy of Sciences, May 31.**—M. Edm. Becquerel in the chair.—The following papers were read:—On an automatic electric lamp, by M. Jamin. A development of the "burner" described before. Three pairs of carbons are set pendant within an oblong covered coil; one pair, having its points nearer than the others, gives rise to the arc first, and burns upwards, and when it is consumed the fusion of a brass wire causes the second pair to come into action (similarly with the third). The expenditure in horse-power and the total light increase up to nine lamps, then both diminish. (Numerical results are fully given.) The brightness of the points directed down is five times that the other way.—On the heat of combustion of the principal hydrocarbonised gases, by M. Berthelot. *Inter alia*, the heat in question is never equal to that of the component elements, and M. Berthelot indicates the nature of the differences.—On the cosmogonic ideas of Kant, *apropos* of a reclamation of priority by M. Schlötel, by M. Paye. He finds no similarity between M. Schlötel's citations from Kant and his own special ideas.—M. Bresse was elected Member in Mechanics in place of the late General Morin.—Synthesis of citric acid, by MM. Grimaux and Adam.—Researches on the albuminoid matters of crystallin as regard the non-identity of those that are soluble with the albumen of white of egg and of serum, by M. Béchamp. In the soluble part he finds two quite distinct albuminous matters (*phacosymase* and *crystalbumin*), and distinctly separates the insoluble matters of the crystallin fibres from fibrine. He laid special stress on direct analysis and determination of rotatory power, regarding coagulation as of secondary importance.—On the use of volcanic sands in treatment of vines attacked by phylloxera, by M. Novi.—A list of memoirs sent in prize-competition was given.—The Secretary described M. de Candolle's work on "Phytography, or the Art of Describing Plants."—On the refractions of Bessel, by M. Radau.—On an extension to functions of two variables of Riemann's problem relating to hypergeometric functions, by M. Picard.—On a class of two functions doubly periodic, by M.

Farkas.—Determination of three axes of a solid body on which centrifugal forces exert, through rotation, a maximum effect, by M. Brassinne.—On the equilibrium of elasticity of a rectangular prism, by M. Mathieu.—Telephone with magnetic superexcitation, by M. Ader. This is based on the principle that if a thin layer of iron or steel be placed before the poles of a magnet it is much more powerfully affected if an iron armature be placed behind than if the latter be not present.—Study of the distribution of light in the spectrum, by MM. Macé and Nicati. Two quantities of light are considered equal when, illuminating a given colourless object placed always at the same distance from the same observer, they enable him to perceive the details with the same distinctness.—On astigmatism, by M. Leroy. Heat liberated in the combustion of some isomeric alcohols of the fatty series, and of oenanthol, by M. Longuinine. Isomerism of substances having the same chemical function, but differing in internal structure, does not appreciably affect their heat of combustion and formation.—On freezing mixtures formed of two crystallised salts, by M. Ditté.—Crystallised hydrofluosilicic hydrate, by M. Kiesler.—Proportion of carbonic acid in the air; reply to M. Riset, by M. Marié-Davy.—Preparation of malonic acid, by M. Bourgoin. He has simplified and improved the process.—Preparation of neutral sulphuric ether, by M. Villiers.—Presence in *Soja hispida* (Münch.) of a notable quantity of a substance soluble in alcohol, and easily transformable into glucose, by M. Levallois.—Functions of the swimming bladder of fishes, by M. Marangoni. It rules the migration of fishes. They have to counteract its action with their fins. It produces a double instability, one of level, the other of position.—Researches on the structure of the axis below seminal leaves in cotyledons, by M. Gérard.—Journey from Biskra among the Touaregs, by M. Roche. This gives some geological details.—On the structure and development of the dentary tissue in the animal series, by M. Magitot.—On the mucus of the cloacal region of the rectum, by MM. Herrmann and Desfosses.—On the inoculability of symptomatic carbon, and the characters which differentiate it from splenic blood, by MM. Arloing, Cornevin, and Thomas. The microbe by which the disease is transmitted is quite distinct from the *Bacillus anthracis*.—On M. Rohlf's journey of exploration into the Eastern Sahara, by M. Berlioux.—French explorations in Central Africa, by M. Fontane. One of the two proposed scientific and hospital stations (the eastern one) is to be established at Kirassa, near Kiora, about 250 km. from Bagamoyo; and Capt. Bloyet, who is to superintend it, has left Marseilles with that object. M. Savorgnan de Brazza has been charged to explore the region about the sources of the Ogooué, and fix a point for the western station; Dr. Ballay accompanies him.—M. Jimenes presented a celestial map projected on the horizon of Mexico.

## CONTENTS

PAGE

"OLD NORWAY." By Prof. ARCH. GRIBKIE, F.R.S. . . . .	117
EUCALYPTOGRAPHIA . . . . .	118
OUR BOOK SHELF:—	
Green's "Short Geography of the British Islands" . . . . .	119
LETTERS TO THE EDITOR:—	
The Visibility of Mercury to the Naked Eye.—T. D. SIMONTON . . . . .	119
Specialised and United Palæontological Research.—W. S. DUNCAN . . . . .	120
The Meteorology of South Australia.—C. MANN; C. TODD . . . . .	120
Comparative Curves in Terrestrial Magnetism.—Rev. S. J. PERRY, F.R.S. . . . .	120
Luminous Painting.—FREDK. V. DICKINS . . . . .	121
Brain Dynamics.—Rev. W. CLEMENT LEVY; S. TOLVER PRESTON . . . . .	121
Vortex Atoms.—S. TOLVER PRESTON . . . . .	121
Songs of Birds.—Prof. ALFRED NEWTON, F.R.S.; FRANK J. ALLEN . . . . .	122
Cup-marked Stones.—JAMES LINN . . . . .	122
ENERGY AND FORCE. By the late Prof. CLIFFORD, F.R.S. . . . .	122
ECHIS CARINATA. By Sir J. FAYRER, F.R.S. . . . .	124
CONTRIBUTIONS TO MOLECULAR PHYSICS IN HIGH VACUA, II. By WILLIAM CROOKES, F.R.S. (With Illustrations) . . . . .	125
ON THE LAW OF FATIGUE IN THE WORK DONE BY MEN OR ANIMALS. By Rev. Dr. HAUGHTON, F.R.S. . . . .	128
A LACUSTRINE VOLCANO (With Illustration) . . . . .	129
NOTES . . . . .	129
OUR ASTRONOMICAL COLUMN:—	
Winnepes's Comet . . . . .	131
The Imperial Observatory, Strassburg . . . . .	132
The Companion of Sirius . . . . .	131
METEOROLOGICAL NOTES . . . . .	132
PHYSICAL NOTES . . . . .	133
GEOGRAPHICAL NOTES . . . . .	134
DR. SIMONS' NEWEST ELECTRICAL RESULTS . . . . .	135
UNIVERSITY AND EDUCATIONAL INTELLIGENCE . . . . .	136
SCIENTIFIC SERIALS . . . . .	136
SOCIETIES AND ACADEMIES . . . . .	139

THURSDAY, JUNE 17, 1880

## TWO DARWINIAN ESSAYS

*Studies in the Theory of Descent.* By Dr. Aug. Weismann, Professor in the University of Freiburg. Translated and Edited by Raphael Meldola, F.C.S., Secretary of the Entomological Society of London. Part I. On the Seasonal Dimorphism of Butterflies, with Two Coloured Plates. (London: Sampson Low, Marston, and Co., 1880.)

*Degeneration. A Chapter in Darwinism.* By Prof. E. Ray Lankester, F.R.S. NATURE Series. (Macmillan and Co., 1880.)

THE first of Dr. Weismann's "Studies," of which Mr. Meldola has given us an excellent translation, with the author's latest notes and additions, is devoted to a thorough examination of the well-known but hitherto little understood phenomenon of the seasonal forms of butterflies. For the benefit of those unacquainted with entomology we may state, that many butterflies have two, or even three broods in a year. One brood appears in spring, their larvæ having fed during the preceding autumn and passed the winter in the pupa state, while the others appear later in the year, having passed rapidly through all their transformations and thus never having been exposed to the cold of winter. In most cases the insects produced under these opposite conditions present little or no perceptible difference; but in others there is a constant variation, and sometimes this is so great that the two forms have been described as distinct species. The most remarkable case among European butterflies is that of *Araschnia prorsa*, the winter or spring form of which was formerly considered to be a distinct species and named *Araschnia levana*. The two insects differ considerably in both sexes, in markings, in colour, and even in the form of the wings, so that till they were bred and found to be alternate broods of the same species (about the year 1830) no one doubted their being altogether distinct.

In order to learn something of the origin and nature of this curious phenomenon Dr. Weismann has for many years carried on a variety of experiments, breeding the species in large numbers and subjecting the pupæ to artificial heat or cold for the purpose of hastening or retarding the transformation. The result of these experiments is, that by subjecting the summer brood to severe artificial cold in the pupa state, it may be made to produce perfect insects the great majority of which are of the winter form; but, on the other hand, no change of conditions that have yet been tried have any effect in changing the winter to the summer form. Taking this result in connection with the fact that in high latitudes where there is only one brood a year it is always the winter form, Dr. Weismann was led to the hypothesis that this winter form was the original type of the species, and that the summer form has been produced gradually, since the glacial epoch, by the summer becoming longer and thus admitting of the production of a second or summer brood. This explains why the production of the winter form (*A. levana*) from summer larvæ is easy, it being a reversion

to the ancestral type; while the production of the summer form (*A. prorsa*) from autumnal larvæ is impossible, because that form is the result of gradual development; and processes of development which have taken thousands of years to bring about cannot be artificially reproduced in a single season.

This hypothesis was supported by experiments with another two-brooded species, *Pieris napi*, with similar results, the winter form being produced with certainty by the application of cold to summer pupæ; and Mr. Edwards, in America, has made similar experiments with the various forms of *Papilio ajax*, finding that the summer broods can be changed into the winter form by the application of cold, while the winter broods can never be made to assume the summer form by hastening the process of transformation. In the Arctic regions and in the high Alps there is only one form of *Pieris napi*, which very closely resembles the winter form of the rest of Europe, and this could never be the least changed by rapidly developing the pupæ under the influence of heat.

Another curious case is that of one of the *Lycænidæ* (*Plebeius agestis*) which exhibits three forms, which may be designated as A, B, and C. The first two, A and B, are alternate broods (winter and summer) in Germany, while in Italy the corresponding forms are B and C, so that B is the summer form in Germany and the winter form in Italy. Here we see climatic varieties in process of formation in a very curious way.

That temperature during the pupa stage is a very powerful agent in modifying the characters of butterflies, is well shown by the case of *Polyommatus phlaeas*. The two broods of this insect are alike in Germany, while in Italy the summer brood has the wings dusky instead of copper-coloured. The period of development is exactly the same in both countries, so that the change must, it is argued, be attributed to the higher temperature of the Italian summer. It has been noticed that in Italy a large number of species of butterflies are thus seasonally dimorphic which are not so in Central and Northern Europe.

Dr. Weismann lays great stress on the varied effects of temperature in modifying allied species or the two sexes of the same species, from which he argues that the essential cause of all these changes is to be found in peculiarities of physical constitution, which cause different species, varieties, or sexes to respond differently to the same change of temperature; and he thinks that many sexual differences can be traced to this cause alone without calling in the aid of sexual selection. The general result arrived at by the laborious investigation of these phenomena is, that—"a species is only caused to change through the influence of changing external conditions of life, this change being in a fixed direction which entirely depends on the physical nature of the varying organism, and is different in different species, or even in the two sexes of the same species;" and he adds:—"According to my view, transmutation by purely internal causes is not to be entertained. If we could absolutely suspend the changes of the external conditions of life, existing species would remain stationary. The action of external inciting causes, in the widest sense of the word, is alone able to produce modifications; and even the never-failing 'individual variations,' together with the inherited dissimilarity

of constitution, appear to me to depend upon unlike external influences, the inherited constitution itself being dissimilar because the individuals have been at all times exposed to somewhat varying external influences." The present writer has arrived at almost exactly similar conclusions to these, from a study of the geographical distribution and specific variation of animal forms, as stated in an article on "The Origin of Species and Genera," which appeared in the *Nineteenth Century* of January last, and it is gratifying to find them supported by the results of a very different line of inquiry, and by the authority of so eminent and original an observer as Dr. Weismann.

The second work referred to in our heading, is Prof. Lankester's British Association evening lecture last year at Sheffield, now republished with illustrations as one of the useful little volumes of the "Nature Series." It discusses the little-known phenomena of "Degeneration" as a phase of development much more general, and of far greater importance than is usually supposed. Degeneration causes an organism to become more simple in structure, in adaptation to less varied and less complex conditions of life. "Any new set of conditions occurring to an animal which render its food and safety very easily attained, seem to lead as a rule to degeneration; just as an active healthy man sometimes degenerates when he becomes suddenly possessed of a fortune; or as Rome degenerated when possessed of the riches of the ancient world. The habit of parasitism clearly acts upon animal organisation in this way. Let the parasitic life once be secured, and away go legs, jaws, eyes, and ears; the active and highly-gifted crab, insect, or annelid may become a mere sac, absorbing nourishment and laying eggs."

We see incipient cases of degeneration in the loss of limbs of the serpentiform lizards and the pisciform mammals; the loss of eyes in the inhabitants of caverns and in some earth-burrowers; the loss of wings in the Apterix and of toes in the horse; and, still more curious, the loss of the power of feeding themselves in some slave-holding ants. More pronounced cases are those of the barnacles—degenerated crustacea, and the mites—degenerate spiders; while we reach the climax of the process in Ascidiæ—degenerate vertebrates, and such mere living sacs as the parasitic *Sacculina* and *Lernæocera*, which are degenerated crustaceans. Not only such lesser groups as the above, but whole orders may be the result of degeneration. Such are the headless bivalve mollusca known as Lamellibranchs, which are believed to have degenerated from the head-bearing active cuttle-fish type; while the Polyzoa or Moss-polyps stand in the same relation to the higher Mollusca as do the Ascidiæ to the higher Vertebrates.

While discarding the hypothesis that all savages are the descendants of more civilised races, Prof. Lankester yet admits the application of his principle to explain the condition of some of the most barbarous races—"such as the Fuegians, the Bushmen, and even the Australians. They exhibit evidence of being descended from ancestors more cultivated than themselves." He even applies it to the higher races in intellectual matters, and asks: "Does the reason of the average man of civilised Europe stand out clearly as an evidence of progress when compared with that of the men

of bygone ages? Are all the inventions and figments of human superstition and folly, the self-inflicted torturing of mind, the reiterated substitution of wrong for right, and of falsehood for truth, which disfigure our modern civilisation—are these evidence of progress? In such respects we have at least reason to fear that we may be degenerate. It is possible for us—just as the Ascidian throws away its tail and its eye and sinks into a quiescent state of inferiority—to reject the good gift of reason with which every child is born, and to degenerate into a contented life of material enjoyment accompanied by ignorance and superstition."

This is very suggestive; but we may, I think, draw a yet higher and deeper teaching from the phenomena of degeneration. We seem to learn from it the absolute necessity of labour and effort, of struggle and difficulty, of discomfort and pain, as the condition of all progress, whether physical or mental, and that the lower the organism the more need there is of these ever-present stimuli, not only to effect progress, but to avoid retrogression. And if so, does not this afford us the nearest attainable solution of the great problem of the origin of evil? What we call evil is the essential condition of progress in the lower stages of the development of conscious organisms, and will only cease when the mind has become so thoroughly healthy, so well balanced, and so highly organised, that the happiness derived from mental activity, moral harmony, and the social affections, will itself be a sufficient stimulus to higher progress and to the attainment of a more perfect life.

For numerous instructive details connected with degenerated animals we refer our readers to the work itself—truly a small book on a great subject, and one which discusses matters of the deepest interest, alike to the naturalist and the philosopher.

ALFRED R. WALLACE

#### NATURE'S HYGIENE

*Nature's Hygiene: a Series of Essays on Popular Scientific Subjects, with Special Reference to the Chemistry and Hygiene of the Eucalyptus and the Pine.* By C. T. Kingzett. (London: Baillière, Tindall, and Cox, 1880.)

THE subject of this book is, practically, Peroxide of Hydrogen. Such a title as "Peroxide of Hydrogen, with Special Reference to its Sanitary Applications," might not have proved so taking as "Nature's Hygiene," but it would have been quite as descriptive of the subject-matter of the work. Mr. Kingzett strives to show that the position which has been assigned to ozone as "Nature's purifier and disinfectant," is not altogether merited by that body, but that it should rather be given to peroxide of hydrogen. There can be no doubt that these substances have been frequently confounded, and that in numerous instances reactions which have been attributed to ozone have been caused by hydrogen peroxide. It has been stated, for example, that the aromatic parts of flowers produce ozone, and that this substance is formed in considerable quantity by plants rich in essential oils—indeed the late Dr. Daubeny was of opinion that the oxygen evolved from plants by the decomposition of carbon dioxide in sunshine was always more or less ozonised; and other observers have sought to show that



oil of turpentine and substances allied to the terpenes have the property of transforming oxygen into ozone. There is no doubt whatever that ozone is soluble in oil of turpentine; this is incontestably proved by the experiments of Soret, who, as all chemists know, has made capital use of the fact, but this is quite another thing to saying that oil of turpentine *generates* ozone. This confusion between ozone and hydrogen peroxide has mainly arisen from the difficulty of discriminating between the two substances, and it is only since the researches of Struve, made about ten or eleven years since, that the presence of the latter body in the air may be said to have been demonstrated. Observers were led astray by the supposition that the simultaneous existence of the two substances was impossible; chemically speaking, they were held to be incompatible. Recent observations have shown that the opinions hitherto held on this point must be modified. We are at present very much in the dark as to the causes which lead to the formation of peroxide of hydrogen in nature, but that many plants, and especially those which secrete essential oils, contribute to its production is almost certain. In the book before us Mr. Kingzett has collected a mass of evidence on this matter, and has presented it in an eminently readable and interesting form. Perhaps the most valuable part of the work is that which relates to the power exercised by the various members of the genus *Eucalyptus* in preventing or destroying malaria—which power according to our author is related to their property of forming peroxide of hydrogen.

The *Eucalyptus globulus* was discovered by Labillardière in Tasmania towards the close of the last century, but it is only within the last quarter of a century that its anti-miasmatic properties have become known to Europeans. To whom the credit of the discovery is due is not clearly made out. M. Ramel, Baron Müller, and Sir W. Macarthen appear to have been among the first to draw attention to its extraordinary power, and seeds of the tree were sent by them from time to time to Europe. The testimony in support of this power is most convincing. In marshy districts near *Eucalyptus* forests fever seems to be unknown, and in parts of Corsica and Algeria where the tree has been planted for the sake of its reputed virtues endemic fevers have been stamped out. M. Girbert, in a report to the French Academy, instanced the case of a farm situated in a pestilential district about twenty miles from Algiers, where by planting a number of the trees the character of the atmosphere was entirely changed. Similar testimony comes from Holland, the South of France, Italy, California, and many other parts of the world as to the febrifugal attributes of this tree. In no case is the evidence more convincing than in that of Algeria, as we have it related to us by Dr. Santra, and, quite recently, by Consul Playfair. Large tracts of land have been quite transformed by the agency of the "fever-destroying tree" as it has come to be called, and wherever it is cultivated fevers are found to decrease in frequency and intensity. Fewer districts in Europe have a more evil reputation than the Campagna as a veritable hot-bed of pestilential fever, and people who know the country round Rome may remember the monastery at Tre Fontane on the spot, as tradition tells, that St. Paul met his death. Life in this monastery meant death to the

monks, but since the *Eucalyptus* has been planted in the cloisters fever has disappeared and the place has become habitable.

That the aromas of plants have in all ages been held to act as preventives of disease, especially against those of an infectious or malarial type, is well known, and in every visitation of plague which has afflicted this country we read of people carrying strong-smelling gums or balsams about their persons. The physicians of a bygone time had vinaigrettes in the handles of their canes to protect them from the exhalations of their patients, and the miserable wretches who came out of the fever-haunted prisons and bridewells of a century or two ago to stand their trials were surrounded by some aromatic herb to protect the court from possible contagion. Even the chaplain as he accompanied the doomed man to the gibbet had presented to him a bouquet as a precaution against the dreaded jail-fever.

Whether the peroxide of hydrogen is invariably produced by the process of oxidation of the aromatic parts of plants is not yet proved, but that it frequently is so seems beyond question. There can be no doubt too that this substance is a very powerful antiseptic; the experiments of Mr. Kingzett and others are quite conclusive on this point.

#### OUR BOOK SHELF

*The Science of Voice Production and Voice Preservation, for the Use of Speakers and Singers.* By Gordon Holmes, Physician to the Municipal Throat and Ear Infirmary. (London: Chatto and Windus.)

THE author says that this work is an abridgment of his "Vocal Physiology and Hygiene," of which a notice has already appeared in *NATURE* (vol. xxi. p. 271), and that it is intended "to furnish persons who make an artistic or professional use of the vocal organs with a concise account of those relations of the voice to physical and medical science which are only cursorily alluded to, or passed over altogether, in treatises on elocution and singing."

The account is concise enough, in the sense of not occupying much space, if we omit the chapter headed "Hygiene of the Voice," which is mainly occupied with general hygiene; but we greatly doubt whether those who "make an artistic or professional use of the vocal organs" will derive much advantage from its study, that is, whether they will be able to carry away much that will be of use to them. In striving to be concise the author seems to have become vague. Although, of course, he must be professionally well acquainted with the details of the vocal organs and their laryngoscopic appearance, he has not succeeded in conveying a clear knowledge of so much as it imports the singer and public speaker to know. Nor are his woodcuts of the larynx at all satisfactory; those, for example, of "the larynx when sounding a note about the level of the ordinary speaking voice," and "during the emission of falsetto notes," being calculated to convey false impressions to those who see them for the first time. His knowledge of the physics of sound, and especially of phonetics, appears to be entirely secondhand. There is the same impression conveyed by his treatment of the registers and voice training for singers. The consequence is a want of definiteness and exactness in all these important branches of his subject. Thus, on p. 2, he tells us that sound travels through air at the rate of about 1,090 feet in a second, but neglects to add "at freezing temperature," or that it goes faster when the air is heated, so that, in fact, about 1,120 feet at 60° F. is the more common rate. At

other times his language is rather singular, as when he says that stammering "frequently arises from a muscular defect, giving rise to a *clumsiness in getting the tongue round one or more letters*" (p. 94), or speaks of the vocal bands being "tensed" (p. 105), or says that "musical gifts of voice are rather *phylogenetic* in their origin," the word in italics not appearing even in Mayne, or speaks of "living up hills" (p. 146). In a book written for singers and public speakers Latin and Greek and technical expressions should certainly be explained, if not avoided, such as *phylogenetic*, already adduced, and *frantum lingua* (p. 95). The article on hygiene conveys a good deal of information, but we suspect most readers will rather remember the amusing account of the dietetic habits of singers, quoted from other sources, on p. 114, than be able to dig out what relates to the voice from the great mass of other matter. In conclusion, we cannot help feeling that the words "the science of," in the title, are not justified by the book itself, and might be advantageously replaced by the single word "on."

*Ceylon Coffee Soils and Manures: a Report to the Ceylon Coffee Planters' Association.* By John Hughes. (London: Straker Bros. and Co., 1879.)

THE writer of this report has at least gathered together a large amount of useful information about the coffee plant, coffee soils, and coffee manures. As an agricultural chemist he has, not unnaturally, attributed excessive importance to the composition and condition of the soils in which healthy and diseased coffee trees are found; manures also are indicated as amongst the chief remedial measures. Doubtless, the proper maintenance of the "condition," as it is technically termed, of coffee soils has been woefully neglected. Indeed, where there is neither rotation nor even alternation of crops the difficulty of securing continued vigour of growth and ample crops of fruit must be considerable, even when soils are rich and seasons favourable. But let any adverse influences, whether of excessive rainfall, or of mechanical and chemical injury to the soil occur, and then the plant is more likely to succumb to the attacks of its enemies, vegetable and animal. Thus wheat straw deprived of adequate supplies of soluble silica becomes more subject to injury from insects and mildew. Other examples might be found of a connection between certain deficiencies in the soil and certain diseases in the plant, but it is unsafe to make a hasty generalisation on this point. In combating the coffee-leaf disease we must first of all devote ourselves to the fungus which is its direct cause. There can be little doubt that calcium sulphide, which proved so efficient a means of destroying the *Oidium* of the vine will be equally destructive to the *Hemileia vastatrix*. A mixture of sulphur and quicklime, or a wash made by simply boiling these two materials together, is much less active.

When Mr. Hughes makes suggestions about the sources of manurial substances available for Ceylon, about the making and preservation of cattle and vegetable manure, and about terracing and draining, we can heartily endorse his recommendations. And when he gives us a number of careful analyses, some of which are of considerable interest, even apart from their connection with the growth of coffee, we are grateful for information which is sure to become useful under some circumstances and at some time. But there are certain portions of Mr. Hughes's Report which seem to have been introduced with no special object, or which are of questionable value. We hardly need to be taught that "Planters want a practical remedy rather than an elaborate description of the disease" (p. 140). The appearance of what look like recommendations of the manurial preparations of particular manufacturers should have been avoided (pp. 27 to 30). We could have spared the repetition of the well-worn table of manurial values on p. 100, and the analysis

of Bude sand (p. 36). The term *granitic* as applied (p. 37) to a limestone containing over 70 per cent. of calcium and magnesium carbonates needs a word of explanation. Of really interesting data furnished by Mr. Hughes we may cite the analyses of castor-seed cakes (p. 15), in which the nitrogen is shown to differ widely—brown and black cakes containing but 4½ per cent., while white cakes show no less than 7½. Although we do not believe in the third decimal places (how often can we chemists secure accuracy in the tenths?) in Mr. Hughes's soil analyses (pp. 46, 53, 65, 72, 77, 81, 150)—particularly as his phosphoric acid determinations were not made by the molybdic acid process—yet these results represent a mass of laborious researches, and ought to furnish much material for the management of Ceylon coffee soils. The analyses of healthy and diseased coffee-leaves (pp. 142-144) deserve careful study; they point unmistakably to the fungoid origin of the disease. A. H. C.

### LETTERS TO THE EDITOR

[The Editor does not hold himself responsible for opinions expressed by his correspondents. Neither can he undertake to return, or to correspond with the writers of, rejected manuscripts. No notice is taken of anonymous communications.]

[The Editor urgently requests correspondents to keep their letters as short as possible. The pressure on his space is so great that it is impossible otherwise to ensure the appearance even of communications containing interesting and novel facts.]

#### Cloud Classification

BETWEEN M. Poy and his latest critic (*NATURE*, vol. xxii. p. 96) it would be impertinent for me to interfere. But until my objection to a part of Howard's original classification has met with some response from those who maintain the adequacy of that classification I must continue, at the risk of some repetition, to call attention to this objection. It can be stated briefly, and I do not see why the answer thereto, if such exist, should be deferred as too long for discussion.

E. H. appears to admit that an observer, when within a cloud (which is then to him a fog), cannot distinguish *cumulus* from *stratus*. He, however, elevates the *stratus* or rather one variety of it, "a few feet (or even inches) from the earth," so as to cut "the taller trees in a horizontal line, leaving their tops and bottoms free." He proposes to shelve the question "whether it is desirable to use the term 'stratus' for clouds in a totally different sky region, which differ both in their origin and their nature from the true stratus" (*i.e.* from the *stratus* of the sky-region of half-length elms in the Thames basin). Now it is precisely this question which the large and growing class of observers, who wish to record the modifications of clouds, can no longer permit to be left unsettled. If clouds are to be classified according to their form at all, some name is absolutely required for a class of clouds which is in all latitudes common, and in the higher predominant. These are the clouds to which the observers can neither give the title *cumulus* nor the title *cirrus*, the clouds which are disposed in beds or layers whose vertical thickness is small. When in trifling amount they arrange themselves in irregular disks or patches capable of being occasionally mistaken for *cumulus* when in the zenith, but elsewhere seen as streaks or threads transverse to the meridian. When in large amount they cover a great portion or the whole of the sky with a shallow and nearly level canopy. In England, putting together observations made at all hours of day and night, clouds belonging to this class are recorded in about 6 per cent. of the observations. Of observations made at 2 p.m. they occur in about 38 per cent.; of observations made between sunset and sunrise in upwards of 90 per cent. Of observations made at all hours in the English Midlands from October, 1879, to February, 1880, inclusive, they were recorded in 8 per cent. To leave this class nameless is intolerable. To give to them either of the compound titles *cumulo-stratus* and *strato-cumulus* is objectionable, because in form they do not resemble *cumulus* at all (I might add that to a defender of Howard's unamended system they also do not resemble *stratus* at all, differing, as we are told, not only in elevation, but in "origin and nature," both from ground-fog and middle-tree fog). A similar objection lies against the application to these clouds of

the terms *cirro-stratus* and *strato-cirrus*. Finally the terms *cumulo-stratus* and *cirro-stratus* are sorely needed for varieties of clouds intermediate between the class I have described and the *cumulus* and *cirrus* types, if any part of Howard's terminology is to be left to us at all.

It would be a pity that that terminology, lucid and expressive, should perish, merely because, to a few minds, the originator of a system must needs appear infallible, and his classification perfect as Minerva when issuing from the head of Jupiter. I think that Luke Howard would have been the last to put forward such a claim.

W. CLEMENT LEY

June 8

The Motion of Fluids

PROF. REYNOLDS, in the course of his review (NATURE, vol. xxi. p. 342) of my book on the above subject, cites two instances in which I have been guilty of what he considers loose and vague reasoning. I would ask space for a few remarks on the points in question.

To take the more important matter first, Prof. Reynolds says, *apropos* of a certain proof of the velocity-potential theorem given in Art. 23:—

"Mr. Lamb has offered a proof of this now historic theorem, which, if judged by the space it occupies, should be much simpler than the acknowledged proofs of Cauchy and Stokes. As no authority is cited, it would appear that this proof is here given for the first time. If so, the author has done himself great injustice in not examining or explaining his reasoning more closely. For, as it stands, it suggests the idea that he has ignored the fact that  $dx, dy, dz$ , on the left of his equation, are integrals through a finite time, and hence, inasmuch as he has given no reason to the contrary, may be of a different order of magnitude from their initial values,  $da, db, dc$ , which appear on the right of his equation. If this is not so it is a peculiarity of the motion of continuous fluid, and needs establishing; otherwise we might infer that two people who had once shaken hands could never after be so much as a mile apart."

Prof. Reynolds, who himself strongly recommends the careful study of "work from the master's hand," will hardly take it amiss if I ask him to turn to the proofs which he justly cites as classical, and to notice that they contain, one of them (Cauchy's) in exactly the same form, the other in a form which is mathematically equivalent, the very assumption which he here calls in question. The assumption is in fact nothing more than a tacit limitation, which is made at the very outset of the subject, as to the class of motions which are proposed for study. In the "Eulerian" method it is implied that the first derivatives of the component velocities  $u, v, w$  with respect to the co-ordinates  $x, y, z$  are to be everywhere and always finite throughout the motion considered; in the "Lagrangian" method the corresponding, and equivalent, assumption is that the derivatives  $\frac{dx}{da}, \frac{dx}{db}, \frac{dx}{dc}$ , &c., and also

$\frac{d^2x}{dad}, \frac{d^2x}{abd}, \frac{d^2x}{dcd}$ , &c., are to be finite. We do not assert

that these are universal characteristics of fluid motion, for it is easy to imagine cases in which they are violated; we merely exclude such cases *ab initio* from the scope of our investigations. But, in one form or another, these fundamental limitations are, from the point of view of analytical hydrodynamics, unavoidable; they are made implicitly every time we write down the equations of motion, and it is therefore not surprising that they should be found to be essentially involved, not only in the proof which Prof. Reynolds on this account criticises, but in every other proof of the velocity-potential theorem which has yet been propounded.

I have only to add that the proof in question is, and professes to be, merely a very obvious corollary to H. Weber's transformation of the Lagrangian equations.

The other passage of Prof. Reynolds's review which I wish to notice is as follows:—

"There is a considerable amount of vagueness attending the author's use of the term *particle*. Having rightly defined fluids as being such 'that the properties of the smallest portions into which we can conceive them divided are the same as those of the substance in bulk,' he proceeds to reason about a particle as though it were a discrete quantity, the position of which is defined by some point, thus ignoring the fact that, according to his definition, the same particle of fluid may at one time be a sphere, at another a filament of indefinite length, or a sheet of

indefinite breadth. This vagueness appears to have led him into error in Art. 11."

A good deal of this criticism is, I think, met by the remarks already made. In a fluid moving subject to the conditions I have stated, only finite changes of shape can be produced in a moving element within a finite time.

Prof. Reynolds does not indicate the precise nature of the "error" which he finds in Art. 11. After a careful reconsideration, the argument of that article appears to me to be sound; but I am free to confess that it is not stated with all the clearness desirable, and that the article is further disfigured by an unfortunate clerical error in the foot-note, where " $u = \pm \sqrt{x}$ " should be read for " $u = \pm x$ ."

HORACE LAMB

Adelaide, March 30

On the Physical Aspects of the Vortex-Atom Theory

WILL any charitable person explain a difficulty which I (and other non-mathematical people) have encountered when seeking to understand and be satisfied with this theory?

The only proof of those properties of vortex rings which match the physical properties of atoms that I have met with is that in Besant's "Hydromechanics"; and is based on the initial-co-ordinate method.

Now it seems to me that this method assumes what is equivalent to the permanence of the vortex filament; so that in proving the latter by use of this system of co-ordinates we may be merely arguing in a circle.

For it assumes that if initially we have any infinitesimal tetrahedron  $\delta x, \delta y, \delta z$ , then after the finite time,  $t$ , this will still form a tetrahedron  $\delta x, \delta y, \delta z$ .

Now I cannot see that one can assume this; that—to use the words in a late article of NATURE—"if two people have once shaken hands they can never be 100 miles apart."

And this inseparability of the particles of a fluid thus assumed bears a very close relation to the permanence of the vortex filament which we wish to prove.

W. L.

Cheltenham, May 29

[It appears to us that our correspondent here confuses between the permanence of any fluid filament and the permanence of the vortex character of the filament. The assumption that every filament remains continuous cannot be said to be equivalent to assuming that the direction of the filament at every point remains coincident with the axis of rotation of its constituent elements at that point, which is what Helmholtz has taught us.—ED.]

The Aurora Borealis and its Colours

WITH regard to Drs. De La Rue and Müller's paper on the Aurora (NATURE, vol. xxii. p. 33) there is still a point I should like to see explained. Is it considered by physicists that in electric discharges similarity of colour is sufficient to indicate similarity of constitution, even when their spectra are quite unlike? The paper, together with the reply to Prof. Smyth, certainly seem to imply this; though I have not previously seen it stated to be the case.

With regard to the red part of auroræ, so far as my observations indicate its position, they show it to be above the greenish part in the auroræ seen here; though according to Weyprecht's observations, it is below the green in the Arctic regions.

Sunderland, June 9

T. W. BACKHOUSE

A New Audiphone

FURTHER experiments on the timbre of musical instruments as rendered by the audiphone have led me to the selection of the following as a distinct improvement on the birchwood veneer, both for musical purposes and also for ordinary conversation. It has the same advantage as my previous form in not requiring to be held by the hand, it costs nothing, and requires no making. Take a sheet of stiff brown paper about 11 x 15 inches, the paper being such as is ordinarily used for making up heavy parcels. Put the ends together, the middle forming a loop, and hold the ends between the teeth. The paper must be pretty stiff, as the loop must stand out round and full, and of course the paper must be without folds or creases.

THOS. FLETCHER

Museum Street, Warrington

Crystal-Ice

IN reference to the "crystal ice" proposed by Dr. Calantarients, of Scarborough, for skating upon with ordinary skates,

it may not be generally known that more than thirty years ago a skating pond was constructed in Liverpool, consisting, I believe, entirely of crystallised Glauber's salt. I have a perfect recollection of this miniature lake with its grotto-like surroundings, of its black looking ice with innumerable white scorings marking the tracks of the skaters, yet, strange to say, I cannot remember whether I skated on it myself. The impression that I did seems to be confused with other skating scenes. This perhaps does not look like very reliable evidence, but that the "rink" (under another name) of artificial ice did exist, and was popular, will no doubt be affirmed by many witnesses besides myself. The date would be about 1845, if I am not mistaken, and the speculation ultimately failed owing to a public impression (possibly a wrong one) that the exhalations from the surface of the pond caused sickness and headache.

R. H.

### The Stone in the Swallow

YOUR correspondent, Dr. P. P. C. Hoek, requests information respecting the origin of the fable to which the poet Longfellow refers at the end of the first part of "Evangeline"—"The stone in the nest of the swallow." In Burton's "Anatomy of Melancholy," p. 434, at the top (Wm. Tegg's edition), after describing in the delightfully quaint style of the age the curative virtues of various stones, he quotes the following:—

"In the belly of a swallow there is a stone called 'cheldonium,' which, if it be lapped in a fair cloth and tied to the right arm, will cure lunatics, madmen, make them amiable and merry."

In a foot-note there are references made to the following authors:—Albertus, Eucellius, cap. 44, lib. 3; Plin, lib. 37, cap. 10; Jacobus de Dondis, &c.

It seems probable that Longfellow got his version of the story from some of the descendants of the French Acadians, to whom the poem relates, and it may have come down from the same sources from which Burton derives his account of the matter. It may be noted that the two versions do not in any way clash, Burton's simply referring to the whereabouts of the stone, "in the belly of the swallow," its name and benefits to those afflicted with insanity; while Longfellow's version relates more to the finding and locality of the stone and its uses to the young swallows, leaving its supposed value to man, depending on the general term of being "lucky."

JOHN LOCKE

Trinidad, West Indies, May 24

### Stags' Horns

IN reference to the opinions recently expressed in your journal regarding the disappearance of the horns of stags, deer, &c., I may mention that this is usually attributed here to the action of rodents rather than of the deer themselves. Even if a deer should occasionally be seen gnawing a horn it would be very difficult to account for the disappearance of all the annual crop of antlers in this way. From the nature of their dentition (having no incisor teeth in the upper jaw) the destruction of such a mass of hard material must be very difficult. Moreover slight examination will show whether the tooth marks are those of the large teeth of a deer or of the small incisors of a rodent.

Antioch College, Ohio, U.S.A.

E. W. CLAYPOLE

### ON SOME POINTS CONNECTED WITH TERRESTRIAL MAGNETISM

I HAVE on more than one previous occasion brought forward some of the various points which are here grouped together. These points are three in number.

(a) Regarding the sustaining power of the earth's magnetism.

(β) Regarding the diurnal and other changes of the same.

(γ) Regarding earth currents and auroras.

I may state at once that this only professes to be a working hypothesis.

(a) *Regarding the Sustaining Power of the Earth's Magnetism.*—I do not here intend to discuss the cause of the earth's magnetism, but I would ask in the first place if it is not possible that this cause may be something small and one which (assuming it to continue at the present

moment) we may not readily perceive. If we assume this cause or magnetic nucleus to be small is it not possible to imagine that there is a machinery which acts upon this nucleus (just as we have in certain magneto-electric engines) so as to swell up the magnetism of the earth ultimately to saturation.<sup>1</sup>

May not this machinery be the great convection currents, the anti-trades, that go from the equator to the poles in the upper regions of the earth's atmosphere, and which may be looked on as conductors moving across lines of magnetic force?

It would appear to me that the tendency of such currents will be to swell up and sustain the magnetism of the earth.

(β) *Regarding the Diurnal and other Changes of Terrestrial Magnetism.*—It will of course be natural, entertaining the views now enunciated, to regard the diurnal changes of the convection currents of the earth's atmosphere, as these are manifested in the upper regions, to be the cause of the diurnal changes of terrestrial magnetism.

If this view be taken it might be argued that wind changes in these upper regions should also produce magnetic variations. The reply is that apparently they do. In conjunction with Mr. Morisabro Hiraoka I have compared together the simultaneous records of magnetic declination ranges at Kew and at Trevandrum, and I find evidence of a progress of things from west to east, so that on the whole a particular magnetic-range phenomenon occurs at Kew 97 days before it occurs at Trevandrum. Again, I have attempted to show, in conjunction with Mr. Dodgson, that a particular magnetic phenomenon occurs at Kew one day before it occurs at Prague.

It would thus appear that there is a progress of magnetic phenomena from west to east, just as we know there is a progress of meteorological phenomena. As, however, the meteorological phenomena which we can examine occur in the lower atmospheric regions, while the magnetic phenomena are, according to this hypothesis, associated with currents in the higher regions, it does not follow that magnetic and meteorological phenomena should travel from west to east at the same rate. I may also mention that we have reason to believe that magnetic changes lag behind corresponding solar changes just as meteorological changes would do.

It is manifest that it will be comparatively easy to settle the fact of a progress from west to east of magnetic weather, and that if such exists it will most readily ally itself with the hypothesis above mentioned.

In the next place, if we regard those changes in the convection-currents of the earth which depend on the year we have reason to imagine that such are most pronounced at the equinoxes. It is also well known that magnetic disturbances are most frequent at these times.

Let us next proceed to regard the secular change of the earth's magnetism. To account for this magneticians have felt the need of something movable, and the hypothesis of a "little earth," a solid nucleus moving within the recesses of our planet, has found much support. But is it not more likely that the result may be caused by a secular variation in the distribution of the convection-currents of the earth? If the question be asked, What reason have we for imagining the existence of such a variation, the answer will be, A much better reason than we have for entertaining the conception of a "little earth." For there is some reason, at any rate, for imagining the power of the sun to be subject to a complicated series of periodicities. Now a secular variation in the power of the sun would produce a secular change not only in the intensity, but in the direction of the convection-currents of the earth, and, according to the above hypo-

<sup>1</sup> If I am not mistaken Sir W. Thomson is inclined to regard the earth as a magneto-electric engine.

thesis, these in their turn would produce a secular magnetic change.

(7) *Regarding Earth Currents and Auroras.*—I have for some considerable time looked on the earth as a Ruhmkorff's coil with a magnetic nucleus. Above this nucleus we may suppose that we have the primary rocks, which are non-conductors, while above these we have the moist or comparatively moist surface of the earth, which is a conductor. Above this, again, we have the lower strata of the atmosphere, which are non-conductors, while above this we have the upper strata, which are conductors.

Now suppose that a small but abrupt change of the earth's magnetism takes place, no matter how. We need not enter into the causes of such.

We have thus two secondary coils, if I may use the expression: (1) the moist surface of the earth, (2) the upper regions of the atmosphere; and both of these will be animated with secondary currents, on account of the abrupt change of the earth's magnetism. These secondary currents will be in one direction for a magnetic change of one kind, and in the opposite direction for a magnetic change of the opposite kind.

Now whenever there are magnetic storms, that is to say, when there are small but abrupt changes of the earth's magnetism, it is well known from the Greenwich records that we have violent earth currents, which are alternately positive and negative, and that we have also auroral displays in the upper regions of the earth's atmosphere. We cannot examine the auroral displays as we can the earth currents. But with regard to earth currents I would remark that the *form* of the phenomena they display is entirely against the supposition that such currents are the main cause of the changes in terrestrial magnetism, and in favour of that which maintains that they are secondary currents induced by magnetic changes.

In conclusion I would guard against its being supposed that all luminous appearances in the atmosphere are due to the same cause. I only hold that certain appearances which occur at times of magnetic perturbation and simultaneously throughout a large portion of the earth have the origin now mentioned.

B. STEWART

#### ON A NEW JELLY-FISH OF THE ORDER TRACHOMEDUSÆ, LIVING IN FRESH WATER

ON Thursday last, June 10, Mr. Sowerby, the secretary of the Botanical Society of London, observed in the tank in the water-lily house in Regent's Park a peculiar organism, of which he was kind enough to place a large number at my disposal on the following Monday.

The organism proves to be an adult medusa belonging to the order Trachomedusæ and the family Petasidæ of Haeckel's system ("System der Medusen," erster Theil). It comes nearest among described genera to Fritz Müller's imperfectly known *Aglauropsis* from the coast of Brazil.

The most obviously interesting matter about the form under notice is that it occurs in great abundance in perfectly fresh water at a temperature of 90° Fahr.

Hitherto no medusa of any order has been detected in fresh water—except perhaps some stray estuarine forms (? *Crambessa*).

It is exceedingly difficult to trace the introduction of this animal into the tank in the Regent's Park, since no plants have been recently (within twelve months) added to the lily-house, and the water is run off every year. Probably a few specimens were last year or the year before present in the tank, and have only this year multiplied in sufficient abundance to attract attention. Clearly this medusa is a tropical species, since it flourishes in water of the high temperature of 90° Fahr.

Mr. Sowerby has observed the medusa feeding on *Daphnia*, which abounds in the water with it.

The present form will have to be placed in a new genus, for which I propose the name *Craspedacusta*, in allusion to the relation of its otocysts to its velum.

It is one of the sub-class Hydromedusæ or Medusæ *craspedotæ*, and presents the common characters of the order Trachomedusæ (as distinguished from the Narcomedusæ) in having its genital sacs or gonads placed in the course of the radial canals. It agrees with all Tracholinæ (Trachomedusæ and Narcomedusæ) in having endodermal otocysts, and it further exhibits the solid tentacles with cartilaginous axis, the centripetal travelling of the tentacles, the tentacle rivets (*Mantelspangen*), the thickened marginal ring to the disk (*Nessel ring*) observed in many Tracholinæ.

Amongst Trachomedusæ, *Craspedacusta* finds its place in the Petasidæ, which are characterised as "Trachomedusæ with four radial canals, in the course of which the four gonads lie, with a long tubular stomach and no stomach-stalk."

Amongst Petasidæ it is remarkable for the great number of its tentacles, which are all solid; and for its very numerous otocysts. Further, it is remarkable among all Hydromedusæ (*velate medusæ*, that is, exclusive of *Charybdæa*) for the fact that centrifugal radiating canals pass from the otocysts into the velum, where they end *cæcally*.

The genus may be characterised as follows:—

MOUTH quadrifid, with four per-radial lobes.

STOMACH long, quadrangular, and tubular, projecting a good deal below the disk.

DISK, saucer-shaped, that is, flattened.

RADIATING CANALS 4, opening into the marginal canal.

GNONADS 4, in the form of 4 oval sacs, depending into the cavity of the subumbrella from the four radiating canals.

MARGINAL or RING CANAL voluminous.

CENTRIPETAL CANALS (such as those of *Olindias*, *Geryonia*, &c.) absent.

TENTACLES solid; in three sets, which are placed in three superimposed horizons:—

1. A set nearest the aboral pole, of 4 large per radial tentacles. These are the *primary* tentacles.
2. A second tier of (in large specimens) 28 medium-sized tentacles placed between these in four groups of seven. These are the *secondary* tentacles.
3. A third tier of (in large specimens) 192 small tentacles placed in groups of six between adjacent secondary tentacles. These are the *tertiary* tentacles.

TENTACLE-RIVETS (*Mantel-spangen*) connecting the roots of the tentacles with the marginal ring (*Nessel-ring*) are connected with all the tentacles of each of the three horizons.

OTOLITHS placed along the line of insertion of the velum—about eighty in number (fewer in small specimens). From sixteen to twenty are placed between successive per-radial tentacles arranged in groups of two or three between the successive secondary tentacles.

VELAR CENTRIFUGAL CANALS (which are really the elongated otocysts) are peculiar to this genus, passing from the otoliths (one inclosing each otolith) into the velum, and there ending blindly. They appear to correspond in character to the *centripetal* canals found in other Trachomedusæ in the disk.

OCELLI are absent.

[The presence of velar otocystic canals constitute the chief peculiarity of the genus *Craspedacusta*, and may necessitate the formation of a distinct family or sub-order for its reception. The minute structure of the otoliths and canal-like otocysts I am now engaged in investigating.]

The above characters are derived from the examination of *adult* male specimens, which were freely discharging ripe, actively motile spermatozoa.

The species may be known as *CRASPEDACUSTA SOWERBII*, nov. gen. et sp.—I name the species in honour of Mr. Sowerby, who discovered it, and to whose quick observation and courteous kindness zoologists are indebted for the knowledge of this interesting animal.

The sole character which I can give as specific over and above the generic characters summarised above is that of size. The diameter of the disk does not exceed one-third of an inch.

*Locality*.—The water-lily tank in the gardens of the Botanical Society, Regent's Park, London.

Very abundant during June, 1880. Probably introduced from the West Indies. E. RAY LANKESTER

#### NOTES FROM JAVA

THE following extracts from a letter written from Java by Mr. Henry O. Forbes to Mr. H. N. Moseley, F.R.S., have been sent to us for publication as of considerable interest. The letter is dated March 19. Mr. Forbes, who has been engaged in collecting in Java, expects shortly to leave for Celebes, Timor, Timor-laut, and other eastern islands. Timor-laut is the most important island of the Malay Archipelago yet remaining to be explored, and is likely to yield many natural history treasures. Mr. Forbes's letter refers to certain passages in Mr. Moseley's "Notes by a Naturalist on the *Challenger*." The question of the mode of growth of Myrmecodia and Hydrophytum has been lately before the Linnæan Society.

"With regard to birds carrying seeds from one island to another, I have observed on the Cocos Keeling Islands (South Indian Ocean) a species of heron which nested in a high tree (species unknown) there, quite covered with its oblong hooked seeds. I was informed by the proprietor of the island that many of these birds, from their feathers getting so thickly covered with the seeds, actually die. I can therefore imagine that many of these seeds might adhere for even weeks and months, and so get transported to very distant regions.

"At p. 493 you note the habit of hot-water drinking. It is quite a custom among, at any rate, the Sudanese, among whom I have been living some time, who, in the afternoons, invite each other to come and have a cup of hot water. It is drunk either plain or with a little arenga sugar.

"I have found here a large quantity of algæ growing in the hot springs at a temperature of 132° F. What the species are or is I have not yet ascertained.

"With reference to Myrmecodia and Hydrophytum, I find some difficulty in reconciling in all cases the statement (p. 389) that 'the ants gnaw at the base of the stem, and the irritation produced causes the stem to swell,' with what I have myself observed. I have grown many young seedlings, some of which were entirely unmolested by ants, and yet produced a bulbous swelling at the base; others were certainly scratched, but that was all, by the ants, the smallest scar being visible. On opening many of those which were unmolested I observed a degenerated, soft, spongy portion, not in connection with the exterior. May not this spot increase till an external opening is formed, and the ants have an entrance made for them to carry out, as I have seen them doing, the soft spongy substance inside? I have seen other seedlings that had a small orifice close to the rootlet, leading into an interior oval or round expansion in the bulb, and though I closely observed them I failed to detect ants touching them. All these seedlings I grew from the seed till they reached at most a couple or three inches or a little more, when they generally became the home of some ants. After they had become infested I did not pursue observations on them, as my time was much occupied, and because the object of my observation was to discover if they bulbous, &c., without the aid of ants. I should

much like to see these plants grow with all ant life removed from them entirely. If opportunity again offers I shall continue my experiments. I have repeatedly noticed on large Myrmecodia and Hydrophyta which were crowded with ants (on both genera I have found only one species of ant) that in many places irregularly-shaped areas of degeneration existed quite cut off from communication with the wonderful series of galleries and chambers which form this ant-hive. These were found oftenest near the upper portion of the bulb, and towards which excavations were being directed. I have not observed that the surface of the rounded mass gives off any twigs bearing leaves or flowers. All my specimens have had the shape of a bulb more or less gobose, or elongate, prickly, tenanted by ants, giving origin to a much thinner stem, not, or rarely, chambered nor passaged, but also armed, and from which the leaves and sessile flowers proceeded, the latter from hollows in which numerous ants were constantly moving about. The Hydrophyta generally give off at once leaves at the summit of a more or less irregular bulb.

"I have seen the same species of ant inhabiting the swollen-up hollow leaves of a species of *Hoya* or *Æschynanthus*. The plant I saw had many of its leaves in this condition. I gathered it one day while on the march, and I fear it is lost. It may have been sent to the British Museum, but I am not certain. I have not met with another instance. There was a small hole in the apex of the leaf, and through it the ants came and went. The leaf looked as if all the mesophyllum had been cleared out and the epidermis blown out into a bladder. This observation may not be quite accurate as to the description of leaf, but I noted that the species of ant was the same.

"Here it is quite impossible to obtain a perfect rhinoceros skull, unless one has the good fortune to shoot it oneself, for the horn is so highly prized that it alone fetches from 200 to 300 rupees (Dutch guilders), being eagerly bought by the Chinese. It is believed in by all the natives as a sure and certain antidote for snake-bites and for purifying water. A respectable hadji affirmed to me with the persistency of belief that on his way to Mecca—he went in a native vessel—the stock of fresh water on board ran out, and that all on the vessel, by drinking sea-water out of a rhinoceros horn, found it to be—*not salt water!*"

#### ON THE FERTILISATION OF *PENDULIFLORA* (HOOK. FIL.)

*COBÆA PENDULIFLORA* is a graceful climber, growing rather sparingly in our mountain-forests. It was described and figured by Karsten under the name of *Rosenbergia penduliflora* ("Flora Columbiae," l. 27, t. ix.), and afterwards in the *Bot. Mag.*, i. 5757. Karsten's plate is very pretty, but in all the specimens I have seen the linear lobes of the corolla were never so red as he paints them, nor do the stamens ever hang straight downwards parallel to the style, as his figure shows. The plate in the *Botanical Magazine* has only one defect, the artist having overlooked the hooklets and the ends of the tendrils.

The plant grows exceedingly quickly when kept in shade. A specimen now in my garden was raised from seed sown October 3, 1879, which sprang up a fortnight later, and covered, in less than three months, a wall twelve feet high and ten feet long. It climbs exactly in the same manner as *Cobæa scandens*, described by Darwin in his "Climbing Plants." The flowers have very little to attract attention, their colour being dull green, with very little red on the filaments, and there is no smell. Though not of great horticultural interest, the plant fully deserves the attention of the botanist on account of the peculiar circumstances under which the flowers are fertilised. Sir J. D. Hooker has made already some pertinent remarks on

this point in his description in the *Bot. Mag.*, and it was for the further investigation of the case that I raised a plant in my garden.

The flowers grow on long peduncles, which generally have a horizontal position, projecting some five or six inches from the mass of the foliage. When the calyx opens, the filaments as well as the style are irregularly twisted; but in about two or three days all become straight. The style hangs obliquely downwards; the filaments all bend sideways, the bend being inside the tube of the corolla, a little over the hairs at their base. There is often a distance of 15 centimetres between the anthers of either side. About 5 or 6 o'clock p.m. the anthers burst, and soon after the style rises and assumes a central position, so that there is a distance of about 10 centimetres between the stigmata and any of the anthers. Only *then* is nectar being secreted by the glandular disk round the base of the ovary, but so copiously that by means of a small pipette I obtained from each flower a mean quantity of 0.14 cubic centimetres. This nectar is completely transparent, very sweet, and slightly mucilaginous. It contained a kind of gum which is precipitated by absolute alcohol. The nectar appears therefore when the anthers have done their work; even an hour before their rupture no trace of it is to be found. The nectar-cavity in the tube of the corolla is completely shut up by the numerous spreading hairs at the base of the filaments, so that an outflow is impossible. The grains of pollen are very large (0.2 millim. in diameter) and of the same structure as in *Cobaea scandens*. They are covered by a glutinous layer, and are heavier than water.

Several weeks passed at first before I witnessed the manner of fertilisation. The stigmata were every morning carefully examined, but no pollen could be discovered on them. The filaments twisted back again and got somewhat frizzled, after one single night's expansion. About noon the corolla drops off, separating from close to the glandular ring, and then slipping down over the style, which, by this time, is again in a relaxed hanging position. There is always some nectar in the tube of the corolla after its separation, but none remains in the calyx round the ovary, nor does its secretion continue.

These facts show clearly that the fertilisation must take place in the same night after the bursting of the anthers, and it was but natural to suppose that it was effected by nocturnal moths. It would appear, furthermore, that the nectar is not of any direct advantage to the plant, as Mr. G. Bonnier emphatically affirms (*Annales des Sci. Nat. Bot.*, sér. vi. vol. viii. p. 206), because of its being produced and lost in all flowers, fertilised or not, in the same way.

As soon as the number of flowers increased (on some evenings twenty to twenty-five had their anthers opened), I found every morning most of them with pollen on the stigmata, and keeping a close watch, I discovered that the plant was visited by several large Sphingidæ belonging to the genera *Chaerocampa*, *Diludia*, and *Amphonyx*. I observed altogether four visits of an *Amphonyx*, three of a *Chaerocampa*, and one of a *Diludia*. All of them proceeded in the same manner. Holding the body close over the style, they dipped their spiral tongues into the tube of the corolla, beating all the while the anthers so violently with the tips of the fore-wings that they dangled about with great velocity in every direction. The grains of pollen being covered by a sticky substance, many of them adhered to the wings. I have caught an *Amphonyx* which, after having visited six flowers consecutively, had the tips of the fore-wings almost yellow with pollen. When leaving a flower for another one, some of this pollen is even lost on the foliage, but by the time the insect takes its central position before the flower the stigmata are likewise touched by the wings, and thus some pollen is left on them. Some flowers remain without being fertilised, especially in places where the moths cannot reach

them easily. All flowers fertilised in this manner set fruit very soon; but no flower gave a fruit without having its stigmata pollenised by crossing.

Self-fertilisation is therefore excluded, and this is further proved by the following experiments:—Twelve flowers were artificially fertilised by their own pollen and afterwards protected by muslin bags; only in one case was a fruit obtained; but I am not quite sure whether there did not come some foreign pollen on the stigmata of this flower. Cross-fertilisation was likewise tried in twelve flowers, nine being experimented on in the same evening after the opening of the anthers, and three the next morning. All the former are now with fruit; the latter remained sterile. This fact shows how very short is the period of possible fertilisation.

Flowers visited by nocturnal moths are as a rule either large and of white colour, or have a strong smell; but in our *Cobaea* the former is certainly not the case, and my olfactory nerves at least cannot discover any smell. But it is well known that insects, especially Lepidoptera, are in this respect of a really wonderful keenness, which enables them to track a scent absolutely imperceptible to man.

As I shall have a considerable crop of *Cobaea*-seeds, I can offer some to any botanists who should wish to grow the plant.

Caracas, April 4.

A. ERNST

P.S.—As soon as the corolla has fallen off, the peduncle withdraws slowly amongst the dense foliage, where the fruit develops, protected from all kinds of injury.

#### EXPERIMENTAL RESEARCHES IN ELECTRICITY<sup>1</sup>

Part III.—*Tube-Potential; Potential at a Constant Distance and Various Pressures; Nature and Phenomena of the Electric Arc.*

MESSRS. De La Rue and Müller, in the third part of their researches on the electric discharge, commence by describing a series of experiments to determine the potential necessary to produce a discharge in a tube, exhausted gradually more and more while using a constant number of cells in all the experiments. In consequence of the life of the battery becoming so much exhausted by the method employed the experiments were confined to one gaseous medium, namely, hydrogen. Since the completion, however, of the measurements described in the paper the authors have found two other more convenient methods for determining the tube-potential, which do not exhaust the battery injuriously; these are described in an appendix. The tube, 162, employed was 33 inches long and 2 inches in diameter, the distance between the ring and straight wire terminals being 29.75 inches; the battery consisted of 11,000 cells. The discharge took place when the pressure was reduced to 35.5 mm., 46,710 M (millionths of an atmosphere), and the exhaustion was afterwards continued gradually until it fell to 0.0065 mm., 8.6 M. In commencing each set of experiments the deflection of a tangent-galvanometer was observed when the battery was short-circuited. By a table previously calculated the value of the deflection in ohms of resistance per cell could be read off; this, multiplied by 11,000, gave the total resistance of the battery; the tube was then connected with the terminals and the galvanometer again observed; this gave a less deflection and indicated a greater resistance, which, multiplied by 11,000, gave the total resistance of the tube and battery: by subtracting the resistance of the battery the resistance of the tube was ascertained. Calling the total resistance R, the tube resistance r, the tube-potential V,  $V = \frac{r \times 11,000}{R}$ . The tube-potential re-

quisite to produce a discharge, with a pressure of 46,710 M, was found to be 10,250 cells; this gradually fell until

<sup>1</sup> "Experimental Researches on the Electric Discharge with the Chloride of Silver Battery," by Warren De La Rue, M.A., D.C.L., F.R.S., and Hugo W. Müller, Ph.D., F.R.S. (*Phil. Trans.*, vol. clxxd. p. 65).

a pressure of 0.642 mm., 1.082 M, was reached, the tube-potential being then only 430 cells, after which it rapidly rose, and, at 8.6 M, it required a potential of 8,937 cells to produce a discharge. From the experiments described

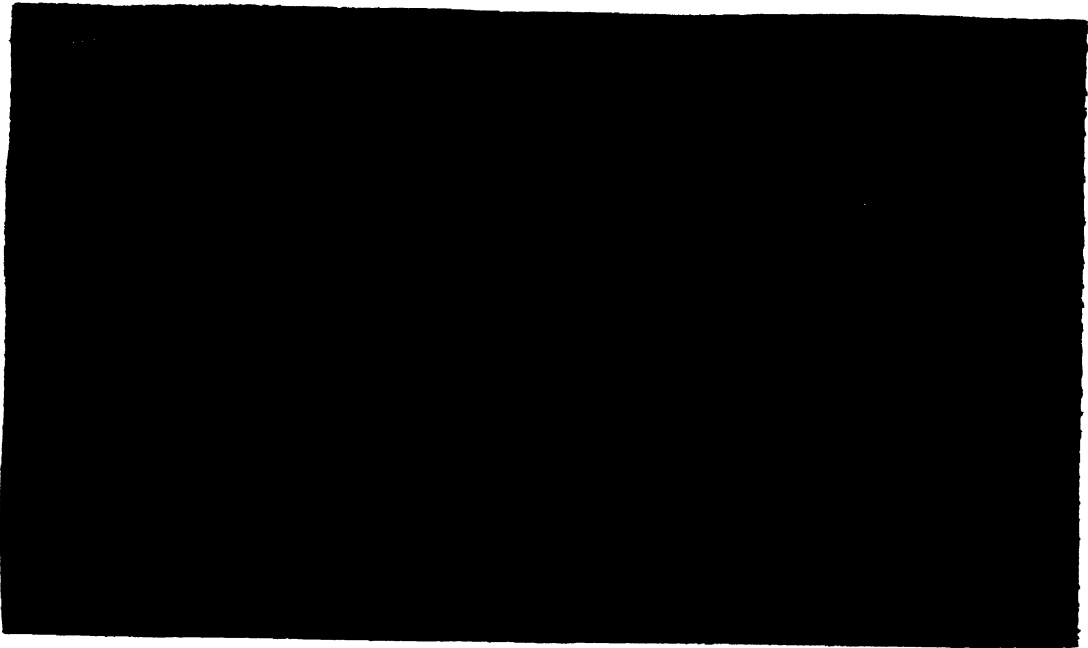

DIAGRAM I.

in a previous paper it was found that, in another tube, it charge at 3 M, and that, at 18 M, this potential was required the full potential of 11,000 cells to produce a discharge at 3 M, and that, at 18 M, this potential was insufficient. The obstruction to the discharge in tube

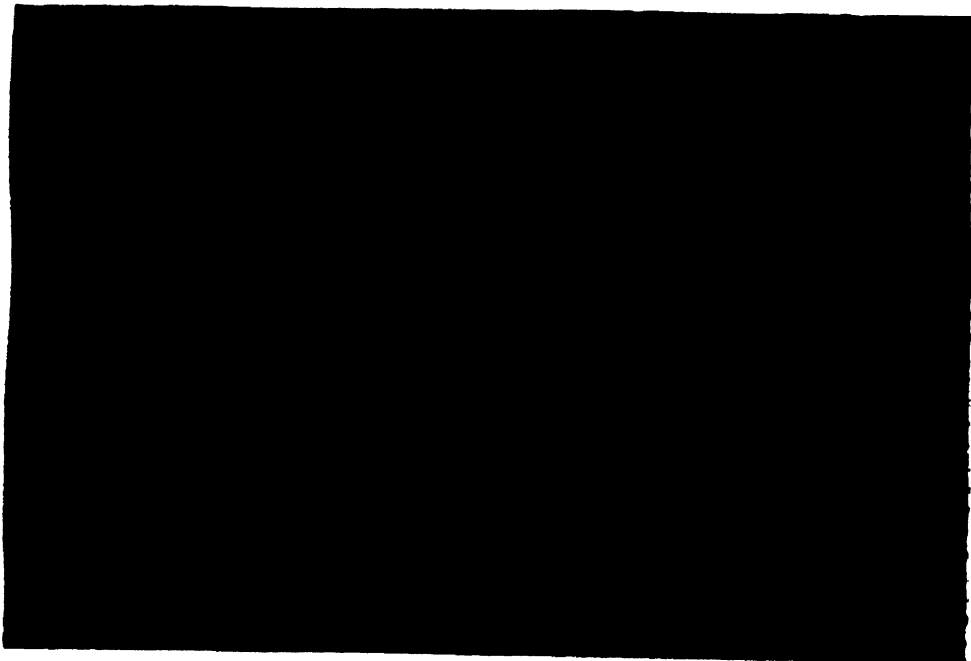

DIAGRAM II.

A—B represents an assumed mean distance of the molecules at a pressure of 5 millionths of an atmosphere. A' to 10, A' 20 20, ..... A' to 40960, the corresponding distances at pressures 10, 20, 40960 millionths.

162 was as great at 8.6 M as at 28,553 M pressure, and | The diagram (No. I.) laid down from the results when the ring was made positive, shows the curve of the obser-



vations as actually obtained without being smoothed. The figure is a reduction to  $\frac{1}{8}$  of the original; the abscissæ are as the cube-roots of the various pressures in millionths of an atmosphere, and show relatively the number of molecules in a given linear space; the ordinates are as the number of cells.

The observations were again plotted down as in Diagram No. II., making the abscissæ in the inverse ratio of the cube-roots of the various pressures in millionths, so as to represent relatively the mean distance of the molecules at the various pressures in millionths of an atmosphere; this has the effect of extending the scale for decreasing pressures beyond the minimum resistance of the tube, and of compressing it on the opposite side for increasing pressures.

The following tables show the number of cells necessary to produce a discharge for various pressures in millionths of an atmosphere:—

Pressure.	V.		Pressure.	V.	
	Cells.	Increase per 1,000 M.		Cells.	Increase per 1,000 M.
M 845	430	cells.	M 23,000	8,490	cells.
1,000	1,000	1,190	24,000	8,630	140
1,500	1,780		25,000	8,800	170
2,000	2,190	590	26,000	8,960	160
3,000	2,780	475	27,000	9,100	140
4,000	3,230	430	28,000	9,250	150
5,000	3,660	370	29,000	9,390	140
6,000	4,030	350	30,000	9,530	140
7,000	4,380	370	31,000	9,650	120
8,000	4,750	320	32,000	9,770	120
9,000	5,070	310	33,000	9,880	110
10,000	5,380	330	34,000	9,980	100
11,000	5,710	320	35,000	10,070	90
12,000	6,030	320	36,000	10,150	80
13,000	6,350	280	37,000	10,230	80
14,000	6,630	270	38,000	10,300	70
15,000	6,900	260	39,000	10,360	60
16,000	7,160	240	40,000	10,420	60
17,000	7,400	230	41,000	10,475	55
18,000	7,630	210	42,000	10,520	45
19,000	7,840	180	43,000	10,550	30
20,000	8,000	180	44,000	10,580	30
21,000	8,180	160	45,000	10,590	10
22,000	8,340	150	46,000	10,600	10
23,000	8,490		47,000	10,600	0

Pressure.	V.		Pressure	V.	
	Cells.	Decrease per to M increase.		Cells.	Decrease per to M increase.
M 8	9,600	cells.	M 90	5,280	cells.
9	8,460	11,400	100	5,145	135
10	7,500	9,600	200	4,200	94.5
20	7,080	420	300	3,600	60
30	6,722	358	400	3,120	48
40	6,390	332	500	2,670	45
50	6,090	300	600	2,280	39
60	5,820	270	700	1,830	45
70	5,625	195	800	1,320	51
80	5,445	180	900	1,000	16
90	5,280	165	1,000		

An experiment was made in order to ascertain whether there was either any condensation or dilatation of the gas in contiguity with the terminals before the actual passage of the discharge. In order to do this an apparatus was constructed, as shown in Fig. 1.

It consists of a glass cylinder, 4.35 inside diameter, the depth of which is accurately the same in every part, 1.6 inch, so as to insure the parallelism of two glass disks which close its ends. Its cubical contents exclusive of the terminals was found to be 385 cub. centims.

These are held in contact with the ends of the cylinder by means of screw-clamps made of ebonite, and the whole apparatus is supported on a tripod ebonite stand, which is fastened to a square wooden foot. Attached parallel to the top and bottom glass disks, by means of flanged-screw rods, are two brass disks with rounded edges, 3.1 inches in diameter; these are maintained at a distance of 0.13 inch, 3.3 mm. at which the discharge of 11,000 cells would only just take place.

The ends which project through the glass disks are furnished with binding-screws for attaching wires from the battery.

On the side of the cylinder is a tubulure in which is fitted a gauge containing strong sulphuric acid, so as to dry the inside of the apparatus, and to indicate whether any condensation or dilatation of the gas contained in the cylinder occurs on connecting the metallic disks with the battery by means of the contact-key. The edges of the cylinder were rubbed with grease, and care was taken to prove that the apparatus was perfectly tight by causing the fluid in the limb of the gauge to stand for some time higher than that in the bulb. When connection was made with a battery of 9,800 cells, there was not the slightest indication of any alteration of volume of the contained air, so that there was neither condensation about the disks which would have caused a contraction, nor repulsion from the disks which would have caused an expansion of volume. The fluid in the stem was observed with a lens, but not the slightest motion of it took place. The same result was noticed even when water was substituted for sulphuric acid. So far, then, as this apparatus would indicate it, the result is entirely negative.

Potential necessary to produce a discharge between disks 1.5 inch diameter at a constant distance and at various pressures

The experiments were made by placing the micro-

meter-discharger, shown in Fig. 2, under the bell-jar of an air pump to which was attached a gauge about 36 inches long in order to indicate the pressure of the contained gas. In the first instance the disks were adjusted to the striking-distance at atmospheric pressure for the battery of 11,000 cells. Afterwards a less number of cells was connected with the disks and the bell-jar gradually exhausted until the discharge occurred; the height of the mercury in the gauge was then read off. Then a less and less number of cells was connected with the disks and the operation was repeated.

In air the discharge took place at ordinary atmospheric pressure with 11,000 cells when the disks were 0.13 inch, 3.3 mm. distant, and with 600 cells at an average pressure of 10 mm.

In hydrogen it took place at atmospheric pressure with 11,000 cells when the disks were 0.22 inch, 5.59 mm. distant; and with 600 cells at an average of 14 mm. pressure.

In carbonic acid, at atmospheric pressure with 11,000 cells, when the disks were 0.122 inch, 3.096 mm. distant; and with 600 cells at an average pressure of 5.2 mm.

The numbers obtained for air, hydrogen, and carbonic acid respectively were plotted down on millimetre scale paper, the abscissæ being 1 mm. = 2,500 M, the ordinates 1 mm. = 25 cells, and curves drawn to give a mean of the several observations. These appeared to resemble hyperbolic curves so closely that true hyperbolic curves were found partly by a geometric construction, partly by computation, which would intersect the mean experimental curves in two points. The results of experiment were again laid down on these new curves, and it was found that they did not differ more from them than they did from each other.

The ratio of the transverse axis (pressure) to the conjugate axis (potential) of the hyperbolas set out on the above-mentioned scale was—

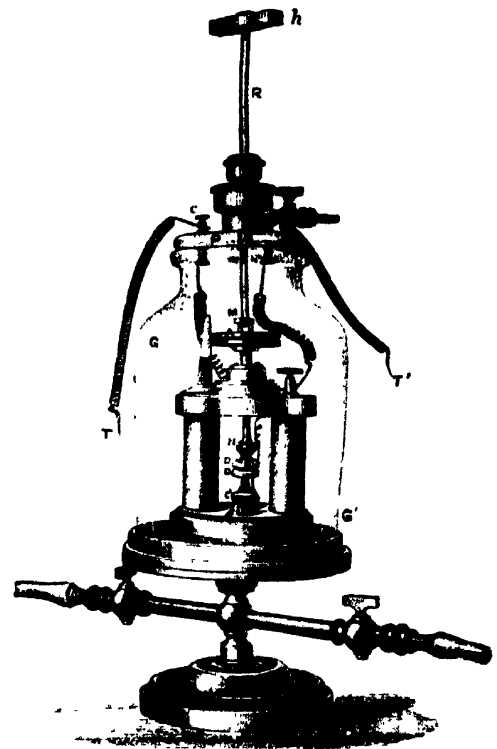
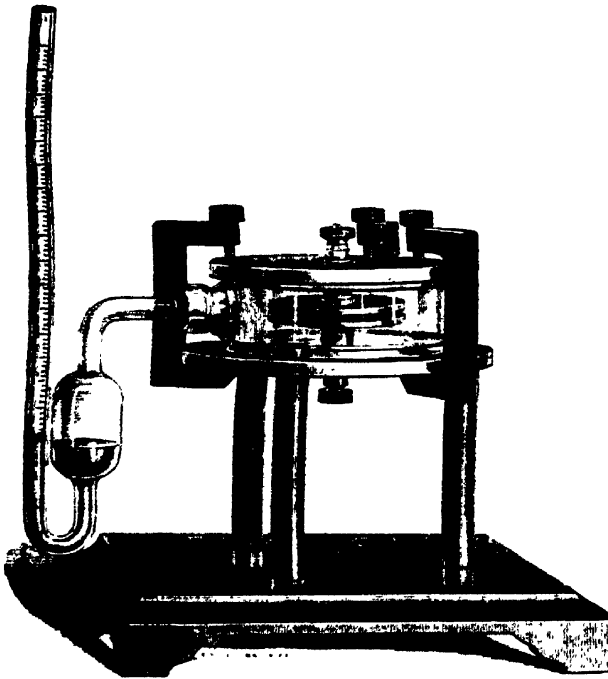

FIG. 2.

For air	...	...	...	...	0.9665
hydrogen	...	...	...	...	1.0170
carbonic acid	...	...	...	...	1.0690

The striking distances at atmospheric pressure for spherical surfaces 3 inches radius and 1.5 inch diameter, with various potentials, as given in Part I. page 68, curve VIII. and at page 118, also those for nearly flat surfaces in pages 73 and 118, were reduced to millimetres distance and plotted down in the same way, but not on precisely the same scale as the preceding curves for constant distance and various pressures. Hyperbolic curves were also found which intersected the experimental curves in two points.

It was seen in the case of spherical surfaces, the result having been obtained as the average of a great number of experiments, that the hyperbola coincided closely with the observations, while for plane surfaces, for which only a few experiments were made, the coincidences were not quite so perfect. Nevertheless, it would appear that the

law of the hyperbola holds equally well for a constant pressure and varying distance as it does for a constant distance and varying pressure; the obstacle in the way of a discharge being up to a certain point as the number of molecules intervening between the terminals.<sup>1</sup>

In the two cases of spherical and plane surfaces the ratio between the transverse (distance) and conjugate (potential) axes of the respective hyperbolas was—

For spherical surfaces	...	...	...	...	1.240
„ disks	...	...	...	...	1.285

With the data already published in Part I., the authors have laid down a fresh curve for the striking distance

<sup>1</sup> Dr. Alexander Macfarlane has published in the *Transactions of the Royal Society of Edinburgh*, 1878, vol. xxvii., an elaborate and careful research of the "Disruptive Discharge of Electricity" in air and different gases, and between terminals of various forms. An abstract of this paper will be found in *NATURE*, vol. xix. pp. 184, 185. Dr. Macfarlane used a Holtz machine and employed higher potentials than those we used. He found that the results for the discharge between two disks 4 inches in diameter at various distances up to 12 centims. and with various pressures were satisfactorily represented by the hyperbola.

between flat disks on a scale of 10 centims. for a millimetre and 5 centims. to 1,000 cells.

From the curve thus laid down the following numbers were deduced :—

EMF in volts.	Striking distance in centimetres.	Difference of potential per centimetre.	Intensity of force.	
			Electro-magnetic.	Electro-static.
		volts.		
1,000	0'0205	48,770	4'88 × 10 <sup>12</sup>	163
2,000	0'0430	46,500	4'65 "	155
3,000	0'0660	45,450	4'55 "	152
4,000	0'0914	43,770	4'38 "	146
5,000	0'1176	42,510	4'25 "	142
6,000	0'1473	40,740	4'07 "	136
7,000	0'1800	38,800	3'89 "	130
8,000	0'2146	37,280	3'73 "	124
9,000	0'2495	36,070	3'61 "	120
10,000	0'2863	34,920	3'49 "	116
11,000	0'3245	33,900	3'39 "	113
11,309	0'3378	33,460	3'35 "	112

The remainder of the paper is chiefly occupied with the study of the phenomena of the electric arc under various conditions of distance, pressure, and potential; the results obtained support the view that the arc and the stratified discharge are merely modifications of the same phenomenon.

(To be continued.)

#### A FOURTH STATE OF MATTER<sup>1</sup>

IN introducing the discussion on Mr. Spottiswoode and Mr. Moulton's paper on the "Sensitive State of Vacuum Discharges," at the meeting of the Royal Society on April 15, Dr. De La Rue, who occupied the chair, good-naturedly challenged me to substantiate my statement that there is such a thing as a fourth or ultra-gaseous state of matter.

I had no time then to enter fully into the subject; nor was I prepared, on the spur of the moment, to marshal all the facts and reasons which have led me to this conclusion. But as I find that many other scientific men besides Dr. De La Rue are in doubt as to whether matter has been shown to exist in a state beyond that of gas, I will now endeavour to substantiate my position.

I will commence by explaining what seems to me to be the constitution of matter in its three states of solid, liquid, and gas.

I. First as to Solids:—These are composed of discontinuous molecules, separated from each other by a space which is relatively large—possibly enormous—in comparison with the diameter of the central nucleus we call *molecule*. These molecules, themselves built up of *atoms*, are governed by certain forces. Two of these forces I will here refer to—attraction and motion. Attraction when exerted at sensible distances is known as *gravitation*, but when the distances are molecular it is called *adhesion* and *cohesion*. Attraction appears to be independent of absolute temperature; it increases as the distance between the molecules diminishes; and were there no other counteracting force the result would be a mass of molecules in actual contact, with no molecular movement whatever—a state of things beyond our conception—a state, too, which would probably result in the creation of something that, according to our present views, would not be *matter*.

This force of cohesion is counterbalanced by the movements of the individual molecules themselves, movements

<sup>1</sup> "On a Fourth State of Matter," in a letter to the Secretary of the Royal Society. By W. Crookes, F.R.S.

varying directly with the temperature, increasing and diminishing in amplitude as the temperature rises and falls. The molecules in solids do not travel from one part to another, but possess adhesion and retain fixity of position about their centres of oscillation. Matter, as we know it, has so high an absolute temperature that the movements of the molecules are large in comparison with their diameter, for the mass must be able to bear a reduction of temperature of nearly 300° C. before the amplitude of the molecular excursions would vanish.

The state of solidity, therefore—the state which we are in the habit of considering *par excellence* as that of *matter*—is merely the effect on our senses of the motion of the discrete molecules among themselves.

Solids exist of all consistences, from the hardest metal, the most elastic crystal, down to thinnest jelly. A perfect solid would have no viscosity, *i.e.*, when rendered discontinuous or divided by the forcible passage of a harder solid, it would not close up behind and again become continuous.

In solid bodies the cohesion varies according to some unknown factor which we call chemical constitution; hence each kind of solid matter requires raising to a different temperature before the oscillating molecules lose their fixed position with reference to one another. At this point, varying in different bodies through a very wide range of temperature, the solid becomes liquid.

II. In liquids the force of cohesion is very much reduced, and the adhesion or the fixity of position of the centres of oscillation of the molecules is destroyed. When artificially heated, the inter-molecular movements increase in proportion as the temperature rises, until at last cohesion is broken down, and the molecules fly off into space with enormous velocities.

Liquids possess the property of viscosity—that is to say, they offer a certain opposition to the passage of solid bodies; at the same time they cannot permanently resist such opposition, however slight, if continuously applied. Liquids vary in consistency from the hard, brittle, apparently solid pitch to the lightest and most ethereal liquid capable of existing at any particular temperature.

The state of liquidity, therefore, is due to inter-molecular motions of a larger and more tumultuous character than those which characterise the solid state.

III. In gases the molecules fly about in every conceivable direction, with constant collisions and enormous and constantly varying velocities, and their mean free path is sufficiently great to release them from the force of adhesion. Being free to move, the molecules exert pressure in all directions, and were it not for gravitation they would fly off into space. The gaseous state remains so long as the collisions continue to be almost infinite in number, and of inconceivable irregularity. The state of gaseity, therefore, is pre-eminently a state dependent on collisions. A given space contains millions of millions of molecules in rapid movement in all directions, each molecule having millions of encounters in a second. In such a case the length of the mean free path of the molecules is exceedingly small compared with the dimensions of the containing vessel, and the properties which constitute the ordinary gaseous state of matter, which depend upon constant collisions, are observed.

What, then, are these molecules? Take a single lone molecule in space. Is it solid, liquid, or gas? Solid it cannot be, because the idea of solidity involves certain properties which are absent in the isolated molecule. In fact, an isolated molecule is an inconceivable entity, whether we try, like Newton, to visualise it as a little hard spherical body, or, with Boscovich and Faraday, to regard it as a centre of force, or accept Sir William Thomson's vortex atom. But if the individual molecule is not solid, *a fortiori* it cannot be regarded as a liquid or gas, for these states are even more due to inter-molecular collisions than is the solid state. The individual mole-

cules, therefore, must be classed by themselves in a distinct state or category.

The same reasoning applies to two or to any number of contiguous molecules, provided their motion is arrested or controlled, so that no collisions occur between them; and even supposing this aggregation of isolated non-colliding molecules to be bodily transferred from one part of space to another, that kind of movement would not thereby cause this molecular collocation to assume the properties of gas; a molecular wind may still be supposed to consist of isolated molecules, in the same way as the discharge from a mitrailleuse consists of isolated bullets.

Matter in the fourth state is the ultimate result of gaseous expansion. By great rarefaction the free path of the molecules is made so long that the hits in a given time may be disregarded in comparison to the misses, in which case the average molecule is allowed to obey its own motions or laws without interference; and if the mean free path is comparable to the dimensions of the containing vessel, the properties which constitute gaseity are reduced to a minimum, and the matter then becomes exalted to an ultra-gaseous state.

But the same condition of things will be produced if by any means we can take a portion of gas, and by some extraneous force infuse order into the apparently disorderly jostling of the molecules in every direction, by coercing them into a methodical rectilinear movement. This I have shown to be the case in the phenomena which cause the movements of the radiometer, and I have rendered such motion visible in my later researches on the negative discharge in vacuum tubes. In the one case the heated lamp-black and in the other the electrically excited negative pole supplies the *force majeure* which entirely or partially changes into a rectilinear motion the irregular vibration in all directions; and according to the extent to which this onward movement has replaced the irregular motions which constitute the essence of the gaseous condition, to that extent do I consider that the molecules have assumed the condition of radiant matter.

Between the third and the fourth states there is no sharp line of demarcation, any more than there is between the solid and liquid states, or the liquid and gaseous states; they each merge insensibly one into the other. In the fourth state properties of matter which exist even in the third state are shown *directly*, whereas in the state of gas they are only shown *indirectly*, by viscosity and so forth.

The ordinary laws of gases are a simplification of the effects arising from the properties of matter in the fourth state; such a simplification is only permissible when the mean length of path is small compared with the dimensions of the vessel. For simplicity's sake we make abstraction of the individual molecules, and feign to our imagination *continuous* matter of which the fundamental properties—such as pressure varying as the density, and so forth—are ascertained by experiment. A gas is nothing more than an assemblage of molecules contemplated from a simplified point of view. When we deal with phenomena in which we are obliged to contemplate the molecules individually, we must not speak of the assemblage as *gas*.

These considerations lead to another and curious speculation. The molecule—intangible, invisible, and hard to be conceived—is the only true *matter*, and that which we call matter is nothing more than the effect upon our senses of the movements of molecules, or, as John Stuart Mill expresses it, “a permanent possibility of sensation.” The space covered by the motion of molecules has no more right to be called matter than the air traversed by a rifle bullet can be called lead. From this point of view, then, matter is but a mode of motion; at the absolute zero of temperature the inter-molecular movement would stop, and although *something* retaining the properties of inertia and weight would remain, *matter*, as we know it, would cease to exist.

## NOTES

THE Council of the Society of Arts have awarded the Albert Medal of the Society of the present year to James Prescott Joule, LL.D., D.C.L., F.R.S., “for having established, after most laborious research, the true relation between heat, electricity, and mechanical work, thus affording to the engineer a sure guide in the application of science and industrial pursuits.” The medal was delivered to Dr. Joule by the Prince of Wales on Tuesday, when Sir William Thomson received the medal awarded him by the Society in 1878.

THE Paris Academy of Sciences has awarded the Monthyon Prize to M. Camille Flammarion for his new work entitled “Astronomie Populaire.” It is a large 4to volume, with magnificent engravings, which was sold in 100 penny parts. The sale in the first year of publication reached 40,000 copies.

It is stated that M. Coggia, Astronomer to the Marseilles Observatory, will be appointed Director of the Algiers Observatory, where no observations at all have been made since its creation in 1864 by Marshal Pelissier.

THE University of Oxford has conferred the degree of D.C.L. on Prof. Sylvester and Mr. Lister, the eminent surgeon.

ON Saturday, May 5, the local committee of the French Association for the Advancement of Science met at Rheims, where the next meeting is to be held in August. An exposition of local industry and archeology will be held. Arrangements have been made for excursions connected with the congress, the more notable of which will be to the Han Grottoes, which are situated in Belgium. Nothing has been arranged yet as to the lectures to be delivered.

THE new Principal of the Royal Agricultural College, Cirencester, the Rev. J. B. McLellan, has started a scheme of congresses or conferences which may prove of considerable value to agriculture. On Friday, the 5th inst., a goodly number of old Cirencester students and professors, as well as local agriculturists, met in the College Hall to discuss important agricultural questions. The morning session was occupied with the subject of cattle diseases; the afternoon was devoted to agricultural stations and research. If the papers introducing the subjects were not of a very high order, it may at least be conceded that the discussions which followed brought out some sound information and advice. If such congresses as this at Cirencester help to draw public attention to the need for some new departure in modern and scientific agriculture, and if they stimulate those interested in farming to look to the College as the central authority on a subject which that institution must learn to handle adequately, then we predict for them a substantial success.

THE annual conference at the Society of Arts on the laws, administration and inspection with regard to public health was opened on Thursday under the presidency of Mr. Stansfeld, M.P. The committee had drawn up a programme of subjects for discussion, which were grouped under the following headings:—  
1. Administrative Organisation: 2. Amendment of the Law: 3. Sanitary Inspection and Classification of Dwellings: 4. Further suggestions by Sanitary Authorities. In the discussion on Thursday the chairman, in opening the proceedings, pointed out the desirability of an “inquiry office” being established in connection with the Local Government Board, at which local authorities might obtain information based on experience. One great hope for the future was that the teaching of the laws of health to children was gradually spreading. The conference was resumed on Friday. In reference to the third heading, the following resolution was put to the meeting:—“That it is expedient that the Metropolitan Board of Works within the metropolis, and the County Board within each county, should

be empowered by the Legislature to make provision for the inspection and sanitary classification of dwellings, upon application being made by the owners thereof, and to grant certificates of healthworthiness in different categories, for terms of years, according to the perfection of sanitary equipment and fitness for habitation of such dwellings; and to determine the scale of fees to be paid for such inspection during construction and repair, and also upon delivery to the applicant of the certificate of classification awarded to such dwelling. In the long discussion which followed it was clear that the sense of the conference was in favour of some change, but opinions were much divided as to how inspection and certificates should be brought to bear. Among other arguments it was urged that, as Lloyd's Association inspected the construction of ships and granted certificates, it would be only an extension of a recognised system to inspect and give certificates for houses. After a protracted discussion, the resolution was passed with some few alterations. An exhibition of sanitary appliances was open free to the public. The chief novelty was the new filtering medium adopted by the Admiralty and War Office named Carferal, on which Prof. De. Chaumont has recently reported so favourably.

MR. R. L. JACK, the Government Geologist of Queensland, has been carrying out his survey operations under difficulties unknown to home geologists. While he and his party were pursuing their explorations in the north of York Peninsula they were attacked by a band of natives, Mr. Jack receiving a spear in the neck, which had to be cut out. Fortunately the wound, though troublesome, is not likely to be attended with any serious or permanent results. North of Temple Bay Mr. Jack came upon a hitherto unknown large river, which he has named the "Macmillan."

THE *Daily News* gives some account of a recent lecture by Prof. Palmieri on earthquakes. Prof. Palmieri went on to say that earthquakes have no doubt shorter or longer periods of preparation. The earth is never perfectly quiet for some time before and after a great shock, but gradually sinks into repose or increases in agitation. The Professor believes that, by registering the slight preliminary tremblings and noticing their increase or decrease it would be possible to forestall an earthquake about three days in advance, just as tempests are now foretold. If a connected system of seismographic stations were to be organised—the different stations communicating with each other by telegraph—it would be quite possible, in most cases, to issue warnings to the threatened district in time. The seismographic stations should be erected by the different Governments in quiet places where the ground was not liable to be shaken by heavy railway trains.

THE illumination of the park of the Industrial Exhibition of Melun with Wild candles has been considered successful, and will be continued every night during the whole of the summer. It is said that the proprietors of the Wild patent will take an injunction against M. Jamin for an infringement of their patent, alleging that his directing frame is not an independent invention.

M. W. DE FONVIELLE has discovered that the intermittent current of the frame of his electro-magnetic gyroscope can be made continuous if the magnet is replaced by an electro-magnet worked by an interrupter.

THE French Government has taken an important step in the education of the people; a course of teaching in agriculture has been ordered to be introduced into every primary school in the country.

MESSRS. MACMILLAN AND CO. have published a sixth edition of the late Prof. George Wilson's well-known little book, "The Five Gateways of Knowledge."

CHEMISTS engaged in the analysis of alcoholic liquids will be able shortly to possess an elaborate and complete series of tables of spirit gravities, prepared by Dr. Thos. Stevenson, of Guy's, and to be published in handy book size by Mr. Van Voorst.

MR. G. AMBROSE POGSON, British Vice-Consul at Hamburg, writes to the *Times* from that place, under date June 12, as to "St. Elmo's Fire":—A series of thunderstorms, he states, has lately passed over Hamburg. During the 11th inst. the air was densely charged with electricity; the storm broke about 10.15 p.m., lasting until 11 p.m., during which time, at very short intervals, from my station, about 1,200 yards distance from the copper-roofed tower of the church known as St. Jacobi, about 300 feet high, I saw this phenomenon apparently resting about 30 feet from the summit of the steeple. The colour was a reddish purple, and reminded one somewhat of burning potassium. From repeated comparisons with other objects during the lightning flashes, I judged these fire-balls (two were several times visible) to be from 4 feet to 6 feet in diameter. The longest duration that I timed was 42 seconds. This passing away of such dense masses of electricity by induction was visible some twenty times, but whether performed silently I had no means of ascertaining. From the apparent size of flame and the non-lighting quality of the colour, I estimated it as equal to 10,000 candles. The colour was doubtless the effect of the glare of the copper roof.

DURING 1881 no less than five exhibitions will be held at Frankfort-on-the-Main, viz., a patent exhibition, a horticultural, a balneological, an industrial, and a tanner's and furrier's exhibition.

A MEETING of the members of the Aeronautical Society of Great Britain will be held at the Society of Arts, Adelphi, on Monday, June 21, for the reading and discussion of papers, and generally for the advancement of the Society's interests. The chair will be taken precisely at 8 p.m.

WE are requested to make the following announcement with regard to the Sunday Art Exhibitions of the Sunday Society:—On Sunday, June 20, the first exhibition at the Hanover Gallery, including Hans Makart's great picture of the Entry of Charles V. into Antwerp, will be open to the members of the Society, and on the two following Sundays, June 27 and July 4, the public will be admitted by means of free tickets, which will be issued to those who apply by letter, sending a stamped and addressed envelope to the Honorary Secretary, 6, Dudley Place, W. On each Sunday the Gallery will be opened from 3 till 9 p.m. The Grosvenor Gallery will be opened to the members of the Society on Sunday, July 25, and to the public on Sunday, August 1, by tickets to be had on written application as above.

ON Saturday the Geologists' Association and the West London Scientific Association make a combined excursion to Croydon and Riddlesdown.

THE additions to the Zoological Society's Gardens during the past fortnight include a White-throated Capuchin (*Cebus hypoleucus*) from Central America, presented by Miss Baker; a Toque Monkey (*Macacus pileatus*) from Ceylon, presented by Mr. H. P. Brennan; a Brown Bear (*Ursus arctos*) from Asia, presented by Mr. Chas. Overbeck; a Pig-tailed Monkey (*Macacus nemestrinus*) from Java, presented by Mr. W. C. Lawes; a Macaque Monkey (*Macacus cynomolgus*) from India, presented by Mr. T. H. Adey; a Black-eared Marmoset (*Hapale penicillata*) from South-East Brazil, presented by Mr. G. Mantell; three Slender Loris (*Loris gracilis*) from Ceylon, presented by Lord Lilford, F.Z.S.; a Dingo Dog (*Canis dingo*) from Australia, presented by Lord Ernest Gordon; a White Pelican (*Pelecanus onocrotalus*) from North Africa, presented by Mr. J. Simonds; a Musky Lorikeet (*Trichoglossus concinnus*) from Australia, pre-

sent by Mr. A. H. Jamrach; a Horsfield's Tortoise (*Pestudo horsfieldi*) from Afghanistan, presented by Capt. Cotton; two Smooth Snakes (*Coronella lavisi*), British, presented respectively by Mr. W. Penny and Mr. Thos. J. Mann; two Yellow-headed Troupials (*Xanthocephalus icterocephalus*) from Mexico, presented by Mr. W. A. Conklin; a Jaguar (*Felis onca*) from Bolivia, two Common Boas (*Boa constrictor*) from Savanilla, deposited; a Ring-tailed Lemur (*Lemur catta*) from Madagascar, a Ludio Monkey (*Cercopithecus ludio*), a Mona Monkey (*Cercopithecus mona*), two Rus's Weaver Birds (*Quelea russi*), two Cinereous Waxbills (*Estrelda carulecens*), two Crimson-eared Waxbills (*Estrelda phenicotis*) from West Africa, a Black-footed Penguin (*Spheniscus demersus*), a Levaillant's Parrot (*Psecephalus robustus*), from South Africa, a Brahminy Kite (*Haliastur indus*) from North Australia, two Swift Parrakeets (*Lathamus discolor*) from Tasmania, two Victoria Crowned Pigeons (*Goura victoria*) from the Island of Jobie, four Bengal Weaver Birds (*Ploceus bengalensis*) from India, a Red Lory (*Eos rubra*), an Ornamental Lorikeet (*Trichoglossus ornatus*) from Moluccas, a White-billed Parrakeet (*Tanygnathus albirostris*) from Celebes, a Noble Macaw (*Ara nobilis*) from Brazil, two Yellow-fronted Amazons (*Chrysolis ochrocephala*) from Panama, a White headed Parrot (*Pionus senilis*) from Mexico, two Black-headed Conures (*Conurus nanday*) from Paraguay, two Silky Marmosets (*Midas rosalia*) from South-East Brazil, a Leucoryx Antelope (*Oryx leucoryx*) from North Africa, a Common Otter (*Lutra vulgaris*), British, three Chinchillas (*Chinchilla lanigera*) from Chili, an Upland Goose (*Bernicla magellanica*) from the Falkland Islands, three Ashy-headed Geese (*Bernicla polioccephala*) from South America, purchased; an Anoa (*Anoa depressicornis*) from Celebes, received in exchange; an Axis Deer (*Cervus axis*), a Japanese Deer (*Cervus sika*), a Geoffroy's Dove (*Peristera geoffroyi*), a Wongawonga Pigeon (*Leucosarcia picata*), a Turquoise Parrakeet (*Euphema pulchella*), bred in the Gardens.

OUR ASTRONOMICAL COLUMN

FAYE'S COMET.—Dr. Axel-Möller commences his ephemeris of Faye's comet for the present year on July 1, when its distance from the earth will be 2'05, and that from the sun 2'53; the perihelion passage will not take place till January 22, 1881. The intensity of light corresponding to the comet's distances on July 1 is 0'039; in 1844 it was observed with sensibly the same intensity, the value for the last observation with the 15-inch refractor at Pulkowa being 0'035. The comet attains its greatest brightness in the middle of October, when the value corresponds to that at the last observation in 1858, with the 9'6-inch refractor at Berlin on October 16. At discovery by M. Faye in 1843 the theoretical intensity of light was 0'54, which has not been approached at any of the subsequent returns. The following positions are taken from Dr. Axel-Möller's ephemeris, which is calculated for Berlin midnight, or about 11h. G.M.T. :—

	Right Ascension. h. m. s.	Declination. ° ' "		Right Ascension. h. m. s.	Declination. ° ' "
July 1 ...	23 5 25	+ 7 53'5	July 17 ...	23 13 17	+ 9 34'5
3 ...	23 6 38	8 7'7	19 ...	23 13 57	9 44'8
5 ...	23 7 47	8 21'4	21 ...	23 14 32	9 54'6
7 ...	23 8 52	8 34'8	23 ...	23 15 2	10 3'6
9 ...	23 9 54	8 47'7	25 ...	23 15 27	10 12'0
11 ...	23 10 51	9 0'1	27 ...	23 15 47	10 19'7
13 ...	23 11 44	9 12'1	29 ...	23 16 2	10 26'6
15 ...	23 12 33	+ 9 23'6	31 ...	23 16 12	+ 10 32'8

The comet will arrive at its least distance from the earth (1'09) on October 3. So far as can be foreseen without calculation of the perturbations the comet is not likely to exhibit a degree of brightness approaching that in the year of its discovery by M. Faye, until 1903.

While Faye's comet is followed up by Dr. Axel-Möller in the same admirable manner as for many years past, calculations relating to other comets of short period are in the hands of the

following astronomers according to the last Report of the *Astronomisches Gesellschaft*.—Dr. Backlund of the Imperial Observatory, Pulkowa, proceeds with the perturbations of Encke's comet, taking up the work where it was left by the late Dr. v. Asten; Brorsen's comet is undertaken by Prof. R. Schulze of Döbeln; D'Arrest's by M. Leveau of Paris; Winnecke's by Prof. Oppolzer of Vienna; Tempel's comet of 1867 by M. Gautier of Geneva; Tempel's second comet (1871), by M. Schulhof of Paris; and Tuttle's comet, due in the year 1885, by Mr. Ormond Stone of Cincinnati. The exceptional case of Biela's comet is not provided for.

THE GREAT SOUTHERN COMET OF 1880.—Dr. M. W. Meyer, of Geneva, assuming for the period of revolution of this comet the interval between the perihelion passage of the great comet of 1843 and that of the comet in 1880, corresponding to a semi-axis major of 11'0869, has adapted the other elements of the orbit thereto by means of Dr. B. A. Gould's observations at Cordoba on February 6, 12, and 19, covering an interval which, so far as we know at present, is only one day less than the whole extent of accurate observation; the Cordoba observations of February 5 await the meridional observation of the comparison star, which is not found in our catalogues; it may be well determined at one of the observatories of Southern Europe. Dr. Meyer's results are as follows :—

Perihelion passage, 1880, January 27'4222 G.M.T.

Longitude of perihelion ...	278 22 47	} Mean equinox, 1880'0
ascending node ...	356 16 43	
Inclination of the orbit ...	36 52 13	
Log. excentricity (=log. sine φ) ...	9'9997682	or φ = 88° 7' 41" 55
Log. perihelion distance ...	7'7720095	

Motion retrograde.

The aphelion distance in this orbit is 22'1679 (the earth's mean distance being taken as unity), and at aphelion the comet is distant from the orbit of Uranus 13'15. The nearest approach to the orbit of Jupiter, about 3'1, takes place when the true anomaly is about 176° 35'. The comet's orbital velocity at perihelion is 338 miles in a second, and that at aphelion 477 feet in the same interval.

MINIMA OF ALGOL.—The following times of geocentric minima of Algol, observable in this country during the ensuing quarter, are deduced from the elements given by Prof. Schönfeld in his catalogue of 1875. Considerable perturbations of epoch appear to have taken place during the last five years, as we have previously noted in this column, and from the course of the errors of calculation it seems quite possible that the computed times may be nearly a half-hour too late. Systematic observations of this variable are now much to be desired, and it may be hoped that one or more of the many zealous amateur-astronomers here will devote attention to it. The perturbations to which we have alluded were particularly evident in 1876, and the error of the calculated times attained a maximum in the following year, a mean of seven observations by Prof. Julius Schmidt at Athens showing that the computed epoch was too late by forty eight minutes. The following epochs are directly comparable with observation :—

	h. m.		h. m.
July 16 ...	12 39'0	G.M.T.	Aug. 25 ... 12 47'9 G.M.T.
19 ..	9 27'5	"	28 ... 9 36'4 "
Aug. 2 ..	14 19'6	"	Sept. 14 ... 14 27'7 "
5 ..	11 8'2	"	17 ... 11 27'7 "
22 ..	15 59'4	"	20 ... 8 4'8 "

PHYSICAL NOTES

ACCORDING to our contemporary *l'Electricité*, M. Exner of Vienna has discovered that a bismuth-antimony pair immersed in a gas incapable of acting chemically on either of these metals yields no current when one junction is heated. Also that if two bars of copper are soldered together to form a "pair" no current is produced when either junction is heated in air (as would be expected in a circuit of one metal), not even when both strips are exposed to the action of chlorine; but that if one strip only is exposed to chlorine gas and then one junction be warmed a thermo-electric current is set up. According to Exner therefore, all so-called thermo-electric currents are due to chemical action. It would be easy for some of our ardent young physicists to put to the test this very remarkable announcement, and see whether

it is Herr Exner, or all the authorities on thermo-electricity from Seebeck to Tait, on whom we are to rely for the facts.

In a new capillary electrometer described by M. Debrun in the *Journal de Physique* (May), the microscope is dispensed with, and the requisite sensibility obtained by inclining the tube, which is slightly conical. The capillary tube is bent into a somewhat zig-zag shape, the two turned-up ends opening into larger tubes, and with the mercury in these wires are connected. The support can be turned in a vertical plane, so as to give the middle part of the capillary tube any desired inclination.

M. CROVA commends, for photometric purposes (*Journal de Physique*, May), M. Prazmowski's polariser, which is a Nicol, with faces normal to the axis of the prism, the two halves of which are joined with linseed oil. It requires large pieces of spar, and the joining is long and difficult, but there are several advantages. Thus the layer of oil (unlike Canada balsam), causes hardly any loss of light; its index, 1.485, being nearly equal to the extraordinary index of spar, the polarised field is limited on one side, as in Nicols, where the total reflection of the ordinary ray commences, by a red band; but these cond limit, corresponding to total reflection of the extraordinary ray, is thrown out of the field of vision; the angular value of the polarised field is thus increased. The increase of field, the angular separation of the only coloured band, and the direction of its bases, normal to the axis, are qualities to be appreciated in certain cases.

ACCORDING to some recent experiments of M. Goulier, the coefficient of expansion by heat of a metal is independent of any pressure put upon the metal, and is the same under a stress of traction as under one of compression.

MR. W. P. JOHNSON gives an account in the *Philosophical Magazine* of a new use of the telephone. It is sometimes necessary to grapple and lift a faulty cable, and if it lies in the water along with other cables of similar exterior make it has hitherto been impossible to decide, without cutting it apart, on the identity of the grappled portion. To avoid the obvious evil of having to cut and splice the cable unnecessarily, it is now suggested to employ the telephone on an auxiliary parallel wire in which the induction may be sufficiently strong to enable the electricians in charge to read the signals which may be sent into the cable, and so identify it.

The following pretty experiment, devised by Mr. R. H. Ridout, illustrates the surface tension of mercury. A shallow tray, six inches by three, is supported on three levelling screws, and inclined just so that the mercury does not flow over the lipped edge. If now a small quantity of the liquid be set flowing over the edge it will draw the rest of the liquid over with a siphon-like action. It is difficult, however, to get the surface so clean that no adherent trail should be left, marring the completion of the experiment.

The expansion of glass by heat may be demonstrated as follows:—A glass tube of narrow bore and about eighteen inches long is bent round in the shape of a horse-shoe, so that the free ends are within a millimetre of one another. Between these ends a coin may be held, being nipped between the ends of the rod and held there by the grasp due to the elasticity of the glass. If now the outer portion of the curved part be warmed, the ends open slightly and the coin drops out. This experiment is also due to the ingenuity of Mr. Ridout.

THE phenomenon lately discovered by Hall of the action of a magnet in altering the path of a current of electricity in the conductor which carries it, has formed the starting-point for two investigations, which have appeared separately in the *Wiener Anzeiger*, by Boltzmann and von Ettingshausen respectively, in which they point out that this discovery may be applied to determine the absolute velocity of electricity in a conductor.

M. LOUGHININ has published in the last fascicule of the *Journal of the Russian Physical and Chemical Society* (vol. xii., fasc. 4) a note on his important work on the heat which results from the burning of several alcohols. The substances experimented on are burnt in a jet of oxygen in a glass vessel which is placed in the water of a calorimeter. The figures are: For normal propylic alcohol, 481.6 calories for one molecule; isopropylic alcohol, 479 calories; isobutylic alcohol, 638.6 calories.

#### GEOGRAPHICAL NOTES

MR. CARL BOCK has lately returned to London after his journeys in Borneo, bringing with him a magnificent series of

portraits of the native tribes of that island,—both Dyaks and forest people—taken in water colours. These, we understand, are to be reproduced, at the expense of the Dutch Government, by chromolithography, and will illustrate his report on the journey, which is to be read in the first instance before the Royal Geographical and Anthropological Society of Holland. Pending the publication of this report, Mr. Bock refrains, at the desire of the Dutch Government, from anticipating it in England even by a preliminary sketch. The varieties of type, the methods of adornment, the manner, and to some extent the religion of these distinct races, are all brought out in Mr. Bock's faithful drawings taken from the life on the spot, which form, over and above the objects for which the journey was taken, a splendid contribution to ethnography, the publication of which will be looked forward to with interest; the greater perhaps if Mr. Bock were permitted to give some further slight outline than has already appeared in the pages of NATURE. Mr. Bock has also made an extensive collection of the swords, lances, blowing tubes, and shields (some of the latter covered with human hair), which are used by the natives. He seems to have had the happy knack of making friends of the savages whom others have found murderers, and has brought himself back alive to receive the honour that is his due.

THE current number of the Geographical Society's *Proceedings* opens with the Rev. C. Maples' very interesting paper on Masasi and the Rovuma district between Lake Nyassa and the east coast of Africa. The Rev. C. T. Wilson's and Mr. Felkin's brief notes on Uganda and the journey through the Nile region are also published, and are followed by an account of that rare occurrence in Dominica, a volcanic eruption at the Grand Soufrière, which took place on January 4. The geographical notes include a list of latitudes in Central South Africa, Mr. F. C. Selous' explorations on the Zambesi, &c. (of which full accounts are to be published in a later number), and a journey in Damara-land and beyond the River Okavango. An allusion is also made to Mr. Whymper's ascent of Cotopaxi, and to a proposed exploration of some of the unknown affluents of the Puris. Among the remaining notes is a long account of the country of the Mijjertain Somalis, and of recent exploration in Central Australia. Col. H. Yule furnishes an obituary notice of General Macleod, whose pioneer journey into the interior of the Indo-Chinese Peninsula in 1836-7 is, we fear, now almost forgotten. The map this month is that of the central portion of South Africa, illustrating Dr. Emil Holub's journeys, and constructed in part from his original drawings.

DR. EMIL BESSELS, who was with Hall in the *Polaris*, hopes to undertake a new Arctic expedition in 1881 on funds subscribed in America. He will establish a station at the entrance of Jones Sound, where a scientific staff will be located, consisting of an astronomer, a physicist, a geologist, botanist, and zoologist. Intercourse will be kept up with the settlement of North Greenland by means of a yacht, as well as with the whalers.

SIGNOR CRISTOFORO NEGRI, President of the Italian Geographical Society, and member of the Geographical Society of London, has just published an interesting pamphlet at Genoa, in which he warmly advocates the proposed Italian Antarctic expedition. He demonstrates the importance not only to science, but probably also to trade, of such an expedition. A special circumstance increases the desirability of this Italian Antarctic expedition. In 1882 the transit of Venus will again occur, but after that not again for a hundred years. The Italian expedition, therefore, finding itself in 1882 at some point of the Antarctic circle, would be able to observe this phenomenon under favourable conditions. Signor Negri believes that the expedition might be made with a single vessel at no very extravagant cost, perhaps 600,000 to 700,000 Italian lire. It would spend two winters, returning to La Plata, if necessary, during that period, to re-provision and re-coal the ship.

AT the last meeting of the Russian Geographical Society the Secretary intimated that M. Potanin continues his exploration of North-Western Mongolia. The Society has just received from him a part of his collections, and expects soon to receive his detailed report. M. Tiaghin, who stays on Novaya Zemlya for the exploration of that island, has brought together a very good collection of plants, and has made interesting communications as to the geography of the island. As to new expeditions, the Society proposes to send M. Mereshkovsky to the Crimea for ethnographical and archaeological explorations, and M. Malakhoff to the Middle Ural Mountains for zoogeographical investiga-

tions. M. Maikoff presented a report of the Committee appointed to discuss the subject of a thorough historical and ethnographical exploration of Bulgaria. Col. Lebedeff presented a sketch of the orography of the Balkan peninsula, according to the last geodetical and topographical operations in Bulgaria by officers of the Russian General Staff. The orography of much of the Balkan peninsula has been pretty well studied, a complete trigonometrical report having been completed, and a relief-map on a large scale, like that of the Caucasus, is now in preparation.

A LIVELY controversy having arisen between the cantons of Geneva and Vaud as to the importance of the dam erected at Geneva with reference to the level of Lake Lemman, the *Journal de Genève* has published during the past month a series of papers by M. H. de Saussure on Lake Lemman, the changes of its level, the destructive action of its waves, and generally on its physical conditions. These papers have a great scientific value. We notice also several papers on the same subject published by the *Gazette de Lausanne* in answer to M. de Saussure's articles.

WE notice an interesting note by MM. Polonsky and Meyer on that part of the eastern shore of the Caspian which is described as Tentiak-sor, and is a former lake now transformed into a series of lagoons separated by muddy spaces. Its origin is explained by M. Meyer by a falling of level of the Caspian. Prof. Lenz having made an incision in a rock at Baku in 1830, the subsequent measurements showed that the level stood—in 1837, 1'6 feet lower; in 1847, 0'7 feet higher; in 1848, 1'3 foot; in 1852, 2'9 feet; in 1853, 2'5 feet; and in 1861, 3'9 feet lower than in 1837. This circumstance would be in complete accord with the general diminution of water in all Asiatic lakes, and would perfectly explain a multitude of important physico-geographical phenomena.

HEFT V. of *Petermann's Mittheilungen* begins with an article by C. Marten, on the Inhabited Part of Chili South of the River Valdivia; Dr. Behm gives some collected information on the gold-fields of Wassa, on the Upper Ankobra, north from the Gold Coast; Dr. Junker narrates his journey through the Libyan Desert to the Natron Lakes; and Herr Bernhard von Struve writes on the history of trade-routes in East Siberia. The *Erganzungsheft* No. 61 consists of a physico-geographical account of the Portuguese Mountain group, the Serra da Estrella, with special reference to its forestal conditions, by Herr J. Rivoli. In the June number Dr. A. Regel gives an interesting account of a visit he made last year to Turfan, in Central Asia. Dr. Emin-Bey describes his journey from Dufilé to Fatiko in December, 1878, and January, 1879. Herr Lindemann gives some statistical information on the forests of Bavaria in connection with a map of the Bavarian Spessart. Herr E. R. Flegel gives a detailed narrative of his journey in the *Henry Venn* in July and August last year, up the Binué, from Gandé to Djen.

THE *Japan Mail* states that development in the trade between Japan and Corea is confidently anticipated in consequence of the opening of the port of Gensan. The Japanese residents at Fusan, in the south of the Korean peninsula, are said already to exceed 14,000 in number, and we may therefore hope that we shall soon have more detailed information regarding the interior of the country than has hitherto been accessible.

THE Melbourne correspondent of the *Colonies and India* states that Mr. White, of the Reed Beds, near Adelaide, has fitted out the schooner *Elsa*, and has left on an exploring cruise to New Guinea for the purpose of making natural history investigations, which are expected to occupy two years.

IN the introduction to his lately published report on the trade and commerce of the Caucasian Provinces, Mr. Lyall, H.B.M.'s Consul for Tiflis and Poti, gives a succinct account of the geographical features of this region, accompanied by remarks on its climate, resources, communications, &c. Though the information is not perhaps entirely new, it is interesting to be able to take in at a glance so much relating to a tract of country which is daily becoming more and more important.

COL. FLATTERS, who had left Wargla on March 15 with a column of 100 men for an exploration in connection with the intended Trans-Algerian Railway, returned to Wargla on May 20, after having travelled 600 miles in the direction of Raof, without meeting any opposition from the natives. He intends to resume his explorations in the months of September or October, in another direction. He was unable to discover the Ighorghor Wed, which is marked on every map.

FROM August 5 to 10 next the French Geographical Society will meet at Nancy for their triennial meeting.

WE have received Parts 12 to 16, each containing three maps, of the new edition of Stieler's "Hand-Atlas."

THE Russian Department of Estates has just published an interesting atlas of six maps, representing the distribution of soils in Russia. The atlas is accompanied by a text by M. Dokoutcheeff. The maps were drawn five years ago by M. Tchaslavsky, who has studied this subject during many years.

### THE ROYAL OBSERVATORY

THE following are the points that seem to us of most interest in the Report of the Astronomer-Royal to the Board of Visitors at their recent Visitation:—

The Admiralty have decided not to proceed with the erection of a new library at present, though the space has been cleared, admitting of the erection of a building fifty by twenty feet. The Astronomer-Royal proposes to erect here a room of one story, but with galleries at mid-height, so that there would never be need to use a ladder. Among other changes occurring in this clearance, he has removed the electrometer mast (a source of some expense and some danger); the perfect success of Sir William Thomson's electrometer rendering all further apparatus for the same purpose unnecessary. With regard to the library the Report states that no change has been made in plan, but in some departments the number of books has increased rapidly. "Fundamental astronomy advances slowly, magnetism is almost stationary, geodesy progresses, photography and spectroscopy increase very fast, and meteorology the most rapidly of all. The Transactions of foreign Academies increase in number. This is owing, I imagine, to the general scientific activity, both of Academicians and of private men of science, in most foreign countries, and to the facilities given for transmission, by the courtesy of publishers and by the extension of book post."

Under the head of Astronomical Observations, the Report says: "The sun, moon, planets, and fundamental stars are the regular subjects of observation on the meridian, special attention being devoted to the moon, which is also observed at every available opportunity with the altazimuth. Other stars are observed from a working catalogue of about 2,500 stars, with which good progress has been made in the past year, though a large number of stars still remain for observation. About 1,100 stars were observed in 1879." Between May 20, 1879, and May 9, 1880, the following observations were made:—With the transit circle 4,164 transits, the separate limbs being connected as separate observations; 3,953 circle-observations; with the reflex-zenith tube, 23 pairs of observation of  $\gamma$  Draconis; with the altazimuth, 713 azimuths of the moon and stars and 352 zenith distances of the moon. A set of micrometer-measures of the outer satellite of Mars and several sets of measures of the satellites of Saturn, were obtained last autumn with the south-east equatorial, and a few drawings of Mars and Jupiter were made near the time of opposition. A remarkable proof of the exceptionally bad weather of last summer is found in the fact that in July it caused the loss of a whole month's observations of the sun.

Under the heading of Spectroscopic and Photographic Observations we find the following statement:—"The sun's chromosphere has been examined on thirty seven days during the period to which this Report refers, and on thirty-four days prominences were seen. Whenever practicable, the appearance of the prominences as seen on each of the chromospheric lines has been recorded, and on four days a detailed examination of the whole spectrum of the chromosphere was made at twenty-four points of the sun's limb. Three sun-spots have been examined with reference to the broadening of lines in their spectra, and fifteen photographs have been taken of the spectra of three sun spots. As regards the spectroscopic determination of star-motions, 113 measures have been made of the displacement of the F line in the spectra of 29 stars, 44 of the  $b_1$  line in 19 stars, and 6 of the  $b_2$  line in 3 stars. Of these 51 stars 21 had not previously been examined. In the case of three of the stars a dispersive power equivalent to that given by fifteen prisms of 60' was used. The stars are taken from a working list of 150 stars, which may eventually be extended to include all stars down to the fourth magnitude, and it is expected that in course of time the motions of about 300 stars may be spectroscopically determined. The spectra of comets *c* (Swift's) and *d* (Palisa's)



1879, and of the red spot on Jupiter, have been examined, but no certain results were obtained. Between 1879, May 20, and 1880, May 9, photographs of the sun were taken on 145 days, and of these 270 have been selected for preservation. The photographs show a complete absence of spots on 64 days out of 145, whilst in the preceding year there was a similar absence of spots on 121 days out of 150. The epoch of minimum appears to have occurred about the beginning of 1879, and since last October the outbreak of spots has been very marked." Various spectroscopic and photographic results, it is stated, have been communicated to the Committee on Solar Physics, with whom, the Report states, the Observatory is in friendly communication.

Under Magnetical and Meteorological Instruments we are told that the Thomson electrometer is in excellent order. "In the warm weather of summer, and in winter when much artificial heat is used in the basement, the photographs have been unsatisfactory, but we are endeavouring to remedy this by cutting off all communication with air from the basement. In the winter the register was frequently interrupted by the freezing of the water in the exit-pipe. A basin (with cesspool) has been recently constructed to carry off the water discharged from this pipe. The action of the photographic barometer appears to have been improved by the slight changes mentioned in the last Report, and small movements are in many cases excellently shown. A new pressure-plate with springs has been applied by Mr. Browning to Osler's anemometer, and it is proposed to make such modification as will give a scale extending to 50 lbs. pressure on the square foot. Other parts of the instrument have also been renewed. An arrangement for slow motion of the barrel, which was much wanted in adjusting the recording paper, has been fitted to Robinson's anemometer. It is in contemplation to alter the photographic cylinders of the magnetometers, barometer, thermometers, and earth-currents apparatus, so as to make the time-scales of all the magnetical and meteorological instruments the same."

Some interesting information is given under the head of Reduction of Magnetical and Meteorological Observations.

The following are given as the principal results for magnetic elements in the year 1879:—

Approximate mean westerly declination ... ..	} 18° 40'
Mean horizontal force ... ..	} 3'911 (in English units). 1'803 (in Metric units).
Mean dip ... ..	} 67° 36' 5" (by 9-inch needles). 67° 36' 54" (by 6-inch needles). 67° 37' 47" (by 3-inch needles).

"On the application of the Committee on Solar Physics, the separate daily values of the diurnal range of magnetic declination for the years 1848 to 1858 have been supplied to Prof. Balfour Stewart."

The Report goes on to say:—"The Visitors at their last meeting suggested the advantage of preparing a digested account of the magnetical results obtained at the Royal Observatory from 1841 to 1876, similar in some respects to the account of meteorological results recently published. A beginning was made by preparing the monthly means of diurnal inequality in force and direction through the whole period, and exhibiting their combination in curves. It is known to the Visitors that, in two communications to the Royal Society, I have exhibited numerically and in curves the means of these monthly results (yearly means through all months, and monthly means through all years) as far as the year 1863. In 1864 observations were interrupted by the work in progress for the magnetic basement, so that the reductions now to be made commence with 1865. The monthly results through the whole period being taken as before, the next step, for obtaining exhibitions which the eye and the mind could easily command, was to collect the monthly conclusions into a limited number of groups of years. On inspecting the monthly curves in detail there was no hesitation in fixing upon the following:—First group, 1865 to 1868; second group, 1869 to 1872; third group, 1873 to 1876. In each of these, as before, yearly means are taken through all months, and monthly means through all years. The curves in the second group are strikingly larger than those in the first and third; the linear dimensions of the curves of 1870 are fully  $\frac{2}{3}$  of those of 1876 in the east-and-west direction, and fully  $\frac{1}{2}$  in the north-and-south direction. In the study of the forms of the individual curves; their relations to the hour, the month, the year; their connection with solar or meteorological facts; the conjectural

physico-mechanical causes by which they are produced; there is much to occupy the mind. I regret that, though in contemplation of these curves I have remarked some singular (but imperfect) laws, I have not been able to pursue them. The heavy load on the Observatory, and the limited means (in the present year) of supporting it, will in part explain this."

Under "Chronometers, Time-signals," &c., we are told that during the period to which the Report refers the error of the Westminster Clock exceeded 1s. on 120 days; on 32 of these it was between 2s. and 3s., on 4 days between 3s. and 4s., and on 1 day it exceeded 4s.

"I have reason to believe," the Astronomer-Royal states, "that the use of the time-signals, originating at the Royal Observatory, and distributed automatically from the General Post Office, is becoming more and more extensive, and it seems probable that the same system may be adopted by foreign nations. Very lately an examination of our instruments was made on the part of another country, with the view of establishing something similar in one of their maritime cities; and it was intimated that Greenwich time would probably be used as standard. The establishment of time-balls, &c., at foreign ports is increasing."

With regard to the progress of the operations in connection with the transit of Venus, 1874, it is stated that permission was given by the Treasury to Major Tupman last September to devote his time to the work till the end of June, 1880. The result is (taking the stations or station-groups in the order which the Astronomer-Royal proposes for publication): the observations and calculations of the Sandwich or Hawaiian group are completed; those of the Egyptian group nearly finished; those of Rodriguez completed; those of Kerguelen nearly finished; and also those (which unfortunately are less important) of New Zealand. "In January of the present year I received through the Admiralty the notification of the Treasury that the printing of the observations and calculations might proceed. It has gone on rather languidly; but I have before me in type 128 pages, including the text and the greater portion of the tabular part of the Honolulu work. I propose to take steps for urging on this printing."

"With regard to the transit of 1882," the Report goes on to state, "I have lately placed a memorandum before the Royal Astronomical Society. From the facility with which the requirements for geographical position are satisfied, and from the rapid and accurate communication of time now given by electric telegraph, the observation of this transit will be comparatively easy and inexpensive. I have attached greater importance than I did formerly to the elevation of the sun. For the four principal phases (ingress accelerated, and retarded; egress accelerated, and retarded) I propose to rely mainly on: 1st, the Cape Colony; 2nd, the shores of Canada and the United States, Bermuda, and the West India Islands; 3rd, the same as the 2nd; 4th, the eastern shore of Australia, or New Zealand in preference if telegraph communication be made. I remark that it is highly desirable that steps be taken now for determining by telegraph the longitude of some point of Australia."

The Astronomer-Royal makes the following statement in reference to his own lunar theory:—"The general principle of this is: to adopt for correction the best existing theory; to compute with the severest accuracy the numerical values of the terms produced geometrically by the tabular coefficients, and also the terms really due to the forces which produce them; and to remove the differences between these by corrections of the tabular coefficients, for which corrections proper factors are prepared. It was a special object with me to avoid the use of powers of *m* (a symbol well known to lunar theorists), and to give easy means of computing, not new absolute values, but corrections of existing numerical coefficients (a principle which I have adopted extensively in other branches of astronomy) and also of computing the effect of small external disturbances or small changes of force. Both these are obtained by my process. The heaviest part of the work is the severe computation to which I have alluded, and this is done entirely by junior computers. The calculations had been carried out in every part to the accuracy of 10<sup>-7</sup>; but for securing the degree of accuracy which I proposed it was found necessary to extend many parts to 10<sup>-8</sup>, and some to 10<sup>-9</sup>. This has caused a very great addition to the labour, but the work has advanced well, and will, I trust, be finished ere long. While waiting for this, which is to give the correction to every coefficient of the ordinary lunar theory, I am employing myself partly in rearranging the whole work for

publication, and in putting calculations in order for that correction of coefficients; and partly on three ramifications or supplements of the theory relating to the effect of the earth's oblateness, the effect of change of position of the ecliptic plane, and the effect of change of eccentricity of the earth's orbit, and lunar acceleration. The last of these I have completed to my satisfaction, requiring only an examination of the external factor; the two others are progressing. The Admiralty have assisted me, on estimates, with a moderate grant (of amount named by myself), but much of the expense has been private."

The Report concludes as follows:—"After the details into which I have entered as applying to the present state of the Observatory, and after the remarks which I have made in the two reports last preceding on the question of reduction of printing (which at some fitting time I would willingly again present to the consideration of the Visitors), and the note in the last report on the increase of annual expense, I have only to place before the Visitors, but for no immediate expression of opinion, the impression which frequently weighs upon me as to the ulterior organisation of the Observatory. The determination of places of stars, sun, moon, and planets, was handed down to me from my predecessors; it has in various ways been much extended. The magnetic and meteorological observations (the first originating with myself, the second partly with the movement introduced by the Royal Society and partly by myself) constituted a distinct branch of science, having this property in common with the original astronomical work, that it is incessant and regular. The much later introduction of photographic and spectroscopic astronomy, established at the instance of the Board of Visitors, and carried on with vigour and regularity, has created a third department. All these departments appear at present to be working efficiently and well. But I can easily imagine circumstances which would interfere materially with the successful continuation in one place of this triplicate series of observations. Though I think this possibility of partial failure worthy the contemplation of the Visitors, yet I do not see any necessity for action of any kind at the present time."

#### INTERCOLONIAL METEOROLOGICAL CONFERENCE AT SYDNEY

A METEOROLOGICAL Conference was held at Sydney in November last, the representatives of the different Colonies being Messrs. James Hector for New Zealand, Charles Todd for South Australia, R. L. J. Ellery for Victoria, and H. C. Russell for New South Wales, the last-named gentleman being chairman. The most cordial unanimity characterised the meeting, which lasted from the 11th to the 14th of the month, and the resolutions arrived at with a view to secure united action in their meteorological investigations and uniformity in the methods and times of observing and forms of publication augur well for the future of meteorology in the Australian Colonies. The whole question of weather telegrams was under anxious consideration. The system in present operation embraces only the Colonies of South Australia, Victoria, New South Wales, and Queensland, but a resolution was passed declaring it desirable to secure the co-operation of the Governments of Western Australia, Tasmania, and New Zealand in the system of inter-colonial weather telegrams. The facts pointed out by Mr. Todd as to the great regularity observed by the atmospheric disturbances in pursuing a course from west to east, and the statement by Dr. Hector that early notices could be sent from Queensland of the origin and progress of the dangerous and suddenly occurring cyclones that cross the northern part of New Zealand, sufficiently attest the practicality of the system of weather warnings and their practical value. For instance, the great storm which wrecked the *Dandnong* in September, 1876, could have been telegraphed in sufficient time to have prevented the great loss of property which took place at the different ports along the coast of New South Wales. We have the greatest pleasure in noting a deliverance by the Conference to the effect that weather telegrams and forecasts shall in all cases depend upon the observations used for general meteorological and climatological statistics. Much emphasis was laid on the establishment of high-level stations with a more special view to the investigation of the winds; and the Conference recommended that there be established in each of the Colonies, upon a high mountain peak, a meteorological observatory for the special study of winds and other meteorological phenomena, the most desirable positions being Mount Lofty, in South Australia, 2,500 feet high; Kian-

dra, in New South Wales, 4,600 feet; Mount Wellington, in Tasmania, 4,000 feet; Mount Macedon, in Victoria, 3,500 feet; and in New Zealand, Tauhara Taupo, 4,600 feet, and Mount Herbert, 4,000 feet. We hope that the Governments of the different Colonies will vote the small sums which are required to carry out the resolutions of the Conference, the giving practical effect to which will certainly confer substantial advantages on commercial, shipping, and other interests, and contribute materially to a more satisfactory development of the meteorology of this important part of the globe.

#### UNIVERSITY AND EDUCATIONAL INTELLIGENCE

CAMBRIDGE.—At St. John's College Prof. Living has been elected to a foundation fellowship, and Dr. Kennedy, Prof. Sylvester, F.R.S., and Prof. Churchill Babington were elected honorary fellows of the society.

The following awards for proficiency in natural science have been made at St. John's College:—A Foundation Scholarship to Samways; a Proper Sizarship to Love, and Exhibitions to Hart (already scholar), Weldon, Edmunds, Love, T. Roberts. Fleming was awarded one of the Hughes Prizes, given to the two most distinguished third-year students in any branch of study, and a Wright's Prize, with augmentation of the year's emoluments to 100*l*. The Open Exhibition was awarded at Easter to Scott-Taylor (City Middle-class School, Cowper Street), and a second Exhibition to Clementson (Newcastle-under-Lyme).

We understand that Mr. W. J. Lewis has been appointed to perform the duties of Professor of Mineralogy at Cambridge until the close of the year, the period to which the election to the chair has been postponed by the University Commissioners.

#### SCIENTIFIC SERIALS

*Zeitschrift für wissenschaftliche Zoologie*, May.—Prof. Zygmont Kahane, on the anatomy of *Tenia persiciata*, Göze, as a contribution to the knowledge of the Cestoids, with a plate and a woodcut. The actual facts recorded in the paper were originally laid before the Academy of Sciences of Krakau in May, 1878, and were afterwards published in a somewhat altered form, in the Polish tongue, in their *Proceedings*. The investigations were carried on during the summer and autumn of 1877 in the Zoological Institute at Leipzig, under the supervision of Prof. Leuckart. The history of the species is treated at length, and the paper extends over seventy-seven pages.—Dr. G. Haller, Contribution to a knowledge of the Tyroglyphidae and their allies, with three plates: describes a new species of *Listrophorus* (*L. faqenstcheri*): On the genus *Homopus*, Koch. It is not an independent genus, but the forms are only the larval stages of *Dermacarus*, which is described as a new parasitic genus; *Tyroglyphus megmii* is described as a new species. There is a sketch of a delineation of the internal anatomy of *Tyroglyphus* and *Dermacarus*, and of the egg in these genera.—Prof. Ludwig Stieda, on the structure and development of the *Bursa fabricii*, with five woodcuts.—Dr. Hubert Ludwig, on the primary sand canal in the Crinoids, with some remarks on the comparative anatomy of the Echinoderms in general, with two plates.—Dr. H. Ludwig, new contributions to the anatomy of the Ophiuroids, with three plates.

*Journal de Physique*, May.—Measurement of the electromotive forces of batteries and electromotive forces of contact of metals, by M. Pellat.—Study of polariser prisms used in photometric observations, by M. Crova.—On the illumination of electrodes, by M. Colley.—On a new capillary electrometer, by M. Debrun.—To determine with the aid of an articulated system the conjugate points of an optical system, by M. Elie.

*Archives des Sciences Physiques et Naturelles*, May 15.—On the earths of samarskite, by M. Mariñnac.—Researches on the condensation of gases on the surface of glass, by M. Chappuis.—The Siemens machine and its application to transmission of force, by M. Achard.—Specific heat, latent heat of fusion, and point of fusion of various refractory metals, by M. Violle.

The *Reale Istituto Lombardo di Scienze e Lettere, Rendiconti*, vol. xiii., fasc. iv. and v.—The phylloxera considered in rural economy, by S. Cantoni.—Geological notes on the basin of Lake d'Orta, by Dr. Parona.—Health and beneficence; their mutual relations, by Dr. Zucchi.

Fasc. vi. and vii.—On the convenience of forming national nurseries of vines resistant to phylloxera, by S. Trevison.—On the chronological determination of Lukanese porphyries, by Prof. Tarantelli.—On the fundamental equation in the theory of linear differential equations, by Prof. Casorati.—Representation on punctuated space of some forms of the third species composed of straight lines, by S. Archieri.—On the institution of two new genera of arachnida, by Prof. Pavesi.—Electricity and earthquakes, by S. Serpieri.—List of algæ of the province of Pavia, by Dr. Cattaneo.—Second case of peritoneal transfusion with good success in an oligocitæmic insane person, by Profs. Colgi and Raggi.—On a transformation of the fundamental equations of hydrodynamics, by Prof. Paci.

THE *Revue Internationale des Sciences Biologiques*, May, contains:—E. A. Schaefer, on the development of animals.—Carl Hoberland, infanticide among the ancients and the moderns.—L. Pasteur, on the cholera morbus in fowls; on virulent maladies and on vaccination.—M. Debierre, man before and on the threshold of history, a study of palæontological facts and of comparative archæology and philology.—Notice of learned societies.—The Academy of Sciences, Paris.—The Academy of Sciences, Amsterdam.—The Anthropological Society of Paris.

*Morphologisches Jahrbuch*, vol. vi., part 2.—Dr. A. Rauber continues his articles on the evolution of form and its transformations in the development of vertebrata, reaching its second section, on the multiplication of axes, pp. 56, with four plates and seven woodcuts illustrating various early stages of monstrous double-axial structures in various species of *Salmo* and *Gallus*.—Dr. J. Brock occupies 112 pages, illustrated by two plates, in endeavouring to establish a satisfactory phylogeny of the dibranchiate cephalopods.—Dr. H. von Thering contributes, on the vertebral column of *Pipa*, to the homology of its individual vertebrae and nerves with those of other anura.—Smaller contributions by Prof. Gegenbaur and by C. Rabl (on Planorbis development).—Reviews of German text-books of anatomy.

*Gazzetta Chimica Italiana*, Fasc. iii. and iv.—On the ulmic matter obtained from sugar by action of acids, by S. Sestini.—On some derivatives of  $\beta$ -chlorobutyric acid, by S. Balbiano.—The diffusion and physiological state of copper in the animal organism, first announced by Bartolomeo Bizio, and elucidated by Prof. Giovanni Bizio.—Notice on the chemical constituents of *Stereocaulon vesuvianum*, by S. Paterno.

*Bulletin of the United States Geological and Geographical Survey of the Territories*, vol. v. No. 3, November 30, 1879.—J. A. Allen, on the species of the genus *Bassaris*.—W. H. Patton, the American Bembecidæ tribe Stizini; list of a collection of Aculeate Hymenoptera from North-Western Kansas; Generic arrangement of the bees allied to *Melissodes* and *Anthophora*.—George B. Sennett, further notes on the ornithology of the Lower Rio Grande of Texas, made during 1878, with annotations by Dr. E. Coues.—Henry Gannett, additional lists of elevations. Among these is a list of the mountain-peaks forming the Cordilleras of North America and of their passes.—Dr. Morris Gibbs, annotated list of the birds of Michigan.—Dr. Le Conte, the coleoptera of the Alpine Rocky Mountain Regions, Part 2.

## SOCIETIES AND ACADEMIES

### LONDON

Royal Society, May 27.—“On the Structure and Development of the Skull in the Batrachia. Part III.” by W. K. Parker, F.R.S. (Abstract.)

Some of the work brought forward in this paper was in hand before the first part was in print. That initial piece of work dealt only with the formation of the skull in the common frog, but it was followed by another which appeared in the *Philosophical Transactions* in 1876, which treated of the skulls of the common and of the “aglossal” toads.

Of the latter types only two kinds are known, viz., the nailed toad of the Cape (*Dactylethra*), and the monstrous toad of Surinam (*Pipa*). All the bulk of the Batrachia are included in the sub-group “Opisthoglossa.” These have a tongue, and in most cases it is free behind and not in front; the “Proteroglossal” Batrachia are very few in number, and the character itself (as Dr. Günther informs me) is not well pronounced.

I have now worked out the skull, in one or more stages, in about a *tithe* of the known species, and in my second paper in

both of the aberrant (“aglossal”) types; in them this was done in various stages.

I am not aware that there is any “order” of any “class” in the Vertebrata where so large a percentage of species has been, or indeed *need be*, worked out, either in the skull or in any other part of their organisation.

That which calls for it here is the great and unlooked-for polymorphism of the species; I may explain this by saying that the skull, in really important modifications, differs more in the species of some of the genera than it does in the orders of some of the classes. As an instance, it would be no easy thing to find a malacopterous fish differing from an acanthopterous type, in deep-seated essential matters, so much as the common toad does from the other native species, viz., the *Natterjack*; and the common frog has only about half as many cranial elements as the bull-frog of North America.

If the metamorphosis of a single species be worked out exhaustively, it gives a range of structural characters which rises up from a larval creature on the level of the lampreys to a reptilian form not far below the Chelonia, and evidently related (obliquely, not genetically) to that “order.”

Moreover, whilst the “opisthoglossa” have larvæ with suctorial mouths, and a quasi-*petromyzine* structure altogether, the larvæ of the “aglossa” need only to be arrested as larvæ and to acquire a dense bony armature to be very close counterparts of the most *bizarre* forms of the ganoids of the “old red sandstone,” such as *Pterichtys* and *Coccoseus*.

The Batrachia show some remarkable things in their metamorphosis, both as to the *size* their larvæ obtain and the *time* during which metamorphosis is taking place.

In the bull-frog (*Rana pipiens*) the larvæ attain the length of about 5 inches, and take two or three years for their transformation; they may be hindered in this, and be made to take twice that time. In these the larvæ bear a moderate relation, as to size, to the adult form, which may be 7 inches long, although tailless.

But in a frog from the neotropical region (*Pseudis*) scarcely larger than our native form, the tadpole attains the length of nearly a foot, the tail acquiring a breadth of 4 inches.

As zoologists well know, it is easy to procure *tadpoles* of this species, but very hard to get an adult. I am of opinion that the adult condition is not attained until after many years; and it suggests itself to me that this species may be the not remote descendant of a type which did not finish its *anural* metamorphosis.

On the other hand, some of the neotropical forms have very small tadpoles. *Bufo chilensis*, a large toad, has them about half the size of those of our common native Batrachia, and the newly-metamorphosed individuals are no larger than a house-fly.

But in *Pipa* the small larvæ are thoroughly metamorphosed in the maternal dorsal pouches, and at first only do they show a trace (and only a trace) of branchial tufts.

These tadpoles, which never see the light as such, have wide mouths (not suctorial), and so also have the tadpoles of the other waif of the sub-order “Aglossa,” viz., *Dactylethra*. In that kind, however, the larvæ become large, and are a long while undergoing their transformations, which take place in the water, according to rule.

In the skull of the adults much variation is evidently due to the different *size* to which the species attains; some, as the bull-frog, are as large as the common Greek tortoise; others grow scarcely larger than a bluebottle fly. As a rule these small kinds show two kinds of modification: they are apt to retain certain larval characters, and they are apt to acquire generalised characters such as do not normally appear in this group, which is very remarkable for the *fewness* of the parts or elements composing the adult skull.

Some of the large forms, as *Rana pipiens*, have many investing bones in their skull, such as must be looked for again in archaic and extinct types, whilst others, as *Ceratophrys* and *Alyptoccephalus*, have a cranial armature that is dense, extended, and almost “ganoid;” this kind of skull, however, is found in middle-sized types also, as in *Pelobates* and *Nototrema*.

In the terminal suctorial mouth of the larva of the Opisthoglossa the mandibular pier and its free “ramus” are carried to the front of the head. After transformation, in the larger kinds, the gape is carried behind the head, as in the crocodile; it can be guessed how much modification such a change as this will necessitate.

But it is evident that a low suctorial fish, such as the *tadpole*

is, must have altogether a totally different kind of skull and skeleton to that of an active, noisy, intelligent, more or less terrestrial reptile, such as the frog becomes.

This necessarily great change involves some very curious and instructive *anachronisms*, so to speak, in the appearance of various parts and organs.

A low suctorial fish would have no fenestra ovalis or stapes, and in the tadpole it is some time before these appear.

The low (urodelous) Amphibia have, in most cases, the upper hyoid element suppressed, sometimes it is present, serving as a rudimentary "*columella auris*."

In most Batrachia this part does not appear until after transformation, and in some kinds not at all. This part especially shows how the *individual* is gradually changed, and makes it clear why so many variations should occur in genera and even species.

With regard to the geographical distribution of the Batrachia, there are many things of importance which I have rather hinted at than expressed in this paper.

There is a sort of *facies* or character about the allied types of any great geographical region which makes me satisfied that certain external characters repeat themselves again and again in different parts of the world.

Thus the types of frogs that have dilated toes are evidently more nearly related to those with pointed toes of the same region than they are even to the broad-toed types of some distant region.

I should be inclined to derive the *narrow-backed* tree-frogs of Australia from the sharp-toed frogs of the same region; the same with those of India, and the same with those of the nearctic and neotropical territories.

The *true* frogs ("Ranidæ") of India have many things in common, as also have the true frogs of North America; in the same may be said of the sub-typical frogs, or "Cystignathidæ."

On the whole the European and Indian territories yield the highest kinds; Australia and South America the lowest and most generalised.

**Mathematical Society, June 10.**—Mr. C. W. Merrifield, F.R.S., president, in the chair.—The following communications were made:—On a binomial biordinal and the arbitrary constants of its complete solution, by Sir J. Cockle, F.R.S.—On the focal conics of a bicircular quartic, by Mr. H. Hart, M.A.—Preliminary note on a generalisation of Pfaff's problem, by Mr. H. W. Lloyd Tanner, M.A.—On the resultant of a cubic and a quadric binary form, by Prof. Cayley, F.R.S.—On the theory of the focal distances of points on plane curves, by Mr. W. J. Curran Sharp, M.A.—Geometrical note, by Mr. H. M. Taylor, M.A.

**Linnean Society, June 3.**—Prof. Allman, F.R.S., president, in the chair.—The secretary read a paper on the specific identity of *Scomber punctatus*, Couch, with the *S. scomber*, Linn., by Dr. Francis Day. The specimen on which this opinion is founded was captured on the coast of Cornwall in April last.—In a note on the anal respiration in the zœa larva of the decapods, by Marcus M. Hartog, he shows from an examination and study of living larvæ of *Cancer* that the terminal part of the rectum is slightly dilated, and possesses a rhythmic contraction and expansion duly associated with opening and closing of the anus. A clue to the ultimate transference of branchial respiration may perhaps be found in the Entomostraca, where in certain forms food is obtained by a current from behind forwards due to the movement of the setose or flat limbs immediately behind the mouth. Prof. Claus has shown that in *Daphnia* the said limb processes have a respiratory function, while this animal also possesses a well-marked anal respiration.—Mr. G. Murray made a communication on the application of the result of Pringsheim's recent researches on chlorophyll to the life of the lichen. Summarising Pringsheim's labours and taking into consideration the views of Vines, Geddes, and Lankester, Mr. Murray arrives at the following conclusion:—That we have in lichens fungal tissues as the body of the thallus and the chlorophyll screen in the gonidial layer; that is, the chlorophyll is in one system of cells and the protoplasm apparently affected by it in another, which is in contact. The light which traverses the chlorophyll containing gonidial layer excites in the fungal tissues the decomposition of carbonic acid.—Mr. P. Herbert Carpenter, in giving the results of some researches of his in the form of a paper on the genus *Solanocrinus*, Goldfuss, and its relations to recent *Comatule*, stated that Schluter was perfectly justified in uniting *Solanocrinus* with

*Antedon*. The latter author does the same with *Comaster*, though to Mr. Carpenter, Goldfuss's description of this type appears to differ so much from all other *Comatule* that he prefers provisionally to regard it as distinct. Mr. Carpenter's researches on the erinoids in question are based on material obtained from the *Challenger* Expedition and a study of the fossil forms contained in the Woodwardian (Cambridge) and British Museums; he thus finds, on comparison of the living with past Jurassic, Cretaceous, and Tertiary forms, that variations in the development of the basals are useless as generic distinctions.

**Chemical Society, June 3.**—Prof. H. E. Roscoe, president, in the chair.—It was announced that a ballot for the election of Fellows would take place on June 17. The following papers were read:—On some products of the oxidation of paratoluidine, by W. H. Perkin. The present paper contains a study of the action of chromic acid on the above substance. Some beautifully crystallised products were obtained; one having the composition  $C_{10}H_{11}N_3$ , melting at  $216 - 220^\circ$ , and giving a magnificent blue colour with sulphuric acid; it has the characters of a base; a second base, rather less soluble, melting at  $175^\circ$  was also separated; it has the formula  $C_{10}H_{17}N_3$ . By using glacial acetic as a solvent for the chromic acid in the above reaction paratoluene was formed.—On the detection of foreign colouring matters in wine, by Dr. A. Dupré. The true colouring matter does not dialyse; all the artificial colouring matters except alkanet dialyse freely, so that cubes of gelatine jelly soaked in the wine for forty-eight hours become scarcely tinged below the surface if the wine is pure, but if coloured with magenta, &c., the cube is stained to the middle. Alkanet is easily recognised by its absorption spectrum.—On the action of organozinc compounds upon nitrites and their analogues. I.—Action of zinc ethyl on azobenzene, by E. Frankland and D. A. Louis. In this reaction anilin is formed, much gas being evolved, consisting of 3 vols. of ethylene to 1 vol. of ethylic hydride. 70 gm. of anilin were obtained from 80 gm. of azobenzene.—II. On the action of zinc ethyl upon benzonitrile, by E. Frankland and J. C. Evans. Cyaphenine was the principal product of this reaction; this substance, by the action of strong hydrochloric acid in a sealed tube at  $250^\circ$ , is converted into benzoic acid and ammonia.—On the relation between the molecular structure of carbon compounds and their absorption spectra, by Prof. W. N. Hartley. The author has photographed the spectra of various substances; he concludes that no molecular arrangement of carbon atoms causes selective absorption, *i.e.*, gives absorption bands, unless three pairs of carbon atoms are doubly linked together in a closed chain. The most remarkable substance in this respect is anthracene, which, when diluted one in 50,000,000, gives a considerable and distinct absorption.—On a simple method of determining vapour densities in the barometric vacuum, by C. A. Bell and F. L. Teed. It consists of a modification of Hofmann's apparatus.—Mr. C. T. Kingzett made a verbal communication to the effect that he had recently investigated the question of the slow oxidation of moist phosphorus in air, and had obtained evidence that both ozone and hydroxyl were formed.

**Zoological Society, June 1.**—Prof. W. H. Flower, F.R.S., president, in the chair.—Mr. Sclater made some remarks on the principal objects he had noticed during a recent inspection of the Zoological Gardens of Berlin, Hamburg, Amsterdam, the Hague, and Antwerp.—The Secretary exhibited a spider of the genus *Tegenaria*, which had been forwarded to him from Cape Town by Mr. J. H. Payne, of that place. It had been taken within three miles of Cape Town, on the back of a horse, which had subsequently died, as it was said from the effects of the bite.—Mr. G. E. Dobson exhibited some new and rare species of bats, amongst which was an example of a new species of the genus *Megaderma*, from Australia, proposed to be called *Megaderma gigas*, and remarkable for its large size.—Mr. Dobson made some further remarks as to the date of the receipt of the Dodo bones exhibited by him at a former meeting.—Lord Lilford exhibited and made remarks on some nests and eggs of the Flamingo, which had been taken in the marshes of the Guadalquivir, below Seville, in April, 1879.—Lord Lilford also exhibited some fine hybrid pheasants, between males of Reeves's pheasant and hens of the common pheasant.—Mr. E. W. H. Holdsworth read a note on the distribution of the crayfish (*As-tacus*) in Spain.—Prof. F. Jeffrey Bell read a paper on some species and genera of the *Tennopleridæ*, in course of which he described the method he had adopted in comparing different species, and species at different stages in growth; he also directed

especial attention to the differences in the size of the generation pores in *Amblypneustes formosus*, and discussed the specific characters of *Salmacis globator*.—A communication was read from Dr. A. Günther, F.R.S., containing notes on a collection of mammals from Japan.—Mr. G. E. Dobson read a description of a new species of bat, of the genus *Natalus*, from Jamaica, which he proposed to name *N. micropus*.—Mr. A. W. E. O'Shaughnessy read the description of a new species of lizard of the genus *Uromastix*, from Zanzibar, which he proposed to call *U. princeps*.

**Geological Society, May 26.**—Robert Etheridge, F.R.S., president, in the chair.—Prof. Frederick Guthrie, F.R.S., Rudolf Hænsler, Ph.D., James Hulme, William Jolly, Charles Myhill, and Alfred George Savile, were elected Fellows of the Society.—The following communications were read:—The pre-carboniferous rocks of Charnwood Forest (Part III.; conclusion), by Rev. E. Hill, M.A., F.G.S., and Prof. T. G. Bonney, F.R.S.—In their former communications the authors had paid less attention (from want of time) to the northern part of the forest than to the rest. This district has during the last two years engaged their special attention. They had provisionally retained the name quartzite for the rocks exposed about Blackbrook, &c., probably the lowest visible on the forest. This name proves to be inappropriate, and they propose to call the group, which contains much fine detrital volcanic material, the Blackbrook Series. They have also reason to believe that the anticlinal fault is less than was supposed, and that we have here a fairly unbroken base for the forest rock already described. In this case there ought to be representatives of the great agglomeratic masses on the western side of the anticlinal (High Towers, &c.). The authors believe that they have found these, though as much finer and more water-worn detritus, in the greenish grits above Longcliff and Buckhill. The authors also believe that they have succeeded in tracing a coarse agglomerate with slate fragments round about three-fourths of the circumference of the forest. Further notes upon the district of Bardon Hill, Peldar Tor, and Sharpley are given, and the origin of the remarkable rock of the last, so like some of the Ardennes porphyroids, is discussed; the authors believe it to be a volcanic tuff, altered by the passage of water or of acid gases. Descriptions of the microscopic structure of some of the rock fragments included in the coarse agglomerate and of some of the slates are given. Also a notice of two small outbursts of igneous rock of the northern syenite type, previously unnoticed, are mentioned.—On the geological age of Central and West Cornwall, by J. H. Collins, F.G.S. The author divided the stratified rocks of this district into four groups, as follows:—1. *The Fowey Beds*, mostly soft shales or fissile sandstones, with some beds of roofing-slate; no limestones or conglomerates. These beds cover an area of not less than eighty square miles, and contain numerous fragmentary fish-remains and other fossils, many as yet undetermined, the whole, however, indicating that the beds are either Lower Devonian or Upper Silurian. The strike of the beds is north-west to south-east, and they are estimated to be not less than 10,000 feet thick. 2. *The Ladock Beds*, consisting of slaty beds, sandy shales, sandstones, and conglomerates; no limestones and no fossils. They cover an area of more than 100 square miles to the west and south of St. Austell, strike from east to west, and overlie Lower Silurian rocks unconformably. They are estimated at from 1,000 to 2,000 feet thick. 3. *The Lower Silurians* consist largely of slates and shales, with some very thick conglomerates (one being at least 2,000 feet thick), some quartzites, and a few thin beds of black limestone. The quartzites and limestones have yielded fossils (chiefly Orthidæ) which are pronounced to be of Bala or Caradoc age by Davidson and others. The total thickness of these beds is estimated at 23,000 feet, and the fossils are found in the upper beds only. Instead of occupying only about twelve square miles, as shown on the Survey maps, they extend over nearly 200 square miles, and reach southward beyond the Helford River, and westward to Marazion. The strike of these rocks is from north-east to south-west. 4. *The Ponsanooth Beds* occur beneath the Lower Silurians, and unconformable with them (strike north-west to south-east); they are often crystalline, and are estimated at 10,000 feet thick. Each of these formations has its own set of intrusive rocks; each has been contorted and in part denuded away before the deposition of its successor. The various granitic bosses have been pushed through this already complex mass of stratified rocks without materially altering their strike, which does not in general coincide with the line of junction. The

chemical effects of the igneous intrusions are generally considerable, and somewhat proportioned to their relative bulk.—On a second pre-Cambrian group in the Malvern Hills, by C. Callaway, D.Sc. F.G.S.

**Anthropological Institute, May 25.**—Edward B. Tylor, F.R.S., president, in the chair.—Dr. H. Woodward read extracts from a paper by Prof. J. Milne, F.G.S., of the Imperial College of Engineering, Yedo, on the Stone Age in Japan. The author described, from personal examination, many of the archaeological remains in Japan. Kitchen-middens are abundant, and are ascribed to the Ainos, the ornamentation on the pottery resembling that still used by the Ainos of to-day. The shells and bones found in the middens were enumerated and described. The stone implements found in Japan include axes, arrow-heads, and scrapers. Many of these occur in the middens. The axes are formed generally of a greenish stone, which appears to be a decomposed trachytic porphyry or andesite. The Ainos used stone implements up to a comparatively modern date. Tumuli occur in many parts of Japan, as well as caves, both natural and artificial. Prof. Milne had opened one of the latter, and found the interior covered with inscriptions. The Japanese themselves make valuable collections of stone implements, old pottery, &c., the favourite notion among them being that such things were freaks of nature. Several fragments of pottery, shells, and other remains from kitchen-middens were exhibited.—Mr. C. Pfoundes read an interesting paper on the Japanese people, their origin, and the race as it now exists. Passing over the fabulous period, we find the Japanese commence their era and history about the same time as that of Rome, B.C. 660; the first Emperor, Mikado, or Ruler, established himself in the vicinity of Kiote, not very far from the present treaty ports Osaka-Kiogo. For centuries history teems with accounts of efforts to civilise the people, and the wild and intractable aborigines were gradually driven northward, until they settled in the North Island, where they still exist and form the bulk of the present inhabitants. Mr. Pfoundes exhibited a valuable collection of photographs and drawings in illustration of his paper, together with articles of Japanese manufacture and some fine specimens of tapestry.

**Entomological Society, June 2.**—Sir John Lubbock, Bart., F.R.S., president, in the chair.—Miss Georgiana Ormerod, of Isleworth, and Mr. Hy. Lupton, of Chapel Allerton, Leeds, were elected Ordinary Members.—Mr. M. J. Walkhouse exhibited a collection of moths from Mangalore, on the Malabar coast, many of the species of which resembled palæarctic forms.—Mr. J. A. Finzi exhibited, on behalf of Mr. Lowrey, a bred specimen of *Arctia fuliginosa* which possessed only one antenna. The President stated that he had occasionally bred ants with only one antenna, and on one occasion had possessed a specimen with no antennæ at all.—The President also exhibited specimens of a new Australian ant received from Mr. Waller, which agreed with the genus *Myrmecocystus*, of Wesmæl, in having an immensely distended abdomen, so that the insect actually serves as an animated honeypot.—The Rev. H. S. Gorham communicated the concluding portion of his Materials for a Revision of the *Lampyriæ*.

**Victoria (Philosophical) Institute, June 8.**—Annual Meeting.—The Right Hon. the Earl of Shaftesbury, K.G., in the chair.—Prior to the delivery of the address by Bishop Cotterill, D.D., F.R.S.E., the honorary secretary, Capt. F. Petrie, read the report, from which it appeared that the total number of Members was now 835.—The subject of the annual address was one aspect of the relation between the scientific and the religious view of the universe.

#### VIENNA

**Imperial Academy of Sciences, February 19.**—The following among other papers were read:—On the relation of the muscle-current to local chemical changes of the muscle substance, by Dr. Biedermann.—On orthoethylphenol, by Drs. Suida and Plohn.—Theory of conic surfaces of the fourth degree with a double conic section, by Herr Ameseden.—Changes of form of electrical figures by magnets, by Prof. Reitlinger and Dr. Wächter.—On ventilation in schoolrooms, by Herr Nachtmann.—On the decomposition of nitrososulphydantoin with bases, and on a new acid, nitrosothioglycolic acid, by Prof. Maly and Herr Andreasch.

March 4.—On the orbit of the planet Ino (173), by Dr. Becker.—Determination of the absolute velocity of current electricity from Hall's phenomenon, by Prof. v. Ettingshausen.

—On a law of the stimulation of terminal nerve-substances, by Prof. Mayer.—Contributions to the photochemistry of bromide of silver, by Dr. Eder.—Notices on the formation of free sulphuric acid, and some other chemical relations of gasteropoda, especially of *Dolium galea*, by Prof. Maly.—On the theory of normal surfaces, by Prof. Peschka.—On cinchomeric acid, by Dr. Skraup.—On aldehyde resin, by Herr Ciamician.—On an extension of the limits of validity of some general propositions of mechanics, by Prof. Simony.—On oxycuminic acid and on the action of nitrous oxide on organic compounds, by Prof. Lippmann and Herr Lange.

March 11.—The orthogonal-axonomic contraction circle, by Prof. Pesar.—Electrolysis of organic substances in aqueous solution, by Prof. Habermann.—Action of oxalic and sulphuric acid on naphthol, by Herr Hönig.—On dipropylresorcin and some of its derivatives, by Herr Kariof.—On idryl, by Dr. Goldschmiedt.—On direct introduction of carbonyl groups into phenols and aromatic acids, by Herr Senhofer and Herr Brunnen.—Remarks on Cauchy's theory of double refraction, by Prof. v. Lang.—Determination of path of comets discovered at Pola in 1879, by Herr Palisa.

March 18.—Heliotropic phenomena in the plant kingdom (second part), by Prof. Wiesner.—On the projective construction of curves of the second order, by Prof. Binder.—On Sturm's series, by Prof. Gegenbauer.—A hydraulic motor, by Herr Kauer.—The alteration of molecular weight and molecular refractive power, by Prof. Janovsky.—On the tannic acid of oak-bark, by Herr Etti.—On some tertiary echinida from Persia, by Herr Fuchs.—Sulphur compounds of chromium, by Prof. Lieben.—Behaviour of bone gelatine in dry distillation, by Dr. Weidel and Herr Ciamician.—On the determination of the halogens in chlorates, bromates, and iodates, by Herr Fleissner.

April 8.—The following among other papers were read:—Theory of motion on developable surfaces, by Herr Wittenbauer.—The inflorescences of Marchantiaceæ, by Prof. Leitgeb.—On the magnetic action on fluorecence light excited by the negative discharge in a vacuum space, by Prof. Domalip.—On discrete vortex lines, by Dr. Marguès.—Contributions to the photochemistry of bromide of silver, by Dr. Eder.

PARIS

Academy of Sciences, June 7.—M. Edm. Becquerel in the chair.—The following papers were read:—On a bromised derivative of nicotine, by MM. Cahours and Etard. The formula is  $C_{20}H_{14}N_2Br$ .—Geological history of the English Channel (first part), by M. Hébert.—M. Daubrée gave a *résumé* of a study entitled "Descartes, one of the creators of cosmology and geology." Descartes considered all celestial phenomena as simple deductions from laws of mechanics, affirmed the unity of composition of the physical universe, perceived the capital rôle of heat in formation of our globe, &c.—M. du Moncel presented a third edition of his work on the telephone, microphone, and phonograph.—M. Chancel was elected correspondent in chemistry in place of the late M. Favre.—Theorems on the decomposition of polynomes, by M. Carrère.—Result of treatments of vines attacked with phylloxera, by M. Boiteau. The vines treated for three years past (with sulphide of carbon) are thriving beautifully. Infected vines over fifteen to twenty years old, which cannot renew their radicular system, should be replaced by young plants. The best method of application is that in parallel lines, with doses of 20 gr. per square metre applied in two or three holes. The sulphide even seems to stimulate the vine.—New generation of the surface of the wave and various constructions, by M. Mannheim.—On ternary cubic forms, by M. Poincaré.—On irreducible functions according to a prime modulus, by M. Pellet.—Remark relative to two integrals obtained by Lamé in the analytical theory of heat, by M. Escary.—On the partition of numbers, by M. David.—Direct measurement of the interior resistance of magneto-electric machines in motion, by M. Carnellas. The induction of the electro-magnets and the metallic cheeks is obviated by rotating the (Gramme) ring mounted carefully with its brushes on wooden supports, and the effects of terrestrial induction are avoided by opposing to each other these effects in two similar Gramme rings, mobile under the same conditions, with axes parallel. The ring (at rest or rotating) is made the fourth side of a Wheatstone bridge formed by Siemens' universal galvanometer. The resistance of the ring in motion (450 turns per minute) shows an increase of 25 per cent. on that of the ring at rest.—Transformation of gunpowder in the metallic cases

of infantry cartridges, by M. Pothier. A diminished velocity of balls of cartridges that have been long charged, and diminished accuracy of fire, are accounted for by a proved chemical decomposition of the powder in contact with the metallic case, the quantity altered varying according to atmospheric influences, especially moisture, at the time of manufacture or during storage. Experiment proved zinc to have most action, then followed copper. Lead, tin, and iron affect the powder less. High temperature accelerates the transformation if the powder is moist.—Optical arrangement for firing within covered batteries, by M. de Frayssèix. By means of a lens and screen the artilleryman is enabled to take better aim. M. Ed. Becquerel called attention to previous devices of the same kind.—On colloidal oxide of iron, by M. Magnier de la Source. The composition of the soluble ferric hydrate is that of the normal hydrate.—On a new sulphate of alumina (sesquibasic sulphate of alumina), by M. Marguerite. One method of preparation is decomposition of alum of ammonia by heat. Three others are indicated.—Action of chlorine on sesquioxide of chromium, by M. Moissan.—On a combination of allylic alcohol with anhydrous baryta, by MM. Vincent and Delachanal.—On the fixity of composition of plants; ratio between the fecula, phosphoric acid, and mineral substances in potato, by M. Pellet. While these show constant ratios there are great differences in the proportions of the chief alkalis, lime and potash; but there is equivalent substitution of these alkalis, so that the quantity of sulphuric acid necessary to saturate all the bases is sensibly the same. Silica and nitrogen vary pretty largely.—Analysis of the seeds of beet, by MM. Pellet and Liebschutz.—Disinfection and conservation, from an agricultural point of view, of animal matters, and notably blood, by use of bisulphate of alumina and nitric acid, by M. Vautelet. They act by coagulation, &c.—On the physiological effects of erythrophleine, by MM. Lee and Bochofontaine. It acts both on the heart and the respiratory apparatus, and may prove a useful clinical agent.—On some anatomical characters of Chiroptera of the genus *Cynonycteris*, by M. Robin.—On the metamorphosis of *Pterostictoma*, by M. Vayssièrè.—On a peculiar modification of a parasitic Acarian, by M. Megnin. The eggs of a *Cheyletus*, on an American Grosbeak, were found protected by fine tissue, like that furnished by certain Arachnides.—Helminthological observations and experimental researches on the disease of work men in the St. Gothard, by M. Perroncito. The numerous workers who have become anæmic have been preyed upon by certain small worms, and this quite explains the anæmia. A similar malady was observed in making the Mont Cenis tunnel.—M. d'Abbadie presented a work by Mr. Knipping on the cyclones of 1878 in the China Seas.

CONTENTS

	PAGE
TWO DARWINIAN ESSAYS. By ALFRED R. WALLACE . . . . .	141
NATURE'S HYGIENE . . . . .	142
OUR BOOK SHELF:—	
Holmes' "Science of Voice Production and Voice Preservation for the Use of Speakers and Singers" . . . . .	143
Hughes' "Ceylon Coffee Soils and Manures: a Report to the Ceylon Coffee Planters' Association" . . . . .	144
LETTERS TO THE EDITOR:—	
Cloud Classification.—REV. W. CLEMENT LEY . . . . .	144
The Motion of Fluids.—HORACE LAMB . . . . .	145
On the Physical Aspects of the Vortex Atom Theory.—W. L. . . . .	145
The Aurora Borealis and its Colours.—T. W. BACKHOUSE . . . . .	145
A New Audiphone.—THOS. FLETCHER . . . . .	145
Crystal Ice.—R. H. . . . .	145
The Stone in the Swallow.—JOHN LOCKE . . . . .	146
Stags' Horns.—E. W. CLAYFOLD . . . . .	146
ON SOME POINTS CONNECTED WITH TERRESTRIAL MAGNETISM. By Prof. B. STEWART, F.R.S. . . . .	146
ON A NEW JELLY-FISH OF THE ORDER TRACHOMEDUSÆ, LIVING IN FRESH WATER. By Prof. E. RAY LANKESTER, F.R.S. . . . .	147
NOTES FROM JAVA . . . . .	148
ON THE FERTILISATION OF <i>COBÆA PENDULIFLORA</i> (HOOK. FIL.). By Dr. A. ERNST . . . . .	148
EXPERIMENTAL RESEARCHES IN ELECTRICITY. By WARRREN DE LA RUE, M.A., D. C.L., F.R.S., and HUGO W. MÜLLER PH.D., F.R.S. (With Illustrations) . . . . .	149
A FOURTH STATE OF MATTER. By W. CROOKES, F.R.S. . . . .	153
NOTES . . . . .	154
OUR ASTRONOMICAL COLUMN:—	
Faye's Comet . . . . .	156
The Great Southern Comet of 1880 . . . . .	156
Minima of Algol . . . . .	156
PHYSICAL NOTES . . . . .	156
GEOGRAPHICAL NOTES . . . . .	157
THE ROYAL OBSERVATORY . . . . .	158
INTERCOLONIAL METEOROLOGICAL CONFERENCE AT SYDNEY . . . . .	160
UNIVERSITY AND EDUCATIONAL INTELLIGENCE . . . . .	160
SCIENTIFIC SERIALS . . . . .	160
SOCIETIES AND ACADEMIES . . . . .	161

THURSDAY, JUNE 24, 1880

## A STEP BACKWARDS

WE are glad that Sir John Lubbock has given notice that he will call attention to the Education Code and move a resolution, unless indeed the Government themselves are sufficiently wide awake, patriotic, and liberal in its best sense, to step in and prevent Lord Norton's resolution in the House of Lords the other day from attaining the issue desired by the educational obstructionists. Lord Norton's hostility to popular education is notorious, and on Friday he had the honour of being supported by several reverend bishops, who are supposed officially to yearn after the highest welfare of the people. The effect of Lord Norton's resolution would be to cut out everything like real education and training from our elementary schools, and leave nothing but the minimum of instruction in the three R's. It seems hard to have to go over the old ground again, and to show that the pittance of education which Lord Norton and those who side with him would allow the vast majority of the children of the nation, is really no education at all. The objection apparently of Lord Norton to the retention of the specific subjects of the fourth schedule is that their introduction has been too successful; that in some schools the talents of a few pupils under this system have been so developed that they have been continued at school beyond the age of fourteen. Considering the ample opportunities which charity has provided for the education of the children of the class to which Lord Norton and his supporters belong, it seems to us mean in them to grudge the pittance expended by the country in encouraging a few hundred clever boys of the humbler classes to pursue their education to a degree for which they have shown special aptitude. We are especially surprised to find among the supporters of Lord Norton's motion the Duke of Richmond and Gordon, who thus condemns the very code which was drawn up under his auspices and which was worked under his superintendence for five or six years without any apparent suspicion on his part that it was not the best possible of all codes. Of course our enlightened statesmen would never stoop to degrade a subject of such national importance into a party question, and therefore the Duke of Richmond and the other enlightened and reverend supporters of the persistent opponent of popular education, did not surely realise the effects of their vote. The real aim of Lord Norton's resolution, there can be no doubt, is to stifle all training in science out of elementary education. We trust Sir John Lubbock will have an opportunity of speaking on the subject in the House of Commons, and reminding our legislators of some of the facts in his impressive speech of 1877. They evidently require to be reminded of what the real object of education is. Mere reading, writing, and arithmetic is but a poor and inefficient equipment for those who will have throughout life the hardest struggle with their physical surroundings. Crime and disease, it has been again and again proved, are more the result of ignorance than of anything else—ignorance, not of the three R's so much as ignorance of our own bodies and of

Vol. xxii.—No. 556

the laws of that nature by which we are surrounded and of which we form part. In a former discussion in Parliament on this subject Mr. Playfair showed that many people were appalled by the mere name of science as connected with education, as if it were something beyond the comprehension of any but a select few, and far too remote from human interests to be of any use in a system of elementary education. But Mr. Playfair also showed that what was meant was merely natural knowledge, a knowledge of the facts and laws of nature, a knowledge of our own bodies and of the things outside our bodies with which daily every one comes in contact. In the speech already referred to by Sir John Lubbock, and reprinted in his "Political Addresses," he shows that grammar and even history, as ordinarily taught, are far more difficult and much less interesting than the elements of natural knowledge, which he maintains ought to be introduced into our elementary schools. Much more, he shows, could be advanced against the utility of teaching grammar than against teaching the elements of physiology or domestic or political economy; and history, as taught in most text-books, is a farrago of figures, crimes, murders, and battles. Lord Norton is evidently so completely ignorant of the real nature of science—which has to do with tangible, hard, every-day facts—that he thinks all that is necessary might be learned from a judiciously compiled reading-book. The fact is no book of any kind need be required by a competent teacher, and the whole aim and end of science teaching would be missed if it dealt with words and not things.

If it is desired to turn out men and women with well-trained, observant minds, fitted to grapple with the circumstances of the every-day life of the bulk of the people of this country, then the education which results from an acquisition of some of the most elementary laws and facts of nature is absolutely necessary. Moreover it has been clearly shown that in schools where a little science is properly taught the pupils are much further advanced as readers than in schools where there is no variety apart from the old-fashioned three R's. We cannot believe that Lord Norton's resolution will meet with any support outside the House of Lords; should it reach the House of Commons we are sure that body will have too much respect for the bulk of its constituents to insult and injure them by approving of any such retrogressive step.

## FRESHWATER RHIZOPODS OF NORTH AMERICA

*United States Geological Survey of the Territories—Freshwater Rhizopods of North America.* By Joseph Leidy, M.D., Professor of Anatomy in the University of Pennsylvania and of Natural History in Swarthmore College, Pennsylvania. (Washington: Government Printing Office, 1879.)

THE scientific history of the freshwater rhizopods begins only a little anterior to the Declaration of Independence. Rösel (1755) knew of the existence of such forms, which puzzled him. Linnæus (1760) named one of them *Volvox chaos*;—*polymorpho-mutabilis*, the form of whose body was *Proteo inconstantior*. But with the increase in the powers of the objectives used with the microscope,

so did the knowledge of these forms increase. Ehrenberg and Dujardin led the way to a brilliant series of discoveries, which have been continuous, and never more numerous than during the last twenty years.

One protozoon was on the roll-call of the *systema natura*—who could count the vast multitude known to us now? The very list of the provisional classes and sub-classes would be a long one.

On some of these classes splendid monographs have been written, among which those of Stein, Carpenter, Claparède, Haeckel, Wallich, and Brady may be mentioned, while the authors of papers on special genera and species would be too numerous to quote.

Most of the authors referred to have worked among the European forms, but Carter added greatly to our knowledge of those to be met with in the Island of Bombay. Africa and America were unknown countries; while the former still remains so, the persevering efforts of Dr. Joseph Leidy for the last ten years have gradually unfolded to us the rhizopodal wealth of North America, and have culminated in the publication of the finely-illustrated work that we proceed to notice.

As preliminary we are reminded that there is no very fixed system of classification for this class. Dr. Leidy treats of the fresh-water species only, as found in the orders Protoplasta, Heliozoa, and Foraminifera, the first two being commonly designated "Freshwater Rhizopods." These, writes Dr. Leidy, are to be found almost everywhere in damp or wet, but not over shaded positions; they are especially frequent and abundant in comparatively quiet waters, which are neither too cold nor yet too much heated by the sun. They are to be found among moss in spongy places or on damp rocks. They hide away among sphagnum-leaves, at the roots of sedges and grasses on the bark of trees. Once, we remember, Dr. Leidy got quite a store of them in the fork of an old apple-tree. Sometimes a depression or fissure in a rock, sometimes even the crevice of a wall or of the pavement, affords them space enough. We have taken them almost at the equator. Dr. Wallich has described many from within the Arctic circle. The favourite habitation of many forms is the light superficial ooze at the bottom of still waters. If this be gently collected, there they will be found grazing among the desmids and diatoms fond of such quarters. The dark deep mud that will be found below this it is as well not to stir; it is a layer in which life turns to death, and its odour is never pleasant. But again, these rhizopods are to be found in that creamy, flocculent matter that half floats on the surface of great pools. The expert collector will soon get to know the difference in these "creams"—some so rich in treasures, some containing nothing but dead cells and empty lorica; then again Dr. Leidy found these rhizopods in no place in such profusion, number, and beauty of form as in sphagnum bogs, living in the moist or wet bog moss (*Sphagnum*). "Sometimes he found this moss actually to swarm with multitudes of these creatures of the most extraordinary kinds and in the most highly-developed condition. A drop of water squeezed from a little pinch of bog moss has often yielded scores of half a dozen genera and a greater number of species." "Frequently, however," he adds, "the sphagnum of many localities contains comparatively few rhizopods, though I have rarely found them

entirely absent from the moss." In Ireland the very reverse of this seems to hold true, and the exceptional multitudes have not yet turned up.

Dr. Leidy's volume is issued under the modest title of a "Report," so that it seems desirable to mention that it forms a large quarto volume of 324 pages, illustrated with 48 coloured plates. The printing and paper of the volume are simply perfection, like, indeed, most of the work issued from the Government printing-office at Washington, and brought out under the superintendence of Dr. F. V. Hayden. It forms one of the volumes of the United States Geological Survey, and its publication betokens an enlightened zeal on the part of the United States geologist in charge. As to the illustrations, we think the author quite unduly hard in his estimate of them. He says: "The illustrations accompanying this work, done in chromolithography, are not equal in execution to my desire," and he regrets the absence from the States "of those accomplished artists from Germany and France." To our mind, as chromolithographs, the illustrations are excellent. The drawings are recognisable at a glance. The slight hardness in outline and sharpness of colouring are not defects to be made over much of, and we feel sure that these plates will be for the most part recognised as good and excellent representations of the forms described.

There are about seventy-five species, including those of all orders, specially described in this volume, and it is a pleasure to note how few new genera are proposed. Speaking in general terms, Prof. Leidy seems to believe in there being a very large range of variability in the species, but it is not improbable that a more lengthened study of the forms might considerably modify his views. Any discussion on such points would be out of place in the present notice. A controversy as to what is a species, what a variety, would seem captious over a book quite full of the facts in nature as Dr. Leidy found them, and from which he leaves one in full confidence to draw their own opinion.

One very lovely form to this only known from North America is called by Dr. Leidy *Hyalosphenia papilio*. It is doubly interesting as marking an era in its describer's life. It is common and at times exceedingly abundant in moist bog or sphagnum, or sphagnum swamps, but it is not found in ponds unless accidentally. "No other lobose rhizopod has more impressed me with its beauty than this one. From its delicacy and transparency, its bright colour and form as it moves among the leaves of sphagnum, desmids, and diatoms, I have associated it with the idea of a butterfly hovering among flowers. From its comparative abundance, the readiness and certainty with which it may be obtained and observed, and from its transparency, which allows its structure to be well seen, it is peculiarly well adapted for the study of the life-history of its order; I have collected it from early spring to late autumn, and have retained it alive in sphagnum in a glass case in winter. This interesting rhizopod, found together with a profusion of other remarkable microscopic forms of both animal and vegetable life, of which many are novel and yet undescribed, recalls pleasing recollections of excursions into the sphagnum bogs, cedar swamps, and pine barrens in the southern region of New Jersey. These localities have special charms for the botanical



student, on account of the diversity of beautiful and interesting plants they produce. In proper season, in most places, they are redolent with the rich perfume of *Magnolia glauca* and the fragrance of *Clethra alnifolia*. In early spring the ground is adorned with bright patches of the little *Pyxidantha barbata*, and the sand myrtle (*Leiophyllum buxifolium*). Later the swamps display an abundance of *Helonias bulbata*, and still later many other liliaceous plants, *Zygadenus limanthoides*, *Narthecium americanum*, besides more common ones. Rich are these woods and swamps in genera of orchids. On the dry banks grow *Vaccinia* and other ericaceous plants, amidst which are conspicuously to be seen the spikes of white flowers of the grassy-looking *Xerophyllum asphodeloides*, while the bogs below are as conspicuously dotted with the curious green and purple pitcher plant (*Sarracenia purpurea*) nestling among sphagnum and entangled among sundews." This rhizopod was first noticed by Prof. Leidy some thirty years ago, but it was not until 1873, on the fiftieth anniversary of his birth, that he commenced to study the rhizopods with the assistance of the microscope. He had scarcely begun to do so until he came again across this form, and he then named it as *Diffugia papilio*. It was the re-discovery of this beautiful form which he tells us impelled him to pursue the investigations which built up the material of the present work.

The greater part of this volume is taken up with the details of the "Protoplasta," of which a few species are for the first time described, but most of the peculiarly American species figured have been already described by Dr. Leidy in the *Proceedings* of the Academy of Natural Sciences of Philadelphia. In many of the species the endosarc was bright green from the presence of chlorophyll (spelled chlorophyl in this volume throughout). The forms recorded as belonging to the "Heliozoa" are not very numerous, and among them no doubt a good deal of work remains to be done. A *Vampyrella* form is included among these, but Dr. Leidy could detect no nucleus. Of the free forms the most interesting are *Actinophrys sol*, *Heterophrys myriapoda*, *Raphidiophrys viridis*, *Diplophrys Archeri*, *Actinospharium eichornii*, and *Hyalolampe fenestrata*, while of the attached forms only *Clathrulina elegans* was met with, it is beautifully figured.

Of the foraminiferous order one species of *Gromia* (*G. terricola*) is described and figured, and a genus *Biomyxa* is established for a rather problematic form, consisting of what might prove yet to be the plasmodium of a fungus. No forms related to *Chlamydomyxa* were met with, but we forbear to linger further over special details, and we close a volume which will henceforth be as useful to the investigator of these forms in Europe as in America.

E. P. W.

#### THE RECENT PROGRESS OF ENGLISH PHILOLOGY

*The Journal of Philology.* ix. 17. (Macmillan and Co., 1880.)

*The American Journal of Philology.* i. 1. (Macmillan and Co., 1880.)

THE establishment of a new philological journal, devoted more especially to the study of the classical languages, seems a fitting occasion for reviewing the present condition of philology, in the narrower and

German sense of the word, among English-speaking scholars. A great change has come over the study of Latin and Greek during the last half century, and the old-fashioned scholarship whose highest aim was the composition of faultless verses seems likely soon to become a thing of the past.

The change has been largely due to the rise and growth of comparative philology. The conception of law has been introduced into the study of speech, and we have learned that in language as in nature there is nothing arbitrary and capricious, that what now exists is the result of a long and gradual development determined by ascertainable conditions and causes. Above all we have come to know that we cannot pick out any one language as superior to all others in the same way that we pick out a particular literature as superior to other literatures; the only test in fact of the worth of a language is its greater or less capacity for expressing thought. The thought, it is true, may be poor; but this is the fault of the thinkers, not of their language.

Latin and Greek grammar has thus been brought down from the lofty pedestal on which it once stood and shown to be neither better nor worse than the grammar of any other form of speech. But in return a new spirit of life has been breathed into it. It is no longer a collection of arbitrary rules and lists of words compiled from the literary usages of a certain number of writers. Its rules have been explained, its words traced historically to their earlier forms, and the grammar of the classical tongues has once more become a living organism, developing and changing in accordance with scientific laws like the grammars of modern languages.

Along with this truer conception of Greek and Latin grammar has come a truer conception of the Greek and Latin languages themselves. We have come to realise that like our own mother-speech they consisted of sounds not of letters, of living words not of the written symbols that stood for them. A dead language differs from a spoken one only in that we know less about it. We cannot lay down that the particular form of language used by certain literary men at a particular period is either Greek or Latin. If we would understand what Greek really was we must study it in its various dialects, must examine it in the inscriptions which represent the language of everyday life more faithfully than an artificial literature, and by the help of comparison and induction must trace its history back to that early time when it was still but a dialect of the common Aryan tongue. So, too, we must divest ourselves of the notion that the idiosyncracies of a few literary men alone constitute correct Latin, and seek the true character and history of the language rather in the inscriptions which modern research has brought to light.

Classical philology has further felt the influence of the comparative method of linguistic science even on its purely literary side. We have ceased to regard the works of the classical writers with the wondering awe of the scholars of the Renaissance, or to determine their relative merits by the conventional standard of traditional or subjective criticism. Manuscripts are now carefully examined and collated, the accuracy of tradition is questioned and the genuineness and date of the books that have come down to us are sharply tested. We can

no longer accept any statement, no longer receive any reading, however strongly supported by authority or backed by ancient tradition, unless it be corroborated by the potent instrument of comparison. The modern scientific method is the bar before which our classical studies must all be brought.

The truth of this may be seen at once by comparing the contents of our modern philological periodicals with those that were published at the beginning of the present century. The material still remains the same, but the spirit, the method, and the aims have all been changed. In this, as in the science of language itself, Germany has led the way; but the example of Germany has now found able imitators both in this country and in America. The *English Journal of Philology* has been too long in existence for its merits to need more than a passing recognition, and the *American Journal*, the first number of which has just appeared under the editorship of Prof. Gildersleeve, promises to be a worthy rival of its English forerunner. At present, indeed, most of its articles have a touch of "rawness" inseparable from a new venture, but a large part of it is occupied in a most useful way by an analysis of the articles that have been published in kindred foreign serials. This is a feature that might be imitated with advantage by the *English Journal*. Both publications admit Oriental and general as well as purely classical subjects, and an article in the last number of the *English Journal* by Prof. Robertson Smith on "Animal Worship and Animal Tribes among the Arabs and in the Old Testament," is marked by his usual learning and acuteness. He shows in it that Mr. MacLennan's theory of a primitive totemism in connection with polyandry is fully confirmed by the early beliefs and practices of the Semites. A new light is thus cast upon the beginnings of Semitic religion, and obscure allusions in the Old Testament are cleared up.

A. H. SAYCE

#### OUR BOOK SHELF

*Fern Etchings: Illustrating all the Species of Ferns Indigenous to the North-Eastern United States and Canada.* Second Edition. By John Williamson. (Louisville, Ky., 1879.)

A HANDSOME book, consisting of etchings, with accompanying letter-press descriptions, of sixty-eight species or varieties of ferns, natives of the northern part of the American continent. The drawings are well executed and characteristic, giving a faithful idea of the general habit of the fern, though without any enlarged details; and the accuracy of the descriptions is insured by borrowing them from Gray's "Manual" or Eaton's "Ferns of North America." Of the species depicted, including all that are natives of the Northern United States and Canada, twenty-two, or about one-third, are also natives of the British Isles. The southern limit for the volume appears to be Virginia and Kentucky. The volume is an elegant ornament to the drawing-room table.

#### LETTERS TO THE EDITOR

[The Editor does not hold himself responsible for opinions expressed by his correspondents. Neither can he undertake to return, or to correspond with the writers of, rejected manuscripts. No notice is taken of anonymous communications.]

[The Editor urgently requests correspondents to keep their letters as short as possible. The pressure on his space is so great that it is impossible otherwise to ensure the appearance even of communications containing interesting and novel facts.]

#### A Fourth State of Matter

IN the very interesting communication from Mr. Crookes on "A Fourth State of Matter," which is contained in *NATURE*,

vol. xxii, p. 153, there is a paragraph at the end which advances, as it seems to me, some most disputable propositions.

Like many other questions of modern science, the question he raises is to a very large extent a question of definition. But questions of definition are questions of the very highest importance in philosophy, and they need to be watched accordingly.

Speculating on the ultimate conceptions of Matter which are affected by the discovery of it in "a fourth condition," Mr. Crookes says: "From this point of view, then, Matter is but a 'mode of motion.'"

It has never appeared to me that this well-known phrase is a very happy one, even as applied to Heat. It is possible, of course, to consider Heat from this point of view. But then it is equally possible to consider all other phenomena whatever from the same point of view. Not only Heat, but Light, Sound, Electricity, Galvanism, and Sensation itself in all its forms, may be regarded as "modes of motion."

But at least in the application of this phrase to Heat there is an intelligible meaning, and not a mere confusion of thought. But as applied to Matter—as a definition of our ultimate conception of Matter—it appears to me to confound distinctions which are primary and essential. "Motion" is an idea which presupposes Matter and Space. Motion has no meaning whatever except the movement of Matter in Space. To define Matter, therefore, as a "mode of motion," is to define it as Matter in a state of motion. But this definition necessarily implies that Matter can also be conceived as without motion, and accordingly Mr. Crookes is obliged to confess that "at the absolute zero of temperature inter-molecular movement would stop," and that after that, Matter would remain with all the "properties of inertia and of weight."

Again, Mr. Crookes says: "The space covered by the motion of molecules has no more right to be called Matter than the air traversed by a rifle-bullet can be called lead." No doubt this is true; but it implies what is not true, that the common idea of Matter is nothing but "the space covered by the motion of molecules." The popular ideas attached to words of primary significance may not be always adequate or complete. But in my opinion they are generally much more near the truth and more accurately represent the truth, than most of the phrases which scientists are now inventing in the region of transcendental physics.

These phrases have their value and their interest as representing special and partial aspects of phenomena. But I hold that the unconscious metaphysics of human speech are often the deepest and truest interpretations of the ultimate facts of nature.

June 20

ARGYLL

#### The Fine Wire Telephone

I HAVE just read in *NATURE*, vol. xxii, p. 138, an abstract of the *Proceedings* of the Royal Society of London, giving an account of a new form of telephone receiver devised by Mr. Preece.

It happens, very curiously, that I was led independently to construct a practically identical instrument, with which I have been experimenting for some time in the laboratory of my colleague, Prof. Tait, and which was exhibited in action at the last meeting of the Royal Society of Edinburgh, before I was aware of Mr. Preece's invention.

The experiments of Mr. Preece and myself have been to a considerable extent anticipated by some results given in a paper by Dr. Ferguson (*Proc. R. S. E.*, 1877-78, pp. 628 *et seq.*), of which I was unaware when I made my own experiments.

It is true that Dr. Ferguson has not applied his apparatus to the transmission of music or of articulate sounds, as has been done by Mr. Preece and myself; but he made the practically very important step of attaching a mechanical telephone to the wire which conveys the varying current, and has thus rendered the observation of De la Rive's sounds in iron and other metals both easy and certain.

In Dr. Ferguson's paper will also be found a most important result, which I have verified since he drew my attention to it, viz., that sounds can be produced in fine wires generally by induction currents of very feeble total heating effect.

As to the theory of the action of this new kind of receiver, I agree with Mr. Preece that in weakly magnetic metals generally it is due to heating effects. I had been discussing with Mr. Blyth the theory of his receiver (described in *NATURE*, vol. xix, p. 72), and it was as an illustration of the explanation of all kinds of microphone receivers, suggested by his beautiful experi-

ments on loose contacts, that I thought of the experiment in question. My idea was to replace his heated point of metal by a continuous portion of the circuit which should act in the same manner. It was obvious that this part must be of small diameter to secure resistance enough to make the extension of the wire due to the variation of the heating effect sensible; and to insure that the cooling should be rapid enough to allow a musical note to be produced.

I had reason beforehand to believe that the second condition could be fulfilled in practice; because I had found in my experiments on Ohm's Law (*Reports*, British Association, 1876, p. 58, *et seq.*) that, when currents of different strengths alternated very rapidly in a fine wire, the cooling was so rapid that the resistance was sensibly greater during the passage of the strong current than it was during the passage of the weaker.

The accompanying figure represents the apparatus with which I worked. I generally used a microphone attached to a violin, belonging to Mr. Blyth, for a transmitter. In this way music was reproduced so as to be audible all over Prof. Tait's large class-room. For reproducing articulate speech I have found a small mica diaphragm, like that used by Edison, Blyth, and others, best; words spoken to the violin are reproduced in this way quite intelligibly, but as I do not possess a good microphone transmitter, I have not experimented much in this direction.

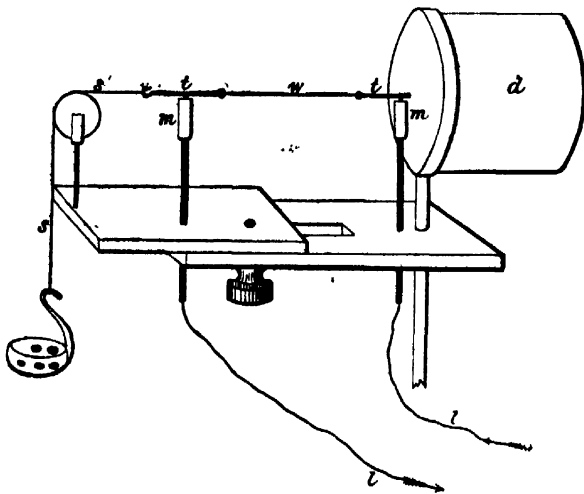

*w*, fine wire; *t t*, thicker copper terminals; *m m*, mercury cups over which *t t* pass; *s s*, string kept tight by small load; *l l*, line wires to microphone; *d*, drum head which distributes the sound.

So far as the limited supply of fine wire permitted, I had arrived substantially at the same results as Mr. Preece regarding the length and tension of the wire. My best results were got with a very fine silver-palladium wire given me by Prof. Tait; with it I could see the string *s s* move in time with the swell of the music. I also used a thicker and shorter platinum wire, heated by the current to a dull red, during silence; it was beautiful to see this wire burst into a bright glow when there came a prolonged note, more especially a high one.

Dr. Ferguson, in the paper above referred to, regards these effects as not due to heating (although he seems to think they follow the same law), but as being molecular in some other sense not very clearly defined. Except in the case of iron,<sup>2</sup> I do not see at present any necessity for so regarding them. The fact that induction-currents of small heating effect will produce them is not conclusive; for it must be remembered that it is not the whole heating effect, but the variation of it during a very short interval that is in question, and some calculations from rough data in my possession have led me to think that there would be no inconsistency in explaining Dr. Ferguson's ticks and the speech and music in Mr. Preece's experiment and my own as due to the same cause. I think also that it is quite possible that

<sup>2</sup> Iron may be anomalous on account of its powerful magnetic properties and Prof. Tait has suggested that, at a certain high temperature, it may, for well-known reasons, be incapable of producing these effects altogether.

we might be able to hear ticks in a wire far too thick for the reproduction of music.

I have begun some experiments with a view to throw some light on questions of this kind. Possibly in the meantime Dr. Ferguson, Mr. Preece, or some other experimenter may be able to produce facts that settle the matter beyond the possibility of doubt. G. CRYSTAL

15, Chalmers Street, Edinburgh, June 12

### The Aurora Borealis and its Colours

IN reference to Mr. Backhouse's letter last week (p. 145) we have nowhere stated that "similarity in colour in electric discharges is sufficient to indicate similarity of constitution, even when their spectra are quite unlike." If Mr. Backhouse will again read our paper on the Aurora, he will see that we say that in the same gas the colour of the discharge varies with the degree of exhaustion. In the *Phil. Trans.*, 1878, part I, we have shown also that in the same gas at the same pressure the colour of the discharge varies with the amount of current; at pp. 180-181, for example, the strata in hydrogen at a pressure of 1.2 mm., 1579 M, were of a cobalt blue with a current of 0.019940 W, and pink with a current of 0.008504 W. In the index at p. 239 are given several references to the same phenomena; and at p. 240 references are given to a number of observations on the "spectra of strata and of glow on terminals."

It is very difficult to say for certain whether the red is below or above the green in aurora displays, by eye estimation; for although apparently above it may be really below. We adhere to our opinion that the red is at the lower level.

WARREN DE LA RUE  
HUGO MÜLLER

73, Portland Place, W.

### On some Points Connected with Terrestrial Magnetism

IN NATURE, vol. xxii. p. 147, our friend Prof. Balfour Stewart makes the following statement in paragraph  $\gamma$  :—

"Above this again we have the lower strata of the atmosphere, which are non-conductors, while above this we have the upper strata, which are conductors."

We venture to think that our researches prove that air cannot, at any degree of attenuation, be considered as a conductor of electricity in the ordinary acceptance of the term.

In the *Phil. Trans.*, Part I. p. 168, after citing a number of experiments bearing on this point, we say:—"These observations show clearly that the discharge through rarefied gases cannot be at all analogous to conduction through metals; for a wire having a given difference of potential between its ends can permit one—and only one—current to pass; whereas we see that with a given difference of potential between the terminals of a vacuum tube currents of strengths varying from 1 to 135 can flow. We are therefore led to the conclusion that the discharge in a vacuum tube does not differ materially from that in air and other gases at ordinary atmospheric pressure, that it is, in fact, a disruptive discharge."

In Part III. of our researches (an abstract of part of which appears in the same number of NATURE), *Phil. Trans.*, vol. clxxi. p. 82, we sum up a series of experiments on the electric discharge in various gases by stating that the same law holds good for a constant pressure and varying distance between flat terminals as for a constant distance and varying pressure, the obstacle in the way of a discharge being, up to a certain point, as the number of molecules intervening between the terminals.

The hyperbolic curves laid down to represent the observations in each case are perfectly continuous, and show no break from the condition of a non-conductor to that of a conductor.

WARREN DE LA RUE  
HUGO MÜLLER

June 21

### Calcareous Concretions in Timber

IN NATURE, vol. xxi. p. 376, I observe that in a remark of the reviewer, and also in an extract from Mr. Ball's "Jungle Life in India," the occurrence of concretions of lime in trees is spoken of as a rare and novel phenomenon. That *Terminalia tomentosa* contains calcareous matter has long been known to natives, and a reference to Tennent's "Ceylon," i. 99, will show that they make a practical use of their knowledge by using the ashes of the bark as a substitute for lime, to chew with betel. Another southern tree which contains an alkali in its bark is *Avicennia tomentosa*. It generally grows along the margins of backwaters,

and has a most wonderful provision for preventing the erosion of the banks and for adding to the dry land. It is a squat bushy tree, and round the stem, to an extent equal to the spread of its branches, it sends up thickets of straight shoots a foot or two high. These, when the tide is up or the water in flood, catch all the stray branches, leaves, grass, &c., that may be floating about, and also promote silt. By this contrivance, therefore, not only are the banks protected from the distinctive action of water, but also raised and consolidated. Again, as regards Mr. Stoney's observation of calcareous masses in timber, which was brought to the notice of the Asiatic Society of Bengal in 1870 as a fresh discovery, it seems strange that the learned body in question did not know that the existence of such concretions, so far from being very rare, is an occasional and well known phenomenon. Thus, in the *Madras Journal of Literature and Science* for April-September, 1858, page 142, Prof. Mayer gives a qualitative analysis of a concretion of the kind found in a teak log. It consisted chiefly of magnesia, with potash, lime, silica, and a trace of iron. The substance, he says, "Must be looked on as a mixture, and not a true chemical compound." Again, he observes, "as a whole the substance thus hardened is insoluble in cold, and but slightly so in water of higher temperature. At 212°, however, there is sensible action after a time. In diluted hydrochloric acid solubility ensues, hastened by increased temperature. Solution is attended by slight effervescence, some carbonic acid being liberated." He then proceeds to give an explanation of the process by which such mineral matters may be taken up from the soil and deposited in the tree. So far as I know the occurrence of such concretions in India was first brought to notice by Lieut., now Col. Hawkes, of the Madras Army, in 1858. He had seen them only in teak logs, and remarked that they generally occur "in what carpenters call a shake in the wood, but with this exception the logs are perfectly sound, and no communication whatever with the external air has been observed."

G. BIDIE

Government Central Museum, Madras, May 13

#### Remarkable Discovery of a Murder in Bermuda

THE following account of a murder which was committed in Bermuda in the autumn of 1878 is taken from a letter written to Gen. Sir J. H. Lefroy, C.B., F.R.S., lately Governor of these islands, and author of the "Annals of Bermuda," by the Attorney-General of the islands, Mr. S. Brownlow Gray. The mode of discovery of the crime is so remarkable that I think it ought to be put on record, and Sir J. H. Lefroy has kindly permitted me to make extracts from the letter for that purpose. I believe no account of the circumstances of the case has as yet been published in Europe. There seems to be no likelihood as to mistake regarding the facts. The special occurrence could probably only happen in the tropics in warm water.

H. N. MOSELEY

"In the autumn of 1878 a man committed a terrible crime in Somerset, which was for some time involved in deep mystery. His wife, a handsome and decent mulatto woman, disappeared suddenly and entirely from sight, after going home from church on Sunday, October 20. Suspicion immediately fell upon the husband, a clever young fellow of about thirty, but no trace of the missing woman was left behind, and there seemed a strong probability that the crime would remain undetected. On Sunday, however, October 27, a week after the woman had disappeared, some Somerville boatmen looking out towards the sea, as is their custom, were struck by observing in the Long Bay Channel, the surface of which was ruffled by a slight breeze, a long streak of calm such as, to use their own illustration, a cask of oil usually diffuses around it when in the water. The feverish anxiety about the missing woman suggested some strange connection between this singular calm and the mode of her disappearance. Two or three days after—why not sooner I cannot tell you—her brother and three other men went out to the spot where it was observed, and from which it had not disappeared since Sunday, and with a series of fish hooks ranged along a long line dragged the bottom of the channel, but at first without success. Shifting the position of the boat, they dragged a little further to windward, and presently the line was caught. With water glasses the men discovered that it had caught in a skeleton which was held down by some heavy weight. They pulled on the line; something suddenly gave way, and up came the skeleton of the trunk, pelvis, and legs of a human body, from which almost every vestige of flesh had disappeared, but which, from the

minute fragments remaining, and the terrible stench, had evidently not lain long in the water. The husband was a fisherman, and Long Bay Channel was a favourite fishing-ground, and he calculated, truly enough, that the fish would very soon destroy all means of identification; but it never entered into his head that as they did so their ravages, combined with the process of decomposition, would set free the matter which was to write the traces of his crime on the surface of the water. The case seems to be an exceedingly interesting one; the calm is not mentioned in any book on medical jurisprudence that I have, and the doctors seem not to have had experience of such an occurrence. A diver went down and found a stone with a rope attached, by which the body had been held down, and also portions of the scalp and of the skin of the sole of the foot, and of clothing, by means of which the body was identified. The husband was found guilty and executed."

#### On the Simplest Continuous Manifolds of Two Dimensions and of Finite Extent

THERE appeared in your pages some three years ago (vol. xv. p. 515) an article of mine "On the Simplest Continuous Manifolds of Two Dimensions and of Finite Extent." In a succeeding number a correspondent (Mr. Monro, of Barnet) propounded a query which may be shortly stated as follows:—"How does it happen that the perpendicular on a geodesic from a point moving along another geodesic changes sign without passing through either the value zero (0) or the value infinity ( $\infty$ )?" The problem here suggested is a peculiarly knotty one. In the case of the Euclidian plane the perpendicular of course changes sign by passing through the value  $\infty$ , while in the case of a spherical surface it is equally obvious that the perpendicular passes through zero, since the two geodesics intersect twice. But what are we to say of the strange hybrid surface which formed the subject-matter of my paper? Your correspondent appeared to insinuate that the problem was insoluble, and that the definition of the surface must therefore involve a logical contradiction. For a while I was greatly puzzled by this unforeseen difficulty, but after a little thought came to the conclusion that the perpendicular changes sign by passing through the value  $\frac{l}{2} \sqrt{-1}$ , where  $l$  is

positive and represents the absolute length of a complete geodesic. In other words, I conceived that the sign of the perpendicular changed from + to - by a continuous variation of the real numbers  $a$  and  $b$  in the complex number  $a + b\sqrt{-1}$ . I conceived  $a$  to diminish continuously till, passing through 0, it became  $-a$ , while  $b$  at the same time increased with simple harmonic motion from 0 to a maximum, and then decreased from a maximum to 0.

I was, however, not sufficiently clear on the matter to feel justified in addressing you until I received, the other day, a copy of a paper by Prof. Simon Newcomb, of the United States Observatory, entitled "Elementary Theorems relating to the Geometry of a Space of Three Dimensions and of Uniform Positive Curvature in the Fourth Dimension."<sup>1</sup> The subject-matter of this masterly paper is in reality the simplest continuous manifoldness of three dimensions and of finite extent. It therefore naturally includes all that had been worked out in my own paper and a little more besides. In particular it throws strong light on the difficulty raised by your correspondent. For an exactly parallel anomaly presents itself in the theory of Prof. Newcomb's solid space, and is stated in his 13th Proposition as follows:—"The two sides of a complete plane<sup>2</sup> are not distinct, as in a Euclidian surface." If a being were to travel along a complete plane in a geodesic line, he would, on his return, find himself on the opposite side of the plane to that on which he started, and would have to repeat his journey in order to regain his original poise. "In this property," Prof. Newcomb says, "we find a certain amount of reason for considering the complete plane as a double surface." The corresponding anomaly in space of two dimensions—i.e., the specific feature noticed as an anomaly by your correspondent—is then explained as Proposition XIV.:—"The following proposition is intimately connected with the preceding one. If, moving along a right line, we erect an indefinite series of perpendiculars, each in the same Euclidian plane with the one which precedes it, then, on completing the

<sup>1</sup> Abdruck aus dem *Journal für die reine und angewandte Mathematik* Bd. 83. Druck von G. Reimer in Berlin.

<sup>2</sup> A "complete plane" is a geodesic surface of Prof. Newcomb's space. It is in all respects identical with the surface treated of in my paper.

line and returning to our starting-point, the perpendiculars will be found pointing in a direction the opposite of that with which we started." Here then is the solution of the difficulty. As we move over our surface along a geodesic, the instantaneous Euclidian plane containing the beginnings of successive perpendiculars (for *small initial* portions of two successive perpendiculars to a geodesic will lie in a Euclidian plane) rotates about the instantaneous tangent to the geodesic, and it does not complete a rotation until we have travelled *twice* the complete length of the geodesic. The perpendicular is a vector quantity, and changes sign by passing through  $\frac{1}{2} \sqrt{-1}$ . Also, a geodesic does

not divide the surface into two completely separate regions, as a great circle does a sphere or a straight line a plane. The two regions are continuous with one another, and it is possible to get from the one to the other along a finite path without crossing the geodesic.

F. W. FRANKLAND

Registrar-General's Office, Wellington,  
New Zealand, April 14

#### Ascent of Etna

IT was a bright sunny sky on the last day of April when we started, with Giuseppe Sedici as guide, from the Grand Hotel at Catania in a carriage and pair bound for Nicoloni, *en route* to the summit of Etna. A dusty drive of two and a half hours, and we were at the door of the inn in the centre of the village. Its appearance was somewhat forlorn, and its fare rather meagre, but the civility of mine host compensated for all other defects. Here we engaged two mules, a porter, and a driver, an operation which took more than two hours, and then set off again for the Casa del Bosco, which we reached in the middle of the afternoon after a ride of two and a quarter hours. A climb up a neighbouring hillock to see the sunset, dinner, and a few hours' rest filled up the time till 11 p.m., when we started off again and rode for about half an hour, till the appearance of snow made it necessary to dismount and continue the remainder of the journey on foot. Our guide was very slow, and on any attempt to force the pace stood still and ejaculated: "Fermo, Signore! Piano, Piano!" so that we did not arrive at the Casa Inglese till 5 a.m., and were obliged to content ourselves with seeing the sun rise from here instead of from the top, as we had intended. It did not much matter, as it was a cloudy morning, and the view was very poor, but still it was a disappointment. The Casa Inglese was covered with snow to the eaves of the roof, the observatory buried altogether, the Val del Booe a sea of white. After a short rest we trudged on again; so far it had been good walking up an easy ascent of crisp snow, but now it became a work of difficulty to pick one's way through deep drifts and treacherous-looking holes, which seemed to explain the guide's reluctance to undertake this part of the route by moonlight. Arrived however at the foot of the cone, the snow ceased, and a heavy climb up the frozen side under a biting wind began. Half way up matters were not improved by a severe attack of sickness; but at length the top was reached at 6.20 a.m. There was no distant view; within the crater the steam and smoke kept being blown hither and thither, and cleared off at times sufficiently to show parts of what looked like a bottomless pit. It was a curious and weird sight altogether, and well repaid the fatigues of the journey. During the descent the notes of the cuckoo and some very sweet violets found by chance under the snow reminded us that, notwithstanding the mountain's wintry mantle of white, it was really spring time, and that the morning sun had ushered in the merry month of May, a fact which we had well nigh forgotten but a few hours before, when our fingers were numb with cold and our ears threatened to become a thing of the past.

G.

#### Colour Combinations

THE production of white by red and green solutions is well seen on mixing cobalt and nickel solutions together in proper proportions. Another interesting example is that of electrically deposited copper immersed in a solution of copper sulphate. The first notice of this, so far as I know, occurs in Shaw's "Mannal of Electro-Metallurgy" (1842), p. 33, in the following terms:—

"This phenomenon may be observed in great perfection by the electrolyte; the solution of sulphate of copper is of an intense and pure blue; and the newly-precipitated ductile copper is of

an equally pure orange; let the reader take a vessel containing the cupreous solution and place it in the sun, in order to have an abundance of light, and immerse in it, in a horizontal position, a piece of new electrotype copper; immediately the metal sinks beneath the surface of the blue solution the orange tint fades, and by placing it at a proper depth altogether vanishes, and the metallic plate appears intensely white; when nicely adjusted the plate so much resembles plaster-of-paris that a person unacquainted with the nature of the experiment would with difficulty be persuaded that it was not made of that substance."

Birmingham and Midland Institute, C. J. WOODWARD  
June 14

P.S.—In mixing red and green solutions is it correct to speak of them as *producing* white? I take it that the mixture absorbs more light than the two solutions would do if separate, *i.e.*, the solution of nickel transmits a greenish white, the cobalt solution a reddish white, but together the red and green destroy each other, the excess of white light passing through. This is shown forcibly by using strong solutions, when the deep red and green produce, not white, but black.—C. J. W.

#### Wild Swans—Notes of Birds

THERE are at present eight wild swans in a lake not far from here. I believe them to be part of a flock of sixty which were there all through the winter. Wild swans in summer were never, so far as I know, heard of in this part of the world before. I have always carefully preserved the wild fowl on this lake, and I pay increased attention to the swans, which I hope will be safe from poachers. They swim in pairs, but show no signs of nesting.

The *major* cuckoo noticed in my letter (*NATURE*, vol. xxii. p. 76) is still here without any other *major* that I could find in this place or in the neighbourhood. Referring to your polite correspondent A. N., in p. 97, I must remark, for the fair fame of the cuckoos, that his theory relating to sex seems quite unsustainable. Certainly if all the minor cuckoos about here were males and the single *major* a female it would show an instance of polyandry (if the term can be applied to birds) such as could scarcely be matched in the whole range of natural history. I quite agree with Mr. Newton (p. 122) that the female cuckoo does not sing; and it might perhaps be unamiably suggested that the comparative silence of the females among the lower animals seems among the most marked distinctions between them and the human race.

Regarding Mr. Allen's letter (same page) I can only say that, while his experiences are so different from mine, there must be an imperfection of ear in either of us, and, without any notion of insisting on the correctness of my own, I should like, at least, to hear the testimony of other parties in the matter. Of course I referred to cuckoos in full voice in the height of the season. When their voice begins to decline, their notes vary, and, as a friend of mine expresses it, they "sing *anyhow*."

Millbrook, Tuam, June 18 J. BIRMINGHAM

#### Anchor-Ice

ALLOW me to say in reply to Mr. Rae's kindly criticism (*NATURE*, vol. xxii. p. 54) that I did not assert that the original ice-crystals are "at least as heavy as water," but that they "*seem*" to be so (vol. xxii. p. 81).

I have seen them collect upon stones at the bottom of waterways two or three feet in depth—where the stream though swift was smooth and unbroken,—and I have thought that this might be the result of their having a greater specific gravity than ordinary ice.

In my desire to be concise I had the misfortune to use a phrase that gave Mr. Rae the impression that I was asserting as a fact that which at best I have only regarded as possible.

Boston, June 7 C. F. C.

#### SCIENTIFIC RESULTS OF THE HOWGATE POLAR EXPEDITION, 1877-78

THE fifteenth *Bulletin* of the United States National Museum (Washington, 1879) consists of contributions to the Natural History of Arctic America, made in connection with the Howgate expedition in 1877-78, by Ludwig Kumlien, naturalist to the expedition, who gives

a most valuable and interesting account of his ethnological observations and important notes on the habits of the birds and mammals of the region explored. Capt. Howgate's expedition was one which had several different ends in view. The primary object of it was the collection of skins, sledges, dogs, Eskimo, and other necessaries for a future colony in Lady Franklin Bay. A secondary object was scientific exploration, whilst the only remuneration of the crew was derived from ordinary whaling operations, every one excepting the scientific men on board the *Florence* having a "lay" in the voyage. The *Florence*, in which the voyage of the expedition was made, was a fore-and-aft schooner of fifty-six tons, which had before been engaged in sealing in the southern seas. Mr. Kumlien necessarily found so small a vessel extremely disadvantageous for scientific operations. He had to leave valuable skeletons of mammalia behind, and could have procured more in addition, if only stowage room had been available.

The explorations of the expedition were made in Hogarth Sound on the western coast of Davis Straits. Hogarth Sound, the Cumberland Straits of Baffin, lies in Baffin's Land, and its western coast is called Penny's Land, after Capt. Penny, who visited it in 1839. The northern part of the Sound is crossed by the Arctic Circle. The Sound is about thirty miles wide at its widest part, its length is uncertain, but over 150 miles. It has been frequently visited by Scotch and American whalers during the last twenty-five years.

The *Bulletin* commences with a long paper by Mr. Kumlien on the Eskimo of the Sound, from which we gather the following interesting statements. The natives are fast diminishing in numbers, and the total population of the Sound is estimated by the author at not more than 400 individuals. The Eskimo are peaceful now, but have numerous traditions of former wars, in which they relate that the hurling of stones was the most effective and common mode of warfare.

The natives have, as usual, suffered by contact with white men, and the Hogarth Sound Eskimo of to-day, with his breech-loading rifle, steel knives, cotton jacket, and all the various trinkets he succeeds in procuring from the ships, is worse clad, lives poorer, and gets less to eat than did his forefathers, who had never seen or heard of a white man. He barter a seal-skin that should have been used for repairing the tent, for a little tobacco, or some valueless trinket which is soon thrown aside.

The children are, when young, quite fair; the adults are so begrimed with soot and grease, that it is impossible almost to tell their real colour, but there are some pure bred Innuits whose skins are no darker than a white man's would be if subjected to the rigours of wind and cold.

"There are at present so many whaleboats owned by the Eskimo, that they experience little difficulty in making quite extensive cruises, three or four families constituting a boat's crew. They will load a whale-boat to within an inch or two of the gunwale, and then set out for a few weeks' enjoyment and abundance. The squaws do the rowing and the captain stands majestically in the stern with the steering-oar, whilst the rest of the men are either asleep or on the look-out for game. The cargo consists of the tent-poles, the skin-tents, pots, and lamps, with sundry skin-bags containing the women's sewing and skinning utensils. The hunting-gear forms, of course, quite a conspicuous portion of the contents of the boat. Very few there are at present who have not become the possessors of half a barrel, and this vessel occupies a conspicuous place in the boat, and is constantly receiving additions of animal matter in some shape; a few young eiders or gulls will soon be covered up with the intestines of a seal and its flesh. From this receptacle all obtain a piece of meat whenever they feel hungry. This vessel is never emptied of its contents except by accident or

when scarcity of material forbids its repletion; and as the temperature at this season is well up in the sixties during the day, this garbage heap becomes so offensive as to be unbearable to any but an Eskimo."

The powers of endurance of these Eskimo appear to be no better than those of whites. Few of them could stand a tramp through the snow all day long better than the members of the expedition, but, as in the case of other savages, it was in "tracking" that they showed their superiority most markedly. "They will follow animal tracks in the snow for a whole day when we confess we could not discover the faintest trace of a track except at long distances apart."

The women's dress differs from that of the men in that their trousers are composed of three separate pieces, the lower reaching from a little below the knee to the middle of the thigh; when at work in their igloos they take off the lower pieces and use their bare thighs as boards for cleaning sealskins on. Amongst most races, as in England, the dress of young children—both boys and girls—resembles that of their mothers, but Eskimo little girls wear trousers like those of the men, made all in one piece, until they are twelve years old.

Most of the Eskimo cannot count higher than ten, and many not higher than six; some are said to have numbers to twenty, but they are few. The names of the same numerals are differently pronounced, and difficulty was experienced in finding a native who knew the names well enough to give them all up to ten.

When a woman is about to be confined she is placed in a small skin tent in summer or a small snow hut in winter, with a little girl only to attend her. This is done for fear the mother or child may die, in which case the tent and all in it could never be used again. For the same reason any native when very ill is carried out to die. In some instances this custom is obliged to be modified. For example, a tent cover thus under tabu is sometimes cut off at about two feet from the ground all round, and the top is used. In one case a man's wife shot herself accidentally in her igloo; the gun was too great a sacrifice for the husband; he used it, but everything else was left to waste away where it lay. After the birth of the child the mother, with the child on her back, is conducted by an aged female ancot to a level spot on the ice, where a curious ceremony of marching in circles is performed.

The following legend gives directions as to how a person may become an ancot or *ang'kok*. It is interesting because it does not differ essentially from the Greenlanders' account of the same thing. An "ancot" may be regarded as the most primitive representative of the priestly office.

"Any one wishing to be an ancot must go away a long distance from where there is any other person. Then he must find a large stone and seat himself by it, and call on *Torngarsuk* (the greatest spirit of good and evil; the name is now used by instructed natives for the devil). This spirit will then make himself present to him. The would-be ancot will at first be very much frightened at the arrival and appearance of the spirit, so much so that he is seized with severe pains and falls down and dies, and remains dead for three days. Then he comes to life again, and returns home a very wise man."

An ancot's duty is, first, to heal the sick by muttering over them; secondly, to talk to *Torngarsuk* and get useful information; thirdly, by this means to foretell deaths and misfortunes. He leads in such ceremonies as the killing of the evil spirit of the deer, an extraordinary jumping, shouting, and stabbing performance directed against an imaginary deer. A successful ancot of long standing may reach higher grade and become a great ancot by means of periods of fasting and an existence for a time in the condition of a walrus.

If an ancot's prophecy does not come to pass, he says that a halo, corona, aurora, or some such phenome-

non which has occurred has broken the spell; but often he is truly oracular in his utterances, as in a case overheard by the author, in which one was asked by a young woman if her child would be a boy or a girl. He went outside the hut for a time, and on returning said it would "be a boy," but "if it is not a boy it will be a girl." His fee for this was three sealskins and a knife.

The Hogarth Sound Eskimo, unlike the Greenlanders, have no permanent habitations. They live in snow houses (*igloos*) till June, when the snow melts, and then take to their skin tents or *toopiks* till the latter part of October, when they build igloos again.

A detailed account of the mode of making of the igloos is given, and a horrible one of the condition of the inhabited interior. Behind and around the lamps the Eskimo pile up their meat, and the pile soon becomes extremely offensive both to sight and smell. Meat is sometimes brought in that is already spoiled, although the temperature may be 50° below zero. This often happens with deer, which, unless disembowelled as soon as killed, rapidly decompose inside before freezing through.

Bows and arrows have been discarded for fire-arms, but are, as usual amongst other races, maintained in use by the children, who kill snow-birds and lemmings with them. The Eskimo are not very expert at making traps or snares apparently, but the simple box-trap of ice for foxes seems to be very effective. The slab of ice which falls and closes it is simply supported by a small upright of ice resting on the bait, and comes down directly the fox pulls at the meat. The author tried steel traps for the foxes, without success; the wily foxes always dug under the traps in the snow, and got at the bait from below.

Nearly all the Eskimo become snow-blind in spring, and generally do not put on their well-known wooden eye-blinkers until the condition of their eyes forbids their going out without them.

The ceremony of greeting a stranger on his arrival at a village is curious, and ends by the ancoot and the stranger stepping out before the villagers and dealing one another alternately a knock-down blow on the cheek, the ancoot of course having first hit: the two then kiss. In another ceremony vestments are used, that is to say, the ancoot puts on a great many pairs of trousers, as a preparation. Formerly all the implements of a dead man were left to rot in his grave, as amongst other American races and so very many peoples in various parts of the world, but of late years the Eskimo have amended this usage, and after the things have remained a short time in the grave, they are taken out and used again by the relatives. In very recent graves tin cups and pots, knives, and even one fork, a photograph, and a *Harper's Weekly Newspaper* were found, a fact which reminds us of having seen a sewing machine rusting on the grave of a Chinook woman in Oregon.

Charms of very various kinds are worn about the person by the Eskimo, and much prized and handed down for generations; one such consisted of two small stones, one a bluish flint, the other apparently meteoric iron. An ancestor discovered by accident that the two would strike fire, and became, in consequence of their possession, a great man amongst the people. The old woman to whom this charm belonged, considered it of inestimable value, for she said, "No one has yet died while wearing this charm." The ancoots are often very expert jugglers. A common trick is for one of them to come into a hut with a harpoon toggled in his breast and the handle sticking in his back, the wound bleeding profusely.

Of the creation of man the Eskimo say: "In the beginning there grew up from the earth a man; he got a wife from one of his *thunbs*, and from this pair the race has originated. But the whites, whom they call *cablunet*, or *codlunak*, they have sprung from dogs. An Eskimo woman at one time gave birth to human beings and dogs.

The latter she put in an old boot, and threw them out into the sea, saying, Go hence, and become white people. From this it happens that the whites live on the sea and their ships are like Innuits' boots, round at both ends. This is a very different notion from the Australian "tumble down, black fellow, jump up, white fellow," and less complimentary to the pale faces.

A good deal of the information about the Eskimo given by the author is of course not new, but the descriptions are very fresh and good, and it is of importance to have so full an account of the present condition of the natives of the west coast of Davis Straits.

An account of the mammalia of Hogarth Sound by the same author follows the ethnological ones. The mammalia seem to be disappearing from the neighbourhood with great rapidity. Bears, walrus, and the hooded seal are very scarce up the sound, and of the musk-ox the traces remain only in the personal name "omingmuk," which is used commonly amongst the Eskimo, who know the animal well as found far to the north.

In the account of the Eskimo dogs the curious theory is upheld by Mr. Kumlien that the peculiar rabies of which they so commonly die is produced in the males by unrequited affection towards the opposite sex, and instances in proof are cited. At least four-fifths of the dogs so dying are males.

There is an interesting account of the various seals of the coast and their habits, and of the modes of catching them adopted by the Eskimo, and also of the whales. The author has known the white whales (*Beluga catodon*) to come in close proximity to the ship and lie along her sides for protection when pursued by the grampus or killer, *Orca gladiator*. The white whales ascend the sound as soon as the ice begins to loosen, but for what purpose seems uncertain; the mothers already have their young with them, and as little or nothing is found in the animals' stomachs when killed, they do not appear to go up the sound for food. In July they repair in hundreds to the sand-beaches of the fjords. The author suggests that perhaps they roll against the sand to free themselves of parasites. Numerous seals (apparently *Pagomys fatidus*) were found inhabiting a fresh-water lake, Lake Kennedy, lying at a considerable distance inland.

In the account of the birds, also by Mr. Kumlien, some curious notes on the habits of ravens, which are extraordinarily common on the sound, are given. Six or seven hunting in company soon kill a young reindeer, and "in the capture of the young seal, *Pagomys fatidus*, the birds evince a considerable degree of intelligence. I have on different occasions witnessed them capture a young seal that lay basking in the sun on the ice near its hole. The first manoeuvre of the ravens was to sail leisurely over the seal, gradually lowering with each circle, till at last one of them suddenly dropped directly into the seal's hole, thus cutting off its retreat from the water. Its mate would then attack the seal, and endeavour to drag or drive it as far away from the hole as possible. The attacking raven seemed to strike the seal on the top of the head with its powerful beak, and thus break the tender skull. In two instances I allowed the combat to proceed until the seal was killed, and then drove the ravens away. I found no marks upon the seal except those of the blows upon the head, which had fractured the skull in two places." Two ravens were seen to chase a hare in concert and kill it.

We regret that we cannot follow the author further.

The *Bulletin* contains lists of the fishes collected in addition, by Mr. T. H. Bean, with descriptions of species; of the crustacea by Mr. S. S. Smith; of the annelides; tunicata, bryozoa, echinoderms, and coelenterates by Prof. Verrill; of the mollusca by Mr. W. H. Dall; of the insects by Messrs. Edwards and Scudder; and of the plants by Prof. A. Gray and Messrs. E. Tuckerman and W. G. Farlow.

*EXPERIMENTAL RESEARCHES IN  
ELECTRICITY*<sup>1</sup>  
II.

THE experiments were made in a bell-jar, containing the terminals, which could be gradually exhausted after having been filled with air or other gas. One of the terminals was fixed to the bottom plate, the other could be adjusted to any distance from it by a rod sliding through a stuffing-box in the glass cover. The foot of the stand was insulated by a disk of ebonite, on which it stands. One such bell-jar is  $9\frac{1}{4}$  inches (23.4 centims.) high, and  $5\frac{1}{4}$  inches (14.9 centims.) in diameter; its cubical content, ascertained by covering the open ends with glass plates and filling with water from a graduated measure, was found to be 3.787 cub. centims.

which would have been produced if an empty bladder had been suspended between the terminals and suddenly inflated and as suddenly emptied.<sup>2</sup>

The following experiment in rarefied air, at a pressure of 56 mm., at a temperature of  $17^{\circ}.5$  C., will give an idea of the amount of instantaneous expansion which occurs when the terminals are connected with the poles of the battery of 11,000 cells, current 0.01102 W; the resistance of the bell-jar was reproduced by substituting 600,000 ohms wire resistance.

Distance of the terminals—the top one a point, the lower a disk—6 in. ;	mm.	M.
pressure	56	... 73,684
On making contact the arc passed and the column of mercury was depressed	... 15.8	... 20,789

Pressure on connection ...  $71.8 = 94,473$

The increased was to the normal pressure in the ratio of 1.282 to 1; as the gas was kept at a constant volume, and supposing the expansion to be due to an increase of temperature, the pressure would vary as the absolute temperature,<sup>3</sup> therefore

$$\frac{T'}{T} = \frac{71.8}{56} = 1.282, \text{ whence}$$

$$T' = 1.282 \times 291.2 = 373^{\circ}.3 \text{ C. ;}$$

$$(373.3 - 273.7) = 99^{\circ}.6 \text{ C.,}$$

the temperature of the bell-jar, and  $(99.6 - 17.5) = 82^{\circ}.1$ , the rise of temperature while the discharge was taking place. But the temperature of the bell-jar as determined by a thermometer inclosed in it with its bulb uppermost only rose  $0^{\circ}.64$  C. per second, taking into account the rate of cooling. It is evident, therefore, that the increase of pressure cannot be ascribed to the instantaneous heating of the bell-jar  $82^{\circ}$  C.

Taking the dimensions of the arc from a photograph shown in the plate, Fig. 30, it was calculated that it must have attained the enormous temperature of  $16,114^{\circ}$  C., if the increase of pressure was really due to heat. It was found that platinum wires 0.001 inch in diameter supported in various parts of the arc, as shown in the plate, Fig. 30, were immediately fused; the temperature of the arc was therefore as high as the fusion-point of platinum, and possibly considerably higher.

If the whole of the heat evolved by a current of 0.01102 W, through a resistance of 600,000 ohms had been communicated to the air in the jar, weighing 0.339 gm., it would raise it  $215^{\circ}.6$  C. in one second. It is known from direct experiment that this enormous evolution of heat was not communicated to any extent to the air in the bell-jar, because its temperature only increased about  $0^{\circ}.64$  C. per second; the heat must consequently

have escaped almost instantaneously by radiation. It is difficult consequently to realise the conjecture that the enormous dilatation which occurred instantaneously could have been caused by increase of temperature. And it points to its being produced by a projection or scattering of the molecules by electrification causing them to press outwards against the walls of the containing vessel, this pressure being distinct from the motion caused by heat.

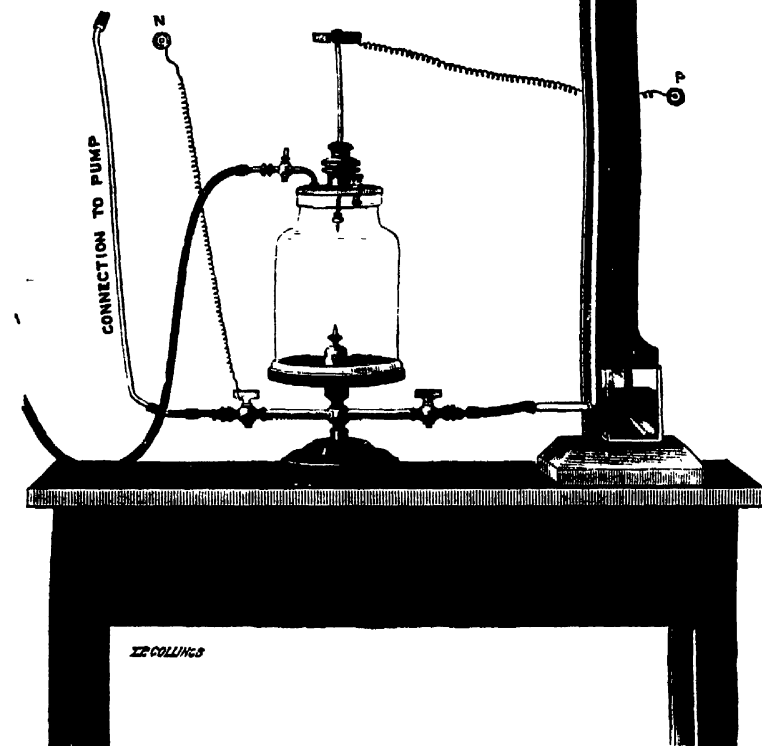

FIG. 3

A remarkable phenomenon was observed on making connection between the terminals and the battery by means of the discharging key, namely, that within certain limits of pressure in the bell-jar a sudden expansion of the gas took place, and that as soon as the connection was broken the gas then as suddenly returned nearly, but not quite, to its original volume in consequence of a slight increase of temperature. The effect was exactly like that

<sup>1</sup> "Experimental Researches on the Electric Discharge with the Chloride of Silver Battery," by Warren De La Rue, M.A., B.C.L., F.R.S., and Hugo W. Müller, Ph.D. F.R.S. Continued from p. 153.

<sup>2</sup> De la Rive noticed that oscillations occurred in the mercury of a gauge attached to an exhausted tube as soon as the current passed.

<sup>3</sup> Absolute zero =  $273.7$  C.,  $273.7 + 273.5 = 547.2$



The authors proceed to describe the appearance of the arc with terminals of various forms at different distances and with various pressures. It was found that the light emitted by different parts of the arc was not of the same intensity throughout, and that from the first there was a tendency to break up into distinct entities, as shown at A, B, C, D, E, F in the diagram, Fig. 4, which only indi-

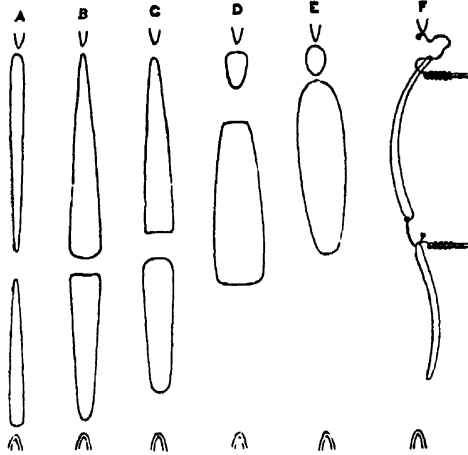

FIG. 4.

cates the central bright portion of the arc, this never quite reached the negative terminal, near which there was always the well-known dark discharge.

As the pressure was diminished the arc widened out, until at last the entire surface of the negative disk was covered with a luminous halo, and the discharge took up a stratified appearance.

The appearances presented by the arc in air, hydrogen, and carbonic acid are illustrated by copies of photographs and drawings in mezzotint, as shown in the Plate.

*The arc in air between two points at various distances and pressures with a constant number of cells. Temp. 127° C. The references are to the Plate*

11,000 cells, distance 0.54 inch, pressure atmospheric, current 0.02456 W; the total resistance of battery and arc was found to be 461,500 ohms, that of the arc, by substituting wire resistance, 27,550; whence the potential between the terminals was 657 cells. The appearance of the arc is shown in the plate, Fig. 20; it exhibits clearly the tendency to break up into luminous entities; the photograph of which this is a copy is nearly full size, and was obtained in twenty seconds. All the other copies of photographs are on a reduced scale. As the batteries were undergoing the annual overhauling, the number of cells, some being removed from time to time, was somewhat less in the following experiments, namely, 10,940.

Fig. 1, from a photograph obtained in 10 seconds.—Pressure atmospheric 748.6 mm., 985,000 M, distance 0.58 inch, current not observed, no depression of the mercury in the gauge was noticed; indeed, it will be seen that at the higher pressures the depression is generally less than at the lower, up to a certain point.

Fig. 2, from a photograph in 15 seconds.—Distance 0.58 X 2 = 1.16 inch, pressure 294.9 mm., 388,026 M, current 0.02881 W, depression 16 mm., total pressure 294.9 + 16 = 310.9; ratio of increased to normal pressure as 1.054 to 1. It will be observed that the central spindle has become bifurcated about midway.

Fig. 3, from a photograph in 15 seconds.—Distance X 3 = 1.74 inch, pressure 191.3 mm., 251,711 M, current 0.04060 W, depression 17 mm., total pressure 208.3 mm.; ratio of increased pressure 1.089. The bifurcation is apparent in this also.

Fig. 4, in which the central spindle is broken up into several luminosities.—Distance X 4 = 2.32 inches, pressure 142.6 mm., 187,631 M, current 0.04474 W, depression 19 mm., total pressure 161.6 mm.; ratio of increased pressure 1.133.

Fig. 5, from a photograph in 15 seconds; in this the central spindle is split up into bright entities connected by less bright portions.—Distance X 5 = 2.9 inches, pressure 112.6 mm., 148,157 M, current 0.03459 W, depression 19 mm., total pressure 131.6; ratio of increased pressure 1.169.

Fig. 6, from a photograph in 15 seconds. The luminous entities still seen, but are less marked.—Distance X 6 = 3.48 inches, pressure 99.4 mm., 130,789 M, current 0.03071 W, depression 21 mm., total pressure 120.4 mm.; ratio of increased pressure 1.211.

Fig. 7, from a photograph in 15 seconds.—Distance X 7 = 4.06 inches, pressure 85.9 mm., 113,026 M, current 0.03259 W, depression 22 mm., total pressure 107.9 mm.; ratio of increased pressure 1.256. The central spindle is divided into two luminosities, with a tendency to form a third near the negative.

Fig. 8, from a photograph in 15 seconds.—Distance X 8 = 4.64 inches, pressure 71.6 mm., 94,210 M, current 0.02693 W, depression 22 mm., total pressure 93.6 mm.; ratio of increased pressure 1.307. The central spindle nearly of the same character as Fig 7.

Fig. 9, from a photograph in 15 seconds.—Distance X 9 = 5.22 inches, pressure 65.5 mm., 86,184 M, current 0.02693 W, depression 22 mm., total pressure 87.5 mm.; ratio of increased pressure 1.336. The bright entities show a tendency to break up into less bright portions.

Fig. 10, from a photograph in 15 seconds.—Distance X 10 = 5.8 inches, pressure 64.4 mm., 84,737 M, current 0.03071 W, depression 20 mm., total pressure 84.4 mm.; ratio of increased pressure 1.310. The arc resembles that seen in Fig. 9.

The appearance of the arc between disks in hydrogen at the various pressures used in determining the potential necessary to produce a discharge, is represented in the plate, Figs. 11-19.

	M	Cells	Seconds
Fig. 11 at pressure of	18,684, w. th	600, from a photograph taken in	50
" 12 "	58,684 "	1200 "	50
" 13 "	141,974 "	2400 "	50
" 14 "	252,368 "	3600 "	50
" 15 "	386,316 "	4800 "	40
" 16 "	558,816 "	6300 "	4
" 17 "	558,816 "	6300 "	2
" 18 "	651,316 "	7760 "	5
" 19 "	1,008,421 "	10,920 "	5

*The arc in hydrogen between two points. Temp. 16° 2 C., 10,940 cells*

Distance 0.75 inch, pressure 745 mm., 980,263 M, current 0.01575 W, the appearance is represented in the plate, Figs. 21 and 22, the first copied from a photograph obtained in 5 seconds, the second in 15 seconds. The central spindle breaks into a brush-like form towards the negative, there is then a dark interval between it and the glow on the negative.

Fig. 26, from a drawing.—Distance 0.9 inch, pressure 745 mm., 980,263 M, the discharge passed intermittently, so that the current could not be read off on the galvanometer. The appearance is represented full size.

Figs. 23, 27, 28.—Distance 0.9 X 2, 1.8 inch, pressure 385.6 mm., 507,368 M, current 0.01575 W, depression] 14 mm., total pressure 399.6 mm., ratio of increased pressure 1.04. Fig. 23 is from a photograph in 13 seconds. The distance between the brush-like termination of the central spindle and the glow on the negative has relatively increased. Figs. 27 and 28 are other representations copied from drawings.

Fig. 24, from a photograph in 15 seconds.—Distance X 3, 2.7 inches, pressure 317.8 mm., 418,158 M, current 0.00580 W, depression 13 mm., total pressure 330.8 mm.,

with increased pressure 104. The central spindle is still shorter. At times only the terminals were stratified, but sometimes strata formed on the positive terminal. Fig 29 is another representation copied from a drawing.

Fig. 25.—Distance  $\times 4$ , 3.6 inches, pressure 170.5 mm., 324.34 M., 6300 cells, current not measured. The central spindle has decreased relatively still more.

Fig. 30. Distance  $\times 7$ , 6.3 inches, pressure 3 mm., 3947 M., 1200 cells, the bottom point positive current 0.03906 W, a splendid stratification, though somewhat unsteady; the figure partly copied from a photograph, partly from drawings. It was thought at first that well defined strata would not be formed in a jar of such large diameter with the quantity of current at disposal, but this experiment shows that this conjecture was unfounded. The negative glow completely fills the neck of the jar.

Fig 31—Distance 6.3 inches, pressure 2.4 mm., 3156 M., 1200 cells, current 0.03728 W, a very steady stratification when the bottom point was positive, this curious stratification completely overlapped the whole surface of the bottom point and the brass holder, as if pushed back by a force emanating from the negative, the glow around the negative completely filled the upper portion of the jar.

An inner tube was now inserted in the bell jar in order to ascertain whether the contraction of the space surrounding the discharge would have any effect on the production of strata. A number of holes had been drilled in opposite sides of the tube, which is 8 inches long and 1.8 inch in diameter. These holes were drilled with the object of straining very fine platinum wires across at different heights for ascertaining the temperature of the arc at these positions, but in the experiments about to be described there were no wires.

The bell-jar was refilled with hydrogen and exhausted, distance of points 6.3 inches, pressure 2 mm., 2.635 M., 2,400 cells; when the top point was positive there was a production of ordinary strata resembling (Fig 32). But when the bottom was positive a very remarkable phenomenon was observed, namely, the production of strata through the small holes,  $\frac{1}{8}$  inch in diameter, in the walls of the inner tube, this being accompanied by an overpouring of negative discharge above the top of it (Fig 33). It seemed as if the positive discharge sought a complete neutralisation with negative electricity beyond the confines of the tube, the area of which was too small to permit of complete relief. The close confinement of the discharge at the bottom end of the tube which rests on the glass plate of the pump may account for the non-oozing out of strata through the holes when the top point was positive.

Some gas let in, pressure 4 mm., 5.763 M., 2,400 cells, current 0.13470 W, a well defined stratification occurred when the bottom point was negative, but no oozing out through the holes in the tube, Fig. 32.

In order to prosecute their experiments in a vessel of still greater capacity, the authors had constructed a larger jar with a neck at each end, or more properly speaking, perhaps, a tube supported horizontally on ebonite crutches. It is 37 inches long and 5.3 inches in diameter, its cubical content was found to be 14,435 cub centims, or 3.8 times that of the bell-jar employed in the experiments on the electric arc. The tube is shown in Fig 5.

The experiments with this tube will necessarily occupy a considerable period, partly on account of the long time it takes to exhaust it after each set, partly on account of the variety of experiments it is intended to make with it, consequently they describe only a few of the first results obtained.

For Example in Air

Pressure 3 mm., 2.047 M., 6,300 cells. Part luminous

nebidity which completely filled the end of the tube. The tube glowed brilliantly with a blue fluorescence which proved to have great actinic power. A dry-plate photograph obtained in five seconds records a very curious phenomenon, namely, that the outer boundary of the



Luminosity appears darker than the tube (Fig. 30). It is to be remarked that while the discharge was red (nitrogen), the fluorescence of the tube was blue; effect appears to be due to the absorption of a color

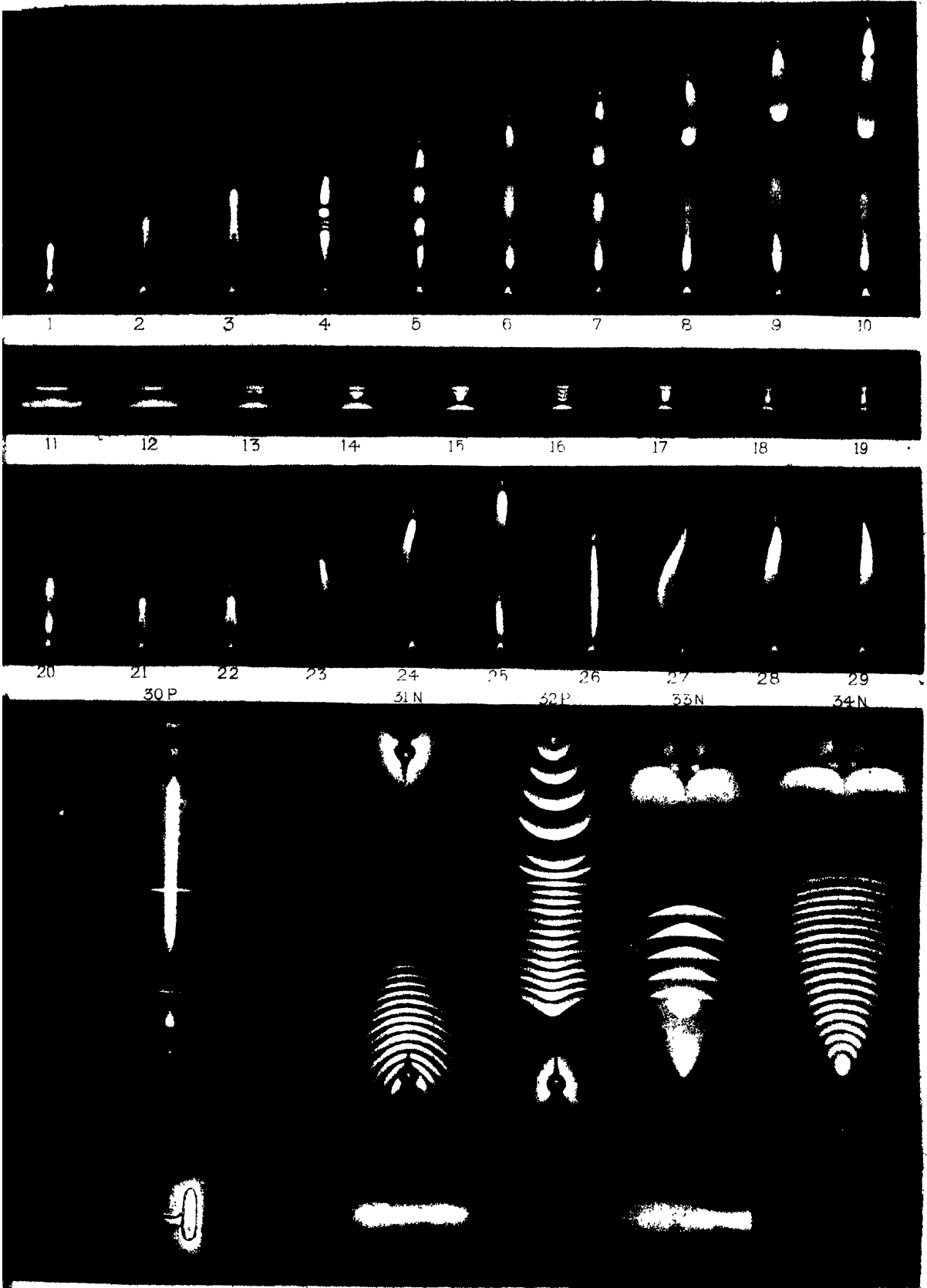



tube in passing through the red luminosity. The effect was quite unexpected, and it was thought at first that it might have arisen from some peculiarity in the development of the dry plate; it was not therefore until the result had been confirmed by other photographs that they ventured on the explanation above given.

A few experiments were made with hydrogen in this same tube; and the appearances observed are shown in Fig. 6, A B C.

Pressure 22 mm., 28,948 M, 11,000 cells, current 0.01412 W. The glow on negative extended to three-eighths of an inch, a spear-head luminosity on the positive wire, to which it was attached by a very bright wire-like stem not greater in diameter than the terminal, A (Fig. 6).

Pressure 15 mm., 19,737 M, 11,000 cells, current 0.03071 W. A spindle-shaped luminosity at the positive about  $1\frac{1}{2}$  inch long, and the negative ring completely surrounded with a glow which had increased considerably since A.

After a short time the spindle on the positive lengthened out and nearly reached the negative, hugging the under-side of the tube as in B (Fig. 6). It was not sensitive to the approach of the finger, although close to the glass; 6,300 cells produced the same phenomena.

Pressure 4 mm., 5,263 M, 6,300 cells, current 0.03459 W. The discharge in the latter case was partially stratified, C.

The paper closes with the following conclusions:—

1. For all gases there is a minimum pressure which offers the least resistance to the passage of an electric discharge. After the minimum has been reached, the resistance to a discharge rapidly increases as the pressure of the medium decreases. With hydrogen the minimum is 0.64 mm., 842 M; at 0.002 mm., 3 M, it is as great as at 35 mm., 46,000 M.

2. There is neither condensation nor dilatation of a gaseous medium in contiguity with charged terminals.

3. When the discharge takes place there is a sudden

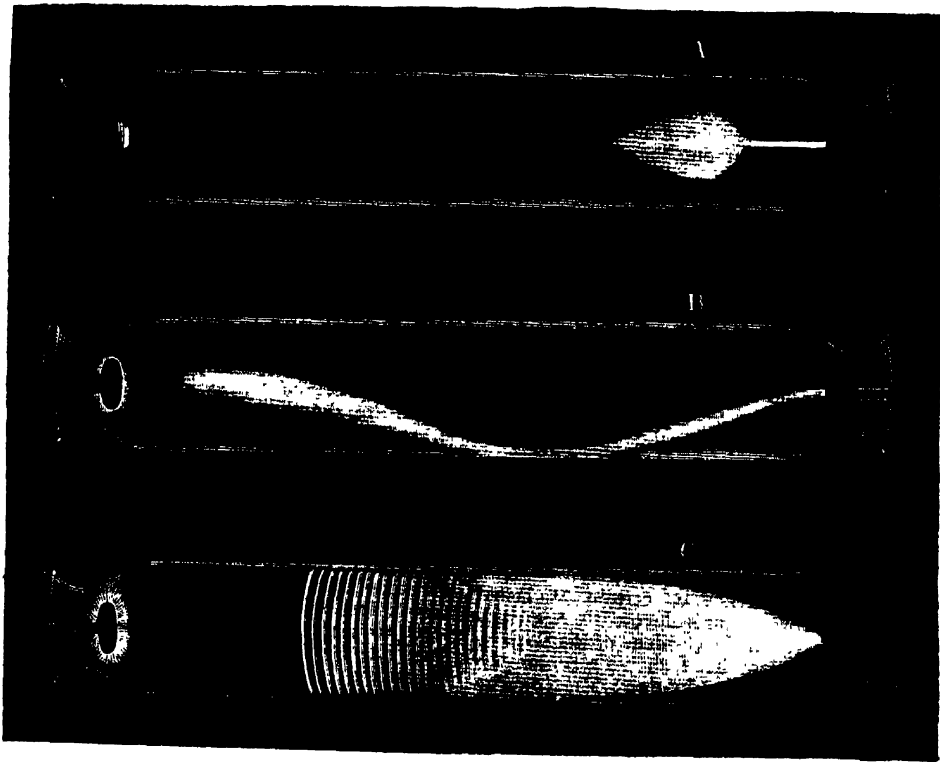

dilatation of the medium in addition to, and distinct from, that caused by heat. This dilatation ceases instantaneously when the discharge ceases.

4. The potential necessary to produce a discharge between parallel flat surfaces at a constant distance and various pressures, or at a constant pressure and various distances, may be represented by hyperbolic curves. The resistance of the discharge between parallel flat surfaces being as the number of molecules intervening between them.

5. This law does not hold with regard to points. In Part I. it has been shown that the potential necessary to produce a discharge at the atmospheric pressure and various distances is as the square root of the distances, while with a constant potential and various distances, the pressure has to be diminished in a greater ratio than that of the increase of distance in order to permit a discharge to take place.

6. The electric arc and the stratified discharge in

vacuum tubes are modifications of the same phenomenon. Lastly, the authors say:—

“We have again pleasure in thanking Prof. Stokes for his much-valued advice during the course of our investigations. To our assistant, Mr. Fram, we are indebted for his able co-operation; and we have to thank Mr. H. Reynolds for his aid and skill in taking photographs.”

#### THE NEW FRESHWATER JELLY FISH

WE have received the following communications on this subject:—

##### The Freshwater Medusa

WHEN I last week sent you an account of the new genus of freshwater Medusæ, to which I gave the name *Craspedacustes*, I was not aware that Prof. Allman had prepared, or even that he was intending to prepare, an account of the same animal for the Linnean Society's

meeting of Thursday (your day of publication). The specimens on which I worked were given to me by Mr. Sowerby, the secretary of the Botanical Society, who discovered the animal, and in reply to my particular inquiry as to whether any naturalist had been charged by him with the task of working it out, he said that no one had, but that he had freely given specimens to several gentlemen. He asked me to find a name for the new Medusa, and I promised to send him a copy of what I should publish on the subject.

I hold it to be a very excellent thing that there is a certain kind of honour attaching to the priority of description of new and important genera among zoologists. It appears to me to give a zest and stimulus to hard work in the cause of zoology which is very far from being a thing to be despised. I confess to having worked at that Medusa day and night when I first obtained it, with the object of having the pleasure and honour of being the first to expound its structure to my brother naturalists.

At the same time I wish to say that had I known that so esteemed and veteran a zoologist as Dr. Allman was anxious to associate himself with this little novelty, I should have felt it to be only consistent with the great personal regard which I entertain for him to abstain from any publication on the subject until he had come forward to provide the new Medusa with a name, which I am sure would have been a prettier one than my somewhat unwieldy proposal.

Under these circumstances it gives me great pleasure to say that, so far as I am concerned, I am quite willing to give up the name *Craspedicustes*, and to adopt Prof. Allman's name for the new freshwater Medusa whenever he may publish it.

I have no doubt that we shall shortly hear a great deal more about the freshwater Medusa, since it is very abundant in the Regent's Park lily-house, and since Mr. Sowerby, with true scientific liberality and courtesy, freely allows naturalists who desire specimens to provide themselves with such, and has very properly placed no restriction upon their study or on the publication of results.

E. RAY LANKESTER

On "*Limnocoedium victoria*," a Hydroid Medusa of Fresh Water

A SHORT time since I received from Mr. Sowerby, Secretary of the Royal Botanical Society, a letter informing me of the occurrence of certain Medusoid organisms in the warm-water tank devoted to the cultivation of the *Victoria regia* in the Gardens of the Society. The letter contained a request that I should examine the animals with a view to their determination; Mr. Sowerby accompanied it with rough sketches, and offered to place specimens at my disposal for investigation.

The discovery of true freshwater Medusæ was so startling a fact that I lost no time in calling on Mr. Sowerby, with whom I visited the tank, and carried away such specimens as were needed for examination.

The water in the tank had then a temperature of 86° F., and was literally swarming with little Medusæ, the largest of which measured nearly half an inch in transverse diameter. They were very energetic in their movements, swimming with the characteristic systole and diastole of their umbrella, and apparently in the very conditions which contributed most completely to their well-being.

As it now became evident that the Medusa belonged to a generic form hitherto undescribed, I prepared for the Linnean Society a paper containing the results of my examination, and assigning to the new Medusa the name of *Limnocoedium victoria* (λίμνη, a pond, and κώδων, a bell). This was received and recorded by the secretaries on June 14, and read at the next meeting, on the 17th.

<sup>1</sup> Some facts in addition to those contained in my original paper are included in the present paper.

The umbrella varies much in form with its state of contraction, passing from a somewhat conical shape with depressed summit through figures more or less hemispherical to that of a shallow cup or even of a nearly flat disk. Its outer surface is covered by an epithelium composed of flattened hexagonal cells with distinct and brilliant nucleus. The manubrium is large; it commences with a quadrate base, and when extended projects beyond the margin of the umbrella. The mouth is destitute of tentacles, but is divided into four lips, which are everted and plicated. The endoderm of the manubrium is thrown into four strongly-marked longitudinal plicated ridges.

The radial canals are four in number; they originate each in an angle of the quadrate base of the manubrium, and open distally into a wide circular canal. Each radial canal is accompanied by longitudinal muscular fibres, which spread out on each side at the junction of the radial with the circular canal.

The velum is of moderate width, and the extreme margin of the umbrella is thickened and festooned, and loaded with brownish-yellow pigment cells.

The attachment of the tentacles is peculiar. Instead of being free continuations of the umbrella margin, they are given off from the outer surface of the umbrella at points a little above the margin. From each of these points, however, a ridge may be traced centrifugally as far as the thickened umbrella margin; this is caused by the proximate portion of the tentacle being here adnate to the outer surface of the umbrella. It holds exactly the position of the "mantelspangen" or *peronia*, so well developed in the whole of the *Narcomedusæ* of Hæckel, and occurring also in some genera of his *Trachomedusæ*. Its structure, however, differs from that of the true *peronia*, which are merely lines of thread-cells marking the path travelled over by the tentacle as the insertion of this moved in the course of metamorphosis from the margin of the umbrella to a point at some distance above it, while in *Limnocoedium* the ridges are direct continuations of the tentacles whose structure they retain. They become narrower as they approach the margin.

The number of the tentacles is very large in adult specimens. The four tentacles which correspond to the directions of the four radial canals or the perradial tentacles are the longest and thickest. The quadrant which intervenes between every two of these carries, at nearly the same height above the margin, about thirteen shorter and thinner tentacles, while between every two of these three to five much smaller tentacles are given off from points nearer to the margin, and at two or three levels, but without any absolute regularity; indeed, in the older examples all regularity, except in the primary or perradial tentacles, seems lost, and the law of their sequence ceases to be apparent.

I could find no indication of a cavity in the tentacles; but they do not present the peculiar cylindrical chorda-like endodermal axis formed by a series of large, clear, thick-walled cells which is so characteristic of the solid tentacles in the *Trachomedusæ* and *Narcomedusæ*. From the solid tentacles of these orders they differ also in their great extensibility, the four perradial tentacles admitting of extension in the form of long, greatly-attenuated filaments to many times the height of the vertical axis of the umbrella, even when this height is at its maximum; and being again capable of assuming by contraction the form of short thick clubs. Indeed, instead of presenting the comparatively rigid and imperfectly contractile character which prevails among the *Trachomedusæ* and the *Narcomedusæ*, they possess as great a power of extension and contraction as may be found in the tentacles of many *Leptomedusæ* (*Thaumantidæ*, &c.). These four perradial tentacles contract independently of the others, and seem to form a different system. All the tentacles are armed along their

length with minute thread cells, which are set in close somewhat spirally-arranged warts.

The lithocysts or marginal vesicles are, in adult specimens, about 128 in number. They are situated near the umbrellar margin of the velum, between the bases of the tentacles, and are grouped somewhat irregularly, so that their number has no close relation with that of the tentacles. They consist of a highly refringent spherical body, on which may be usually seen one or more small nucleus-like corpuscles, the whole surrounded by a delicate transparent and structureless capsule. This capsule is very remarkable, for instead of presenting the usual spherical form, it is of an elongated piriform shape. In its larger end is lodged the spherical refringent body, and it thence becomes attenuated, forming a long tubular tail-like extension which is continued into the velum, in which it runs transversely towards its free margin, and there, after usually becoming more or less convoluted, terminates in a blind extremity.

The marginal nerve-ring can be traced running round the whole margin of the umbrella, and in close relation with the otolithic cells. Ocelli are not present.

The generative sacs are borne on the radiating canals, into which they open at a short distance beyond the exit of these from the base of the manubrium. They are of an oval form, and from their point of attachment to the radial canal hang down free into the cavity of the umbrella. Some of the specimens examined contained nearly mature ova, which, under compression, were forced from the sac through the radial canal into the cavity of the stomach.

While some of the characters described above point to an affinity with both the *Trachomedusæ* and *Narcomedusæ*, this affinity ceases to show itself in the very important morphological element afforded by the marginal bodies. In both *Trachomedusæ* and *Narcomedusæ* the marginal bodies belong to the tentacular system; they are metamorphosed tentacles, and their otolite cells are endodermal, while in the *Leptomedusæ*, the only other order of *craspedotol* Medusæ in which marginal vesicles occur, these bodies are genetically derived from the velum. Now in *Limnocoelium* the marginal vesicles seem to be as truly velar as in the *Leptomedusæ*. They occur on the lower or abumbral side of the velum, close to its insertion into the umbrella, and the tubular extension of their capsule runs along this side to the free margin of the velum, while the delicate epithelium of the abumbral side passes over them as in the *Leptomedusæ*. It is true that this point cannot be regarded as settled until an opportunity of tracing the development is afforded; but in very young specimens which I examined I found nothing opposed to the view that the marginal vesicles were derived, like those of the *Leptomedusæ*, from the velum.

Important points still remain to be cleared up regarding the development of *Limnocoelium* and the determination of the question whether the Medusa be derived from the egg directly or only through the intervention of a hydranlid trophosome. I have arranged with Mr. Sowerby some methods of observation by which I hope to obtain data for determination of these points.

If this be the case *Limnocoelium* will hold a position intermediate between the *Leptomedusæ* and the *Trachomedusæ*; but as the greatest systematic importance must be attached to the structure and origin of the marginal vesicles, its affinity with the *Leptomedusæ* must be regarded as the closer of the two. GEO. J. ALLMAN

#### *Physiology of the Freshwater Medusa*

THE structure of this remarkable animal has already been investigated and described by Professors Allman and Lankester, with the result of showing that, although constituting a new genus, it is in all respects a true Medusa. After the publication of their papers I began to work out

the physiology of the new form, and the following are the results which so far I have obtained.

The natural movements of the Medusa precisely resemble those of its marine congeners. More particularly, these movements resemble those of the marine species which do not swim continuously, but indulge in frequent pauses. In water at the temperature of that in the Victoria Lily-house (85° F.) the pauses are frequent, and the rate of the rhythm irregular—suddenly quickening and suddenly slowing even during the same bout, which has the effect of giving an almost intelligent appearance to the movements. This is especially the case with young specimens. In colder water (65° to 75°) the movements are more regular and sustained; so that, guided by the analogy furnished by my experiments on the marine forms, I infer that the temperature of the natural habitat of this Medusa cannot be so high as that of the water in the Victoria Lily-house. In water at that temperature the rate of the rhythm is enormously high, sometimes rising to three pulsations per second. But by progressively cooling the water, this rate may be progressively lowered, just as in the case of the marine species; and in water at 65° the maximum rate that I have observed is eighty pulsations per minute. As the temperature at which the greatest activity is displayed by the freshwater species is a temperature so high as to be fatal to all the marine species which I have observed, the effects of cooling are of course only parallel in the two cases when the effects of a series of higher temperatures in the one case are compared with those of a series of lower temperatures in the other. Similarly, while a temperature of 70° is fatal to all the species of marine Medusæ which I have examined, it is only a temperature of 100° that is fatal to the freshwater species. Lastly, while the marine species will endure any degree of cold without loss of life, such is not the case with the freshwater species. Marine Medusæ, after having been frozen solid, will, when gradually thawed out, again resume their swimming movements; but this freshwater Medusa is completely destroyed by freezing. Upon being thawed out, the animal is seen to have shrunk into a tiny ball, and it never again recovers either its life or its shape.

The animal seeks the sunlight. If one end of the tank is shaded, all the Medusæ congregate at the end which remains unshaded. Moreover, during the daytime they swim about at the surface of the water; but when the sun goes down they subside, and can no longer be seen. In these habits they resemble many of the sea-water species. They are themselves non-luminous.

I have tried on about a dozen specimens the effect of excising the margin of the nectocalyx. In the case of all the specimens thus operated upon, the result was the same, and corresponded precisely with that which I have obtained in the case of marine species. That is to say, the operation produces immediate, total, and permanent paralysis of the nectocalyx, while the severed margin continues to pulsate for two or three days. The excitability of a nectocalyx thus mutilated persists for a day or two, and then gradually dies out—thus also resembling the case of the marine naked-eyed Medusæ. More particularly, this excitability resembles that of those marine species which sometimes respond to a single stimulation with two or three successive contractions.

A point of specially physiological interest may be here noticed. In its unmutated state the freshwater Medusa exhibits the power of localising with its manubrium a seat of stimulation situated in the bell. That is to say, when a part of the bell is nipped with the forceps, or otherwise irritated, the free end of the manubrium is moved over and applied to the part irritated. So far, the movement of localisation is precisely similar to that which I have previously described as occurring in *Tiaropsis indicans* (*Phil. Trans.*, vol. clxvii.). But further than this, I find a curious difference. For while in *T. indicans*

these movements of localisation continue unimpaired after the margin of the bell has been removed, and will be ineffectually attempted even after the bell is almost entirely cut away from its connections with the manubrium; in the freshwater Medusa these movements of localisation cease after the extreme margin of the bell has been removed. For some reason or another the integrity of the margin here seems to be necessary for exciting the manubrium to perform its movements of localisation. It is clear that this reason must either be that the margin contains the nerve-centres which preside over these localising movements of the manubrium, or, much more probably, that it contains some peripheral nervous structures which are alone capable of transmitting to the manubrium a stimulus adequate to evoke the movements of localisation. In its unmutulated state this Medusa is at intervals perpetually applying the extremity of its manubrium to one part or another of the margin of the bell, the part of the margin touched always bending in to meet the approaching extremity of the manubrium. In some cases it can be seen that the object of this co-ordinated movement is to allow the extremity of the manubrium—i.e., the mouth of the animal—to pick off a small particle of food that has become entangled in the marginal tentacles. It is therefore not improbable that in all cases this is the object of such movements, although in most cases the particle which is caught by the tentacles is too small to be seen with the naked eye. As it is thus no doubt a matter of great importance in the economy of this Medusa that its marginal tentacles should be very sensitive to contact with minute particles, so that a very slight stimulus applied to them should start the co-ordinated movements of localisation, it is not surprising that the tentacular rim should present nerve-endings so far sensitive that only by their excitation can the reflex mechanism be thrown into action. But if such is the explanation in this case, it is curious that in *Tiaropsis indians* every part of the bell should be equally capable of yielding a stimulus to a precisely similar reflex action.

In pursuance of this point I tried the experiment of cutting off portions of the margin, and stimulating the bell above the portions of the margin which I had removed. I found that in this case the manubrium did not remain passive as it did when the whole margin of the bell was removed; but that it made ineffectual efforts to find the offending body, and in doing so always touched some part of the margin which was still unmutulated. I can only explain this fact by supposing that the stimulus supplied to the mutilated part is spread over the bell, and falsely referred by the manubrium to some part of the sensitive—i.e., unmutulated—margin.

But to complete this account of the localising movements it is necessary to state one additional fact which, for the sake of clearness, I have hitherto omitted. If any one of the four radial tubes is irritated, the manubrium will correctly localise the seat of irritation, whether or not the margin of the bell has been previously removed. This greater case, so to speak, of localising stimuli in the course of the radial tubes than anywhere else in the umbrella except the margin, corresponds with what I found to be the case in *T. indians*, and probably has a direct reference to the distribution of the principal nerve-tracts.

On the whole, therefore, contrasting this case of localisation with the closely parallel case presented by *T. indians*, I should say that the two chiefly differ in the freshwater Medusa, even when unmutulated, not being able to localise so promptly or so certainly; and in the localisation being only performed with reference to the margin and radial tubes, instead of with reference to the whole excitable surface of the animal.

All marine Medusæ are very intolerant of fresh water, and therefore, as the freshwater species must presumably

have had marine ancestors,<sup>†</sup> it seemed an interesting question to determine how far this species would prove tolerant of sea water. For the sake of comparison I shall first briefly describe the effects of fresh water upon the marine species.—If a naked-eyed Medusa which is swimming actively in sea water is suddenly transferred to fresh water, it will instantaneously collapse, become motionless, and sink to the bottom of the containing vessel. There it will remain motionless until it dies; but if it be again transferred to sea water it will recover, provided that its exposure to the fresh water has not been of too long duration. I have never known a naked-eyed Medusa survive an exposure of fifteen minutes; but they may survive an exposure of ten, and generally survive an exposure of five. But although they thus continue to live for an indefinite time, their vigour is conspicuously and permanently impaired. While in the fresh water irritability persists for a short time after spontaneity has ceased, and the manubrium and tentacles are strongly retracted.

Turning now to the case of the freshwater species, when first it is dropped into sea water at 85° there is no change in its movements for about fifteen seconds, although the tentacles may be retracted. But then, or a few seconds later, there generally occurs a series of two or three tonic spasms separated from one another by an interval of a few seconds. During the next half minute the ordinary contractions become progressively weaker, until they fade away into mere twitching convulsions, which affect different parts of the bell irregularly. After about a minute from the time of the first immersion all movement ceases, the bell remaining passive in partial systole. There is now no vestige of irritability. If transferred to fresh water after five minutes exposure, there immediately supervenes a strong and persistent tonic spasm, resembling rigor mortis, and the animal remains motionless for about twenty minutes. Slight twitching contractions then begin to display themselves, which, however, do not affect the whole bell, but occur partially. The tonic spasm continues progressively to increase in severity, and gives the outline of the margin a very irregular form; the twitching contractions become weaker and less frequent, till at last they altogether die away. Irritability, however, still continues for a time—a nip with the forceps being followed by a bout of rhythmical contractions. Death occurs in several hours in strong and irregular systole.

If the exposure to sea water has only lasted two minutes, a similar series of phenomena are presented, except that the spontaneous twitching movements supervene in much less time than twenty minutes. But an exposure of even one minute may determine a fatal result a few hours after the Medusa has been restored to fresh water.

Contact with sea water causes an opalescence and essential disintegration of the tissues, which precisely resemble the effects of fresh water upon the marine Medusæ. When immersed in sea water this Medusa floats upon the surface, owing to its smaller specific gravity.

In diluted sea water (50 per cent.) the preliminary tonic spasms do not occur, but all the other phases are the same, though extended through a longer period. In sea water still more diluted (1 in 4 or 6) there is a gradual loss of spontaneity, till all movement ceases, shortly after which irritability also disappears; manubrium and tentacles expanded. After an hour's continued exposure intense rigor mortis slowly and progressively develops itself, so that at last the bell has shrivelled almost to nothing. An exposure of a few minutes to this strength places the animal past recovery when restored

<sup>†</sup> Looking to the enormous number of marine species of Medusæ, it is much more probable that the freshwater species were derived from them, than that they were derived from a freshwater ancestry.

<sup>‡</sup> For full account, see *Phil. Trans.*, vol. cxvii., pp. 744-745.



to fresh water. In still weaker mixtures (1 in 8, or 1 in 10) spontaneity persists for a long time; but the animal gradually becomes less and less energetic, till at last it will only move in a bout of feeble pulsations when irritated. In still weaker solutions (1 in 12 or 1 in 15) spontaneity continues for hours, and in solutions of from 1 in 15 to 1 in 18 the Medusa will swim about for days.

It will be seen from this account that the freshwater Medusa is even more intolerant of sea water than are the marine species of fresh water. Moreover the freshwater Medusa is beyond all comparison more intolerant of sea water than are the marine species of brine. For I have previously found that the marine species will survive many hours' immersion in a saturated solution of salt. While in such a solution they are motionless, with manubrium and tentacles relaxed, so resembling the freshwater Medusa shortly after being immersed in a mixture of 1 part sea water to 5 of fresh; but there is the great difference that while this small amount of salt is very quickly fatal to the fresh-water species, the large addition of salt exerts no permanently deleterious influence on the marine species.

We have thus altogether a curious set of cross relations. It would appear that a much less profound physiological change would be required to transmute a sea-water jelly-fish into a jelly-fish adapted to inhabit brine, than would be required to enable it to inhabit fresh water. Yet the latter is the direction in which the modification has taken place, and taken place so completely that sea water is now more poisonous to the modified species than is fresh water to the unmodified. There can be no doubt that the modification was gradual—probably brought about by the ancestors of the freshwater Medusa penetrating higher and higher through the brackish waters of estuaries into the fresh water of rivers—and it would, I think, be hard to point to a more remarkable case of profound physiological modification in adaptation to changed conditions of life. If an animal so exceedingly intolerant of fresh water as is a marine jelly-fish may yet have all its tissues changed so as to adapt them to thrive in fresh water, and even die after an exposure of one minute to their ancestral element, assuredly we can see no reason why any animal in earth or sea or anywhere else may not in time become fitted to change its element.

GEORGE J. ROMANES

### NOTES

THE Fiftieth Annual Meeting of the British Association will commence on Wednesday, August 25, 1880, at Swansea. The President Elect is Andrew Crombie Ramsay, LL.D., F.R.S., Director-General of the Geological Survey of the United Kingdom and of the Museum of Practical Geology. The Vice-presidents Elect are: The Right Hon. the Earl of Jersey, the Mayor of Swansea, the Hon. Sir W. R. Grove, D.C.L., F.R.S., J. Hussey Vivian, M.P., F.G.S., L. Ll. Dillwyn, M.P., F.L.S., J. Gwyn Jeffreys, LL.D., F.R.S.; and the General Secretaries: Capt. Douglas Galton, C.B., D.C.L., F.R.S., 12, Chester Street, Grosvenor Place, London, S.W., Philip Lutley Sclater, Ph.D., F.R.S., 11, Hanover Square, London, W.; Assistant-Secretary: J. E. H. Gordon, 22, Albemarle Street, London, W.; General Treasurer: Prof. A. W. Williamson, Ph.D., LL.D., F.R.S., University College, London, W.C.; Local Secretaries: W. Morgan, Ph.D., F.C.S., and James Strick, Swansea; and Local Treasurer: R. J. Letcher, Swansea. The Sections are the following:—A.—Mathematical and Physical Science.—President: Prof. W. Grylls Adams, F.R.S. Vice-Presidents: C. W. Merrifield, F.R.S.; C. W. Siemens, D.C.L., F.R.S. Secretaries: W. E. Ayrton; J. W. L. Glaisher, F.R.S.; Oliver J. Lodge, D.Sc.; Donald McAlister, B.Sc. (Recorder). B.—Chemical Science.—President: John Henry

Gilbert, Ph.D., F.R.S. Vice-Presidents: I. Lowthian Bell, F.R.S.; William Crookes, F.R.S.; W. Chandler Roberts, F.R.S. Secretaries: Harold B. Dixon, F.C.S.; Dr. W. R. Eaton-Hodgkinson; P. Phillips-Bedson, D.Sc., F.C.S.; J. M. Thomson, F.C.S. (Recorder). C.—Geology.—President H. Clifton Sorby, LL.D., F.R.S. Vice-President: Prof. Archibald Geikie, LL.D., F.R.S., L. and E., Warrington W. Smyth, F.R.S. Secretaries: W. Topley, F.G.S. (Recorder); W. Whitaker, F.G.S. D.—Biology.—President: A. C. L. G. Gunther, M.D., F.R.S. Vice-Presidents: F. M. Balfour, F.R.S.; Prof. Newton, F.R.S.; F. W. Rudler, F.G.S. Secretaries: G. W. Bloxam, F.L.S. (Recorder); Prof. M'Nab, M.D. (Recorder); John Priestley; Howard Saunders, F.Z.S. E.—Geography.—President: Lieut.-General Sir John Henry Lefroy, C.B., K.C.M.G., F.R.S. Vice-Presidents:—Sir Henry Barkly, G.C.M.G., K.C.B., F.R.S.; Admiral Sir Erasmus Ommanney, C.B., F.R.S.; Lieut.-General Sir H. F. I. Thuillier, C.S.I., R.A., F.R.S. Secretaries: H. W. Bates, Assist.-Sec. R.G.S., F.L.S.; C. E. D. Black; E. C. Rye, Librarian R.G.S., F.Z.S. (Recorder). F.—Economic Science and Statistics.—President: George Woodyatt Hastings, M.P. Vice-Presidents: James Heywood, F.R.S.; William Newmarch, F.R.S.; Henry Richard, M.P. Secretaries: Noel A. Humphreys, F.S.S.; Constantine Mollay (Recorder). G.—Mechanical Science.—President: James Abernethy, C.E. Vice-Presidents: Prof. Osborne Reynolds, F.R.S.; Prof. James Stuart. Secretaries: A. T. Atchison (Recorder); H. Trueman Wood. The first general meeting will be held on Wednesday, August 25, at 8 p.m., precisely, when Prof. G. J. Allman, M.D., LL.D., F.R.S., L. & E., Pres. L.S., will resign the chair, and A. C. Ramsay, LL.D., F.R.S., V.P.G.S., Director-General of the Geological Survey of the United Kingdom, and of the Museum of Practical Geology, President-Elect, will assume the presidency and deliver an address. On Thursday evening, August 26, at 8 p.m., a *soirée*; on Friday evening, August 27, at 8.30 p.m., a discourse by Prof. W. Boyd Dawkins, F.R.S., on "Primæval Man"; on Monday evening, August 30, at 8.30 p.m., a discourse by Francis Galton, M.A., F.R.S., on "Mental Imagery"; on Tuesday evening, August 31, at 8 p.m., a *soirée*; on Wednesday, September 1, the concluding general meeting will be held at 2.30 p.m. On Saturday evening, August 28, Henry Seebohm, F.Z.S., will deliver a lecture to the operative classes on "The North-East Passage"; tickets can be purchased of the local secretaries. A room will be provided for the reception of apparatus and specimens illustrative of papers communicated to the sections. Excursions to places of interest in the neighbourhood of Swansea will be made on Thursday, September 2, and short excursions on the afternoon of Saturday, August 28.

WE regret to announce the death of M. J. M. Gaugain, the eminent French electrician, at the age of seventy years. We shall give some account of his life and work next week.

THE Committee for the erection of a statue to Gauss have just issued a note, from which we learn that on the 27th instant (11.30 A.M.) the statue—modelled, as we have previously announced, by Prof. Schafer of Berlin, and cast by Prof. Howaldt—is to be unveiled. The Committee will be happy to have the names of any English mathematicians or gentlemen who may be willing, or who intend, to take part in the festivities which are to accompany the ceremony of unveiling. Applications should be addressed at once to the Landsyndicus Otto, Gauss Monument Committee, Braunschweig (Brunswick).

A CORRESPONDENT, J. H. S., sends us the following notice of Dr. E. L. Moss, who has shared the fate of the *Atalanta*:—"It seems to have escaped the notice of the scientific world the loss it has sustained in the ill-fated *Atalanta*. Dr. Edward L.

Moss, one of the officers on board that vessel, besides being a surgeon of renown in the navy, was also, in the best sense of that phrase, a scientific man. His papers read before the British Association, and his remarks at sectional meetings over a large range of natural history subjects (I remember such particularly at the last Plymouth meeting) will be fresh in the minds of many. He was one who, always observing and storing up facts, at whatever part of the world he might be, could clearly and systematically arrange them, and also employ them if required with convincing force. Such opportunities for observation were many and various. His profession, and the high estimation in which he was held by the naval authorities making him a picked man for any special service. By no means his least accomplishment was the masterly way in which he wielded brush and pen. In the Arctic Expedition of 1875-76 he served on board H.M.S. *Alert*, and to the astonishment of every one brought back with him from that expedition a number of most beautiful finished water-colour paintings and sketches in black and white. These were all made on the spot in those far off regions, and are, I believe, the only examples in colour, painted from nature, of those dreary, cold solitudes, and consequently were the first intimation to the majority of people of the gorgeous effects of colour to be seen there. I remember him telling me about the trouble it was to keep his pigments fluid and the devices he had to resort to to effect that result. Many of these paintings and drawings (in facsimile), with a vivid and most interesting descriptive narrative, were published in his book, 'Shores of the Polar Sea.'

MR. W. A. FORBES, B.A., the Prosector to the Zoological Society, is leaving England by the mail steamer to-day for a short visit to the province of Pernambuco, Brazil. One of the chief objects of his visit will be to obtain specimens in spirit of the various Neotropical Mesomydian *Tassers*, as well as of *Alcedo* and other birds. During his absence all communications relating to animals in the Gardens, &c., should be addressed to Mr. J. J. Lister, B.A., who has undertaken Mr. Forbes's prosectorial duties during the absence of the latter.

THE numerous friends of the late Prof. A. H. Garrod will be glad to hear that a "Garrod Memorial Fund" has been set on foot, with the object of reprinting, in a complete and separate form, all his published papers, both physiological and zoological. We hope to be able to announce further particulars shortly.

AMONGST the peculiar institutions of Paris are the street astronomers, who exhibit through their telescopes the moon, sun-spots, comets' tails, and other celestial objects, according to circumstances. Their charges vary from 1*d.* in the suburbs to 5*d.* on the Place de la Concorde or the Place Vendôme, where the instruments are not unworthy of a regular observatory. At the last monthly meeting of the scientific journalists M. Flammarion read an address sent to him by the corporation of these itinerant teachers of the marvels of the heavens. They state that from the beginning of the publication of the "Astronomie Populaire" the number of their customers has more than doubled.

THE establishment in Paris of a system of pneumatic clocks has not put a stop to the experiments for transmitting the observatory time by electricity not only to the several public clocks of Paris, but all over France, taking advantage of the telegraphic wires. A commission has been appointed by the Municipal Council of Paris to select between the several systems which have been proposed on competition.

AMONG the statues which have been exhibited in the *Salon* at the Palais de l'Industrie, Paris, two large monuments, to commemorate Denis Papin at Blois and Leverrier at Paris, have largely attracted public notice. The astronomer is represented

erect, wearing his usual dress, and supporting in his left hand a celestial sphere; the right is pointing to the heavens.

THE U.S. Congress, we learn from the *Electrician*, has voted the sum of 15,000 dollars for a statue of the late Prof. Joseph Henry, to be placed in the grounds of the Smithsonian Institution.

THE *Colonies* draws attention to the establishment of a "School of Agriculture" at Canterbury, New Zealand, with the object of affording students the opportunity of acquiring a thorough knowledge of the science and practice of agriculture. The institution, which is under the direction of Mr. W. E. Ivey, M.R.A.C., F.C.S., is situated near Lincoln, about twelve miles from the city of Christchurch; and in addition to the school buildings—comprising lecture theatre, library, museum, chemical laboratory, &c.—has attached to it a farm of 500 acres of land of various qualities, from rich swamp pasture land to light and comparatively thin soil overlying shingle. A portion of the farm is devoted to experimental purposes to test the value of different methods of cultivation, the effect of manures on various crops, the qualities of indigenous and exotic grasses, and the suitability and comparative worth of new varieties of cereals, roots, fodder, and other plants. The students will be required to take part in the regular daily practical work of the farm, to acquire a practical knowledge of ploughing and every other kind of farm work, the use of implements and machinery, the management of stock, and the making of cheese and butter. They will also receive practical instruction in agricultural chemistry in the laboratory. Land surveying and levelling will be undertaken at suitable times for practice in the use of instruments, in measuring land, in harvest and other piece work, and for taking levels for drainage purposes. Lectures and instruction will be given to various subjects connected with agriculture, chemistry, botany, entomology, veterinary medicine, &c. Under the present rules candidates for admission as resident students are required to pass a preliminary examination; and must be between the ages of fifteen and nineteen.

FROM the reply of Earl Spencer last Thursday in the House of Lords to a question as to the teaching of agricultural science by the Science and Art Department, we are glad to find that at least the "utility" of science is beginning to be recognised in high places. "There was no more important matter," the Earl said, "than the application of science to the art of agriculture. Great attention had of late years been very properly called to the great aid which science gave to the various classes of manufacturers and producers; and that principle applied with quite as great force to agriculture as to any other art. That was especially the case at the present moment, when the country was inquiring narrowly into the whole of our agricultural system. If science could enable our agriculturists to produce more from the land than they had hitherto done it would add another to the many useful things it had been the means of accomplishing. It had been decided," the Earl went on to state, "by the department, in consequence of the pressure for accommodation for science classes and for instruction in various branches, not to have a special class for agricultural science this year, seeing that botany, geology, and chemistry, which were so intimately connected with agriculture, were taught separately. Since he had come into office, however, the department had decided that a class for agriculture should be held in August next."

THE Midland Union of Natural History Societies held its third annual meeting at Northampton on Thursday and Friday last, 17th and 18th inst., under the presidency of Sir Hereward Wake, Bart. The Union consists of twenty-four societies in the central counties, and numbers nearly 3,000 members. Its object is to encourage natural history studies, and to make local students residing far apart known to each other. So far its

success has been most marked. At Birmingham in 1878, at Leicester last year, and at Northampton this year, it has brought together naturalists from Nottingham, Luton, Leicester, Bedford, Peterborough, Hereford, Welshpool, Shrewsbury, Cheltenham, Stroud, Birmingham, and other places, and has afforded opportunities for intercourse between many who were previously strangers. The presidential address was brief, but interesting and suggestive. Lord Lilford took part in the proceedings, and read an admirable paper on ornithological topics. He exhibited nearly 200 specimens of birds taken chiefly in North Northamptonshire, the bulk of which he presented to the Northamptonshire Naturalists Society, of which he is president. The report of the council gave an outline of work done by the various societies in the Union during the past twelve months. In the evening an interesting scientific *conversazione* was provided in the Town Hall, and was largely attended. On Friday the members divided into two parties, one of which explored the geology of the district under the guidance of Mr. Hull; the other, led by Mr. Scriven, visited Castle Ashby, the seat of the Marquis of Northampton, and devoted the bulk of their time to botanising in Yardley Chase, &c. The meeting was in every way a success. The next year's meeting will be held at Cheltenham, and Dr. T. Wright, F.R.S., is the president elect.

M. DAUBRÉE, director of the French School of Mines, has published an essay on Descartes, in which he summarises the services rendered by that philosopher to science. He reminds his readers that Descartes advocated the theory of an igneous origin for the earth, and he enters into a lengthened discussion of the objections which may be raised against the theory of actual causes, as advocated by Lyell.

THE City and Guilds of London Institute for the Advancement of Technical Education has definitively accepted from Her Majesty's Commissioners for the Exhibition of 1881 a site for the Central Institution in Exhibition Road. The site is 300 feet long, and is between the temporary French and Belgian Courts. The advantages of this site are its proximity to the museums and libraries, and science and art schools of South Kensington. The central institution, when erected, will be used for the training of teachers, and will provide the highest technical instruction to students who have already obtained such a knowledge of the elements of science as is furnished by the School of Mines and other scientific institutions.

REPORTS continue to appear of the unusual quantity of drift ice met with in the North Atlantic by vessels sailing between this country and America. Do not these "numerous fields of ice" met with indicate an unusually early and extensive break-up of the Arctic ice-sheet, and extreme meteorological conditions in the Polar area?

MR. FRANK BUCKLAND has been awarded a gold medal and a decorated diploma of honour by the authorities of the Berlin International Fishery Exhibition.

PÈRE MARC DECHEVRENS, the Director of the Zikawei Observatory, near Shanghai, has lately published an important essay on the disastrous typhoon of July 31, 1879, accompanied by remarks on other typhoons in the autumn of the same year.

BY recent intelligence from New South Wales we learn that very rich silver lodes, with a large quantity of gold, had been discovered at the Nambucca River, and that gold had also been found near Moama, on the Murray.

IN his just published Consular Report from Saigon, Mr. Tremlett furnishes some further notes respecting *huang-mao*, to which we have referred on a previous occasion. It is said to be a bush, and to present something of the appearance of ivy; it is only found in mountains of lime stone formation. It is said to

cure the bite of the most venomous serpents, and has been successfully employed in curing cancer and principally leprosy, in the treatment of which it has never given other than satisfactory results. The native physicians, Mr. Tremlett remarks, distinguish thirty-six kinds of leprosy, the most common attacking the feet and hands; it is considered to be hereditary, and is usually contracted by children at the age of puberty. After some generations it has been noticed to confine itself to either the male or the female members of the family; the disease is considered contagious, which only would account for the large number of lepers in Tongking.

IN the last aeronautical ascent which was made at Rouen on Monday, June 13, by M. Jovié, M. De-maret, one of the aeronauts, tried with success to take photographs of the land below. About fifteen different views were taken by him, and are wonderfully executed. The car had a hole in the centre, and the photographic apparatus was supplied with a patent obturator working in one-hundredth of a second. The photographs were of course taken by instantaneous process.

WE notice some interesting geological researches by M. Kontkevitch on the eastern slopes of the Oural Mountains. They will be an important addition to the well-known map of the western slope published some years ago by Prof. Moller.

WE have received the tenth volume of the *Memoirs* of the St. Petersburg Society of Naturalists, which contains, besides the minutes of meetings of the Society, a series of interesting papers:—A *résumé* of our knowledge on the Silurian in the Governments of St. Petersburg and Esthonia, by Prof. Friedrich Schmidt; on the ornithological fauna of the marshes of the district Uman (province Kieff), by G. Th. Gobel; a monograph on the sponges of the White Sea, by K. S. Merejkovsky; on the algae of the Gulf of Finland, by Chr. Gobi; ornithological observations on the province of Kazan, by P. Pavloff; on the birds of the tracts between the Amou and Kouvan-djarma Rivers, by M. Boutleroff; on the structure of the eye-like spots in certain fishes, by M. M. Onsoff; and a flora of the Phanerogams of the Government of Tver, by A. A. Bakounin.

IN the *Sessional Proceedings* of June 4 of the National Association for the Promotion of Social Science will be found an extremely interesting discussion of the subject of educational pressure among girls, by various ladies connected with well-known girls' schools, and others.

THE additions to the Zoological Society's Gardens during the past week include two Rhesus Monkeys (*Macacus erythreus*) from India, presented respectively by Mr. W. Connell, and Mr. George L. Amlot; a Quica Opussum (*Didelphys quica*) from Demerara, presented by Capt. E. Ball; an Azara's Fox (*Canis azarae*) from South America, presented by Mr. Edward Cooper; a Greater Sulphur crested Cockatoo (*Cacatua galerita*) from Australia, presented by Mrs. M. A. Brown; two Common Gulls (*Larus canus*), European, presented by Mr. J. Castell; a Dominican Gull (*Larus dominicanus*, n. sp.) from New Zealand, presented by Capt. R. Bower; a Buzzard (*Buteo sp. inc.*) from Tasmania, presented by Capt. J. Seaborne; a Salt Water Terrapin (*Clemmys terrapin*) from North America, presented by Mr. A. D. Bartlett; a Common Ocelot (*Felis pardalis*) from Demerara, a Brown Capuchin (*Cebus fatuellii*) from Guiana, a Weeper Capuchin (*Cebus capucinus*) from Brazil, an Australian Crane (*Grus australasiana*) from Australia, deposited; two Virginian Deer (*Cariacus virginianus*) from North America, four Beautiful Finches (*Estrela bella*) from Australia, purchased; a Leonine Monkey (*Macacus leoninus*) from Arracan, a Slow Loris (*Nycticobus tardigradus*) from Malacca, two Bay Bamboo Rats (*Rhizomys badius*) from India, two Sumatran

Wild Dogs (*Canis rutilans*) from Sumatra, a Javan Adjutant (*Leptoptilus javanicus*) from Java, received in exchange; a Wapiti Deer (*Cervus canadensis*), an Axis Deer (*Cervus axis*), born in the Gardens; three Siamese Pheasants (*Euplocamus prolatus*), two Horned Tragopans (*Cerionis satyra*), two Peacock Pheasants (*Polyplectron chinquis*), four Mandarin Ducks (*Aix galericulata*), four Variegated Sheldrakes (*Tadorna variegata*), bred in the Gardens.

OUR ASTRONOMICAL COLUMN

KEPLER'S NOVA OF 1604.—The vicinity of this object is now favourably situate for observation in the evenings, and it is well worth while to keep a close watch upon one or two small stars near the position deduced for Kepler's object by Prof. Schönfeld from the observations of David Fabricius, which he considered preferable to those of Kepler and his pupils, given in his celebrated work, "De Stella nova in pede Serpentarii," more especially upon a star of the twelfth magnitude, or fainter, observed by Prof. Winnecke in 1875, which is close upon the place of a star of the tenth magnitude inserted on Chacornac's chart, but not afterwards found of this degree of brightness, and which is still more significant, almost exactly in the position of Kepler's object assigned by the observations of Fabricius. The most convenient reference star in this neighbourhood is one meridionally observed by Argelander, No. 16872 of Oeltzen's Catalogue, a bright ninth magnitude, the position of which for the beginning of the present year is in R.A. 17h. 23m. 52.2s., N.P.D. 111° 23' 22"; Schönfeld's place of Nova 1604 for the same epoch is in R.A. 17h. 23m. 26.9s., N.P.D. 111° 22' 32"; Winnecke's star precedes Argelander's 33.2s., in 2.7 less N.P.D. There is a somewhat brighter star preceding Argelander's 18.8s. with 1.6 greater N.P.D., which, after several years' observation, has not exhibited any sensible fluctuation of magnitude. Attention should be chiefly directed to Winnecke's object, and it would be desirable to know its present magnitude, which some reader of this column may have the opportunity of putting upon record; we would, however, suggest its frequent observation.

There is no reason to suppose, notwithstanding the name of "temporary stars" which has been attached to them, that either Tycho Brahe's famous star of 1572, Kepler's of 1604, or the less conspicuous star discovered by Anhelm in 1670, have died out; on the contrary, in all three cases there are now small stars close upon the best positions which we can assign to the objects of those years, in which some fluctuations of brightness have been remarked after very careful observation.

WESTPHAL'S COMET (1852 IV).—In Mr. Chamber's useful manual of astronomy there is an oversight with respect to the orbit of the comet discovered by Westphal at Göttingen in June, 1852, the elliptic character of which was first made apparent by the computations of Mr. Marth towards the end of the same year. Elements derived from the earlier calculations are given in place of the definitive orbit deduced by Dr. Axel-Möller or the similar very completely-investigated orbit by the discoverer; hence the comet is credited with a period of revolution which is certainly ten years in excess of that belonging to the ellipse in which it was moving during its appearance in 1852. Dr. Axel-Möller's orbit is as follows:—

Perihelion passage, 1852, October 12.76278 G.M.T.

Longitude of perihelion ... ..	43 14 " 8	} Mean equinox,
" ascending node ... ..	346 9 49	
Inclination ... ..	40 54 28	
Angle of excentricity ... ..	66 42 8.36	
Log. semi-axis major ... ..	1.1855845	
Motion—direct.		

With these elements we find:—

Semi-axis major ... ..	15.3315
" minor ... ..	6.0637
Excentricity ... ..	0.9184625
Aphelion distance ... ..	29.4129
Perihelion distance ... ..	1.2501
Revolution ... ..	60.031 years

It is easy to see by what action the comet has been at some past time in all probability fixed in this orbit till similar perturbation recurs. In a true anomaly of 126° 30' after perihelion or in ecliptical longitude 168° 52', the comet is distant

from the orbit of Jupiter only 0.36 of the earth's mean distance from the sun, and so close an approach of the two bodies would almost certainly result in the impression upon the comet of an orbit, materially differing from that in which it moved previously; this we know has occurred in several instances since the motions of comets have been rigorously investigated, a notable case being that of Brorsen's comet, which is now moving in an orbit into which it was thrown by its encounter with Jupiter in May, 1848.

GEOGRAPHICAL NOTES

In yesterday's *Times* is a letter from Mr. Thorndike Rice, giving details of the programme of the expedition to Central America, under the leadership of M. Charnay, for the exploration of the ancient monuments there, and to which we referred some time ago. Casts will be taken of all important bas-reliefs and inscriptions, part of which will be deposited in the Smithsonian Institution, and part sent to Paris. Details of the work of the expedition will be published from time to time in the *North American Review*.

CONSIDERABLE attention is still attracted in Australia to the supposed existence in recent years of a survivor of Leichhardt's great exploring expedition, which disappeared in 1848. Numerous lengthy communications have been published by the Colonial press, which tend to confirm the belief that an aged European, not improbably Classen, as we have before mentioned, was living with the blacks near the Queensland border until some four years ago. A man has also come forward at Sydney and made a curious statement to the effect that he was a sailor on board a steamer which was sent by the South Australian Government in 1867 to take cargo to the Roper River, Gulf of Carpentaria, and that on landing some ten miles to the south of the mouth of that river he met natives who told him that three days journey up the river there was an old white man with a very long beard. The position mentioned would, it is thought, be very near the Elsey, where it has been before suggested that something might be found out about the fate of Leichhardt's party. It is to be regretted that the different persons who have contributed items of information did not come forward sooner with their contributions, however small, towards the solution of this mystery, as it might have been cleared up ere this.

THE s.s. *Eira*, recently launched, left Peterhead on Saturday morning for the Arctic regions on a voyage of discovery. She has a crew of some twenty-five, and carries a photographer, the same who accompanied Capt. Nares, and a doctor. The steamer has been coaled and provisioned for two years, but her return is expected before that time.

THE Ontario correspondent of the *Colonies and India* states that the construction of the long-talked-of railway across the island of Newfoundland has at length been decided upon; it will be 350 miles long, and will be of great benefit to the island.

IN his report on the department of maps, charts, &c., at the British Museum, Mr. Major notes the undermentioned interesting additions during the past year:—A large English chart on parchment of the coasts of Brazil and Africa of the early date of 1647, bearing the legend, "made by Nicholas Comberford, dwelling near to the West end of the Schoole House, at the XX signe of the Plat in Radcliffe, anno 1647." Also two illuminated and gilt MS. maps on parchment, the one of the coasts of Florida, New Spain, and Africa (1688), and the other of the West Indies (1698). These are by José da Costa Miranda. Another valuable acquisition is an important plan of Paris in seventy-two sheets, constructed by Varniquet, and finished in 1791, after thirty years' labour.

THE new number of the Belgian Geographical Society's *Bulletin* opens with a paper on the geography of Lake Tanganyika, which was prepared by Lieut.-Col. Adan for the committee of the International African Association; it is illustrated by an interesting reproduction on one sheet of various maps, exhibiting the views of cartographers on the shape of the lake. The other papers are by Dr. Litton Forbes on the Island of Rotumah, and by M. A. J. Wauters on the African elephant.

SIR JOHN LUBBOCK ON THE HABITS OF ANTS

IN a further contribution of his observations towards elucidating the economy and habits of these insects, laid before the last meeting of the Linnæan Society (June 17), Sir John commenced

by relating his fresh experiments on their powers of communication. Among others a dead blue-bottle fly was pinned down, and after vain efforts at removal the selected ant hid home, and emerged with friends who slowly, and evidently incredulously, followed their guide. The latter starting off at a great pace distanced them, and they returned, again, however, to be informed, come out and at length be coaxed to the prey. In the several experiments with different species of ants and under varied circumstances, these seem to indicate the possession by ants of something approaching language. It is impossible to doubt that the friends were brought out by the first ant, and as she returned empty handed to the nest the others cannot have been induced to follow merely by observing her proceedings. Hence the conclusion that they possess the power of requesting their friends to come and help them. For other experiments testing the recognition of relations, although the old ants had absolutely never seen the young ones until the moment, some days after arriving at maturity, they were introduced into the nest, yet in all cases they were undoubtedly recognised as belonging to the community. It would seem, therefore, to be established that the recognition of ants is not personal and individual, and that their harmony is not due to the fact that each ant is acquainted with every other member of the community. It would further appear from the fact that they recognise their friends even when intoxicated, and that they know the young born in their own nest, even when they have been brought out of the chrysalis by strangers, indicating, therefore, that the recognition is not effected by means of any sign or password. With regard to workers breeding, the additional evidence tends to confirm previously-advanced views, that when workers lay eggs males are always the issue of these. Without entering into details of instances it may broadly be affirmed that in the queenless nests males have been produced, and in not a single case has a worker laid eggs which have produced a female, either a queen or a worker. On the contrary, in nests possessing a queen, workers have been abundantly produced. The inference to these curious physiological facts leads to the presumption that, as in the case of bees, so also in ants, some special food is required to develop the female embryo into a queen. In Sir John's nests, while from accidents and other causes many ants are lost during the summer months, in winter, nevertheless, there are few deaths. As to the age attained, specimens of *Formica fusca* and *F. sanguinea*, still lively, are now four and others five years old at least. The behaviour to strange queens often results in their being ruthlessly killed; yet as communities are known to have existed for years, queens must occasionally have been adopted. With the view of trying how far dislike and passion might be assuaged by a formal temporary acquaintance a queen of *F. fusca* was introduced into a queenless nest, but protected by a wire cage, and after some days the latter removed, but the queen was at once attacked. Mr. McCook, nevertheless, relates an instance of a fertile queen of *Crematogaster lineolata* having been adopted by a colony of the same species.

Such difference in conduct, Sir John suggests, may be due to his own ants having been living in a republic; for it is affirmed that bees long without a queen are strongly averse to adopt or accept another. Furthermore, if a few ants from a strange nest are put along with a queen they do not attack her, and if other ants are by degrees added the throne is ultimately secured. In pursuance of experiments to test the sense of direction, some ants were trained to go for their food over a wooden bridge made up of segments. Having got accustomed to the way, afterwards when an ant was in the act of crossing, a segment was suddenly reversed in direction, evidently to the ant's discomfiture; she then either turned round, or, after traversing the bridge, would return. When, however, similar pieces of wood were placed between nest and food, and the ant at the middle piece, those at the ends being transposed, the ant was not disconcerted. In other instances a circular paper disk was placed on a paper bridge, and when the ant was on the disk this was revolved, but the ant turned round with the paper. A hat-box with holes of entrance and exit pierced at opposite sides was planted across the line to the food; when the ant had entered and the box turned round, the ant likewise wheeled about, evidently retaining her sense of direction. Again, with the insect *en route*, when the disk or box with the ant within was merely shifted to the opposite side of the food without being turned round, the ant did not turn round, but continued in what ought to have been the direction to the food, and evidently was surprised at the result on arrival at the spot where the food had

previously been. To ascertain whether ants make sounds audible to one another, the use of the telephone was resorted to, but the results were negative. These experiments may not be conclusive, for the plate of the telephone may be too stiff to be set in vibration by any sounds which the ants produced. As opposed to the opinion expressed by M. Dewitz, Sir J. Lubbock regards the ancestral ant as having been aculeate, and that the rudimentary condition of the sting in *Formica* is due to atrophy, perhaps attributable to disuse. A ground plan of the nest of *Lasius niger* is now given by Sir John, which exhibits an intricate, narrow, and winding entrance-passage; the main nest cavity is further supported by pillars, and here and there by islands; protected recesses obtain, evidently strategical retreats in times of danger. Studying the relations and treatment of the aphides, or plant-lice of the ants, Sir John clearly demonstrates that not only are the aphides kept and protected in the ants' nests, but the eggs of *Aphis* laid outside on the leaf-stalks of its food-plant in October, when exposed to risks of weather, are carefully brought by the ants into their nests, and afterwards tended by them during the long winter months until March, when the young ones are again brought out and placed on the young vegetable shoots. This proves prudential motives, for though our native ants may not lay up such great supplies of winter stores of food as do some of those found abroad, they thus nevertheless take the means to enable them to procure food during the following summer. The fact of European ants not generally laying up abundant stores may be due to the nature of their food. Insects and small animals form portions of their food, and these cannot always be kept fresh. They may also not have learnt the art of building vessels for their honey, probably because their young are not kept in cells like those of the honey bee, and their pupae do not construct cocoons like those of the humble bee. Relatively to their size our English ants nevertheless store proportionally; for if the little brown garden ant be watched milking their aphides, a marked abdominal distension is observable. The paper concludes by the history and technical description of a new species of Australian honey ant. This corroborates Westmæll's strange account of the Mexican species; certain individual ants being told off as receptacles for food, in short they become literally animated honey pots.

#### UNIVERSITY AND EDUCATIONAL INTELLIGENCE

THE committee of management of the Royal Agricultural College, Cirencester, have just established two scholarships of 25*l.* and 10*l.* respectively, to be open to all students of the college, and to be awarded three times every year in accordance with the results of the sessional examinations. The first award will take place after the Christmas examination of the present year. The vellum certificates and book prizes, and the gold medals, will be continued as heretofore.

THE first session of the representative Conseil Supérieure de l'Instruction Publique of France was closed on June 17, by an address pronounced by M. Jules Ferry. The result of the deliberations has been to raise the standard of *Baccalauréat*, the first step in French classical honours; the time allotted to Greek and Latin in the course of studies has been curtailed at the expense of themes and versification, and allotted either to science or to living languages. The work of the next session will be to organise the scientific instruction. Sharp discussions are expected between the delegates who wish to organise a special course of instruction for sciences, and those who stick to the old scheme of making the preparation for the Government schools a supplement to classical instruction.

#### SCIENTIFIC SERIALS

*Annalen der Physik und Chemie*, No. 5.—On tones generated by a limited number of impulses, by W. Kohlrausch.—On torsion, by E. Warburg.—On stationary vibrations of a heavy fluid, by G. Kirchhoff.—On the propagation of electricity by current water, and allied phenomena (continued), by E. Dorn.—On the new relation discovered by Dr. Kerr between light and electricity, by W. C. Röntgen.—On some new researches on the mean length of path of molecules, by R. Clausius.—Researches on heat-conduction in liquids, by H. F. Weber.—Researches on the height of the atmosphere and the constitution of gaseous celestial bodies (continued), by A. Ritter.—On ultra-violet rays (con-

tinued), by J. L. Schön.—On a new simple condensation-hygrometer, by A. Matem.—On a general proposition of Herr Clausius in reference to electric induction, by G. J. Legebeke.—On an optical illusion in looking at geometrical figures, by W. Holtz.—Reflection and refraction of light on spherical surfaces, supposing finite angle of incidence, by F. Lippich.

*American Journal of Science*, May.—Outlet of Lake Bonneville, by G. K. Gilbert.—Chemical and geological relations of the atmosphere, by T. Sterry Hunt.—Archæan rocks of Wahsatch Mountains, by A. Geikie.—Apatites containing manganese, by S. L. Penfield.—New meteorite in Cleberne co., Alabama, by W. E. Hidden.—On the recent formation of quartz and on silicification in California, by T. S. Hunt.—The Uranometria argentina, by H. A. Newton.—The Ivanpah, California, meteoric iron, by C. U. Shephard.—The atomic weight of antimony (preliminary notice of additional experiments), by J. P. Cooke.—Daubrée's experimental geology, by J. Lawrence Smith.—Bastnäsite and Tysorite from Colorado, by O. D. Allen and W. J. Constock.—On argento-antimonious tartrate (silver emetic), by J. P. Cooke.—The sternum in Dinosaurian reptiles, by O. C. Marsh.—On the southern comet of February, 1880, by B. A. Gould.

*Proceedings of the Boston Society of Natural History*, vol. xx., part 3 (published April).—Dr. Sam. Kneeland, the mineralised phosphatic guanos of the equatorial Pacific Islands: on the frozen well at Decorah, Iowa.—Prof. Brewer, additional notes on his lists of New England birds; catalogue of humming-birds in the Society's collection (only commencement).—Prof. Shaler, on the submarine coast shelf.—Dr. Wadsworth, on danalite from the iron-mine, Bartlett, N.H.; on picrolite from a serpentine quarry in Florida, with analysis by W. H. Melville.—J. H. Huntington, on the iron ore of Bartlett, N.H.—Dr. Fewkes, on *Rhizophysa filiformis*, with a plate; on the tubes in the larger nectocalyx of *Abyla pentagona*, with a plate.—Prof. E. Morse, on the antiquities of Japan.—F. W. Putnam, on chambered mounds in Missouri; on some explorations in Tennessee, with remarks on some bones of N.E. Indians; on the ornamentation of some aboriginal American pottery.—Dr. Hagen, on a new species of *Simulium* with a remarkable Nympha-case.—W. O. Crosby, on evidences of compression in the rocks of the Boston basin.—Dr. W. K. Brookes, development of the digestive tract in molluscs.—S. H. Scudder, probable age of Haulover Beach, Nantucket Harbour.

## SOCIETIES AND ACADEMIES

### LONDON

Royal Society, May 27—"On the Relation of the Urea to the Total Nitrogen of the Urine in Disease," by W. J. Russell, Ph.D., F.R.S., and Samuel West, M.B., Oxon.

In the valuable series of papers upon the excretion of urea, communicated by Prof. Parkes to the Royal Society, he showed that in health 90 per cent. of the nitrogen in the urine was eliminated in the form of urea. It seemed to us of considerable interest and importance to ascertain whether in disease this statement still held good, or whether, as indeed seemed probable, under altered conditions, nitrogen might not be excreted in some other form. With the view of determining this point, the following experiments were undertaken.

The cases upon which the observations were made fall into two groups—the first, a series taken at random from the hospital, the patients suffering from various diseases, and being under various conditions as regarded diet, muscular exertion, &c. In the second series, the patients were healthy, and placed under conditions as far as possible constant, the amount of diet being fixed, and the patients at absolute rest.

The first series, consisting of twenty-three observations, falls into several small groups. The relation of the urea-nitrogen to the total nitrogen was, in all cases, calculated out in percentage amounts (the total nitrogen being taken as 100), and the mean of each group of observations given.

The first group consists of six cases of pneumonia, and in these the urea-nitrogen represents 90 per cent. of the total nitrogen.

The second, of two cases of jaundice, with two determinations in each. The mean of the first giving 85.7 per cent.; of the second 90.2 per cent.

The third, of two cases of albuminuria, in which the mean is 86 per cent. In these observations the albumen was previously

precipitated and removed. In a third case the determination was made without previously removing the albumen. In this latter, the percentage was 63.6.

The fourth group consists of a collection of cases of various kinds. One of pyæmia, one of typhoid fever, rheumatic fever, acute dysentery, pleurisy, hepatic abscess, and leucocytæmia, two of erysipelas, and two of diabetes, making eleven in all. The mean percentage of them all is 93.8.

The lowest percentage in this first series is found in the cases of albuminuria and of jaundice, a fact of interest as bearing upon the place of production of urea.

The second series consists of eighteen determinations made upon three cases, in which the diet was fixed and the patient in a condition of absolute rest.

These give a mean of 90.1 per cent. The mean of all the cases in the two series is 89.3, or, if the cases of albuminuria and jaundice be excluded, 91.3 per cent., and this agrees almost exactly with the results of Prof. Parkes' experiments, in which the mean arrived at is 91 per cent.

We may therefore assume that the urea-nitrogen may be taken as the measure of the total nitrogen, and that this may be approximately determined by adding 10 per cent. to the amount of urea-nitrogen.

This is, however, only true if the mean of a large number of observations be taken, for there is no fixed relation between, on the one hand, the amount of the urine and the amount of the solids in it, or on the other, between the amount of the various solids *inter se*.

The result, then, of our observations is to prove that the chemistry of the urine remains essentially the same in disease as in health, and that the generalisation of Prof. Parkes is true in either case. The urea may therefore be safely regarded as the measure of the total nitrogen, and as forming 90 per cent. of it.

"On the amount of Nitrogen excreted by Man at rest," by Samuel West, M.B. Oxon, and W. J. Russell, Ph.D., F.R.S.

The three patients, the subjects of this investigation, were all placed under the conditions of the most absolute rest, not being allowed to sit up in bed, or even indeed to feed themselves. Their diet was reduced till it was found that their health was suffering, and then increased until a condition was reached, which may be called one of "clinical equilibrium," when the health, so far as could be determined clinically, was perfect.

The patients were all suffering from the same affection, viz., aneurism, a disease which produces mechanical rather than constitutional symptoms, and in these cases, so long as the treatment was carried on, produced no symptoms at all, so that for all practical purposes the patients may be regarded as healthy men.

The condition of clinical equilibrium being reached, the amount of nitrogen in the food was determined by direct analysis.

In two of the cases the diet consisted of 10 ozs. of solids and 10 ozs. of liquids.

By calculation from Parkes' tables, this should yield 6.3 grms. of nitrogen. Analysis gave a somewhat higher number: in the first determination 7.07, and in the second 6.95.

In the third case the diet was 8 ozs. of solids and 8 ozs. of liquids, distributed in the same proportion. This by calculation from the preceding analysis should give about 5.6 grms. of nitrogen.

Comparing now the amount of nitrogen ingested in the food with the amount obtained from the urine, we find:—

	Nitrogen ingested.	Nitrogen in urine.
Case I. ... ..	7.0	8.6
" II. ... ..	7.0	8.64
" III. ... ..	5.6	6.4

In all the cases the amount in the urine is in slight excess of that in the food, so that we may fairly regard all the nitrogen here obtained as representing tissue waste, for there was no surplus in the food to increase the amount in the urine.

We obtain as the mean of these three cases  $\frac{23.64}{3} = 7.87$ , or approximately 8 grms., which we therefore are justified in regarding as the minimum amount of nitrogen a healthy adult man excretes per diem. This is equivalent to 17 grms., or 260 grains of urea.

It is interesting to compare with these observations the results obtained by the other methods of the investigation above referred to.

Ranke repeated upon man the experiments which Bischoff and

Voit had conducted upon the dog, and among them are two series of observations which illustrate the subject at present under consideration.

In the first no food at all was given, and the patients were kept at rest.

In one case 8 grms. of nitrogen were passed, in a second 10, and in a third 8.6. In a fourth case the amount was as low as 6. And in another series of observations upon himself, Ranke found the amount passed in two starvation days to be 8 and 8.6 grms.

Nicholson made three estimations in the case of starving prisoners, and found as the mean of three days 8.6 grms.

Many other observers have noticed the rapid fall in the amount of nitrogen excreted during starvation.

But the short duration of these experiments makes it probable that the minimum was not reached.

We have then 8 grms. as the mean of the only reliable determination at our command of the nitrogen excreted in the urine during starvation.

Prof. Playfair attacked the question from another side, by collecting from various sources the minimum diets upon which man could live, and to which he gave the name of subsistence diets, and by calculation the amount of nitrogen contained in them. This method gave him as a mean 9.2 grms., but his patients were none of them at absolute rest, but were performing during the day a certain amount of work. Edward Smith in the same way, by calculation from the diets of the spinners during the cotton famine, found a somewhat larger amount of nitrogen (12 grms.), which agrees with the amount of nitrogen contained in Playfair's second class of small diets, but in all these cases the effect of muscular exertion is not eliminated.

Unruh gives a series of three observations upon hospital patients kept at rest and placed upon a restricted diet.

In the first, a case of cancerous obstruction, the amount of nitrogen was 8 grms. (17.5 urea). But this case is not altogether satisfactory, from the amount of wasting accompanying this disease.

The other two were cases of syphilis placed upon fever diet, and kept at rest for the sake of the experiments; the first passed 8.6 grms. (18.6 urea), the second 7.5 grms. (16.2 urea).

The mean of these three cases is 8 grms. (17.5 urea).

The general results of the various series of observations may be roughly tabulated thus:—

- I. Starvation. 8 grms.
- II. Non-nitrogenous food. 8 grms.
- III. Subsistence diet. 9 grms.
- IV. Insufficient diet. 8 grms.
- V. Clinical equilibrium. 8 grms.

A remarkable coincidence, considering the variety of the methods employed and the different conditions under which the determinations were made.

We may therefore conclude that the minimum amount of nitrogen excreted by a healthy adult man is on the average 8 grms. in the twenty-four hours, this being equivalent to 17.5 grms., or to 260 grains of urea.

Geological Society, June 9.—Robert Etheridge, F.R.S., president, in the chair.—John Burn Anstis du Sautoy and Rev. John Cowley Fowler, B.A., were elected Fellows; Prof. G. Dewalque, Liège, a Foreign Member, and Prof. Leo Lesquereux, Columbus, U.S., a Foreign Correspondent of the Society.—The following communications were read:—On the occurrence of marine shells of existing species at different heights above the present level of the sea, by J. Gwyn Jeffreys, F.R.S., Treas. G.S. This paper resulted from the author's examination of the molluscs procured during the expeditions of H.M.S.S. *Lightning* and *Porcupine* in the North Atlantic. He stated that he found several species of shells living only at depths of not less than between 9,000 and 10,000 feet, which species occurred in a fossil state in Calabria and Sicily at heights of more than 2,000 feet, such depths and heights together exceeding the height of Mount Etna above the present level of the Mediterranean. He then gave an account of the post-tertiary deposits in Europe, Asia, and North America, to show their various heights, and especially of the raised beach on Moel Tryfaen in Caernarvonshire, which was from 1,170 to 1,350 feet high. Some of the shells in that deposit were boreal, and did not now live in the adjacent sea. The author stated that no shells of a peculiarly northern character had been noticed in the west or south of England. He then questioned the permanence and even the antiquity of the present oceanic basins, from a consideration not only of the fauna which

now inhabits the greatest depths, but also of the extent of oscillation which had prevailed everywhere since the Tertiary period. A complete list of the Moel Tryfaen fossils was given, to the number of sixty, besides three distinct varieties, of which number eleven were Arctic or northern, and the rest lived in Caernarvon Bay. All of these fossils were more or less fragmentary.—On the pre-Devonian rocks of Bohemia, by J. E. Marr, B.A., F.G.S. The author commenced with a brief notice of the pre-Cambrian rocks, which are gneisses and schistose limestone with intrusive eclogite; over these lie unconformably green grits, ashes, breccias, hornstones (étage A of Barrande), which the author considers to represent the Harlech group of Wales. Étage B is unconformable with this, but conformable with C, which contains the "primordial" fauna. D contains the colonies. E to H are Silurian, and more calcareous than those underlying them. The base of the group is unconformable with those beneath. The lithological characters of the various beds were described. The following are the associated igneous rocks:—Granite, quartz feltite, porphyrite, mica-trap, diabase, diorite, eclogite. Of these brief descriptions were given. The author gave a comparison of the various shales with English deposits. The pre-Cambrian series much resemble the Dimetian and Pebidian of Wales, the latter being étage A; étage B, the Harlech; étage C, the Menevian, probably a deep-water deposit, as is indicated by the abnormal size of the eyes of its Trilobites; the lowest bed of étage D probably represents part of the Lingula flags of Britain. D,  $\alpha$ , 1,  $\beta$ , seems to represent the Tremadoc shale of Britain, and, like it, contains pisolitic iron-ore. Representatives also of the Arenig and Bala beds are found. A slight unconformity marks the base of the Silurian. Three graptolitic zones occur. The lowest, or *Diplograptus* zone, identical with the Birkhill shales, contains thirteen species of graptolites; the next, or *Priodon* zone (four species) resembles the Brathay flags; the upper, or *Colonies* zone (five species), resembling the Upper Coldwell beds of the Lake-district. Above these follow representatives of Wenlock, Ludlow, and probably of the Passage beds. The author, with the evidence of these, discussed the "colonies" theory of M. Barrande, pointing to the non-intermixture of species, notwithstanding the irregular repetition of the zones, the non-occurrence of these colony species in intermediate beds, and other reasons. The stratigraphy and palæontology of several of these colonies were discussed in detail, showing it to be more probable that their apparent intercalation with latter faunas is due to repetition by faulting.—On the pre-Cambrian rocks of the North-Western and Central Highlands of Scotland, by Henry Hicks, M.D., F.G.S. The author, after examination, considers the rocks of the following districts to be wholly or in part pre-Cambrian:—(1) *Glen Finnan, Loch Shiel to Caledonian Canal*; (2) *Fort William and Glen Nevis*; (3) *Ballachulish, Glen Coe, and Black Mount*; (4) *Tyndrum to Callander*. The author states that the Silurian (and Cambrian) rocks flank the pre-Cambrian in lines from north east to south-west, and overlap Ben Ledi on the south side. Thus here, as elsewhere, subsequent denudation has removed enormous masses of the more recent rocks, only here and there leaving patches of these in folds along depressions in the old pre-Cambrian floor.

#### EDINBURGH

Royal Society, May 17.—Mr. D. Milne Home, vice-president, in the chair.—Mr. J. B. Haycraft, M.B., B.Sc., read a paper on a method for the quantitative estimation of urea in the blood. The method depended upon the fact that one can dialyse the fluid parts of blood into alcohol, into which the urea passes in a very pure form. The alcohol containing the urea is evaporated, the residue washed with petroleum ether, re-extracted, and estimated after the method of Huefner. This method yields urea from so small a quantity of blood as 10 cc., and shows that more is present than was formerly conjectured, there being on an average 35 parts per 100,000.—Mr. Patrick Geddes, in his paper on the phenomena of variegation and cell-multiplication in a species of *Enteromorpha*, pointed out that the development of colourless cells in this alga was by a process of budding into the intercellular spaces between the coloured cells, so that both kinds of cell-multiplication, by fission and by budding, were exemplified in the same plant.—Prof. Tait gave a communication on the accurate measurement of high pressures. For pressures up to a few tons the behaviour of nitrogen had been thoroughly investigated (at least at one temperature). By comparison with a nitrogen compression gauge, a scale could be

constructed for a pressure gauge registering by the compression of the walls of a thinnish glass cylinder containing mercury; and this scale could be applied as long as the limits of elasticity, as defined by Hooke's law, were not exceeded. To determine when these limits were being approached, a similar glass cylinder with thicker walls was to be compared with the former one, which would be the first to deviate. This second gauge, with its higher limits of elasticity, could then be used for the higher pressures; and when its indications began to deviate from Hooke's law, a third and still stronger gauge could be substituted, its constants having been determined similarly by comparison with the second gauge. And thus a series of graduated gauges could be constructed to measure extremely high pressure; and at length when the pressure was such as to crush glass, a steel gauge constructed on somewhat similar principles could be substituted, being graduated first by comparison with the strongest glass gauge. Thus accurate measurements of high pressures could be obtained up to the point at which the compressing apparatus itself would begin to give way.—Mr. D. Milne Home, as convener of the Boulder Committee, presented the sixth report, and gave a notice of its chief features.—Prof. Turner exhibited a curious collection of natural masks and skulls from New Guinea and neighbouring islands.

VIENNA

Imperial Academy of Sciences, April 15.—Observations on the deadening of torsion oscillations by internal friction, by Dr. Klemencic.—Studies on the decomposition of simple organic compounds by zinc powder; I. alcohol, by Prof. Ludwig.—On the action of some metals and metalloids on phosphorus oxychloride; and the existence of Leverrier's phosphoric oxide, by H. H. Renitzer and Goldschmidt.—On the saltiness of water in the Norwegian North Sea, by Herr Tornoe.—New methods of finding mean geometric proportions, by Herr Zimels.—On the former and present position of geology and geogony, and the methods of research in these directions, by Dr. Boué.—Geological observations in Southern Calabria, by Dr. Burgenstein and Herr Noe.—Radiant electrode matter, by Dr. Pulu.

PARIS

Academy of Sciences, June 14.—M. Edm. Becquerel in the chair.—The following papers were read:—On papaine; contribution to the history of soluble ferments, by M. Wurtz. Alcohol precipitates from the juice of papaya, a principle of variable composition, but, when purified by dialysis, approximating to albuminoid matters. Papaine purified with subacetate of lead has the composition and characters of such matters. The rapid liquefaction of fibrine by papaine may occur in presence of prussic, boric, or even carbolic acid (conditions excluding microbe).—Geological history of the English Channel (second part), by M. Hébert.—Craniology of African negro races; non-dolichocephalic races, by M. de Quatrefages. The ninth volume of the "Crania Ethnica" finishes the account of negro races, and enters on the yellow or Mongolic races. M. Hamy finds in Africa that not only in individuals, but in entire populations occupying considerable spaces, and in some instances extending through about four-fifths of the Continent from east to west, there is an absence of dolichocephaly. One portion of these, marked also by small stature, are sub-brachycephalic generally, but sometimes reach brachycephaly; M. Hamy calls them Negrillo. He characterises various races that have hitherto been confounded.—New experiments on the resistance of Algerian sheep to spleen-disease, by M. Chauveau. The twelve European sheep tested all died after a single inoculation. Of forty-seven Algerian sheep, thirty-nine proved resistant after repeated inoculations.—M. Stas was elected Correspondent in Chemistry in room of the late M. Zinin.—On the value of gravity at Paris, by M. Peirce. He considers (from certain corrections) that the value hitherto given should be increased by one-ten-thousandth.—Determination of a function with only one variable, in a given interval, according to mean values of this function and of its successive derivatives in this interval, by M. Leauté.—On the resolution of the equation  $x^n + y^n = z^n$ , in whole numbers, by M. Lefébure.—Experimental researches on magnetic rotatory polarisation in gases, by M. Henri Becquerel. The memoir presented relates chiefly to various small corrections in his direct measurements, the most important being due to influence of magnetism on the glass closing the tubes. For the gases nitrogen, carbonic acid, protoxide of nitrogen, and olefiant gas (not for oxygen), he finds the magnetic rotations for rays of different wave lengths nearly in inverse ratio of the square of the wave lengths as for non-magnetic solid bodies and liquids. The inti-

mate connection of the rotation with the refractive index: shown. Oxygen, curiously, gives with red rays a rotation very little above that with green (in the other gases the deflection is greater for green rays in the ratio of about 1:50). This may be connected with the very magnetic character of oxygen.—O the constancy of the proportion of carbonic acid in the air, by M. Schloesing. He calculates that the sea holds in reserve quantity of CO<sub>2</sub> disposable for exchange with the air ten times greater than the whole quantity in the atmosphere, and much greater, *a fortiori*, than the variations of this quantity; hence: strong regulative action on the amount of aerial CO<sub>2</sub>.—On cause which tend to warp the girders of iron bridges and means of planning these girders so as to resist warping influences by M. Périssé.—On the transcendents which play an important part in the theory of planetary perturbations, by M. Darboux.—M. Gauguain's death was announced.—On the figure of the planet Mars, by M. Hennessy.—On the equivalence of forms, by M. Jordan.—The tensions of saturated vapours have different modes of variation according as they are emitted above or below the point of fusion, by M. De Mondesir.—Action of bromide of methyl and of iodide of methyl or monomethylamine, by MM. Duvillier and Buisine.—On the transformation of terebentene into cymene, by M. Brucré.—Preparation of indoline and its compounds, by M. Giraud.—On the existence of a lymphatic circulation in *Pleurometes*, by M. Jourdain. The appearances in *Platessa vulgaris*, Cuv., and *Plat. fleus*, Cuv., are described. There are vessels which convey the lymph to peripheric parts, and others which bring it to a central reservoir. Also, the lymph seems to be aërated in vessels in the branchiae. The lymph-reservoir has no intrinsic muscles (to effect the circulation), but the fibres acting on it seem to belong to the respiratory apparatus.—On the physiological action of *Thalictrum macrocarpum*, by MM. Bochefontaine and Doassans. *Thalictrine*, the active principle of this plant (found in a certain part of the Pyrenees), acts first on the central encephalomedullary nervous system, then on the heart, arresting the functions; it affects nervous excitomotricity, and diminishes muscular contractility. It resembles aconitine, but is not so active.—On the micrographic analysis of water, by M. Certes. He treats water with a 1.5 per cent. solution of osmic acid (1 cc. of this to 30 to 40 cc. of water); the acid kills any organisms present without deforming them; they sink to the bottom and may be examined microscopically. Some colouring reagents mixed with dilute glycerine may also be used.—On the place of formation of adventive roots of monocotyledons, by M. Mangin.

CONTENTS

PAGE

A STEP BACKWARDS . . . . .	165
FRESHWATER PHIZOPODS OF NORTH AMERICA . . . . .	165
THE RECENT PROGRESS OF ENGLISH PHILOLOGY. By Rev. A. H. SAYCE . . . . .	167
OUR BOOK SHELF:—	
Williamson's "Fern Etchings; Illustrating all the Species of Ferns Indigenous to the North-Eastern United States and Canada" . . . . .	168
LETTERS TO THE EDITOR:—	
The Fourth State of Matter.—THE DUKE OF ARGVLL . . . . .	168
The Fine Wire Telephone.—Prof. G. CRYSTAL ( <i>With Illustration</i> ) . . . . .	168
The Aurora Borealis and its Colours.—Dr. WARREN DE LA RUE, F.R.S.; Dr. HUGO MÜLLER, F.R.S. . . . .	169
On some Points Connected with Terrestrial Magnetism.—Dr. WARREN DE LA RUE, F.R.S.; Dr. HUGO MÜLLER, F.R.S. . . . .	169
Calcareous Concretions in Timber.—Dr. G. BIDIE . . . . .	169
Remarkable Discovery of a Murder in Bermuda.—H. N. MOSLEY . . . . .	170
On the Simplest Continuous Manifolds of Two Dimensions and of Finite Extent.—F. W. FRANKLAND . . . . .	170
Ascent of Etna.—G. . . . .	171
Colour Combinations.—C. J. WOODWARD . . . . .	171
Wild Swans.—Notes of Birds.—J. BIRMINGHAM . . . . .	171
Anchor-Ice.—C. F. C. . . . .	171
SCIENTIFIC RESULTS OF THE HOWGATE POLAR EXPEDITION, 1877-78 . . . . .	171
EXPERIMENTAL RESEARCHES IN ELECTRICITY, II. By WARREN DE LA RUE, M.A., D.C.L., F.R.S., and HUGO W. MÜLLER, Ph.D., F.R.S. ( <i>With Illustrations</i> ) . . . . .	174
THE NEW FRESHWATER JELLY-FISH. By Prof. E. RAY LAMBERTER, F.R.S.; Prof. G. J. ALLMAN, F.R.S.; GEORGE J. ROMANES, F.R.S. . . . .	177
NOTES . . . . .	181
OUR ASTRONOMICAL COLUMN:—	
Kepler's Nova of 1604 . . . . .	184
Westphal's Comet (1838 IV) . . . . .	184
GEOGRAPHICAL NOTES . . . . .	184
SIR JOHN LUBBOCK ON THE HABITS OF ARTS . . . . .	185
UNIVERSITY AND EDUCATIONAL INTELLIGENCE . . . . .	185
SCIENTIFIC SERIALS . . . . .	185
SOCIETIES AND ACADÉMIES . . . . .	185



THURSDAY, JULY 1, 1880

## THE SACRED BOOKS OF THE EAST

*The Sacred Books of the East.* Edited by F. Max Müller. Vols. iv., v., and vii. (Clarendon Press, 1880.)

THE great work upon which Prof. Max Müller is engaged goes on apace. Volume after volume issues from the University Press containing the principal portions of the sacred literature of the East translated by competent scholars. The materials for a science of religion are being rapidly accumulated. The grand conception of a science which shall trace the development and relations of the religions of the world and determine the laws that have presided over their birth, their growth, and their decay is no longer a dream of the distant future. Before many years are over the materials will be in our hands for realising that conception, if indeed it is ever to be realised at all.

The fourth and fifth volumes of the series introduce us to Zoroastrianism, the great Puritan religion of the Aryans, and thus the counterpart of Mohammedanism in the Semitic world. The fourth volume contains M. Darmesteter's translation of the Vendîdâd, a compilation of religious laws and mythological tales which forms the first part of the Avesta or Zoroastrian bible. The two other parts consist of the Vispêrad or litanies for the sacrifice, and the Yasna, which includes five hymns or Gâthâs written in a peculiar dialect and constituting the oldest portion of the Avesta. Besides these the Parsis also reverence the Khorda Avesta or Small Avesta, comprising short prayers, the Yashts or hymns of praise, and several other fragments.

These are all that is left of a much larger body of sacred literature which once existed among the disciples of Zoroaster. According to Parsi tradition, out of the twenty-one Nosks or books revealed to the Mazdean prophet one only, the Vendîdâd, remains complete, and though this tradition cannot be accepted in its literal form, there is abundant evidence that the Parsis have saved only scattered fragments out of the wreck of their sacred books caused by Greeks, by Christians, and by Mohammedans. In their present shape, moreover, these fragments do not go back beyond the age of the Sassanians, indeed they bear traces of even later modernisation; but the basis upon which they rest, the leading ideas they embody, and numerous passages that are imbedded in them are of much earlier date. If we may trust Dr. Oppert's translation of the Protomedic transcript of the inscription of Darius Hystaspis at Behistun, it was that Persian monarch who ordered the Avesta or "law" and the Zend or "Commentary" to be restored after the religious disturbances of the Magian usurpation. At any rate there can be little doubt that both existed before the foundation of the Persian Empire.

But like all other religions, Mædeism developed and became changed in the process of time, and this development and gradual change may be read in the records of its sacred books. M. Darmesteter points out the untenability of the view which made it at the outset a revolt against the old Vedic religion of the Eastern Aryans; on the contrary, it grew naturally out of the elements, religious and mythological, which were reflected in the

VOL. XXII.—No. 127

Rig-Veda of India, and even after taking shape and consistency, after the days of Darius and the Sassanians, it still continued to grow. In the hands of its priests it became more and more rigorous and ceremonial; ancient texts were misinterpreted, and the misinterpretation carried out to its logical consequences.

In the fifth volume Dr. West introduces us to a later phase of Zoroastrian belief. He translates for us the Pahlavi texts, the Bundehesh, the Zâd-sparam, the Bahman Yasht, and the Shâyast lâ-shâyast, which are translations and explanations of the older Avesta. The Zend language had become obsolete, and the books written in it accordingly required to be translated and interpreted. The Pahlavi texts have, therefore, preserved portions of the ancient Zoroastrian scriptures which would otherwise have been lost. The Pahlavi is the language of mediæval Persia, the daughter of the Persian of Darius and his successors, and the niece of the Zend dialect of the Avesta. Our acquaintance with it practically begins with the inscriptions of Artakshshîr-i Pâpakân (A.D. 226-240) the founder of the Sassanian dynasty, and ends with Parsi writings, one of the latest of which is dated A.D. 881. The Pahlavi alphabet is an exceedingly difficult one; its letters have been corrupted to a prodigious extent, so that a large number of them are written exactly alike. The difficulties in the way of reading it may therefore be imagined. Pahlavi texts, however, are not always written in the Pahlavi alphabet; sometimes the Zend alphabet of the Avesta, sometimes the modern Persian alphabet, is used instead.

But the reading of these texts is further complicated by the introduction of Semitic words, which have, however, to be replaced in pronunciation by their Persian equivalents. Thus what is written *malkân malkâ*, "king of kings," would have to be pronounced *shâhân shâh*. The same phenomenon meets us in the cuneiform inscriptions, where an Accadian word often occurs in an Assyrian text, for which its Assyrian equivalent has to be substituted in reading, and so too in modern Japanese Chinese words are written but translated into Japanese by the reader. The usage of Pahlavi seems to be ancient, since the cuneiform alphabet of the Achæmenian inscriptions was obtained by Darius by translating a certain number of Assyrian ideographs into Persian and then setting apart the initial sound of the Persian word as the alphabetic value of the ideographic character. In addition to these Semitic logograms the Parsis also gave a conventional pronunciation to certain obsolete Persian words, the true pronunciation of which they had forgotten and were unable to recover owing to the obscurities of Pahlavi writing, and the employment of these two kinds of logograms is termed Huzvâresh.

The seventh volume contains a translation by Prof. Jolly of the Vishnu-sûtra, a semi-inspired Hindu law-book belonging to one of the schools who studied the Black Yajur Veda, and closely related to the famous Code of Manu. It has been revised by a Vishnuitic editor of comparatively recent date, but the substance of it goes back to an early time, before the introduction of ~~any~~ or widow-burning, or even, it may be, the rise of Buddhism. It will be interesting to the lawyer as well as to the student of religion, who will be tempted to compare it with the book of Leviticus. Its minute and absurd

regulations as to ceremonial expiation and penance, its tyrannous assertion of Brahminical domination, and its unpractical and unspiritual character will illustrate the condition to which a religion may be brought by mere subtlety and barren meditation, divorced from active life and influenced by an interested priesthood.

A. H. SAYCE

#### EVOLUTION OF THE VEGETABLE KINGDOM

*Versuch einer Entwicklungsgeschichte der Pflanzenwelt, insbesondere der Florengebiete seit der Tertiärperiode.* Von Dr. Adolf Engler. I. Theil. Die Extratropischen Gebiete der Nördlichen Hemisphäre. Mit einer chromolithographischen Karte. 8vo. pp. 202. (Leipzig: Verlag von Wilhelm Engelmann, 1879.) Essay of a History of the Evolution of the Vegetable Kingdom, especially of the Floral Areas since the Tertiary Period. Part I.—The Extratropical Regions of the Northern Hemisphere.

PHYTOGEOGRAPHY still presents many difficult problems, the final solution of some of which is extremely unlikely, though patient research will doubtless bring us much nearer the truth than we have yet reached. The latest comprehensive work on the subject (Grisebach's "Vegetation der Erde") is a very good exposition of the existing distribution of plants, but it is nothing more. Since the promulgation of the theory of descent, however, the study of the dispersion of plants has entered upon a fresh phase, and it has received the attention of some of the ablest minds engaged in botanical pursuits; and with the ever-increasing geological evidence of the composition of the floras of former periods there is a good prospect of a real advance in this branch of science. Unfortunately there is a tendency to travel far beyond a point warranted by the evidence. This remark specially applies to the determination of many of the fossils of the earliest Tertiary times. Whether fresh discoveries will prove the correctness or the incorrectness of Unger's "New Holland in Europe," we do not venture to predict, though we think the latter; but we agree with Saporta that most of the assumed determinations are better designated by such terms as affiliation and collocation (*assimilation et rapprochement*). Dr. Engler is not an unknown worker in phytogeography, for in his various monographs, especially in that of the genus *Saxifraga*, he has set forth the views which he, in some respects, more fully elaborates in the work before us. The essay itself is preceded by thirty-six formulated leading ideas (*leitende Ideen*), which may, for our purpose, be reduced to one, namely, the relation of evolution and geological changes to distribution. Dr. Engler endeavours to trace the descent and migration of the vegetation of the regions under consideration since the Tertiary period by the aid of geological and recent evidence, but for various reasons he does not go back beyond the Miocene period. In his conception of the Miocene period he is in accord with Prof. Heer, who, he thinks, has easily refuted the arguments adduced by Mr. Starkie Gardner in support of his opinion that much of what Prof. Heer regards as Miocene is referable to the Eocene period. The author divides his subject into five sections and eighteen chapters. In the first section he treats of the development of the flora of North America from the Miocene period to the Glacial epoch; the second is devoted to the

development of the flora of Eastern and Central Asia since Tertiary times; the third to the main features of the development of the Mediterranean flora since the Tertiary period; the fourth to the development of the high mountain flora before, during, and after the Glacial epoch; and the fifth to the consideration of the development of the floras of other countries influenced by the Glacial period. The map is constructed to show, as nearly as possible, the configuration of land and water in Tertiary times, the direction of the spreading and change of the vegetation during and after the gradual drying-up of the Tertiary seas, and the most important migratory routes of the Glacial plants. Disregarding the evolutionary element, which must necessarily be to a large extent purely speculative, Dr. Engler's essay is exceedingly interesting and instructive. The mere collocation of the facts bearing upon the subject renders it so, independently of the author's deductions therefrom. So far as the migratory part is concerned, it may be designated as an amplification, with some modifications, of the theory recently discussed by Dr. Asa Gray, Sir Joseph Hooker, Mr. Thiselton Dyer, and others. Dr. Engler does not find the contrast so great in the development of the Asiatic element in the vegetation of Eastern and Western North America, and there is no doubt of the existence of many more Asiatic types in Western North America than was formerly suspected. Diligent as the author has been in collecting evidence, he has overlooked some that he would have found useful. Thus at page 29 he seeks to explain the "extraordinarily interrupted distribution" of *Monotropa uniflora* and *Phryma leptostachya*, both of which he assumes to be limited to the Himalayas, North-eastern Asia, and Eastern North America. Now *Monotropa uniflora* is common in North America west of the Rocky Mountains, as evidenced by specimens and collectors' notes in the Kew Herbarium; and it likewise occurs in Mexico, New Granada, Sachalin, and the Corea. The distribution of *Phryma*, too, is by no means so restricted as Dr. Engler supposes. But these are minor details which do not affect the main issues.

Although evolution is the pervading feature of the work, the author nowhere attempts to point out the original types from which other species have descended, as he does in his monograph of the genus *Saxifraga*. Bunge, who devoted much time to the study of large genera, constructed a genealogical tree to illustrate the possible descent of the species of *Acantholimon*, but he admits that the result was eminently unsatisfactory. If so difficult to trace the descent of a genus having the distribution of *Acantholimon*, we may excuse Dr. Engler for being less successful on the evolution theme than he is on migration.

W. B. HEMSLEY

#### LETTERS TO THE EDITOR

- [The Editor does not hold himself responsible for opinions expressed by his correspondents. Neither can he undertake to return, to correspond with the writers of, rejected manuscripts. Notice is taken of anonymous communications.]
- [The Editor urgently requests correspondents to keep their letters short as possible. The pressure on his space is so great that it is impossible otherwise to ensure the appearance even of communications containing interesting and novel facts.]

#### The Freshwater Medusa

I OBSERVE in Prof. Allman's article of last week (p. 178) that this organism, that he states that the article in question in-  
cluded

"additional facts not contained in the paper" read by him to the Linnean Society.

Although Prof. Allman does not directly allude to my article of the week before (p. 147), I may assume that the statements which he makes in opposition to my conclusion that *Limnocodium* (*Craspedacustes*) belongs to the group of the *Trachomedusæ* were elicited by the publication of my results.

I intend in the July number of the *Quarterly Journal of Microscopical Science* to show in an illustrated memoir that, contrary to the conclusion of Prof. Allman, the tentacles of *Limnocodium* do resemble those of the *Trachylinae Medusæ* in their insertion and in the possession of true (though rudimentary) peronia, as I stated in my original note and in my paper read to the Royal Society on June 17. I shall also show that my statement that the so-called lithocysts or marginal bodies have essentially the same structure as those of *Trachylinae Medusæ* (being modified tentacles with an endodermal axis) is warranted by the developmental history of the bodies in question. Consequently I adhere to my original determination of the affinities of the new *Medusa* as one of the order *Trachomedusæ*, and cannot agree with Prof. Allman that its affinity with the *Leptomedusæ* must be regarded as the closer of the two.

Prof. Allman states that he has arranged certain methods of observation with Mr. Sowerby, by which he hopes to determine the developmental history of *Limnocodium*. It will be of the greatest interest to have this matter fully investigated, and to know what are the methods which Prof. Allman has devised to this end. Mr. Sowerby informs me that at present he has undertaken no experiments of the kind excepting the isolation of specimens in two glass jars in the lily-house, which he carried out at my special request on June 15.

In the meantime I may say that I have fully satisfied myself that *Limnocodium* develops directly from the egg. When specimens are kept living in a glass jar under constant observation it is found that exceedingly small specimens of the *Medusa* make their appearance amongst the larger specimens. Mr. Sowerby had already determined this fact a fortnight ago, when I first was introduced by him to the *Medusa*. I have now, through his kindness, been able to examine several young phases of *Limnocodium*, the discovery of which is entirely due to him.

The youngest specimen which I have seen at present measured only the one-thirtieth of an inch in diameter, and I have had others under observation very little larger. The smallest was of a sub-spherical form without any aperture to the ectodermal investment. Four minute tentacles were sprouting near one pole of the spherical body, and between these rudiments of four others were seen. Within—the subumbrellar musculature was already developed and contracting at intervals. The four radial canals were also present, and, what is more remarkable, the sub-umbrellar cavity was already well marked, and within it the manubrium with the oral aperture. Yet the margin of the umbrella was still closed by a continuous ectodermal coat which, when perforated, would, I conceive, become the velum.

These minute embryos correspond very closely in appearance with the embryos of the well-known typical *Trachomedusan Geryonia*, as figured by Metschnikow in the *Zeitsch. für wiss. Zoologie*, vol. xxiv., Plate II., Figs. 12 and 15.

They leave no possibility of supposing that *Limnocodium* has, like most *Leptomedusæ*, a hydroid trophosome. In respect of its development as in other respects, *Limnocodium* is not more closely allied to the *Leptomedusæ* than to the *Trachomedusæ*, but is one of the *Trachomedusæ*.

A remarkable fact which I am not able to explain is the excessive rarity of females amongst the specimens of *Limnocodium* taken from the tank in Regent's Park. All the specimens which I have examined have been males. Females clearly enough must be present, or have been present amongst the shoals of males—whence the embryos discovered by Mr. Sowerby.

It is a known fact among *Trachylinae Medusæ* that in some species males are excessively abundant, and even in some species females have never been detected. Thus again *Limnocodium* agrees with the *Trachylinae Medusæ*.

One word more with regard to the name of the new *Medusa*. Whilst I waive the right of priority for the generic term *Craspedacustes*, and adopt Prof. Allman's term *Limnocodium*, I feel it to be only right to maintain the association of Mr. Sowerby's name with this discovery, which I had originally proposed, and I shall accordingly henceforth speak of the *Medusa* as *Limnocodium Sowerbii*, Allman and Lankester.

E. RAY LANKESTER

#### Aqueous Vapour in Relation to Perpetual Snow

SOME twelve years ago I gave (*Phil. Mag.*, March, 1867, "Climate and Time," p. 548) what appears to be the true explanation of that apparently paradoxical fact observed by Mr. Glaisher, that the difference of reading between a thermometer exposed to direct sunshine and one shaded *diminishes*, instead of increases, as we ascend in the atmosphere. This led me to an important conclusion in regard to the influence of aqueous vapour on the melting-point of snow; but recent objections to some of my views convince me that I have not given to that conclusion the prominence it deserves. I shall now state in a few words the conclusion to which I refer.

The reason why snow at great elevations does not melt but remains permanent, is owing to the fact that the heat received from the sun is thrown off into stellar space so rapidly by radiation and reflection that the sun fails to raise the temperature of the snow to the melting-point; the snow evaporates, but it does not melt. The summits of the Himalayas, for example, must receive more than ten times the amount of heat necessary to melt all the snow that falls on them, notwithstanding which the snow is not melted. And in spite of the strength of the sun and the dryness of the air at those altitudes, evaporation is insufficient to remove the snow. At low elevations, where the snowfall is probably greater and the amount of heat even less than at the summits, the snow melts and disappears. This, I believe, we must attribute to the influence of aqueous vapour. At high elevations the air is dry and allows the heat radiated from the snow to pass into space, but at low elevations a very considerable amount of the heat radiated from the snow is absorbed in passing through the atmosphere. A considerable portion of the heat thus absorbed by the vapour is radiated back on the snow, but the heat thus radiated, being of the same quality as that which the snow itself radiates, is on this account absorbed by the snow. Little or none of it is reflected like that received from the sun. The consequence is that the heat thus absorbed accumulates in the snow till melting takes place. Were the amount of aqueous vapour possessed by the atmosphere sufficiently diminished, perpetual snow would cover our globe down to the sea-shore. It is true that the air is warmer at the lower level than at the higher level, and by contact with the snow must tend to melt it more at the former than at the latter position. But we must remember that the air is warmer mainly in consequence of the influence of aqueous vapour; and that were the quantity of vapour reduced to the amount in question the difference of temperature at the two positions would not be great.

But it may be urged, as a further objection to the foregoing conclusion, that as a matter of fact on great mountain chains the snow-line reaches to a lower level on the side where the air is moist than on the opposite side where it is dry and arid. As, for example, on the southern side of the Himalayas and on the eastern side of the Andes, where the snow-line descends some 2,000 or 3,000 feet below that of the opposite or dry side. But this is owing to the fact that it is on the moist side that by far the greatest amount of snow is precipitated. The moist winds of the south-west monsoon deposit their snow almost wholly on the southern side of the Himalayas, and the south-east trades the snow on the east side of the Andes. Were the conditions in every respect the same on both sides of these mountain ranges, with the exception only that the air on one side was perfectly dry, allowing radiation from the snow to pass without interruption into stellar space, while on the other side the air was moist and full of aqueous vapour absorbing the heat radiated from the snow, the snow-line would in this case undoubtedly descend to a lower level on the dry than on the moist side. No doubt more snow would be evaporated off the dry than off the moist side, but melting would certainly take place at a greater elevation on the moist than on the dry side, and this is what would mainly determine the position of the snow-line.

In like manner the dryness of the air will in a great measure account for the present accumulation of snow and ice on Greenland and on the Antarctic continent. I have shown on former occasions that those regions are completely covered with perpetual snow and ice, not because the quantity of snow falling on them is great, but because the quantity melted is small. And the reason why the snow does not melt is not because the amount of heat received during the year is not equivalent to the work of melting the ice, but, mainly because of the dryness of the air, the snow is prevented from rising to the melting-point.

There is little doubt but that the cold of the glacial epoch would produce an analogous effect on temperate regions to that

experienced at present on Arctic and Antarectic regions. The cold, although it might to some extent diminish the snowfall, would dry the air and prevent the temperature of the snow rising to the melting-point. It would not prevent evaporation taking place over the ocean by the sun's heat, but the reverse, but it would prevent the melting of the snow on the land during the greater part of the year.

In places like Fuego and S. Georgia, where the snow-fall is considerable, perennial snow and ice are produced by diametrically opposite means, as I have elsewhere shown, viz., by the sun's heat being cut off by clouds and dense fogs. In the first place the upper surface of the clouds act as reflectors, throwing back the sun's rays into stellar space; and in the second place, of the heat which the clouds and fogs absorb, more than one-half is not radiated downwards on the snow, but upwards into space. And the comparatively small portion of heat which manages to reach the ground and be available in melting the snow is insufficient to clear off the winter's accumulation.

JAMES CROLL

#### Artificial Diamonds

ON reading Mr. Hannay's communication to the Royal Society on the production artificially of crystallised carbon or diamond (*Proc. Roy. Soc.*, vol. xxx., No. 204, May, 1880), in the course of which Mr. Hannay states that he has made eighty experiments, only three of which have been successful. In almost every case his iron or steel vessels, enormously thick in proportion to their small bore, have burst at a red heat or above it, by the pressure of the included hydrocarbon vapour.

Will Mr. Hannay permit me to suggest to him that if, instead of an enormously thick and difficult to weld up tube, he will inclose his materials in a comparatively thin one and then inclose that in another like tube shrunk on or contracted over the former, and so on to a third, or, if necessary, fourth tube, each possessing an initial tension upon those within it, he may thus obtain compound tubes either of wrought iron or steel easily welded staunch, and capable of withstanding any assignable amount of internal elastic pressure. This is the principle upon which, since 1855, all rifled artillery is constructed.

The Grove, Clapham Road, June 22

R. MALLETT

#### A Fourth State of Matter

IN Mr. Crookes' communication on this subject (*NATURE*, vol. xxii, p. 153) occurs the sentence, "An isolated molecule is an inconceivable entity." This proposition would appear to me to be questionable. For if we cannot conceive an isolated molecule, how are we to conceive of two (or more) molecules, *i.e.*, conceive of matter at all? For the conception of two molecules involves the isolation of each in the mind, otherwise surely the two would be mentally blended into one. It is further said of a molecule, "Solid it cannot be." May not the external qualities ordinarily attributed to a "solid" be said to be those of a body possessing a certain amount of rigidity (*i.e.*, whose parts resist displacement) combined with a certain elasticity? Would not these be substantially the properties of a single vortex molecule, according to those who have investigated this subject? For it appears that such a molecule would be (perfectly) elastic, and inseparable into parts. At the same time it would seem that there would be nothing to prevent it from being harder or more rigid than any large scale solid (built up of such molecules?) with which we are acquainted.

"A fourth state of matter," as it appears to me, is a distinction which has something arbitrary about it. If (for instance) the æther be a gas, the mean length of path of whose minute molecules is not less than planetary distances—a proposition which it might not be easy to disprove directly—then this would be a mean path indefinitely greater than that of the molecules of the most rarefied gas. Would it, however, be legitimate to regard the æther (under this condition) as matter in "a fourth state"? This would seem, in my judgment at least, only to complicate the subject unnecessarily. For after all we are concerned in such cases with the mere quantitative difference of length of path.

S. TOLVER PRESTON

London, June 28

#### Auroral Observations

IN order to get nearer, if possible, to the unravelling of the mysteries of the aurora borealis, I have in the course of the last

two years endeavoured to procure a great number of observations of this phenomenon in Norway, Sweden, and Denmark. I have succeeded in engaging throughout the above-named countries several hundreds of observers, who, led only by scientific interest, have lent me their assistance, and from whom I have already received a considerable amount of information. These observations are to be continued, as there is reason to suppose that the aurora borealis in the near future will appear much more frequently than has been the case during the last years. Finland and Iceland will also now be drawn within the circle, and it would be most desirable that similar observations were made also in Great Britain, which country—especially in the maximum years of the appearance of the aurora borealis—certainly would yield characteristic contributions in this respect. I therefore take the liberty to invite friends of science to make such observations in accordance with the system which I have introduced in Scandinavia; a schedule for recording observations, along with the necessary instructions, will be sent to any one who, before the end of August, informs me of his name and address.

SOPHUS TROMHOLT

Bergen, Norway, June

Professor of Mathematics

Other papers in Great Britain are requested kindly to give the above appeal a place in their columns.

#### The Hydrographic Department

AS you have been misinformed on several points respecting my connection with the Hydrographic Department, I request, both on public grounds and in ordinary fairness to myself, that you will insert the following corrections of statements in your article on this subject in *NATURE*, vol. xxii, p. 86.

My work on the Norwegian coast has not been "dignified into a hydrographical survey." That work, combined with my knowledge of the Norwegian language, charts, and pilotage, satisfied the hydrographer that I was competent to compile a "Norway Pilot." It is incorrect to represent that I have ever laid claim to anything more than that.

I have not made a "rude" or "ungenerous" attack on the Hydrographic Department. I have temperately stated facts which cannot be disproved, in the interests of hydrography, and to show the necessity for giving increased strength and efficiency to the department. It is no answer to these facts to disparage my own efforts in the cause, or to call me a small and obscure clique actuated by personal motives. The clique to which I belong is small indeed, for it consists only of myself. It may also be obscure, but it is untrue that I am influenced, in anything I may do, by other than public motives and a desire to further the interests of commerce and of hydrography.

The gravest error into which your informant has led you is the statement that the Hydrographic Department had confided to me, "mistakenly" or otherwise, the "revision of the sailing directions" for part of Norway. I compiled those sailing directions, as expressly stated in the official printed "Advertisement," signed by the hydrographer himself, and the department has done exactly the opposite of what your informant states; it has refused to allow me to revise my own work, and has consequently published an erroneous light list, which will be followed by an incomplete "Pilot." Against this procedure it is my obvious duty to protest. I am also bound to warn all those whom it may concern of the errors to which the department has deliberately given dangerous publicity.

The paper read before the Society of Arts brought the dangers along the trade route between England and Siberia to public notice in some detail, and contained other facts relating to neglected surveys and to charts compiled from antique and inadequate data, which it was right that merchants and seamen should be aware of. If my statements are accurate—and I challenge your informant to disprove any one of them—then the Society of Arts did useful service in accepting my paper. No good end can be gained by calling me names and accusing me of personal motives. Let my statements be disproved if your informant is able to disprove them. If he cannot do so, then those statements are incontrovertible witnesses to the fact that the Hydrographic Department is unequal to the demands upon it. Unsupported assertions that the department stands "well, and deservedly so, in the estimation of scientific circles" are of no weight when opposed to facts, which your informant cannot disprove, and apparently dares not face.

GEORGE T. TEMPLE

The Nash, near Worcester, June 2

[We have given publicity to Lieut. Temple's reply to the

notice on the Hydrographic Department which appeared in *NATURE*, vol. xxii. p. 86, on the grounds advanced by him in the first paragraph of his letter.

Our readers will scarcely receive Lieut. Temple's statement that that department has deliberately given dangerous publicity to errors. This would be contrary to the traditions, and certainly to the interests, of any public office connected with the practical and working world. But however this may be, is not the Hydrographic Department pursuing a prudent course in causing a revision to be made of Lieut. Temple's compilation by another authority? In the interests of navigation we think it is; for on a great stretch of coast like Norway, which, from its sinuous and broken character, can be reckoned by thousands of miles of sea-board, it is clearly unadvisable that dependence should be entirely placed on the efforts of one individual.

We are the more confirmed in this belief from a significant letter which lately appeared in the *Shipping and Mercantile Gazette* and in the *Daily News* from the Royal Norwegian Geographical Survey Office, dated Christiania, the 16th inst., written, as the writer alleges, "in order to correct the erroneous statements contained in Mr. Temple's paper (read at the Society of Arts) respecting the charts and descriptions of the Norwegian coast now existing."—ED.]

#### Curious Electric Phenomenon

AT about 4.30 p.m. this day a severe thunderstorm with a deluge of rain came up from the north-west and lasted about an hour. At 5.30 my wife was standing at the window watching the receding storm, which still raged in the south, just over Leicester, when she observed, immediately after a double flash of lightning, what seemed like a falling star, or a fireball from a rocket, drop out of the black cloud about 25° above the horizon, and descend perpendicularly till lost behind a belt of trees. The same phenomenon was repeated at least a dozen times in about fifteen minutes, the lightning flashes following each other very rapidly and the thunder consisting of short and sharp reports. After nearly every flash a fireball descended. These balls appeared to be about one-fifth or one-sixth the diameter of the full moon, blunt and rounded at the bottom, drawn out into a tail above, and leaving a train of light behind them. Their colour was mostly whitish, but one was distinctly pink, and the course of one was sharply zig-zagged. They fell at a rate certainly not greater than that of an ordinary shooting star. I have never witnessed a phenomenon of this kind myself, but my wife is a good observer, and I can vouch for the trustworthiness of her report.

F. T. MOTT

Birstal Hill, near Leicester, June 22

#### Meteor

ON Friday, June 11, at 8.5 p.m., while the sun was still shining, I saw due east as near as I could judge, and about 30' above the horizon, a bright white meteor pass across about 10° or 12° from right to left with a slight downward course. Two or three hours later I saw a small one take a parallel course, but the other side the zenith.

W. ODELL

Coventry, June 14

#### Minerva Ornaments

DURING a recent visit to England I spent a considerable time in the Museum at South Kensington, and Dr. Schliemann's collection of antiquities was one of the objects in that museum which I was most desirous to see.

I should like to call attention to one point in regard to this collection of relics. Among others I saw a number of flat rounded pebbles, which, by chipping at the middle on both edges, have been brought into something like the shape of an hour-glass. These are marked "Minerva Ornaments." There are several other relics, the titles on which seemed to me to be, speaking within bounds, somewhat imaginative; such, for example, as the small pieces of gold plate on the *πλευρή ἀναδέσμη*, or headdress, where Dr. Schliemann sees the owl's head and two large eyes, "which cannot be mistaken"; but to name these flat pebbles "Minerva Ornaments" seems to trespass not a little beyond the due limits of the imagination when applied to science.

Stones of precisely the same shape and size, and cut in the same way, are common in this country, where Minerva was "an unknown goddess" before the arrival of the Christians. They

are picked up on the banks of the rivers, and when placed in collections are ticketed "net-sinkers." I cannot doubt that Dr. Schliemann's "Minerva Ornaments" are only Trojan net-sinkers formed as those of the aboriginal inhabitants of this country, because the savage mind seems to have run in the same channel all over the world.

E. W. CLAYPOLE

Antioch College, Ohio

#### A Snake in Kensington Gardens

I WAS considerably surprised this evening at finding the lifeless body of a snake about one hundred yards to the south-east of Kensington Palace. A policeman informed me that he had killed it there last Thursday as it was rapidly moving over the ground. The head and neck had been utterly destroyed, most likely by stampings of the policeman's foot, but the remainder of the body was perfect. In length it was about twenty inches, the body, from the thickness of a little finger, gently tapering to a tail ending in a fine point. Regular scales, brownish-black in colour, clothed the back, the scales along the sides being yellowish-green. A distinct fringe, or prolonged fin, stiffly standing erect, of about one-quarter of an inch in height, ran down the centre of the back, in colour the same as the rest of the body in that region. I trust this description may enable some of your readers learned in snakes to identify the species. Then I would ask, Is this animal a native of these parts, or had it been introduced, or had this specimen most likely escaped from captivity to meet with its untimely end?

J. HARRIS STONE

11, Sheffield Gardens, Kensington, W.

#### THREE YEARS' EXPERIMENTING IN MENSURATIONAL SPECTROSCOPY

BY A NEW HAND THEREAT

IT was in 1876 that the experimenter,<sup>1</sup> of whom the following notes have been requested, clearly perceiving that it would not do any longer, even in his private work, to be content with merely a little direct-vision, ready-made, purchased, spectroscope and the few scale points offered by reference to lamp-flame lines—set about making up a tolerably large spectroscopic instrument to satisfy his own ideas, wants, and aims.

Now the leading desire with him herein, was, in suitable return for H.M. Government having then recently changed the locality of his official residence from a low, sunk position, where and whence little but other houses could be seen, to an elevated site half-way up the northern side of the Calton Hill, commanding an excellent view of the northern, north-eastern, and north-western horizons, together with the best and brightest parts of almost all auroral displays, whenever they occurred—it was his desire, as a decorous and appropriate tribute, to render some respectable spectroscopic account (over and above anything that the Royal Observatory, Edinburgh, and its more purely astronomical instruments could do) of those sometimes nocturnally luminous, but generally fitful, evanescent, and not yet fully explained, phenomena of the skies, the *Aurora Polares*.

To this end the nascent spectroscope, mounted before a window in an upper chamber, assumed the form of a large flat telescopic box, almost five feet long, two broad, half a foot deep, supported on a stout alt-azimuth stand, with powerful screw motions. The box carried a gathering telescope in front, whose objective, as well as those of the internal collimator and inspecting telescope, were, like those of a "night-glass," large, *i.e.*, 2.2 inches in diameter; and short, *i.e.*, 17 inches, in focal length. An extensive and easily read scale for any prism's minimum deviation positions, and a long, but very easily worked, micrometer-screw motion for the telescope eye-piece were supplied, also an illuminated pointer. An electric reference spectrum of hydrogen lines above and below the fiducial central zone of the field of view was caused to be ever

<sup>1</sup> Prof. Piazzi Smyth, Astronomer-Royal for Scotland.

available; the slit, though 4 feet distant, was made capable of being adjusted from the observer's chair; a variety of prisms both simple and compound, with deviations from  $0^\circ$  to  $45^\circ$ , and dispersions from  $0.5$  to  $14^\circ$  between A and H solar, but all of large size, and capable of being used in quick succession at pleasure, were added; with further arrangements for bringing into central view and correct measure, many other natural spectroscopic milestone lines, both with blowpipe-flame and induction-spark.

Thus far the instrument had been constructed, step by step to a series of orders, chiefly by M. Salleron, of 24, Rue Pavée au Marais, Paris, and it was ready in the beginning of 1877 for any aurora that should display itself in the north-north-western parts of the sky; but no auroras came, nor have any appeared up to the present time, February, 1880. But the instrument has not been idle. Its general material, wood, allowed it to be cut into and altered for any experiment, educational or otherwise; Mr. Adam Hilger, of 192, Tottenham Court Road, furnished it with a train of compound prisms raising its dispersion powers to  $33^\circ$  A to H, with improved Huyghenian rock-crystal eye-pieces and a spectrum-illuminated pointer of a remarkable kind for the purity of the colours successively imparted; until, though large parts of the apparatus were still rough, it had become, on the whole, an essentially safe instrument for spectroscoping numerically anything within its powers to spectroscope at all, and for looking into any such subject in a variety of different ways, and to different degrees as to definition, illumination, dispersion, and magnifying; thereby imparting considerable confidence in its final results: and this is the chief reason for saying so much at starting on the mere means employed.

*Colours and Absorption Spectra.*—The first series of observations with this new instrument was of a very simple kind as to the smallness of dispersion employed, and on an often discussed subject, viz., the colours both of the spectrum and of various coloured media, solid as well as fluid. These observations were printed by the Royal Society, Edinburgh, in vol. xxviii. of their *Transactions* (1878), in a paper extending through sixty-four pages and illustrated with three plates; one of them containing twenty-five different colours, viewed under seven different gradations. Though much of the subject matter of this paper could only be a confirmation, perhaps strengthening, of many previous workings by others in the same directions; yet the following points, more or less new, were also clearly established; as—

1. Colour bands, and bounding edges of coloured regions in the spectrum, are not fixed in spectral place as both Fraunhofer lines and luminous lines of gases so eminently are, but have a positive power of locomotion, within certain limits, according to intensity of illumination and depth of colouring matter. Witness especially the march of the whole red band of light, with successively increased depths of solution, over, and past, the black Fraunhofer line, both found on this occasion in oxalate of chromium and potash dissolved in water, and proved to be as fixed as any other Fraunhofer line in all spectroscopy.

2. Amongst colours the same to the eye, a physical difference still more important than colour was ascertained to exist, accordingly as their transmitted spectra formed, either one central beam, or two widely separated beams in spectral place. So that one green glass exhibited only the green region of the spectrum; while another glass, of different chemical coloration, but equally green to the eye, shone chiefly in setting forth the ultra-red regions of the spectrum at one end, and some of the blue at the other, but extinguished strangely the yellow, citron, green, and all that might have been expected *a priori* to have been well rendered by it.

3. Amongst these double-beam colours, of which cobalt-

blue glass is an old example, well known from the times of Sir David Brewster downwards, a far more powerful case was met with in Judson's green dye of the aniline series; and by merely looking through a film of that (without any prismatic or spectroscopic assistance) it was shown to be possible to detect copper and arsenic greens among vegetable green dyes in papers and muslins; with all the facility too, of seeing the former become blue or black, while the latter became red, and sometimes gloriously so.

4. While the green of vegetation was in every case, both abroad and at home, together with its yellows, its blue as in litmus dye, and some of its browns, turned into crimson or scarlet—the green of shallow sea-water, as in the mouth of the Tagus, and the deep blue of the ocean, as in the Bay of Biscay, were both of them totally unaffected; but brown oars dipped in the act of rowing into the former, in itself unimpressible, green water, came up blood-red at every stroke; and brown seaweed floating in the blue Bay, appeared of a richer scarlet than any coral. These scenes too were all the more brilliant and life-like to the observer, though looking through something like a black ink-bottle, from the tendency ascertained of two superposed films of any of these double-beam colours, when differently illuminated (the one looked at having to be more strongly illuminated than the one looked through), to produce light, rather than double dark, in and about the F region of the spectrum; thus recalling a remarkable feature established by the late esteemed Prof. Clerk Maxwell, in his researches on colour-blindness.

*Rain-band Spectroscopy.*—The next subject on which the experimenter published (both in the *Journal* of the Meteorological Society of Scotland and in the fourteenth volume of the “Edinburgh Astronomical Observations”) was the power of the spectroscope to foretell rain. This subject had been much studied by him already in various countries and climates with pocket spectroscopes, but assumed a far firmer character when their indications could be tested by the spectroscopic machine above described.

Every spectroscopist knows how rich in black lines and grey bands is the red-end of the spectrum of the sky; especially towards sunset, and near the horizon. M. Ångström had moreover already taught that some of those lines or bands were due to watery vapour, and others to dry gas, in the earth's atmosphere; while M. Janssen had minutely identified the components of the former as being of such an origin, by comparing them with the absorption lines in a long tube of high-pressure steam. The Edinburgh experimenter therefore started with much prepared to his hand, when seeking to obtain a practical use for meteorology out of such observations; and his further steps were these:—

1. He ascertained by many months of continued daily experience that the lines attributed to watery vapour in the spectrum of the sky, though formed by that vapour when in the state of a transparent, invisible gas, increased in their intensity of darkness, other things being the same, according to the quantity of such vapour present in the atmosphere. That quantity being independently ascertained for the time by reference to wet and dry bulb thermometers and the usual hygrometrical calculations.

2. To keep those “other things the same,” and prevent the variations they are only too capable of setting up, from interfering with the one phenomenon now sought after, the experimenter confined his spectroscopic notings of the sky's light to a constant, and that a low, altitude therein; as well as to an hour giving a constant, and not a very low altitude to the sun, and an azimuthal direction considerably distant therefrom. Also to blue sky itself, as seen through openings between clouds, if possible, rather than to any cloud surface, and much rather than to

any haze, fog, or smoke surface nearer still than the clouds.

3. These precautions being taken, there was no difficulty in recognising, *first*, during frosty weather, when meteorologists know there is a minimum of moisture in the air, what should be the normal appearance of the dry-gas lines or bands, for they only are then conspicuous, and are chiefly great B, the *alpha* band between C and D, and a remarkable band on the green side of the universally known D line of the regular solar spectrum. That band being remarkable, not only for being situated as a dark shade in the otherwise brightest part of the spectrum of daylight, but by being much more dependent than the other dry bands, on the lowness of altitude of the sun at the moment, for its full and darkest development, and thence called in these inquiries "the low-sun band." *Next*, in the summer season of the year when the temperature has risen say to 70°, and we know, as *per* the acknowledged hygrometrical tables, that there is then four times as much, to the eye invisible, moisture in the air, for that reason only, as at 30° temperature—spectroscopic observation will show, simultaneously with and in addition to, all the previous dry-gas lines, not only a strong water-gas, or vapour, line closely following C, a true sun-line, but a much grander line, double line, or rather band of lines immediately preceding the solar line D; and this particular water-vapour group is in practice the only one of that kind which meteorologists need attend to in their ordinary daily work.

So far indeed we have only got, by its means, a species of thermometer; but if we go on observing day after day in nearly similar summer temperature, and accustom ourselves thereby to the then quality of appearance of that band preceding D—and if on the next day, at the same, or nearly the same, temperature, we should see the band, say twice as dark as on the previous days—then in that excess of darkness it has become "the rain band" sought for. Because that abnormal excess of darkness shows as infallibly as though it were written up in the sky, that there is at that moment far more invisible watery vapour in the upper atmosphere than the air there is capable of holding much longer in suspension, wherefore such extra moisture must very shortly be deposited as rain.

This then is the "rain-band spectroscopy" established by the Edinburgh experimenter; and it may be now successfully practised with the smallest spectroscopes either at home or abroad; when one is travelling as well as when stationary, for it occupies only a moment of time each day, as the merest glance will tell whether the rain-band preceding D is much stronger or less strong than the normal quantity; and with all the more certainty on account of the low-sun band immediately following D in the spectrum, enabling a differential, as well as an absolute, estimate of darkness to be formed. While in any but very cold and wintry weather, when Nature herself tilts the balance for rainfall by a very small addition to the watery vapour in the air, the spectral indications are easily read off and apprehended. They have also been found as certain at sea, in South Africa, and India, or wherever the system has been carried, as in Great Britain during the best part of its summer season.

If the research be further prosecuted with large dispersions, high magnifying powers, and on the direct light of the sun, the hazy bands above spoken of as existing in the general daylight, are found in the same spectral places, but breaking up into scores and hundreds of fine lines; while the range of visible spectrum then extending from the B limit of the mere sky and indirect sun's light, to great A and beyond it—the intermediate groups of lines called "little *a* and its preliminary band" will be found a still more powerful "rain-band" than that near D. For though they, little *a* and its preceding band, are

composed of lines vanishingly thin, few and far apart in dry-weather and as seen in a high sky, yet their interstices in damp weather become peopled with myriads and myriads of black lines, so as at last, indeed, in a setting sun, to block up the whole space of each group, from one side to the other, solidly; and then actually to dwarf the almost proverbial spectral colossus "great A," into a mere line comparatively puny and unimportant.

*The Red-End of the Solar Spectrum.*—"There must surely be some mystery of difficulty," thought the experimenter, "touching the red-end of the spectrum of the high sun, or the able Ångström, of Upsala, would not have omitted it in his otherwise grandly perfect normal solar spectrum map; while some points in the Royal Society's Himalayan solar spectra would have been very differently rendered." Now one undoubted obstacle to mapping that part of the spectrum well, is undoubtedly the faintness of its light; wherefore an idea immediately occurred to the new worker that the qualities of his aurora spectroscopy were the very desiderata for both the red, the ultra-red, and for everything, in fact, that the very beginning of the solar spectrum has to show beyond, or earlier than, the point where Ångström's spectrum commences its admirable delineations with the rudimentary lines of only little *a* and its preliminary band.

But the summer of 1877 threatening to be hopelessly cloudy in Scotland, the experimenter, after considering the various *pros* and *cons* of many southern stations, decided on trying Lisbon, as the place of all others giving the highest summer sun, the best climate, and most social facilities, with least time lost in getting there. And then he further happily experienced, not only that the magnificent steamers of the Pacific Steam Navigation Company of Liverpool, are the most admirable means of accomplishing the ocean transit; but that the directors of that Company are most favourably and liberally inclined to help on any really scientific matter when for the sake of science alone.

Hence it was that in June and July, in Portugal, with his Edinburgh spectroscopy and a heliostat of simple construction worked for him by his Wife's hand and eye, the experimenter was enabled to see and map at noon-day, and, day after day, in a high sky, free from ordinary telluric effects, all that portion of the solar spectrum outside, or situated preliminarily to, Ångström's shortened beginning; viz., the matchless series of lines that go towards forming the colossal groupings of both great A and its grand preliminary band; then beyond that the very strong line Y and the groups of finer lines on each side of it; and beyond that again, near the beginning of all visible spectral light, the strong line X, and certain thinner lines on either side of it.

Photography, as Capt. W. de W. Abney has admirably shown since then, can take account of many more lines still; and some of them so very far away beyond all visible red light, as to remind one of those other lines recorded by Dr. Draper, the elder, in his celebrated Daguerreotype spectrum taken in 1843, lines which are quite outside the pale of all optical spectra. But the human eye had probably never, up to 1877, seen more in the "red" than what the Edinburgh experimenter's roughly built-up aurora spectroscopy showed on this occasion: and the whole result, as contributing at last the head-piece required for Ångström's normal solar spectrum, was described in the 14th volume of the "Edinburgh Astronomical Observations," published towards the end of the same year 1877. It was accompanied there by a map, extending from the beginning of all visible light, and including 62 lines up to the groups of little *a*, so correctly represented in themselves by the philosopher of Upsala.

(To be continued.)

EXPERIMENTAL RESEARCHES IN  
ELECTRICITY

TO PART III.—*The Electric Condition of  
Terminals of a Vacuum-Tube after their connection  
Source of Electricity has been broken*

question has been mooted whether there is a polarisation of the terminals of a vacuum-tube after the discharge through it has been interrupted by breaking connection between it and the source of electricity. This question is to be understood in the sense—does there exist a chemical polarisation as is the case for instance with the terminals of a voltameter under similar circumstances?

The problem is by no means easy of solution. The authors believe, however, that the few experiments they describe, selected from a long series, will show that there is really no such polarisation of the terminals.

In the first instance the case of the voltameter is considered; the arrangement of the apparatus employed in the experiments is shown in Fig. 1, where *k k'* represent

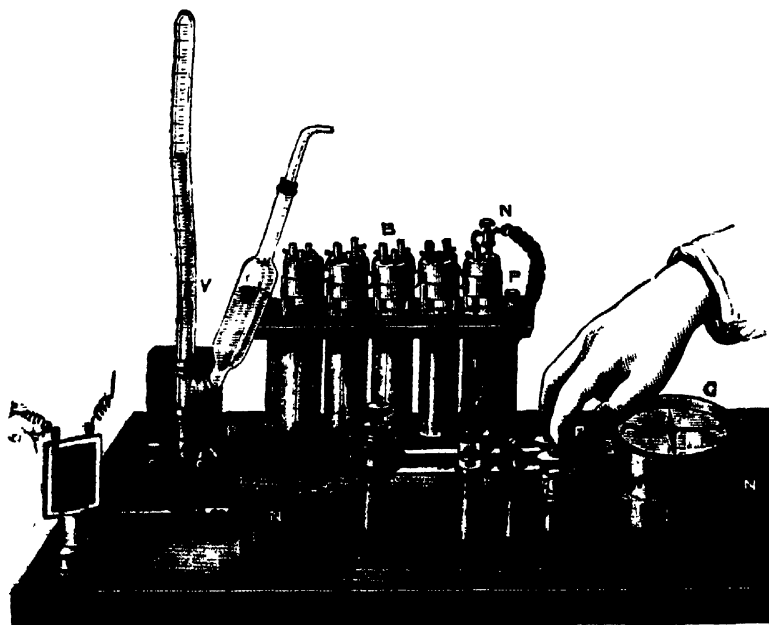

a special key for breaking connection between any piece of apparatus and the battery, *B*, and connecting it afterwards instantaneously with a galvanometer, *G*. The terminals of the battery are attached respectively to the screw-clamps, *c* and *d*, carried by an ebonite bar, supported on two ebonite columns, touch-points in metallic contact with *c* and *d*, pass through this bar, so that when the brass springs, *a c* and *b f*, are allowed to rise and press against these touch-points, the battery is in metallic connection with the screw-clamps, *a* and *b*, and any piece of apparatus attached to them, as, for example, the voltameter, *V*. The voltameter employed has a resistance of 20 ohms; its platinum electrodes are 2.5 inches long and 0.025 inch in diameter, and are separated 0.25 inch; it is charged with dilute pure sulphuric acid in the proportion of 1 volume of acid, sp. gr. 1.84, to 8 volumes of water. When the springs are suddenly pressed down by the fingers placed on the ebonite disks, *e* and *f*, the connection is broken between the voltameter and the battery, and it is

connected instantaneously with the galvanometer *G*. The

galvanometer actually employed was not that shown in the figure, but a Thomson galvanometer, whose constant,  $C = \frac{1 \text{ volt}}{1 \text{ megohm}} = 1,874$  scale divisions. On connecting

a battery of 10 chloride of silver cells with the voltameter for a minute or less, and then suddenly pressing down the springs *e* and *f*, there was a deflection to the left, say, of more than 1000 scale divisions, although the  $\frac{1}{10}$  shunt was used to reduce the current through the galvanometer; therefore, the deflection without the shunt would have been more than 1,000,000 divisions. By comparing this deflection with that produced by a half microfarad condenser, charged with 240 cells, it was ascertained that the deviation produced by the voltameter was equivalent to that of 111 microfarads.

The small condenser shown at *C*, Fig. 1, was substituted for the voltameter; it is made of a thin plate of glass 2 inches square and 0.0115 inch thick; the tinfoil coatings being 1.5 inch square, its capacity was found to be 0.00055 m.f. When charged with 3,600 cells, and afterwards connected with the Thomson galvanometer through the  $\frac{1}{10}$  shunt, by pressing down *e* and *f*, the deflection was 136.5 divisions to the left; this multiplied by 0.92, the value of the shunt was equivalent to 1,354 divisions.

The apparatus, shown in Fig. 2, which was constructed for another object already described,<sup>1</sup> was connected with *a* and *b*; it consists essentially of two disks, 3.1 inches diameter, placed 0.13 inch apart. The capacity of this apparatus, when used as an air-condenser, was determined, and found to be 0.000058 m.f. With 3,600 cells no discharge took place, and it merely charged up as a condenser. The deflection produced, when the keys *e* and *f* were pressed down, was (without shunt) 150 divisions, still to the left. It is evident, therefore, that the direction of the deviation throws no light on the question, for it is the same with the voltameter as with the condenser.

Tube 73, containing a residuum of acetylene, was now substituted for the air-condenser; it is 26.5 inches long and 1.5 inch diameter, the distance between the terminals 23 inches; this tube was connected with 3,600 cells, current 0.00681 *W*. The tube potential was found to be 2,980 cells, and its resistance 449,500 ohms. On pressing down the springs *e* and *f*, so as to break connection with the battery and connect the tube with the galvanometer, there was a deflection of 11 divisions to the left, the same as before. The current was only

$$\frac{11}{1874 \times 1,000,000} = \frac{1}{170,000,000} W.$$

The diagram, Fig. 3, will illustrate the action of the special key, Fig. 1. When the handle is moved to the left, the tube *T T'* is placed in metallic connection with the battery, whose terminals are shown attached to *c* and *d* (this is equivalent to the springs being allowed to press upwards against *c* and *d*, Fig. 1); when the handle is moved to the right, then the discharge of the battery through *T T'* ceases, and the terminals of the tubes *N* and *P* are connected with the galvanometer, the extremities of whose coil are attached to *e* and *f* (this is equivalent to pressing down the springs in Fig. 1).

On another occasion with the same tube, No. 73, with



a discharge from 2,400 cells, the deviation to the left on passing down *e* and *f* was 20 divisions.

Tube 199, with a hydrogen charge, was now substituted; pressure 2 millims., 2,632 M., 5,100 cells, current 0.01639 W. This tube has already been described (NATURE, vol. xxii. p. 176); it is 37 inches (94 centims.) long, and 5 1/8 inches (14.8 centims.) in diameter. The distance between the terminals, a ring and a straight wire, is 33.5 inches (85 centims.). In the first place the battery was connected direct to the galvanometer, the positive to *e* and the negative to *f* (that is, in the same direction as if the positive were attached to *c* and the negative to *d*). A short piece of wire was inserted between *e* and *f* as a shunt, and the shunt was also used with the galvanometer, the direction of deviation was found to be to left, which it was desired to know.

On pressing down *e* and *f*, the deviation was to the left, and only amounted to 2 divisions. On another occasion, at the same pressure, 3,900 cells, current 0.02925 W., the deviation to the left on pressing down *e* and *f* was from 3 to 5 divisions.

The same tube, with a charge of coal-gas, pressure 3 millims., 3,947 M., current 0.01705 W., deflection, on pressing down *e* and *f*, 7 divisions to left.

The same tube, with air, pressure 1.5 millims., 1,974 M., current 0.02728 W., on pressing down *e* and *f*, deviation 20 divisions. The deviation was, therefore, greatest with air; but if due to a chemical polarisation, it would have been *a priori* expected to be greatest with coal-gas, which is a mixture of decomposable molecules. The result of the experiments with tube 199 gave the following deviations:—

Hydrogen.	Coal-gas.	Air.
3 ... ..	7 ... ..	20

Again, tube 199, 2,400 cells, pressure 1 millim., 1,316 M., current 0.02456 W., deflection on pressing down the keys, 16 to left; with 1,500 cells no discharge, yet a deflection of 10 divisions to the left was produced on pressing down the keys. The deflection in the latter case being clearly due to a static charge.

Experiments were now made in air with an apparatus similar to that already described in NATURE, vol. xxii. p. 174, but with disks instead of points, in order

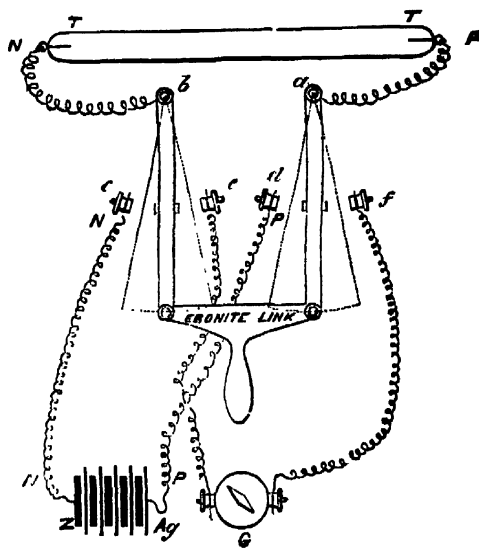
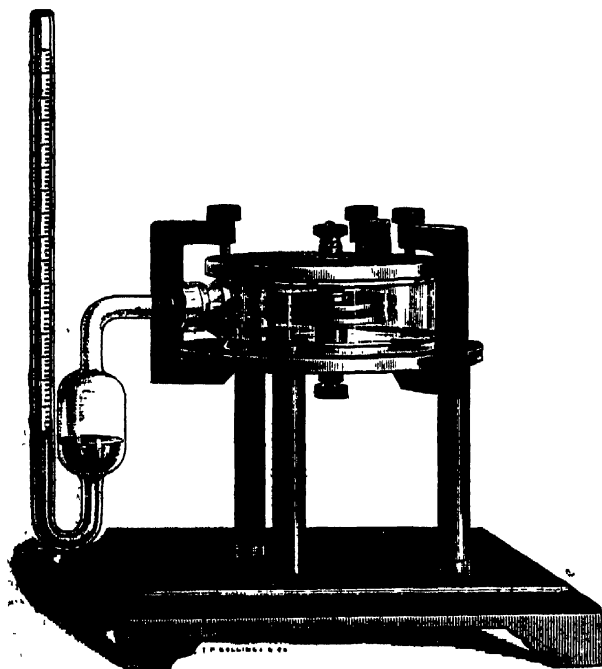

FIG. 3.

to obtain a vacuum vessel with large terminals. The terminals are two disks a little over 4 1/4 inches (11 centims.) in diameter, and in the first instance were placed 3 inches (7.62 centims.) apart. Pressure 4.5 millims., 5,921 M., 2,400 cells, current 0.04366 W., deviation on connecting the disks with the galvanometer, 10 divisions to left.

With 1,200 cells, no discharge took place, but on connecting the galvanometer a deviation of 27 divisions to the left was, nevertheless, produced.

At a pressure of 20 millims., 26,316 M., with 3,900 cells, no current passed, but the deviation on connecting the galvanometer, was 66.6 divisions to the left.

The disks were now placed at a distance of 2 inches (5.08 centims.), the pressure being still 20 millims., and the battery 3,900 cells, the discharge now took place, current 0.03896 W., deflection on connecting galvanometer 8.5 to left.

On reducing the battery to 2,400 cells, the discharge did not take place, but a deviation of 43 divisions was produced on pressing down *e*

The disks were placed at 1 inch (2.54 centims.) apart, same pressure, with 3,900 cells, the current was 0.04201 W., deviation to left on connecting the galvanometer 13 divisions.

2,400 cells would not pass, but a deviation to the left of 47 divisions was obtained on connecting the galvanometer.

The following are the results of these experiments with the disks at various distances:—

Distance, inches.	No. of cells.	Pressure, mm.	Deflection on
	1,200	4.5	did not pass
	2,400	4.5	passed
	3,900	20.0	did not
	3,900	20.0	passed
	2,400	20.0	did not pass
	3,900	20.0	passed
	3,900	20.0	did not pass

So that in every case when the current had not passed

the deflection was the greatest on connecting the terminals with the galvanometer.

If the fact already pointed out be taken into account, that with a constant battery-potential, the difference of potential between the terminals of a vacuum-tube varies, in the same gas, according to the degree of exhaustion, it follows that as soon as a discharge takes place, the potential of the terminals will be lowered. One would therefore expect to find what the before-cited experiments indicated, namely, that the static charge of the terminals would be greater when no discharge takes place than after it has occurred, notwithstanding that a larger number of cells may have been employed in the latter case than in the former, for the authors have shown (*Phil. Trans.*, vol. clxxi. p. 67) that a tube-potential may be only 430 cells, although the battery connected with its terminals is 11,000 cells.

The authors believe, therefore, that the experiments point conclusively to the deduction that the current obtained from the terminals of a vacuum tube, after having been disconnected from the battery, is solely due to a static charge and not to a chemical polarisation.

An experiment was made with the apparatus arranged as in Fig. 4, a tangent galvanometer being inserted in the

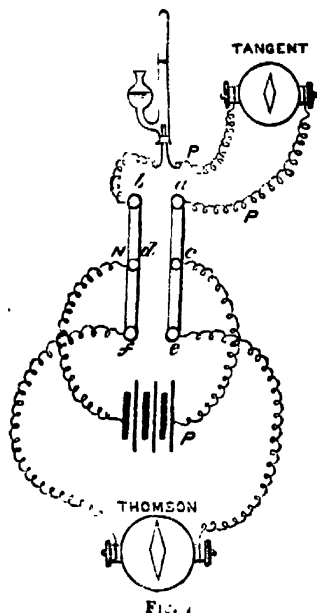

FIG. 4.

circuit between the battery and the voltameter, the shunt being used with the Thomson galvanometer.

No. of cells.	Current indicated by the tangent galvanometer. W.	Deflection of Thomson galvanometer, with shunt $\frac{1}{10}$ , on pressing down $e$ and $f$ .	Divisions.
1 ...	0'00000 ...	$220 \times 995^3 1$ ...	218,930.
2 ...	0'00415 ...	765 ...	761,380
3 ...	0'03463 ...	984 ...	978,820
10 ...	0'14660 ...	990 ...	985,150

On keeping down the keys  $e$  and  $f$  after the voltameter had been connected with three cells, the deflection, which at first was 984 divisions, fell in—

1 minute to	110
2 minutes to	80
3	68
4	60
5	55
6	52
7	49

so that it was evident that a current was kept up by the voltameter for a considerable time after the battery had been disconnected.

In order to render evident the direction of the current of polarisation of the voltameter the apparatus was arranged as in Fig. 5, that is, the Thomson galvanometer, with  $\frac{1}{10}$  shunt, was inserted in the circuit between the battery and the voltameter. An adjustable shunt was fixed between  $a$  and  $b$  to permit the greater part of the current to pass through it. A plate of metal,  $ss$ , was provided to slip under  $e$  and  $f$  to short circuit the return current through the galvanometer. The shunt which was found just sufficient to carry the major part of the current, and yet permit sufficient to traverse the voltameter to produce a just visible evolution of gas, was 13 ohms.

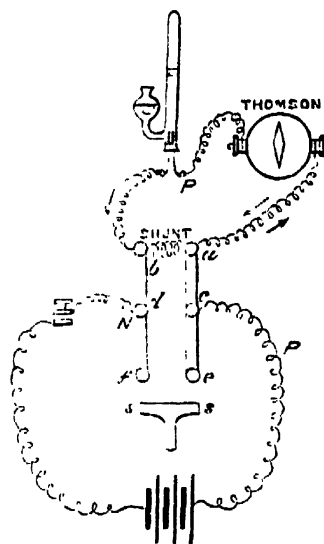

FIG. 5.

On connecting the battery, the current was in the direction of the lower arrow, and the deviation 133 divisions say to the left; on pressing down the keys on to the metal slip placed under them to short circuit the current, after the battery had been disconnected, the return current was in the reverse direction, as shown by the upper dotted arrow, the deviation being 425 divisions to the right. Even without pressing down the keys on to the metal slip nearly the same deviation was obtained on disconnecting battery for the return current then traversed the shunt from  $a$  to  $b$ .

On substituting either the bell-jar, with disk terminals, or the tube 199 for the voltameter, the deflection of the return static charge was in the same direction as the return current from the voltameter, so that, as was before stated, no inference can be drawn from the direction of the current as to its being produced by polarisation or a static charge. The authors conclude by saying:—We think, however, that we have shown that the effect in the case of a vacuum-tube is due to a static charge, and not to a polarisation of the terminals. We rest our opinion mainly on the fact that a greater deflection is produced, when the potential has not been lessened by a discharge through the tube, than that which occurs after the discharge has taken place, which, it had been surmised, might possibly produce a chemical polarisation.

#### THE LATE M. GAUGAIN

SCIENCE has to deplore the loss of an industrious but unobtrusive worker in the person of Jean-Moïse Gaugain, who died at the village of St. Martin d'Estreaux,

near Bayeux, on the 31st of May, 1880. His name is honourably associated with experimental researches in a good many of the less-frequented bye-paths of electrical science. Living in a time which may well be regarded as the transition period, during which electricity has passed from the stage of a phenomenal and experimental science to one of exact mathematical relations, some of Gaugain's investigations are already superseded by the later and more comprehensive researches of a younger generation. Yet he has done good work, which will live to carry down his name along with that of Peltier, of Pouillet, and of Becquerel, and with the still greater names of Arago and of Ampère.

His earliest contribution to science of which we are aware was a memoir published in 1853, under the title "Note sur les Signes Electriques attribuées au Mouvement de la Chaleur," and in the same year he brought out his tangent galvanometer. The essential point of this instrument consisted in employing as a coil several turns of wire of increasing diameter arranged about a conical surface, at whose imaginary apex was placed the small magnetic needle, each of the coils thus subtending the same solid angle at this point. This arrangement, to which Gaugain was experimentally led, was in some points virtually anticipated by the tangent galvanometer of Helmholtz, in which, however, a symmetrical arrangement was employed. In the same year Gaugain announced the discovery that continuous currents of electricity could be produced by the continuous friction of two dissimilar metals upon one another. The next two years saw him employed in investigating the electricity produced by evaporation and by combustion. In 1856 he produced his double-condenser electroscope, designed, like the condensing-electroscope of Volta, for the investigation of the electrification due to contact of dissimilar substances. At the same time he published some observations on the behaviour of amalgams of sundry metals, and showed that in a voltaic pair the amalgam of zinc was more electro-positive than zinc itself, while the amalgam of cadmium was on the other hand, more electro-negative than the pure metal. From 1856 to 1859 Gaugain was occupied with important inquiries on pyroelectricity, and he succeeded in establishing sundry laws, with respect to the electricity of the tourmaline in particular, which had escaped previous observers. The results he arrived at were published in the *Annales de Chimie et de Physique*, and comprised a number of curious and unexpected results. The tourmaline, which at ordinary temperatures is a bad conductor, even for high-tension electricity, begins to conduct at 400° or 500° C., and on cooling is still found to conduct; but if washed in water and dried carefully it once more insulates. All tourmalines are not equally active, those of Brazil, green or blue in colour, being the most electrical. In order to obtain a measure of the amount of electricity furnished by a tourmaline whose poles were united by a metallic circuit, he devised a discharging gold-leaf electroscope, and by means of this instrument showed that a number of tourmalines united by their similar poles gave quantities of electricity proportional to their number, while if united in single series they gave no more than a single long one, thus behaving like batteries of great electromotive force and of almost infinite internal resistance. The quantities of electricity furnished by tourmalines of equal lengths but of different thickness while passing through equal ranges of temperature he found to be proportional to the cross-sections of the crystals, again agreeing with the law of Ohm as applied to batteries of very high internal resistance. Gaugain also showed the quantity of electricity thus flowing through the tourmaline in one direction during a rise of temperature to be equal to that flowing in the reverse direction during a corresponding fall. The year following the discharging electroscope was usefully employed in verifying Ohm's law as applied to other bad conductors. Volta's contact

theory occupied Gaugain at several periods of his career, and he established amongst other interesting results that there is a difference of potential between a piece of platinum which has been dipped into acid, and one which has been dipped into alkali, even though both have been subsequently washed. Gaugain also conducted a number of careful researches on specific inductive capacity, on the capacity of cables, on the residual charge of condensers, and on what he termed the variable electric state of a condenser communicating with the soil by a bad conductor, in which, when discharged by disruptive sparks or by the discharging electroscope, the time-intervals of the discharges were found to form a geometric progression. His extended observations on condensers of spherical, cylindrical, and flat forms were communicated to the Académie des Sciences in three special notes. In later years Gaugain devoted himself to the examination of the effects of heat upon the magnetism of steel tubes and bars, and found the remarkable result that a bar magnetised powerfully while hot may when cooled exhibit a reversed polarity, and *vice versa*; also that the magnetisation by a strong current penetrates deeper than that due to a weaker current. He also brought to light sundry analogies between the behaviour of magnets under magnetic force, and of matter generally under mechanical forces.

Born in Normandy in 1810, he entered the École Polytechnique at about the age of eighteen, and afterwards attended the École d'Artillerie at Metz, after which he adopted metallurgy as his profession. Gaugain worked during the closing years of his life in isolation and in straitened circumstances, assisted by his only daughter, who devoted herself to him. His researches, though several times rewarded with academic recognition, were not in themselves productive of gain; and the *prix Gegner*, an annual grant of 4,000 francs, given *à un savant pauvre afin de l'aider dans ses recherches*, awarded to him for five years past, was a welcome amelioration of his position in a time of failing health and during the painful illness to which he succumbed at the age of seventy years. S. P. T.

#### A CHAPTER IN THE HISTORY OF THE CONIFERÆ

IN working out the Eocene coniferæ, in continuance of the monograph which the Palæontographical Society are kindly publishing and illustrating in a sumptuous manner, some reflections upon the past history of the more prominent Eocene genera, such as *Araucaria*, *Podocarpus*, *Dammara*, *Sequoia*, &c., have occurred to me, which, although being perhaps outside the scope of the Palæontographical Society's work, may not be uninteresting to the general readers of NATURE. I have therefore tentatively brought forward the present chapter on *Araucarias* without yet having any definite intention of putting together my notes upon the other genera, in the present form.

*Araucaria*,<sup>1</sup> Jussieu.—The earliest traces of distinctly coniferous wood known, those from the Carboniferous, were for many years thought to belong exclusively to the Araucarian type. This supposed prototype became, according to Schimper, modified in successive ages, and he endeavours to trace these modifications through the extinct genera *Walchia*, *Ullmannia*, *Araucarites*, *Voltzia*, *Ptycholepis*, *Pachyphyllum*, and *Cunninghamites*. Lesquereux, however, carries the actual genus *Araucaria* to as far back as the Trias, and unmistakable cones of both sections of the genus have been described by Carruthers from the Stonesfield, Yorkshire, and Somersetshire oolites; fossil forms agreeing closely with these have been also found in the Jurassic of India. It is not

<sup>1</sup> From Araucanos, a people of Chili, in which country *A. imbricata* abounds, and furnishes the principal food of the Indians.

definitely known at present in cretaceous rocks, for the large fossil cone figured by Heer as *Araucarites nordenskiöldii*, from the upper cretaceous of Spitzbergen, is a very indistinct coaly mass, and as he suggests, possibly cycadaceous.<sup>1</sup>

The Araucarias thus appeared to have declined since Jurassic times, and Schimper states that, with the Tertiaries, they became extinct in Europe. Thiselton Dyer<sup>2</sup> goes further, and has even stated that, so far as we know, they have been extinct north of the equator since the Oolitic age. It is certain, however, as I hope to show, that at least one section of them abounded in Europe during the Eocene age, and probably did not quit it until the Miocene.

The existing Araucarias present a singular appearance when contrasted with other trees, and would be looked upon from their aspect alone as unmistakably archaic in character. They have been divided by Salisbury<sup>3</sup> into two very distinct sections: Columbea, or true Araucarias, and Eutacta, or the needle-leaved false Araucarias. They are exclusively confined to the southern hemisphere, Columbea alone being represented in South America, and both sections in Australia and the adjacent isles.

The section *Columbea* possesses but four species, which are, however, very distinct from each other and of great interest. The most familiar is the common *Araucaria imbricata*, or Monkey-puzzle. It is almost confined to Chili, forming vast forests which extend upon the slopes of the Andes from the snow-level to about 1,500 or 2,000 feet downwards. The trees reach 150 feet in height, and with their dark pendulous foliage are of imposing grandeur. Their appearance when full grown can scarcely be realised from the young trees in England, but an exceptionally fine specimen is at Windsor, and a carriage-drive leading to a nobleman's house, near Armagh if I remember rightly, is bordered by high banks of large and, for our country, well-grown trees of this species, and presents a strikingly dignified effect. The cones are very large, and the seeds, which are highly nutritious, form the staple food of the Indians. The second South American species, *A. brasiliensis*, is somewhat similar in appearance, and reaches 100 feet in height. It also forms immense forests, and produces edible nuts, but as it will not live in our climate without protection, is less frequently seen in cultivation.

The Australian species are even more strange in aspect. *Araucaria Bidwillii* forms a majestic tree, growing to 150 feet in height, and confined to a tract 30 miles long by 12 on the east coast near Brisbane, where it far overtops the other forest trees. *A. Rulci*, a smaller though equally beautiful tree, is chiefly remarkable for its singularly restricted range, being only indigenous to Porte Molle, one of the Caledonian Isles, where it is confined to the summit of an extinct volcano, but half a mile in radius, and exposed to extremes of heat and cold that appear destructive to other kinds of vegetation, for hundreds of feet below it.

The Columbeas have not been met with fossil either in the Eocene or Cretaceous rocks, probably because their stations are mostly high rocky ridges, where there is an absence of water, rendering it unlikely that their remains would find their way into marine or fluviatile sedimentary strata. We must by no means infer, therefore, that species belonging to this section did not exist in Europe contemporaneously with the species of Eutacta that have been found.

The section *Eutacta* has terminal globular cones with broadly-winged and generally persistent scales and falcate

<sup>1</sup> Flora foss. Arctica, vol. iii. Pl. xxxvii. p. 126. Heer says the figure is much too distinct, and that the position and arrangement of the scales can only be made out with the greatest trouble. Restored as it is, it possesses no distinctly Araucarian characters, while no branches of Araucaria have been found that could be placed with it. Cycadaceous and Sequoia foliage moreover abounds in most cretaceous rocks in high latitudes.

<sup>2</sup> Royal Geog. Soc. Proceedings, 1878, vol. xvii. p. 427.

<sup>3</sup> Trans. Linn. Soc., vol. viii., 1807, pp. 308-317.

needle-like leaves. There are but three existing species, all of gigantic dimensions, for two of them attain a height of over 200 feet, and the third 150 feet. *Araucaria Cookii*, or the Norfolk Island pine, a native of New Caledonia and New Hebrides, presents a fantastic columnar-like growth, giving the trees when seen from a distance somewhat the appearance of a grove of ship's spars 200 feet or so in height. *A. excelsa*, indigenous to Australia and Norfolk Island, is an even more majestic and colossal tree, towering to a height of 230 feet, with a trunk of some 30 feet in girth. The third species, *A. Cunninghamsi*, I wish to describe in more detail, for I have ascertained, conclusively I believe, that it, or a species indistinguishable from it, flourished abundantly in our latitude and longitude in the Middle Eocene period.

*A. Cunninghamsi*, like many Coniferæ of the southern hemisphere, has two slightly distinct forms of leaf, those of the young plants being straighter, more sabre-like, and horizontally disposed than those of the more fully developed tree, which hitherto have alone been met with fossil.

The foliage of the more full-grown tree is composed of moderately short falcate needle-like leaves, quadrangular in section, thickening at the base, and with the lower side produced and decurrent on the stem. These are disposed all round the branches, and leave the stem at first at right angles to it, and then gently curve upward and inward. This arrangement causes each leaflet to be free or seldom in contact one with another, and is an important character in distinguishing the species by its foliage when other organs are absent. The terminal branchlets are generally simple for 5 or 6 inches, and then branch shortly but copiously, and chiefly horizontally. These branchlets apparently represent one year's growth, for they are articulated at the base, and are annually shed in abundance by the trees. Branchlets resembling these in the minutest particulars are to be found in great quantities in the Eocene beds at Bournemouth.

Other coniferous foliage, however, resembles *A. Cunninghamsi*, especially that of some of the cultivated *Sequoia gigantea*, so much so that I had difficulty in removing the prejudice from Ettingshausen's mind, shared by all the Teutonic palæobotanists, in favour of referring all this type of foliage to *Sequoia*. Before it can definitely be said to belong to *A. Cunninghamsi* these types of foliage must of course be considered.

In the first place the foliage of *A. Cunninghamsi* is easily distinguishable from that of the other Araucarias in the section; *A. excelsa* having leaves more at right angles, more laterally disposed, and foliage less branching, and *A. Cookii* possessing the leaves broader and in contact with an imbricated appearance, while every articulated branch is simple. The other Coniferæ which resemble it are *Creptomeria japonica*, in which the leaves are much longer and straighter, and quit the stem at an angle of about 35°; *Arthrotaxis selaginoides* and *Dacrydium araucarioides*, which have the imbricated appearance of *A. Cookii*; and *Sequoia gigantea*, which is much the nearest in general habit. The leaves of *Sequoia* differ in being rather longer in proportion, less regularly disposed and curved, leaving the stem at a very acute angle, and hugging it more closely, so that their points irregularly overlap and touch each other. Its foliage in the wild state seems always to be very much smaller, and the larger foliage it seems sometimes to assume away from its native habitat, shows very distinctly the seasonal variations in the size of the leaves so characteristic in the other existing *Sequoia*, *S. sempervirens*. The Bournemouth foliage differs from all these materially, but as already stated, resembles that of *Araucaria Cunninghamsi* in so close a degree as to be indistinguishable from it by any discoverable character.

Apart from the foliage, however, there is other evidence in support of the view that this is really *Araucaria*

*Cunninghami*. Although the branchlets are most abundant in some of the beds, both marine and freshwater, no trace whatever of the cones could be found. I was at first surprised at this, for it is generally more common in beds of marine origin, as at Bracklesham, Barton, Sheppey, &c., to meet with cones than with foliage, and no instance of the presence of coniferous foliage only, in a sea-deposit of any age had previously come under my notice. I was so puzzled that I spent several days in digging and tracing out these branchlets and vainly trying to find the attached fruits—the cause of whose absence should have been clear. The cones, 3 inches long and nearly 9 inches in diameter, are so exceedingly dense and heavy that they have no power of flotation, and their presence in beds of fine drifted sediment could therefore only be due to some rare accident. On the other hand, the small light cones of *Sequoia* would, like those of *Pinus*, everywhere drift by flotation, and necessarily not infrequently become imbedded with the foliage. Although I found no cones, the female terminal buds present the peculiar constriction and then swelling, so characteristic of *Araucaria*.

The distribution of *Araucaria Cunninghami* at Bournemouth is very clearly defined, and tells as plainly as possible that its habits when existing in our latitudes did not differ from those it now possesses. No trace of it is met with west of the pier in the beds whose floras may be thought, from their characters, to have come from districts away from the sea—but east of the pier it abounds everywhere, in company with fan-palms, eucalyptus, aroids, ferns, &c., and in certain beds of mud and muddy sand of the marine series, the branchlets, in marvellous preservation, are seen to cross each other in every direction.

The existing *Araucaria Cunninghami* forms vast forests on the shores of Moreton Bay, on the alluvial banks of the Brisbane River, and grows in the greatest profusion in the brush forests of the Richmond River. "The trees seem to thrive best near the coast, attaining in such a situation their greatest height, often from 100 to 130 feet,<sup>1</sup> but gradually diminishing in height the farther the trees are inland. It would appear from this that the sea air has a great effect upon it."

The "brush" forests, in which *A. Cunninghami* very generally occurs, although it is not exclusively confined to them, are thus described by Moore:—

"The 'brush' is characterised by denseness of growth, the altitude and beautiful dark green foliage of the trees, the presence of lofty climbing plants, which extend their slender pliant branches considerable distances, and by this means often embracing, as it were, into one common bond, many of the loftiest and largest trees. . . . Another characteristic of forests of this description is a thick undergrowth of numerous kinds of ferns and other plants. Palms and tree-ferns also usually abound, the former reaching a height, in some instances, of at least 130 feet. . . . On the stems and branches of the trees numerous kinds of epiphytal ferns and orchids grow, which, with the other plants referred to, contribute materially to give such forests a very tropical appearance."<sup>2</sup>

It is clear, from the debris of trailing Smilacæ and Aroids, and from the remains of large fan-palms and ferns, that our Eocene "brush"-growth must have been very similar to this in appearance. The physical aspects of the former stations of *Araucaria* on the alluvial banks of the great Bournemouth River in close proximity to the sea, as we have ascertained, and its probable extension along the shores of what must have been the east coast of the submerged continent seem to approximate to those it now occupies on the Brisbane River and the shores of Moreton Bay on the east coast of Australia. Nothing

can be more impressive indeed than the remarkable agreement in habit, as far as we can trace, between the *Araucaria* and associated plants that have passed away and those that survive. The long-imbedded plants of our Eocene coasts seem to have risen up and to live again in this far-off country, and by what we see there we are able to picture the long sandy coasts, beaten by an ocean surf and fringed with dark-foliaged and gigantic *Araucarias*, gum-trees, luxuriant palms and ferns, whose remains have helped to form the present pine and heather-clad cliffs of Bournemouth. If we contrast this with the comparative absence of any associated vegetation in the Mammoth Grove, we see how opposed the intended reference of these branches to *Sequoia* would have been to any known natural grouping.

Elsewhere in Great Britain we have little trace of anything referable to *Araucaria* younger than in the Jurassics, except certain foliage at Sheppey and the foliage from the basalt of Antrim, referred by Bailey to *Sequoia* as *S. du Noyeri*, about which however I am not yet able to express an opinion. In France, from many Eocene localities, undoubted *Araucaria* branches have been obtained, though none of them seem to be specifically identical with ours, and some appear more of the *A. excelsa* type.

In Central Europe, from Sotzka, Häring, Monte Promina, Bilin, &c., in Tertiary beds whose exact age is not yet satisfactorily determined, a somewhat similar foliage abounds. This was originally described as *Araucarites*, and indeed at Häring a young cone with every characteristic of *Araucaria* was found in the same bed with it.<sup>3</sup> All of them were subsequently transferred to *Sequoia*, which many certainly more nearly resemble in the direction and arrangement of the leaves; yet the absence of any *Sequoia* cones which can, so far as I know, be directly connected with them, and the presence of a characteristic *Araucaria* cone should, at all events, induce caution in believing the whole of this type of foliage met with in Central Europe during the Middle or Upper Eocene to belong to an ally of *Sequoia gigantea*. It is quite open to doubt whether, as Heer's determination of two fragments would imply, this species known as *S. sternbergeri*, whatever its real character may be, persisted as late as the Miocene of Oeningen. On the other hand, the presence of fossil *Sequoia* of the Wellingtonia type within the Arctic circle is undoubted, though Heer appears to have made more species than were necessary.

The presence of an *Araucaria*, indistinguishable from *A. Cunninghami*, in our latitudes at a time not more remote than the Middle Eocene, is of interest, for although many of our Eocene plants have been referred to Australian genera, there has always been doubt sufficient to render any confirmation of the supposed land connection with Australia of importance. While the association with it at Bournemouth, of Podocarps and *Dammara*, *Eucalyptus*, and many Protaceæ, which are strictly forms of the southern hemisphere, is but natural, the presence of a needle-leaved conifer of the genus *Pinus*, even rare as it is, is singular. Such a union nowhere takes place at the present day, although in Mexico pines mingle with feather palms.

The presence in N. lat. 50° of a flora, now distinctive of the sub-tropics of the southern hemisphere, and of a north temperate flora in N. lat. 70°, during the Eocene period, can hardly fail to provoke wonder as to where the equator of heat was then situated. It is impossible to suppose that the equator of heat separated them as it does now, however far north it might be driven by shutting off the Arctic currents and leaving those of the Antarctic to circulate. Yet if the southern hemisphere flora were formerly to the north of the equatorial zone of heat, the question must arise as to how *Araucaria Cunninghami*,

<sup>1</sup> 130 feet. "Industrial Progress of New South Wales; Official Report of the Sydney Exhibition, 1870," Part II. p. 443. It is astonishing how very generally the dimensions of the Conifers of Australia and America are similar.

<sup>2</sup> Loc. cit., p. 453.

<sup>3</sup> "Foss. Coniferen," Göppert, Haarlem *Typosuchus*, tab. pl. 44. P. 237.

and other forms that are not tropical, could have reached their present habitat. The range of this *Araucaria*, although greater by far than that of the other *Eutactas*, is very definitely limited to a strip of coast in New South Wales between the Bellingen, a small stream about S. lat.  $31^{\circ} 40'$ , and Cape York in Queensland, in nearly  $10^{\circ}$  S. lat. It does not approach, therefore, to within nearly a thousand miles of the equator of heat, which is several degrees north of the true equator. They must either have crossed the equator from the south in præocene times and subsequently become isolated and died out in their northern habitat, or have been originally indigenous to the north and retreated to their present stations. A passage must have been made in either case, for the present distribution of *Coniferæ* is against the supposition that any *identical species* could have extended synchronously in lowlands in both hemispheres, widely separated by the equator. If a general lowering of temperature had favoured their passage, the pre-existing tropical vegetation must have altogether died out, and the existing equatorial vegetation would present a comparatively new aspect. The absence of any of the *Coniferæ* that have ever been met with fossil in the plains of the tropical regions at the present day, and of any existing strictly equatorial plants, such as *Gnetum* among *Conifers*, in the fossil floras, seems at first sight to show that it does so and therefore lends some colour to what is at best merely a very crude hypothesis. A simpler supposition than that of a general lowering of temperature in the Tropics, until more facts are forthcoming, is that the passage was effected across high land, some of which may still remain in Sumatra and Java.

The specific identity which is apparent, of this and other Australian forms, with those of our Eocenes, proves that some, at all events, of the at present purely Australian genera, neither originated nor became differentiated, as Bentham supposed, in Australia. The endemic genera, he says, never spread far out of it, the only exceptions appearing in the Malay Archipelago, "especially Timor, New Guinea, and Borneo, and a few as far as Southern China."<sup>1</sup> Nothing could speak more eloquently of the path the migrations have taken, than these remnants left upon the road, nor go farther to prove the former connection with our antipodes, which the discovery in 1814 by Brown of 150 European plants, a number since greatly increased, growing endemically in Australia, first of all I believe suggested to us.

It may not be altogether a useless supposition to hazard, that if, as Saporta supposes, plants originated mainly if not wholly in northern regions, and migrated south, the continents of the southern hemisphere may be actually preserving, as in the present case, our Eocene flora, and have been inhabited in Eocene times by the Jurassic flora which preceded it, or by some intervening flora of which we have now but the scantiest records.

From what has been said the *Araucarias* are seen to be an archaic type, formerly most widely spread, now dying out and only lingering in restricted areas in the southern hemisphere, whose very specific differentiation was accomplished before the Eocenes began. May its value as food and use as the chief timber tree in the districts it still inhabits preserve it from an accelerated extermination at the hands of man.

J. STARKIE GARDNER

#### ON SOME POINTS CONNECTED WITH TERRESTRIAL MAGNETISM

THE remarks in NATURE, vol. xxii. p. 169, of Messrs. De La Rue and Müller in connection with their most interesting and important researches on rarefied gases induce me to ask the privilege of stating somewhat more fully than I did on June 17 what I conceive to be the

<sup>1</sup> Bentham, "Flora Australiæ," vol. vii.

position filled by a working hypothesis such as that then mentioned in the science of terrestrial magnetism. Let me begin with the aurora. Here we have a phenomenon which invariably accompanies magnetic storms, on which occasions it occurs simultaneously over a large portion of the globe. Again the recent researches of the above-named gentlemen render it very probable that auroral displays do not occur at a very great height, while it is conceivable that they may occur at times at an altitude of a few thousand feet. Here then we have a phenomenon which is intimately connected with sudden changes of the earth's magnetism. To this we may add earth currents as another phenomenon of the same kind, so that we have earth currents and auroral displays invariably associated with magnetic storms, when these are of marked violence. Now what is the nature of this connection? When we examine the formal laws of these associated phenomena we find that these lead us (almost irresistibly, as I think) to conclude that earth currents and auroræ are secondary discharges caused by sudden changes in the earth's magnetism, no matter how these changes are produced. So strong is the evidence of *form* in this instance that the late eminent magnetician John Allan Broun expressed to me his belief that earth currents and auroræ were connected with magnetic storms in the way above mentioned.

If this be assumed as the most probable working hypothesis, it is natural to take another step. If we have discharges produced in stationary strata by a changing magnet, may we not have discharges produced in moving strata by a constant magnet, and may not the motions and changes of motion produced by the sun in the upper convection currents of the earth give rise to electric phenomena which may explain the changes of terrestrial magnetism? Of course this is only a working hypothesis. Before it can possibly become an established theory we must have obtained from Messrs. De la Rue and Müller and from other observers that full and complete information regarding discharges in rarefied media which they are rapidly affording us, and we must likewise have obtained fuller information than we now possess regarding the directions and velocities of the convection currents in the upper regions of the earth's atmosphere. When this is done, the problem may be regarded as ripe for the mathematical physicist who may proceed with his calculations and either dismiss the hypothesis as untenable or increase the probability of its truth.

But in the meantime we are not ripe for this, and all that we can do is to regard the hypothesis as a working one, and endeavour by its means to elicit new facts regarding the *form* of the diurnal and other variations of terrestrial magnetism. I submit that in this respect the hypothesis has not been devoid of value. I have by its means been led to derive the fact that certain magnetic diurnal changes lag behind corresponding solar changes, just as meteorological changes would do—a fact which has since been confirmed by Mr. Ellis of the Greenwich Observatory. And I may be allowed to anticipate the results of work at which I am now engaged so far as to say that in the short periods which I am now investigating an increase or decrease of solar activity corresponds to an increase or decrease both of magnetical and meteorological activity.

Again, in conjunction with others, I have shown by preliminary discussions the probability of a progress of magnetic phenomena from west to east just as we know there is a progress of meteorological phenomena, only magnetic weather (if I may use the expression) appears to travel faster than meteorological weather. This last appears to me to furnish almost a crucial test in favour of this hypothesis, and through the courtesy of the Kew Committee, the Astronomer Royal, and Mr. Carmichael of Toronto I hope to be able soon to investigate this phenomenon in a more complete manner.

Finally, I understand that the Kew Committee are about to take in hand the subject of the progress of magnetic weather and to investigate it in a manner peculiarly suitable to an institution possessing relations with numerous self-recording magnetic observatories.

BALFOUR STEWART

### NOTES

THE fund which has been established by the members of the Birmingham Philosophical Society for the endowment of original research already amounts to 700*l.* in donations, and to 70*l.* in annual subscriptions. Out of this a sum of 150*l.* per annum for three years has been voted to Dr. George Gore, F.R.S., which amount is, in the terms of the grant, placed at his disposal in order that he "may have greater facilities for continuing in Birmingham his original researches." The council of the society proposes to make other grants as soon as the funds will permit. We have already spoken of the enterprise and public spirit of this society in establishing the fund; it is gratifying that they have been able to make a beginning so speedily, and the success of the scheme cannot be doubted. Dr. Gore's address is now the Institute of Scientific Research, No. 67, Broad Street, Birmingham.

WE are glad to hear that Mr. L. Fletcher, M.A., Fellow of University College, Oxford, has been appointed to succeed Prof. Story-Maskelyne as keeper of the Mineral Department of the British Museum. Mr. Fletcher was appointed first assistant in the department a little over three years ago, and the energy and ability with which he discharged the duties of that appointment promise well for the future of the Mineral Department.

WE regret to have to announce the death of Mr. Henry Ludlam, which occurred last week from the rupture of a blood-vessel. He had been in failing health for some months, but seemed on the road to recovery when the hæmorrhage occurred. He was well known in the mineralogical world as one of the most assiduous and able of private collectors, and his valuable collection was one of the objects of interest which foreign mineralogists visiting this country wished to consult. He has carried out his intention, announced several years ago, of bequeathing the collection to the Jernyn Street Museum. This gift will render the collection of this museum second only to that of the British Museum, and will, in fact, render it a formidable rival in the case of some of the rarer and more beautiful minerals. Mr. Ludlam was always willing to allow his mineralogical friends to consult his collection, and also frequently supplied them with specimens for examination.

THE Council of the Society of Arts have awarded medals to the following gentlemen for papers read during the session which is just over:—Major-General H. Y. D. Scott, C.B., F.R.S., for his paper on "Suggestions for Dealing with the Sewage of London;" A. J. Ellis, F.R.S., for his paper on "The History of Musical Pitch;" John Sparkes, for his paper on "Recent Advances in the Production of Lambeth Art Pottery;" Henry B. Wheatley, F.S.A., for his paper on "The History and Art of Bookbinding;" W. Holman Hunt, for his paper on "The Present System of Obtaining Materials in use by Artist Painters, as compared with that of the Old Masters;" Thomas Fletcher, for his paper on "Recent Improvements in Gas Furnaces for Domestic and Laboratory Purposes;" John C. Morton, for his paper on "The Last Forty Years of Agricultural Experience;" Prof. Heaton, F.C.S., for his paper on "Balmain's Luminous Paint;" Capt. Abney, R.E., F.R.S., for his paper on "Recent Advances in the Science of Photography."

Lord Norton has all along protested that he is not unfavourable to the teaching of science in elementary schools, and

is evidently hurt at the incredulity with which his protestation is received by those one-sided individuals who persist in judging his intentions by his actions, and not his words. He is evidently of opinion that the only difference between himself and those who would maintain the Code unaltered, is one of method. There are people so benighted as to believe that as science deals with *things*, it is hopeless to teach it apart from these things; who believe that if you want to make children know what a daisy or a buttercup is like, and to understand its structure, the shortest and most effectual way is to show them the flower and take it to pieces in some sort of systematic way before their eyes. But these people are all wrong. Why should children and teachers put themselves to the trouble of soiling their hands by pulling to pieces nasty weeds, when the thing can be much better done from books? Lord Norton, as we learn from a contemporary, has resolved to triumphantly refute these deluded people, by himself compiling a series of reading lessons in botany, warranted to teach the children of our elementary schools all that it is safe and wholesome for them to know. Evidently modern science and its methods are all wrong; books, after all, are the only instruments of education, and the sooner we make a holocaust of all modern scientific implements and methods the better. Might we suggest to Lord Norton that after he has completed his botanical enterprise he might compile a series of lessons in engineering, civil and mining, for the purpose of saving the neophytes in these departments the necessity for spending their time in sooty workshops and stifling mines? In fact there seems no end to the enterprise which Lord Norton is about to "inaugurate;" if he is able to carry it on to completion, he will probably earn for himself a right to be considered the most remarkable educationist of his time. In the meantime Her Majesty's reply to the address which the Lords were persuaded to adopt is virtually a quiet snub; while in the Commons Mr. Mundella has declared that the Government have no intention of lowering the standard of education in the country. Does not this look rather bad for the success of Lord Norton's projected compilation?

It is a tacitly-accepted practice, and one so beneficial to student-readers as to be almost imperative, that writers of original scientific memoirs should, wherever their researches touch upon common ground with those of older workers of standing, give references (at the very least in a decent foot-note) by which the student may be able to turn at once to the *ipsissima verba* of the possible authorities. We regret to notice an increasing tendency of late to slovenliness in the way of making such references on the part of some of the younger generation of enthusiastic would-be discoverers. Even the *Proceedings* of the Royal Society itself are not exempt from this modern weed, for in a recent paper we find the following given as references:—*Phil. Mag.*, 1850, *Pogg. Annalen*, 1858, and—for an important deduction from a paper by Clausius—*Phil. Mag.*, 1851. Is it too much to request the writers of Royal Society papers to be at least a little more explicit in their allusions? We cannot suppose that such references are made vague with any sinister purpose.

DR. P. F. C. HOEK of Leiden writes:—"The zoological station of the Netherlands Zoological Society for the summer months of this year is erected in the neighbourhood of Nieuwediep Harbour. The use of the station is free to the members of the Society and to strangers introduced by one of the members. The laboratory is furnished as completely as possible with all the implements—optical and steel instruments excepted—necessary for anatomical, histological, and embryological researches; it contains also a small collection of books necessary for a preliminary investigation and determination of the animals collected, &c. Special arrangements of a very simple but practical kind serve to keep alive the collected animals. Smaller and larger

exhibitions are organised every year by the station, and for these it always has at its disposal pilot-boats and other small vessels of the Dutch marine. Since its opening, in the summer of 1876, the station has repeatedly received proofs of appreciation from different quarters. Thus on the Scotch coast a similar station has been erected after the drawings and notes furnished by the Dutch Society; the International Exhibition of Fish and Fisheries, this year held in Berlin, rewarded the practical side of the institution with a silver medal. Further particulars may be obtained from the Secretary of the Commission for the Zoological station."

DR. HERMANN MÜLLER'S long-promised work on Alpine Flowers is being printed, and will be published towards the end of the year.

MR. DANIEL GRANT has given notice that he will to-day ask the First Commissioner of Works whether he will take into his consideration the advisability of substituting the electric light for the purpose of illuminating the House in place of the gas now used in the roof.

THE annual exhibition of the Photographic Society at Pall Mall will open on Saturday, October 2, and close on November 13. Friday, September 24, is the last day on which pictures can be received.

THE *Times* Geneva correspondent writes under date June 20 that a remarkable electrical phenomenon occurred at Clarens on the afternoon of Thursday last. Heavy masses of rain-cloud hid from view the mountains which separate Fribourg from Montreux, but their summits were from time to time lit up by vivid flashes of lightning, and a heavy thunderstorm seemed to be raging in the valleys of the Avants and the Alliaz. No rain was falling near the lake, and the storm still appeared far off, when a tremendous peal of thunder shook the houses of Clarens and Tavel to their foundations. At the same instant a magnificent cherry-tree near the cemetery, measuring a metre in circumference, was struck by lightning. Some people who were working in a vineyard hard by saw the electric "fluid" play about a little girl who had been gathering cherries and was already 30 paces from the tree. She was literally folded in a sheet of fire. The vine-dressers fled in terror from the spot. In the cemetery six persons, separated into three groups, none of them within 250 paces of the cherry-tree, were enveloped in a luminous cloud. They felt as if they were being struck in the face with hailstones or fine gravel, and when they touched each other sparks of electricity passed from their finger-ends. At the same time a column of fire was seen to descend in the direction of Chatelard, and it is averred that the electric fluid could be distinctly heard as it ran from point to point of the iron railing of a vault in the cemetery. The strangest part of the story is that neither the little girl, the people in the cemetery, nor the vine-dressers appear to have been hurt; the only inconvenience complained of being an unpleasant sensation in the joints, as if they had been violently twisted, a sensation which was felt with more or less acuteness for a few hours after. The explanation of this phenomenon is probably to be found in Prof. Colladon's theory of the way in which lightning descends, as described in *NATURE*, vol. xxii, p. 65. The Professor contends that it falls in a shower, not in a perpendicular flash, and that it runs along branches of trees until it is all gathered in the trunk, which it bursts or tears open in its effort to reach the ground. In the instance in question the trunk of the cherry-tree is as completely shivered as if it had been exploded by a charge of dynamite.

THE number of lions in Algeria is fast diminishing, and it is expected that the animal will soon be extirpated from the colony. As there is an increasing demand for public exhibitions at fairs and zoological gardens, an establishment has been formed at Bona, by a private individual, for lion-breeding.

The Commission for the construction of the Trans-Saharan Railway has determined that this great work shall be preceded by the establishment of a telegraph line connecting Algiers with St. Louis in Sengal *via* Timbuctoo.

WE hear that Mr. J. R. Gregory, the well-known mineral dealer in London, has been awarded at the Sydney Exhibition a *first class*—equal to a gold medal—and a *third class*, for his collections of minerals and fossils, and geological collections.

WE are asked to state that the business of Messrs. R. and J. Beck, the manufacturing opticians, has been removed from No. 31, Cornhill, to No. 68, Cornhill.

THE success achieved by M. Paul Desmarests in his balloon photographs, to which we referred last week, has created some sensation in the scientific world of Paris. The photographs obtained by him at Rouen were exhibited and explained by M. de Fonvielle in a lecture delivered at Versailles Mairie on June 22, at a sitting of the Société des Sciences Naturelles. They have been presented by MM. Paul Desmarests and Jovis to the Minister of War; M. Janassen will present them at the Academy of Sciences, and M. W. de Fonvielle to the Geographical Society. One of the photographs will be published next Saturday in the *Monde Illustré*, having been photographed on wood and engraved. The electrical apparatus which enabled M. Paul Desmarests to obtain his *clicks*, and the obturators have a weight of 700 grammes only, including the elements required. Steps are being taken for the systematic photographing of Paris and vicinity. One plate shows a piece of land covered with houses, gardens, and roads in the vicinity of Rouen, measuring 300 yards by 300 yards, and executed on the scale of  $\frac{1}{117}$ . The altitude was about 1,100 metres. The second photograph was in the direction of W.N.W., facing the horizon. All the Seine, from Rouen Railway Bridge to Guellebœuf, is seen with wonderful distinctness. The city of Rouen was concealed by a dense cloud, and is lost in darkness. The details on the banks can be magnified and examined at leisure. This remarkable ascent was made from Rouen on June 14, with *Gabriel*, a new balloon of 1,200 cubic metres belonging to M. Tovia, and built for the express purpose of crossing the Channel, weather permitting. It is owing to the uncertainty of the weather that this enterprise, of which we have spoken already, has been postponed.

WE learn from a circular forwarded to us that the Epping Forest and County of Essex Naturalists' Field Club will hold their next Field Meeting on Saturday afternoon, July 3, for the purpose of thoroughly inspecting the ancient earthworks of Ambresbury Banks and Loughton. The archaeological conductor for the occasion is Major-General Pitt-Rivers, F.R.S.

M. TESSIE DU MOTAY, a French chemist who had invented a continuous process for the preparation of oxygen gas and apparatus for oxyhydric lighting, has recently died at New York at the age of sixty-two.

THE excursions arranged for by the Geologists' Association are to Maidstone on July 10, Leith Hill and Dorking July 24, and Bristol on August 16 and five following days.

ON Tuesday evening Signor Alberto B. Bach gave a lecture at the Royal Academy of Music on the cultivation of the voice, and on his invention, the Resonator, an instrument somewhat of the nature of an artificial palate, intended to increase the power of the voice without any additional expenditure of breath.

NATURAL caverns of enormous size—one being 600 feet long—have been discovered within the last few days in the neighbourhood of West Harptree, near Wells, in Somerset. The investigations are still being carried on, and the discoveries have excited some interest among antiquaries and archaeologists.



In a paper read at the last meeting of the Statistical Society, by Mr. R. Price Williams, C.E., "On the Increase of Population in England and Wales," the author said the total increase of the population of England and Wales during the whole of the 17th century was only 3,417,536, the average decennial rate of increase being nearly 5 per cent., whereas during the present century, up to 1871, there was an increase of nearly 14 millions, the average decennial rate of increase being over 14 per cent. The rate of increase in the decade 1811-21 was the maximum attained in his century, viz., 18 per cent., as from that period down to the census of 1861 the rate of increase of the population had continuously diminished. He observed that a great increase of the population took place at the time when steam-power began to be used for manufacturing purposes, and while the towns increased, the rural districts were found to diminish. Mr. Williams estimates that the population of England and Wales by the census of 1881, will be 25,735,900. In the case of the population of London the decrements were very slight indeed, showing that it had not reached that declining stage in the rate of its increase long since arrived at in the case of Liverpool, Manchester, and many other large towns. The population of London had increased from 58,863 in 1801 to 3,251,913 in 1871. He did not think there was sufficient data for estimating the future increase of the population of London for any lengthened period, and he regarded as unreliable the enormous estimates which had recently appeared in connection with the question of the water supply of the metropolis, where the population in the course of the next century was estimated at over 17 millions.

THE Thirteenth Annual Report of the Peabody Institute of Baltimore testifies to the increasing usefulness of that institution, both as a library and as a centre of varied instruction. Among its means of usefulness are a series of lectures, many of which are on scientific subjects.

WE have received the Report of the South African Museum for 1879, from which we are pleased to see that the Museum is in a fairly flourishing condition. A long list of additions during the year is appended.

THE May and June numbers of the Friends' Schools' Natural History Journal contain much interesting matter, the local papers being specially valuable.

THE additions to the Zoological Society's Gardens during the past week include an Arabian Gazelle (*Gazella arabica*) from Arabia, presented by Capt. Titus; a Common Genet (*Genetta nigris*), South European, presented by Mr. G. H. Thunder, L.N.; an Ema (*Dromicus nova-hollandia*) from Australia, presented by Mr. A. McIlwraith, F.Z.S.; a Greater White-crested Cockatoo (*Cacatua cristata*) from Moluccas, presented by Mrs. A. L. Chetwode; three Red-beaked Weaver Birds (*Quelea anguinirostris*) from West Africa, presented by the Marchioness of Westminster; a Crested Ground Parrakeet (*Calopsitta nova-hollandia*) from Australia, presented by Miss M. S. Spooner; a Barbary Ape (*Macacus inuus*) from North Africa, an Ocellated Monitor (*Monitor ocellata*) from West Africa, deposited; three Ruddy Sheldrakes (*Tadorna rutula*), European, two Sandwich Island Geese (*Bernicla sandwicensis*) from the Sandwich Islands, two Blood-rumped Parrakeets (*Prephodus hamatopus*) from Australia, two Celebean Rails (*Rallus celebensis*) from Celebes, purchased; a Collared Fruit Bat (*Cynonycteris collaris*), a Japanese Deer (*Cervus sika*), born in the Gardens.

by Caturegli at Bologna, and two by Gambart at Marseilles, and the only orbits found in the catalogues are the two calculated by Kelligenstein. The comet was however observed at Rio de Janeiro, from June 18 to June 24, and Henderson reduced the observations, which were made by Lieut. Robertson, R.N., and calculated an approximate orbit upon them. The comet approached near to the earth, and is of some interest upon that account. Mr. Hind has combined the observations of both hemispheres, and with the following results for the elements of the orbit: Henderson's numbers, not being found in our catalogues, are annexed:—

	HIND.	HENDERSON.
Perihelion passage July 15	8442 G.M.T.	July 15 651 G.M.T.
Long. of perihelion ... ..	219 59'4	220 19 49
" Ascending node ... ..	97 44'3	98 14 47
Inclination of orbit ... ..	36 17'5	35 36 0
Log. perihelion distance ... ..	9'92797	9'92879
Motion—retrograde.		

Henderson's paper upon this comet will be found in the *Philosophical Transactions* for 1831. On June 18 the comet was in opposition to the sun, distant from the earth 0'14. Though it was discovered by Pons at Marlia on May 30, we have no observation previous to June 8. Pons at the time was not provided with instruments competent to fix the positions. Zach writes of the comet at the time of discovery that it was without tail or nucleus, simply a nebulosity more condensed towards the centre. Pons thought that in the absence of moonlight it would have been visible without the telescope. He was then on the watch for Encke's comet, which, though not observed in Europe, was closely followed by Rümker at Paramatta, N.S.W.

THE DOUBLE-STAR 85 PEGASI.—Mr. Burnham publishes measures of the small and close companion of this star made in the summer of 1879, which, compared with those he obtained the previous year when he detected this very faint object, establish its physical relation to the principal star, since it is shown to partake of its large proper motion, while a suspicious difference of 10" between the means of the measures in 1878 and 1879 points to its binary character. These means are as follow:—

1878'43 ... Position	274'0 ... Distance	0'67 ... 3 nights
1879'46 ... ..	284'6 ... ..	0'75 ... 5 nights

Mr. Burnham estimates the magnitude of the close companion about the twelfth on Struve's scale, and considers it will require an aperture of at least twelve inches to show it. He has also measured the distant companion which was used by Prof. Brünnow in his investigation of the parallax of 85 Pegasi, which he made to be 0'054. This star was observed with 85 at Königsberg by Bessel on October 6, 1825, when it followed 61'95 in R.A., and was 38'6 south of the bright star. If we compare these differences with those corresponding to Mr. Burnham's measures at the epoch 1878'95, and assume the fixity of the companion, we shall find for the secular proper motion of 85 Pegasi in R.A. + 100'1, and in Decl. - 96'1, agreeing precisely with the values resulting from a comparison of the meridian observations. If, as Prof. Brünnow hinted, there is proper motion of the distant companion, its amount would appear to be very minute. Mr. Burnham adds that there are but two other stars on our lists similar in character to 85 Pegasi, viz.,  $\gamma$  Piscium and  $\beta$  Scorpii; all three were detected by him with the 18-inch Chicago refractor.

A VARIABLE STAR IN AQUARIUS.—The star observed on six nights at Bonn, in 1863, in R.A. 22h. 28m. 16'9s. N.P.D. 98° 21' 19" for 1855'0, is variable from 9m. to invisibility in a 7-inch aperture. Argelander noted it four times 9'5, once 9'6, and once 10'0. It was observed at Markree as a 9m. on October 27, 1848, on August 26, 1852, it was 11m., and on November 9, 1874, it was invisible. On September 21, 1876, it was 11'12. It has at times a hazy blurred appearance, as remarked in several other variable stars. This star was long since indicated as variable, but appears to have escaped attention from most observers of this class of objects.

#### GEOGRAPHICAL NOTES

DR. FRANCISCO FERREIRA PASSOS, Director of the Brazilian State Railways, has recently caused to be prepared and published a map showing the existing and projected railways in the provinces of Rio de Janeiro, Minas, and San Paulo. This map is

#### OUR ASTRONOMICAL COLUMN

THE THIRD COMET of 1822.—Neither Galle in his catalogue, nor Kall in his *Repertorium der Cometen-Astronomie*, refers to any observations of this comet except the imperfect ones made

apparently executed with much care, and is stated to be the most accurate of its kind yet produced in Brazil. He has also published the first part of a work on the railways of Brazil in 1879, descriptive of the lines shown on the above-mentioned map, and he has added a skeleton map showing the railways only. Dr. Passos has, we believe, been induced to issue these publications in order to make more widely known in England the progress in railway communication now going on in Brazil, a subject which is of considerable interest from an economical and geographical point of view.

THE last *Bulletin* of the Antwerp Geographical Society contains a geographical and commercial essay on the Australian colonies, which is accompanied by reproductions of some curious old maps, as well as by a sketch map which professes to distinguish the arable, pastoral, and desert regions of the continent, in regard to which, however, the writer's information hardly appears to be brought down to the latest date.

FROM the Japan papers we learn that H.M.'s surveying vessel *Sylvia* left Hiogo on April 24 for Cape Chichakoff to take a line of soundings there, which will complete her surveying work on the Japanese coast. The *Sylvia* has been employed for about twelve years in surveying the coasts of Japan and the Inland Sea, and during this period has done excellent service to navigation.

M. DE UJFALVY is to leave Paris at the end of the summer on his new journey of exploration in Central Asia.

THE *Times* correspondent writes from Copenhagen that on June 24 died there Mr. Carl Petersen, whose name is connected with some of the most renowned Arctic explorations. He was a born Dane, but had lived many years in Greenland, and had there acquired a perfect knowledge of the Esquimaux language, being at the same time a most skilled hunter and fisherman. At the age of thirty-seven he was engaged by Capt. Penny as interpreter, and accompanied his expedition in the years 1850-51. Some years later he followed Dr. Kane on his unfortunate expedition, when the vessel had to be left in the ice and the crew were nearly starved and frozen to death. He had not been home more than a couple of weeks after returning from a two years' stay in Greenland, before he went out again as interpreter with the *Fox*, Capt. Sir Leopold M'Clintock, with Mr. (now Sir) Allan Young as sailing master. Of this expedition, lasting from 1857 to 1859, and leading to the discovery of the fate of Sir John Franklin, he has written a graphic description, supplying many details wanting in the well-known book of Sir L. M'Clintock, and inscribed with the words chosen by Jane Franklin for the flag of the *Fox*, "Hold fast," happening to be quite as correct in Danish as in English. In 1861 he accompanied the Swedish naturalists Nordenskjöld and Torell on their first expedition to Spitzbergen, and when, in last April, the *Vega* passed Copenhagen, the hardy old sportsman and sailor, with his cross and Arctic medal, was one of the friendly faces greeting the discoverer of the North-East Passage. Mr. Petersen died from heart-disease at the age of sixty-seven.

### PHYSICAL NOTES

ONE of our electrical contemporaries across the Channel gives a glowing description of *une grande machine électrique allemande*, which its editor says he wishes to see introduced into France, "where our official professors appear to have lost all ambition at making things big." The great gooseberry of the season is nothing to this new machine, which is, we are told, composed of twenty parallel disks of 1,300 metres in radius. This is "making things big" with a vengeance, for the diameter of the disks will be over  $2\frac{1}{2}$  kilometres, or about a mile and a half. Did our contemporary make a double blunder when it wrote "*treize cents mètres*"? If we remember rightly, the plates in Topley's induction-machine, which appears to be the one referred to, are not far from 13 centimetres radius.

PROFESSORS BRACKETT AND YOUNG have made a new determination of the efficiency of Edison's dynamo-electric generator and of his carbon horse-shoe lamp, and find that one horse-power applied at the dynamometer would produce in this lamp a light equal to that of 107 standard candles. As a matter of fact the lamp was only giving a light of 10·7 candles while consuming 0·077 of a horse-power, which is not quite the same thing.

PROF. QUINCKE has lately been occupied with a very remarkable research on the alteration of volume which a dielectric experiences under the stress of an electric charge. In most

cases the result of surface electrification is to produce a minute expansion, but one class of bodies—that of the fatty oils and resins—contracts under similar circumstances. Herr Quincke applies his measurements to explain the phenomena observed by Kerr of the double refraction of light exhibited by dielectric media when under electrostatic strain; and he shows that the optical effects in the two classes of media are opposite in character.

M. MOUCHET is continuing in Algeria the researches on the utilisation of solar heat which he began in the South of France. He employs, according to his recent communication to the *Comptes Rendus*, a mirror 3·8 metres in diameter to concentrate the rays of the sun upon a boiler of copper 5 millims. thick. Even on dull days the apparatus boils water under half an hour. M. Mouchet has employed his apparatus for the distillation of oils and essences, the boiling of linseed oil, and the sublimation of benzoic acid. He has even succeeded in working a small engine.

MR. G. R. CAREY of Boston has published in the *Scientific American* a suggested system for the transmission of light by electricity. A camera throws an image of the object to be exhibited upon a surface made up of small pieces of selenium, each of which forms part of a separate voltaic circuit, the circuits passing to a receiving instrument, where they reproduce the image by incandescence. To this Mr. Sawyer has appended the following criticisms:—The action of light in altering the conductivity of selenium is slow. To transmit satisfactorily an image one inch square would require 10,000 selenium points and 10,000 conducting wires, unless some principle of isochronous movement could be devised—which Mr. Sawyer regards as unattainable in practice.

M. FAYE has lately published in the *Comptes Rendus* a remarkable paper on the physical forces which have produced the present figure of the earth. After remarking on the use of the pendulum in determining the figure of the earth from series of measurements of the intensity and direction of the gravitation force at different parts of the earth's surface, he draws attention to the curious fact that while the direction and intensity of gravity are affected perceptibly by the presence of hills such as Schiehallion and Arthur's Seat, or even by masses as small as the Great Pyramid of Gizeh, gigantic mountains such as the Himalayas, and great elevated plateaux and table-lands do not affect the pendulum-indications in any sensible manner, except in certain cases where upon elevated continents there appears to be a veritable defect of attraction instead of the excess which might be expected. Indeed, the observations are sufficiently striking to seem to point to the supposition that not only under every great mountain, but even under the whole of every large continent, there were enormous cavities. More than this, the attraction at the surface of all the great oceans appear too great to agree with the distribution presumed by Clairaut's formula, which is exact enough for most purposes. Sir G. Airy's suggestion that the base of the Himalaya range reaches down into the denser liquid interior, and there displaces a certain amount of that liquid, so that the exterior attraction is thereby lessened, is one which, inherently improbable, fails to have any application in explaining why the attraction above the seas should be greater than over the continents. M. Faye propounds the following solution to the difficulty:—*Under the oceans the globe cools more rapidly and to a greater depth than beneath the surface of the continents.* At a depth of 4,000 metres the ocean will still have a temperature not remote from 0° C., while at a similar depth beneath the earth's crust the temperature would be not far from 150° C. (allowing 33 metres in depth down for an increase of 1° in the internal temperature). If the earth had but one uniform rate of cooling all over it, it would be reasonable to assume that the solidified crust would have the same thickness and the same average density all over it. It is therefore argued that below the primitive oceans the earth's crust assumed a definite solid thickness before the continents, and that in contracting, these thicker portions exercised a pressure upon the fluid nucleus tending to elevate still further the continents. This hypothesis, M. Faye thinks, will moreover explain the unequal distribution of land and sea around the two poles; the general rise and fall of continents being determined by the excess of density of the crust below the oceans, and by the lines or points of least resistance to internal pressure being at the middle of continents or at the margin of the oceans.

SOME experiments have lately been made by the Rev. Dr. Laughton and Prof. Emerson Reynolds to evaluate the coefficient of friction (*i.e.* the "drag") of air upon air and of water upon water. In these experiments a spherical ball of unpolished granite of 25 kilogrammes weight and 25 centimetres in diameter was suspended freely by a pianoforte wire and was set rotating in the air or in water; the period of the vibrations and the decrement of their amplitudes being observed by means of indices attached to the brass collar by which the ball was suspended. A discussion of the equations of motion led to a simple working equation for reduction of results. The mean coefficient of friction found for air upon air was  $f = \frac{1}{6052.7}$ , though this value apparently differed slightly according to barometric and thermometric conditions. For the "drag" of water upon water he value found was  $f = \frac{1}{307}$ . These experiments involved friction at low velocities only, for which it could be assumed that the friction was proportional to the velocity. The authors of his research point out that these results tend to negative the theory of Dr. Carpenter that the phenomena of ocean circulation are due to the greater height of the water at the equator as compared with that at the poles.

FROM a series of experiments with tones produced by a limited number of impulses, Herr Kohlrausch finds (*Wied. Ann.*, No. 5) that a tone of only two vibrations of a certain frequency can be distinguished as differing in pitch from a continuous tone, when it forms with it an interval of  $\frac{1}{3}$ . Also, in agreement with the researches of Herr Exner and Herr Auerbach, the possible sharpness in definition of the pitch of a tone by an ear of average fineness does not perceptibly increase after sixteen vibrations have occurred. The general results are regarded as confirming Helmholtz's theory of the co-vibration of tone-perceiving organs in the ear. The experiments were made with a pendulum fitted with a piece of toothed wheel, of radius equal to the length of the pendulum, the teeth impinging on a piece of cardboard. The continuous tone was obtained from a monchord.

THE torsion of wires of steel, iron, and copper has been recently made a subject of experiment by Herr Warburg (*Wied. Ann.*, No. 5). Among other results, the statically-determined moments of torsion are found to be all smaller than those dynamically determined; and the differences rise from 1 per 1,000 for steel to 6 for iron and 28 for copper. The elastic pressures seem to increase somewhat more slowly than the deformations, the divergence being greater for copper than for iron, and for iron than for steel. No dependence of the coefficients of torsion on the tension was discoverable (within the limits of experiment). As to the properties of wires that have undergone permanent torsion, it appeared that it was only in the case of soft copper wires that, within wide limits of permanent torsion, these extend almost uniformly over the whole wire. Confining himself to copper wire, then, his experiments lead him to believe that by permanent torsion the wire becomes anisotropic, behaving, at any part, like a crystal of the rhombic system, whose axes have certain directions.

ATTENTION has been called by Herr Holtz (*Wied. Ann.*, No. 5) to an optical illusion in looking at geometrical figures, whereby they appear shorter from right to left than they really are; a square, *e.g.*, appearing more or less as a rectangle, and a circle as an ellipse. One direct consequence is that when we draw such figures according to eye-measurement, we make them too long horizontally. The reason of the illusion Herr Holtz contends to be that, in common life, we much more frequently see real bodies than geometrical figures, and so are disposed to draw the outlines of such figures for the outlines of actual bodies. Now we see more of a body in a horizontal direction than in a vertical, because we see with two eyes, and these are in a horizontal line. The outline of a ball appears to us really as an ellipse, because, from right to left, we see more than half of the ball. When we see a true circle this seems horizontally shortened, because we take it for the outline of a ball, and if we draw a circle we unconsciously give the outline of a ball.

SOME researches by Herr Röntgen in the same line as those by Dr. Kerr, revealing a new relation between light and electricity, are described in the *Annalen der Physik*, No. 5; the methods were somewhat varied. Special attention was given to the direction of vibration of the light in the liquid, and the author's results seem in the main to confirm Dr. Kerr's views. Dr. Kerr got an effect

with nitro-benzol only when a spark-interval was introduced in the connection of the one electrode with the conductor of the machine, giving a sudden discharge through the liquid. This Herr Röntgen considers due to the comparatively good conductivity of nitro-benzol; the spark discharge effects a brief but large difference of potential (not obtained in the other case), producing sudden luminosity in the field of vision. But Herr Röntgen obtained the same effect with all the badly-conducting substances he examined; it was only of longer duration. A welcome method is thus afforded for examining comparatively good conducting liquids as to electro-optic properties, and Herr Röntgen thus demonstrated, for glycerin, sulphuric ether, and distilled water, an influence of electricity on the transmitted light. The author offers (doubtfully) a different hypothesis of the phenomena to that of a direct action of electricity on the light vibration.

IN a recent paper in the *Annalen der Physik*, No. 5, Prof. Clausius criticises recently-published views of Maxwell, Frowen, and Korteweg on the mean length of path of gas molecules.

### PHYSICAL SCIENCE IN RUSSIA

WE have before us the minutes of the meetings of the Physical Section during the last congress of Russian naturalists, just published in the last number of the *Journal of the Russian Physical and Chemical Society* (vol. xii., fasc. 4), and we find in them reports of several very interesting papers which were read and discussed during the congress.

The most numerous communications were on electricity. Thus, M. Feploff exhibited the new electrophoric machines of his invention. A glass of sulphuric acid is sufficient for maintaining the machine ready, even during moist weather; it gives very powerful sparks, white and coloured, and succeeds well in decomposing water.—Prof. Khvolson made a communication on corrections to the differential equations of the motion of a magnet which oscillates under the influence of a metallic tranquilliser, and discussed the method of computation of corrections to differential equations of motion in general.—M. Tchikoleff gives the equations for determining the losses which an electrical current experiences when passing through telegraphic wires.—Prof. Stoletoff has terminated his experiments for determining the ratio between electro-magnetic and electro-static units ( $v$  of Maxwell). He undertook his experiments in 1876, but had not terminated them at that time; recently MM. Ayrton and Perry have determined the value of  $v$  by a method analogous to his own, which differs from theirs in measuring a current produced by a series of successive discharges, by means of a rotating commutator, the velocity of rotation of which is measured by means of a chronograph. The preliminary experiments have given a velocity very near to that found by other researches, *i.e.*, about 300,000 kilometres per second, and Prof. Stoletoff expects to obtain more exact figures.—M. Borgmann continues his experiments for determining the heating of iron by intermittent magnetisation. The experiments are very difficult, because of the inductive currents, but they have already shown that a change in the magnetic state produces an increase of temperature.—Prof. Lemström (Helsingfors) made a communication on his most important work on the causes of terrestrial magnetism. He has demonstrated that an annular isolator, when put in rapid rotation around an iron cylinder, acts upon this last as a galvanic current and magnetises it. Likewise an iron cylinder when rapidly rotating in an insulating medium must be magnetised, and thus the earth when rotating in an atmosphere of ether must also be magnetised. The various peculiarities observed as to terrestrial magnetism might be easily explained by the motion of the earth around the sun, and by the terrestrial galvanic currents.—M. Tchikoleff explained his improvements in the Foucault electric lamp, which allow several lamps to be placed in one circuit.—Prof. Petrushevsky made an interesting communication on his measurements of the intensity of the magnetic field between the extremities of electro-magnets of various shapes, which measurements were made for determining the best shape to give to electro-magnets. That of Ruhmkorff proved to be twice as strong as that of Gramme. The best shape is that of two iron cylinders united together by means of arcs made of broad iron plates. The free ends must be provided with two spherical pole-pieces, each of which has a conical process, the ends of these two processes being directed one to another.

In meteorology we notice several valuable papers, the most important of them being that by M. Woetkoff on rainfall in

various parts of the earth within different seasons.—Prof. Krayevitch, who has undertaken a series of investigations on the very small changes of pressure of the air in connection with changes of weather, exhibited his new graphic very sensitive barometer, the column of which consists of water and mercury, and which amplifies 140 times the oscillations of a common mercury barometer.—Prof. Egoroff has begun a series of researches into the atmospherical lines of the solar spectrum. As known, several of them are due to the presence of water-dust in the atmosphere, and Ångström supposed that several other lines (A, B, and  $\epsilon$ ) depend upon the presence of carbonic acid and nitrogen. The experiments of M. Egoroff show that neither of these two gases modifies the solar spectrum, even when the rays go through a sheet five metres thick of gas.

In other branches of physics we must but notice the most important work, by Prof. Tchelysheff, on centrifugal regulators; the researches by M. Sloughinoff on the calorific capacity of gases; by Prof. Petrushevsky on the velocity of evaporation of liquids with reference to the coefficients of cohesion of these liquids and to the molecular pressure; on the true atomic heat capacity, by M. Stelson, who arrives at the conclusion that the theory of a constant atomic heat-capacity is not true for many gases; and by M. Sloughinoff, on the powder-state of bodies, and on the changes of the internal energy of solids and fluids under the influence of exterior forces.

We notice also the communication by M. Lebedzinsky on an improved microscope with liquid lenses, which gives enlargements from 50 to 200 times, and is very cheap; and by M. Argamakoff on lighting and heating by means of pulverised hydrocarbons.

### SEISMOLOGY IN JAPAN

*The Earthquake of February 22, 1880.*—The earthquake which occurred shortly after midnight on the morning of February 22 was the most severe since the opening of this country to foreigners. I have been so much in the habit of noting my watch during the frequent earthquake manifestations by day and night, that I am sure I must have been instantly awakened. My house was swaying to and fro, windows were rattling, timbers creaking, mortar falling, and pictures swinging violently. Although, as usual on such occasions, I was studying my watch by a night light, I meditated escape. After forty seconds the motion apparently subsided. There had been two distinct periods of maximum intensity. Taking my lamp, I tried to reach the door, but the motion was still so great that I had to stop, supporting myself against the wall. When I went down stairs to look at two long pendulums of 20 and 30 feet length respectively, I found them swinging in arcs of about 2 feet, having broken all the apparatus on the table over which they hung. Hitherto the pointers placed on heavy weights suspended by long wires have been regarded by me as motionless points during an earthquake, and I have been able to use them accurately on this assumption even for a shock which Palmieri's instrument indicates as 21', a shock which knocked down several chimneys. It would seem that in the last earthquake the house, instead of, so to speak, "eating up" the vibrations, was forced into vibration itself. The period of this vibration was roughly noted by my neighbour, Mr. Thomas Gray, as nearly one second. At the lower end of one of these pendulums I have small pointers which scratch two smoked glass plates. These plates are caused to move away during an earthquake, so that relative vibrations are shown in two wavy lines. The direction of the first mark upon the plate tells the direction of the shock, and also the distance moved by the earth relatively to the steady pointer. The amplitude of the waves tells approximately what the movement has been during succeeding vibrations. From the number of waves upon a given length of glass we get the rate of vibration, and hence, knowing the velocity of transit, the true wave-length of the earthquake may be determined. As an example I may mention that an earthquake (December 3, 1879) registered by Palmieri's instrument as 18', was recorded on 7 inches of one of my glass plates in a curve of seven very small waves, the amplitude of each of which was about 1 mm. Each wave was formed in half-a-second. The important deductions which may be drawn from even only one observation of this kind are obvious. The other pendulum I have used only for finding the greatest horizontal movement of an earth particle and its direction. Two pointers push against the motionless pendulum-bob when an earthquake occurs, and so they are moved in the stand which carries them, deflecting

two suspended galvanometer mirrors, and readings of the amount of deviation of beams of reflected light are taken. I give some examples of the movement of the head of a pile which was driven deeply into the soft soil upon which Yedo is built:—

1. March 4, 1879, 4.43 p.m.—On the smoked glass the mark made was 3 mm. long; N. 10° E. to S. 10° W. Palmieri's instrument gives this shock of intensity 10' from S.S.W. to N.N.E.

2. February 1, 1880.—Small shock. Mark 1.25 mm. from N. 35° W. to S. 35° E. Palmieri's instrument gives intensity 2'5 S.S.E. to N.N.W. As measured by the mirrors, this shock was 0.5 mm., and there is reason to believe that the mirrors were more correct. The amplitude of swing, as indicated on the moving plates, was from 3 mm. to 4 mm. At the point, however, there seems to have been a motion of about 10 mm.

As my indicating apparatus was broken, I give the following record from two of Palmieri's instruments in the Government Observatory:—

From S.S.E.	or N.N.W.	the intensity was	78
" S.S.W.	" N.N.E.	" "	52
" W.S.W.	" E.N.E.	" "	28
" W.N.W.	" E.S.E.	" "	28

These measurements had to be computed, as the graduations of the instruments are only to 26°. The shaking seems to have had three periods. The first began at 12h. 49m. 22s., and lasted 14 seconds; the second began at 12h. 50m. 19s., and lasted 1m. 26s.; the third began at 12h. 52m. 15s., and lasted 6 seconds.

On visiting Yokohama I found that the chief destruction had been amongst the houses belonging to Europeans. This is partly due to the Japanese houses being nearly as flexible as baskets, but it is also on account of the European houses being mostly built on hills. Thus the houses built on the *bluff*, hills intersected by sharp steep valleys, and also many houses built along the *creek* have suffered; the greater part of Yokohama is built on a plain of shingle, and the houses here escaped with small damage.

The edge of a declivity is like the last of Tyndall's row of boys, unsupported on one side, and therefore gets shot forwards.  
Tokel, Yokohama, Japan  
JOHN MILNE

### UNIVERSITY AND EDUCATIONAL INTELLIGENCE

CAMBRIDGE.—In the first half of the winter course of lectures given in connection with the Cambridge Local Lectures the attendance of about 1,200 persons, on subjects of physical science, out of a total of 3,570, may be noted. In the second half of the session scarcely 400 were attending lectures on physical science subjects, but this was coincident with a general falling off after Christmas, to which bad weather, depression of trade, and political excitement may have contributed.

Another academic year has completely passed, and in the multitude of counsellors no relief has yet been given to those who desire freedom of choice of language studies and some chance for modern languages. The University still says: "If you have not the smattering of Greek we require, we will give you no degree unless you bring up Arabic or Sanskrit as an Oriental student."

A LIVERPOOL paper intimates that the movement for establishing a University College in that city is likely soon to be crowned with success. In the scheme which was approved at a town's meeting held some months ago it was proposed that seven professorships and two lectureships should be founded, and it was estimated that, independent of the cost of erecting college buildings, the amount required for the foundation of the college is an annual income of 3,000*l.*, or a capital sum of 75,000*l.* The committee accordingly appealed for subscriptions, and the appeal has been responded to in such a hearty manner that there is every probability of the entire sum required being raised before long. Already 60,000*l.* has been subscribed for the establishment of the college, the subscriptions including several of 10,000*l.* each. Lord Derby has subscribed 10,000*l.* towards the founding of one professorship; a like sum has been given by Messrs. W., S. G., and P. H. Rathbone. Mrs. Grant of Rock Ferry has endowed another professorship with 10,000*l.*; Col. A. H. Brown and the Messrs. Crossfield have between them contributed 10,000*l.* for the founding of another chair; and it is believed a number of Scotchmen resident in the city will provide

a similar amount for a similar purpose. Several other large subscriptions have been promised to the treasurer, Mr. Robert Gladstone, bringing the total up to the amount above stated.

### SCIENTIFIC SERIALS

*Bulletins de la Société d'Anthropologie de Paris*, tome 2, fasc. 4, 1879.—This closing number of the last year's Bulletins contains an interesting paper by M. Jacques Bertillon on the mean averages of life in the various grades of society among civilised races. His paper refers specially to France, although it supplies some comparative tables deduced from the mortality tables of other countries, while it principally aims at directing attention to the preventibility of numerous causes of early death.—M. G. Lagneau, in presenting to the Society [the mortality tables for Belgium, drawn up by Dr. Janssens for 1878, referred to the predominance of phthisis in male subjects in France since 1865-66, females having before that period supplied the larger number of deaths from pulmonary tuberculosis.—M. Lunier records the results of the official inquiry which he had been authorised to make in reference to the distribution of epilepsy in the various departments of France, and with regard to station, age, sex, &c.—M. le Docteur G. Le Bon gives an interesting report of his examination of the curious collection of skulls of celebrated men, now in the possession of the Paris Museum of Natural History, which is believed to include those of Boileau, Descartes, and Gall. The mean cranial capacity for the forty-two skulls, when compared with that of forty-two skulls of modern educated Parisians, was in excess of the difference between the latter and an equal number of negroes.—The present number of the *Bulletins* contributes little of importance to the literature of local French paleontology, the most interesting of such contributions being a paper by M. Mortillet, who reports the discovery, by M. Perrou, of a funereal car with traces of human bones and textile fabrics in the tumulus, or barrow, known as la Motte at Apremont, in Haute-Saône.—M. Verneau describes the Grotto de Voutré, in La Mayenne, in which a skeleton, believed to belong to the Bronze age, has been found, while a similar discovery has been made at Quevilly, near Rouen, as also at Cierges, where fragments of a dolichocephalic cranium of the neolithic type have been recovered. M. Millescamps has, moreover, drawn attention to the recent discovery by the Abbé Hamard, at Hermes (Oise) of cut flints in graves of the Merovingian age. The previous discovery between 1873 and 1875 of upwards of 20,000 flints in the Merovingian cemetery of Caranda has raised the question, which still awaits solution, whether these flints were deposited with the dead merely as objects with which the living had been most familiar, or whether their presence had any supposed protective action.—M. Zaborowski has laid before the Society the result of his examination of five Hakka skulls, and communicated the information he had received from M. de Lagrenée, French Consul at Canton, in regard to the history and pure Chinese origin of the Hakkas, who have in all ages formed the active combative element in the Chinese system, and have in recent years constituted the kernel of the Taiping rebellion.—The Abbé Durand describes a blonde African race, noticed near Laouga in 1562, and still traceable in Mozambique.—The original site of the Aryan race has again been brought under discussion by M. Henri Martin, who now inclines to the opinion, supported by M. de Ujfalvy, that a brown brachycephalic Aryan branch took precedence in Asia of the blonde dolichocephalic Aryans.—The most important paper in the present volume is M. Paul Broca's "Etude des Variations craniométriques, et de leur Influence sur les moyennes." To this is appended a valuable series of the means, variations, &c., of the cranial measurement of heads belonging to all countries and various periods.—M. Ujfalvy explained his views in regard to the opinion put forth by the Swedish anthropologist, Prof. G. Retzius, that Finland is occupied by two distinct races, the true Fin, or Tawaste, and the Carelian, or Finlander.—M. Emile Soldi, in presenting to the Society his recent work on the proportions of Greek and Egyptian statues, took occasion to refute the opinion advocated by Dr. Le Bon and M. Broca, that the Greeks followed Egyptian canons of taste in art, and that they took their models from foreigners.—M. Bataillard read a paper on the ancient workers in metals in Greece, and endeavours to trace in the traditions of Dodona the direct ancestors of the modern Tagman, or gipsies.

*Papers and Proceedings of the Royal Society of Tasmania for 1878.*—R. M. Johnston, on the freshwater shells of Tasmania;

gives a list and describes several new species.—Rev. J. E. Tenison-Woods, on some new Tasmanian marine shells; describes a new genus, *Iosepha*, for a *Cominella* with a plait, and several new species.—R. M. Johnston, on certain tertiary and post-tertiary deposits on islands in Bass's Strait.—F. M. Bailey, remarks on the distribution and growth of Queensland plants.—Rev. J. E. Tenison-Woods, on some Tasmanian freshwater univalves.—F. Abbott, on *Carduus arvensis*.

### SOCIETIES AND ACADEMIES

LONDON

Royal Society, June 10.—"On *Bacterium fatidum*: an Organism associated with Profuse Sweating from the Soles of the Feet." By George Thin, M.D. Communicated by Prof. Huxley, Sec.R.S.

The feet of certain individuals are characterised by a peculiar powerful and foetid odour, which is really connected with the moisture that soaks the soles of the stockings and the inside of the boots. The moisture, which comes from the skin of the soles, especially from that of the heels, has no offensive smell whilst it is exuding, but it rapidly acquires the characteristic odour when taken up by the stocking.

The fluid is an admixture of sweat with serous exudation from the blood, occurring in persons whose feet sweat profusely, and who, from much standing or walking, acquire an erythematous or eczematous condition of the skin of the soles, the local eczema or erythema being favoured by the softening and macerating effect of the sweat on the epidermis.

When a small portion of the sole of the wet stocking was teased out in water, the drop of water was found to be swarming with micrococci.

A second generation of the organism, which the author calls *Bacterium fatidum*, was obtained by placing a small piece of the wet stocking in a test-glass, charged with pure vitreous humour. This and succeeding generations were cultivated at a temperature which varied between 94° and 98° F. The successive generations were obtained by inoculating pure vitreous humour, with requisite precautions.

In twenty-four hours the surface of the vitreous humour was always found covered with a delicate scum, which in forty-eight hours was compact and tolerably resistant.

In the scum of one day's growth and in the fluid below it organisms were found as cocci, single and in pairs, in transition stages towards rod formation, as single and jointed rods, and as elongated single rods. Many of the rods were actively motile.

The compact scum of two days' growth was sufficiently resistant to be removed in an unbroken sheet. When disturbed by the needle it fell to the bottom of the glass. It was found to contain all the forms found in the twenty-four hours' growth, and in addition long unbroken rods in transition stages towards the formation of chains of spores.

Spores were also found lying beside the empty and partially empty sheaths from which they had been discharged. Groups of single spores and pairs, identical in size and appearance with those which had come to maturity in the sheaths, were found mixed up with rods in all phases of development.

The first stage in the development of the organism is the formation of a pair from one coccus.

The next stage is that in which the whole body is wedge-shaped, the round brightly refractive coccus being found in the thick end of the wedge. Another phase, which is probably the successor of the preceding one, is the appearance of a canoe-shaped figure with the bright coccus in the centre.

Other appearances connected with the early stage of development, and probably following the wedge and canoe-shaped figures, show the organism developed into a staff-shaped body, containing two elements of very different refractive power. The coccus element is still distinct and is brightly refractive, the other element is very slightly refractive and is seen as a dull shade, with however perfectly distinct outlines.

The coccus may be at one end of the rod, two cocci may be in the centre close together with a prolongation of protoplasm on either side, or a central rod of protoplasm may have a coccus at either end.

In the next stage we have the formation of the rods characteristic of bacteria. The distinction between the coccus and the protoplasm becomes lost, although transitions are found in which faint differences of refraction still betray the two elements. The formation of rods of ordinary size, of long rods with

unbroken protoplasm, of rods with segmented protoplasm, and of rods filled with spores or cocci progresses identically with the similar formation in the *Bacillus anthracis*.

The bacterium grows in turnip infusion less actively than in vitreous humour. The observations were not sufficiently extended to determine whether the bacterium forms spores when cultivated in turnip infusion, but they sufficed to show that if such a formation takes place, it occurs much less actively than when the cultivation is in vitreous humour.

The fetid odour of the stocking was reproduced in the cultivation glasses, although the strength of the odour diminished in successive generations.

Dr. Thin stated at the meeting that an antiseptic treatment by which the bacteria were killed in the stockings and inner surface of the soles of the boots completely destroyed the fœtor.

"Memoir on Abel's Theorem," by R. C. Rowe, Fellow of Trinity College, Cambridge. Communicated by A. Cayley, LL.D., F.R.S., Sadlerian Professor of Pure Mathematics in the University of Cambridge.

"On certain Effects of Stress on Soft Iron Wires," by J. A. Ewing, B.Sc., F.R.S.E., Professor of Mechanical Engineering in the University of Tokio, Japan. Communicated by Fleeming Jenkin, F.R.S., Professor of Civil Engineering in the University of Edinburgh.

Physical Society, June 12.—Mr. Huggins, F.R.S., in the chair.—New Members: Mr. H. B. Inff, Mr. Adam Hilger, Mr. C. V. Boys.—Dr. Shettle, of Reading, read a paper on the influence of solar radiation on the earth's rotation. The fact established by Dr. Shettle, that the magnetic energy of a bar magnet acts along spiral lines has led him to surmise that the energy emanating from the sun and impinging on the earth on the zone of the ecliptic, traverses the earth in a spiral path and finally emerges at the magnetic poles. The spiral of energy is "right-handed" at one pole and "left-handed" at the other, like the magnetic force in a magnet and the electric discharge in Crookes' vacuum tubes. Like precession and nutation, these spiral paths are constantly changing and producing magnetic variations. He therefore infers that the magnetic poles will complete a cycle corresponding to the period of precession. Dr. Shettle thinks that bodies exhibit magnetic properties in proportion as they change the direction of the energy traversing them, and throw it into the spiral form. Terrestrial magnetism would be due to the solar radiance on this hypothesis. Gravity also would be produced; so likewise would the earth's rotation (by a kind of "magnetic whirl"), electricity, tornadoes, cyclones, water-spouts, and whirlwinds. Moreover this "spiral energy" would seem to operate throughout the whole universe.—Prof. Wiedemann, of Leipsic, made a communication on the phenomenon of interference in rays of long path, and showed how the phase of vibration of the atom or molecule emitting the rays influenced the phenomenon. Molecular collisions could operate in preventing interference. From a study of this question he was able to deduce a method of determining the pressure on the surface of the sun and stars. He mentioned that he had found that the temperature of a glowing gas in Geissler's tubes may be under 100° C., and therefore the light of the aurora or of comets might be accompanied by a low temperature. He had determined that the quantity of heat produced in a gas by the electric discharge was always the same, with the same amount of electricity, whether discharged at once or not, and that it increases nearly in proportion to the pressure of the gas. He had also determined that the heat which must be developed by a discharge in hydrogen in order to change the band spectrum of H into the line spectrum is about 100,000 calories for 1 gramme of hydrogen, and hence this might represent the amount of heat necessary to transform the hydrogen molecule into its atoms. Dr. Schuster suggested that Prof. Wiedemann should make a similar experiment with another gas, say nitrogen, as there was a disagreement about the spectra, and Prof. Wiedemann stated that he so intended.—Mr. Kidout exhibited a device for amplifying small motions. A small barrel is slung by two threads between the prongs of a metal fork in such a manner that if the fork is bodily carried to and fro the barrel will rotate round its axis. This is simply effected by making each thread, in its passage from one prong to the other, take a few turns round the barrel. To the barrel an index is attached, and the fork is then fixed on the body whose minute motion is to be indicated. The translation of the body shifts the fork and rotates the barrel, which in turn deflects the index round the face of a dial, and the magnifying power is expressed by the ratio of the diameter of the barrel to the length

of the index. With this apparatus Mr. Kidout exhibited the lengthening of an iron core when magnetised by the passage of the current of two Grove's cells through an insulated wire coiled round it. By riveting a slip of brass to the iron, the unequal expansion of brass and iron under heat was also shown, the heat being generated by keeping the current flowing in the coil.—Mr. D. Winstanley exhibited his new radiograph for recording graphically the intensity of solar radiation throughout the day. It consists of a differential thermometer with one black bulb and a circular stem. The lower part of the stem is filled with mercury, the upper branches with sulphuric acid and water. The tube is mounted on a brass wheel, so that when the black bulb is exposed to the sun's rays the differential motion of the mercury causes the wheel to turn. The wheel carries a light index or marker, which is free to traverse a vertical cylinder covered with paper coated with lampblack, and leaves a white track where its point has scratched off the soot. The radiogram thus produced can be fixed and preserved. Dr. Guthrie pointed out the curious "thermal twilight" these radiograms had betrayed to Mr. Winstanley. They show that before sunrise the temperature increases, owing to solar radiation. Moreover, half an hour after sunset the index falls and remains till within a few minutes of midnight, when it mysteriously rises and sinks again, although the sun is then directly over the opposite hemisphere.—Mr. Baillie then gave the results of a study he had made into the theory of the phonoscope. He finds that waves simultaneously start from each side of the soap-film when the note is sounded, and meeting in the middle generate ventral points and nodes. The equations of several cases were given by him, and he suggested that photography should be employed to fix the appearance of the figures, in order that they might be investigated theoretically.

Linnean Society, June 17.—Prof. Allman, F.R.S., president, in the chair.—Dr. R. C. A. Prior read a letter from a correspondent concerning the rare case of a mistletoe parasite on a mistletoe.—Lord Lilford exhibited and remarks were made on a series of skins, skulls, and horns of the Wild Sheep of Cyprus (*Ovis ophion*, Blyth).—Mr. E. M. Holmes pointed out the peculiarities of the Antheridia in an excellent example of *Polysiphonia fastigiata*, gathered at Ventnor.—Mr. F. Crisp exhibited slides prepared at the Zoological Station of Naples, illustrating the early stages of the life of invertebrates, and he also showed living specimens of the new Medusa, *Limnocoelum victoria*.—Mr. C. Stewart showed microscopic sections of the growing point of chara and of the common ash.—A paper was read by Mr. F. M. Campbell on certain glands in the maxillæ of spiders. These glands, to which he attributes a secretory function (probably salivary), he finds in *Tegeneria domestica* have apertures on the inner side of the upper face of each maxilla, thence inclining towards the mouth. They are ring-like in figure, with an inclosed disk. There are integumental folds at their outlets. The glands and apertures increase in number with age, and the ducts tend to become chitinous. Glands varying somewhat in structure, but evidently similar in kind, exist in species of Linyphiidæ, Theridiidæ, and the Epeiridæ.—Mr. S. O. Ridley made a communication on two cases of incorporation by sponges of spicules foreign to them. In a species of the genus *Ciocalypta*, Bwk., the dermis contained spicules which belonged to a species of *Esperia*, and which latter sponge had been obtained in the same haul of the dredge. In another example of *Alabion spicules* also derived from *Esperia* were likewise obtained. Thus an element of error might arise from one sponge containing skeletal structures accidentally derived from a neighbouring sponge of a different genus and habit.—Prof. Allman then called attention to the remarkable Medusa recently observed by Mr. W. Sowerby in the freshwater tank at the Botanic Gardens, Regent's Park (a notice of this appeared in our last week's issue, p. 178).—A short note from Prof. E. Ray Lankester concerning the same Medusa was also read.—Mr. F. M. Campbell read a second paper on the stridulating organs of *Stenotoda pustulata* and *Linyphia temericola*. A stridulating organ has already been described by Prof. Westring and Mason Wood in certain other of the spiders; the present observations demonstrate its existence in both sexes, and the essentials of the structure are given in detail.—Dr. G. E. Dobson, in notes on *Aplysia dactylomela*, a specimen obtained at Bermuda, but not distinguishable from the species inhabiting the Cape Verde Islands, showed that there is inequality of size in the right and left moiety in the dental sows of the lingual ribbon, and he described other structures appertaining to the mandibular plates.—Mr. G. Bask communicated some researches of

his on the Polyzoa collected in the late North Polar Expedition. Several interesting and new forms are given, while the author expressed himself in certain cases as differing in his determinations from Prof. Smitt of Stockholm.—A paper on the natural classification of the Gasteropoda (part 1), by Dr. J. D. Macdonald, was read. He refers to a communication of his published by the Society twenty years ago, wherein sexual characters, lingual dentition, and auditory concretions formed the basis of classification. With modifications this is now elaborated, and in certain groups additional value given to the lingual and labial dentition.—The sixth contribution to the mollusca of the *Challenger* Expedition, by the Rev. R. Boog Watson, was taken as read. The author treats of the Turritellidæ, and describes nine new species.—A paper by Sir J. Lubbock was read, namely, Observations on Ants, Bees, and Wasps, with a Description of a new species of Honey-Ant, an abstract of which appeared last week (p. 184).—The following gentlemen were elected Fellows of the Society:—The Rev. H. G. Bonavia Hunt, Trinity College, London; H. N. Moseley, F.R.S., University of London; the Rev. A. Merle Norman, Durham; and E. A. Webb, Turnham Green.—The President with a few parting words then closed the session.

Chemical Society, June 17.—Prof. H. E. Roscoe, president, in the chair.—The following papers were read.—On pentathionic acid, by T. Takamatsu and Watson Smith. The authors have examined the evidence for and against the existence of this substance; they conclude that it does exist, and give a new method of preparing it, by the action of a very strong solution of iodine in hydriodic acid upon lead theiosulphate.—Preliminary note on some orcinol derivatives, by J. Stenhouse and C. E. Groves. The authors have confirmed their previous conclusion that halogen derivatives of orcinol exist, containing 5 atoms of bromine, &c., both the hydrogen atoms in the hydroxyl groups being displaced.—On the determination of carbon in soils, by R. Warington and W. A. Peake. Oxidation with potassium permanganate gives 92 per cent. of the total carbon, but digestion with chromic acid, &c., only 79 per cent. The best method is combustion with oxide of copper in a stream of oxygen.—Note on camphydrene, by H. E. Armstrong. In this note the author sharply criticises a recent paper by Dr. Letts in the *Berlin Berichte*, and, as a result of some experiments, completely confirms the statement of Montgolfier that the substance formed by the action of sodium on the solid hydrochloride from turpentine oil is a mixture, and not a hydrocarbon having the formula  $C_{10}H_{17}$ , as asserted by Dr. Letts.—On the action of nitric acid upon diparatolyguanidin, by A. G. Perkin. Dinitrodiparatolyguanidin, melting at  $205^{\circ}$ , was obtained in red crystals, also, by a slight modification, dinitrodiparatolyurea, melting at  $233^{\circ}$ .—On some higher oxides of manganese and their hydrates, by V. H. Veley. The oxide was precipitated by chlorine from a pure solution of the acetate, and was then heated in a current of air, oxygen; hydrates,  $Mn_2O_{11}$ ,  $2H_2O : 2(Mn_2O_{11})3H_2O$ , and  $Mn_{11}O_{23}H_2O$  were obtained; but in no case was the dioxide formed.—On a new method of preparing dinitroethyllic acid, by E. Frankland and C. C. Graham. This consists in passing nitric oxide into a mixture of zinc ethyl and sodium ethyl, to which a suitable solvent such as benzine has been added.—On the action of organo-zinc compounds upon nitriles and their analogues, by E. Frankland and H. K. Tompkins. The action of zinc ethyl upon phenylacetanitrile is studied.—On the action of benzoyl chloride on morphine, by C. R. A. Wright and C. H. Rennie. The end result is always dibenzoyl morphine.—An examination of terpenes for cymene by means of the ultra-violet spectrum, by W. N. Hartley. The author has examined specimens of orange oil, French turpentine, and Russian turpentine, by photographing their absorption spectra; the first two oils were free from cymene, the last contains certainly less than 4 per cent.—Notes on the purple of the ancients, by E. Schunck. The author has examined a sample of the dye still used on the Pacific coasts of Nicaragua, and finds that it contains a colouring matter soluble in boiling anilin, having all the properties of punicin obtained by him from the *Purpura lapillus* of the British coasts.—The Society then adjourned over the summer recess.

Anthropological Institute, June 8.—Major-General A. Pitt-Rivers, F.R.S., vice-president, in the chair.—Mr. F. G. Hilton Price, F.G.S., read a paper on camps on the Malvern Hills; last September, having obtained permission from Lord Somers to excavate in any part of the camps on these Hills, he set his labourers to work, first on Hollybush Hill, on the

south side of the Malvern range, and afterwards on Midsummer Hill, both of which were encircled by a deep ditch and a rampart, while in the glen between the two hills on the south side was the site of a town about 1,100 feet in length. In the interior of the ancient camp on Hollybush Hill were many but hollows, some of which he opened, but without making any discovery. On the east face of Midsummer Hill were several lines of such hollows, which, like the rest, had been habitations, and no fewer than 214 had been counted. Along the ravines between the two hills were four tanks, having the ancient dams for holding back the water still in existence. The explorations of these camps were not very fruitful. More productive were the excavations on the Herefordshire Beacon Camp, one of the largest and strongest earthworks in the district. It had usually been looked upon as of British origin, and Mr. Price saw no special reason for doubting it. In one hut hollow much coarse black pottery was met with, and there were besides many bones of the ox, pig, horse, sheep, dog, some kind of gallinaceous fowl, and of the deer. A description was given of the huge block of syenite known as the "Divination stone." It was mentioned that in 1650 a jewelled gold crown or bracelet was found in a ditch at the base of the Herefordshire Beacon. Camden had written of it, and in a MS. said to belong to Jesus College, Oxford, it was stated to have been sold to a Gloucester goldsmith for 37*l.*, who sold it to a jeweller in Lombard Street for 250*l.*, who sold the stones alone for 1,500*l.* There were many traditions as to coins found there, but their dates were uncertain. Mr. Price thought this large camp, as well as those on Hollybush and Midsummer Hills, were of late Cymric or Celtic origin, that the latter camp was of earlier date than that on the Herefordshire Beacon, and that in all likelihood they were occupied by the Romano-British, as many remains of those tribes existed in the district, and the pottery seemed to date from that period.—A paper was read on religious beliefs and practices in Melanesia by the Rev. R. H. Codrington. The subject is a very difficult one, inasmuch as, the islands and dialects being so numerous, no one person's knowledge can well range over the whole. The author's information was chiefly derived from the Banks' Islands and the Solomon group, whence the most advanced scholars have come to the Melanesian Mission Station on Norfolk Island. Nothing is known to show that the Banks' Islands have been influenced by Polynesian immigration or neighbourhood; though there are still men alive who can remember a visit of double canoes from Tonga. The Banks' Islanders alone among Melanesians knew no cannibalism and wore no dress. The Banks' Islanders distinctly recognise two orders of intelligent beings different from living men; they believed in the continued existence of men after death in a condition in which they exercised power over the living; and they believed in the existence of beings who were not and never had been human. The latter are called Vuis, and are divided into two great classes, corporeal and incorporeal. The most conspicuous amongst the first class is Qat, the legends concerning whom correspond to those which prevail among the Maories and other Polynesian people concerning Maui or Tangaroa. The brothers of Qat have all of them the name of Tangaroa, and the Vuis of the northern New Hebrides have the same name, which is also applied in Banks' Islands to stones used as fetishes or amulets. The story of Qat's disappearance from the island bears a close resemblance to that of Noah and the Flood, and has possibly been embellished since the Bible history has been made known among the natives. Of the same order of beings with Qat and his brothers, though looked upon as very inferior, are certain Vuis, having rather the nature of fairies. Some of these are called Nopitu, which come invisibly, or possess those with whom they associate themselves. The possessed are themselves called Nopitu. Such persons would lift a cocoa-nut to drink, and native shell-money would run out instead of the juice, and rattle against their teeth; they would vomit up money, or scratch and snake themselves on a mat while money would pour from their fingers. This was often seen, and believed to be the doing of a Nopitu. The story of the bringing of death into the world is remarkable, because it is told without any variation in the Solomon Islands and Banks' Islands alike. At first men never died, but when advanced in life they shed their skins like snakes or crabs, and came out in renewed youth. An old woman went to a stream to change her skin, and let the old one which she had shed float away till it caught against a stick. She then went home, where she had left her child; the child refused to recognise her, and, declaring that she was another

persons could only be pacified by the woman returning for her lost-off integument and putting it on again. From that time man-kind have died. The Vuis, which are incorporeal and have nothing like a human life, have a much higher place than Oat and his brothers in the common religious system of the Banks' Islanders. They have no names, no stories are told of them, and they have no shape, but they are numerous, and are present and powerful to assist men who can communicate with them. They are very generally associated with stones, snakes, owls, and sharks. Communication with these Vuis is not in the power of all, but there is an order of priests. If a man has his stone or his snake, by means of which he supposes that he can obtain favours from his Vui, he will instruct his son or some one else to take his place. No other sacrifice than that of the shell money in common use seems to be offered in Banks' Islands. The great institutions of the Banks' Islands are the Suge and the Tamate. Neither has a religious character, nor is any superstitious practice necessarily connected with them. The Suge is a club, the house belonging to which is the most conspicuous building in every village, and is to be found wherever there is a permanent habitation; this house, or "gamal," has many compartments, each with its own oven, in accordance with the several grades in the society. To rise from one grade to another money has to be given and pigs killed. The authority of the men highest in the Suge is very considerable, and it is these persons who appear to traders and naval officers as chiefs. The Tamate is a secret society, to which entrance is obtained by payment, and the neophyte has to spend many days in the Salagoro, or sacred place; the only secret, however, is the making of the masks and hats in which the members appear in public and the way of producing the sound which is supposed to be the cry of the ghosts. The members of the great Tamate indulge in much licence. When they choose to go abroad to collect provisions for one of their feasts, the women and uninitiated are obliged to keep away from their paths. The warning voice of the Tamate is heard, and the country is shut up.

PARIS

**Academy of Sciences, June 21.**—M. Edm. Becquerel in the chair.—The following papers were read:—On the reduction of pendulum observations to the sea-level, by M. Faye. Some deductions are here made from principles he lately enunciated.—On effects of reversal of photographic images by prolongation of the luminous action, by M. Janssen. After a certain time of exposure a less distinct negative image is had, and with continued exposure this image quite disappears, and a positive one is obtained, which may be quite as distinct as the first. This was the case, *e.g.*, in photographing the sun at Meudon, when plates that had been exposed  $\frac{1}{100}$  of a second, or even  $\frac{1}{1000}$  of a second (gelatino-bromide plates) were exposed half a second or a second. The sun's disk appeared white, the spots black. Similarly, positive images of landscapes, &c., were obtained. The same spectral rays give first the negative image, then the positive.—On the heat of formation of oxides of nitrogen and of those of sulphur, by M. Berthelot. The discrepancies of former observations on oxides of sulphur are here accounted for chiefly by a simultaneous formation of several degrees of oxidation of sulphur, and perhaps even the presence of water-vapour. The author's own experiments lead to the result that  $S + O_2 = SO_2$ , gas liberates + 34.63.—On the luminous spectrum of water, by Dr. Huggins.—Proportion of carbonic acid in the air; reply to M. Marié-Davy, by M. Reiset.—New meteoritic mineral, with a complement of information on the fall of meteorites observed in Iowa, in May, 1879, by Prof. Lawrence Smith. The formula he now gives for the mineral (indicated at the  *séance*  of April 26, 1880), is  $SiR + \frac{1}{2}(Si, 2R)$ , or perhaps more exactly  $2SiR + Si, 2R$ , which represents 2 at. of enstatite or bronzite united to 1 at. of olivine. The name of *Peckhamite* is proposed (after Prof. Peckham). On the border of Emmel and Dickson Counties some 3,000 fragments were found within a radius of 13 km.; their total weight 30 kg. Though they had lain nearly a year under water (submerging a prairie), there was not a trace of oxidation. Prof. Smith thinks this may have been due to a thin invisible coating of silicates.—Employment of bitumen of Judæa against diseases of the vine, by M. Schefer.—Report on Mr. Peirce's memoir concerning the constant of gravity at Paris and the corrections required by old determinations of Borda and Biot. The length of the simple pendulum determined by Peirce with his own apparatus is 993'934 mm., alt. 74 m. (Biot 993'913 mm., same alt.; Borda 993'918 mm.,

alt. 67 m.)—On the problem of invention, by Mr. Elliot.—On an apparatus for registering the law of motion of a projectile, either in the bore of a gun or in a resistant medium, by M. Sebert. A metallic smoked rod, of square section, is fixed in the axis of the projectile, and serves as guide to a small mass carrying a small tuning-fork furnished with two metallic points, which leave undulating traces on the blackened surface; as the projectile moves along (the prongs of the fork being liberated from a constrained state, and set vibrating, when the motion of the projectile commences). From the tracing may be deduced the velocities acquired and the accelerative force in function of the time; also the law of the pressures developed.—On the transcendents which play an important part in the theory of planetary perturbations, by M. Darboux.—On the method of Cauchy for the development of the perturbative function, by M. Trépied.—On linear differential equations with an independent variable, by M. Appell.—On certain linear differential equations of the second order, by M. Picard.—On elliptic functions, by M. Farkas.—On some modifications in the construction of the Bunsen lamp and of monochromatic lamps, by M. Terquem. There are no lateral apertures, and the air is admitted between the foot of the lamp and the bottom of the tube, which is raised somewhat (6 to 7 mm.). A cross plate divides the orifice into four parts. The temperature is found nearly uniform from the upper point of the flame to the top of the green cones, and from the centre to the circumference. (An analysis of the gases drawn off is given.) This flame is variously superior, and it gives, with sodium, *e.g.*, a much more intense monochromatic flame.—On the flow of gases, by M. Neyreneuf.—On the etherification of bromhydric acid, by M. Villiers. *Inter alia*, the limit of etherification is not equal to that corresponding to organic acids, and it rises with the temperature. Etherification ceases in mixtures containing a certain proportion of water. The limit of dilution from which etherification ceases rises with the temperature.—On the hydrate of iodide of methyl, by M. de Forcrand.—On the artificial reproduction of analcime, by M. de Schulten. The process consists in heating in a closed vessel at 180° to 190°, a solution of silicate of soda or caustic soda in presence of an aluminous glass.—Presence and special character of oyster-marls of Carnetin (Seine-et-Loire), by M. Meunier.—Prevision relative to the amount of current water in the valley of the Seine during summer and autumn of the present year, by M. Lemoine. The Seine between Paris and Rouen, with its large affluents, is expected to present one of those serious and prolonged diminutions of volume which occurred in 1863, 1868, and 1871, but no extraordinary drought.—On the geological constitution of the Isthmus of Panama, with regard to the execution of the inter-oceanic canal, by M. Bouter.

CONTENTS

	PAGE
THE SACRED BOOKS OF THE EAST. By Prof. A. H. SAYCE . . . . .	189
EVOLUTION OF THE VEGETABLE KINGDOM. By W. B. HEMSLEY . . . . .	190
LETTERS TO THE EDITOR:—	
The Freshwater Medusa.—Prof. E. RAV LANKESTER, F.R.S. . . . .	190
Aqueous Vapour in Relation to Perpetual Snow.—Dr. JAMES CROLL, F.R.S. . . . .	191
Artificial Diamonds.—R. MALLET, F.R.S. . . . .	192
A Fourth State of Matter.—S. TOLVER PRESTON . . . . .	192
Auroral Observations.—Prof. SOPHUS THOMHOLT . . . . .	192
The Hydrographic Department.—LIEUT. GEORGE T. TEMPLE, R.N. . . . .	192
Curious Electric Phenomenon.—F. T. MOTT . . . . .	193
Meteor.—W. ODELL . . . . .	193
Minerva Ornaments.—Prof. E. W. CLAYTON . . . . .	193
A Snake in Kensington Gardens.—J. HARRIS STONE . . . . .	193
THREE YEARS' EXPERIMENTING IN MENSURATIONAL SPECTROSCOPY By Prof. PIAZZI SMYTH . . . . .	193
EXPERIMENTAL RESEARCHES IN ELECTRICITY. By WARREN DE LA RUE, M.A., D.C.L., F.R.S., and HUGO W. MÜLLER, Ph.D., F.R.S. (With Illustrations) . . . . .	196
THE LATE M. GAUGAIN . . . . .	198
A CHAPTER IN THE HISTORY OF THE CORIPIRE, By J. STANKIN GARDNER . . . . .	199
ON SOME POINTS CONNECTED WITH TERRESTRIAL MAGNETISM. By Prof. BALFOUR STEWART, F.R.S. . . . .	200
NOTES . . . . .	202
OUR ASTRONOMICAL COLUMN:—	
The Third Comet of 1880 . . . . .	205
The Double-Star $\delta_5$ Pegasi . . . . .	205
A Variable Star in Aquarius . . . . .	205
A Variable Star in Aquarius . . . . .	205
GEOGRAPHICAL NOTES . . . . .	206
PHYSICAL NOTES . . . . .	206
PHYSICAL SCIENCE IN RUSSIA . . . . .	207
SEISMOLOGY IN JAPAN. By HANS JUNGE MÜLLER . . . . .	208
UNIVERSITY AND EDUCATIONAL INTELLIGENCE . . . . .	208
SCIENTIFIC SERIALS . . . . .	209
SOCIETIES AND ACADEMIES . . . . .	209



THURSDAY, JULY 8, 1880

### THE TAY BRIDGE

THE Report of the Court of Inquiry appointed to investigate the circumstances of the fall of the Tay Bridge last December has now been made public. There appears to be some difference of opinion amongst the members of the court respecting the scope of the inquiry and the duties placed upon them by the Board of Trade, in consequence of which two separate reports appear together, one by Col. Yolland, Chief Government Inspector of Railways, and Mr. Barlow, President of the Institution of Civil Engineers, and the other by Mr. Rothery, the Wreck Commissioner. The former report describes in detail the design and method of erection adopted in the bridge, giving also a description of the various alterations in the plan which were rendered necessary as the work progressed.

The bridge was 3,465 yards in total length, divided into 86 spans, and it was the central portion, of 3,149 feet in length, which fell on the evening of December 28. As originally designed, this central portion was to consist of lattice girders of 200 feet span, carried by brickwork piers somewhat over 80 feet in height from high-water level, but as the river bottom turned out to be different from what was expected from the borings, and the difficulty of obtaining a secure foundation greater, eleven spans of 245 feet and two of 227 feet were substituted, and braced iron piers were adopted in the place of brickwork, as imposing a less weight on the foundations. It is these piers which at the inquiry chiefly received attention, as there can be little doubt that they were the immediate cause of the catastrophe. The process of floating out and sinking the caissons for these piers has already been described in these columns, and so successfully was this—certainly the most difficult and hazardous part of the undertaking—accomplished, that no suggestion of insufficient strength has been made, and in the Report it is stated that there is nothing to indicate any movement or settlement in the foundations of the piers which fell.

The caissons were lined with brickwork and filled with concrete, on which was built a hexagonal pier of masonry carried up to 5 feet above high-water mark. Upon this pier was built up six cast-iron columns secured by holding-down bolts to the masonry at the angles of the hexagon. The columns were made up of lengths united by flanges and bolts, and connected with each other by horizontal struts and diagonal ties. The up-stream and down-stream columns were each 18 inches in diameter, the remaining four, 15 inches; all were inclined 12 inches inwards at the top. The piers thus formed were from 81 to 83 feet in height from the top of the masonry to the under-side of the girders. The diagonal bracing consisted of flat bars attached to the columns by means of "lugs" cast on them, being secured at one extremity by a screw-bolt passing through the lugs and bar, and at the other by a strap provided with a gib and cotter for tightening up. The horizontal struts consisted of two channel-bars bolted back to back to a single lug on each column.

It will thus be seen that all vertical load must be borne entirely by the columns, and with the exception of the

small transverse resistance of the latter the whole of any lateral pressure must be transmitted to the bracing.

Whether as designed the bridge would have been strong enough for its work if the materials and workmanship had been good throughout is very doubtful, but, as carried out, the evidence shows distinctly that it was not sufficiently substantial for the heavy traffic and severe gales to which it was exposed. When everything was tight and in good order the bridge, at the time of its inspection by General Hutchinson in February, 1878, showed great rigidity under the tests imposed by him, but by October of the same year so much slackness had made its appearance in the bracing that, besides the ordinary keying-up by driving the cotters, more than 100 packing-pieces about three-eighths of an inch thick had to be introduced in different parts.

Respecting the immediate cause of the accident the Court states—"In our opinion the weight of evidence points out the cross bracing and its fastening by lugs as the first part to yield." This we believe the calculations of Dr. Pole and Mr. Stewart, taken in connection with the experiments of Mr. Kirkaldy, are quite sufficient to establish. With a wind pressure of 30 lbs. to the square foot on the windward girder and train, and half this amount on the leeward girder, the stress on the tie-bar most severely strained, would be 16·8 tons, or 10·18 tons per square inch; again, with a wind pressure of 40 lbs. to the square foot the stress on the tie-bar would be 22·4 tons. Now, as Mr. Kirkaldy's experiments, made by order of the court on some of the tie-bars removed from the bridge, showed that they broke with a load of from 19 to 23 tons, and the corresponding lugs with a load of 23 to 25 tons, it is pretty certain that the ultimate strength of this part of the structure would be reached by a wind pressure of 40 lbs. to the square foot. And in addition to this more variation is to be expected in the strength of the lugs, as some at least were admitted to be of bad manufacture, and when the pier was most severely strained it would be some of the worst lugs in the lower tiers that would be the first to yield; thus the samples taken for testing would not be likely to embrace specimens of the lowest strength, as these would probably have already given way.

Again, it does not appear necessary to assume a wind pressure of 40 lbs. per square foot to ensure the destruction of the pier; the stresses above mentioned are due merely to the statical pressure, and it can hardly be denied in the face of the evidence respecting the details of the structure that there would be a great deal of motion due to backlash over and above the elastic yielding of the material. Thus a much lower pressure would produce the effects calculated for one of 40 lbs. per square foot.

The principal conclusions arrived at by the court are that there is no indication of settlement in the foundations, that the wrought iron employed was of fair strength, though not of high quality as regards toughness, that the cast iron was fairly good, that the main girders were of sufficient strength, and that the iron piers, though strong enough to sustain the vertical load, were insufficient to resist the lateral action of heavy gales from the weakness of the cross bracing and its fastenings; that the railway company did not enforce the recommendation of General Hutchinson by limiting the speed of trains over the

bridge to twenty-five miles per hour, much higher speed being frequently run; that while of opinion that the fall of the bridge was occasioned by the yielding of the cross bracing and fastenings, it might possibly have been due to the fracture of one of the outward leeward columns.

Col. Yolland and Mr. Barlow conclude by stating "that there is no requirement issued by the Board of Trade respecting wind pressure, and there does not appear to be any understood rule in the engineering profession regarding wind pressure in railway structures; and we therefore recommend that the Board of Trade should take such steps as may be necessary for the establishment of rules for that purpose."

Mr. Rothery, in his independent report, while stating that there is an entire agreement between himself and his colleagues in the conclusions arrived at from the evidence, goes further than them, and unhesitatingly apportioning the blame among the different parties concerned. On the recommendation that the Board of Trade should establish rules providing for wind pressure, he differs from his colleagues, emphatically stating that it is for the engineering profession to make them, and evidently regards the superficial character of an official inspection as no great evil.

Where French engineers have long adopted 270 kilogrammes per square metre, and many English engineers, on the authority of Rankine, the equivalent 55 lbs. per square foot, while nearly the same figure is used in America, it seems strange that so much difference of opinion should be found to exist; but one thing at least is certain, that the instruments at present in use for measuring wind pressure are exceedingly crude and liable to error, and that until these are improved and much increased in number there is little chance of being on the spot when these excessive pressures occur, or of truthfully recording them when met with.

Respecting the transfer of these responsibilities to a Government Department, we believe that such apron-string policy would be fatal to the profession of the civil engineer; we would rather see the Board of Trade Inspection, which at least is formal and superficial, relaxed than any attempt made to increase its efficiency. The medical profession does not require a fatherly department to watch over its operations or give an opinion on an amputation; why then should the engineering profession? It cannot be too clearly understood that an engineering work cannot be successfully carried out by mere rule of thumb or even by the copious use of "Molesworth" or "Rankine"; each operation is to some extent a physical experiment subject to known laws, but under variable conditions. The physicist and the engineer have already to a great extent established the laws for him, but it remains for the scientific engineer to carefully watch their operation, and thus gain that practical experience which will enable him to deal with each special case as it arises.

The conclusions we draw from the evidence and report are that the design of the piers was most imperfect, cheapness appearing to be the ruling element in every detail, a cheapness too that must have been completely delusive, as any money saved in first cost would soon, in such a rickety structure, have been swallowed up in maintenance. At nearly all points an absence of consideration for small details is most apparent, indicating probably that these were intrusted to some subordinate, who failed to appreciate their importance.

It is very far from our object in this article to hold up any particular individuals to blame for this disaster, but we should like to point out on whom the responsibility should rest if such a thing should occur again.

It would be quite impracticable for the Board of Trade to exercise such supervision over the selection of the material and the execution and erection of a large work throughout its progress, as would render its certificate of any value; we believe, therefore, that the undivided responsibility should rest on the engineer. Any dishonesty on the part of the contractor or his workmen,—and we are sorry to believe this still exists in some cases,—could be easily rendered hazardous by legal penalties.

Doubtless with the keen competition of the present day things must be "cut finer" than they used to be; but while we would remove any arbitrary restrictions imposed by Government on the judgment of those who ought to be best able to appreciate the particular conditions of their own work, we should be very sorry to see the introduction of flimsy structures or reckless traffic arrangements without it being clearly understood on whom the responsibility rested in case of failure.

#### CAMPS IN THE CARIBBEES

*Camps in the Caribbees. The Adventures of a Naturalist in the Lesser Antilles.* By F. A. Ober. (Boston, U.S.: Lee and Shepherd; Edinburgh: Douglas, 1880.)

THE author of this lively and very entertaining book of travel undertook in 1876 the exploration of the Caribbees or Lesser Antilles, which islands extend over eight degrees of latitude between Porto Rico and Trinidad, connecting the Greater Antilles with the continent of South America. The islands had been hitherto little visited by naturalists, and the author made his expedition under the auspices of the Smithsonian Institution, with the especial object of collecting the birds of the group.

Around the borders of each island there is a cleared belt of fertile land, and on the coast often large villages and towns, whilst the interior is one vast forest covering wild hills and mountains. It was in the forests that the author's work lay. He took his camera into the mountains with him and photographed everything of interest which he met with, and the book is illustrated by numerous wood engravings of remarkably fine quality taken from the photographs and his sketches. About half the book, which is an octavo of 350 pages, describes adventures in the island of Dominica. Barbuda and Antigua were visited, but are not referred to at length. The account of the islands of St. Vincent, Grenada, Guadeloupe, and Martinique compose the remainder of the work, together with a catalogue of the birds of the group and descriptions of the sixteen new species of birds discovered.

Dominica was so named by Columbus, who happened to hit off the Lesser Antilles on his second voyage, because he sighted the island on a Sunday, November 3rd, 1493. The island is most beautiful. The hills are broken and ragged, seamed, furrowed, and scarred, yet covered with a luxuriant vegetation of every shade of green—purple of mango and cacao, golden of cane and lime—whilst the ridges are crowned with palms, and behind Roseau, the capital, rises Lake Mountain, four thousand feet in height, five miles distant from the town, yet seeming to overshadow it.

Mr. Ober started forthwith for the mountains, and

settled himself in a cabin in the midst of the forest amongst the mountaineer population, which is of mixed race, partly negro, partly, Carib, partly European. Here the mountaineers' children waited on him, and brought him beetles and snails and humming-birds, which they caught with birdlime. But he had to dispense with their services, for they brought him far too many things of one kind, and especially huge land-crabs as big as a man's hand. He had incautiously remarked that he should like a specimen of this crab, which abounds in the ravines and rivulet banks. "Each boy and girl in the place resolved to be the first to furnish me with the coveted crab. The consequence was that my place was soon overrun with shell-fish—ugly red and yellow crabs, as large as a man's hand, and from that to the most diminutive. One of the girls in a mischievous mood brought in a crab with a family of little ones, over a hundred, just large enough to be seen, and let them loose on the floor. Through some open window, while I was absent, some giant crab would be dropped on the floor to await my arrival. This was not done in a spirit of mischief, but from an earnest desire to aid me in my labours. For a week I could not stir without coming in contact with a shelly creature. I could not put my foot out of bed without a shudder of apprehension. Of nights I would be awakened by the rattling of ale-bottles, and arising, would discover that some crab had got thirsty in the night and had inserted a claw, which had caught in the neck of a bottle." In the afternoon the author sat looking out through the loophole of this cabin, which served as a window, and surveyed the peaceful Caribbean Sea, with the same vessels to be seen sometimes becalmed under the lee of the Caribbee Islands day after day. The sea is, however, not always placid; in the "hurricane season" it rises in its wrath. It is disturbed, however, only by a hurricane; nothing less. In the mornings and evenings he explored the beautiful forests and streambeds around his camp, gun on shoulder, and collected all he could find. Sometimes on these excursions he had merry companions, laughing girls combining Carib, French, and negro blood in their veins, and full of life and fun. Let us follow him with Marie and her friend in search of crayfish (we presume a species of *Palæmon*, the author unfortunately does not state). "The path is slippery, and we shall need a help from 'Marie's' hand, for the way leads up hill and over rocks wet and smooth, whilst wet leaves flap in our faces and creeping ferns and trailing plants hang on our feet as we go.

"We reach the river, the stream that flows out of the mountain lake, broad and with gravelly beach, with immense boulders as islands, and a wall of vegetation on either side that rises straight up a hundred feet. Here the two girls made into the stream in search of crayfish. The stream is broad with deep pools, and in these the crayfish lurked, looking like miniature lobsters in the clear water. We can see only the small ones, but Marie assures us that there are large ones out of sight beneath the cascades.

"Erect upon a rock she stood for a moment, then plunged head foremost into a foaming pool, disappearing from sight. A moment later rising bubbles preceded a round little head, from which hung long limp tresses;

a pair of shoulders brown and bare, and round arms and little hands reaching out for a support. She had a crayfish in each hand, and another with wriggling legs in her mouth."

The following is an account of the method in which humming-birds are caught:—"Let us follow little Dan, the oldest and sharpest of the humming-bird hunters, as he goes out for birds. First he goes to a tree called the mountain-palm, which replaces the cocoa-palm in the mountains, the latter growing only along the coast. Beneath the tree are some fallen leaves fifteen feet in length; these he seizes and strips, leaving the midrib bare, a long slender stem tapering to a point. Upon this tip he places a lump of bird-lime, to make which he had collected the inspissated juice of the bread fruit and chewed it to the consistency of soft wax. Scattered over the Savanna are many clumps of flowering bushes, over whose crimson and snowy blossoms humming-birds are dashing, inserting their beaks in the honeyed corollas, after active forays resting upon some bare twig, pruning and preening their feathers. Cautiously creeping toward a bush upon which one of these little beauties is resting, the hunter extends the palm-rib with its treacherous coating of gum. The bird eyes it curiously but fearlessly as it approaches his resting-place, even pecking at it; but the next moment he is dangling helplessly, beating the air with buzzing wings in vain efforts to escape the clutches of that treacherous gum."

Mr. Ober tried hard to keep humming-birds alive, but, as usual, without success. They never survived many days. If exposed to the light they kept up a constant fluttering, until the muscles of their wings became so stiff they could not close them, but expired with the wings widely outstretched. "Every morning I would introduce into the cage a bough of fragrant lime-blossoms, at which they would all dash instantly, diving into the flowers with great eagerness. Sugar dissolved in water and diluted honey was their favourite food, and they would sip it greedily. Holding them by their feet I would place their beaks in a bottle of syrup, when they would rapidly eject their tongues and withdraw them, repeating this operation until satisfied. They never displayed fear, but would readily alight on my finger and glance fearlessly up at me, watching an opportunity, however, for escape."

The boiling lake of Dominica was visited and photographed by the author. It was remarkably quiet during his visit, showing only a slight movement in the centre. The margin showed traces of the recent subsidence of the water-level, and on the following day the water had risen again somewhat, and was more active. It appears that the ebullition must be intermittent, but Mr. Ober did not see it in full action, though the water rose further, and the disturbance and noises continued to increase. The temperature of the water was only 96° F., though Dr. Nicholls, one of the party who discovered the lake, found it at 196° F., and Mr. Prestoe, of the Botanic Gardens of Trinidad, from 180° to 190°. The author follows Mr. Prestoe in the expectation that by the widening and deepening of the outlet the lake will disappear in time, and a geyser alone remain. In a boiling spring hard by the author and his guides cooked their supper of wild yams and eggs, and, as usual, cold water for drinking was found also close at hand.

An interesting account of the Caribs of Dominica follows. They have allotted to them a reservation extending from Mahoe River to Crayfish River, a distance of about three miles along the Atlantic coast and away back into the mountains as far as they please to cultivate. Though each family has a little garden near the house, all the "provision grounds," where staple articles of food are grown—yams, sweet potatoes, cassava, bananas, and taro—are at a distance from the houses, some even two miles away—solitary openings made in the depths of the high woods. The Caribs are especially interesting as being the earliest American savages met with by Columbus, the original "cannibals," and the race to which Caliban and Man Friday belonged. They seem somewhat addicted to drinking now, for the author describes the old King George the Third as seen tottering towards the plantation with a sovereign he had earned in his hand to spend it in rum. A lot of drunken Caribs tried to break into the author's house one night for amusement, and not being able to do that, poked a lot of fireflies in at the cracks to light up the inside, and see for certain whether he was at home—a very neat way of lighting up an interior. The general account of the Caribs is well worth reading.

We cannot follow the author in his exciting hunt after the souffrière bird, which lives only about the crater of the island of St. Vincent. The wary bird when at last procured proved to be of a new species, *Myadestes sibilans*. In Antigua he was victimised by the well-known "jigger." "I awoke one morning with an itching of my toes, which frequent rubbing failed to allay, and examination revealed four white tumours. They were as large as peas, and in the centre of each was a little black speck. I called my boy William, who at once pronounced them jiggers." The first old negress passing was called in, and turned them out of their nests with an adroitness which showed long practice. "A few hours are sufficient to give the jigger a hiding-place, and as the sensation he causes is a rather pleasant itching only for a time, he is sometimes not discovered till a painful sore is formed."

At Dominica the author met with Dr. Miroy, a friend and correspondent of Sir Joseph Hooker, and who is endeavouring, through the aid of the Kew establishment, to re-introduce the cultivation of coffee into the island. He is cultivating Liberian coffee, in the hope that it will prove able to withstand the attacks of blight which ruined the former crops forty years ago.

In Grenada the author hunted the monkeys which abound there as at St. Kitts, having been of course introduced, and having run wild, as explained in a series of letters in NATURE some months ago. He could not, however, make up his mind to shoot one when it came to the point. The monkeys are a great pest, and do great damage to the cultivator, just as in St. Iago, Cape Verde Islands, on the other side of the Atlantic, where also they were doubtless introduced, though it is not as yet known what the species is.

The book ends with an account of an ascent of the Guadeloupe Souffrière. It is throughout entertaining and highly amusing, but the author is evidently not very deeply versed in natural history, and there is often to be noted a lack of precise information, as in the case, for example, of the crayfish, cited above. The account of the land-crabs is somewhat conflicting. At one place we read of a

mother-crab, with 100 tiny young, found ~~in~~ in the mountains, at another, where the author falls in with an army of land-crabs on their combined march to the sea; he tells us that they bury their eggs under the sand, where they are hatched, and soon after millions of the new-born crabs are seen quitting the shore and slowly travelling up the mountains.

The story which he tells of the habits of the huge Hercules beetle, *Dynastes hercules*, can hardly be accepted as it is by the author on the authority of his dusky guide. It is that the male beetle seizes a small branch of a tree between its enormously long nippers and buzzes round and round the branch till this is cut off, producing a knife-grinding sound, supposed by the author to be a sexual call. He heard a knife-grinding noise indeed, but he did not see the rotating beetle. We recommend the book to all our readers.

*A NEW ENGLISH TEXT-BOOK OF BOTANY*  
*An Elementary Text-book of Botany.* Translated from the German of Prof. K. Prantl. Revised by S. H. Vines, M.A., D.Sc., F.L.S. (London: Sonnenschein and Allen, 1880.)

THIS text-book, we are informed in the English preface, "was written by Prof. Prantl, to meet a growing demand for a work on botany, which, while less voluminous than the well-known work of Sachs, should resemble it in its mode of treatment of the subject, and serve as an introduction to it." While we already have in English many text-books for students, one indeed almost professedly taking the same line as this, every teacher must have felt how inadequately they supply the needs of the class for which they have been written. Most are new editions of books written first twenty years ago or more, and suffer from the impossibility of introducing those new facts which have so deeply modified our present standpoint, without damaging the symmetry and unity of a well-written work; and others, of more recent origin, are badly compiled or over-concentrated. The book before us, avoiding these faults, will unquestionably take a high place at once; for though using Sachs as his storehouse, the author has digested the strong meat of the big book, and here provides his readers with the milk suited to their years. Moreover, the book is singularly well-balanced in all its parts, and clearly-written throughout. The translation is so flowing that no reader unformed of the fact would guess that German was the original dress; and Mr. Vines has added to the value of the work by appending a table, in which the classification there adopted is compared with that of Bentham and Hooker.

A reference to those knotty points to which one always looks at once as tests of successful treatment has proved so satisfactory that it is with regret that we turn to the ungracious task of pointing out the deficiencies that will somehow creep into the most carefully-written book. In several points Prantl has followed Sachs too closely, so that the accounts of cell-division, of the morphology of the pollen-grain and ovule, of the growing-point of Phanerogams, are all far behind our present knowledge. Again, in the treatment of "Modes of Branching," Sachs has been followed rather than Hooker, who, despite his complex sentences, gives a much clearer exposition.

Thus Sachs is copied even to including the cyme in *monopodial* systems. Surely this is a contradiction in terms, and might be avoided by the use of "lateral," in contradistinction to "dichotomous." In the figures (17, 19) of uniparous cymes, Sachs, and with him Prantl, omit to mention that the diagram is taken in *plan*, a point the more important that in French and English text-books it has been usual to give such diagrams of inflorescence in *elevation*. Without noticing this, a trap is laid through which not students alone have fallen into the error of thinking that the Germans use "scorpioid" and "helicoid" in senses inverse to the usage of other botanists. Under inflorescence no mention is made of the very useful French "Cymobotrya" terminology, possibly through feelings of patriotism, with which, however, Englishmen are not concerned. The Elder is given as the example of a corymb; which term is, however, restricted by the best botanists to the corymbose *raceme*, of which the elder is not an example.

In the histology there are several not unimportant errors, probably Prantl's own. He says that the phloem contains both "phloem parenchyma" and "cambiform tissue"—is not phloem parenchyma always (primitively at least) cambiform? We are told (p. 51) that the vessels of secondary wood are "invariably provided with bordered pits;" this is far too absolute. Under collenchyma no mention is made of its commoner form, distinguished as "concave" by Vesque. Endoderm is defined as peculiar to Dicotyledons! Under "stomata" no mention is made of water-pores. The account of the structure of roots and the development of their secondary wood in Dicotyledons is hardly explicit enough, and almost demands the introduction of one or two pure diagrams; and when it is stated that rootlets arise in front of the xylem bundles of the root, mention should be made of such important exceptions as Umbellifers and Grasses.

The physiology proper is singularly well treated, though perhaps with too great a fear of detail. Thus no sufficient account is given of the *vis a fronte* and the *vis a tergo*, which lead to the movements of the rising sap.

A few little mistakes have been left uncorrected in the systematic part. The legume is stated on p. 197 to occur in "all the Leguminosæ;" and while this is modified in the account of the order on pp. 278-280, a true legume is here implicitly denied to the Cæsalpinieæ! "Replum" is given as meaning a false-dissepiment of the Crucifers, a use unauthorised by the best systematists, and inconsistent alike with its application to the lomentaceous Leguminosæ and to its Latin signification.

The figures are good, but, as usual in English editions of foreign works, poorly printed. The worse fault of separating them widely from the text they illustrate has been avoided.

Finally, despite all trouble taken by the editor, oversights will occur in a translation. Thus *Tüllen* is given in italics without its English (?) equivalent, "tyloses," and "bracteole" is given instead of the more familiar "bractlet." But these blemishes show how good is the book in which they are the worst to be found; they have here been put forward chiefly in the hope of helping the editor in the new edition which will soon be demanded; and with a safe conscience that we would recommend this book as the best of its kind in the English language.

## LETTERS TO THE EDITOR

[The Editor does not hold himself responsible for opinions expressed by his correspondents. Neither can he undertake to return, or to correspond with the writers of, rejected manuscripts. No notice is taken of anonymous communications.]

[The Editor urgently requests correspondents to keep their letters as short as possible. The pressure on his space is so great that it is impossible otherwise to ensure the appearance even of communications containing interesting and novel facts.]

### Ocean Circulation

THE notice in NATURE (vol. xxii. p. 207) of the experimental researches of Professors Houghton and E. Reynolds on the coefficient of friction of water upon water, having concluded with the statement that "the authors of this research point out that these results tend to negative the theory of Dr. Carpenter that the phenomena of ocean-circulation are due to the greater height of the water at the equator as compared with that at the poles," I must be allowed to protest against being credited (or rather discredited) with a doctrine which is neither expressed nor implied in anything I have written on the subject.

The doctrine which I have advocated is no other than that first distinctly promulgated by Lenz in 1847, and now accepted by numerous Physicists of the highest eminence, both British and Continental; viz., that besides the *horizontal* circulation produced by the action of winds on the ocean-surface, there is a *vertical* circulation of which Polar cold is the *primum mobile*, consisting of an *underflow* of Polar water (chiefly from the Antarctic area) towards and even beyond the Equatorial zone, and a complementary *upper-flow* of Equatorial water towards the Poles.

That every part of the vast Oceanic basin in free communication with either of the Polar areas is occupied, to within the range of the surface-heating produced by insolation,<sup>1</sup> by water which has been cooled down in one of those areas, is now one of the best-established facts of Terrestrial Physics. And those who cannot find in the excess of specific gravity imparted to sea-water by Polar cold, an adequate cause for this movement of translation, are bound to account for it in some other way.

I venture to submit to the accomplished professors of Trinity College, that laboratory experiments made to determine the friction of water upon water at *sensible velocities* can scarcely prove that when the equilibrium of a great mass of water has been disturbed, there will *not* be any movement of translation (however slow) for its recovery. And I would suggest to them that they should rather investigate the conditions of one of those "experiments ready prepared for us by Nature," which is constantly going on in the Baltic Straits, and of which the results have been for many years past most carefully recorded by Dr. Meyer of Kiel and his associates. Four factors are there in continually varying action, viz. (1) difference of *level* between Baltic and North Sea water; (2) difference of *salinity*; (3) difference of *temperature*, mainly due to an importation of Polar water into the Skager-rack; and (4) *surface-movement* produced by wind, which may also modify the relative levels.

I am assured by Dr. Meyer that the action of each of these factors has now been so fully determined, that the effect of any combination of them can be predicted as certainly as ordinary tidal phenomena. And of the competence of small differences in specific gravity to produce movement in great bodies of water, no one who has investigated the question on the great scale seems to have the smallest doubt. This was the unhesitating conviction of the late Mr. Froude, as the result of his numerous observations on harbours, lochs, and floods, communicating with the sea at their mouths: for he assured me that wherever the salinity of the water at their upper end is lowered by the descent of fresh water from the land, producing a slight

<sup>1</sup> The researches of Prof. Forel and his associates on the Swiss lakes clearly show that in *fresh* water the heating effect of insolation is limited to about 100 feet. In *salt* water, on the other hand—as I pointed out in my Mediterranean Report—there is a *downward convection* of heat produced by the sinking of the water made heavier at the surface by saline concentration. In the Mediterranean, where this effect is limited to a part of the year, it scarcely shows itself below 100 fathoms (600 feet); but near the Equator, where it is constant, the surface-heated stratum tapers downwards to from 300 to 400 fathoms. Beneath this depth the thermometric temperature sinks in the ocean-basin generally (the thermal condition of the North Atlantic being altogether exceptional) from 40° to 33°, or thereabouts; in the Mediterranean, to the deeper part of whose basin the *Red Sea* has no access, the thermometer shows a uniform temperature of from 44° to 50° (according to the locality) from the surface-heated stratum to the deepest bottom (2,000 fathoms).

surface outflow, he could trace an underflow of sea-water up the channel; and this he could attribute to nothing else than the slight excess of downward and therefore lateral pressure in the outside column, depending on the continually-maintained reduction in the mean salinity of the inside column, which more than compensated for any slight excess in its level.

WILLIAM B. CARPENTER  
56, Regent's Park Road, London, N.W.

### The Freshwater Medusa

IN NATURE (vol. xxii. p. 190) Prof. Lankester refers to a statement of mine in the preceding number, that I had arranged with Mr. Sowerby some methods of observation from which I hoped to obtain data for the determination of important points regarding the development of the freshwater Medusa, and expresses a desire to be informed as to the nature of the proposed methods.

The obvious and only practicable course to be adopted with this view was arranged with Mr. Sowerby by Mr. Busk and myself, and consisted in the separation of specimens from the Victoria tank and their confinement in glass jars, which, in order to secure a continuance of the necessary temperature conditions, were to be retained in the same house with the tank in which the Medusa had shown itself. The examination from time to time of these jars would probably bring to light facts having a direct bearing on the development of the animal. This method of observation, indeed, is so obvious that it must have occurred to any one engaged in the investigation it was designed to aid.

Prof. Lankester now says that Mr. Sowerby informs him that he had undertaken no experiments except such as had been carried out at his request; but as it seems that these are identical with those proposed by Mr. Busk and myself, nothing has been thereby lost.

Residing at a distance from London, my opportunities of studying the life-history of the Medusa are at this moment comparatively few. Prof. Lankester, however, being on the spot, and having an unlimited supply of subjects for investigation, will doubtless avail himself of the advantage thus afforded, and will render our knowledge of this remarkable little animal more complete than would otherwise have been possible.

Prof. Lankester refers to the difference of opinion between himself and me, and promises to bring proofs of his own views. When these proofs are offered I shall gladly accept them. My desire is that no previous expression of opinion shall blind me to evidence in favour of a contrary position. The only important points, however, on which my conclusions have been absolutely at variance with those of Prof. Lankester are the presence of a circular canal and the perviousness of the distal extremities of the radial canals. With regard to these there cannot in my opinion be the slightest doubt.

The nature of the marginal bodies is also a point of much importance in this investigation, but I have expressed only a conditional opinion with regard to it. While Prof. Lankester considered these bodies as undoubtedly tentacular, I held that the evidence afforded by adult and by comparatively young specimens is in favour of their velar origin; but at the same time I stated that this point cannot be decided without the evidence obtained from development.

I also drew attention to the remarkable attachment of the tentacles, whose adnate basal portion occupies exactly the position of the peronia in the Narcomedusæ and Trachomedusæ, but I failed to find evidence of the presence of true peronia as described by Prof. Lankester, who now admits that the peronia while present are rudimental.

The other points, namely those which concern the systematic position of the Medusa, are necessarily only hypothetical. It appeared to me that while there are certain features in the structure of the adult Medusa which point towards the Trachomedusæ, there are others which connect it with the Leptomedusæ, to which on the whole it seemed to be more closely allied, though holding a position intermediate between the two; but I regarded the data in our possession as insufficient for the final determination of this point, which can be absolutely settled by the study of development alone.

Prof. Lankester promises details of his observations in this month's number of the *Quarterly Journal of Microscopic Science*, and I look forward to what I doubt not will be a valuable contribution to hydroid zoology.

As to the name of the Medusa, Prof. Lankester, while abandoning his generic name in favour of mine, declares it to be his intention to retain his own specific name for the animal. This is to me a matter of complete indifference. Science can gain nothing from personal contention about names, and the time so occupied might with far greater advantage be devoted to more useful and lasting work.

J. ALLMAN

### On the Simplest Continuous Manifold of Two Dimensions and of Finite Extent

So far as I am concerned Mr. Frankland answers too soon (p. 170), for I am sorry to say I have not read Klein in the meantime. Therefore my reply is provisional. A hint was given of Mr. Frankland's explanation by Mr. Newcomb in a phrase quoted by Mr. Halsted (*American Journ. of Math.*, I. iii. 275, paper on the bibliography of hyperspace, &c.): "The first elements of complex functions imply that a line can change direction without passing through infinity or zero." We do not require even the first elements of complex functions to tell us that we can get to the other side of a point without passing through it, provided we can go round it. But the question was not whether "a line" simply could be thus reversed, but whether it could be so with the geodetic perpendicular in question described in a uniform continuous manifold of two dimensions. Mr. Frankland's explanation expressly takes account of a third dimension. It supposes the moving line to generate a sort of skew helicoid about the fixed line to which it is perpendicular. But how can even initial portions of successive generators be in the same plane, Euclidean or other? This point may seem incidental, but I think it is essential, so I omit further questions.

Somewhere in his "Dynamic" Clifford says that Klein's double surface is a sphere in which opposite points are considered as one. In this light the mystery disappears. There are two perpendiculars: considered as one they never change sign; because, considered as two, they periodically exchange signs. But if opposite points do not coincide, they may be "one," but they are not one point; if they do, is the manifold they compose a surface? Mr. Frankland has not called it a surface: but is it continuous?

There is a very well-known manifold which obviously obeys the laws worked out by Mr. Frankland and Mr. Newcomb, a system of straight lines, not vectors, through a common point; or, reciprocally, a system of planes. To measure of curvature answers density; if this is constant, the geodetic distance from a point to a geodetic line is represented by the angle between a straight line and a plane.

It may be worth while to note one or two oversights in the writing or printing of Mr. Frankland's letter. For  $\sqrt{-1}$  we ought to have an expression involving the angle between the geodetics. The sentence "If a being," &c., is a quotation, and the last word should be "position," not "poise."

Both Mr. Newcomb and Mr. Frankland understand my intention as more negative than it was. I said (xv. 547) "It could hardly fail to be instructive if Mr. Frankland would explain," &c. Probably I underrated the difficulty, in this Euclidean world, of making it clear that one means just what one says.

C. J. MONRO

Hadley, June 29

### A Fourth State of Matter

It seems to me that Mr. Tolver Preston in his letter on the above to NATURE (vol. xxii. p. 192) has somewhat overlooked the con. ext. in the objections he urges against Mr. Crookes' remark that "an isolated molecule is an inconceivable entity." It is plain that Mr. Crookes meant this statement to apply to the quality, not the existence of a molecule, and granting Mr. Crookes's premisses regarding the constitution of matter, it appears a very fair deduction; since if the three states of matter (as we know it), viz., solid, liquid, and gas, owe their different qualities merely to different modes of motion of the ultimate molecules, it is quite conceivable as well as logical to suppose that the latter have a nature totally unlike that of the effects of their motion, and therefore inconceivable to us by reason of its dissimilarity to anything of which we at present possess any knowledge.

Again, with reference to the remark, "solid it cannot be,"

which Mr. Preston calls in question, it would be manifestly illogical on his premises for Mr. Crookes to regard the isolated molecule as a solid, even though, according to Mr. Preston, it may possibly possess certain properties in common with what we call solids, for solidity, according to Mr. Crookes, being "merely the effect on our senses of the motion of the discrete molecules among themselves," it would be exceedingly arbitrary to ascribe to the molecules themselves a quality which, as we commonly know it, is simply an effect of their motion.

July 3

E. DOUGLAS ARCHIBALD

### Minerva Ornaments

I NOTICE that a correspondent writing from America expresses his scepticism as to the figural character of certain stone objects in Dr. Schliemann's collection at South Kensington. Judging from the analogy of similar objects found in America, he pronounces them to be "net-sinkers" and not idols. Whatever, however, may be the nature of the American objects, I think there can be but little doubt that Dr. Schliemann is right in considering the objects discovered by him at Hissarlik to be rude representations of a deity. At first sight they certainly have but little resemblance to anything of the sort, but a careful examination shows that several are marked with the rude delineation of a human face—or, as Dr. Schliemann believes, of an owl's face—as well as of a triple necklace, and sometimes also the characteristics of a woman. Occasionally the hair is represented on the back of the head by straight lines. The delineation is sometimes incised, sometimes painted, though the paint is mostly worn off. As the marked objects are of the same shape as the unmarked ones, we can have no hesitation in inferring that both were intended for the same purpose.

July 4

A. H. SAYCE

### Arthur Young's Travels in France

A FEW months ago my friend Mr. F. F. Tuckett, of Bristol, drew my attention to a passage in Arthur Young's Travels in France, published in 1792, narrating a visit to Lavoisier and to a certain M. Lomond, the inventor of an electric telegraph, which in some points anticipated that of Ronalds. The mention of Lomond's name in a historical list of telegraphic inventors recently published by your contemporary, the *Scientific American*, induces me to send you the inclosed extract as likely to be of interest to the readers of NATURE.

Univ. Coll., Bristol, June 18

S. P. THOMPSON

"The 16th.—To M. Lavoisier by appointment. Madame Lavoisier, a lively, sensible, scientific lady, had prepared a *déjeuner Anglois* of tea and coffee, but her conversation on Mr. Kirwan's Essay on Phlogiston, which she is translating from the English, and on other subjects which a woman of understanding, that works with her husband in his laboratory, knows how to adorn, was the best repast. That apartment, the operations of which have been rendered so interesting to the philosophical world, I had pleasure in viewing. In the apparatus for aerial experiments nothing makes so great a figure as the machine for burning inflammable and vital air, to make or deposit water; it is a splendid machine.

"Three vessels are held in suspension with indexes for marking the immediate variations of their weights; two, that are as large as half-hogheads, contain the one inflammable, the other the vital air, and a tube of communication passes to the third, where the two airs unite and burn; by contrivances, too complex to describe without plates, the loss of weight of the two airs, as indicated by their respective balances, equal at every moment to the gain in the third vessel from the formation or deposition of water, it not being yet ascertained whether the water be actually made or deposited. If accurate (of which I must confess I have little conception) it is a noble machine." Mons. Lavoisier, when the structure of it was commenced, said, 'Mals oul, monsieur, et mieux par un artiste François!' with an accent of voice that admitted their general inferiority to ours. It is well known that we have a considerable exportation of mathematical and other science instruments to every part of Europe, and to France among the rest. Nor is this new, for the apparatus with which the French Academicians measured a degree in the polar circle was made by Mr. George Graham. Another engine Mons. Lavoisier showed us was an electrical apparatus inclosed in a balloon, for

trying electrical experiments in any sort of air. His pond of quicksilver is considerable, containing 250 lbs., and his water apparatus is great, but his furnace did not seem so well calculated for the higher degrees of heat as some others I have seen. I was glad to find this gentleman splendidly lodged and with every appearance of a man of considerable fortune. This ever gives one pleasure: the employments of a state can never be in better hands than of men who thus apply the superfluity of their wealth. From the use that is generally made of money, one would think it the assistance of all others of the least consequence in affecting any business truly useful to mankind, many of the great discoveries that have enlarged the horizon of science having been in this respect the result of means seemingly inadequate to the end: the energetic exertions of ardent minds, bursting from obscurity, and breaking the bonds inflicted by poverty, perhaps by distress.

"To the 'Hotel des Invalids,' the major of which establishment had the goodness to show the whole of it. In the evening to Mons. Lomond, a very ingenious and inventive mechanic, who has made an improvement of the jenny for spinning cotton. Common machines are said to make too hard a thread for certain fabrics, but this forms it loose and spongy.

"In electricity he has made a remarkable discovery: you write two or three words on a paper, he takes it into a room and turns a machine inclosed in a cylindrical case, at the top of which is an electrometer, a fine small pith ball; a wire connects with a similar cylinder and electrometer in a distant apartment; and his wife, by remarking the corresponding motions of the ball, writes down the words they indicate: from which it appears he has found an alphabet of motions. As the length of the wire makes no difference in the effect, a correspondence might be carried on at a distance—within and without a besieged town, for instance, or for a purpose much more worthy, and a thousand times more harmless, between two lovers prohibited or prevented from any better connection.

"Whatever the use may be, the invention is beautiful. Mons. Lomond has many other curious machines, all the entire work of his own hands. Mechanical invention seems to be in him a natural propensity." ("Travels during the Years 1787, 1788, and 1789," by Arthur Young, Esq., F.R.S. Vol. i. p. 64.)

### "Saxifraga umbrosa" adorned with Brilliant Colours by the Selection of Syrphidæ

AMONG Diptera the most assiduous visitors of flowers are certain Syrphidæ, which, elegantly coloured themselves, are fond of splendid flower-colours, and, before eating pollen or sucking nectar, like to stop a while, hovering free in the air, in front of their favourites, apparently fascinated, or at least delighted, by the brilliancy of their colours. Thus I repeatedly observed *Syrphus balteatus* hovering before the flowers of *Verbascum nigrum*, often *Melanostoma mellina*, and *Ascia podagræ* before *Veronica chamaedrys*; in the Alps the lank *Sphægina clunipes* before *Saxifraga rotundifolia*, and in my garden *Ascia podagræ* before *Saxifraga umbrosa*.

Of *Verbascum nigrum* the main fertilisers are humble-bees, Diptera co-operating only in a subordinate degree; in the case of the three other species, on the contrary, the above-named Syrphidæ are such frequent visitors and cross-fertilisers that we may safely conclude that it is by their selection of elegantly-coloured varieties that these flowers have acquired their beautiful peculiarity. Hence, in order to estimate the colour-sense of these Syrphidæ, it is worth while to consider what colour-combinations they have been able to produce by their selection.

*Saxifraga umbrosa* being, as far as hitherto known, their finest masterpiece, we may in the first place look at the variegated decoration of this species. Its snow-white petals are adorned with coloured spots, which in size and intensity of light gradually decrease from the base of the petals towards their extremity. Indeed, nearest to their base, within the first third of their length, there is a large irregular spot of an intense yellow; about the middle of their length there follows a narrower cross band of red colour, vermilion towards the base, intensely pink towards the outside, not reaching the margins of the petals, sometimes dissolved into several separate spots; lastly, beyond the middle of the length of the petals there are three or eight smaller roundish spots of a paler violet-pink colour.

The flowers of *Veronica chamaedrys* prove that also gay blue colours are perceived and selected by *Ascia*.

Lippstadt, Germany

HERMANN MÜLLER

## Dilatation of the Iris

In addition to the method of observation mentioned by Mr. Achroyd in his photometric proposal (*NATURE*, vol. xxi, p. 627) I may mention that the variations of the diameter of the pupil are very beautifully observed by a pair of punctures in a screen over the eye. In fact long ago I used this as a means of observing the absolute diameter of the pupil, subject to a small unexamined constant error.

By pricking a row of holes in a card at distances of '06, '07, '08 . . . '25 inch, and placing this close over the eye, the diameter is observed by sliding the card until two of the holes are found at such a distance that their edges appear to touch. The opening of the other eye, or the slightest disturbance of light, produces an apparent alteration in the sizes of the disks of light, so that their edges recede or overlap; and a fresh pair of holes may be found showing the altered diameter of the pupil.

Thus (1) the extreme diameters of the pupil were found to be '07 (? '06) and '25 inch; (2) the diameter is rapidly variable at will, without any alteration of stimulus, even as much as from '13 to '19 inch; (3) the sympathetic motion takes '4 or '5 second to be produced when the other eye is exposed to light. Many similar interesting questions may be examined by this simple instrument; for which purpose I inclose a sample card for editorial trial.

W. M. F. P.

## Comparative Curves in Terrestrial Magnetism

MONSIEUR.—En séquence à la intéressante communication de Rev. S. J. Perry de l'Observatoire de Stonyhurst, je vous prie d'additionner les suivants renseignements sur la même perturbation magnétique de 17 mars passé, d'après la courbe du declinographe de l'Observatoire du Infant D. Luiz, à Lisbonne.

La différence entre le maximum et le premier minimum à 5h. 49,5m. G.M.T. est de 13,9 (un tiers du mouvement à Stonyhurst), et entre le même maximum et le 2<sup>e</sup> minimum à

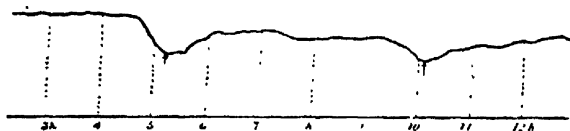

Declinographe 17 Mars, 1880 (Lisbonne M.T.)

10h. 45m. G.M.T. est un peu plus grande 16,2, le contraire qu'on voit à Vienne et Stonyhurst.

Il est digne aussi de remarque que le temps du 1<sup>er</sup> minimum ne s'accorde avec le temps à Stonyhurst et Vienne, pendant que le temps du second est de parfait accord.

La longitude de cet Observatoire est + 36m. 35s. G. Je vous envoie la copie de la courbe.

Agrées, Monsieur, l'assurance de ma haute considération.

Lisbonne, 21 juin 1880

J. CAPELLO

## Effects of Lightning on Trees

YOUR note in *NATURE*, vol. xxii, p. 204, on the recent thunderstorm at Geneva induce me to send you a note on a tree struck by lightning in Stoneleigh Park during a severe storm on last Thursday week (June 24). The tree was a fine oak about forty feet high, and the lightning seemed to have struck not among the smaller branches at the top, but about two-thirds of the way up the main trunk, just where several of the larger branches came off from the stem. From this point to the ground the bark had been rent off along a strip about three inches wide, and through the whole length the wood beneath the bark had been gauged out as if by a carpenter's tool, the groove made being about an inch wide and deep. The curious fact of the tree being struck apparently among the branches at once suggested to me that the electricity must have travelled, without visible effect, through the upper branches, and only produced disruption of the wood when the current was strengthened by the combination of a great number of separate streams. I had forgotten that this was Prof. Colladon's theory of electric discharge, but am glad to be able to give it the support of this observation.

Rugby, July 3

L. CUMMING

## Iron and Hydrogen

In the description given a few weeks back of the experiments of Prof. Hughes, the fact was demonstrated that iron wire in

contact with dilute acids becomes brittle, and at the same time, takes up hydrogen.

There are one or two points of great interest that many, perhaps, besides myself, would like to know more about.

Thus, at the same time the iron becomes brittle, does it also become harder?

This leads one to speculate on the facts illustrated in the hardening and tempering processes of steel.

We know that such liquids as water, weak acid, oil, &c., which are used as baths in which the heated metal is quenched, are all decomposable by iron and other metals at a high temperature, the result being the liberation of hydrogen, &c. Now is it not probable that this liberation of hydrogen is really the essential element in the physical change produced in the hardened steel?—that is to say, that the steel absorbs, or perhaps becomes alloyed with the nascent hydrogen in contact with its surface, thus rendering it intensely hard?

Prof. Hughes has pointed out that a red heat entirely dissipates the hydrogen from the iron wire, which returns to its normal state.

This perhaps will explain the process of tempering by supposing that a certain proportion of the (hardness-rendering) hydrogen is driven off according to the temperature reached, as shown in the well-known shades of colour seen on the surface—that is to say, the hardness is proportionate to the contained hydrogen, such as that many other metals become very hard or soft by being alloyed as zinc and copper in brass, tin and copper in bronze, &c.

This is supported by the fact that one of the most successful processes of hardening depends on the use of a quenching-bath of dilute sulphuric acid. This would be explained by the greater ease with which acidulated water is decomposed by iron, and therefore a larger bulk of the nascent hydrogen liberated on its surface could be absorbed by the metal.

The carbon in steel probably only plays the part of a go-between in rendering the absorption of hydrogen more facile. There is a fact that also supports this, namely, if unhardened steel is dissolved in HCl the carbon is left in the form of graphite scales, whereas after hardening, if treated with the acid in the same manner, the residue is found to consist of a liquid hydrocarbon, thus showing the presence of hydrogen in the metal.

These points I should like to have been able to confirm or refute for myself; but not having the required time or apparatus, I leave it with the hope that some one possessing those advantages, will settle these questions.

Naples

H. J. JOHNSTON-LAVIS

## "Coronella lævis"

IN *NATURE*, vol. xxii, p. 156, the presentation is announced of two specimens of *Coronella lævis* (British) to the Zoological Society. I have known so many persons doubt the existence of the *Coronella* in the New Forest that I should feel greatly obliged to any of your correspondents who would give me some information as to its history, whether it has been introduced, or is really indigenous.

H. KING

[Mr. Sclater tells us that he has no doubt that the smooth snake is indigenous to the British Islands, although it was overlooked for many years. The first living example received by the Zoological Society was in August, 1862, presented by Mr. Fenton, having been obtained in the neighbourhood of Sandhurst. Since then nearly twenty specimens have been received, chiefly from the New Forest and neighbourhood of Bournemouth. See Mr. Cooke's excellent little volume, "Our Reptiles" (London, 1865), for a full account of this species of snake.—ED.]

## Recall of Appearance of Books, &amp;c.

I HAVE only to-day been able to read the back numbers of *NATURE* for the past two or three months, and hence have only now seen Mr. Ernst's letter in your issue of April 29 last.

His power of recalling the appearance of books I know is possessed by others. I have a very large and still increasing library, but there is hardly a volume, or indeed a tract, the appearance and condition of which does not at once present itself to my mind if occasion to use it should arise. Further, being engaged in the compilation of a work some years since, wherein many references to other books were necessary, I used



when away from home (as was frequently the case) to write and indicate not simply in what part of the library the book would be found, but in what portion of the volume, and almost always whether on the left or right hand page, any given passage required would be found.

Of late years I have found it desirable to rebind my tracts in something of a uniform manner. Their external individuality is thus destroyed, but the aspect of their title-pages and the location of particular passages of the contents remain as fresh as ever.

CORNELIUS WALFORD

London, June 24

### Stags' Horns

WITH further reference to the above question I have pleasure in inclosing a letter received to-day from the head keeper at Bradgate Park, near Leicester, where both red and fallow deer are kept.

I may add that I saw at the end of July last, near the head of Loch Erlbol, in Sunderland, a quantity of stags' horns in a gipsy encampment, which I supposed had been collected for sale by that curious fraternity.

HERBERT ELLIS

62, New Walk, Leicester

"To HERBERT ELLIS, ESQ.

"Bradgate Park, 22nd June, 1880

"DEAR SIR,—In answer to yours of the 19th inst. respecting what becomes of the stags' horns after being shed, I beg to say they are regularly collected and sold. But there is not the slightest doubt of their eating each other's horns. I have myself seen several cases where both brow antlers and the top points have been gnawed off. I have also seen Scotch heads that have been quite spoiled by the tines having been gnawed, which must have been done after the horn had become hard, and whilst the animal was living. I am, sir, yours respectfully,

"C. OVERTON"

### Cup and Ring Stones

MANY of the markings mentioned by Mr. Middleton are hollows made by rain, or rather deepened by rain-water holding many low organisms in hollows, on the upper surfaces of exposed grit stones; overflow from these accounts for the groove or spout noticed at the margin of some of them. They are to be seen on the stones erected near Boroughbridge, and speak to the length of time these stones must have been raised into their present position.

W. S.

June 21

### Diatoms in the London Clay

To enable me to determine the exact extent of the diatomaceous band in the London clay, I am anxious to obtain information of any wells in progress, or in contemplation, anywhere in the London Basins, west and north of London. With the help of some of your readers I have no doubt that I shall shortly be able to show that the one referred to is co-extensive with the London clay. The details I wish for are:—

1. Locality of well.
2. If begun, the depth attained.

I shall also be glad to hear of any railway cuttings now being made in the same area.

W. H. SHRUBSOLE

### WATER SUPPLY

AMONG the improvements in sanitary matters that this generation has witnessed not one ranks higher than the settled and still growing conviction of the importance of a pure water supply, and nowhere are the various aspects of the question more keenly debated and considered than in the Metropolis at the present time.

At a discussion at a recent meeting of the Chemical Society there seems to have been some doubt thrown on the conclusions arrived at by chemists in determining the wholesomeness of a water by no less an authority than Prof. Huxley, and it may be well to inquire how far his allegations are borne out by facts.

In the earlier days of the history of chemistry, as was to be expected, the processes adopted in the analysis of water were crude in the extreme, and the quaint ideas promulgated in the treatises then published are not a little amusing. Gradually, however, and especially during the last few years, the methods of analysis have improved, and although, judging by the wide diversities of opinion that exist as to what may or may not be pronounced a water sufficiently pure for drinking purposes, the subject cannot yet be said to have arrived at a stage completely satisfactory; still, so far as the purely chemical evidence is concerned, it would seem to be able to furnish results which are sufficiently exact for all practical purposes. The operations involved are among the simplest and easiest the chemist has to perform, and consequently it is not the data furnished by analysis that are called in question, but the conclusions drawn from them.

Persons interested in sanitary questions, but who have no special knowledge of the difficulties that beset the forming a correct judgment as to the wholesomeness of water, are apt to express themselves as scandalised, and it must be confessed with some show of reason, that it should be possible there should be so little agreement amongst those who are looked up to as authorities on such matters.

This disagreement, however, is more or less inevitable in the present state of our knowledge, and is largely due to the intricacy of some of the problems involved in the question, which is by no means a simple chemical one.

The debatable ground is the nature and estimation of organic matter and the amount of significance that should be attached to the presence of oxidised nitrogen compounds.

Organic matter may be of animal or vegetable origin, the former being dangerous and the latter much less so, if indeed it be not altogether innocuous. To distinguish between the two kinds is therefore all important; but unfortunately it is impossible directly to do this, as both animals and vegetables yield albuminoid matters, which are, chemically speaking, practically identical in composition.

Of the various processes for the estimation of organic matter there are three that are in general use. One, the oldest, known as the permanganate process, finds its advocate in the present day in Dr. Tidy, and consists in measuring the organic matter by the quantity of oxygen required to oxidise it. Another, originated by Prof. Wanklyn, and which he calls the albuminoid-ammonia process, consists in decomposing the organic matter by an alkaline solution of potassium permanganate, and taking the resulting ammonia as the measure of the organic matter. The third process, the one employed in the laboratory of the Rivers Pollution Commissioners and advocated by Dr. Frankland, its originator, estimates the organic carbon and nitrogen separately.

A good deal may be said in favour of all these processes, as affording a rough estimation of the quantity of organic matter, but none of them can be relied upon as giving any indication of its nature, *i.e.*, as to whether it is dangerous or not; and yet it is the almost invariable custom to judge of a water by the quantity of organic matter it contains, no matter what its origin, and a variation of two or three times a given amount is held to make the difference between a good and bad water.

It was to this point that Prof. Huxley especially addressed himself in his remarks already referred to. He gave it as his opinion, speaking as a biologist, "that a water may be as pure as can be as regards chemical analysis, and yet, as regards the human body, be as deadly as prussic acid, and on the other hand may be chemically gross and yet do no harm to any one." "I am aware," said he, "that chemists may consider this as a terrible conclusion, but it is true, and if the public are

guided by percentages alone they may often be led astray. The real value of a determination of the quantity of organic impurity in a water is, that by it a very shrewd notion can be obtained as to what has had access to that water."

However startling these statements may be to those who judge of the wholesomeness of a water by the amount of organic matter it may contain, we believe it to be none the less an accurate description of facts. It is within our knowledge that some of our most wholesome supplies sometimes contain an excess of organic matter, and that the waters which give rise to typhoid fever and other hardly less serious disorders are frequently just those which contain the least, the difference of course being that in the one case the organic matter is innocuous, in the other deadly.

Since, then, chemical analysis fails entirely to distinguish between these two kinds of matter, it may be thought to be a work of supererogation to have recourse to it at all. Not so, however, for what analysis fails to do directly it can to a large extent do indirectly. Organic matter in solution in water is more or less prone to oxidation, the highly putrescible matter of sewage being most so, and that derived from vegetation very much less so. Hence it follows that one would expect to find the oxidised nitrogen compounds in greater excess in the one case than in the other, and as a matter of fact that is just what we do find. Almost invariably, in all waters of acknowledged wholesomeness, the quantity of nitrates never exceeds a certain small amount, whereas in waters, such as polluted well and spring waters, that have given rise to illness, the oxidised nitrogen compounds, with other accompaniments of sewage, are to be found in excess. By means then of these oxidised nitrogen compounds we get collateral evidence throwing light on the nature and probable source of the contamination of which a mere percentage estimation of organic matter would fail to give the slightest indication.

The mistake that has been hitherto that the discussion has been narrowed by looking at the question almost entirely from a chemist's point of view. It is, however, to the biologist that we must look chiefly for the future elucidation of the subject, and he has a field of the widest range, embracing much untrodden ground, for his investigations.

Putting on one side the specific poisons which through the medium of water are able each to generate, after its kind, diseases such as typhoid fever, it is highly probable, judging from what has already been proved to take place in analogous cases, that dangerous organic matter is not poisonous as such, but acts by affording the pabulum for organisms which are able to set up putrefactive changes in the blood of the person drinking polluted water. Even the conversion of organic matter into nitrates is not a mere chemical process of oxidation, since we now know that the oxidation only takes place by the help of a distinct ferment.

In the inquiry as to how far organic matter is destroyed in rivers, it is clearly insufficient to rely upon laboratory experiments in which diluted sewage is exposed only to the oxidising influence of air. This is entirely to ignore the agency of vegetation and of the vast army of organisms, identical with or allied to bacteria, which, being endowed with various functions of reorganisation, convert the carbon and nitrogen of organic matter into simpler inorganic compounds, these in turn to become the food of the more highly organised aquatic vegetation.

Whilst therefore duly recognising the practical help that chemistry can afford in the more limited scope that properly belongs to it, we trust, in the interest of sanitary science, that the enunciation of the views of so distinguished a biologist as Prof. Huxley may have their due weight with those to whom these questions are ordinarily referred, and will tend to promote a better understanding

and more solid ground for agreement than has up to the present seemed possible.

CHARLES EKIN

### THREE YEARS' EXPERIMENTING IN MENSURATIONAL SPECTROSCOPY<sup>1</sup>

BY A NEW HAND THEREAT

#### II.

*The Whole Solar Spectrum.*—Could an observer, who had once made close acquaintance with the glories of symmetry resident in great A of the solar spectrum, when seen in the brightness of a southern noon-day, under a dispersion of 33° and magnifying power of 10, ever remain content therewith?

Never! if a particle of soul belonged to him! for he would be imperiously constrained from that moment to feel that he must see the whole solar spectrum as it is given forth effulgently to the denizens of the south by a nearly zenith sun, before he died; or to what purpose would he have lived in a sun-illuminated world?

Out, therefore, once more to Lisbon the experimenter and his Wife went in 1878, with the important assistance again of the Pacific Steam Navigation Company of Liverpool; but now, armed with a rather different apparatus. There was indeed the same heliostat and there were all the prisms belonging to the aurora spectroscopy; but instead of each of them being looked through singly and successively, they were now used all together, set out in a curvilinear line several feet long on a large table, and looked through all at once; with telescope and collimator each 32 inches in focal length; with magnifying power of 20, and a further prismatic method supplanting the usual employment of coloured glasses to prevent false glare in the field of view; and then what a new world was opened up to behold and admire!

Lines multiplied on lines and in a perfection of finish and refinement, sometimes of infinite thinness, sometimes remarkable power; and the classic fields of those more refrangible portions of the spectrum where the great spectroscopists of the age, Kirchhoff and Secchi, Lockyer and Janssen, Huggins and Young, have chiefly gained their laurels, as expounders of the constitution of the sun, were surveyed with respect and all admiration; but first, foremost, and beyond everything else, were the glories of the illimitable depths of solar colour; colour, the best leading index that has ever been invented yet, to simplify and facilitate the description of all spectrum place.

After having got completely rid of those usual attendant impurities in solar spectroscopy, viz., chemically coloured glasses used as shades, the large dispersions now employed enhanced rather than dulled the solar colours; raised one's ideal of what colour in light can be, and gave, through near fifty gradations, a definite and ever-memorable colour-characterisation to as many portions of the whole spectrum.

In presence of such solar colours, it seemed to be a wilful ignoring of one's best and plainest faculties to speak of the spectrum colours as being only 3, or 5, or even 7. They might indeed be rather spoken of as next to infinite in number; or rather still, as being just so many as there are easily perceptible differences of spectral place; but for that law of locomotion of colour-bands within certain limits, already discovered by the experimenter in his absorption spectra, and found equally applicable to the solar spectrum. Confining therefore the number of colours to something which should give each of them a breadth, not likely to be overpassed by the locomotive effects + and - on their boundaries, the following table of fifteen spectral colours was prepared after much discussion and criticism of each individual member of it:—

<sup>1</sup> Continued from p. 221.

General Distinctions.	Particular Colours.	Wave-Number Spectral Place, normally.		Solar Lines within those Limits of Place.	Chemical Flame, and Electric Spark, Lines within the same Limits.
		Extends from	Reaches to		
Red end of Spectrum.	Ultra-Red.	25,000	30,000	X.	—
	Crimson-Red.	30,000	34,000	Y and A.	Rubidium $\alpha$ and Potassium $\alpha$ .
	RED.	34,000	37,000	Little $a$ and great B.	Lithium $\alpha$ , nearly.
	Scarlet-Red.	37,000	39,000	Great C.	Scarlet Hydrogen Line.
	Light-Red.	39,000	40,000	$c'$ and $a$ Band.	Light-Red Oxygen.
Middle of Spectrum.	Orange.	40,000	42,000	$a$ Band and Rain-Band.	Carbo-Hydrogen's Orange Band, and chief Oxygen Line.
	Yellow.	42,000	44,000	D.	Sodium $\alpha$ .
	CITRON.	44,000	47,000	Aurora's chief Line.	Carbo-Hydrogen's Citron Band of Lines.
	Green.	47,000	51,000	E and little $b$ .	Thallium $\alpha$ and C.-h.'s Green-Giant Line.
	Glauous.	51,000	55,000	Little $c$ and F.	Glauous Hydrogen.
Violet end of Spectrum.	Blue.	55,000	57,000	Little $d$ .	Cæsium $\alpha$ and $\beta$ .
	Indigo.	57,000	58,000	Little $e$ and little $f$ .	Indigo Nitrogen Band.
	VIOLET.	58,000	61,000	Great G and little $g$ .	Violet-Hydrogen Line.
	Lavender.	61,000	65,000	Little $h$ and great H <sup>1</sup> and H <sup>2</sup> .	Lavender-Hydrogen Line.
	Gray.	65,000	70,000	—	—

The colour question settled, then came the measurement of the places of the lines seen therein and amongst. Each day the rather ragged train of some simple, some compound, prisms was set to minimum deviation for each of them in the part of the spectrum concerned, and from 100 to 200 or more lines per day were securely recorded day after day; until at last, after that long and laborious journey through all the colours and all the lines, not omitting to chronicle in appearance, as well as measured place, a single one amongst 2,000, at last, like huge volcanoes throwing out pillars of black smoke streaked with vertical lines, the overpowering forms of H<sup>1</sup> and H<sup>2</sup> hove in sight, and formed a fitting balance as well as contrast in the violet to great A and its rhythmical predecessors in the red.

But long, long before soundings were touched in the appearance of these two smoky giants, certain questions had to be wrestled with touching the terms in which all spectral places should be measured and published.

Full of desire to contribute data for theorists, the experimenter had indulged in the prospect of recording all line-places in terms of wave-lengths; and had even made his versatile, Robinson Crusoe sort of solar spectroscope, read its scales in numbers increasing as the wave-lengths of light do, from the violet towards the red end of the spectrum; and also caused it to present the violet end towards the left, and the red towards the right hand, as with most of his predecessor's maps employing wave-lengths. Further still, as he found it expedient to compare the solar spectral lines he was observing each day with the best maps and photographs he could collect, he applied a wave-length scale to each of them, made them all turn their violet ends leftward, and then tried to trace each line visible in the telescope through all its previous renderings or omissions by previous observers.

But oh! the difficulty of carrying that fully, with anything more than a very few. The difference of the differences of a diffraction or wave-

length scale, between one part of the spectrum and another, as compared with an average refraction or prism representation, viz., some sixteen times, was found to defy all accuracy by any ordinary pen or pencil, and to mislead or confound the eye, as to the mere physiognomy of groupings of the lines. Then, worse still, nature herself, and spectrum-forming nature too, was being fought against, in having scales increasing their numbers for dispersion one way, when the prismatic deviations which produced these dispersions were going the other way. So at last it was determined that whatever the scale a pure theorist may eventually prefer to put a few spectrum places in at last, for his own purposes, the spectrum observer, in order to observe well, quickly, and safely throughout the whole spectrum must have:—

1. A scale according to nature, as to the direction of increase of its numbers.

2. Increasing therefore these numbers from red to violet, both because the prismatic deviations do the same, and because, when the temperature of bodies is gradually raised, from that of the air in which we live up to such point that they begin to be luminous, the first light given off is red; and they only attain to violet light in the latest and most extreme degrees of heat eventually obtained.

3. Red therefore being the natural beginning of the spectrum, and all spectral numbers arranged as above, increasing towards the rest of the spectrum, the said red end requires to be placed on the left hand, so that every spectrum map may be told off as all writing and printing is made to read in all European countries, viz. from left to right, never from right to left.

4. Seeing that prisms will always be employed by some observers of the solar spectrum, and gratings by others, the scale to be used should be one whose general form, in equal parts, should divide the immense difference of physiognomy which exists between the spectra offered by these two instrumental methods; that is, not compressing the red end so much as the prism does, nor compressing the violet so much as the grating does; and this end is obtained most neatly, on an equally absolute foundation with wave-lengths, and in a handy set of whole figures by adopting the number of such waves to the inch, British.

The above points having been all fairly arrived at, after great sacrifices of both time and labour in the other direction, the Edinburgh experimenter proceeded without any further compunction to alter his spectroscopic once more, and make it conform in all respects thereto, *i.e.*, to show the red end of spectra towards the left, and to increase spectral readings from left to right; while he further applied new scales to his collection of spectrum maps in terms of wave-numbers. And then came the reward; for not only did the same eye and pencil succeed in applying a wave-number scale more accurately than a wave-length one to prism-observed spectra, and make the correspondences between prism and grating spectra more numerous, perfect, and easily apprehensible, but the wave-number scale was found more suited naturally to the absolute requirements of the solar spectrum in itself. Or, thus, while the wave-length scale, as represented in Ångström's grand normal solar, but diffraction spectrum stretches out the red end to such a degree that the lines there are so few and far between as to waste the very paper on which they are drawn, the wave-number method gently compresses them, or brings them twice as close together; while again, if at the violet end the lines are so numerous, and closed packed in Ångström's map that they have hardly standing room, and can scarcely be separated one from the other—the wave-number method gives them twice as much space there, in a map measuring, on the whole, from red to violet, only the same length as Ångström's.

But there was a still higher reward to the experimenter, who, adopting the scale of wave-number, and finding he had more room for the violet end of the spectrum, began

to pay more attention thereto; for he then found that, crowded as were the violet lines in Ångström's diffraction map, they were not half crowded enough; or rather that there were really in that part of the solar spectrum three or four times as many more lines still; far more indeed than could have been inserted on the engraved plates of the Swedish philosopher, and many more than his diffraction grating was probably able to show. While therefore all strong lines throughout Ångström's map are believed to have been most admirably measured, and the far more numerous thin lines are also most truthfully rendered in the earlier and middle parts of the spectrum—the violet termination, what with the imperfect showings of his grating, and the contracted space of the wave-length scale map, has not been done justice to.

Yet this is a very material point in the physics of the sun; for according to the preponderance of violet, over red, light, so may be assumed the intensity of the temperature of that light's origin. Whereabouts then did the increased number of lines in the violet observed by the Edinburgh experimenter with his prisms, over Ångström with his grating, place the photosphere of the sun as to temperature?

This point, described by the experimenter in the *Transactions* of the Royal Society, Edinburgh, vol. xxix., for 1879, was approximated to by him in this manner:— Having collected from various sources several thousands of spectrum place observations, he reduced them all to wave-number scale, and then arranged them according to the temperatures of their sources of origin, or, as Mr. Norman Lockyer has since then termed it, their respective "heat-levels," and the following series was obtained:—

Source of origin of spectral light, when at freezing point as in telluric absorption spectra, has its maximum of lines at W.-N. place	... ..	= 39,000
Chamber absorption spectra at temp. 68° F. at	... ..	41,000
Flame lines at lamp-flame temperatures at	... ..	47,000
Gas-vacuum tubes illuminated by 1 inch induction spark	... ..	49,000
Chemical lines in 2 inch sparks	... ..	49,000
Chemical lines in 6 to 10 inch sparks intensified	... ..	51,000
And Ångström's diffraction solar spectrum	... ..	55,000

But the solar spectrum, as observed on this occasion in Portugal, showed its maximum of lines at 61,000 of the same scale; or indicated that the temperature of the solar photosphere may be as much above the highest temperature yet attained by man, even with assistance of electricity in its condensed form, as that is above the freezing temperature of the upper strata of the earth's atmosphere.

Lastly, *Gaseous Spectra*.—Under this term are included both flames, especially blow-pipe flames, in the open air; and electric illuminations inside so-called gas-vacuum tubes, such as those of Geissler and Plucker combined. But in all these cases the experimenter, finding that faintness of the light was the crying evil, changed the usual *transverse* method of looking at lines, or cones, of light, for an *end-on* view of the same.

Trying this first for the blow-pipe, whose flame of coal-gas urged by a stream of air could then, by a collimating objective applied to the anterior telescope, be safely looked into, though directed right towards the slit—the increased number of lines, their steadiness and definiteness in all the several hydro-carbon bands—and then the resolving of the mere haze in the field of view into closely ranked little lines or linelets, proved an inimitable reward, as well as a priceless source of the best kind of reference-data in all his subsequent inquiries; especially too because these advanced results were procured without increasing either the temperature, or size, or combustion material of the flame at all.

Next applying the same principle to the Geissler-Plucker tubes, by having their form modified by M.

Salleron, so that they could be similarly looked at in the direction of the long line of the capillary—the effects were found almost startling in the brilliancy of the principal lines (chiefly indeed at the red end of the spectrum, for only weak sparks were employed) and in the immense number of additional lines in almost every tube-spectrum examined. These results had been communicated to the Royal Scottish Society of Arts in 1879, before it was ascertained that similar tubes for end-on use in photographing the violet lines had been made by the eminent Dr. van Monckhoven, at Gand, Belgium, three years earlier. But while fully acknowledging the Doctor's undoubted priority of invention, and inviting him to communicate his first published results at one of their meetings, the Society found the case already before them a perfectly independent invention; a part, too, of a more general system, and accompanied by a series of measures of some of the gas spectra, both in blowpipe flames and spark-illuminated tubes, to a greater refinement than had ever been made before. They therefore graciously crowned the paper with a prize and printed it at full length in their *Transactions* for March, 1879.

Now some of these increased refinements in knowledge of the spectra of the gases referred to matters long in dispute before the world; and especially to the contention of whether the so-called "carbon-lines" of some observers seen by them in candle-flames, could possibly be the lines of that most refractory element carbon, or were not rather the lines of some of the very easily volatilised compounds of carbon, unless all the usual chemistry of carbon be utterly at fault. Herein the powers of the aurora spectroscopy with its bright images, its still brighter end-on methods of viewing gas-flames, and its easy powers of rotation from one source of light to another, proved of inestimable advantage; for not only could large dispersions, approaching those employed on the sun, be used with effect, but the minutest line in one spectrum could be so quickly compared with a similar line in any other, and decided on absolutely as to whether it was or was not in the same spectrum place.

Wherefore the Edinburgh experimenter proceeded in the following manner: after repeating Prof. Swan's ancient observations and finding with him that all the various hydrocarbons gave more or less completely the same spectrum as the blue base of a candle-flame does, he set up for permanent reference, end-on, a blowpipe flame of coal-gas with common air as the best example of that kind of spectrum, viz., the spectrum of a something which vapourises at merely lamp-flame temperature. That that thing could be pure carbon, the chemists one and all declare is impossible, because no furnace heat can vapourise that element; but the Royal Society, London, had printed a paper declaring that the unknown agent must be carbon, pure and elemental, because the author of that paper had seen the same spectrum, not only in all combinations of hydrogen with carbon, but in those of oxygen, and also nitrogen, with carbon. This statement too was further strengthened by a Report from the Greenwich Observatory in 1877, to the effect that gas-vacuum tubes electrically illuminated, having been examined there spectroscopically, no sensible or material differences were found between carbo-hydrogens, carbo-oxygens, and carbo-nitrogens; the one common spectrum seen there must also, it was argued, though very different from the blowpipe flame spectrum, be the spectrum of pure carbon.

But as soon as the Edinburgh experimenter tried his end-on vacuum tubes he found an immense difference between carbo-hydrogens on one side, and both carbo-oxygens and carbo-nitrogens on the other; for the former, though with some other features constant, invariably showed many most brilliant lines in the orange, the citron, the green, and the blue; while the other tubes either had not any trace at all of those lines, or only so faint a mark-

ing as to indicate they were there as impurities and not as the whole contents of the so-called "vacuum-tube."

What were these lines then, so peculiar to carbo-hydrogen tubes? A reference to the coal-gas blowpipe flame showed that they were its characteristic lines; the lines, too, of an easily dissociable compound gas therein, and not of an ultimate and most refractory element; for as soon as the electric sparks illuminating the tubes were somewhat increased in intensity, quantity, and heat, these blowpipe, or we may now safely call them carbo-hydrogen, lines faded out of view; while the two elements which had made them, viz., pure hydrogen, showed its lines, and pure carbon showed, not its ultimate, elemental lines (which nothing short of the most powerful sparks, large batteries, and enormous condensers far above the private means of the Edinburgh experimenter can bring forth), but its low-temperature, compound-linelet, or *band*, spectrum.

Next, on examining the tubes of carbo-oxygen and carbo-nitrogen certain differences between them were detected, due apparently to the compound gas in each case being partly dissociated, and partly left untouched, by the simple, small induction-sparks employed. When largely dissociated, then carbon bands and oxygen lines were grandly present in one case, and carbon bands and nitrogen bands in the other; with some indications also of the compound's presence in either case, though never to the magnificent degree of the carbo-hydrogen in tubes of that gas. This, however, was merely for the simple reason that carbo-hydrogen is by nature a more magnificent "lighter-up" in luminous spectra; just as it is indeed the basis of all the means yet adopted in the history of mankind to correct the darkness of night; and there seems little chance that science will ever find anything better for every kind of occasion wherein we now employ candles, gas-lights, and lamps.

On further examining the carbon bands in the end-on tubes by a dispersion power of  $33^\circ$  from A to H, a peculiar structure was discovered by the experimenter in their component lines; and when he found that to be as distinct in a cyanogen tube which contained no trace of either oxygen, or more unusual still, hydrogen impurity, he considered it a proof that that electric spark-raised carbon-band (to which the chemists will probably not object) was the low-temperature spectrum of that element, and not the spectrum, as argued by M. Thalén, of an oxide of carbon.

Many important points, therefore, seem to be indicated by these experiments, but with the general effect also of showing that spectroscopy loses much of its exceeding accuracy in power of discrimination, unless its observation be accompanied by some record of the particular "heat-level" at which the materials examined by it were rendered incandescent.

Hence a paper on these subjects was communicated to the *Philosophical Magazine*, London, in August, 1879; and further observations are now being carried on by the same experimenter on a new variety of his end-on tubes, prepared also by M. Salleron, and giving still brighter spectra than before, with the same electric illumination.

But all this is only while waiting for the aurora to appear, that phenomenon being the proper cause of this particular Edinburgh spectroscopy. And now all men trust that the said aurora is soon to reappear, as the multifarious solar activities of a new sun-spot cycle have so evidently begun in the increased size and number of these spots ever since October, 1879; when they were critically considered, and openly announced in *NATURE*, to have at last shaken off the languor of their long minimum epoch, and to have begun in earnest their preparation for the new series now fairly under way.

(Since the above paper was written, the first of the new cycle of auroras to come, has been caught. See *NATURE*, vol. xxi. p. 492.)

## PNEUMATIC CLOCKS

TO distribute the time with accuracy and uniformity in a large city is a problem of great utility and extreme importance. This problem has been all but completely solved by the pneumatic clocks erected since March last in the principal streets of Paris and among a considerable number of subscribers, who, for a halfpenny a day, receive

the time from the observatory every minute without winding up or any care on their part. The details of the system established in Paris we take from an article by M. E. Hospitalier in a recent number of *La Nature*. The system consists of (1) a central station where the compressed air is produced and sent every minute through the system of tubes; (2) a distributing system of tubes with ramifications to streets and houses; (3) a series of

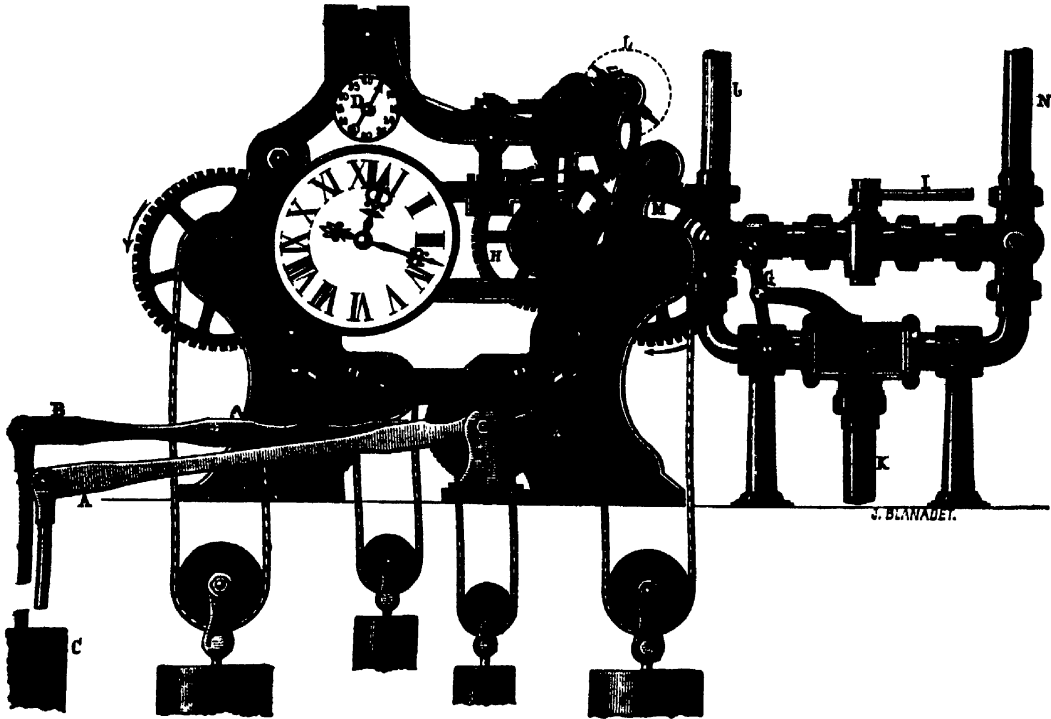

FIG. 1.—Distributing Clock of Compressed Air.

dials with pneumatic receivers established in the public streets and in private buildings.

At the central works a steam-engine sets in motion two pumps, which compress air into a large reservoir of about eight cubic metres, at a pressure of five atmospheres. This compressed air, by means of a special regulator, is transmitted to a second chamber called the distributing reservoir, where the pressure is kept at seven-tenths of an atmosphere by means of a simple automatic apparatus. This reservoir is put into communication every minute with the main distributing pipes for twenty seconds by means of a distributing clock shown in Fig. 1. The distributing clock comprises two quite distinct movements: the left movement is intended to set the clock going in the ordinary manner; the right movement is specially intended to work the distributing valve R. The seconds-hand is at D. At the beginning of each minute the air of the distributing reservoir arriving by the tube J in the distributing box is sent into the main distributing pipes by the tube M. At the end of twenty seconds a displacement of the lever G places the valve R in its second position. The tube N then communicates with the tube K, open to the atmosphere, while the tube J no longer communicates either with K or with N. The valve R remains 40 seconds in this position, to complete the minute, when a new displacement of the valve again places J in connection with N, and so on. All these displacements of the valves are effected by means of gearings arranged in the works

of the distributing clock. The compressed air of the main pipes is utilised to wind up automatically the two movements by means of the levers A and B, which are connected with pistons placed in the cylinders C, and

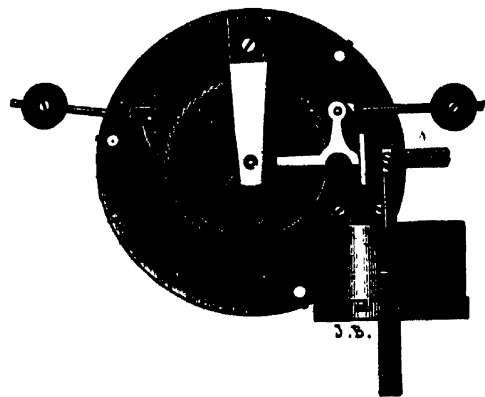

FIG. 2.—Dial Mechanism of Street and Private Clocks.

raised every minute by the compressed air to a distance exactly equal to that through which the motor weight has descended during the preceding minute. There is no need, therefore, to trouble about the winding up of the

distributing clock. This clock is regulated by the Observatory, by hand; but soon a special system will be established, by which the exact time will be distributed from the Observatory by electricity. As the system is established in duplicate at the central works, should anything go wrong with one clock the other is put in working order in a few seconds. The function of the distributing clock may be performed by the hand by working properly,

every minute, the three-way tap, I, which plays exactly the part of the valve R.

For the system of distribution the air is sent every minute into the tube N, which bifurcates into a certain number of smaller branches, forming so many networks completely separate and independent, so that a derangement of one of the systems does not affect the others. The principal tubes, carried underground, are of wrought iron, and have



FIG. 3.—The Pneumatic Clock on the Place de la Madeleine.

an internal diameter of 27 millimetres. The tubes placed in private houses are of lead, 15 mm. in diameter; in apartments and passages this diameter is reduced to 6 mm., and the tube attached to the clock, in lead or india-rubber covered with silk, is only 3 mm. in diameter. With a pressure of seven-tenths of an atmosphere, by leaving the distributing system for 30 seconds in communication with the distributing reservoir, as we have said, it is easy to set the clocks going several miles from the central works,

notwithstanding the inevitable escape from the pipes. Differences have occasionally been observed between some of the clocks, probably in most cases the results of mischievous meddling; these, and other accidents, however, become fewer and fewer, and will no doubt gradually disappear. Owing to the division of the service into various distinct networks, any flaw is soon detected and easily repaired.

Whatever be the form or size of the dial, public or

private, the mechanism is always the same. A caoutchouc bellows, like that used in Walker's pneumatic air-bells, is in communication with the main pipes. Every minute the pressure of the air raises it (Fig. 2); this bellows acts on a lever which draws a wheel of sixty teeth, in the axis of which is fixed the minute-hand. The wheel makes one-sixtieth of a revolution; a ratchet-click, shown on the left of the toothed wheel, prevents any return of the wheel. The movement of the hour-hand is effected by means of a small train of wheels, which is not represented in the figures. This small and very simple mechanism may be placed with the greatest facility in the interior of existing clocks, without changing the external form, substituting it for the old movement.

By means of a second bellows, the function of which is to wind up the bell of a pneumatic clock on a slightly different system, we may establish striking clocks. The price of the former to subscribers is 5 centimes a day, the striking clocks costing 6 centimes.

In Fig. 3 is represented the pneumatic clock of the Place de la Madeleine, furnished with its three dials, the movement of each of which is independent. The letters are clear on a blue ground. At night a jet of gas lights the interior, and the hour is clearly discernible at a considerable distance.

### NOTES

WE have much pleasure in stating that Her Majesty has been graciously pleased to grant to the widow of John Allan Broun a pension of 75*l.* per annum. In *NATURE*, vol. xxi. p. 112, will be seen a full account of the life and works of that distinguished magnetician and meteorologist, whose life may truly be said to have been sacrificed through his devotion to the cause of scientific research.

THE following grants have been made from the Research Fund of the Chemical Society:—10*l.* to Mr. Kingzett for experiments on the atmospheric oxidation of phosphorus; 25*l.* to Mr. Watson Smith for the investigation of the di-naphthyls and phenyl naphthalene; 25*l.* to Messrs. Bailey and Munro for investigations of the colour reactions of certain metals and metallic solutions.

MR. AUBERON HERBERT is anxious to preserve our ancient monuments, but thinks the method proposed in Sir John Lubbock's Bill all wrong and unnecessarily harassing; indeed in his letter in Tuesday's *Daily News* he scents communism in Sir John's enterprise. He deprecates Government interference at all, and thinks the only effectual and enlightened method to be the education of the people into an intelligent respect for all our ancient monuments, a respect which would be a sufficient guarantee for their protection. Might not Mr. Herbert get Lord Norton to compile a series of reading-lessons on archaeology after his lordship has completed the botanical reading-book to which we referred last week? These lessons might take practical effect in the course of a generation or two, by which time probably there would be no ancient monuments for popular protection. The obtuseness of Mr. Herbert's letter is almost phenomenal.

UNIVERSITY COLLEGE, London, is anxious to complete its buildings, and in connection with this purpose a meeting was held at the Mansion House last Friday. We have frequently had occasion to speak of the great services rendered by the institution to the raising and broadening of education in this country. It has not only itself aimed to carry out a high standard of education, but has given a strong and healthy impulse to older institutions, and led, directly or indirectly, to the establishment of other institutions in which science has its fair place. Of the desirability of completing the buildings of Uni-

versity College there can be little doubt. The sum required is large—105,000*l.*; but if Edinburgh could raise 90,000*l.* for a similar purpose surely the wealthiest city of the wealthiest country in the world need have little difficulty in raising the sum required. Of this sum 20,000*l.* has already been subscribed; about the balance we trust there will be no difficulty.

IN connection with the recent meeting to raise funds for the completion of University College buildings, Prof. Ray Lankester writes to yesterday's *Times*, animadverting in strong terms on the scandalous misappropriation of the funds left by Sir Thomas Gresham "for the purpose of providing a college which should rival the Universities of Oxford and Cambridge in the completeness of its appointments and bring the highest education to the very doors of the citizens of London." Prof. Lankester suggests that the present representatives of the Corporation, who appear so anxious to promote the educational interests of the metropolis, should restore "to University education in London a fair portion of the sum which the Corporation of London, in days long past, diverted to its own benefit from Sir Thomas Gresham's trust." But could not the Gresham funds be included in the inquiry of the Commission now being appointed by Government to investigate the whole question of the City Corporations? If not, it ought to be.

TWO important accessions have recently been received by the Herbarium of the Royal Gardens, Kew. The corporation of Carlisle has transferred to it the herbarium of Dr. Goodenough, who was formerly Bishop of the Diocese, and who died in 1827. This is rich in specimens of plants cultivated at Kew and Chelsea in the end of the last century, but which have hitherto been very imperfectly represented in the Kew Herbarium. The very extensive collections of mosses accumulated by the late Prof. Schimper of Strassburg, and upon which his well-known works upon this group of plants were based, has been purchased (together with the accompanying drawings and notes) from Prof. Schimper's family by the Baroness Burdett-Coutta, and also presented to Kew.

DR. M. C. COOKE having been placed by the India Office at the disposal of the authorities of the Royal Gardens, Kew, has now entered upon his duties as cryptogamist attached to the Herbarium, and will for the present take charge of the collections of non-vascular cryptogams.

MR. H. A. ROLFE, lately a gardener in the employ of the Royal Gardens, Kew, has been appointed by the Civil Service Commissioners, after a competitive examination, to the vacant post of second assistant in the Herbarium of the same establishment.

DR. WOODWARD has been appointed keeper of the geological department of the British Museum in succession to Mr. Waterhouse, who resigned about three months ago. Dr. Woodward has occupied the position of assistant-keeper in the department for many years, and is the editor of the *Geological Magazine*, in which, as well as in the *Journal* of the Geological Society, he has published numerous memoirs.

MANY lessons will, and already have been, drawn from the unprecedented explosion of gas in London on Monday; the results were disastrous enough, but we may congratulate ourselves that they were no worse. The science of the explosion is simple enough, as the daily papers have been telling the public; and when science is properly taught in our elementary schools such accidents can only be due to perversity, not lack of knowledge. We recommend this explosion and its immediate cause, to the consideration of Lord Norton.

OUR readers may remember that some months ago Sir William Thomson made several valuable suggestions as to the require-



ment of our present system of lighting our coasts, which, he maintained, is a fruitful source of danger to navigation. A Parliamentary paper has just been issued containing a correspondence between Lloyd's Committee and the Trinity House on these suggestions. Naturally the Elder Brethren of the Trinity House attempt to show that their system is by no means so unsatisfactory as Sir William Thomson maintains it is, though they admit it is by no means perfect. They assured Lloyd's Committee of two things—(1) that the lighthouse system was not in the crude state which Sir William Thomson appeared to imply, and (2) that its present custodians were actuated by a very earnest desire yet further to simplify and improve it. The Committee of Lloyd's remarked, in their reply, dated January 16, 1880, that they were glad to find that they were at one with the Elder Brethren in thinking that some distinctions more marked than those already existing would be useful. They had no special interest in Sir William Thomson's plan, but they had always understood that his inventions and improvements in electrical apparatus, the mariner's compass, and the sounding machine had been of great service to the community at large. We suspect there is much more in Sir William Thomson's animadversions and suggestions, the result of the practical experience of an eminent man of science, than the Elder Brethren of the Trinity House are willing to admit.

THE engineers of the St. Gothard Tunnel are stated to be in a fair way to overcome the difficulty arising from the falling in of the roof in the part known as the "windy stretch." This stretch, which is 200 metres long, and situated almost directly under the plain of Andermatt, passes through strata composed alternately of gypsum and aluminous and calcareous schists, which absorb moisture like a sponge and swell on exposure to the atmosphere. It has given the contractors immense trouble, and has fallen in so often that it was seriously proposed a short time ago to allow it to collapse, and make a bend so as to avoid the "windy stretch" altogether. The expedient now adopted, which has so far been successful, is the rebuilding of the supporting masonry in rings of solid granite. The rings are each four metres long, so that in the event of any one of them giving way the others will not thereby be affected. The building is constructed slowly and with the utmost care; no imperfect stones are allowed to be used; the masonry is perfect, and the walls of extraordinary thickness—in the parts most exposed to pressure not less than ten feet. At the beginning of June only 34 metres of the "windy stretch" required to be revaluted.

M. TRESCA, whose name has been connected with the Conservatoire des Arts et Métiers for about twenty-five years, no longer belongs to that establishment. His office has been suppressed by a recent decision of M. Tisard, the Minister of Agriculture and Commerce. This unexpected resolution has created some sensation in the Paris scientific world.

WE have received the first volume of the *Archives of the Deutsche Seewarte*, a neatly-printed quarto volume of above 300 pages, with numerous plates, containing an account of the first four years' working of the Meteorological Office at Hamburg, 1875-78, under the able guidance of Dr. G. Neumayer, well known as the former Superintendent of the Flagstaff Observatory at Melbourne. The volume contains some elaborate reports, among which may be specially mentioned an account of the activity of the Office in the departments (1) of Marine Meteorology, (2) of Weather Telegraphy and Storm Warnings, (3) a Report on the Testing of Chronometers, and (4) a paper on the Non-periodical Monthly Variations of the Barometer. Subsequent annual volumes are promised in regular succession, and we look forward with confidence that an addition of much useful knowledge on the subject of meteorology generally will be gained by their publication. The *Seewarte* already possesses a library

of 9,400 volumes, and includes that formerly belonging to Prof. Dove of Berlin, which was acquired at a cost of 1,500*l.*

A CURIOUS work, impressively illustrative of the "science" of the Dark Ages, has just been published at Berlin, under the title of "Compendium der Naturwissenschaften an der Schule zu Fulda in IX. Jahrhundert." Its purpose is to expound the works of Rhaban, the celebrated Abbé of Fulda (788-856). The Abbé, under the title of *De Universo*, published what would now probably be classed as an encyclopædia, and as we have said, its divisions and contents are a curious illustration of the state of systematic knowledge at the time it was written. Book I. treats of the Trinity and Angels; Book II. Patriarchs and Prophets; Book III. Men and Women spoken of in the Old Testament; Book VI. Man and the various parts of the Human Body; Book IX. the World, Atoms, Elements, the Sky, Stars, Meteors; Book X. the Almanack and Feasts; Book XII. the Earth; Book XIII. the Vertical (?) Parts of the Earth; Book XV. Philosophers, Poets, Sorcerers, Idols, Pagans; Book XVIII. Measures, Weights, Numbers, Music, Medicine, and Diseases; Book XX. War, Horses and Ships, &c. Of course the book is full of curious mythological and other mysteries, a remarkable feature, however, being the important part given to etymology; indeed it would almost seem as if all science consisted in good etymology.

DR. R. F. HUTCHINSON of Mussooree, India, writes that on the afternoon of May 25 a hail-storm, remarkable for its fury, extensive area, and size and structure of its stones, enveloped that station, and Deyrab and Rajpore, at the foot of the hill. A discharge of stones as large as pigeon-eggs opened the attack, and this was followed by a continuous downpour of stones, oblate spheres as large as small marbles. The whole station was penetrated by these, and it presented the appearance of being strewn broadcast with acidulated drops. These stones were of pure, clear ice, and, barring their shape, quite amorphous. Not so the large stones, whose structure and mode of formation were very puzzling. First, an opaque nucleolus surrounded by a concentric nucleus of clear ice, and this by a radiating periphery. The nucleolus being opaque, was rapidly frozen; it must then have moved through alternate layers of hot and cold air to have received the concentric accretions of clear ice. The radiating periphery (which was translucent, but not transparent) quite puzzles our correspondent.

A VALUABLE paper of observations of the aspect of Mars during his recent opposition, of the red spot of Jupiter, and the spots of Venus, by M. Terby, appears in the Belgian Academy's *Bulletin* (No. 3). The most delicate part of the work is that relating to the spots of Venus, of which he supplies ten carefully executed drawings.

CAPTAIN DOUGLAS GALTON gives an address to-day in connection with the Sanitary Institute at the Royal Institution.

THE 126th annual meeting of the Society of Arts was held on the 30th ult., when the Report was presented and officers elected. The Society is in a more satisfactory condition than at any previous period.

*Scientific Practice* is the title of a periodical published three times a year for the students of the School of Practical Engineering at the Crystal Palace. No. 7, which we have received, contains several papers likely to interest young engineers.

MR. W. SAVILLE KENT's long-promised "Manual of the Infusoria" will be published by Mr. David Bogue. The complete MS. and drawings are in the printer's hands. The work will be issued in six monthly parts, the first of which is to be ready in October.

A new list of members of the Institution of Civil Engineers has just been issued, from which it appears that there are now on the books 1,217 members, 1,299 associate members, 579 associates, 48 honorary members, and 657 students—together 3,770 of all classes. At the same period last year the numbers of the several classes were 1,148, 1,200, 622, 17, and 591, making a total of 3,578, showing an increase at the rate of nearly 5½ per cent. During the past session the elections have comprised 2 honorary members, 43 members, 129 associate members, and 15 associates; and 160 students have been admitted.

A COMMISSION appointed on November 27, 1879, has visited the five French provincial observatories. A report has been written by M. Lecwy, sub-director of the Paris Observatory, discussed at a meeting of the directors of the establishment, approved by the Minister of Public Instruction, and published by the *Journal Officiel* on June 29.

In a report which he has lately sent to the Foreign Office, the acting Consul-General at Bangkok remarks that the year 1879 will long be memorable in the provinces of Battambang and Chantaboon for the discovery of valuable sapphire mines in that part of Siam. Mines of inferior value have long been known in the neighbourhood, and about five years ago new mines were discovered by a native hunter. Being, however, in a very remote and secluded position, it was long before their fame spread to the Burman and Indian gem-traders and miners. Eventually they became more widely known, and large numbers flocked to them, especially from British Burmah. The largest sapphire hitherto found weighed, according to Mr. Newman, 370 carats in the rough, and when cut turned out 111 carats of the finest water. The ruby, onyx, and jade are also found in the district, but are apparently of inferior quality.

THE *Liverpool Courier* understands that the telephone has been successfully laid down from Childwall Church, Liverpool, to the house of a lady half a mile off who is unable to go out; the chants, hymns, and lessons are distinctly heard, but only fragmentary sentences of the sermon can be caught.

WE see from the *Otago Witness* of May 22 that Prof. Black of Otago University has commenced a second course of public lectures on chemistry, in continuation of the course last winter, to which we referred as having been attended by teachers from all parts of the province of Otago, many of them coming distances of sixty, seventy, eighty, and ninety miles. The present course promises to be quite as successful. The *Witness*, we are informed, publishes the lectures in response to several requests, and in view of the heartiness with which the course (both of last year and this) has been received.

MR. J. LEE JARDINE writes from Capel, Surrey:—"I felt what may have been the tremor of an earthquake on Sunday, June 27, at 9 p.m. I was sitting with friends talking and reading on the ground floor of a house close to a road, and noticed a low rumbling lasting two or three seconds; this was repeated five or six times in the course of four or five minutes, sounding so like the noise of wheels that I watched for a cart, but in vain. The last three or four times the rumbling was accompanied by a slight vibration sensible only to the feet. It was felt also by one of my friends, who remarked upon the curious sensation."

THERE was a severe shock of earthquake at Brieg, Switzerland, on Sunday. Many buildings were injured, but, so far as is known, no lives were lost. The movement was also much felt at Zermatt and Belalp, and very slightly at Geneva.

M. FERRY, French Minister of Public Instruction, presided at the first meeting of a commission established for the improvement of popular publications. It has been resolved that a sub-commission shall decide what works shall be rewarded and what subjects proposed by way of competition.

IN a work published by Dr. Ricour of Philippeville, Algeria, on "Demographie figurée de l'Algérie," it is proved that marriages are more prolific than in France, the mean number of children being 3·67 in the colony, as contrasted with 3·07, in the mother country. In the first twenty years after the French occupation it was taken for granted that European children could not be reared in the colony. The increase of the European population is very remarkable; in 1830, 600; ten years afterwards, 27,000; twenty years, 125,000; thirty years, 200,000; forty years, 271,000. In 1880 the number is not yet known, but is probably 400,000, having been found 323,000 in 1876.

WE have received the Calendar of the "Tokio Daigaku," or University of Tokio for 1879-80. This university seems to be quite as complete in all its departments as any similar institution in this country, and the education provided seems, to judge from the examination papers, thorough. The place given to science is what it ought to be, on an equal footing with any other department in all respects. An interesting historical summary is prefixed of the introduction of Western learning into Japan.

THE *Report* of the Miners' Association of Cornwall and Devon for 1879 shows that the Association continues to do good work among the mining population of these two counties. The numbers attending the classes continue to increase, and the instruction given is well calculated to be of great service to a mining population. The *Report* contains a paper by Mr. A. T. Davies on the "Phenomena of the Heaves or Faults in the Mineral Veins of St. Agnes."

WE have received a very favourable *Report* (the 22nd) from the East Kent Natural History Society. The *Report* contains several good papers read at the meetings of the Society, the most important and the longest being that of Capt. McLakin, "An Outline and Index to the Geology of East Kent."

WE are asked to state by Mr. Walter Baily (not *Baillic*) that in our report of the Physical Society last week, p. 210, second column, line 29, *notes* should be *notes*.

THE additions to the Zoological Society's Gardens during the past week include a Rhesus Monkey (*Macacus erythreus*) from India, presented by Mr. Fred. Felix; a Banded Ichneumon (*Herpestes fasciatus*) from East Africa, presented by Mr. H. Hall; a Common Marmoset (*Hapale jacchus*) from Brazil, presented by Mr. T. Douglas Murray, F.Z.S.; a Java Sparrow (*Padda oryzivora*) from Java, a Spotted-sided Finch (*Amadina tathamii*), a Chestnut-eared Finch (*Amadina castanotis*) from Australia, two Chestnut-bellied Finches (*Munia rubro-nigra*), a Yellow-bellied Liothrix (*Liothrix luteus*) from India, two Red-beaked Weaver Birds (*Quelea sanguinirostris*), a Crimson-crowned Weaver Bird (*Euplectes flammeiceps*), a Paradise Whydah Bird (*Vidua paradisica*) from West Africa, a Brazilian Tanager (*Ramphocelus brasilius*) from Brazil, a Bearded Tit (*Calamophilus biarmicus*), European, presented by Mr. St. Julien Arabin; two Common Peafowls (*Pavo cristata*) from India, presented by Miss Wedderburn; a Slender-billed Cuckoo (*Licmetis tenuirostris*) from South Australia, presented by Mr. H. F. Bussey; a Jaguar (*Felis onca*), two Huanacos (*Lama huanaco*), two Coypu Rats (*Myopotamus coypus*), two American Barn Owls (*Strix flammea*) from South America, deposited; a Cereopsis Goose (*Cereopsis nova-hollandia*) from Australia, a Doubtful Toucan (*Ramphastos ambiguus*) from United States of Columbia, six Chinese Quails (*Coturnix chinensis*) from China, two American Kestrels (*Tyrannus sparverius*) from America, an Ocellated Monitor (*Monitor ocellata*) from West Africa, purchased; a Red Deer (*Cervus elaphus*), a Reeves's Muntjac (*Cervulus reevesi*), born in the Gardens, three Upland Geese (*Bernicla magellanica*), bred in the Gardens.

OUR ASTRONOMICAL COLUMN

THE VARIABLE NEBULA NEAR  $\zeta$  TAURI.—Though there has been no mention of late of observation of the vicinity of the nebula discovered near  $\zeta$  Tauri on October 19, 1855, by Chacornac, at Paris, and of which he found not the least trace in November, 1862, it may be nevertheless hoped that attention has been directed to the neighbourhood, even if with negative results. As we do not find a sufficiently detailed account of Chacornac's experiences bearing upon this nebula in our astronomical treatises, we may recapitulate them here.

Chacornac tells us that when constructing, at Marseilles, the chart No. 17 of the Atlas employed in the search for small planets, he registered between December 3, 1853, and February 20, 1854, a great number of stars in this part of the heavens, and amongst others he observed, from January 26 to 31, a star of the eleventh magnitude, the position of which for the beginning of 1852 was in R.A. 5h. 28m. 35<sup>s</sup>.6s., and Decl. + 21° 7' 18". At that time and later he did not perceive any nebulosity about it; at the Observatory of Paris on September 1 and December 17, 1854, with a refractor of ten inches aperture he did not detect any such appearance. On October 19, 1855, in verifying the chart of this region, he remarked a faint nebula about the star and delineated it upon the map. He was then, as he says, far from thinking that objects generally considered to be masses of small stars could vary in brightness like the isolated variables, and attributed the degree of visibility to the greater or less degree of transparency of our atmosphere. But under the idea that the nebulosity might really be a distant comet, he endeavoured to repeat his observation on following nights, though from clouds and moonlight it was not till November 10 that he could satisfy himself that the object was precisely as he saw it on October 19, having changed neither in position, extent, nor form. Its brightness was particularly remarked on January 27, 1856, when it is recorded: "Elle offre l'apparence d'un nuage transparent qui semble reflecter la lumière de l'étoile  $\zeta$  Taureau, et son aspect tout différent de celui de la nebuleuse 357 (Herschel II.) ne fait naître aucune idée de points stellaires visibles sur toute l'étendu de sa surface. Cette nebuleuse d'Herschel se présente en effet comme un amas d'étoiles qui s'aperçoivent distinctement séparées les unes des autres même avec un faible grossissement, tandis que le souvenir que je garde de la nebuleuse variable ne l'a fait comparer à un léger cirro-stratus strié de bandes parallèles: cette description est, du reste, en toute conforme au dessin de la carte."

From the end of January, 1856, until November, 1862, the dates of comparisons of this chart with the sky were not recorded, but on the 20th of the latter month Chacornac failed to see the least trace of the Nebula, though the star of the eleventh magnitude, upon which it was formerly projected, remained of precisely the same brightness. On frequent occasions subsequently, before notifying his discovery in April, 1863, he could see no vestige of nebulosity with the instruments at the Observatory of Paris. With regard to the appearance of the nebula Chacornac remarks: "Elle offrait une forme presque rectangulaire, dont le plus grand côté mesurait un arc de 3 minutes et demie, et le plus petit 2 minutes et demie." The eleventh magnitude, according to his position, precedes  $\zeta$  Tauri, 12<sup>s</sup>.6s., and is 4' 26" north of that star; it appears to be No. 907 of the zone + 21° in the *Durchmusterung*, where it is rated 9<sup>m</sup>.4m, the scale of magnitudes in that catalogue not being identical with Chacornac's.

In the same neighbourhood is a variable star notified by Prof. Julius Schmidt, which follows the bright nebula  $\lambda$  357, about 23<sup>s</sup>.8s., with 4<sup>m</sup>.2 less declination. It is No. 894, zone + 21° in the *Durchmusterung*, and there called 9<sup>m</sup>.5m. According to Schmidt's observations it was 8<sup>m</sup>.9 on February 4, 1861, 11<sup>m</sup>.12 on March 21, 1862, 9 on January 9, 1864, and 10 at the end of the same year; he found its place for 1861<sup>o</sup> in R.A. 5h. 26m. 33<sup>s</sup>.7s., and Decl. + 21° 50' 47"; a twelfth magnitude follows it 3<sup>s</sup>.7s., about 1' 18" to the south.

THE GREAT COMET OF 1880.—Dr. B. A. Gould has calculated a third parabolic orbit for the southern comet which he finds to represent his observations very closely; the elements are:—

Perihelion passage, 1880, January 27<sup>d</sup> 4<sup>h</sup> 17<sup>m</sup> Washington M. T.

Longitude of perihelion ...	280 11 10	} Mean equinox,
" ascending node ...	7 7 38	
Inclination ...	35 12 27	
Log. of perihelion distance...	7 <sup>7</sup> 568724	

Motion—retrograde.

He has also computed an ephemeris for February, from which we extract positions and distances for the period during which the tail was visible.

At Washington mean noon.

	Right Ascension.	Declination.	Log. distance from the Earth.	Log. distance from the Sun.
	h. m. s.			
Feb. 2 ...	21 47 38 ...	- 28 57 <sup>m</sup> .6 ...	9 <sup>8</sup> 86856 ...	9 <sup>5</sup> 3319
3 ...	22 3 4 ...	30 8 <sup>m</sup> .8 ...	9 <sup>8</sup> 85728	
4 ...	22 19 12 ...	31 10 <sup>m</sup> .8 ...	9 <sup>8</sup> 84799 ...	9 <sup>6</sup> 2292
5 ...	22 35 54 ...	32 3 <sup>m</sup> .1 ...	9 <sup>8</sup> 84064	
6 ...	22 53 1 ...	32 44 <sup>m</sup> .9 ...	9 <sup>8</sup> 83521 ...	9 <sup>6</sup> 9139
7 ...	23 10 24 ...	33 15 <sup>m</sup> .8 ...	9 <sup>8</sup> 83167	
8 ...	23 27 52 ...	33 35 <sup>m</sup> .8 ...	9 <sup>8</sup> 82994 ...	9 <sup>7</sup> 4677
9 ...	23 45 13 ...	33 44 <sup>m</sup> .9 ...	9 <sup>8</sup> 82997	
10 ...	0 2 17 ...	33 43 <sup>m</sup> .8 ...	9 <sup>8</sup> 83165 ...	9 <sup>7</sup> 79326
11 ...	0 18 55 ...	33 33 <sup>m</sup> .1 ...	9 <sup>8</sup> 83487	
12 ...	0 34 58 ...	33 13 <sup>m</sup> .7 ...	9 <sup>8</sup> 83949 ...	9 <sup>8</sup> 3333
13 ...	0 50 20 ...	32 47 <sup>m</sup> .0 ...	9 <sup>8</sup> 84538	
14 ...	1 4 57 ...	- 32 14 <sup>m</sup> .0 ...	9 <sup>8</sup> 85237 ...	9 <sup>8</sup> 6853

This gives the least distance of the comet from the earth 0<sup>6</sup> 6757 of the earth's mean distance from the sun at about 6h. a.m. Greenwich time on February 9.

THE DIAMETER OF VESTA.—Prof. Tacchini has taken advantage of the recent favourable opposition of this planet to measure the apparent diameter, which with a power of 1,000 on his refractor he found to be, on June 9, 1<sup>m</sup>.706. This value reduced to the mean distance is about double that resulting from Secchi's observation at the opposition of 1855, when he judged the apparent diameter to be a little less than that of the first satellite of Jupiter, or about 0<sup>m</sup>.8, but "molto più debole di luce, e di colore ranciato carico." For distance *unity*, Tacchini's measure gives 1<sup>m</sup>.96, and Secchi's estimate 1<sup>m</sup>.01. Probably we may hear of other measures of Vesta at the opposition of the present year, made with large instruments.

GEOGRAPHICAL NOTES

THE collections in natural history and ethnography brought home from the coasts of Siberia and Eastern Asia by the *Vega* are to be exhibited in the old hall of the Royal Library at the Palace, Stockholm. The exhibition was opened yesterday, and Baron Nordenskjöld invites naturalists and geographers to visit the collection.

AT the German Athenæum last week the Chevalier Ernst von Hesse Wartegg gave a lecture on his recent travels in North Africa, comprising chiefly the southern parts of Algiers and Tunis and the rarely-visited frontier regions between these two countries. Herr von Wartegg's principal aim was the thorough revision and completion of the very defective Tunisian map of the French General Staff, edited in 1858, and the investigation of the Schott region in Southern Tunis, adjoining the Lesser Syrtes. The first object was, according to the lecturer, satisfactorily completed by the substantial aid of the Tunisian Government and the foreign consular body at Tunis. To point out a few instances of the deficiency of the French maps, Herr von Wartegg mentioned the large river Kassab, a tributary of the Medjerdah, which in the map empties into the Mediterranean about 200 kilometres from its actual mouth. Large lakes are entirely omitted, and cities invented which do not exist. The main fault of the map is the erroneous spelling of the topography, Frenchifying and mutilating nearly every name. For instance, the Arab word Sandjak has been turned into "Saint Jacques," &c. Regarding the well-known project of Capt. Roudaire and M. de Lesseppe, the lecturer states that neither the geological formation nor any other sign indicates the former connection between the so-called "submarine basin" in Southern Tunis and Algiers, and he believes, contrary to the sanguine dreams of Capt. Roudaire, that it never was connected with the Mediterranean. According to his observations the submarine basin in the interior approaches the coast only at a distance of about seventy miles, and the canal to be constructed across the isthmus would have to be therefore of that length. The cost of such a work, rivaling the Suez Canal in magnitude, would never be in proportion to the benefit derived, which latter is entirely doubtful. No thorough investigation of the region was ever made, and its results would never be certain, as the constant vibration of the air in this hot climate and the deceptions caused by frequent fogs *morgans* render scientific measurements very problematic. If

the connection between the two basins were to be established, some of the most flourishing cities of the Schott region, like Tômba and Nephta, would be submerged by the floods, and most probably all the large date-tree forests of the Djeric destroyed by the change of climate and the increased moisture. Herr von Hesse Wartegg spoke at length of his travels through the Regency, and mentioned some curious meteorological and botanical observations. The traveller brought back with him a large collection of plants, ethnological objects, and insects, as well as drawings and photographs. He will exhibit his collection at his lecture before the British Association at the forthcoming Swansea meeting.

THE new number of the Geographical Society's *Proceedings* opens with the presidential address on the progress of geography, in which the chief space is devoted to the Arctic regions and Africa; it is supplemented, however, by a summary of Admiralty and Indian surveying operations. A letter is next given from Mr. James Stewart of Livingstonia to the Free Church of Scotland, furnishing a further account of his recent explorations north-west of Lake Nyassa, up to the south end of Lake Tanganyika, and which was accompanied by valuable longitude observations. The latter is illustrated by Mr. Stewart's route surveys, which are of great value from a geographical point of view. Among the notes information is given respecting Dr. Lens' progress in North-Western Africa, which had reached the Foreign Office through the British Minister at Tangier. Dr. Lens is stated to have crossed the Atlas, and Moorish protection being refused him beyond Terodant, he has pushed on alone towards Timbuctoo and the Soudan, disguised as a Mohammedan doctor and accompanied by a Moor named Hadj Ali. There are also interesting particulars respecting the movements of a Roman Catholic missionary expedition to the Matabele country and the Upper Zambesi region.

SIGNOR FRACCAROLI, the delegate of a society formed last year at Milan for the development of commerce with Central Africa, has lately paid a visit, in company with Emiliani Bey, to the centre of the Darfur province, which he found in a state of desolation from the recent wars. After a vain attempt to reach the summit of Jebel Si, a lofty isolated peak in the Jebel Marra, he returned to Khartoum, whence he expected to proceed on a journey up the Balor el Ghazal.

COUNT LOUIS PENNAZZI is about to undertake a journey in Abyssinia and the neighbouring region. He proposes to start from Massowah and visit the city of Gondar and Mount Debra Tabor, hoping to find King John and obtain from him an escort to accompany him through the Gojam province and to the Blue Nile. Thence he will proceed in a west-south-west direction, following the Sobat and the White Nile along the eighth parallel, and eventually join Signor Gessi.

### NEW METALS

WITHIN a period of about two years the chemical world has been startled by the successive announcement of the discovery of no less than fourteen<sup>1</sup> new elementary bodies. All of them are classed as metals, and eleven are said to belong to the yttrium or to the closely-allied cerium group. Without pausing to examine the advisability of announcing the discovery of a new element whenever an unknown reaction crops up, we purpose to give a brief account of these discoveries, and to investigate, as far as possible, what claim they may have to be honoured with a place in our lists of the chemical elements.

In July, 1877, M. Sergius Kern published<sup>2</sup> the discovery of a new metal belonging to the platinum groups, to which he gave the name *davyum*. The *davyum* was, he said, contained in the latter portions of the platinum ores precipitated by hydrogen at 100° together with the rhodium and iridium. The metals having been heated with barium chloride and chlorine in the usual manner, the rhodium and iridium were fractionally precipitated by acid sodium sulphite, and the *davyum* contained in the filtrate thrown down with ammonium chloride and nitrate. From this double chloride an ingot of the metal weighing 0.27 gramme was obtained. The properties of this metal and its compounds, as stated by M. Kern, all agree more or less closely with those of the other platinum metals. It is difficultly fusible, dissolves only in *aqua regia*, possesses an atomic weight of about 100, &c.

<sup>1</sup> M. Lecoq de Boisbaudran's *galium*, the existence of which has now been fully established, is not included in this number.

<sup>2</sup> *Chemical News*, vol. xxxvi. p. 4.

Its specific gravity is, however, said to be 9.38, which is lower than that of any other metal of this group, but approximates to a mixture of rhodium with a little iron. The characteristic reaction is stated to be the red colour produced by potassium sulphocyanate, but unfortunately both iron and ruthenium produce the same result, and M. Kern does not tell us what means he has adopted to get rid of traces of these and the other platinum metals, or to convince himself that they were absent. It is to be regretted that no protest, except a letter of Mr. W. H. Allen,<sup>3</sup> has been raised against this endeavour to foist a "new metal" upon the chemical world, and that too by a chemist who has signalled himself by such inaccurate results in other directions.

Turning now to the recent additions to the yttrium metals, we have in the first place to notice a contribution by Marignac. In the summer of 1878, after examining the earths from gadolinite to establish the existence of terbium, this chemist was induced to attempt a further separation of the erbia obtained in the course of his experiments. These investigations led to the discovery that this pink earth contained another white earth with a somewhat higher atomic weight, and whose salts gave no absorption-spectrum. To the metal contained in this earth the name *ytterbium*<sup>4</sup> was given. These results have recently been fully confirmed,<sup>5</sup> and we may accept the existence of this metal as an established fact. Marignac gave some of his specimens to his colleague, M. Soret, to examine spectroscopically. The latter chemist, operating with sunlight and with a spectroscope of high dispersive power, found that certain lines in their absorption-spectra did not agree with those of erbia, and that this was particularly the case with regard to the violet and ultra-violet portions of the spectra. From these results he was led to suspect the presence of two new earths, one of which he named provisionally X, leaving the other unnamed.<sup>6</sup> All attempts to separate either of these earths were, however, futile.

Shortly afterwards Lawrence Smith published<sup>7</sup> the results of some investigations on these earths obtained from the mineral samarskite, abundant in North Carolina and other American localities, instead of from gadolinite. As the result of his investigations he announced the discovery of a new earth, to which, however, he gave no name. It was, he said, a yellow earth possessing most of the properties of terbia, but differing from it in some reactions. Marignac, who received a sample of this earth, found,<sup>8</sup> on examining it, that its properties did not differ appreciably from those of terbia, and we may very well accept the verdict of this distinguished chemist. Lawrence Smith also stated that the earth called X by Soret had been discovered by him in samarskite about a year previously, and had been named *mosandrum*. He has since admitted<sup>9</sup> that the salts of this metal give no absorption-spectrum, and he has furnished us with no details as its special properties, mode of separation, &c., which are conclusive enough to admit of its immediate recognition as a new metal.

We now come to a number of "new" metals all belonging to the same group, and mainly distinguished by slight differences in the absorption-spectra of their salts and in their atomic weights. The earth named X by M. Soret, as well as the one he left unnamed, have been already referred to. Besides these, two new metals have been announced by M. Delafontaine,<sup>10</sup> which he has named *philippium* and *decipium*. The former is a yellow earth with an equivalent between that of yttria and terbia, the latter a white earth with a higher equivalent; both possess indistinct absorption-spectra. M. Soret, who has examined the absorption-spectra very carefully, thinks it probable<sup>11</sup> that the mixture formerly known as erbia may contain philippia or his unnamed earth, together with the earth X and the real erbia, besides other earths giving no absorption-spectra. Of *decipium* we have no confirmation. These earths have also been investigated by Cleve, in conjunction with Thalén. They came to the conclusion that there are three distinct earths which yield absorption spectra in the old erbia.<sup>12</sup> These they named *thulium*, *holmium*, and the real *erbia*. Subsequently they have admitted<sup>13</sup>

<sup>4</sup> *Chemical News*, vol. xxxvi. p. 33.

<sup>5</sup> *Arch. des Sci., Phys. et Nat.*, vol. lxxiv. p. 101.

<sup>6</sup> Nilson, *Ber. d. deut. ch. Gesell.*, v. xii., p. 550; Humphreys, *Brit. Ass. Reports for 1879*; Lecoq de Boisbaudran, *Comp. Rend.*, vol. lxxviii. p. 2342.

<sup>7</sup> *Arch. des Sci., Phys. et Nat.*, vol. lxxiii. p. 99.

<sup>8</sup> *Comp. Rend.*, vol. lxxvii. p. 246.

<sup>9</sup> *Arch. des Sci., Phys. et Nat.*, vol. lxxiii. p. 279.

<sup>10</sup> *Comp. Rend.*, vol. lxxix. p. 478.

<sup>11</sup> *Comp. Rend.*, vol. lxxviii. pp. 250, 629.

<sup>12</sup> *Arch. des Sci., Phys. et Nat.*, vol. lxxiii. p. 99.

<sup>13</sup> *Comp. Rend.*, vol. lxxviii. p. 478.

<sup>14</sup> *Ibid.*, vol. lxxviii. p. 908.

that M. Soret has priority in the discovery of these new earths, since the absorption-spectrum of holmium coincides exactly with that of the earth X, and thulium is probably the same as the unnamed earth of Soret or the phillipsium of Delafontaine. The existence of these three earths in the yttria group is also acknowledged to some extent by Marignac; it may therefore be considered tolerably certain that these new earths are really contained in this group, whatever names they may ultimately receive. In connection with this we must not omit to mention the investigations of M. Lecoq de Boisbaudran. He has confirmed the results of M.M. Soret and Cleve concerning the three earths mentioned above, and even thinks that he has obtained sufficient evidence of a fourth, named *samarium*. He admits, however, that its separation is too tedious to allow of its extraction in a state approaching purity.

In operating upon the mixture of earths formerly known as erbia Nilson was able to separate, besides the earths giving absorption-spectra and besides ytterbia, another white earth, whose salts gave no spectrum and which possessed a low atomic weight (about 45). The new metal contained in this earth he named *scandium*, and he states that it is distinguished by a special spark-spectrum. These results have been confirmed by Cleve, and he has remarked that many of the properties of this scandium agree closely with the metal whose existence was predicted by Mendeleef under the name of *ekabor*.

The following are a few of the more striking of these resemblances:—

Ekabor	Scandium
At. wt. = 44	At. wt. = 45
Only oxide = $Eb_2O_3$	Only oxide = $Sc_2O_3$
The oxide is white, infusible, and nearly allied to yttria.	
S.G. of oxide = 3.5	S.G. of oxide = 3.8

On the other hand it is difficult to understand how a metal with such a low atomic weight could remain associated with others possessing atomic weights three or four times as great throughout the long process of fractional separation. According to all analogy with yttrium, terbium, and erbium, it ought to remain with the first of these. The following table of the metals of the yttrium group will illustrate the present state of our knowledge with regard to them. The atomic weights are calculated on the supposition that their oxides are of the general formula  $M_2O_3$ —those in italics give distinct absorption-spectra:—

	Scandium (?)	Sc = 45	(Nilson)
	Yttrium ...	Y = 89	Bunsen and Cleve
	<i>Phillipsium</i> ...	Pp = 111	(Delafontaine)
Probably identical	<i>Unnamed metal of Soret</i> ...		
	<i>Thulium</i> ...		
Probably identical	<i>X of Soret</i> ...		Undetermined
	<i>Holmium</i> ...		
	Terbium ...	Tr = 147	(Marignac)
Probably identical	<i>Samarium</i> (?)		Undetermined
	<i>Decipium</i> (?)	Dp = 159	(Delafontaine)
	<i>Yβ</i> ...	... = 149.4	(Marignac)
	<i>Yα</i> ...	... = 156.7	(Marignac)
	<i>Erbium</i> ...	Er	Undetermined
	Ytterbium ...	Yb = 172	(Marignac)

It must also be remarked that Delafontaine has suspected that the didymia obtained from cerite differs from that from samarskite, although Lecoq de Boisbaudran and L. Smith have since shown that the absorption-spectrum of the didymia salts may be considerably altered by making the solutions strongly acid, &c. And it is of course open to question whether some of the spectroscopic differences ascribed to different metals may not be due to differences in the concentration, acidity, &c., of the solutions employed.

It only remains to mention the newly-discovered metals—*niobium* and *vanadium*. The former was announced to English chemists some twelve months ago by Dr. T. Dahll.<sup>5</sup> It is, he says, a white metal, allied to copper in many of its properties, but with a melting-point of about 350° C., and a specific gravity of about 9.4. Its atomic weight would lie between 141.6 and 150.6. The latter metal (vanadium) has been stated by M. A. Seacchi to be present in a green incrustation found on Vesuvius in the fissures of the eruption of 1631. It is, he says, present in

the shape of a red metallic acid, giving colourless salts with the alkalis. Many of its properties agree with those of molybdenum or vanadium, particularly the latter, though M. Seacchi believes that both these metals are absent. Of analytical data only the proportion of silver in the silver salt is given. This is stated to be 48.8, while for the corresponding vanadium salt it would be 52.1, a coincidence too close to be disregarded.<sup>6</sup> Up to the present we are without any confirmation of the existence of these two metals, and we cannot do otherwise than suspend judgment on them for a time.

Indeed the scepticism which the chemist, in common with other scientific men, ought to practise cannot be too strongly insisted upon. No discovery of such importance as that of a new element should be generally accepted until it has been submitted to a series of rigorous confirmatory tests. It is obviously so much better to defer definite judgment until sufficient facts have been collected than to accept a hasty conclusion, probably based only upon one or two anomalous reactions. How often it happens that the chemist describes a reaction not as he saw it, but as he thought he saw it, or as he hoped to see it! Even in cases where the reaction possesses some peculiarity too little attention is often paid to the effects which even traces of other substances may produce, or to any extraordinary conditions under which the experiment may be made, and the chemist at once imagines that he has discovered a "new element." Time alone will prove how many of the fourteen substances enumerated above will pass the ordeal of further and perhaps more rigorous investigations.

T. S. HUMPHREY

Since writing the above M. Marignac has published an account of some investigations on the earths contained in samarskite.<sup>7</sup> He divides these earths into four groups, according to their solubility, in a saturated solution of potassium sulphate:—

- (i.) Those earths soluble in less than 100 parts of the solution.
- (ii.) Those soluble in 100 to 200 parts.
- (iii.) Those only slightly soluble.
- (iv.) Those insoluble.

Group (i.) contains only well-known earths, and particularly yttria and terbia. Their equivalent was always below 119 (oxide = MO). Group (ii.) consists of earths with an equivalent between 119 and 115. It contains traces of the preceding and following groups, but principally consists of a pale yellow earth with an equivalent of about 120.5, and without any absorption spectrum. This earth he provisionally calls *Ya*; its properties do not agree with those of any of the others of this group mentioned above. Group (iii.) contains a considerable quantity of terbia and didymia, together with a colourless earth yielding an absorption-spectrum agreeing with that of Delafontaine's decipia, or better with that of Lecoq de Boisbaudran's samaria. This earth he calls *Yβ*, and he is of opinion that decipia, samaria, and *Yβ* are practically one and the same earth. The equivalent he makes 115.6 (oxide = MO), which would give an atomic weight of 149.4 (oxide  $M_2O_3$ ). Group (iv.) consists principally of didymia, together with considerable portions of the other earths, which it is almost impossible to completely separate.

### UNIVERSITY AND EDUCATIONAL INTELLIGENCE

OXFORD.—At Trinity College one Millard Scholarship, tenable for four years during residence, and of the annual value of 80*l.* without limit of age, will be awarded in October next for proficiency in natural science if any candidate of sufficient merit offers himself. The subjects of examination will be chemistry and physics. Candidates may also offer mathematics, if they wish to do so, and give notice a week before the examination. Special weight will be attached to excellence in one or two subjects, rather than to a less thorough knowledge of all. The scholar elected will not necessarily be required to commence residence immediately. The same papers will be set in chemistry and physics as in the examination for the Natural Science Scholarship at Exeter College. Every candidate will be considered as standing at both colleges, unless he makes a statement to the contrary on entering his name. Candidates are requested to state which college they would prefer in the event of their being elected at both colleges. The president will receive the names of candidates, and their testimonials of character, on Wednesday, October 13, between 8 and 9 p.m.

<sup>1</sup> *Arch. des Sci., Phys. et Nat. (loc. cit.)*.  
<sup>2</sup> *Chem. Reviv.*, vol. lxxix., pp. 212 and 326.  
<sup>3</sup> *Ibid.*, vol. lxxviii., p. 643.  
<sup>4</sup> *Comp. Rend.*, vol. lxxix., p. 419.  
<sup>5</sup> Lavoisier's *vanadium* is not included in this list, since its existence is no longer probable.  
<sup>6</sup> *Chem. News*, vol. xl., p. 25.

<sup>7</sup> *Rev. d. Anal. Ch. Compl.*, vol. xiii., p. 250; *Marignac*, vol. x., p. 499.  
<sup>8</sup> *Comp. Rend.*, vol. xc., p. 899.

## SCIENTIFIC SERIALS

*Proceedings of the Linnean Society of New South Wales*, vol. iv. Part 3, 1879, contains:—W. A. Haswell, on the Australian amphipoda, with thirteen plates, describes many new species and several new genera; of these latter, one, *Amaryllia*, is unfortunately already familiar to the botanist; another, *Glycera*, has been in use since the days of Savigny as a generic name in the animal kingdom; on the phyllosoma stage of *Ibacus peronii*; notes on the anatomy of birds; on the cylostomatous polyzoa of Port Jackson.—E. P. Ramsay, notes on birds from the Solomon Islands.—Prof. F. W. Hutton, on the genus *Phalacrocorax*.—W. Macleay, on the Clupeidae of Australia.—Dr. James Cox, on the genus *Cypræa*.—Rev. J. Tenison Woods, on some new Australian echini (plates 13 and 14), describes *Hemister apicatus* (sp. n. and *Phyllacanthus parvispina* (sp. n.), and gives a revised list of all Australian echini (fifty-eight in number); on *Heterosamma michelinii* (plate 15); on a new species of *Disticophora*; on some fossils from Fiji; on some post-tertiary fossils from New Caledonia.—R. B. Read, on *Doris arbutus*, Angus (plate 17).

*Atti della R. Accademia dei Lincei*, Fasc. 4, vol. iv., March.—Light and the transpiration of plants, by Dr. Comes.—The *Climax* volcano, by S. Verri.—On *Edwardia clareida* (*Halcampa claf.* of Panzer), by Dr. Andrea.—Fierasfer, by Prof. Emery.—On some ancient eclipses of the sun, and that of *Agathocles* in particular, by S. Celoria.—On movements of a surface which does not constantly touch another fixed surface, by Prof. Gautero.—The *Bacillus malarie* in the region of Selinunte and Campobello, by S. Tommasi-Crudeli.—Studies in experimental pathology on the genesis and the nature of abdominal typhus, by Prof. Tizzoni.—On the variations of area described by the moon about the earth, produced by solar action, by S. de Gasparis.—Reply on the secular variations of the magnetic needle in Rome, by Dr. Keller.—On neutral tungstates of cerium, by SS. Cossa and Zecchini.

Fasc. 5, April.—The colours of animals, by Dr. Camerano.—On some noteworthy configurations of points, straight lines, and planes, of conics and of surfaces of the second order, by Dr. Veronese.—On some observations of S. Klocke on striæ of dissolution of chrome alum, by Prof. Uzielli.—On yellow incrustation of the Vesuvian lava of 1631, by S. Hofman.—On bromocamphor, by Prof. Schiff.—On the chemical constituents of *Sterocaulon vesuvianum*, by Prof. Paterno.—On some new reactions of guanina, by Prof. Capranica.

THE *Bulletin de l'Académie Royale des Sciences de Belgique*, No. 3.—Researches on the nervous system of the Arthropoda; constitution of the œsophagean ring, by M. Liénard.—Notice on the Austro-American Cucurbitaceæ of M. Ed. André, by M. Cogniaux.—Aspect of the planet Mars during the opposition of 1879, and observations of the red spot of Jupiter and of the spots of Venus, by M. Zerby.—Several reports on memoirs.

THE *Rivista Scientifico-Industriale*, No. 8, April 30.—The nefoscope, a new instrument for showing the direction of motion of clouds, by Prof. Fornioni.—The Etna observatory, by S. Da Roberto.—Considerations on regular polygons, by Prof. Mantino.

*Journal of the Franklin Institute*, June.—Influence of speed on the frictional and air resistances of an unloaded steam-engine and its connected lines of shafting, by Chief-Engineer Isherwood.—The decimal gauge, by R. Briggs.—Review of the report on the Irwin injector, by W. Lewis.—Eye memory (continued), by C. G. Leland.—Nodal estimation of the velocity of light, by P. E. Chase.—Early use of anthracite coal in Pennsylvania.—On the adhesion of belts, by J. H. Cooper.

*Reale Istituto Lombardo di Scienze e Lettere*, vol. xiii. Fasc. viii. and ix.—Geo-mechanical solution of some problems of interpolation, by Prof. Jung.—Compensation of *proportional errors* by a given system of direct observations, by the same.—On cooling of a liquid in contact with a body in course of liquefaction or of vaporisation, by S. Cantoni.—Influence of temperature on the distribution of magnetism in a permanent magnet, by Dr. Poloni.—A curious phenomenon presented by boiling liquids, by Dr. Grand.

Fasc. x. and xi.—On the origin of red earth in the vegetation of the calcareous soil, by Prof. Taramelli.—On the problem of the tautochrone, by Prof. Formenti.—On two new species for the Italian flora, by Prof. Ardizzone.—On the aberration of

sphericity in lenses of ordinary strength and aperture, and in centred dioptric systems, by Prof. Ferrini.—On the necessity in Italy of a geological institute independent of the R. Corps of Mining Engineers, by Prof. Taramelli.—On neuropathic arthritis, by Prof. de Giovanni.—On *Cilio-flagellati*, by Prof. Maggi.—On a theorem of Abel and some of its applications, by Prof. Beltrami.

## SOCIETIES AND ACADEMIES

## LONDON

Royal Society, June 17.—"Notes of Observations on Musical Beats." By A. J. Ellis, F.R.S.

This paper gave the results of three years of observations for the purpose of discovering the cause and amount of error in Appunn's reed tonometers, and for obtaining materials for the writer's "History of Musical Pitch" (*NATURE*, vol. xxi. p. 550). The principal results were these:—In free air the number of beats between two musical notes are exactly equal to the difference of their pitch, or number of double vibrations made in one second by the lowest partial or prime; this was proved by the exact agreement of the pitch of the forks in Scheibler's tonometer, determined by such beats, with their measurement by Professors McLeod and Mayer, and with the results of Koenig when reduced to a uniform temperature. For this reduction the coefficient by which the number of vibrations must be multiplied for each degree Fahrenheit varies from '00004 to '00006, and may be assumed as '00005 (forks flattening by heat and sharpening by cold). It differs for different forks, and depends on the action of temperature on elasticity. Tuning-forks are very stable, proved by the fact that Scheibler's extreme forks have not varied by one-tenth of a vibration in a second since his death in 1837, and that a fork measured and marked by himself as 438 single vibrations, that is, 219 double vibrations, fifty years ago, although much rusted, has not lost more than 0'3 d. vib. Beats which take place in confined compressed air, as in Appunn's reed tonometers, are accelerated by 76 in 10,000, or, say  $\frac{1}{2}$  per cent., as a mean; proved by taking the beats within and without the box of the tonometer, and determining the pitch of the reeds by beats with Scheibler's forks, the two means agreeing precisely. All beats are beats of the simple partial tones of which the compound tones are made up; proved by the bell-like beats of the disturbed unisons and higher consonances in Appunn's tonometer, while the "surge" of the non-beating partials was distinctly evident, and by the beats of the higher upper partials themselves of very low and very compound reed tones in a single note. The independent existence of the partial tones, without any assistance from reinforcing resonance cavities, was proved by determining the pitch of low reeds by the beats of their upper partials with the prime or lowest partial of different forks; thus the pitch of a reed of 31'47 vib. was determined by beats with partials 7, 9, 10, 11, 12, 13, each with a different fork, and the results varied only from 5 to 9 in the second place of decimals; the pitch of a reed of 11'90 vib., of which the prime was quite inaudible, was determined by beats with partials 20 and 28, giving 11'88 and 11'91 respectively. The best mode of constructing a tuning-fork tonometer was shown to be dependent on the fact that all tuning-forks contained their own octave, or second partial, distinctly enough to count beats between it and a fork forming its approximate octave, so that there was no occasion to tune an octave. Practical directions were given for this construction. Practical directions for performing the experiments on Appunn's tonometers have been deposited at the South Kensington Museum, where the instruments used exist, especially for the delimitation of the higher consonances and consonances where the terms of the ratios are any of the numbers 1 to 16.

"Preliminary Note on the Ossification of the Terminal Phalanges of the Digits," by E. A. Schäfer, F.R.S., and F. A. Dixey, B.A.

The diaphyses of the ungual phalanges of the digits offer an exception to the usual mode of ossification of diaphysal bones (including the other phalanges) in the fact that the calcification of the cartilage and its attendant changes begins at the tip and not in the centre of the diaphysis. The subperiosteal intramembranous ossification also commences at the same point—the tip, namely, of the cartilage—as a cap-like expansion over the end of the cartilage. The irruption of the osteoblastic subperiosteal tissue also first occurs here, so that this part seems to correspond morphologically with the centre of the shaft of other

long bones. The expanded portion of the phalanx which bears the nail, claw, or hoof is entirely formed by an outgrowth of the subperosteal bone, and is not preceded by cartilage.

A detailed account of the mode of ossification of these phalanges will be shortly published.

"The Aluminium-Iodine Reaction," by J. H. Gladstone, Ph.D., F.R.S., and Alfred Tribe, F.C.S., Lecturer on Chemistry in Dulwich College.

"Note on the Discovery of a Freshwater Medusa of the Order Trachomedusæ," by E. Ray Lankester, F.R.S. (See NATURE, vol. xxii. p. 147)

"Note on the Bearing on the Atomic Weight of Aluminium of the Fact that this Metal occludes Hydrogen," by J. W. Mallet, F.R.S.

Zoological Society, June 15.—Prof. W. H. Flower, F.R.S., president, in the chair.—The Secretary exhibited the skin of an antelope received from the Gaboon, and remarked that it appeared to belong to the female of an undescribed species of *Tragelaphus*, allied to *Tragelaphus speki*, which he proposed to name *T. gratus*.—Dr. A. Günther exhibited and made remarks on a series of horns of the Sambur deer of Borneo.—Mr. W. T. Blanford made some remarks on the proper name of the Himalayan marmots, now living in the Society's Gardens, which he believed to be *Arctomys hodgsoni*.—Prof. Mivart called attention to the Meduse, now living in the Victoria-Lily house, in the Botanic Gardens, Regent's Park.—Mr. Edward R. Alston read a paper on *Antechinus* and its allies, in which he described the anatomy of that little-known marsupial. He regarded the four genera, *Phascogale*, *Antechinus*, *Podabrus*, and *Antechinomys* as constituting a sub-family of the *Dasyurida*, the first and the second, and the third and the fourth, being most nearly related to one another.—Mr. G. E. Dobson read a paper on some new or rare species of Chiroptera, in the collection of the Göttingen Museum. Amongst these was a new species of *Megaderma* from Australia, which, on account of its large size, Mr. Dobson proposed to name *Megaderma gigas*.—Mr. W. A. Forbes read a paper on the anatomy of *Leptasoma discolor*, and adduced further evidence to show that this bird is related not to *Cuculida*, but to the rollers (*Coraciidae*).—A second paper by Mr. Forbes contained remarks on two rare Ploceine birds in the Society's collection (*Vivana splendens* and *Ptyelia wieneri*).—Mr. Forbes likewise read some notes on the anatomy of a male Denham's Bustard, lately living in the Society's Gardens, and on its mode of "showing off" when alive.—Mr. Edgar A. Smith read the descriptions of twelve new species of shells from various localities. Specimens of all but two were in the collection of the British Museum.—Sir Walter Elliot, K.C.S.I., read some notes on the Indian Bustard, and its manner of "showing off," as observed by him in India.—Mr. F. H. Waterhouse read a list of the dates of publication of the several parts of Sir Andrew Smith's "Illustrations of the Zoology of South Africa."—Mr. A. W. E. O'Shaughnessy read the description of a new species of lizard of the genus *Anolis*, from Ecuador, which he proposed to call *Anolis buckleyi*, after its discoverer, Mr. Clarence Buckley.—Mr. Selater read a paper containing a list of the certainly-known species of Anatidae, with notes on such as have been introduced into the zoological gardens of Europe.—Mr. Wilfred Powell read some notes on the habits of the Mooroop (*Casuarus bennetti* of New Britain).

Anthropological Institute, June 22.—Edward B. Tylor, F.R.S., president, in the chair.—Mr Wilfred Powell exhibited a collection of ethnological objects from New Britain and New Ireland. Amongst them was a mask formed from a human skull and a sling which was chiefly remarkable for its great length.—Don Francisco P. Moreno exhibited two skulls from Patagonia (Rio Negro).—Prof. W. H. Flower, F.R.S., gave the substance of a paper on a collection of crania from the Fiji Islands. The two principal islands of this group are Viti Levu and Vanua Levu; until very recently [we have had no skulls from either of these islands, all that have reached Europe having come from one or other of the small Eastern Islands. There has been for some time in the Museum of the Royal College of Surgeons one skull obtained from the hospital at Hobart Town, which was said to be Fijian, but this specimen is not at all typical, but rather misleading in its characters. These skulls (fourteen in number) were all found by the Baron Anatole von Hügel in the same cave in the Landongo district, quite the northern end of Viti Levu. No skull has ever been brought from the northern island, Vanua Levu. The most noticeable

feature is the great similarity between the skulls; in every essential particular they are precisely alike, proving that they belong to a pure race. They are the longest and narrowest of any known, the average cephalic index being 66; they are also very high skulls. All these skulls are prognathous and platyrrhine, the alveolar index being 102 and the nasal index 57. They are also mesosemes, having an orbital index of 85. A great difference is seen between these skulls and Samoan skulls, and five skulls from Vanua Velava, where the two races are brought into contact, show characters between these two extremes:—

	Bi	Hi	Al	Ni	Oi
Fiji ... ..	66	74	102	57	85
Vanua Velava ...	72	75	101	50	88
Samoan ... ..	83	78	98	44	92

Meteorological Society, June 16.—Mr. G. J. Symons F.R.S., president, in the chair.—T. W. Barry, M.D., A. W. Martin, and C. E. Peek, were elected Fellows, and Señor A. Aguilar and Dr. H. H. Hildebrandsson were elected honorar members of the Society.—The following papers were read:—Ozone in nature, its relations, sources, and influences, &c., from fifteen years' observations ashore and afloat under all conditions of climate, by J. Mulvany, M.D., R.N. The meteorological elements with which ozone is most intimately associated are such as occasion high vapour tension and a high degree of saturation therefore it is promoted by wind passing over a large aqueous expanse and by heat producing rapid evaporation. Hence heat if humid is no bar to atmospheric ozonisation, but no definite relation exists in the atmosphere between that *per se* and ozone its relation to humidity is more definite and direct, but subject to many exceptions; in consequence of this relation it most ably where its chemical qualities render it most useful. It appears to be formed in the upper strata and to be carried down by rain-drops, whose office is vehicular. The spherules which constitute clouds, and have their origin in radiations, condensation, have a similar office. Ozone does not diffuse readily downwards, so that when the lower strata are robbed of ozone by jungle, &c., a considerable difference in ozonic condition close to and at 170 feet above the surface exist. The author is of opinion that no disease can be traced to ozone as met with in the atmosphere.—The height of the barometer in London, by Henry Storks, M.A., F.M.S.—Note on a waterspout observed at Morant, Jamaica, March 23, 1880, by Lieut. Alfred Carpenter, R.N. F.M.S.—Account of a balloon ascent from Lewes in a west wind on March 23, 1880, by Capt. James Templer and A. Elsdale.—Results of meteorological observations made at Stanley, Falkland Islands, 1875-77, by William Marriott, F.M.S.—A new thermograph, by William David Bowkett.—The winter climate of Davos, by C. T. Williams, M.D., F.M.S. Among the high altitude sanatoria of Europe, Davos at present enjoys the greatest reputation, partly on account of its easy accessibility, and partly on account of certain peculiarities of position and shelter. The valley of Davos lies in the canton of the Grisons, between the valleys of the Lower Rhine and the Upper Engadine. The valley runs from N.N.W. to S.S.E. for about ten miles in length, with an average breadth of about a third of a mile, being for the most part of this extent a plain gently sloping towards the north, and varying in elevation from 5,400 to 4,500 feet. Davos Platz is 5,105 feet above the sea level. The author discusses the observations made during the four winters of 1876-7 to 1879-80. The peculiar effects of Davos winter climate seem to depend on (1) the rarefaction of the atmosphere; (2) its dryness; (3) the absence of strong currents, owing partly to shelter and partly to the uniform layer of snow spread around; and (4) the large percentage of the direct solar rays reaching the locality, owing to rarefaction of the air, and also the considerable amount of heat reflected from the extensive snow plain in front of the village of Davos Platz.

Royal Microscopical Society, June 9.—Dr. Braithwaite, vice-president, in the chair.—The following papers were read:—On the relative visibility of minute structures in solutions of phosphorus, sulphur, &c., by Mr. Stephenson.—On the life-history of the Diatomaceæ, illustrated by a large number of coloured drawings, by Prof. Hamilton L. Smith.—On a parabolised gas slide, by Dr. Edmunds.—On the structure and functions of scale leaves of *Lathraea squamaria*, by Mr. Gilbert.—On the interference-phenomena produced by luminous points, by

Mr. Woodall.—On an isothermal binocular microscope, by Mr. Woodall. —On the theory of microscopic vision, by Prof. Abbe. —Amongst the objects exhibited were new treatises by Dr. Matthews; slides illustrating invertebrate embryology, by the Naples Geological Station; and several new forms of microscopes and apparatus by Mr. Crisp.

PHILADELPHIA

Academy of Natural Sciences, February 17.—Germination of acorns, by Mr. T. Meehan. March 2.—Report on plants introduced by means of the International Exhibition of 1876. March 9.—Dr. H. Allen on the mammary glands of bats. March 16.—Carcinological notes, No. 4, by J. S. Kingsley. March 23.—On the gestation and generative apparatus of the elephant, by H. C. Chapman, M.D.

PARIS

Academy of Sciences, June 28.—M. Edm. Becquerel in the chair.—The death of M. Lissajous was announced.—The following papers were read:—Researches on the determination of wave-lengths of calorific rays at low temperatures, by MM. Desains and Curie. A beam of dark heat was sent through a slit to a grating of fine wire, opposite which was a rock-salt lens; beyond this lens the calorific image was formed, and examined with a thermopile. The results mainly agree with those of M. Mouton (by another method).—On the heat of vaporisation of anhydrous sulphuric acid, by M. Berthelot.

On the vapourisation, about 18°, absorbs - 5.9.—On some general relations between the chemical mass of elements and the heat of about the earth's regulators with vanes, by M. Villarceau. M. Breguet by Dr. Keller. —On the apparatus for Lisbon Observatory for and Zecchini.

Fasc. 5, April. —On some new species of the genus Dasyurus, from New Guinea, Veronese. —On the new species of the genus Dasyurus, from New Guinea, Veronese. —On the Australian D. hallucatus. —Craniology of African negroes of the Vesolichocephalic races, by MM. Quatrefages and Hamy. —On the causes of variation in the results of anthracic inoculation Stereocaulon vesuvianum sheep; influence of infectant agents; applications of the theory of immunity, by M. Chauveau.—Results obtained

THE Bulleatment of vines with sulphocarbonate of potassium, by M. No. 3.—Retréc.—On the healthiness of the Isthmus of Panama, by M. constitution Lesseps. Many persons affected by yellow fever have landed he Austrone without restriction, but the fever has not at all spread. Cognian M. de Lesseps' opinion that quarantines could not prevent epidemics from spreading where their spread was favoured by atmospheric conditions, was called in question by M. Bouley.

—On a new form of galvanometer, by M. Gostynski. Proportional intensity is gained to nearly 90°. The bobbin is continuous, or without slit for passage of an astatic system. A U-piece of aluminium wire hung by a cocoon fibre supports two astatic systems of the same kind, crossed at 45° and connected. A small mirror above the aluminium wire reflects the divisions of a semi-cylindrical scale.—On an apparatus for registering the law of motion of a projectile, &c. (continued), by M. Sebert. This relates to the case of the projectile meeting a sudden resistance, as when entering sand. A plan for reording the law of motion in the entire bore of the gun consists in having two guides and runners in the projectile; one runner is free, and on reaching the end of its course it removes a stop holding the other, which then begins its motion. The resistance of the air in part of the course might similarly be measured.—On the existence in tobacco-smoke of prussic acid, of an alkaloid as poisonous as nicotine, and of various aromatic principles, by MM. Le Bon and Noel. The alkaloid seems identical with the compound collidine, got in distillation of several organic substances.—Researches on the electric properties of collodium, with reflections on the nature of static electricity, by M. Leure. Collodium in thin sheets is negative with all bodies.—On transcendents which play an important part in the theory of planetary perturbations, by M. Callandreau.—On the application of the theory of sines of superior orders to the integration of linear differential equations, by M. Farkas.—Vibrations on the surface of liquids, by M. Lechat. Lagrange's supposition is incorrect, that below a very slight depth the influence of depth is null.—Relation between

the major and minor modes in the gamut agreed according to equal temperaments, by M. Ricard.—Strong and constant voltaic pile, furnishing results susceptible of regeneration by electrolysis by M. Reynier. The zinc (un amalgamated) is in caustic soda solution, the copper in sulphate of copper solution, separated from the other by a rectangular vessel of parchment paper (several thicknesses). The electromotive force is 1.2 volt at 1.5 volt, according to concentration. The couple is regenerated by passing through it the current of a magneto-machine. M. Edm. Becquerel said the arrangement was not new, his father having used a similar one.—On the mechanical effects in a magnetic core from magnetising action of an electric current, by M. Ader. He has proved that all bars of magnetic nature submitted to the mechanical action of compression, torsion, or traction, tend to recover their original molecular arrangement under influence of the magnetising current.—Independent optical compass for iron clads, by M. de Fraisséix.—Thermal study of alkaline polysulphides, by M. Sabatier.—On the transformation of amylen and valerylene into cymene and benzenic carburets, by M. Bouchardat.—On the etherification of hydriodic and hydrochloric acids, by M. Villiers.—On anhydrous crystallised lime, by MM. Levallois and Meunier. This was found on the walls of a kiln of bauxite, for burning lime.—On the presence of iron in falls of dust in Sicily and Italy, by M. Tacchini. This iron is thought to have come from the Sahara.—On the organisation and development of Gordians, by M. Villot.—On an asorian destroy of the gallicolar phylloxera, by M. Pickard.—Zinc: its existence in the state of complete diffusion in all rocks of the primordial formation and in the waters of seas of all ages, by M. Dieulafait.—On the cretaceous formation of the Northern Sahara, by M. Rolland.—On the discovery of new mammalia in the phosphate of lime deposits of Quercy, by M. Fülhol.—On the transmissibility of tuberculosis by milk, by M. Peuch. This was proved in pigs and rabbits which drank the milk of diseased cow. MM. Bouley and Larrey made remarks on the subject.

VIENNA

Imperial Academy of Sciences, April 22.—The following among other papers, were read:—A new synthesis of sulphydric acid, by Herr Andreasch.—A new derivative of sulphydric acid, carbonyl sulphonic acid, by the same.—On some transformation-products of rufigallic acid and the so-called oxychinon, Dr. Schreder.—Geological Researches in the Western Balks and neighbouring region, by Dr. Joule.—Diluvial fauna Zuzlawitz, near Winterberg, in the Böhmerwald, by Fr. Woldrich.

CONTENTS

THE TAY BRIDGE . . . . . 237
CAMPS IN THE CARIBBEES . . . . . 238
A NEW ENGLISH TEXT-BOOK OF BOTANY . . . . . 239
LETTERS TO THE EDITOR:—
Ocean Circulation.—Dr. WILLIAM B. CARPENTER, F.R.S. . . . . 247
The Freshwater Medusa.—Prof. J. ALLMAN, F.R.S. . . . . 252
On the Simplest Continuous Manifold of Two Dimensions and of Finite Extent.—C. J. MONRO . . . . . 254
A Fourth State of Matter.—E. DOUGLAS ARCHIBALD . . . . . 256
Minerva Ornaments.—Prof. A. H. SAYCE . . . . . 258
Arthur Young's Travels in France.—Prof. S. P. THOMPSON . . . . . 259
" Saxifraga umbrosa " adorned with Brilliant Colours by the Selection of Syrphidae.—Dr. HERMANN MÖLLER . . . . . 260
Dilatation of the Iris.—W. M. F. P. . . . . 261
Comparative Curves in Terrestrial Magnetism.—J. CARBONEL (With Diagram) . . . . . 262
Effects of Lightning on Trees.—L. CUMMING . . . . . 263
Iron and Hydrogen.—H. V. JOHNSTON-LAVIS . . . . . 264
" Coccoloba levis "—H. KING . . . . . 265
Recall of Apparatus of Books, &c.—CORNELIUS WALFORD . . . . . 266
Sugar Horns.—HERBERT ELLIS . . . . . 267
Copp and King Stones.—W. S. . . . . 268
Diatoms in the London Clay.—W. H. SHREUBOLE . . . . . 269
WATER SUPPLY. By CHARLES ERIN . . . . . 270
TAYLOR'S EXPERIMENT IN MEASUREMENTAL SPECTROSCOPY, II. By Prof. PIAZZI SERRA . . . . . 271
PNEUMATIC CLOCKS (With Illustrations) . . . . . 272
NOTES:—
OUR ASTRONOMICAL COLUMN:—
The Variable Nebula near Tau 1 . . . . . 273
The Great Comet of 1865 . . . . . 274
The Diameter of Vesta . . . . . 275
GEOGRAPHICAL NOTES . . . . . 276
NEW METALS. By Prof. T. S. RICHMOND . . . . . 277
UNIVERSITY AND SOCIETY INTELLIGENCE . . . . . 278
SCIENTIFIC BOOKS . . . . . 279
RECEIVED AND FORWARDED . . . . . 280



THURSDAY, JULY 15, 1880

## THE NEW MUSEUM OF NATURAL HISTORY

MR. WATERHOUSE'S new building at South Kensington has, we believe, been formally handed over to the trustees of the British Museum, and as will be seen by their Report, which we give in another column, it is in contemplation, or was so at the time the report was drawn up, to remove several portions of the natural history collections on to the new site during the present year. Up to this time, however, little has been done in the matter. The only beasts and birds to be seen in the new building are those stone images which it has pleased Mr. Waterhouse to place upon the corbels without and upon the pillars within. It is perhaps only fair that if the inside is devoted to natural history the outside should be similarly devoted to unnatural history, and architects must have their way. It may also be observed that if the trustees have really taken possession they have sadly neglected their garden department, for the vacant space round the building, which was nicely laid out last year, has been allowed to become overrun with weeds and rubbish. There are two subjects, we believe, which have caused some delay in the proposed removal—the questions of the library and of the mode of government of the new institution. The last-named and most important point being, as the Secretary of the Treasury had stated, still “under the consideration of my Lords,” we will make so bold as to tender them a few words of advice on the former subject which also requires their serious attention.

A Library of Reference is, as we need hardly tell the readers of NATURE, an indispensable addition to a Museum of Natural History. No scientific work can be done without it. Of this we may remark the trustees appear hardly to have been aware, if, as we are informed is the case, there is no special room set apart for a library in the new museum. Had the trustees put aside a thousand a year, out of their annual grant of 10,000*l.* for printed books, for this purpose, when it was first determined to remove the natural history collections ten years ago, there would have been by this time in existence a library fully adequate for the purpose. But no provision of this sort appears to have been thought of, and it is only within the last year or so, when the building is ready and the time is come to remove the natural history collections into their new quarters, that any application for the necessary funds to buy a library has been made to the Treasury.

Now the special function of the Secretary of the Treasury is, as everybody knows, to keep down expenditure. We need not, therefore, be surprised if when the request was made to him for 30,000*l.* to buy a library of natural history books Sir Ralph Lingen stood rather aghast, and demanded time to consider the subject. But even were this great official most benevolently disposed towards the new natural history museum and ready to produce the sum demanded at once it would not by any means enable the trustees to meet the object in view. It is by no means simply a case of going into the market and ordering all the books required of the first bookseller. The greater number of the works required are out of print, and only to be

picked up at scattered intervals at second-hand shops. To endeavour to purchase them all at a moment's notice would be simply useless. This is another reason why the policy above recommended of collecting the required library by slow degrees should have been adopted.

There is now in fact only one way out of the difficulty. It is a very simple one, but we fear the trustees will not like it. The naturalists and students of the British Museum have hitherto had the use of the Great National Library, which contains all the necessary scientific books. Let these necessary books be removed along with the collections to South Kensington, not as a *gift*, but as a *loan* to the new institution. Let the trustees devote an annual sum of such an amount as they can conveniently employ to their redemption—that is, to the purchase of second copies of these scientific books. As soon as the duplicates are received at South Kensington let the originals be returned to the British Museum. Thus the Great National Library will ultimately recover its own completeness, while at the same time the new museum of natural history at South Kensington will be able to start work with a perfect library—which could in no other way be provided for it. Moreover instead of having to find some 25,000*l.* of 30,000*l.* at the present moment, the Treasury is now able to spread the necessary expenditure over different years, during which it is certain that many of the observed volumes unattainable at the present moment will be brought into the market. The only objection to this, which can be seen is that it will be sometimes necessary to apply for a particular volume at the rate of 2*l.* when the British Museum to South Kensington. It is once understood that the natural history people will very soon leave the lungs, if for them.

The real difficulty in the present situation is that the control of the whole museum is in the hands of the principal librarian, who naturally enough prefers the library to that of the natural history. He is not enough to get rid of the beasts and birds, but when you ask him to give up, even temporarily, a portion of the books it is quite another question. Very few of the trustees who are nominally his masters care anything for natural history, so that from that quarter no intervention can be looked for in favour of the scheme we have put forward. The only way in which it can be carried out is by the *vis major* of the Treasury, which, as the plan is not only advantageous, but also economical, should surely be exerted in its favour.

If the Government had taken the advice of the Duke of Devonshire's Commission, and handed over the natural history collections to a director under the control of the Department of Science and Art, there would have been some one sufficiently interested to make a stir on the subject. As the matter now stands the principal librarian can of course do as much as he pleases, and will, no doubt, keep his books in Bloomsbury as long as possible.

## ELEMENTARY EDUCATION

LORD NORTON and his friends seem determined to take every opportunity of hunting down the present system of education in Government elementary schools

Last week the subject was again introduced in the House of Lords, with, as before, an unsatisfactory result. The action of Government with reference to Scottish educational endowments is rather an impressive commentary on the conduct of the obstructives who are so anxious to reduce the standard of education in England. The effect of the Scotch measure will be greatly to extend the means of education for those who usually attend Board Schools, placing as it does at their disposal the education to be obtained in secondary schools, an advantage, we should think, likely to be largely taken advantage of. Until some similar course be taken with reference to England, where so many valuable educational endowments have been diverted from their legitimate purpose, it seems to us cruel rigidly to limit the function of elementary schools in reference to pupils of exceptional promise. Still more cruel is it to turn out the great bulk of the children with an education quite unworthy of the name, and which renders them little better fitted to cope with their surroundings than if they were entirely unlettered. It is our bounden duty, since we insist on keeping children at school till a certain age, to do the best we can for them; and to turn them out equipped with nothing more useful than the Prof. Tiz's is a mere mockery of education. If reading, Reply on the merits, is to be a really useful acquisition, let by Dr. Keller, we understand that there are things quite as and Zecchini, and quite as well worth reading about as the Fasc. 5, April. On some notable planes, of course, men and working women of the future, Veronese.—On a little time to put the three R's to much use, solution of chrom, ion of the Ver, all grounded in the elements of one or two of vocamphor, by ul of the sciences, they will have a continual Sterocaulon ve, casure within themselves, requiring neither eactions of g, e mens, but only the exercise of thoughtful obser-

THE Bulletin that education is admittedly the best which to. 3.—Reply, constituting one to cope most successfully with the difficulties be Austr, surroundings, and we cannot see how any candid ognis will deny that for this purpose an accurate training in the science of common things is worth all the books in the world. That the Government system as at present established commends itself to the sense of the people is clear from the fact that Government schools are practically killing all competitors. As to the dread of the over-education of the people, this is a bogey which only needs to be stared at to vanish. Do we find any lack of men and women to do all sorts of work in Germany or France, or in any other country where the people have a really substantial education? In nearly every county of the kingdom are local scientific societies, many of which are composed mainly of working men who have educated themselves into whatever they may know of science; but we have yet to hear that they are more discontented with their position than unlettered Hodge. The real truth is, as is too clearly shown on the Continent, the better educated the working man is, the better workman does he turn out to be. The great mistake is to confound a smattering with a grounding, and this, it seems to us, is the mistake made by Lord Norton and those who side with him, and possibly may account for the opposition to the Fourth Schedule. The exclusive use of such a reading-book as Lord Norton threatens to compile would be the best help to a smattering education; a very few hours a week devoted to a few well-selected experiments,

the judicious use of specimens and diagrams, a little training of the observing faculties of children, and the systematic teaching of the great elementary facts of one or two sciences would be a welcome relief to the pupils, and would do far more for their real education than a library of reading-books.

Sir John Lubbock has given notice that he will shortly introduce the subject into the House of Commons; it is inconceivable that that body will permit anything like retrogression in the matter of education; they cannot do so without being liable to the imputation of class legislation. At the best, our working men and working women, it must be confessed, have a hard life of it, many of their hardships resulting from ignorance of the commonest laws and facts of nature. If we wish to make them contented with their lot, let us lighten it by enlightening their minds and giving them the means of making the best of their circumstances. It is against the teaching of all history to maintain that what the retrogressionists are pleased to call over-education will lead to all sorts of political and social evils. It is, history tells us plainly enough, the ignorance, and not the enlightenment, of the people that should be feared. The better educated we are all round the more likely are we to keep our foremost place among nations who have already, solely by the superior education of all classes, got ahead of us in some important respects, and the more likely are we to continue to advance by gradual evolution instead of by violent revolution, which always requires a large substratum of ignorance to work with.

#### ARGENTINE ENTOMOLOGY

*Hemiptera Argentina enumeravit, descripsit, et novae descripsit Carolus Berg (Curo) Böhmeharic, ex typographia Pauli E. Coni. Han biblopolis gassmannii. (Frederking et Graf,*

ENTOMOLOGY is finding a new co. nos Ayres; synchronous with the first part of Dr. Burmeister's treatise on the Lepidoptera of the Argentine Fauna, lately noticed in these columns, has appeared the above work on the less popular and very much less known order Rhynchota. In common with many entomologists, we use this last term rather than that of Hemiptera, as written by our author, for the following reasons. Linnæus founded the order Hemiptera, but included therein non-allied insects, to which the name Orthoptera was ultimately applied by Olivier, whilst Fabricius was the first to separate the true "bugs," under the name of Ryngota, which was afterwards linguistically purified into Rhynchota. Not only, however, did the great Swedish naturalist first propound the order Hemiptera, but we are also indebted to Sweden, in the person of the late Prof. Stål, for gathering together with critical and exhaustive care the descriptive work of an intervening century, and, by the help of a splendid collection formed at Stockholm, reducing the classification to a system, and making the study of the order a possibility. It is this system which is followed by Prof. Berg in the modest work under notice, which is not a monograph, but rather an enumeration of the known species, accompanied by descriptions of new ones. The work is therefore special in its character and classificatory in its

aim; no biological conclusions are attempted nor structural details given, save such as appertain to generic or specific diagnosis. Its value therefore is to the student of the local fauna and the generaliser in the study of geographical distribution.

The work of course must be considered to a certain extent as introductory only; many species will necessarily be discovered and added to the fauna, whilst of those described it is equally probable that some will prove of synonymic value only. The last conjecture becomes almost a certainty when an estimate is made of the difficulties under which Prof. Berg must have worked, so far removed from all the large collections, identifying or separating frequently by the help of poor descriptions, with the impossibility of examining the original types. His descriptions however are very clear, and have as a rule appended the *differentia specifica* from a nearly allied form. It is much to be regretted that this course is not more usually followed by some other entomologists, and it would almost appear in many cases that from being so frequently told by the biological philosopher that descriptive is the lowest form of scientific work, that the describers themselves in despair had done the work in the very lowest manner. It was well said that "some see differences and no resemblance, others resemblance and no difference, whilst some again can see neither the one nor the other," and thus the help acquired from comparative diagnosis appended to an exhaustive description becomes the more necessary when it is not possible to give a figure of the species. Whatever conception may apply in the mind of the individual worker as to the much vexed term "species," it is at least to be expected that the limits of variation can only be estimated by one who has thoroughly studied a group and knows some little of their life histories. It is in this field that the specialist should really be considered a prophet, and in entomology there are not only families but even genera which are so peculiar and unique in the variation of their species that the *variable* might with advantage be added to the *structural* diagnosis. In the Rhynchota this is extremely applicable, even structural characters which are constant and specific in one genus being variable and of no specific value in another, whilst colour and size, generally of no moment, are in some few instances beacons which denote specific differentiation.

In studying a work of this nature we become sensible of the vast unexplored field of entomology. We here possess the identifications and names of the forms constituting a fauna, but by what methods its homogeneity was secured remains still to be discovered. Which species or genera are even pleistocene forms which have been introduced by man, or by other means of involuntary migration, we have at present no record. The interdependence on the botanical geography of the district must always be a factor in the distribution of the non-carnivorous forms of the Rhynchota, and the meteorological conditions of a country will in future be more studied by entomologists who are investigating local faunas.

Prof. Berg has introduced a valuable addition to his work in the descriptions, where possible, of immature forms. Larvæ in this order are most difficult to adequately describe, and we may hope that the author in

some subsequent publication may be able to give us illustrations of the same.

W. L. DISTANT

### THE HUMAN VOICE

*The Mechanism of the Human Voice.* By Emil Behnke, Lecturer on Vocal Physiology at the Tonic Sol-fa College. (London: J. Curwen and Sons, 1880.)

THE object of this little book is to give singers a plain and comprehensible view of the musical instrument on which they perform. The author seems to have succeeded in this attempt remarkably well. He has evidently had much practical work himself, and has especially set himself the task of examining the action of the vocal organs during singing by means of the laryngoscope, and his record of his own experience in acquiring the use of that beautiful instrument is not only interesting but of much practical value. The last section of the book is devoted to the teaching of the laryngoscope, as to the action of the vocal ligaments in producing voice, with especial reference to the so-called registers. "A register consists of a series of tones which are produced by the same mechanism," is his definition (p. 71), which is new, and complete, and he proceeds to explain the different mechanism of each kind of register as actually observed on singers. There are some good remarks on breathing, (pp. 17-22). All information is given throughout in which intelligible language, and illustrated by fourteen woodcuts (not all original), which are purposely arranged that the eye looks as if many details at a time, but some essential points escape from ally introduced. The author seems to have been in the consultation of authorities as to the lungs, if work of his own, and the book may be highly recommended to all singers, and others who are desirous of knowing how vocal tones are produced.

There are a few things which may be pointed out which will be corrected in a second edition. On p. 21, the author says "the former musical pitch was a minor third flatter than at present. But all music now sung the difference was scarcely more than a semitone." On p. 30, and again on p. 70, he says "The vocal ligaments, by their vibrations, cut the stream of air passing between them into regular waves." It is difficult to see how these words convey, even metaphorically, a correct conception of what happens. "To cut a stream into regular waves," is not a very intelligible operation. The expression should certainly be altered, and a few lines added to convey the full notion. On p. 37 the author seems to be wrong in considering that glottis (or "tongue" in the singular) refers properly to the vocal ligaments (or "tongues" in the plural). It is merely what he terms the "chink," or the tongue-shaped space between the vocal ligaments as shown in Pl. X. A. He also omits to notice especially the cartilaginous glottis between the pyramids (arytenoids), although it appears in Plate X. c, and XIV., XV., XVI. On p. 44 he gives as a function of the pockets (ventricles of Morgagni) that "they allow the stream of air which has just been converted into tone to expand sideways, thereby materially adding to its resonance." The whole phrase is confused and should be entirely re-written; the

conversion of a "stream" into a "tone," and "adding" to the "resonance" of such a converted stream, is very aliphod-writing. On the whole matter of resonance (p. 46) the writer is unsatisfactory. He does not include the cavities between the vocal ligaments and the lid (epiglottis) among the resonating chambers, except in the objectionable passage just cited, and he does not enter into the question of the modification of quality of tone by means of these resonances. By some accident in engraving Plate XIII. the letter w is placed on the windpipe, as well as on the cartilages of Wrisberg, and the vocal ligaments are not distinct enough. All the figures, XIII. to XVI., seem to be copied from the English edition of Madame E. Seiler's "Voice in Singing." It is a pity to waste space in such a little book on controversy. It was hardly necessary to quote Madame E. Seiler at length (pp. 81-90), and then controvert many of her statements. This only tends to confuse the learner. The result should be given from the author's own observations, and then, if desired, the points of difference might be explained in a note. Similarly for the controversy about the action of the "wedges" (cuneiform cartilages) on p. 45, which has no interest or use for a beginner. The space devoted to controverting Mr. Lunn's "Philosophy of Voice" (pp. 52, 69, 70), and to Mr. Hilingworth's "hazelnut" theory of the "pockets," and other bits of controversy with Miss Sabilla Novello (p. 30) and Dr. Garrett (p. 32) might also have been saved with advantage.

It does not take much space to point out a few minor blemishes, which scarcely detract from the general merits of the book, and which clearly the result of much real work and careful attention of the author.

#### ON THE BOOK SHELF

**THE BULL.** Thatston's *Illustrations of Electricity and Magnetism*. By W. Lees, M.A. (W. and A. K. Johnston, London.)

Mr. Lees and Mr. Johnston have begun an excellent series of four sheets of diagrams in the science of the fundamental experiments of electricity and magnetism. The subjects are well chosen, and with hardly any exception well drawn and coloured. They will be welcomed by teachers of science classes in schools for their clearness and general excellence. Mr. Lees, who has prepared them, has also issued a specially-written "Handbook" to accompany each sheet. Of these handbooks—though perhaps useful for such pupil-teachers as may have the misfortune to be set to teach a subject in which they have themselves never made a single experiment—the less said the better. The writer of them is in bondage to the ideas of half a century ago. Take as a specimen the following statement concerning the Leyden jar:—"Suppose, then, the accumulation of electricity in the jar to proceed, the quantity of free electricity in the inner coating goes on also increasing, until the density of that electricity becomes the same as the density of the electricity of the prime conductor." The italics are the author's own! This is no more absurd, as a scientific statement, than it would be to say that when a dock-sluice is opened the water rushes in from the higher level until the muddiness of the water inside is as great as the muddiness of the water outside; for the electric equilibrium of two conductors no more depends upon the density of their respective charges than does the flow of water upon its degree of turbidity. Yet the writer of this amazing sentence styles himself "Lecturer on Natural Philosophy, Edinburgh"! For the sheets of diagrams themselves we have nothing but praise.

#### LETTERS TO THE EDITOR

[The Editor does not hold himself responsible for opinions expressed by his correspondents. Neither can he undertake to return, or to correspond with the writers of, rejected manuscripts. No notice is taken of anonymous communications.]

[The Editor urgently requests correspondents to keep their letters as short as possible. The pressure on his space is so great that it is impossible otherwise to ensure the appearance even of communications containing interesting and novel facts.]

#### A Fourth State of Matter

MR. CROOKES has given us optical evidence of the existence of matter in a state of tenuity known hitherto only indirectly, and considers himself warranted in affirming the discovery of a fourth or ultra-gaseous condition; yet it can scarcely be conceded that he has demonstrated the truth of his views, or that his recent exposition of them has strengthened his position or satisfied the doubts of the sceptical. It is simply a question of the use or misuse of certain specific terms, and it is difficult to follow the logic which justifies the creation of a "fourth state" by the attribution of properties not differing essentially from those of matter in its normal condition. Before his contention be granted it should be proved that the substance under experiment possesses properties exclusively and inalienably its own; as rigidly defined as those which distinguish the solid from the liquid, or the latter from the gaseous.

By the abstraction from his experimental chamber of a large portion of its contents he has enlarged the interstitial spaces of the residual gas, and thus amplified the mean free path of molecular vibration from some millionths of an inch to several inches; but beyond this extension of the path of oscillation there seems nothing to warrant the opinion that the residual gas is essentially other than it was before.

If this amplification of the molecular path be the feature relied on for justifying the term "fourth state"—and this seems the only inference—then further travel in this direction brings us to a point easily within our conception, where the contents of the experimental chamber shall not exceed one or two molecules; and it becomes interesting to know if Mr. Crookes would then add a fifth to the other states of matter. To do so would seem the inexorable outcome of his reasoning, and inevitably resolves the question into one of the numerical contents of the chamber; and it rests with him to define the precise point where the ordinary conditions cease, and the ultra-gaseous commences.

In gases, whether at the normal density, or rarefied to 3 mm., we have an unbroken continuity of condition; which, contrasted with the solid and liquid forms of matter, is noticeable for the absence of any point whence a new state can be said to originate: would Mr. Crookes assign a vacuum of 0.999 mm. or one of 0.0003 mm. as the critical point in the attainment of his "fourth state" or some intermediate density?

Again, has Mr. Crookes fully recognised the distinction between the properties of matter *per se* and those which are referable to electrical agency as revealed by the experiments of Messrs. De La Rue and Müller, where the projection of molecules against the walls of the containing vessel is attributed to electrification; or, further, the fact that a tenuity approaching that attained in his experimental chambers has been long familiar to us in the case of steam of very high pressure?

Whatever may be the solution of our speculations regarding the ultimate condition of matter, opinion seems unanimous that the concrete form in which it is known to us consists of an aggregation of particles having immutable properties and composition, gaseous bodies being definite molecular groupings of such particles; and if such be the case, and the chemical character of the contents of Mr. Crookes' experimental chambers remained unaltered, it is difficult, if not impossible, to conceive the existence of any further condition other than that produced by the breaking up of the molecule into its component atoms.

London, July 9

GEO. E. NEWTON

#### Permanent Record of Foucault's Pendulum Experiment

SOME four years since, while arranging a Foucault's pendulum for use in the class-room, it occurred to me to endeavour to obtain a permanent record of the experiment, and as the results were very good, and the method simple, they may be interesting to others.

The pendulum used was sixteen feet long, the height of my lecture-room at the Massachusetts Institute of Technology, and

consisted of a cannon-ball weighing about 5 lbs., suspended by a fine steel wire, which at its upper end passed through a hole drilled in an iron plug. The pendulum would continue to vibrate for sixteen or eighteen hours after being set in motion. After obtaining satisfactory results by using a ring of sand in the ordinary manner, a very stiff bristle was attached to the terminal spindle, and under it was placed a thin smoked-glass plate. The resistance was too great to allow the bristle to strike against the plate at each vibration of the pendulum, so that the device was adopted of fixing the plate upon a heavy brass disk capable of being raised or lowered by levelling-screws. This was placed under the pendulum before the latter was set in vibration, and then carefully raised until the bristle scratched its trace on the smoked-glass plate. After two or three oscillations of the pendulum the plate was lowered, great care of course being taken to avoid all possibility of rotation during this operation. At the expiration of fifteen, thirty, or sixty minutes it was again raised, and this process was repeated as often as desired. The inclination of the tracings was beautifully shown, and its amount agreed exceedingly well with that given by theory. With a heavier ball and longer wire even better results might have been obtained, but the motion of the pendulum used was but very slightly interfered with by the friction of the bristle. I should not omit to mention that the details of the experiment were carried out by Mr. F. W. Very, then a student at the institute.

CHAS. R. CROSS

Boston, Mass., June 19

#### The Freshwater Medusa

IN NATURE, vol. xxii, p. 218, Prof. Allman by mistake attributes to me the conclusion that *Limnocoedium* has no marginal canal, and that its radial canals are not pervious. A reference to NATURE, vol. xxii, p. 147, will show that in my first publication on the subject I gave as a character of the new genus "Radiating canals 4, opening into the marginal canal. Marginal or ring canal voluminous." I made the same statement in my communication to the Royal Society on June 17, and have not since deviated from it.

E. RAY LANKESTER

#### Artificial Diamonds

THE process of building up tubes, which Mr. Mallet has been so kind as to suggest to me through your valuable journal, has been tried, but was unsuccessful through the same defect as caused the failure of many of my other experiments, namely, leakage without bursting. Some of the tubes found empty would bear, when cold, a pressure of ten tons on the square inch without leaking, showing that the gases escaped through the porosity of the iron at a high temperature. Hydrogen and hydrocarbons seem to go through iron at a red-heat very easily, and the direction in which I am working is to obtain an impervious coating, or a method of "clogging" the iron, as seems to have sometimes taken place in the carbon experiments.

Experiments conducted since the reading of my paper have convinced me that the crystallisation of silica and alumina may yet be carried out with ease and certainty, and when I have rendered one of these processes a commercial success the experience gained in daily manufacturing operations will enable me to attack the carbon problem with much more certainty of obtaining definite results.

As I shall be writing an account of this work in the autumn I shall feel greatly indebted to any of your readers who, if they come across any not widely known experiments in this direction, will kindly communicate with me, so that I may have all the work done in this direction before me. Suggestions such as Mr. Mallet's are valuable to any worker, as the reactions of one brain must always be somewhat similar unless outside stimuli give new directions to its activity. I am always therefore thankful for either suggestion or corrections.

J. B. HANNAY

Private Laboratory, Glasgow

#### Temperature of the Breath

THE average temperature of the interior of the human body, according to our best authorities, is 98°·6 F. What is the temperature of the breath? It might naturally be supposed that its temperature was the same as that of the interior of the body, or lower, if it is derived from the lungs, into which it is drawn from the cold outer air. But is this so?

The temperature of my body, as shown by the thermometer in the axilla and mouth, is normal, *i.e.*, about 98½°. On rising in the morning, before dressing or eating, I take the thermometer, wrap it up tightly in several folds of a silk handkerchief, and breathe upon it (expiring through the silk immediately over the bulb of the thermometer and inspiring by the nostrils). After five minutes of this operation I examine the thermometer, and find that it indicates a temperature of 106°·2. At 7 p.m., after brisk walking exercise, having eaten nothing since breakfast except a spoonful of boiled rice at 1 p.m., and having drunk nothing but half a tumbler of water and a mouthful of ginger-beer, I take the temperature of my breath in the manner described, for five minutes. I find the thermometer indicates 107°. Again, immediately after dinner, at which only water was drunk, the thermometer shows my breath to have a temperature of 108°. At other times the thermometer will not rise under apparently the same conditions higher than 102° to 105°. A temperature of 109° was observed by the correspondent of an American journal, but he does not mention under what circumstances this occurred.

How is this high temperature produced? It cannot, as a friend suggested to me, be caused by the condensation of the moisture in the breath by the silk handkerchief, for if the temperature of the breath as it issues from the lungs be the same as that of the lungs themselves, *i.e.*, not exceeding 99°, the silk, soon becoming much hotter, would rather tend to volatilise than to condense the moisture of the breath. Is it caused by the friction of the breath upon the fibres of the handkerchief? I know of no observations to show that a high temperature would be so caused. Is it the actual temperature of the breath as it issues from the lungs? If so, then it is by the breath that the system gets rid of its superfluous caloric. For this elevated temperature is not communicated to the blood oxygenated in the lungs; the blood in the left ventricle of the heart (which receives this oxygenated blood) being, according to some physiologists, lower in temperature than the blood in the right ventricle, which has not yet entered the lungs.

The few experiments I have made seem to show that the temperature obtained as above described is higher when the surrounding air is warm than when it is cold. This looks as if more caloric passed off by the breath when less can escape from the general surface of the body.

How these high temperatures are produced in the lungs, if they are developed there, is a mystery. Perhaps some of your readers may be able to explain.

53, Montagu Square, May 27

R. E. DUDGEON

#### Reversals by Memory

I SHOULD much like to know if it be a common thing for people to reverse the positions of objects in the memory. An artist, on returning from the National Gallery, painted the *Téméraire* from memory. Taking his picture to compare it with Turner's, he found to his surprise that he had reversed the positions of the ship, tug, sun, &c. His daughter tells me that if she wants to refer to a passage in a book she as often looks for it on a left-hand page, while it is on a right-hand page, or *vice versa*. Another lady, on looking at a wood-engraving made from a sketch which she had seen some time previously, asked if the engraver had not reversed everything? These are the only cases known to me.

Is the following universally true?—

Let some one write with a blunt instrument the letter P on your forehead, or anywhere on the front half of the head from ear to ear, and the P must be written backwards for you to "see" it correctly. But if it be written anywhere at the back of the head, it must be written correctly both for you and the writer to read it. The change takes place abruptly in a line over each ear.

GEORGE HENSLOW

#### Toughened Glass

THE night before last a lady of my family emptied a paper powder composed of 7½ grains of carbonate of potash and 11 grains of carbonate of soda into a tumbler of what is called toughened glass less than half full of cold water. After stirring the mixture she drank the contents, leaving a silver teaspoon in the tumbler, and then placed the empty tumbler on the table by her side within perhaps a foot of a burning duplex lamp. About five minutes afterwards a sharp explosion occurred, which startled

all in the room. We found the tumbler shattered into fragments, the body of the glass ripped up, as it were, into several large, irregular-curved pieces, and the bottom of the tumbler broken into small pieces more resembling thick rough ice than anything else. Query: Was the explosion caused by the inherent properties of the toughened glass, or by the contact of potash, soda, the silver spoon, and proximity to a lamp, the heat from which was very slight, indeed scarcely perceptible to the hand at the spot where the tumbler stood?

The accident might have been very serious, for pieces of the glass flew to within a very few inches of the lady's face. A solution of the cause of the explosion is therefore of considerable importance to all who may have occasion to use vessels of this peculiar glass.

Sunninghill, July 7

NOBLE TAYLOR

#### Great Meteor

A METEOR of extraordinary brilliancy was seen on Friday, July 9, about 8.20 p.m.—almost in full daylight, the sun having only just set—by the Rev. Mr. Lloyd-Jones, who kindly took me to the place of observation and gave me the following particulars:—

The meteor was quite half as large as the full moon, of dazzling light-blue colour. It moved slowly in a path inclined about 10° to the horizon, from left to right, and emitted a train of ruddy sparks. Mr. Lloyd-Jones was looking in the opposite direction, and had time, after his attention was called to it by a friend, to turn round and see the last 10° of the path. The total duration may have been ten seconds, and could not have been less than five, the meteor dying out slowly. The point of disappearance was carefully noted and referred to some trees about 200 yards distant. I afterwards found it to be in true azimuth N. 69½° E., altitude 9°. No detonation was heard. The place of observation was about two-thirds of a mile east of the Royal Observatory, Greenwich.

G. L. TUPMAN

#### Iron and Hydrogen

MAY I be allowed to point out that the question of the occlusion of hydrogen in steel, and its influence in hardening, has been discussed by Mr. Wm. Anderson in his report to the Committee of this Institution on the Hardening, &c., of steel.

At the last meeting of this Institution Prof. Hughes stated that his experiments did not support the hydrogen theory, but rather the view that hardened steel was an actual alloy of carbon and iron, unhardened steel a mixture only. I may add that experiments are now in progress, designed to test the truth of this latter view.

WALTER R. BROWNE  
Secretary

Institution of Mechanical Engineers, July 12

#### The Stone in the Nest of the Swallow

THE swallow stone is the agate pebble, called in French *Chelidoine*—the name given to the chalcedony (NATURE, vol. xxi. p. 494), but the same virtue is attributed to the swallow herb. This is the *Chelidonium majus*, about which Britten and Holland, in their "English Plant Names," give the following quotation from Lyte:—"Chelidonium, that is to say, swallow-herbe, bycau-e (as Plinie writeth) it was first found out by swallows and hath healed the eyes and restored sight to their young ones that had harme in their eyes or have bene blinde."

Litré, in his great *Dictionnaire*, gives two quotations, in which *Chelidoine* is used in a botanical sense:—

"Se vos avez as oils manjue  
Dunc prenez celedoine et rue."

MS. St. Jean, 13th century.

"Ausai le guerit le jus de cheledoine, le lait de tithymal."

Parc, v. 21, 16th century.

He also gives its meaning as the name of a precious stone, and adds: "Petits cailloux appartenant aux agates, on dit aussi pierres d'hirondelle." With respect to its etymology he says he derives it from "χελιδόνιον, de χελιδόν, hirondelle, à cause qu'on disoit que l'hirondelle se servoit de cette plante pour rendre la vue à ses petits."

WILLIAM E. A. AXON  
Fern Bank, Higher Broughton, Manchester

#### THE CARIBBEAN SEA

THE Coast Survey steamer *Blake*, Commander J. R. Bartlett, U.S.N., Assistant Coast Survey, recently returned from a cruise taking soundings, serial temperatures, &c., in the course of the Gulf Stream, under instructions from C. P. Patterson, Superintendent Coast and Geodetic Survey, has brought very interesting data in regard to the depths of the western portion of the Caribbean Sea.

The depths and temperatures obtained last year in the "Windward Passage" between Cuba and San Domingo were verified, and a few hauls of the dredge taken directly on the ridge in this passage. The data obtained render it very probable that a large portion of the supply for the Gulf Stream passes through this passage, and that the current extends in it to the depth of 800 fathoms. A few lines of soundings with serial temperatures were run from Jamaica to Honduras Bank, *vid* Pedro and Rosalind Banks, and it was found that the temperature of 39½°, obtained at all depths below 700 fathoms in the Gulf of Mexico and the Western Caribbean, could not enter through this portion of the sea. But the temperature at the depth of 800 fathoms on the ridge in the "Windward Passage" between Cuba and Hayti was found to agree with the normal temperature of the Caribbean and Gulf of Mexico, *viz.*, 39½°. Soundings were taken between Hayti and Jamaica, developing a general depth between these islands not exceeding 800 fathoms, except where broken by a remarkably deep channel connecting the waters of the main Caribbean south of San Domingo with those north of Jamaica. This channel runs close to Hayti with a greatest depth of 1,200 fathoms, and a general depth of 1,000 fathoms. Its course is northerly along the western end of Hayti, where it does not exceed a width of 5 or 6 miles; thence westerly, south of Navassa Island, with a tongue to the northward between Navassa and Foxmigas Bank, and another to the westward between Foxmigas Bank and Jamaica.

A line of soundings was run from San Iago de Cuba to the east end of Jamaica, where a depth of 3,000 fathoms was found 25 miles south of Cuba. This deep place was found by subsequent soundings to be the eastern end of an immense deep valley extending from between Cuba and Jamaica, to the westward, south of the Cayman Islands, well up into the Bay of Honduras. The Cayman and the Misteriosa Bank were found to be summits of mountains belonging to a submarine extension (exceedingly steep on its southern slope) of the range running along the south-eastern side of Cuba. This deep valley is quite narrow at its eastern end, but widens between the western end of Jamaica and Cape Cruz, where the soundings were 3,000 fathoms within 15 miles of Cuba, and 2,800 fathoms within 25 miles of Jamaica. Near Grand Cayman the valley narrows again, but within 20 miles of this island a depth was found of 3,428 fathoms. The deep water was carried as far as a line between Misteriosa Bank and Swan Islands, with 3,010 fathoms within 15 miles of the latter. On a line between Misteriosa Bank and Bonacca Island there was a general depth of 2,700 fathoms, and a depth of over 2,000 fathoms extended well into the Gulf of Honduras. Between Misteriosa Bank and Chinchorro Bank the soundings were regular at 2,500 fathoms. North of Misteriosa and Grand Cayman, to the Isle of Pines and Cape San Antonio, the soundings were generally 2,500 fathoms. The serial temperatures agree, in relation to depth, with those obtained in the Gulf of Mexico, by Lieut. Commander Sigbee, and in the Eastern Caribbean by Commander Bartlett; decreasing from the surface to 39½° at 700 fathoms, or less, and constant at that temperature for all depths below 700 fathoms. At greater depths than 600 or 700 fathoms the bottom was always found to be calcareous ooze composed of Foropod shells with small

particles of coral. These Pteropod shells, as noted in previous expeditions by different nations, appear to be an important factor in the determination of the movements of great bodies of sea-water. The ridge at the "Windward Passage" is bare coral rock, and on the south side the Pteropod shells were found to be much more numerous than to the northward of the ridge. Soundings and serial temperatures being the special objects of the course, dredgings were only incidentally attempted for the purpose of reconnoitring, as it were, the ground, and it was found that the area passed over was not nearly so rich in animal life as that in which dredgings were taken last year under the lee of the Windward Islands at the eastward of the Caribbean Sea.

The development of the extraordinary submarine valley in the western Caribbean Sea is a matter of great interest considered as a physical feature. This valley extends in length 700 statute miles from between Jamaica and Cuba nearly to the head of the Bay of Honduras, with an average breadth of 80 miles. Curving around between Misteriosa Bank and Yucatan, and running along between Cuba and the ridge of the Caymans for a distance of 430 miles, with a breadth of 105 miles, it covers an area of over 85,000 square miles, having a depth nowhere less than 2,000 fathoms, except at two or three points (the summits of submarine mountains), with a greatest depth, 20 miles south of the Grand Cayman, of 3,428 fathoms, thus making the low island of Grand Cayman, scarcely 20 feet above the sea, the summit of a mountain 20,568 feet above the bottom of the submarine valley beside it—an altitude exceeding that of any mountain on the North American continent, above the level of the sea, and giving an altitude to the highest summit of Blue Mountain in Jamaica, above the bottom of the same valley, of nearly 29,000 feet, an altitude as great, probably, as that of the loftiest summit of the Himalayas above the level of the sea.

For the deepest portion of this great submarine valley the Superintendent of the Coast and Geodetic Survey has adopted the name of "Bartlett Deep."

#### ALBANIA AND THE ALBANIANS

ABOUT the dawn of authentic history the Balkan peninsula seems to have been mainly occupied by two kindred Aryan peoples—the Hellenes in the south, the Thrako-Illyrians in the north. Since then, or, say, for some 3,000 years, this region has been swept by more numerous tides of migration than almost any other country on the globe. Some of these waves, such as those of the Kelts 300 years before, and of the Goths 400 years after, the Christian era, receded without leaving any permanent traces behind them. Some, such as the Romans, are still represented by the Dako-Rumanians of the Danubian principalities and their southern kinsmen, the Zinzars or Kutzo-Vlachs of the Pindus range and Thessaly. Others, such as the Ugrian Bulgars, have been absorbed or assimilated to the Slaves, intruders like themselves, while others again have either resettled the land, as, for instance, the Serbo-Croatians, or else, like the Osmanli of Türki stock, have seized the political control without making any serious attempts at colonisation. The result is a condition of things absolutely without a parallel elsewhere—an utter chaos of races, languages, religions, a clash of social interests and national aspirations, which has long threatened the peace of the world, and the means of reconciling which the wisest heads have hitherto failed to discover.

But beneath and above all these strange vicissitudes and endless complications the two relatively aboriginal elements of the population still here and there hold their ground. The Hellenes have doubtless been largely Hellenised almost everywhere on the mainland,<sup>1</sup> although

<sup>1</sup> The Greek dialects use Slavic, et. idiomata generaliter uti lingua Slave" (L. Reclus, l. p. 62).

even here the old Dorians are still believed to survive in the Zakonians of the Spartan hills and the Mainotes of the Tænarum peninsula. The northern branch, also, of what has not inaptly been called the Thrako-Hellenic family still predominates, and even retains a certain vitality, in the Albanian highlands. Thracians, Pæonians, Dardanians, Mœsians, and all the other eastern and northern members of the race have long been extinct as independent nationalities; but the Illyrian or western branch still continues to be represented by the Shkipetars in their original home, on the south-eastern shores of the Adriatic.

The term Albania, it is needless to say, possesses no administrative significance, nor even any very strictly-defined geographical limitations. It is purely an ethnographic expression, though even in this sense no longer quite conterminous with the people from whom it is derived. In its widest extent Albania stretches from the Montenegrin and Servian frontiers southwards to Greece, and from the Pindus, Grammos, and Char Dag ranges westwards to the coast. Within this area are comprised three nearly coincident physical and ethnical divisions, for everything here seems to run in triads, so that the more technical data necessary to understand a somewhat intricate subject may be conveniently summed up in the subjoined series of triplets:—

I. THREE NATURAL DIVISIONS.—1. *Upper Albania*, reaching as far south as the river Shkumbi, about 41° N. lat., and mainly comprised in the Drin basin. 2. *Central Albania*, between the Shkumbi and Voyussa rivers, mainly in the Ergent basin. 3. *Lower Albania*, or *Epirus*,<sup>1</sup> thence to the present Greek frontier (Akarnania).

II. THREE POLITICAL DIVISIONS.—The Turkish vilayets of *Isgodra* (*Skutari*), *Monastir* or *Qosowa*, and *Yanina*, the two former stretching eastwards beyond the actual limits of Albania proper, most of the third awarded to Greece by the Berlin Conference, which has just concluded its labours in connection with the settlement of the new Turko-Greek frontier.

III. THREE GREAT LAKES.—Those of *Skutari*, *Okhrida*, and *Yanina*, convenient landmarks, a curve described through which from about Antivari to Prevesa, both on the coast, will roughly mark the inland frontier line of Albania proper.

IV. THREE MAIN RACIAL ELEMENTS.—1. The old Thrako-Illyrian, now everywhere largely intermingled with 2, The Slav (Serbo-Croatian branch) in the north, and with 3, The Hellenic (Dorian branch) in the south.

V. THREE COLLECTIVE ETHNICAL OR NATIONAL NAMES.—1. *Shkipetar*, the most general national appellation of the people, whence *Shkiperia* (in the Northern dialect *Sipenia*) the country, and *Shkipeia*, the language; from root *Shkip*, *Shkup* = rock; compare Greek, *σκόπελος*; Latin, *scopulus*; and Ptolemy's old Dardanian town of *Skupi*. Hence *Shkipetar* = hillmen, highlanders, according to the most accepted interpretation. 2. *Albanian*, unknown, at least in this form, to the natives, yet of respectable antiquity, and now mainly current in the west of Europe and Greece. The word is usually referred to the Keltic or Aryan root *alb*, *alp* = height, snowy, and has been connected with Ptolemy's *Albani*, a tribe whose chief town was Albanopolis, north of the Lychnitis Palus (Lake Okhrida). As a general term it occurs first in the Byzantine writings of the 10th century under the two forms *Ἀλβανίαι* and *Ἀλβανία*.

<sup>1</sup> That is, "Hæspis, or "Mainland," so called no doubt or fiction of the Greeks of the adjacent island of Korkyra (Corfu) the people were

<sup>2</sup> Kedrenus, Skylitzes, Anna Comæna. In Geogr. classicæ (Paris, c. 68) occurs the expression τῶν τῶν Ἀλβανίων ἢ κλασικῶν ἢ Ἀρβανία for the land, and *Arbereshi* for the dialect current amongst the Northern Albanians, and must be kindred to the general, for the various Albanian colonies. Beneficially mentioned in the latter half of the fifteenth century even. Beneficially mentioned in *Arberesh*, and their language *Arberish*. *Ἀλβανία* and *Ἀρβανίαι* are current names, the latter being *Ἀλβανία*.

and from the latter seems to have been formed, 3. *Arnaut*, the general Turkish designation, though more strictly applicable to the Muhammadan Albanians. This *Arnaut*, Albanian, and Shkipetar, all traceable to roots meaning rock, height, would be practically synonymous, and aptly descriptive of an essentially "highland" race.

VI. THREE MAIN ETHNICAL DIVISIONS.—1. *Gheg* (Gepides) in Upper Albania, as far south as River Shkumbi, and penetrating eastwards across the Morava Valley nearly to Sophia, with detached enclaves in Servia, but on the other hand partly Slavonised on the Montenegrin frontier. Elsewhere the Ghegs are taken as the purest representatives of the old Illyrian stock. This word, the origin of which is unknown, was a term of contempt originally applied to them by their southern kinsmen. It has thus come into general use, although never employed by the people themselves, who use either the collective designation Shkipetar or the particular name of their tribe. 2. *Toshk* or *Tosk* (Toskides) in Central and Lower Albania, wherever not Hellenised. Originally confined to the Toskides proper of Toskeria, a small district on the right bank of the Lower Voyussa north-west of Topedelen, this word has also gradually acquired general currency, and so far differs from the corresponding Gheg that it is accepted and used by the people themselves, at least throughout the whole of the Voyussa basin. 3. The *Epirots* of the Vilayet Yanina from the remotest times largely intermingled with the Dorian Greeks, and now almost completely Hellenised. The term is of course rather geographical than ethnical, but very convenient in view of the political changes now pending in this district. In connection with these changes it will be useful to note that the Pindus range between Epirus and Thessaly is occupied by the Kutzo-Vlachs (the Kara-Guni or "Black Capots" of the Turks), with decided Hellenic proclivities, religious, political, and social, though still speaking a corrupt Rumanian (neo-Latin) tongue. Even in Epirus the *Toshk* itself, wherever still spoken, is largely mixed with Greek elements, and most of the *Toshks* themselves are here bilingual, speaking Greek and their mother tongue indifferently, while in Yanina, capital of the vilayet, Greek has long been supreme. Consequently the contemplated transfer of this territory to Greece, with which it has been uninterruptedly associated from prehistoric times, cannot seriously affect the integrity of the Albanian race or do any undue violence to their legitimate national aspirations.

VII. THREE RELIGIONS: 1. *Muhammadan* everywhere, but rather more general in the south than the north; 2. *Orthodox Greek*, almost exclusively in the south; 3. *Roman Catholic*, of Latin rite, almost exclusively in the north. From this it follows that the Ghegs are partly Moslem, partly Roman Catholic; the *Toshks* partly Moslem, and partly Orthodox Greek; the respective numbers being as under, as far as any such estimates can at all be depended upon in Turkey:—

Türki stock; but the converse is very far from being the case, for we see from this table that in Albania alone there are no less than 1,000,000 Muhammadans who are not Türki, but of Illyrian stock, apart always from a few Osmanli officials and others in the large towns.

TRIBES.—It is not a little remarkable that the country which might almost be regarded as the cradle of European civilisation has itself remained nearly stationary since the rude Dorians issued forth from the mountains of Epirus to the conquest of Peloponnesus. Of all the western Aryans the Albanians alone have remained in a semi-pastoral state, and retained the primitive tribal organisation. Both branches of the race, but especially the Ghegs, are still divided into a considerable number of *phar* or *phar*, that is, clans or septs, some of which, such as the Suliots in the south, and the Mirdites in the north, have acquired historic renown. George Castriota, the Scanderbeg, or "Alexander the Great" of the Turks, who almost single-handed for thirty years stemmed the torrent of Osmanli conquest, was Prince of the Mirdites, and the astounding valour and self-devotion of the Suliots form one of the most stirring episodes in the Græco-Turkish wars during the early part of the present century. Recently also such tribal names as those of the Klementi, Hotti, Dukazin and others have been heard of in connection with the present political troubles on the Montenegrin and Albanian frontiers. As such troubles are likely to be of a protracted character, pending the definite settlement of the new northern and southern frontier lines, the readers of NATURE will probably be glad to have in the annexed table a complete classification of all the Albanian tribes:—

GHEGS.	{	MIRDITES:—Dukazin; Dibri; Mats or Matia; Oroshi Fandi; Kushneni, Spachi; Kuchi
		PULATI:—Giovagni; Planti; Kiri; Summa; Toplana; Dushmani; Shalla; Shoshi
		Other semi-independent tribes. } Klementi; Hotti; Shrelli; Kastrati Rechiluhö; Rioli; Posripa; Kopliki Grica Gruemir; Busagwit; Grudda; Trepchi
TOSKS.	{	To-shks proper of Toskeria; Yapides or Liapes;
		Kheimariots; Khamides or Khumis Tyames; Suliots

Of all the tribal associations by far the most important are the Mirdites, who, although numbering scarcely over 20,000 altogether, form a powerful political factor in the country. They constitute a Roman Catholic oligarchy, whose chief town is Orosh, where resides their prince or chief. The confederacy is fully recognised by the Porte, to which it is tributary. Amongst them has long been prevalent the custom of marrying none but Turkish, or rather Muhammadan, women, carried off from the plains and baptised in the mountains. Their territory lies chiefly south of the Drin, and with the Pulati ("Men of the Woods"), Klementi, Hotti, and other highland tribes between the head streams of that river and Lake Skutari,



as the River Pavla,<sup>1</sup> and the Khamids or Khamis between the Pavla and Kalama Rivers over against Corfu. Many of the Khamids, however, have already been Hellenised, and the rest form detached communities everywhere surrounded by Greek-speaking populations, as correctly indicated on the ethnological map of European Turkey and Greece recently published by Stanford of Charing Cross.

Including the Albanian colonies since the fifteenth and sixteenth centuries settled in South Italy and Sicily, and many scattered Toshk settlements in the Morea, Attica, Eubœa, and the Archipelago, the whole race numbers at present considerably over a million and a half, as under:—

Upper Albania (Ghegs) .. .. .	700,000
Central and Lower Albania (Tosks) .. .. .	680,000
South Italy and Sicily .. .. .	180,000
Greece and Archipelago .. .. .	90,000
	1,650,000

LANGUAGE.—The broad distinction between the northern and southern branches of the race—Illyrians or Ghegs, and Epirots or Toshks—dates from the earliest historic records, and was clearly recognised by antiquity. The parting line between the two was much the same then as now, being fairly indicated by the famous Roman road, the Via Egnatia, running from Dyrrachium (Durazzo), on the Adriatic, through Okhrida and Bitolia (Monastir), to Thessalonica (Saloniki), on the Ægean. North of this great highway dwelt the Illyrians, Dardanians, and Pæonians, all closely allied in speech, south of it the Epirots and Southern Macedonians, also represented as originally of kindred speech and like customs, though both were later on largely Hellenised.<sup>2</sup> The difference between the northern and southern dialects still persists in Albania, where alone the Thrako-Illyrian language survives, the Gheg and Toshk standing in much the same relation to each other as High to Low German, or even to Danish. Hence the extreme northern and southern tribes are almost mutually unintelligible, although the the Toshsks and Ghegs of the border districts (Ergent and Shkumbi valleys) are able to converse together. The Italo-Albanian Demetrius Kamardas accordingly takes the speech current in this central tract as the common "Illirio-Epirotic" standard.<sup>3</sup>

The linguistic affinities of Albania were long a source of great trouble to philologists, and its claims to membership with the Aryan family were only finally established beyond dispute by J. G. von Hahn.<sup>4</sup> But its position within the family itself can scarcely be said to have yet been satisfactorily determined. Bopp<sup>5</sup> compared it, after his usual method, chiefly with Sanskrit, while others have regarded it as simply an archaic or even a corrupt variety of Greek.<sup>6</sup> The truth would seem to lie between these extremes, and a more exhaustive study of the subject will probably show that in Albanian we have the only surviving link between the Asiatic and Græco-Italic branches of the Aryan family. An analysis of the southern dialect shows that of its roots about one-third are common to Æolic Greek, one-third to Italic, Keltic, Teutonic, and

Slavonic, the rest consisting of an unknown element assumed to represent the speech of the ancient Thrako-Illyrians. The Italic, Keltic, Teutonic, and Slavonic words may be referred partly to their common Aryan inheritance, partly to contact possibly in prehistoric, certainly in historic times—the Keltic invasion third century B.C.; Gothic irruption under Alaric; Roman rule of five centuries; Serb occupation of Upper Albania to the Drin from 640 to 1360 A.D.; Bulgarian occupation of the central districts till 1019.

But what has been called the Æolic Greek element seems rather to date from a common pre-Hellenic period, for it often presents a more primitive phonetic system, and more archaic grammatical and lexical forms than the oldest Greek extant—forms which cannot be derived from Greek, but which are intermediate links between Hellenic and Asiatic Aryan. Thus the Albanian *bolnesa* = *will* (noun) explains the Greek βουλομαι for βολνομαι, connecting it with the Sanskrit *varnamai*. Alb. *dera* = *door*, stands between Gr. θύρα and Sans. *dvāra*; Alb. *neër* or *niër* = *man* between Gr. ἀνῆρ and Sans. *nar*. Here the organic *a* has become *e* both in Alb. and Gr., but Alb. has not taken the prosthetic *a*, a sufficient proof that it does not derive from, but belongs to an older period than, Greek. Grammatical forms point in the same direction. Thus the Alb. genitive in *eye*, as in *atiye* = *of him*, answers to the Sans. *sia*, *sva*, and to the old Gr. εἶο, εἶο, εἶο = *ov*, as in ἐμείο, ἐμέο, ἐμοίο, ἐμου. The numerals, often so instructive in comparisons of this sort, place the matter in a still clearer light. Thus Alb. *nyë*, *nya* = *one* = Gr. *ἓς* for *ἕν*-s, neutral *ἕν*; *katrep* = *four*, has the organic *k*, which in Gr. becomes *t* (*tétrap-es*), Sans. *katvar*, *katvar*, Lat. *quatuor*. Compare also Alb. *gvash-te* = *six* with the Sans. *shash* and Gr. ἕξ, where the Alb. *g* forms the intermediate stage between the original sibilant and the Gr. rough breathing. In *shetta-te* = *seven* Alb. retains the sibilant, here standing on the same level as Sans. *saptan*, as compared with Gr. ἑπτὰ for *septta*.

In other instances Albanian shows great corruption and phonetic decay, as might be expected in a rude, uncultivated tongue never reduced to writing till quite recently. But the corruption and decay always proceed on different lines from those followed by Greek in its evolution. Thus Alb. *nën-te* (Skutari dialect *nân*) and Gr. *ἑννέα* = *nine*, have both lost the digamma preserved in the Sans. *navan*, from which each flows in independent channels: Alb. *nefan*, *nean*, *nën*, *nân*; Gr. *ἑννέα*, *ἑννέα*, here prosthetic *a* causing reduplication and loss of final *v*.

The general tendency of Albanian, as of French, is towards short and contracted forms, the suppression of middle and weakening of final vowels to *e* mute or *eu*. This, combined with a somewhat barbarous system of orthography, half Greek, half Latin, which has here been replaced by a simple phonetic system, gives the language a decidedly rough and uncouth look, though it is by no means deficient in harmony, and what Kamardas finely calls a certain Hellenic "aura," so that "at times we fancy we are listening to Greek instead of Albanian utterances."<sup>7</sup>

The determination of the true position of Albanian is of such importance in the history of Aryan speech that the reader will probably excuse this somewhat digressive excursus.

TYPE.—From many of the foregoing indications it is obvious that the Albanians can by no means be regarded as a pure race. In popular works of travel or fiction a certain halo of romance is thrown over the people, who are represented as endowed with almost classic symmetry of form and beauty. This is to some extent true in the south, where intermixture with the kindred races could scarcely be otherwise than beneficial.

<sup>1</sup> Here was Ptolemy's Albanopolis, and here is a maritime canton still called Arberia or Arber, and in Gheg Arberia, that is, Albania. The interchange of *r* and *l* is a prevailing feature in Albanian, as in French, Chinese, Polynesian, and so many other tongues. The peasantry about Frascati and elsewhere in the Campagna call the English *Ingrizi* for *Inglizi*.

<sup>2</sup> Thus Strabo (vii.): "Leaving Epidaurus and Apollonia (Durazzo and Pollia) to follow the Via Egnatia, we have on our right the peoples of Epirus, bordering on the Sicilian Sea as far as the Gulf of Ambracia, and on our left the Illyrian highlands and the peoples of that region as far as Macedonia and the Pæonians."

<sup>3</sup> "Bergis di Grammatologia comparata sulla Lingua Albanese," Leipzig, 1855, p. 19.

<sup>4</sup> In his classical work "Albanesische Studien," Jena, 1854.

<sup>5</sup> "Ueber das Albanesische," Berlin, 1855.

<sup>6</sup> Amongst others the anonymous author of the introductory remarks to Stanford's Ethnological Map, who (p. 8) speaks of the Albanians as "being in their original and elementary condition," a fact "now clearly established" by the study of the Albanian dialect, which modern comparative philology has shown to be but another form of the Hellenic language.

<sup>7</sup> "Una certa aura, per così dire, d'ellenismo, che si manifesta nelle udite parole greche invece di albanesi." Op. cit., p. 29.

the extreme north, where the elements here absorbed belonged to some of the best Slav blood—Serbs and Montenegrins. But the plain and often even repulsive features met with in some of the central districts would seem to point at fusion with the Ugrian or Volga Finn Bulgarians, whose headquarters were at Okhrida, and who at that time (8th and 9th centuries) had not yet been Slavonised. Nevertheless, the Albanians are on the whole a fine and even a handsome race, with long head, oval face, long thin nose, rather high cheek bones, small eyes, generally grey or blue, hair often fair or light brown, long neck, broad chest, slim and upright figures. But descriptions of course vary with the experiences of the observer. Thus while Pouqueville speaks rather of black eyes, others describe the Toshks as essentially a blue-eyed and light-haired race. In general the purest type is found in the district between the Shkumbi and Voyussa, where Kamardas says that the language also is spoken in the greatest purity. North and south of this district both people and language are more or less intermingled with Slav and Hellenic elements respectively.

A. H. KEANE

#### REPORT OF THE BRITISH MUSEUM

THE Parliamentary Report of the Trustees of the British Museum, which has been lately issued, tells us that during the past year much progress has been made in arrangements for removal of the natural history collections, and in preparations for their reception in the new buildings designed for them at South Kensington. New cases and fittings have been provided and erected for the departments of botany and mineralogy, and in part for that of geology; and the transference of these three collections to the new museum will probably be effected in the course of the present year. The galleries vacated by these collections will be at once made use of for the exhibition of objects of archæological interest which have been accumulating for many years, and from want of space have been stored away in imperfectly-lighted rooms in the basement of the British Museum.

The whole of the zoological and geological portions of the India Museum at South Kensington, together with the friezes from the Amravati Tope and other remains of ancient sculpture, have been made over by the Secretary of State and Council of India to the Trustees of the British Museum. The sculpture will be exhibited in the Museum; the zoological and other collections have been removed to the New Natural History Museum at South Kensington.

Turning to Prof. Owen's special report on the departments of natural history, we are told that part of the work during the past year has been that of the preparation of the collections for the pending transfer to South Kensington.

In the department of zoology Dr. Günther informs us that not less than 45,881 specimens have been added to the several parts of the collection; of this, however, more than half is attributable to the collection of exotic butterflies, bequeathed to the nation by the late William Chapman Hewitson. This is one of the most extensive and valuable collections of this group of animals that has ever been formed; it consists of 24,624 specimens referable to 5,795 species, many of which have been described by the testator in his "Exotic Butterflies," "Diurnal Lepidoptera," and other works. The collection is in a perfect state of arrangement and preservation, and by Mr. Hewitson's direction a catalogue of its contents has been prepared and printed at the expense of his estate. The testator attached to this bequest the condition that the collection should be called the "Hewitson Collection," and should be kept in good order, preservation, and condition, and in the same cabinets, and in the same

order and arrangement, and under the same nomenclature as they should be at the time of his decease, until the expiration of twenty-one years from that time.

Another important addition to the national collection of insects made during the last parliamentary year was the Wollaston collection of St. Helena Lepidoptera, consisting of 364 specimens, and including types of thirty-eight species, collected and described by Mrs. Vernon Wollaston. This must be regarded as one of the most important acquisitions of last year, as the accurate and perfect knowledge of the fauna and flora of so isolated a locality as St. Helena at a given period will enable future investigators to determine exactly the changes which are taking place in oceanic islands, not only with regard to the composition of their fauna and flora, but also with regard to the specific characters of the animals and plants imported into them.

Four additions have been made to the well-known series of zoological catalogues in 1879, namely, the fourth volume of Mr. Sharpe's "Catalogue of Birds"; an octavo volume by Mr. C. O. Waterhouse, containing descriptions of typical specimens of coleoptera, illustrated by coloured plates; a volume containing descriptions of a number of new species of hymenoptera by the late Mr. Frederick Smith, which the lamented author left nearly ready for publication at the time of his death; and the third volume of Mr. Butler's "Illustrations of Typical Specimens of Lepidoptera heterocera."

Mr. Waterhouse's report on the Geological Department and Mr. Story Maskelyne's on that of Mineralogy succeed that of Dr. Günther, but we observe nothing of very special interest contained in them. Mr. Carruthers' report on Botany records an important addition to that department in the shape of the extensive herbarium of the late John Miers, F.R.S., &c., the distinguished botanist, which he bequeathed to the Trustees. It contains the types of the species described in his numerous systematic works and memoirs, as far as they were in his own possession, together with an extensive series of South American plants from various collectors, and many valuable collections from other regions of the world. Besides the plants Mr. John W. Miers has presented to the department the large series of original drawings made by his father from the living plants in South America and from dissections of plants in later years.

#### MARCEL DEPREZ'S GALVANOMETER FOR STRONG CURRENTS

PRACTICAL electricians have laboured up to the present time under a considerable difficulty in attempting to measure the strength of very powerful electric currents, such as are, for example, employed in the production of the electric light. There has been no simple instrument suited to the rapid direct measurement of the strength of such currents, much less one that would measure any fluctuations of short duration. Ordinary galvanometers have not been equal to the task, being adapted for a different class of work, usually of too high a resistance to be safely introduced into the circuit, and in general too leisurely in their movements to afford indications of any rapid fluctuations.

Although the current furnished by a good dynamo-electric machine, such as those of Gramme, Siemens and Brush, may for most practical purposes be considered both continuous and uniform, the construction of these instruments could hardly leave any doubt on a priori grounds that the current really consists of a number of successive impulses, which, although they may, as it were, run into one another and yield a continuous current, yet cause the strength of the current to be continually increasing and diminishing in rapid alternations; and indeed the telephone shows clearly that this is the case, for a low humming sound is heard in that instrument when the

terminals are joined to the two ends of an insulated wire, part of the length of which is laid parallel and near to the conducting-wire of the dynamo-electric machine. M. Deprez's new galvanometer shows by the most direct evidence that this is the case, for when inserted in the circuit of any dynamo-electric machine its needle is observed to be in incessant vibration.

The only instrument constructed previously to that we are about to describe, suitable for measuring strong currents, was the tangent galvanometer of Dr. Obach, the essential feature in which consisted in the conducting-ring being made movable about a horizontal diameter, and therefore capable of being adjusted by inclining it at

a greater or less obliquity to any degree of sensitiveness between its maximum and zero, the horizontal component of the magnetic force of the current circulating in it being zero when the ring was laid over into a horizontal plane.

M. Deprez's galvanometer is, however, a much more handy instrument, its indications are almost instantaneous, and the deflections with very strong currents are not unreasonably great. To secure this end it has been necessary to make the needle of the instrument very light, and at the same time to give it a very great directive force by placing it in an artificial "field" of very great intensity. The needle consists of twelve or fifteen little pieces of soft iron wire set side by side transversely

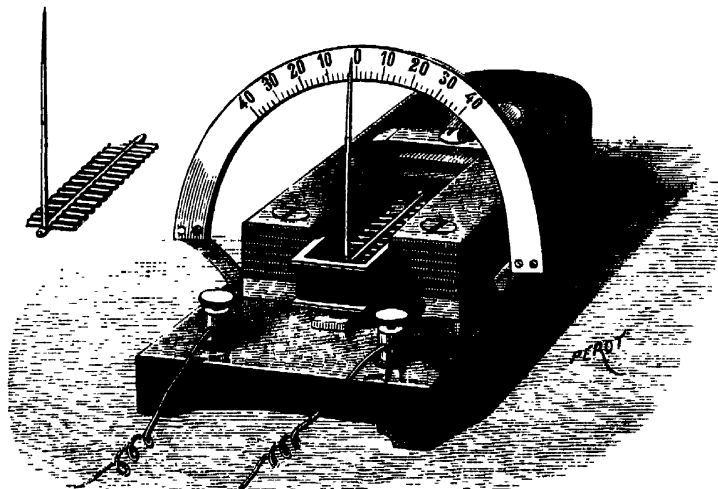

Marcel Deprez's Galvanometer for very strong currents.

upon an axis of brass which is supported between two pivots. The axis carries also a light hand or index of straw or aluminium fixed at right angles to the little iron needles. This compound needle is placed between the limbs of a powerful permanent magnet made of separately magnetised laminæ superposed upon one another (as suggested by Scoresby and Jamin), and is thereby powerfully magnetised and directed into the horizontal plane. The coils of conducting wire are carried round the needle by being wound upon a light rectangular frame which surrounds the needle, but lies within the limbs of the permanent magnet. When a current passes the needle jumps almost instantaneously to its position of equilibrium, its oscillations being of extremely short duration. M. Deprez has also tried needles made up of

several superposed layers of the thin sheet iron used in telephones, but the form shown in the figure is, on the whole, the most satisfactory in practical operation. One advantage possessed by the instrument is that it is independent of gravity and of the magnetism of the earth, and can therefore be used anywhere in any position. It will, therefore, be found to be a very convenient instrument for electrical engineers, but as its readings are not capable of being translated into values representing current-strengths by any simple trigonometrical function, sines or tangents, it would require to be graduated empirically by a process similar to the method of "calibration" adopted for ordinary galvanometers by Melloni, before it could be regarded as more than a convenient galvanoscope.

#### PROF. W. H. MILLER

IT is only just to the memory of a man conspicuous within the circle of a not very large scientific class that more than a passing word should be spoken over his grave before the grass has grown on it.

William Hallows Miller, whose life began with the century, has lived far enough into it to experience what is a happy fate for a scientific man; he has seen the chief work of his life bear fruit; has seen the system he introduced holding its place in the face of other systems, and recognised more and more as a permanent addition to the agencies with which man may grapple with the problems that nature presents to him; he has seen it developed, but not superseded.

Crystallography was Miller's science. It had taken its first shape in the hands of Häuy in the decade of years before he was born, and in those of Weiss, of Mohs, and

especially of Franz Ernst Neumann and of Grassmann, it had been receiving development during the years of Miller's growth and manhood.

The chair of mineralogy at Cambridge was filled previously to 1832 by Dr. Whewell, and a well-known memoir on the geometrical treatment of crystal forms which Dr. Whewell contributed to the *Transactions* of the Cambridge Philosophical Society gave an impetus to the study of crystallography in England which launched Miller on his career. For, taking this memoir and Neumann's treatise of 1823 (*Beiträge zur Krystallogonie*) as his starting-point, Miller, who was a pupil of Whewell, proceeded to develop a system of crystallography which was not published till 1838, but which was the most important work of his life.

Dr. Whewell had already for some time recognised in his pupil the ability and accuracy that marked him out for the career he afterwards pursued, and in 1832 the

historian of the inductive sciences resigned his chair and used his disinterested influence to obtain the appointment of Miller as his successor.

Previously to this, in 1825, Miller had taken his degree as a fifth wrangler, and he obtained some reputation as a tutor. In 1831 he published an elementary treatise on hydrostatics, and in 1835 one on hydrodynamics. They bore the mark of the same concise and precise treatment, and excision of all that was merely explanatory, which gave afterwards its character to his treatise on Crystallography, and probably deterred the ordinary student from that subject far more than any real difficulties inherent in the science.

Already in 1829 he had published a crystallographic notice of the forms of ammonium carbonate, followed in 1830 by two other memoirs, and thenceforward notices from time to time emanated from his pen on crystallography and on optical and physical subjects.

Miller was thirty when he succeeded to the chair, which he occupied forty-eight years.

The system of Weiss indicated the position of a face on a crystal by expressing its intercepts on a system of axes in the form of integer multiples of the intercepts (parameters) of some other selected crystal-face on the same axes.

The system of Miller represented the face by a symbol composed of three numerals, or indices, which are the denominators of three fractions with unity for their numerator and in the ratio of the multiples of the parameters; and he asserted the principle that his axes must be parallel to possible edges of the crystal.

The elegant way in which this mode of representing a face lent itself to yielding expressions for the relations between faces belonging to a zone (*i.e.* faces that would intersect in edges parallel to the same line) gave it superiority over previous methods, due to its bringing the symbols of the crystallographer into a form similar to that employed in algebraic geometry. But though expressions were given for the relations connecting four crystal planes in a zone, the principle lurking in them of the rationality of the anharmonic ratios of four such planes was not recognised, or at least was not announced as such, by Miller till 1857, nor were the further results deducible from this principle ever propounded by him. It was by a pupil of Axel Gadolin's and by V. von Lang independently that the limitations imposed by this principle on the varieties of crystal symmetry were first set forth; but Bravais had already deduced the necessity for these limitations by a parallel method of reasoning founded on the idea of what may be termed a net-pile of the centres of mass (*Raumgitter*), that is to say, a parallelepipedal system of arrangement of molecules. But Miller's work consisted in working out into a beautiful system the indicial method of notation and calculation in crystallography, and obtaining expressions adapted for logarithmic computation by processes of great elegance and simplicity. The faces of a crystal he followed Neumann, Whewell, and Grassmann in representing by normals to the faces, which are conceived as all passing through a common point; and this point is taken as the centre of an imaginary sphere, the sphere of projection. The points, or poles, in which the sphere is met by these normals, and which therefore give the relative directions in space of the faces of the crystal, can have their positions on the sphere determined by the methods of spherical trigonometry. Moreover a great circle (zone circle) traversing the poles of any two faces will traverse all the poles corresponding to faces in a zone with them.

By the aid of the stereographic projection, which Miller also adopted from Neumann, he was able at once to project any of these great circles on a sheet of paper with a ruler and compasses, and for the purposes of the crystallographer elaborate edge-drawings of crystals become of comparatively little importance. Miller's system

then gave expressions for working all the problems that a crystal can present, and it gave them in a form that appealed at once to the sense of symmetry and appropriateness of the mathematician.

His book at length became recognised by physicists and by the higher school of crystallography as one to supersede what had gone before it, as is evidenced by its having been translated into French by no less a man than Senarmont, into German by Grailich, who added a valuable chapter to it on crystallographic physics, and into Italian by Quintino Sella, and by its being now almost universally employed in crystallographic physics.

The future development of crystallography, there can be little doubt, will follow on the lines laid down by Miller, whatever may be the direction that development will take; and in the cause of higher scientific education, it is much to be regretted that in a National School of Mining and Mineralogy like that established in Jermyn Street the elaborate and relatively clumsy system of notation introduced by Naumann should still be retained, to the exclusion of an incomparably more comprehensive and reasonable system which has at least the advantage not only of being English in its completed form, but of having been originated by mathematicians so eminent as Neumann, Grassmann, Whewell, and Miller. For it is to be borne in mind that the (so-called) system of Naumann, apart from his long superseded geometrical treatise, is nothing but a system of notation for the general forms, and not for the particular faces of a crystal, and becomes more complicated in proportion as the symmetry of the crystal is more simple, while it is entirely useless in the methods of computation, its symbols being actually converted by the modern crystallographer who uses them into the Millerian symbols on every occasion when he wishes to deduce relations between faces and the zones to which they belong.

Besides his memoirs describing the results of crystallographic measurement and certain tracts such as that on the gnomonic projection and on the crystallographic method of Grassmann, Miller published in 1863 a tract on crystallography which was, in fact, a second edition of his original treatise.

In 1852 he published his great work, for it was all his own, on Mineralogy, modestly entitled a new edition of the "Elementary Introduction to Mineralogy, by the late William Phillips," by H. J. Brooke and W. H. Miller. The publication of this severe little volume was an epoch in the science it illustrated. It contained a mass of results obtained by Miller with all his accuracy and all his patience through many years, and tabulated in his usual concise manner. It may be said to have fired the zeal and directed the general form of the greater but still uncompleted work of his friend Des Cloizeaux. It is a monument to Miller's name, though he almost expunged that name from it. Like other work of his it may be merged in the larger works of newer men, but it will not be superseded, and will always have to be referred to.

One of the great works of Miller's life was the restoration of the standards lost in the fire which destroyed the Houses of Parliament. The microscopic accuracy of his mind here had a congenial task; and another conspicuous quality of that mind had to be brought into play in devising the elaborate precautions to be taken in order that the balances and apparatus employed might be sufficiently sensitive, and at the same time absolutely accurate when considerable weights were under determination. Indeed there was no faculty for which Miller was more remarkable than this of devising readily the most simple means of making an experiment and the apparatus needed for it.

His room at the Cambridge Museum was a storehouse of such simple and almost improvised furniture, embracing forms of apparatus needed by a crystallographer and observer using optical instruments: a little heliotrope suggested to him by a crack in the window of a railway





carriage; a clock of wondrous simplicity and accuracy, the motive power of which was a drop of water, a fresh drop always waiting ready to be picked up and to give its impulse to the returning arm of the escapement; a goniometer, consisting solely of a block of wood with a straight edge, and an upright wire with its end bent round so as to carry a cork with a second wire on which the crystal was fastened, and by which it was adjusted for measurement on Wollaston's method, the angle between two positions of the straight edge being found by the aid of a pair of compasses and determined by a continued fraction. These are a few only of the marvels of ingenuity which every one admitted to that interesting room will remember; and there were implements of observation fashioned out of the simplest materials—deal, cork, glass tube, wire—by the hand of their inventor, rough to look at, but exact in their performance. Nor was there any man who better appreciated the elaborate mechanism of an important instrument; no one, for instance, who could make an afternoon at the Greenwich Observatory more interesting and suggestive alike to the instructed student and to the uninformed visitor.

Such was the work of Miller. Personally he was quiet, unobtrusive, but observant; retiring, almost shy, in his manner, but in the highest degree genial and full of cordiality when this curtain of instinctive restraint was drawn aside and you met the man himself face to face.

He was a traveller. Impelled by his old master Whewell to the study of German as necessary to a mineralogist, he spent many a long vacation in the German and Tyrolean haunts of the mineralogist, and lost no opportunity of exchanging speech and therewith winning the esteem of the masters of his science on the Continent. Most of those contemporaries he survived. Mitscherlich, Gauss (who paid him the just tribute of complimenting him with having "exactly hit the nail on the head" in his Crystallography), Dove, Gustav Rose, Haidinger, Breithaupt, Wöhler, Sartorius von Waltershausen—names many of them but yesterday of living workers, were those of silent men before Miller's grave was closed, but they and Miller had in life been united by esteem and regard, and in some cases by warm friendship.

Of the travels which thus brought friendships and new scenes home to him, and in which he acquired valuable additions to the mineral collection at Cambridge, he had other pleasant records in the sketch-books which his constant companion, Mrs. Miller, filled as they journeyed.

Those who know the broad strath of the Towey above Llandilo in Carmarthenshire will remember, near its head, in the neighbourhood of Llandoverly, a pretty gentleman's seat named Velindra. This was Miller's birthplace. Here his father, Captain Francis Miller, had settled towards the close of the last century, after fighting as an officer in the English army throughout the American War of Independence, and after losing a good estate which he possessed in the Boston Government, and which he never recovered. He too came of a fighting family, and doubtless something of the independence, the reserve and gentlemanly courtesy of the crystallographer came to him through this inheritance.

The valuable collection of minerals at Cambridge was largely the fruit of Prof. Miller's long-vacation rambles. The addition to it of the collection of Mr. Brooke, presented by his son, the late Mr. Charles Brooke, was an appropriate gift, considering the illustrations Miller had so copiously drawn from that collection for the important treatise on Mineralogy, to which he modestly gave the title of an edition of Phillips' "Mineralogy," by Mr. Brooke and himself: the real authorship of all that made the book invaluable to the true mineralogist being his whose name stood last, though for ever greatest, on the title page.

Some of his later years were devoted to arranging in the New Museum at Cambridge the collection he had

done so much to form. He did not live to make a catalogue of it, though Mr. Lewis, who during Prof. Miller's illness was intrusted with the duty of acting for him, has commenced the laborious work of a register, as a preliminary to a catalogue.

There have been rumours that a change would be made in the character of the chair before the appointment of a successor to Prof. Miller. Considering that but for the two mineralogical chairs at the two great universities of England the study of crystallography otherwise than as an almost childish adjunct to popular lectures on mineralogy would have been extinguished in England, it may be worth while to urge that the significance of crystallographic structure as a key to great physical problems, and probably too, when the chemists have awakened to the fact, as a key to some of the newest problems in chemistry, gives to crystallography a very considerable claim for recognition among the subjects taught in the university that produced the greatest crystallographer of our time. N. STOREY MASKELYNE

#### PAUL BROCA

WE regret extremely to have to announce the death of this distinguished physician and anthropologist, which took place suddenly at Paris on Thursday last. He had attended a meeting of the Senate, of which he had lately been elected a member, and died during the night in consequence of the rupture of an aneurism. He was fifty-six years of age, born at St. Foy, in the Gironde, educated for the medical profession, and became Professor of Surgical Pathology at Paris. He soon acquired a high reputation by his researches in cerebral pathology, and continued to devote himself with great zeal to hospital work and clinical teaching to the last; but it is chiefly in consequence of his having taken up the subject of anthropology that he has obtained a world-wide fame, and occupied a position which it will indeed be difficult to fill up.

Twenty years ago the science of physical or anatomical anthropology was in its infancy, and all investigations were at variance even as to the methods to be pursued in its cultivation. Broca devoted many years of unceasing activity in endeavouring to define, systematise, and perfect these methods. The thoroughness and energy with which he threw himself into any research which he undertook were marvellous, and only equalled by the clearness and facility of expression with which he communicated his results to others. His series of essays on various subjects connected with craniometry, published in successive numbers of the *Mémoires* of the Société d'Anthropologie of Paris, and the *Revue* which he founded, and his "Instructions craniologiques et craniométriques," with the introduction of numerous neat and happily chosen terms for descriptive processes, have made an immense advance in the progress of the science.

Happily Broca's perfect simplicity and amiability of character, his pure love of science for its own sake, and his readiness to help those engaged in pursuits similar to his own, have inspired with enthusiasm most of those who came in contact with him; and he has created at Paris a school which it is to be hoped will carry on the work which he inaugurated. We may take occasion to notice his scientific work in greater detail in an early number.

#### THE UNITED STATES WEATHER MAPS, SEPTEMBER, 1878

IN the description of the United States Weather Maps for August, 1878, attention was drawn to the fact (vol. xxii. p. 36) that in that month atmospheric pressure was under the normal over a broad belt going halfway round the globe, extending from the Rocky Mountains across the United States, the Atlantic, Europe, and thence into Asia as far as the valley of the Lena, and the

bearing of this abnormal distribution of the pressure on the temperature, winds, and rainfall of this large and important part of the globe was adverted to. In the September following, the U.S. Weather Map for which appears with this notice, great and radical changes in the distribution of pressure took place—such as a change from a large defect from the normal pressure to a large excess above it in the New England States, South Britain, Central Europe, South Africa, and New Zealand; and on the other hand, a change equally striking from a large excess above the normal to a large defect from it over the West India Islands, South Greenland, Iceland, North Britain, and the whole of Southern Asia from the Bay of Bengal to Japan. As it is still premature to speculate on the causes of these enormous changes in the distribution of the mass of the earth's atmosphere and the still more enormous forces called into play in effecting them, we must content ourselves with stating them a little more in detail, and drawing attention to some of the more immediate and striking climatic consequences which followed in their train.

In North America pressure fell most below the normal about Lake Winnipeg, and southwards over the region traversed by the upper tributaries of the Missouri and Platte Rivers. This region of low pressure was extended, though in a less pronounced form, to the south-east, deepening again, however, on approaching Florida, to 0.090 inch, the greatest depression below the normal in the Bahamas. Over the Gulf States and westward through Texas and California, pressure was above the average; and to the north-eastward of the region where pressure was low it rose gradually, till in the Gulf of St. Lawrence it stood at 0.133 inch in excess of the average.

This high pressure extended across the Atlantic, and thence overspread Ireland, England, the northern half of France, Germany, all Russia except the extreme south near the Black Sea, and on into Siberia as far as the valley of the Tobol. As already stated, the southern half of Africa and the whole of New Zealand had a pressure considerably above their normal, the excess in the northern island of New Zealand being about 0.150 inch.

To the north of the European belt of abnormally high pressure there was a widespread region of low pressure including South Greenland, Scotland, Denmark, and Scandinavia, the centre of greatest depression being 0.209 inch below the normal in the north-east of Iceland. On the other side of the European belt of high pressure lay a most extensive stretch of low pressure covering the Spanish peninsula and the rest of Southern Europe; the north of Africa, all Asia, except Siberia to westward of the Tobol River and a small patch including the Lower Amur, the East India Islands, and the whole of Australia. In this widespread region centres of still deeper depression were formed in Italy, the Upper Obi, Western India, Southern China, and the south-eastern division of Australia, the depressions below the normal pressures of these five regions being respectively 0.133 inch, 0.146 inch, 0.084 inch, 0.070 inch, and 0.136 inch. The sharpness with which the regions were marked off will be seen from the statements that in their relations to the normals pressures showed differences of a fall of 0.342 inch from Nova Scotia to Bernfiord in Iceland, 0.329 inch of a rise from Bernfiord to Cork, and 0.153 inch of a fall from Cork to Rome, and 0.290 inch of a rise from near Melbourne to Napier in New Zealand.

In the United States, temperature was under the average on the western side of the area of low pressure, the deficiency from long. 98° W. to the Rocky Mountains being from 1.5 to 3°. This low temperature extended far to northward, the deficiency from the normal amounting to 4.5 at York Factory, Hudson Bay. In the region of high pressure which overspread the New England States the rainfall was small, and temperature from 1.5 to 3.5 above

the normal. On advancing, however, to the north-east temperature fell to near the average in Newfoundland which lay just on the western outskirts of the great barometric depression which had its centre near the north-east of Iceland. Greenland was completely enveloped in the western division of this depression, and there it will be seen that winds were northerly and easterly, and temperature consequently fell to 4° below the normal. On the other hand, Scotland occupied the south-eastern segment of the barometric depression, and there, consequently, winds were west-south-westerly; temperature was from 1° to 2° above the average; and the rainfall in the west of the country from 40 to 110 per cent. above the average; whereas near the east coast it was about, or rather slightly under, the average. Thus in Scotland the distribution of the rainfall of September was the reverse of what prevailed in August, the weather in the latter month being fine and dry in the west, but wet and backward in the east. These differences of weather were occasioned by the circumstance that in August the centre of greatest barometric depression was to the south-west of Ireland, thus resulting in rain-bringing easterly winds in Scotland with the distribution of the rainfall stated above; whereas in September the centre of the barometric depression was near Iceland, thus resulting in rain-bringing westerly winds in Scotland, and consequently unfavourable weather in the west, but favourable weather in the east for the ingathering of the harvest.

Temperature was about the average in England, slightly under it in France and Western Switzerland, but above the average over the whole of the rest of Europe, and eastward into Asia as far as the area of high pressure extended. The greatest excess of temperature over this extensive region occurred in the great plains of the Danube and the Dnieper, where it amounted to from 4° to 5°. In Italy the excess was small, and in Sicily temperature even fell 1.4 below the average, and this area of low temperature was continued to the north-west through France. Another breadth of low temperature, falling however nowhere lower than 2° below the normal, extended from the Caspian Sea as far to the north-east as the head-waters of the Yenisei, in other words over the western side of the barometric depression which overspread this part of Siberia. To the eastward of the Yenisei temperature was above the average, but only slightly so, nowhere exceeding 2°.

The greatest barometric depression in Australia lay off the coast south of Melbourne, and in accordance therewith, keeping in view the law of the winds of the southern hemisphere, the prevailing winds were N.E. and N. at Gabo Island and Melbourne, and N.W. and W. at Sandhurst and Portland; in other words, with the distribution of pressure described, equatorial winds blew over this part of Australia, and the temperature rose at Wilson's Promontory to 3.2 above the normal; and the winds being land winds, the rainfall, particularly at places in the interior, was considerably below the average. In New Zealand pressure was not only absolutely higher in the north than in the south, but also much higher relatively to the normals, and it was also higher in the west than in the east. Under this distribution of the pressure and the strong equatorial winds resulting therefrom, temperature rose above the normal over the whole of New Zealand, the excess being nearly 4° at Dunedin, Christchurch, and Napier.

#### NOTES

It was scarcely to be expected that the debate last Friday in the House of Commons on Mr. Roundell's motion for the complete abolition of the clerical headships and fellowships at Oxford and Cambridge should have had any other ending than it had. The Government thought it scarcely fair to the University of



Commissioners to interfere with what is regarded as one of the points which they are bound to consider. At the same time it is believed that the Commissioners are favourable to the almost complete abolition of clerical tests, and if this is one result of their deliberations, it seems to us their appointment will not have been in vain. The memorial on the subject, with 800 signatures, presented to Mr. Gladstone, could scarcely be more influential. Among the names are those of Sir G. Jessel (Master of the Rolls), Sir Henry Thompson, Dr. Risdon Bennett (President of the Royal College of Physicians), Mr. Darwin, Prof. Huxley, Mr. A. R. Wallace, Dr. W. B. Carpenter, Dr. Abbott, numerous members of Parliament, the Presidents of the Congregational and Baptist Unions and the Dissenting Deputies, the professors of most of the Nonconformist colleges, and several hundred graduates of the Universities of Oxford, Cambridge, London, and Scotland. It seems clear that the days of this remnant of an age of intolerance are numbered, and that in the near future Oxford and Cambridge will be as untrammelled by antiquated restrictions as the London and Victoria Universities. The central institutions of these bodies have developed with a marvellous rapidity, one cause of which, we must believe, has been the perfect liberty of teaching. University College, as we intimated last week, feels urgently the necessity of more elbow-room, and yesterday the foundation of Victoria University was celebrated at Manchester, where Owens College, the nucleus of the University has developed quite as rapidly, at least, as her elder sister of London. When Oxford and Cambridge have been brought as much abreast of the age as the two younger institutions, an impulse will be given to higher education in this country, and an encouragement to research in all departments of learning and science, that in time will bring us on a level with Germany in respect of University education.

No more satisfactory token of the rapid progress of liberal and just ideas as to the proper functions of universities could be desired than the tone of the leading article in the *Times* of Tuesday in connection with the Victoria University ceremonies at Manchester. After giving a melancholy picture of the disastrous effects of the existing system at Oxford and Cambridge, both on crammers and crammed, the *Times* gives what is evidently its ideal picture of university life. "Let us imagine," the leader concludes, "a body of professors employed not in examining or in cramming, but in original research or original work of some sort, pushing forward the bounds of knowledge, adding new ideas to the possessions of the human mind, creating, in short, and not merely appropriating or aiding and testing the appropriations of other people. The stimulus of such work as this would be felt, we may be sure, by all who come in any sense within its range. The example would be contagious. Original workers will be in no want of pupils, whether they seek for them or not. When valuable ore is being dug there will always be some one with a due sense of its worth ready and eager to pick it up. It is for the promotion of such work as this that great funds and great institutions most properly exist. The professions and trades of the country have their own appointed rewards. The successful barrister or the successful merchant may or may not have been a university student. It is not in any case the chief duty of a university to assist him in the attainment of his rank, first to sharpen his tools for him and then to keep him in funds during the interval while he is waiting to use them. The professions and trades can hold their own very well without such adventitious help as this. Original work is not so directly remunerative; to the individual engaged upon it it may not be remunerative at all. It often bears fruit slowly, but it bears it abundantly in the end. It needs, therefore, and it needs the special encouragement which a university can most effectively provide. The Victoria University has its life before it.

It can choose its own course. It may become a machine for turning out second and third-rate intelligences, a sort of procrustean bed, so constructed as to bring its sons as nearly as possible to the same intellectual stature and equally to forbid any of them from falling far short of it or from exceeding it. Or it may propose to itself another aim, and may seek principally to aid in the creation of knowledge rather than in its distribution, and even weighing out." We are pleased to find the views we have so long advocated finding acceptance in so influential a quarter, and we commend the article to the earnest consideration of the University Commissioners.

THE second annual meeting of the Index Society was held on Friday last, the 9th inst., in the rooms of the Society of Arts, when His Excellency the American Minister, Mr. J. Russell Lowell, presided. The Report contained an account of the work already accomplished and of that which is in hand or can be put in hand when the list of subscriptions is enlarged. Many of the Indexes issued through the Society refer to literature and history matters, but science is not overlooked. A Handbook of the Literature of Botany, by Mr. Daydon Jackson, the secretary of the Linnean Society, is just ready for the press, and a companion volume for meteorology is proposed. Indexes of Logic and Anthropology also find a place in the list of schemes. Besides the formal business at the meeting, resolutions were passed for the appointment of committees to consider the best means of carrying out the following objects:—(1) The indexing of biographical collections, especially those contained in the *Gentleman's Magazine* and the *Annual Register*; (2) the indexing of Roman antiquities and remains in Great Britain; and (3) the opening of an office to contain the printed and MS. indexes.

WE have already called attention to the fact that the friends of the late Prof. Alfred Henry Garrod, F.R.S., being desirous of possessing some memorial of him, it has been agreed, after due consideration, that this object will be best effected by the republication in a collected form of all his separate memoirs and papers, both zoological and physiological, prefaced by a biographical notice and portrait of the author. A committee has been formed to carry out this object, consisting of Prof. W. H. Flower, LL.D., F.R.S., P. L. Sclater, Ph.D., F.R.S., Dr. A. Günther, F.R.S., O. Salvin, F.R.S., F. M. Balfour, F.R.S., Prof. E. A. Schäfer, F.R.S., G. E. Dobson, E. R. Alston, Prof. F. Jeffrey Bell, W. A. Forbes, secretary. It is estimated that Prof. Garrod's collected papers will form a volume of about 500 pages, royal octavo, illustrated by twenty-five plates and numerous woodcuts. Each subscriber to the fund will be entitled to receive a copy of the work for every guinea subscribed. Intending subscribers are requested to forward their names, and to state the amount they are willing to subscribe, to the Secretary of the Garrod Memorial Fund, 11, Hanover Square, London, W.

DR. J. H. GLADSTONE, F.R.S., has presented 100*l.* to the Research Fund of the Chemical Society.

THE French Government has allotted M. Pasteur the sum of 50,000 francs for the purpose of enabling him to carry out his researches on the contagious diseases of animals.

WISHING to devote himself exclusively to scientific pursuits, Admiral Mouchez, director of the Paris Observatory, has asked to be placed on the retirement list, a request which has been granted by the Ministry.

THE well-known mathematician, Prof. C. W. Borchardt, died at Rüdersdorf, near Berlin, on June 27. He was formerly Professor of Mathematics in the Military Academy, and of ten years Professor in the University of Berlin. Since 1856 he was editor of the *Journal for Pure and Applied Mathematics*, the oldest of the existing mathematical periodicals.

has been successfully traced to its origin in a harmless dust whirl generated between two currents of air which met in such a way as to produce a whirl in the opposite direction to the hands of a watch, the air at the same time along its subsequent path being oppressively warm and moist. The third tornado occurred about the same time, and passed to the north-east, near Jefferson City. The area covered by these three tornadoes is about 80 square miles, and more than 100 persons lost their lives. Many interesting points were noted by Prof. Nipher and his staff of observers. Almost all the trees blown down were thrown down in the line of the tornado track, and the lane of prostrate trees lying in the line of the storm's path was continued across sparsely wooded tracts, where, consequently, the destructive lane was formed, not by the trees falling on each other, but by each tree being overturned by the violence of the gust. One of the observers, Mrs. Lenz, reports that the whirlwind cloud seemed to be of a circular or wheel shape, dark and heavy on its edges, and white or more like an ordinary cloud in the interior; her description being that it looked like a coiled snake whirling round and round a white centre. In this connection an additional observation was made by another observer, Mr. Steel, to the effect that the bottom of the cloud-funnel seemed to sway somewhat, as well as to move up and down; it looked like dark smoke, and he could occasionally see up into the funnel, which seemed to be hollow, the inside appearing to be lighter coloured than the outside. It is much to be wished that future observers who may be so circumstanced as to be able to observe this feature of whirlwinds would endeavour to note the motions, whether upward or downward, in the interior and on the outside of the funnel, accurate observations on this point being of supreme importance in arriving at a correct knowledge of whirlwinds. It was also noted that trees were stripped of their bark only where the ground was covered with debris, and the barking was confined to the sides of the trees exposed to the flying missiles. It is a singular circumstance that along the whole path of the tornado not a single flash of lightning was observed.

In the *Missouri Weather Service Report* referred to above the tracks of these tornadoes are laid down on the map accompanying the report, and it is in this part of the State that the rainfall of the month was greatest, the maximum of 8'00 inches being at Verona, which is situated near the point where the tornadoes originated. The rainfall over the southern portion of the State equalled five inches, and the amount diminished on proceeding northward. The minimum amount was recorded along the northern slopes of the Missouri valley, the least fall being 1'07 inch at Glasgow. The mean temperature was 58°·7 at St. Louis, or 2°·6 in excess of the average of April. A general and severe fall of temperature followed the storms of the 18th, when snow fell at Oregon, Palmyra, Neosko, and Greenfield.

We are indebted to Mr. W. A. Dixon, Sydney, for a communication on the meteorology of a guano island, originally made by him to the Royal Society of New South Wales. The island referred to is Malden Island, in 4° 2' S. lat. and 154° 58' W. long.; it is triangular in shape, of purely coral formation, and comprising a land area of little over 10,000 acres. The climate of the island, though near the equator, and sometimes having the north-east and sometimes the south-east trades, is generally characterised by extreme dryness. Mr. Dixon resided in Malden Island two and a half years, dating from October 13, 1866, when the following amounts of rain were collected:—In November, 1866, there fell 0'50 inch; in 1867 there fell in September 0'26 inch; October, 0'23 inch; November, 0'63 inch; and December, 0'19 inch; in all, 1'31 inch in twelve days. In 1868 there fell in January 0'69 inch; February, 0'002 inch; March, 0'17 inch; April, 0'19 inch; May, 0'56 inch; June, 0'12 inch; July, 3'82 inches; August, 0'87 inch; September, 0'11 inch; October, 2'89 inches; November, 0'77 inch; and December, 3'46 inches; in all, 13'60 inches in fifty-two days. In 1869 the rainfall was in January, 12'73 inches; in February, 4'83 inches; and March, 2'77 inches; for the three months, 20'33 inches in twenty-eight days. On January 28–29, 1869, there fell in eight and a half hours 4'57 inches of rain. It was often noticed in the daytime that whilst it rained heavily over the ocean all round the island the moisture-laden clouds from the east disappeared as they drifted over the island, and no rain fell. As regards temperature, the variations of the thermometer in shade were extremely regular. At daybreak it stood at 80°, when it gradually rose to 96° between 9 and 10 a.m., about which point

it stood till shortly after sunset, when it began gradually to fall to 80° at 10 p.m., remaining near this point till morning. From January 16 to 29, 1869, the temperature did not rise above 82°, there being continuous rain, and no sun visible, for thirteen days, with the wind due west. An unblackened thermometer frequently exposed to the sun was never observed to rise above 106°·0, but, covered with one inch of light grey soil, it rose to 135°·0. Evaporation was observed at irregular intervals; an average of eight days ending December 11, 1868, gave 0'397 inch per day. In the beginning of October the wind was generally light east, with calms; and the north-east trades began about the middle of the month, varying from east to north-east till the end of February, when light winds and calms again set in, followed by south-east and east trades till October. The currents round the island changed with the changing of the trades, and this change was marked by the movement of an immense mass of sand forming the west beach. From the beginning of March the sand went on accumulating till the beginning of October, forming a beach 120 feet wide, 9 feet high, and a mile long. When the sun crossed the zenith the sand began to move to the south, and all that the waves could reach was removed and carried to the south beach; and the whole of this sand was washed back when the sun again had crossed the zenith going north.

### GEOGRAPHICAL NOTES

It is stated that Col. Prjevalsky and his party are prisoners in the hands of the Chinese, who, it will be remembered, prevented him from proceeding to Lhasa.

The *New York Herald* publishes a telegram from St. John's, Newfoundland, stating that the steamer *Gulnare*, conveying Howgate's expedition to Lady Franklin Bay, has been towed into St. John's with her machinery disabled. The message adds that it is thought probable that she will be sufficiently repaired to proceed north in about a fortnight.

News from the Azores states that a disturbance of the earth has occurred in the island of St. George, resulting in the formation of another small island of about 18,000 square yards, and distant 600 yards from the shore.

An Arctic Exhibition has been opened at the Alexandra Palace, in which a great variety of objects, pictures, photographs, and other things connected with Arctic exploration are displayed. The collection is both interesting and instructive, and is well worth a visit, whatever we may think of Commander Cheyne's scheme, in connection with which the exhibition is being held. Mr. Coxwell makes an experimental ascent to-day at the Palace in connection with Commander Cheyne's project.

In the *Archives des Sciences* for June 15, Prof. Forel describes researches on the temperature of Lake Lemano and other freshwater lakes. *Inter alia*, it appears that the heat penetrates very rapidly into the 50 or 100 metres next the surface (in Lake Lemano) and very slowly in the deeper layers. The temperature proved to be variable even at the extreme depth of 335 m. and the degree of variation showed that depth was still far from the depth where variability ceases. Heat penetrates more deeply into Lake Lemano than into Lake Thun; the isotherms descend on an average 24 m. deeper. By January 15, 1880, Lake Lemano is considered to have expended all the heat put in reserve during the summer of 1879. (This point was not reached in 1879 till February 7.)

No. 87 of the *Zeitschrift* of the Berlin Geographical Society has a long and important article by G. Harting on the formation of valleys. K. Himly gives an interesting account of the "Si Yü Shui Tao Ki," a Chinese work, published in 1824, on the hydrography of Central Asia. There are two articles on South America: one by Max Beschoren, on the forest region of the Rio Uruguay in the Brazilian province of Rio Grande do Sul, and the other by Arthur Werthemann, on the Rivers Parapanura and Cahuapanas in the Peruvian department Amazonas. The journal of the late Erwin v. Bary in North Africa is continued. From the *Verhandlungen*, No. 6, we learn that the Swits contemplate a survey of both coasts of the Red Sea for commercial purposes, and a list is given, based on Schlagintweit's investigations, of the greatest heights of North India and Central Asia.

The principal article in the July number of *Petersmann's Mittheilungen* is on the variation in the quantity of water in the

livers and other bodies of water of the various continents, by Prof. H. Fritz. The author does not think there is any reason for believing that anything like a permanent decrease of the volume of water in rivers has taken place, but that this volume is subject to variations, which, when grouped in periods of about ten years, are seen to be wonderfully regular. He gives, for example, the years 1804, 1816, 1829, 1837, 1848, 1860, 1871, as years of water maxima, and notes as at least a coincidence that these were years of maximum sun-spots. An article by P. F. Baines refers to the recent discovery of the Niger sources; there is information on various recent Nile expeditions, and some notes in connection with the projected railway from Mejillones to La Paz in Bolivia.

### ARTIFICIAL DIAMONDS<sup>1</sup>

IN a preliminary notice, which the Royal Society has done me the honour of publishing in the *Proceedings*, I gave a very short sketch of the work I have done which led me to a reaction whereby hard crystalline carbon has been produced. I have now the honour of laying a detailed account of the methods and results before the Society. As far back as September, 1879, I was searching for a solvent for the alkali metals, and tried experiments with many liquids and gases, but invariably found that when the solvent reached the permanently gaseous state chemical action ensued. This was the case even with hydrocarbons, the metal combining with the hydrogen and setting free the carbon. Paraffin spirit, boiling at 75°, was first used in experimenting, and the spirit contained a considerable amount of olefines; but even these unsaturated hydrocarbons seemed to be split up in like manner. The experiments were conducted in thick tubes from 1 to 1.5 millims. internal, and 10 to 15 external diameter, and made of hard glass.

The alkali metal which decomposes the hydrocarbon retains a quantity of pure hydrogen, which may be seen by exhausting it by the Sprengel pump. A piece of sodium was exhausted in the molten state for five hours by the Sprengel pump, and when no more hydrogen had been evolved for an hour, a piece was placed in a tube with paraffin spirit and heated for two hours, and when a considerable quantity of carbon was deposited, as much of it was removed as could be conveniently obtained and again exhausted, when 32 times its volume of hydrogen was extracted from it. This was repeated several times, and quantities of hydrogen, varying from 17 to 25 times the volume of the sodium, obtained. The carbon deposited on the tube is of a hard scaly nature, and when the sodium is slowly oxidised and dissolved in water, some very hard scales of carbon are often obtained. This was then the reaction on which my work was built. As potassium is a metal of stronger affinities I thought that an examination of its action on paraffin would yield somewhat better results, but in this I was disappointed. Sometimes its action was very great, but it seemed to combine with some of the substance in the tube, and formed black compounds, having no hard carbon amongst them. Some of the experiments did yield a little, but on the whole it was not so good as sodium. Lithium was next tried, and yielded results which were much more hopeful.

After an account of experiments on gaseous solution the author proceeds:—The general result obtained from these experiments was that the solvent power of water was found to be determined by two conditions: 1. Temperature or molecular *vis viva*; and 2. Closeness of the molecules on pressure, which seems to give penetrative power. From these observations it will be seen that if a body has any solvent action on another and does not act upon it chemically, such solvent action may be indefinitely increased by indefinitely increasing the temperature and pressure of the solvent. In nature the temperature has been at one time higher than we can obtain artificially, and the pressure obtained by a depth of 200 miles from the surface is greater than can be supported by any of the materials from which we can form vessels. It will thus be seen that, whereas in nature almost unlimited solvent power could be obtained, we are not as yet able to reproduce these conditions artificially. Could pressure alone increase solvent power, then much might be done, but pressure only acts by keeping the molecules close together when they have great *vis viva*, and this latter is only obtained by high temperature.

As glass tubes were quite out of the question when a red heat

was required, iron tubes were resorted to, and a series of attempts made to dissolve carbon by various gaseous solvents. The difficulty of closing iron tubes as compared with glass tubes caused me to try various methods, which I shall describe here. Tubes were made of strong hydraulic tubing 20" long, 1" thick, and  $\frac{1}{4}$ " bore. These were fitted with a plug, screwed with a strong screw fitting very well. There was placed in the tube some powdered charcoal from which all the inorganic matter had been removed by immersion in hydrochloric and hydrofluoric acids and washing with water, and then sufficient paraffin spirit to fill the tube two-thirds of its volume. The plug was screwed in with a lute composed of silicate of soda and manganese dioxide, but after heating the tube in a reverberatory furnace for four hours it was found to be impossible to remove the plug, so the end had to be bored out. There was neither liquid nor gas in the tube, the luting having leaked. Another tube similarly filled was fitted with a plug with a copper washer, the end of the tube, plug, and washer being polished, but this also leaked, and no result was arrived at. Baryta, clay, asbestos, and other substances, wet with silicate of soda, were all tried with the same result—leakage. A silver washer kept comparatively tight, but only on one occasion. It was thus seen that screw-closing would give no reliable results, so another method was tried. A ball of iron, fitting the tube tightly, was placed in it after the materials had been introduced. The end of the tube was then narrowed by compression between rollers and turned smooth inside. The iron ball was then drawn up by a wire attached and luted by silicate of soda and fine manganese dioxide. It was expected that the pressure would only serve to make the closing more secure, but, on heating, the iron yielded, and the ball was driven out with a loud explosion. After trying several other methods of closing—outside screwing and filling the mouth with molten metal on the top of a clay plug being amongst them—I came to the conclusion that nothing would suffice but welding up the open end. This has been, when carried out efficiently, invariably successful, and in all my later experiments I have used it alone. It requires great skill on the part of the workman, and it is only one man in a hundred who can perform the operation with invariable success. The furnace used in these experiments was a reverberatory one, 6 feet long (internal measurement) and 2 feet broad; fire-place, 15 inches; bridge, 9 inches; hearth, 4 feet. The roof sloped down towards the flue, and the spent gases had exit at the level of the hearth, thus carrying the flame down as it receded from the fire in order to have the hearth of one temperature. The walls were 13 inches thick, and the roof formed of 4-inch fire-clay covers.

Three tubes, 20" x 1" x  $\frac{1}{4}$ " bore, were filled as follows:—

No. I.	3 grms. sodium,	$\frac{3}{4}$ full paraffin spirit.
" II.	" "	$\frac{1}{2}$ " "
" III.	" "	$\frac{1}{4}$ " "

On heating them in the reverberatory furnace, No. I. exploded before a visible red-heat had been obtained, so the temperature was not allowed to rise any higher, and Nos. II. and III. allowed to lie for four hours and then slowly cooled. On being bored open next day, No. II. contained a little scaly carbon, but No. III. contained almost none, and nearly all its liquid had been converted into gas, which rushed out on boring it open. It was noticed by the workmen that the inside of the tube was harder to bore than the outside, and I thought, as I found out afterwards rightly, that the iron had been carbonised and converted into steel. It seemed, then, that the free carbon had been taken up by the iron.

An account of a number of preliminary experiments with various tubes here follows:—The iron used in making the tubes is what is known as "Lowmoor" iron, a very pure and strong quality, and a portion removed from the interior of a tube which has been used gave, on analysis, 2.17 per cent. of carbon, showing to what an extent carbonisation had gone on.

Having obtained results from this process of a kind which showed that diamond was unlikely to be formed by its agency, I reverted to the original idea of solution of carbon in a gaseous menstruum, and from some experiments I had been carrying on with the view of finding some commercial use for "bone oil," I concluded that the distillate from bone oil containing the nitrogenous bases would be most likely to yield such a solvent. Bone oil, the nitrogenous distillate obtained in the manufacture of bone char, and for a plentiful supply of which I am indebted to Messrs. John Poynter and Sons of Glasgow, was distilled, and the portion boiling between 115° and 150° was taken and rectified

<sup>1</sup>On the Artificial Formation of the Diamond." Paper read at the Royal Society by J. B. Hannay, F.R.S.E., F.C.S. Abstract by the Author.

over solid caustic potash, and latterly over sodium. When satisfied that it was free from moisture, oxygen, and sulphur, a tube,  $2\frac{1}{2}$ "  $\times$  20"  $\times$   $\frac{1}{4}$ " bore, was three parts filled, and some charcoal powder added, and the whole welded up solid. I found that the nitrogenous liquid was even worse to work with than the hydrocarbon, as on coming into contact with the hot iron it burnt it away at once, and as the tube was of great diameter it was extremely difficult to keep the lower part cool. For welding it had to be arranged so that it was standing in a tub of ice, and the top projecting through the bottom of the forge, and heated until it was at a welding heat, with as little de'ay as possible. When a tube was obtained welded up solid it was heated to a dull red-heat for 14 hours and allowed to cool; on opening the tube there was a very great out-rush of gas, and the carbon was to a certain extent dissolved, and some minute portions of it very hard. Still, under the microscope it presented little difference in appearance from the wood charcoal employed, some of the features, however, being obliterated, and it had a bright appearance. Another tube of the same dimensions and contents was closed up in the same manner, but after eight hours' heating it burst with a loud explosion. I had noticed that a tube which had been once used and been partially carbonised would not stand a second heating, and for this reason I had no belief in the power of cast-iron or steel to withstand the great pressure at a red heat. Nevertheless, as many of my friends had urged upon me to try these materials, I had a cast-iron tube made,  $3\frac{3}{4}$ "  $\times$  24"  $\times$   $\frac{1}{4}$ " bore, and filled two-thirds of its volume with bone oil distillate and carbon, and then welded up. We succeeded after a little trouble in making a good weld, and the tube was then slowly raised to a dull red-heat in the furnace. It had not been heated for more than an hour when it exploded with a great noise and knocked down the back and one of the ends of the furnace, leaving the whole structure a wreck. The tube had broken into small fragments, and was quite unlike the malleable iron tubes which generally tore up. Thinking that it was perhaps a bad casting, I tried another, but it leaked all over, and emptied itself before the temperature was nearly up. A third tube of the same material burst like the first, but as I had built up the furnace with large blast-furnace blocks, it was not blown down. Cast-iron being inadmissible, experiments were then made with steel. I had several tubes made of this material by the best firms in the kingdom—made by the three methods, Bessemer, Siemens, and the crucible method—but they had the same faults as cast-iron, although to a less degree. The difficulty in making a good weld in cast-iron and steel tubes makes their employment in such experiments as these a matter of inconvenience. Out of five tubes made of steel, some of which were made of the very toughest material manufactured by Messrs. Cammell and Co., only one held in the substance completely. Three burst in the furnace, and one had leaked by its porosity. The top of the furnace, by the continued shocks of explosions, fell in at the bursting of the last of the steel tubes. The continued strain on the nerves, watching the temperature of the furnace, and in a state of tension in case of an explosion, induces a nervous state which is extremely weakening, and when the explosion occurs it sometimes shakes one so severely that sickness supervenes. An account of several experiments follows, none of which were, however, successful.

I thought I should either have to abandon the attempt or begin experiments of a very expensive nature, using large tubes and a large furnace, as 20-inch tubes of a greater diameter than four inches could not be closed when three parts filled—at least by welding. As some of them, however, seemed to stand, I determined to make some further trials with the apparatus I had at my disposal; so another tube, 20"  $\times$  4"  $\times$   $\frac{1}{4}$ " bore was filled, using 4 grms. of lithium and a mixture of bone oil, carefully rectified, 90 per cent., and paraffin spirit 10 per cent., using these proportions because I had never had any results with a high percentage of bone oil, the tubes so filled having burst. The tube was closed with great difficulty, being three-parts full of liquid, and then heated to a visible red heat for fourteen hours, and allowed to cool slowly. On opening the tube a great volume of gas was given off, and only a little liquid remained. In the end of the tube which had been the upper end in the furnace, the tube lying obliquely, there was a hard smooth mass adhering to the sides of the tube, and entirely covering the bottom. As I had never obtained all the solids in one piece before, I wished to examine it, and so had the other end of the tube cut off, exposing the hard mass. It was quite black, and was removed with a chisel, and as it appeared to be composed principally of iron and lithium; it

was laid aside for analysis. I was pulverising it in a mortar when I felt that some parts of the material were extremely hard—not resisting a blow, but hard otherwise. On looking closer I saw that these were mostly transparent pieces imbedded in the hard matrix, and on triturating them I obtained some free from the black matter. They turned out to be crystalline carbon, exactly like diamond. I shall describe further on the analyses, &c., but will here go on with the account of my further experiments. Two tubes were filled in the same manner as the last, but one burst on heating, and the other had leaked so that there was no reaction. Two more tubes were prepared, but were spoiled on welding, and on cutting off the carbonised portion the remainder was too short to work. After much trouble three tubes were obtained, well closed, in which the three alkali metals were inclosed with liquid containing 20 per cent. bone oil and 80 per cent. paraffin. All three stood, and, on opening, only the potassium one had leaked to any extent. The results were not good, however, the sodium tube containing only soft scaly carbon, and the other two very little better. The reaction did not seem to have proceeded in the same manner in the lithium tube as before, as the mass was soft and friable. Still, lithium seemed to yield the best results, so it was adhered to in the further experiments. A list of disasters now awaited me. Eight tubes failed through bursting and leaking, and one of the explosions, when two were being heated together, destroyed a part of the furnace and injured one of my workmen. Besides this, two tubes were spoiled in welding. However, I had four experiments after this, all withstanding the pressure, and in one of these, with 10 per cent. bone oil and 90 per cent. paraffin spirit, a small quantity of diamond was found. The contents of this tube were different from the other successful one, being much looser and not in the same hard mass as the first. In another series of six experiments two were at first thought to have been successful, but I afterwards found that one of them was not so, the transparent matter being siliceous, but insoluble in cold hydrofluoric acid, although it dissolved on boiling. The uncertainty and great expense involved in using these forged coils of iron with tubes bored out of the solid induced me to again try steel, and Messrs. Cammell and Co., having prepared some tubes for me, I tried them, but with the same results—they exploded into fragments at a red heat. And herein they are much more dangerous than coiled tubes, because the latter seldom fly into fragments, but just tear open a little. A further unforeseen danger in using steel tubes was discovered. One which had stood the heating very well was being bored, and when the inner skin was cut so that the gas rushed out, the whole exploded, endangering the life of the workman who was boring, but as he was standing at the end of the tube and the pieces flew laterally, he was not hurt. I have performed over eighty experiments, and have only obtained three results of a successful nature. The identification of the crystalline pieces as carbon was easy enough, but I have been anxious to find whether they are pure carbon or a compound with some other element, and to that end the following experiments were conducted.

A portion of the substance from the first successful experiment was weighed out after it had been freed from all foreign matter adhering to it, and placed in a very small platinum boat made of a strip of thin foil, the ends of which were wrapped round two stout platinum wires which were sealed into a wide glass tube. The carbon particles were transferred to this boat after being weighed, and the tube connected by india-rubber stoppers with an oxygen gasometer on the one side and a series of potash bulbs on the other. The oxygen was dried over solid caustic potash before entering the tube, and again after leaving the potash bulbs. The carbon (14 mgrms.) having been weighed out, the potash bulbs were weighed, and a current of oxygen passed through the apparatus, and the platinum wires connected with a battery strong enough to heat the foil to a bright red-heat. After a few minutes the oxygen was stopped and the bulbs weighed, when it was found that they had gained 1 mgrm. On repeating this operation no gain was found, the moisture having been entirely driven off by the first treatment. The carbon was now placed in the boat, and a slow current of oxygen started, then the bulbs connected and the current made to pass through the platinum until all the diamond had been burnt, when the current was stopped and the oxygen allowed to pass for fifteen minutes more, when the bulbs were detached and weighed. They were then reconnected and the gas passed for other ten minutes to find whether all the carbonic acid had been expelled,

and reweighed. They weighed 0.2 mgrm. less than before. The numbers were as follows:—

Potash bulbs before combustion	...	43.8308	
" " after "	...	43.8776	'0468
Drying tube before combustion	...	26.4294	
" " after "	...	26.4328	'0034
			'0502

This gives a composition of 97.85 per cent. of carbon, which is a pretty fair approximation to pure carbon. However, to determine whether or not this was the case, some further experiments were tried. A small quantity of the carbon was placed on the platinum boat and burnt in oxygen without any of the gas being allowed to pass out of the apparatus, and the mixed gases so obtained transferred to a eudiometer, and the carbonic acid and oxygen absorbed. It was then found that a residue amounting to about 3 per cent. of the carbonic acid was left unabsorbed by alkaline pyrogallate solution. This proved to be nitrogen. A blank experiment was done, but it gave only a minute bubble of nitrogen. Another experiment was performed with the following results:—

Total volume	...	183.7	
After absorption of CO <sub>2</sub>	...	148.5	CO <sub>2</sub> = 35.2
After " O	...	111.0	147.4
		N	1.1

This plainly shows that nitrogen was present from some cause another, and as every precaution was taken in transferring the gas from one vessel to another, and as the blank experiment showed nothing, I am inclined to believe that the carbon, or at least some portions of it, contained nitrogen chemically combined. The numbers above given are degrees on the eudiometer scale, and are not more than one-third of a cubic centimetre each. Their exact value was of no consequence in the experiment, and the tube was only calibrated by comparing one part with another, and not with an absolute measure.

From the fact that no diamond was found when nitrogen compounds were absent, and from the fact that the mixed product or only a portion of the 14 mgrms. was clear (diamond) contains nitrogen, I am inclined to believe that it is by the decomposition of a nitrogenous body, and not the hydrocarbon, that a diamond is formed in this reaction. The experiments are, however, too few, and the evidence too vague, to draw any conclusions, as there are even very few negative experiments on which anything can be learned, most of the results being lost by explosion. I intend, when my other work—which I hold aside for the diamond experiments—is finished, to begin a series of experiments on the decompositions of carbon compounds by metals, to find whether a more easily-controlled action may not be discovered.

UNIVERSITY AND EDUCATIONAL INTELLIGENCE

THE following circular has been issued by the Science and Art Department:—"It having been represented to the Lords of the Committee of Council on Education that many parts of the Kingdom are still in ignorance of the system of aid to the formation of classes for instruction in the principles of agriculture afforded by the Science and Art Department; that the supply of teachers who have obtained the necessary qualification to earn payments on results is very limited; and that a strict adherence to the rules of the Science Directory, which require that, in order to obtain aid, classes must be under the instruction of such teachers, would entail the delay of a year in the commencement of classes in this important subject, my Lords decide that [xxxiv. and xxxvi. of the Directory may be relaxed for this year in the following manner:—My Lords will be prepared to consider an application from any committee, formed in accordance with § x. of the Science Directory, to grant a temporary qualification to any person selected by it as fitted to teach the principles of Agriculture, and, if such application be found satisfactory, will permit the teacher to earn payments on the results of the examination in May, 1881; on the condition that this provisional qualification shall then determine, and that the only teachers who can after that date be recognised as qualified to earn payments on the results of their teaching in this subject will

be such as have complied with the ordinary rules. In making the application the committee must show that there is no technically qualified teacher in the locality who could be employed to instruct the class, and also state the grounds on which the proposed teacher is considered to be really capable of giving instruction in agriculture, by his knowledge of chemistry and other sciences bearing on the subject."

MR. RICHARD CHARLES ROWE, M.A., B.Sc., Fellow of Trinity College, Cambridge, has been appointed Professor of Mathematics in University College, London.

PLANS have been prepared for a new botanical class-room in connection with Edinburgh University, the present room being much too small. The plans have been submitted to Government; if approved there will be a grant for the purpose required. The new class-room proposed will be seated for six hundred students, while the old class-room will be altered so as to be used as a practical and histological class-room.

SCIENTIFIC SERIALS

*American Journal of Science*, June.—Physical structure and hypsometry of the Catskill Mountain region, by A. Guyot.—Recent explorations in the Wappinger Valley limestone of Dutchess Co., N.Y., by W. B. Dwight.—The colour-correction of certain achromatic object-glasses, by C. A. Young.—Note on the companion of Sirius, by A. Hall.—Study of the Emmet Co. meteorite that fell near Estherville, May 10, 1879, by J. Lawrence Smith.—Oxidation of hydrochloric acid solutions of antimony in the atmosphere, by J. P. Cooke.—Relation between the colours and magnitudes of the components of binary stars, by E. S. Holden.—Occurrence of true lingua in the Trenton limestones, by R. P. Whitfield.—Experiments on Mr. Edison's dynamometer, dynamo-machine, and lamp, by Profs. Brackett and Young.—On substances possessing the power of developing the latent photographic image, by M. Carey Lea.

*Archives des Sciences Physiques et Naturelles*, June 15.—Researches on the temperature of Lake Leman and other freshwater lakes, by Prof. Forel.—The disease of workmen employed in the St. Gothard tunnel, by Dr. Lombard.—Explosions by freezing, by Prof. Hagenbach.—On a yellow rain observed near Bonneville in Savoy, on April 25, 1880, by M. de Candolle.—Diatoms of the Alps and the Jura, and of the Swiss and French region in the environs of Geneva, by M. Bonn.—On a simplification of the theory of vibratory movements, by M. Cellérier.

*Atti dei R. Accademia dei Lincei*, fasc. 6, May.—Distribution of electricity in equilibrium on two parallel indefinite plane conductors, subjected to the induction of a point in the space included by them, by Dr. Maggi.—On a meteoric rain, containing an abundant quantity of metallic iron, observed at Catania on the night of March 29-30, 1880, by Prof. Silvestri.—On bromo-camphor, by Prof. Schliiff.—Chemical and pathological studies on the hematopoetic function, by SS. Tizzoni and Fileti.—Influence of light on the production of hæmoglobin, by the same.—On ethylnaphthalene, by S. Camelutti.—On phenol derived from santonic acid, by the same.—On a connection between meteorological phenomena and the time of arrival of the earth at perihelion, by Mr. Jenkins.—On the electric polarisation produced by metallic deposits, by Prof. Macaluso.—On the envelope and structure of the uveal tract in vertebrates, by Dr. Angelucci.—Helminthological observations on the endemic malady of the workmen in the St. Gothard (*Ancylostoma duodenale*), by Prof. Perroncito.

*Reale Istituto Lombardo di Scienze e Lettere. Rendiconti*. Vol. xiii, fasc. xii.—On the aberration of sphericity, &c. (continued), by Prof. Ferrini.—On injury to agriculture caused by the winter 1879-80, by Prof. Cantoni.—On a problem of electrostatics, by Dr. Maggi.

*La Natura*, vol. iv, Nos. 3 and 4 (February).—On some recent studies in agrarian meteorology, by S. Porro.—Morphogeny of animal individuality, by Dr. Cattaneo.

*Bulletin de l'Académie Royale des Sciences de Belgique*, No. 1, 1880.—Letter from Dr. Huggins on the subject of M. Piazzi's recent note.

*Journal de Physique*, June.—Vibrations on the surface of a liquid in a rectangular vessel, by Prof. Lechat.—On the economic yield of electric motors, and on measurement of the quantity of energy which traverses an electric circuit, by M.

Deprez.—An experiment in physiological optics, by M. Bibart.  
—Measurement of the refractive indices of liquids, by MM. Maedé  
de Lépinay.

### SOCIETIES AND ACADEMIES

#### LONDON

Royal Society, May 27.—“A Preliminary Account of the Reduction of Observations on Strained Materials, Leyden Jars, and Voltameters,” by John Perry and W. E. Ayrton. Communicated by Prof. G. G. Stokes, Sec. R.S. [Abstract].

In discussing the residual-charge phenomena of condensers, the authors point out that in spite of certain elaborate measurements which have been made on different kinds of glass, nobody has yet discovered a constant such that it expresses the residual charge property of a particular substance. They therefore say that the simple plan of charging a Leyden jar for a long time, short-circuiting for a small definite period, then insulating and giving the residual charge at certain times from insulation (thus getting say three definite numbers for each dielectric experimented upon), is more accurate than, and is just as definite as, any plan hitherto proposed for determining the residual-charge properties of a dielectric. They show that if Prof. Clerk Maxwell is right, the only correct means of studying these properties are given by the constants of Maxwell's differential equation, and they describe experiments on the Leyden jar of a Thomson's electrometer, and reductions of observations to obtain such constants. Thus one such constant is found to satisfy all the observations made from the 500th to the 900th minute of insulation of a jar. The authors draw attention to the analogy which they have pointed out between condensers and voltmeters charged by electromotive forces less than one and a half volts, and show that if we assume Maxwell's equation to be true for voltmeters, that is, if we assume a voltmeter to be a condenser, one constant satisfies observations from the 50th to the 190th minute of charging, and from the 20th to the 80th minute of discharging. They then proceed to develop a theory of the increasing strains in bodies subjected to constant stresses. When a homogeneous substance is suddenly subjected to stress, there is a suddenly produced strain which follows Hooke's law, depending on a constant  $k$ , but besides this there is a viscid increase of strain whose rate is proportional to the stress depending on a constant  $r$ . In steel the viscid strain is not of much importance, whereas in water strained by bodies moving in it it is very important, as it is also when a beam of sealing wax is loaded. They show that the viscid increase of strain is exactly analogous with the flow of electricity in accordance with Ohm's law, and that the suddenly-produced strain is analogous with induction; and considering a heterogeneous material subjected to bearing stress, they find that the above assumptions lead, for strained materials, to exactly the same equation as Prof. Maxwell found for condensers. They found that the support of this theory is exactly the same as the support which they have given of Maxwell's theory of condensers. Thus one constant of the equation satisfied the recovery from deflection of a glass beam from the 4th to the 240th hour of relief, and satisfied the recovery from twisting of a glass fibre for all but the first few observations. They have also constructed a voltmeter such that the platinum electrodes may be maintained at any temperature in an atmosphere of any gas for any length of time, maintaining a vacuum over the liquid or saturating it with any gas, and they give the different values of the residual charge constant, which satisfies all but the first few observations of charge and discharge in different cases. The authors conclude their paper by saying that, regarding a voltmeter as a condenser, then as the plates of the charging battery are larger and nearer together, and as the times of charge and discharge of the voltmeter are made less and less, the more do the total quantities of the charge and discharge approximate to one another.

Physical Society, June 26.—Prof. W. G. Adams in the chair.—Mr. C. V. Boys read a paper, by Prof. Guthrie and himself, on the measurement of the conductivity of liquids by means of magneto-electric induction. The liquid is suspended in a glass vessel by a fine iron wire in the centre of a cylindrical electro-magnet formed of two semicircular parts. This electro-magnet is rotated at a velocity not exceeding 3,000 turns per minute, and the liquid being drawn round in the direction of rotation, the wire is subjected to torsion, which, under correction for certain errors, is proportional to the resistance of the liquid. The torsion is observed by means of a scale and microscope

The results, plotted in a curve, agree very closely with those of Kohlrausch, obtained by alternate currents, and Dr. Guthrie thinks that they are probably more correct and trustworthy than Kohlrausch's, for the method would seem to be superior and the curve contains fewer excentric points than his.—Dr. Gladstone read a paper on the refraction equivalents of isomeric bodies, in which he described the present state of the subject and his own contributions to it. He showed that the refractive power of bodies over light was of great importance to chemists, since it depended on their essential structure.—Dr. Huggins described his latest results of star spectra, and illustrated his remarks by photographic spectra taken by his improved method. From these it appears certain stars, such as Vega, give a complete spectrum of hydrogen. Others, more yellowish in colour, show a thinning of these lines, such as Sirius,  $\eta$  Ursæ Majoris. Others show the intrusion of more refrangible lines; for example, Arcturus,  $\alpha$  Aquila,  $\alpha$  Virginis; while Capella gives a complex spectrum like that of the sun. Dr. Huggins also showed a spectrum of the flame of a spirit lamp, which presented a strong group of lines at S, and he considered it to represent the light emitted by the molecules of water. He further observed that the spectrum offered a highly sensitive test of the presence of carbon.—Mr. Liveing exhibited a new fire-damp indicator, capable of detecting  $\frac{1}{4}$  per cent. of marsh gas in air. It is based on the fact that an incandescent body shows more brilliantly in proportion to the amount of marsh gas in the air, and consists of two fine platinum wires kept incandescent by a magneto-electric current sent through them in one circuit. One wire is excluded from the fire-damp, the other is exposed to it, and the relative intensities of the two glowing wires is compared by a photometric screen placed between them and adjustable to a position between them at which the reflections of the wires on the screen are of equal intensity. The position of the screen relatively to the wires is given by a scale, and measures the proportion of fire-damp in the air. This contrivance is more advantageous than the safety-lamp, which only indicates 2 per cent. of marsh gas in the air.—Dr. Stone exhibited a vacuum-tube of variable resistance and a large electro-magnet wound with iron wire. The former consists of a barometer tube thirty-two inches long, terminating above in a short vacuum-chamber arranged transversely, and closed at either end by adjustable india-rubber stoppers, through which platinum terminals are passed. Above this the vertical tube is continued to a glass stopcock, by means of which small quantities of air can be introduced. The foot of the tube is attached to an india-rubber flexible pipe with a cistern like that of Frankland's gas apparatus. The cistern full of mercury is counter-balanced, and can be raised or lowered at will through the whole thirty-two inches. A Torricellian vacuum can thus be made in the upper chamber, or one of more or less perfectness. On passing the induction-spark between the terminals in the former case all the discharge is carried off, none appearing at the discharger. By gradually raising and lowering the cistern, after admitting a little air by the stopcock, the resistance of the partial vacuum thus obtained can be altered within wide limits. A point can also be found where the spark of breaking-contact is shunted through the vacuum-tube, while the weaker discharge of making-contact is stopped. The induction-current is thus obtained in a single direction, a matter of some importance in physiological experiments. The electro-magnet could not be described from pressure of other matter. Its peculiarities consisted in its being wound with best charcoal-annealed wire of about 5 millim. section in four parallel circuits, and in each pole being cast, after winding into a solid block of paraffin. It was expected that the latter device would increase the inductive effect of the spiral, and indeed it appeared that the lifting power was somewhat strengthened. The cores had been originally wound with best copper wire of about the same weight as the iron wire. But the lifting power for batteries of moderate size, five or six Bunsen cells, for instance, had increased fourfold after the substitution. A paper by Mr. McFarlane Gray entitled specific heat calculated from entropy. This is a re-affirmation of a paper of value of  $v$ , declined by the committee of the Royal Society in February, 1878. The author read a paper at the last meeting of the Institution of Naval Architects, which we saw in our singularly bold and original attempt to account for many of the phenomena of steam and other effects of heat when applied to matter. In the present paper Mr. Gray continues in the same line of startling generalisation. The following is a specimen:—Taking the  $p$  of hydrogen at  $493^{\circ}2$  F., as in Rankine's tables, to be 272810 foot pounds, he writes—

$$m = \frac{m \rho v}{\theta} = \frac{2 \times 378819}{772 \times 463^2} 1'989856.$$

The letter  $m$  in the paper with the value obtained as above is applied in the following remarkable generalisations:  $m$  being the molecular weight of the substances, and  $\rho v$  and  $\theta$  being the pressure, volume, and absolute temperature in any standard units.

The thermal equivalent of  $\rho v = \frac{m}{m} \theta$ .

Specific heat at constant volume =  $2\frac{1}{2} \frac{m}{m} \theta$

Specific heat at constant pressure =  $3\frac{1}{2} \frac{m}{m} \theta$

The specific heat in the gaseous state is therefore at constant pressure.

$$\frac{3\frac{1}{2} \times 1'989856}{17'96} = .387779$$

For  $H_2O$ , water in the gaseous state. By calculating the difference of entropy for water at numerous temperatures for the different states of aggregation, first absolute  $H_2O$  without energy volume, secondly, water as we know it with a volume increasing with temperature; thirdly, water split into single molecules, but these at without motion; fourthly, single molecule  $H_2O$  or steam as it is; he shows that the difference of entropy between the third and the fourth state is equal to the specific heat at constant pressure, and that the whole energy possessed by the water up to the split and motionless state is a constant quantity at all temperatures for the same substance. He calls this quantity the absolute splitting heat; the splitting heat above any standard state he calls the original splitting heat,  $S$  a constant quantity for all temperatures. From the entropy calculation for more than twenty temperatures, he calculates to seven places of decimals from Regnault's exact formula ( $H$ ) for saturated steam, he takes two temperatures indiscriminately, and equates the value of  $S$  expressed in entropy quantities with one unknown quantity, the specific heat entropy.

Equating 278° C. with 374° C. gives	...	387729
" 278° C. with 494° C. gives	...	387867
	2)	775596
Mean calculated specific heat	...	387798
Instead of	...	387779
Difference	...	000019

The value of  $S$  above melted ice is for water

Calculated at 278°	...	$S = 502'386$
" 294°	...	$S = 502'405$
	2)	1004'791
		502'395 C.
	or	904'311 F.

This is a remarkable corroboration of the kinetic theory of gases, quite unlooked for in steam experiments, and, as the author of the paper remarked, it shows how reliable are the results of the experimenter Regnault. The author also explained a new diagram, in which the area is energy, the length entropy, and the height temperature. In such a diagram it becomes as simple an idea as temperature. From this it appears that the ratio of the two specific heats is 1.4 for steam.—Mr. Clark communicated a paper on the behaviour of liquids and gases near their critical temperatures.—Mr. Winstanley exhibited two new varieties of air-thermometers and a thermograph actuated by an air-thermometer on the principle of his radiograph exhibited at last meeting. The first thermometer consists of a U tube with amalgam bulbs and the left leg of much finer bore than the right. Mercury is in the right leg, sulphuric acid surmounted with air in the left. The apparatus is a barometer to the air inside the left bulb, and a thermometer to that outside. A similar combination of an air-thermometer and an aneroid barometer constitutes the second instrument. The expansion or contraction of the air in the stem by external temperature expands or compresses a small aneroid chamber in the bulb.—Mr. Gee and Mr. Stroud made a communication on a modification of Bunsen's calorimeter, which will be found in the *Proceedings* of the Society.—The meeting then adjourned till the winter session commences.

Geological Society, June 23.—Robert Etheridge, F.R.S., resident, in the chair.—Edwin Muir, Benjamin Sykes, and

John Thorburn were elected Fellows of the Society. The following communications were read:—On the skull of an *Ichthyosaurus* from the lias of Whitby, apparently indicating a new species (*I. satlandicus*, Seeley), preserved in the Woodwardian Museum of the University of Cambridge, by Prof. H. G. Seeley, F.R.S.—Note on the cranial characters of a large Teleosaurus from the Whitby lias, preserved in the Woodwardian Museum of the University of Cambridge, by Prof. H. G. Seeley, F.R.S.—On the discovery of the place where Paleolithic implements were made at Crayford, by F. C. J. Spurrell, F.G.S.—The geology of Central Wales, by Walter Keating, F.G.S., with an appendix by C. Lapworth, F.G.S., on a new species of *Cladophora*.—On new Erian (Devonian) plants, by J. W. Dawson, F.R.S. The paper first referred to recent publications bearing on the Erian (Devonian) flora of North-East America, and then proceeded to describe new species from New York and New Brunswick, and to notice others from Queensland, Australia, and Scotland. The first and most interesting is a small tree-fern, *Astopteris noveboracensis*, characterised by an axial cylinder composed of radiating vertical plates of scalariform tissue imbedded in parenchyma and surrounded by an outer cylinder penetrated with leaf-bundles with dumb bell-shaped vascular centres. The specimen was collected by Mr. B. Wright in the Upper Devonian of New York. Another new fern from New York is a species of *Equisetides* (*E. wrightianum*), showing a hairy or bristly surface, and sheaths of about twelve short acuminate leaves. A new and peculiar form of wood, obtained by Prof. Clarke of Amherst College, Massachusetts, from the Devonian of New York, was described under the name *Celluloxylon primævum*. It presents some analogies with *Prototaxites* and with *Aphyllum paradoxum* of Unger. Several new ferns were described from the well-known Middle Devonian plant-beds of St. John's, New Brunswick; and new facts were mentioned as confirmatory of the age assigned to these beds, as showing the harmony of their flora with that of the Erian of New York, and as illustrating the fact that the flora of the Middle and Upper Devonian was eminently distinguished by the number and variety of its species of ferns, both herbaceous and arborescent. It will probably be found eventually that in ferns, equisetaceous plants, and conifers, the Devonian was relatively richer than the Carboniferous. Reference was also made to a seed of the genus *Altheotesta* of Charles Brongniart, found by the Rev. T. Brown in the Old Red Sandstone of Perthshire, Scotland, and to a species of the genus *Dicranophyllum* of Grand'Eury, discovered by Mr. J. L. Jack, F.G.S., in the Devonian of Queensland. In all, this paper added six or seven new types to the flora of the Erian period. Several of them belong to generic forms not previously traced further back than the Carboniferous. The author uses the term "Erian" for that great system of formations intervening in America between the Upper Silurian and the Lower Carboniferous, and which, in the present uncertainty as to formations of this age in Great Britain, should be regarded as the type of the formations of the period. It is the "Erie Division" of the original Survey of New York, and is spread around the shores of Lake Erie, and to a great distance to the southward.—On the terminations of some Ammonites from the inferior oolite of Dorset and Somerset, by James Buckman, F.L.S.—Faröe Islands: Notes upon the coal found at Suderöe, by Arthur H. Stokes, F.G.S.—On some new cretaceous *Comatula*, by P. Herbert Carpenter, M.A. Communicated by Prof. P. Martin Duncan, F.R.S.—On the Old Red Sandstone of the north of Ireland, by F. Nolan, M.R.I.A. Communicated by Prof. Hull, F.R.S.—A review of the family Vinctulariæ, recent and fossil, for the purpose of classification, by G. R. Vine. Communicated by Prof. P. M. Duncan, F.R.S.—On the zones of marine fossils in the calciferous sandstone series of Fife, by James W. Kirkby. Communicated by Prof. T. Rupert Jones, F.R.S.—The glaciation of the Orkney Islands, by B. N. Peach, F.G.S., and John Horne, F.G.S. In this paper, which forms a sequel to their description of the glaciation of the Shetland Isles, the authors, after sketching the geological structure of Orkney, proceeded to discuss the glacial phenomena. From an examination of the various striated surfaces they inferred that the ice which glaciated Orkney must have crossed the islands in a north-westerly direction from the North Sea to the Atlantic. They showed that the dispersal of the stones in the boulder-clay completely substantiates this conclusion; for in Westray this deposit contains blocks of sandstone derived from the Island of Eda, while in Skapish blocks of slaggy diabase, occurring *in situ* on the south-west

shore, are found in the boulder-clay of the north-west of the island. Again, on the mainland, blocks of the coarse siliceous sandstones which cross the island from Ingness to Orpin are met with in the boulder-clay between Heaton Head and the Loch of Slennis. Moreover, they discovered in the boulder-clay the following rocks, which are foreign to the island: chalk, chalk-flints, oolitic limestone, oolitic breccia, dark limestone of Califerous-sandstone age, quartzites, gneiss, &c., some of which closely resemble the representatives of these formations on the east of Scotland, and have doubtless been derived from thence. From this they infer that, while Shetland was glaciated by the Scandinavian *mer de glace*, Orkney was glaciated by the Scotch ice-sheet, the respective ice-sheets having coalesced on the floor of the North Sea and moved in a north-westerly direction towards the Atlantic. They also found abundant fragments of marine shells in most of the boulder-clay sections, which are smoothed and striated precisely like the stones in that deposit. They conclude that these organisms lived in the North Sea prior to the great extension of the ice, and that their remains were commingled with the *moraine profonde* as the ice-sheet crept over the ocean-bed. From the marked absence of shell-fragments in the Shetland boulder-clay they are inclined to believe that much of the present sea-floor round that group of islands formed dry land during the climax of glacial cold.

## PARIS

Academy of Sciences, July 5.—M. Edm. Becquerel in the chair.—The death of M. Borchardt (correspondent in Geometry) was announced.—The following papers were read.—Study of the variation of the line of sight, on the great meridian circle of Paris Observatory (constructed by M. Eichens), by means of a new apparatus, by M. Loewy. The essential part is a small glass disk giving simultaneously three images in the eye-piece: (1) that of the cross wires, (2) that of a division drawn on the objective, and (3) that of one of the divisions of a plate inserted in the axis.—On the photography of the chromosphere, by M. Janssen. The exposure is continued till the solar image is positive to the border; the chromosphere then appears as a dark circle 8" or 10" in width.—On the integration of linear equations by means of the sines of superior orders, by M. Villarceau.—On the consequences of the experiment of MM. Lontin and de Fonville, by M. Jamin. He indicates experiments which should test his explanation.—On the vision of colours, by M. Chevreul.—On some general relations between the chemical mass of elements and the heat of formation of their combinations (continued), by M. Berthelot. The influence of mass of the elements in diminishing the stability, and therefore the heat liberated, may be conceived simply by supposing that the system formed by two molecules will be more exposed to destruction by movements of the whole system (rotations, vibrations, &c.) the heavier the molecules. On the other hand, the reserve of energy (which is gradually expended in combination), should, *ceteris paribus*, be greater in light elements than in heavy ones.—Epochs of vegetation for the same tree in 1879 and in 1880, by M. Duchartre. Though the temperature was much more severe in December and January last than the previous year, the renewal of vegetation in six chestnuts was earlier. The mild time between the cold of December, 1879, and January, 1880, does not account for this, for a longer and milder time intervened in 1878-79. Nor does the method of sums of heat explain it. But the trees received more heat this year from the beginning of vegetation to complete expansion of their leaves.—On a meteorite which fell on November 16, 1874 at Kerilis (Côtes du Nord), by M. Daubrée. This belonged to the sub-group Oligosideres in the Sporosideres.—On a meteorite which fell on September 6, 1841, in the vineyards of Saint Christophe-la-Chartreuse (Vendée), by M. Daubrée.—Inquiry into the situation of agriculture in France in 1879, by M. Chevreul.—On the utility of quarantines, by M. de Lesseps. He gives examples of their inadequacy.—Nature of the immunity of Algerian sheep against spleen-disease; is it an aptitude of race? by M. Chauveau. The property is congenital and natural. It may be communicated by crossing to European sheep. French sheep bred in Algeria do not acquire it, and it is not proved that Algerian sheep bred in France may not lose it.—Determination of the difference of longitude between Paris and Bonn, by MM. Le Clerc and De Bernardières. The figures obtained are 19m. 2'269s., probable error  $\pm 0'009s.$  German astronomers found for the same arc, 19m. 2'231s.—Some remarks on the equation of Lamé, by M. Esary.—Integration of any number of simultaneous equations

between a given number of functions of two independent variables and their partial derivatives of the first order, by M. Turquan.—On the bright spectral lines of scandium, by M. Thalen.—Improvements in Siemens' bobbins, by M. Trouvé. He suppresses the two periods of indifference, making the polar faces of steel form, so that the surfaces approach those of the magnet gradually till the moment that the posterior edge escapes from the pole when repulsion commences. The work is thus economised.—On the sensibility of the eye to differences of light, by M. Charpentier. A given light, strong or weak, must (in his case) be increased or diminished about eight hundredths to give a distinct new sensation; and it seems to be the same in indirect vision [as in direct, and with coloured as with white light.—Thermic study of polysulphides of ammonium and persulphide of hydrogen, by M. Sabatier.—On the density of iodine vapour, by M. Troost. He finds it to diminish both at a low and at a high temperature, so that dissociation or isomeric change seem hardly admissible.—On the atomic weight and on some characteristic salts of ytterbium, by M. Nilson.—On the dissolution of platinum in sulphuric acid, by M. Scheurer-Kestner. The attack of platinum is always due to presence of nitrogenised compounds in the sulphuric acid.—Remarks on etherification of hydracid, by M. Villiers.—Atmospheric bacteria, by M. Miquel. The number, very small in winter, increases in spring, and is high in summer and autumn; but while spores of mould are abundant in wet, and rare in dry, periods, it is the opposite with aerial bacteria. At Montsouris, in summer and autumn, 1,000 germs of bacteria are sometimes found in 1 cubic metre; in winter the number may go down to 4 or 5, and on some days 200 litres of air are insufficient to infect the most alterable liquors. In ordinary houses air proves fertilising (to neutral bouillon) in a volume of 30 to 50 litres. M. Miquel notes an increase of deaths from contagious and epidemic diseases in Paris, about eight days after recrudescence of aerial bacteria. Water vapour from the ground, rivers, or putrefying masses is always micrographically pure.—On a digestive ferment contained in the sap of the fig, by M. Bouchut.—A work by M. de Koninck, on the fauna of the carboniferous formation of Belgium, was presented.

## VIENNA

Imperial Academy of Sciences, May 7.—B. Bolzano's significance in the history of infinitesimal calculation, by Prof. Stolz.—Investigation of the roast products of coffee, by Herr Bernheimer.—On direct introduction of carbonyl groups into phenols and aromatic acids (third part); behaviour of pyrogallol and gallic acids with carbonate of ammonia, by Prof. Senhofer and Dr. Brunner.—On Guthrie's cryohydrates, by Herr Offen.—On the relation of the coefficients of diffusion of gases to the temperature, by Herr von Obermayer.—On the coincidence of disorders of the skin and of the grey axis of the spinal cord, by Dr. Jarisch.

## CONTENTS

PAGE

THE NEW MUSEUM OF NATURAL HISTORY . . . . .	
ELEMENTARY EDUCATION . . . . .	
ARGENTINE ENTOMOLOGY. By W. L. DISTANT . . . . .	
THE HUMAN VOICE . . . . .	
OUR BOOK SHELF:—	
Lees' "Keith Johnston's Illustrations of Electricity and Magnetism" . . . . .	
LETTERS TO THE EDITOR:—	
A Fourth State of Matter.—GEO. E. NEWTON	
Permanent Record of Foucault's Pendulum Experiment.—CHAR. R. CROSS . . . . .	
The Freshwater Medusa.—Prof. E. RAY LANKESTER, F.R.S. . . . .	
Artificial Diamonds.—J. B. HANNAY . . . . .	
Temperature of the Breath.—Dr. R. E. DUDGON . . . . .	
Reversals by Memory.—Rev. GEORGE HENSLAW . . . . .	
Toughened Glass.—NOBLE TAYLOR . . . . .	
Great Meteor.—Major G. L. TUPMAN . . . . .	
Iron and Hydrogen.—WALTER R. BROWNE . . . . .	
The Stone in the Nest of the Swallow.—WILLIAM E. A. AXON . . . . .	
THE CARIBBEAN SEA . . . . .	
ALBANIA AND THE ALBANIANS. By A. H. KEANE . . . . .	
REPORT OF THE BRITISH MUSEUM . . . . .	
MARCEL DEPREZ'S GALVANOMETER FOR STRONG CURRENTS (1902) . . . . .	
(Illustration)	
Prof. W. H. MILLER. By N. STONEY MACKELLYNE, M.P. . . . .	
PAUL BROCA . . . . .	
THE UNITED STATES WEATHER MAPS, SEPTEMBER, 1878 . . . . .	
NOTES . . . . .	
METEOROLOGICAL NOTES . . . . .	
GEOGRAPHICAL NOTES . . . . .	
ARTIFICIAL DIAMONDS. By J. B. HANNAY, F.R.S.E. . . . .	
UNIVERSITY AND EDUCATIONAL INTELLIGENCE . . . . .	
SCIENTIFIC SERIALS . . . . .	
SOCIETIES AND ACADEMIES . . . . .	



THURSDAY, JULY 22, 1880

## VICTORIA UNIVERSITY

IT was only the singular moderation and good sense with which the promoters of the New Manchester University movement conducted their case that could have secured that no Parliamentary opposition should be made to the late Government taking a step so momentous, and affecting so many rival interests, as the foundation of a new English university. They were compelled, indeed, like many other strategists, to change front once or twice, and to accept a charter different in two vital respects from that which they had asked. They wanted a university in England on the model of the Scotch and German universities—a university of a single college in a great centre of population. They were compelled, however, to make provision for affiliating Leeds and other colleges, when they become adequately equipped, with full faculties of arts and science, and when it is completed the new University will have to carry out an experiment completely novel. It will occupy a midway place between the Scotch single-college universities, the English universities with their families of colleges bound together by their common locality, and the Central Examining Board or all qualified applicants, which is known as the University of London. The separate colleges will in fact be Universities of the Scotch type, complete in themselves before they are affiliated in respect of two important faculties. They will differ vitally from the single colleges of Oxford and Cambridge, each with three or four tutors of its own, but each requiring to lean on the private tutors and the resident university professors and lecturers for the necessary supplement of their teaching. It will be most interesting to see how the University authorities will conciliate the independence and rigidity of the teaching of the individual colleges with the examination system which must govern and regulate them all. The new University will more nearly resemble the late Queen's University in Ireland than anything else of which we have had experience. It will differ from the Queen's University only in the greater importance of the separate colleges. Meanwhile all these arrangements are *à posse*. The University will be started on the familiar lines of the Scotch and German universities, with a single college, with which for the time being it is practically identified, and whose teaching it will be its sole business to influence.

The other important modification is in the temporary absence of the medical faculty. An important medical school is attached to Owens College. The last Government were occupied with a Medical Bill, the main object of which was to diminish the number of licence-granting medical centres, and to substitute a single authority for the nineteen medical bodies which confer the right to practise on the bodies of Her Majesty's subjects. It was strongly represented to them that it would be an anomaly that they should add a twentieth licensing body to the nineteen at the very moment when they were attempting to fuse the nineteen into one. The charter they have issued to the Victoria University grants it the right to confer all degrees and titles of honour that are now conferred by other universities in the United Kingdom.

dom to grant, except in the single faculty of medicine. Although the medical professors of Owens College become professors in the University, they will remain in an exceptional position, at all events until the new Government have made up their minds what course to adopt with the Medical Bill. Should the agitation for a medical uniformity die out, and the Government resolve upon no disturbance of the existing arrangements, it will be impossible for them not to complete the charter of the new University by conferring on it the right to grant medical degrees. Should they revive the proposals of their predecessors and succeed in passing them into law, the new University will stand in the same position as that which the older universities will then be reduced to occupy.

The public will be most interested to see on what lines the Victoria University will be developed. Will it strike out a new line for itself? Every university in this country aims at being a *studium generale*, but every university has in practice shown a tendency to the exceptional development of special studies. Oxford is in the main a great classical, and Cambridge a great mathematical, school, and London has been exceptionally distinguished for the high attainments and reputation of its medical graduates. In the Victoria University, so far as it is possible to forecast its future, a similar position seems likely to be asserted by the scientific faculty. It is in that respect that Owens College has been specially strong. In all the older universities the scientific faculties have had to assert for themselves a higher position than they originally occupied, and they have generally done so during the last century of their history. They will start in the Victoria University from a position at least equal to that occupied by the elder "Arts" studies. It would be a mistake if they were to attempt to claim an exclusive predominance, and the first step which the University has taken indicates that there is no such danger. They have appointed as their Chairman of the Board of Studies their Professor of History and English Literature. Every one who has followed the movement in which the University originated knows how deeply it has been indebted, from its commencement to its close, to Prof. Ward, and it is safe to say that no sounder appointment could have been made, and none more likely to secure the impartial appreciation of all the competing claims of the old and the new learning. The authorities of the Victoria University will begin their new career on the broad and satisfactory lines indicated by the words of their founder. Mr. Owens' will pointed to the creation in Manchester of a seat of learning in which the subjects taught in the English universities should be taught in the best way, and the promoters of the movement have never advocated any scheme for making themselves a scientific college, or what is called a technical university. But it will be as difficult as it would be imprudent to ignore the fact that Manchester has special opportunities for becoming a great scientific school, and the eminent teachers who represent its scientific faculty may be confidently trusted to maintain the position which they have secured for their subjects. We may reasonably hope to see the new University set itself to the task of proving that science is as educationally effective an instrument as literature and philosophy.

history, and language will hold their own adequate place in its scheme of instruction, but the newer sciences of animate and inanimate nature will certainly start from a fairer platform than usual, in the North of England. The Victoria University will not be hampered, like its elder sisters, by the traditions of the past. There is a great career before it, and the people of England will watch its development with the deepest interest. They may be reasonably confident of one thing, that the new educational "brand," to adopt Prof. Huxley's felicitous expression, will be of as select a character as any of the "brands" with which they are familiar.

ON THE RELATION BETWEEN THE MOLECULAR WEIGHTS OF SUBSTANCES AND THEIR SPECIFIC GRAVITIES WHEN IN THE LIQUID STATE

UNDER this title I have communicated to the Chemical Society the results of a prolonged investigation on the connection existing between the weights of unit volumes of liquid substances and their relative molecular weights (see *Journal of the Chemical Society* for March, April, May, and June, 1880), and in obedience to a request from the Editor of NATURE I will briefly indicate the scope of the inquiry, and point out the main conclusions to which I have been led. The inquiry, I may say in the outset, has resolved itself into a critical and experimental examination of what are known as Kopp's laws of specific volume. That some definite connection between molecular weight and specific gravity would be traced had been surmised more than forty years since, but all our exact knowledge on the subject is contained in the series of classical memoirs which we owe to Hermann Kopp. Kopp first clearly recognised the necessity of comparing the liquids when under strictly analogous conditions. By dividing the specific gravity of a liquid taken at the temperature at which its vapour-tension is equal to the standard atmospheric pressure—that is, at its ordinary boiling-point—into its molecular weight, we obtain its specific volume. If the specific gravity be referred to the point of maximum density of water, this value represents the number of cubic centimetres occupied by the relative molecular weight of the liquid expressed in grams at its boiling-point under the standard pressure. The numbers thus obtained were first shown by Kopp to exhibit certain definite relations which may be briefly stated as follows:—

I. *In many instances differences in specific volume are proportional to differences in corresponding chemical formulae.*—Thus a difference of  $\text{CH}_2$  in a homologous series corresponds to a difference of about 22 in the specific volume, or  $(\text{CH}_2)_x = 22x$ . On comparing the specific volumes of similarly constituted haloid compounds, it is seen that the substitution of  $n$  atoms of bromine for an equal number of chlorine atoms increases the specific volume by  $5n$ .

II. *Isomeric and metameric liquids have, as a rule, the same specific volume.*—Exceptions are exhibited by certain oxygen and sulphur compounds.

III. *The substitution of an atom of carbon for two of hydrogen makes no alteration in the specific volume of certain groups of organic liquids.*

On the basis of these conclusions Kopp was able to calculate certain numerical values for the specific volumes of the elements in combination. These values are as a rule constant for the particular element: thus, according to Kopp, carbon has invariably the value of 11, hydrogen that of 5.5. Exceptions are observed in the case of the chemical analogues oxygen and sulphur. Each of these bodies has two values depending, it would seem, on its mode of combination, or on its relation to the remaining atoms in the molecule. For example, acetone and allyl alcohol have each the empirical formula  $\text{C}_3\text{H}_6\text{O}$ , but the specific volume of acetone is 78.2, whilst that of allyl alcohol is 73.8. In the case of acetone the combining power of the oxygen atom is wholly satisfied by carbon; that is, we have reason to know that the oxygen atom is more intimately associated with one of the carbon atoms than it is with any one of those of the other elements; whereas in allyl alcohol a moiety of the combining value would seem to be satisfied by carbon and the remainder by hydrogen. It appears, then, that when oxygen is united to an element by both its affinities its specific volume is 12.2; when it is attached by only one combining unit its specific volume is 7.8. The corresponding values for sulphur are 28.6 and 22.6.

I have already pointed out that these differences in the values for the specific volumes of oxygen and sulphur may be employed to throw light upon the constitution of such bodies as the phosphoryl and thiophosphoryl compounds, and that we may in this way obtain evidence as to the particular affinity-value that an element such as phosphorus, which is variously regarded as a triad and a pentad, exerts, and in the present paper I give additional instances to show that a knowledge of the specific volume of a body is often calculated to furnish valuable information concerning its constitution.

The most accurate method of ascertaining the specific volume of a liquid is (1) to determine its specific gravity at some convenient temperature; (2) to ascertain its boiling-point with the utmost exactitude; and (3) to determine with great care its rate of expansion, say between  $0^\circ$  and this boiling-point.

The space at my disposal forbids me attempting to show how these various physical data were determined for the purpose of the present inquiry. Full details of the methods employed are given in the original paper, and the errors incidental to the various processes are fully discussed. The observations necessitated among other things the frequent determination of the fixed points of the thermometers employed, and the accompanying figure shows how these were found to rise during the progress of the investigation. The abscissæ represent the times in months at which the several observations were taken, and the ordinates the extent of displacement in hundredths of a degree. A represents a thermometer ranging from  $-10^\circ$  to  $50^\circ$  C., B from  $50^\circ$  to  $105^\circ$  C., and C from  $98^\circ$  to  $144^\circ$  C. It will be seen that the extent of the displacement is evidently dependent on, or at any rate is greatly influenced by, the amount of molecular disturbance to which the glass envelope is subjected.

The accuracy of the results is of course in great measure dependent upon the purity of the liquids employed, and this fact to some extent limited the number of compounds which could be investigated. Whenever the mode

preparation was not a sufficient guarantee of the purity it was established either by analysis or by the determination of its vapour density—a most rigid test, provided that this could be ascertained with sufficient accuracy. I have ventured to modify the original form of the Gay-Lussac-Hofmann apparatus, and I think I may claim that this modification admits of all the precision which the process is capable of yielding. It obviates some of the disadvantages of the original method, such as the liability to crack the tube, and the use of a large quantity of mercury and of liquid to vaporise the body under investigation, and it also permits of a more certain application of the necessary corrections.

Among the many problems suggested by a review of our present knowledge of the subject, the following seemed to me to be specially worthy of solution.

I. Is it definitely established that an element in combination has as a rule an invariable specific volume? May not the volume be modified by the number of the atoms of that particular element in the molecule? Is it

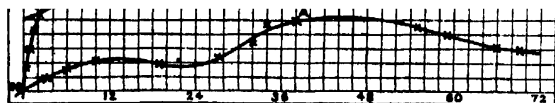

Curves showing rise of fixed points in thermometers.

altogether independent of the general complexity of the molecule, or may not the specific volume of the molecule be a function of its weight?

II. Do the various members of a family of elements possess identical specific volumes, or may not the volume be a function of the atomic weight?

III. Would a re-examination of the cases of so-called variable atomic value serve to show that the specific volume of an element is a function of that value, as Buff supposes?

IV. The hypotheses of Mendelejeff and Meyer indicate the need of additional and more exact determinations of the values for the specific volumes of the elementary bodies?

This scheme of work required the determination of the specific gravities, boiling-points, and thermal expansions of about fifty liquids, and the results of the observations were used as material for the calculation of the specific volumes of the seventeen elementary bodies. The rates of expansion were represented by formulæ of the form—

labour of reducing the observations, and more especially of calculating the empirical formulæ for so many a number of substances, has been materially lessened by the use of the arithmometer of Thomas (de

Colmar). The investigation has therefore incidentally added very considerably to the data upon which the determination of the general laws affecting the thermal expansion of liquid bodies must depend.

After a discussion of the errors of the observations and a comparison of my results with those obtained by previous observers, whenever these were applicable, I have summarised the main conclusions to which I have been led as follows:—

1. It seems certain that many isomeric liquids, even of the same chemical type (using that phrase in the sense in which it is employed by Kopp) have not identical specific gravities at their respective boiling-points, and hence have not identical specific volumes. Such exceptions are more commonly met with in compounds containing carbon and hydrogen; this fact appears to indicate that the specific volume of one or both of these elements is not absolutely invariable. Benzene derivatives especially show a greater departure from the general law than can be fairly attributed to experimental error. Their variations are of the same order as has been shown to occur in the refraction values for these compounds.

2. We must also suppose that of the additional elements, oxygen, sulphur, and nitrogen have likewise variable specific volumes in conformity with Kopp's conclusions.

3. There is at present no experimental evidence for assuming that any other element has a variable specific volume.

4. Hence in the case of these elements the volume is not modified by the number of the atoms of the particular element in the molecule, and it is therefore altogether independent of the general complexity of the molecule.

5. The different members of a family of elements do not possess identical specific volumes; the volumes of the elements are periodic functions of their atomic weights.

6. The inquiry affords no evidence in support of the hypothesis that the specific volume of an element in combination is modified by any possible variation in the affinity value which it may possess. T. E. THORPE

#### GORDON'S "ELECTRICITY AND MAGNETISM"

*A Physical Treatise on Electricity and Magnetism.* By J. E. H. Gordon. (London: Sampson Low and Co., 1880.)

THE author, in the first paragraph of his preface, draws a distinction between the physical and mathematical points of view in treating the Science of Electricity. Unfortunately, the distinction is at present a real one. Many mathematicians, fascinated by the beauty of the instruments they handle, are disposed to treat physical problems as though the principal function of the universe were to suggest problems to the pure mathematician, instead of the principal function of the pure mathematician being to provide suitable tools for solving physical problems. On the other hand, there are skilful experimentalists who fail to appreciate those powerful methods of deductive quantitative reasoning which they are themselves unable to handle. Mr. Gordon does not profess to be a mathematician, and adopts the experimental point of view.

The book makes no claim to be a complete treatise, but rather to deal with those branches of the science with which the author is best acquainted, one might almost say, those parts at which he has himself worked, either originally or by way of verifying the work of others. As might be expected from such a scheme, the descriptions of apparatus and phenomena are admirable, but, unfortunately, the theoretical explanations, intended to give the book more or less the character of a systematic treatise, are neither clear nor accurate. So early as page 2 we read: "It is found that if equal quantities of the electricity of glass and the electricity of sealing-wax be added together they neutralise each other." But this is not preceded by any explanation of what is meant by equal quantities of the electricities of glass and sealing-wax. If the sentence had been cast as a definition, it would have been comprehensible. On page 20 there is an extraordinary illustration of the medium supposed to transmit electrostatic forces:—

"The transmission of strain may be very beautifully seen at any railway-station when shunting is going on, if a train of carriages is being pushed by an engine which happens, instead of giving a steady pressure, to strike a slight blow on the carriage nearest to it. The furthest carriage does not move at once, but the buffer springs are compressed—that is, the first carriage is for an instant strained by having its total length shortened by some inches. It instantly recovers from this strain by the expansion of the springs; but as it cannot expand towards the engine, it expands away from it, and transmits the strain to the next carriage by compressing its buffer-springs, and the process is repeated all the way from the engine to the carriage furthest from it."

This buffer experiment is an illustration of wave-motion, an idea we do not need in any theory of electrostatics. On page 23 there is a popular explanation from the pen of Prof. Ayrton of the easy discharge of electricity from points; this remarkable explanation does not in any way depend on the greater electric surface density at and near a point, and it suggests that the force near a conductor is not normal to its surface. It is unnecessary to pursue this criticism further; we have said enough to show that Mr. Gordon's strength does not lie in the systematic exposition of electrical theory.

The book is divided into four parts—Electrostatics, Magnetism, Electrokinetics, and Electro-optics. In the third part is included all the phenomena of current electricity. This is an unsatisfactory classification. Electrokinetics should be confined to those phenomena of current electricity which involve the kinetic energy of current, such as electromagnetism and electromagnetic induction. The author would have been wiser to have followed the arrangement of Maxwell, and have classed the steady flow of electricity in conductors at rest rather with electrostatics than electrokinetics. Adams's experiments on equipotential lines and surfaces in conductors are interpolated between diamagnetism and the induction coil; they are, of course, naturally a part of the theory of electrical resistance, and have no near connection with the chapter preceding or following.

Great care has been bestowed on the illustration of the work. We know of no book on electricity so beautifully illustrated. Nor are the pictures merely pictures. They show well the details of apparatus; often, too, some

leading dimensions are given when perspective does not admit of a scale. We would recommend this practice to all writers on science. It is a great help to the imagination to know how large a thing is, and better that this information should be upon the picture than in the text only.

In the construction of this book the freest use has been made of the scissors, whole pages being quotations. This is both wise and modest, for when the original works of the man who discovered and stated a fact are suitable for a treatise, there can be no use in paraphrasing them. Some of the chapters are excellent analyses of the several investigations which have been made into the subjects of which they treat. This is notably the case with the chapter on "Specific Inductive Capacity." When Mr. Gordon has occasion to prepare a new edition he will do well to expand where he is strongest, to omit as far as possible systematic exposition, but to make each chapter a history to which the reader may refer with confidence that he will there find a clear account of every original experiment, English or foreign, that has been tried in that department. The value of such a work would be inestimable.

#### STRATIGRAPHICAL GEOLOGY

*Lethæa geognostica, oder Beschreibung und Abbildung der für die Gebirgs-Formationen bezeichnendsten Versteinerungen.* Herausgegeben von einer Vereinigung von Paläontologen. I. Theil: *Lethæa palæozoica*, von Ferd. Roemer. Textband: Erste Lieferung. Pp. 324. (Stuttgart, 1880.)

THE study of fossils may be approached from two distinct points of view: we may regard them as furnishing us with additional illustrations of the diversities of form and structure in the animal and vegetable kingdoms, or we may study them as making their appearance in a certain definite order, and thus as characterising particular geological formations. The former is the point of view of the biologist, the latter that of the stratigraphical geologist. Palæontology, or the study of fossil forms, must necessarily be pursued as a branch of biology, for only by the study of their nearest recent analogues can we hope to interpret the fragmentary and often obscure relics of former inhabitants of the globe; but, on the other hand, the progress of systematic geology has been bound up with the study of fossils ever since it has been clearly recognised that strata can be identified by the organic remains which they contain.

German scientific literature is now being enriched by the publication of two very valuable works in which fossils are treated of, in the one case from the stand-point of the biologist, in the other from that of the stratigraphical geologist. The admirable treatise on palæontology by Zittel and Schimper gives an excellent account of the chief types of fossil plants in their relations to living forms, and the work of which we have placed the title at the head of the present article, promises to supply an equally important contribution to stratigraphical geology.

The title of "*Lethæa Geognostica*" was first employed by Bronn, who between the years 1835 and 1837 published a work under this name, in which he described all the

fossil genera then known in the several geological formations. This book, which was accompanied by an excellent atlas of plates, passed through three editions during the author's life-time, but in the preparation of the last of these he was aided by Dr. Ferdinand Roemer.

The number of fossil forms now known to geologists is so vast that it would be impossible to find any palæontologist competent to deal equally well with the faunas and floras of all the geological periods; and hence it has been decided to commit the palæozoic, the mesozoic, and the tertiary divisions of the work to different hands. Dr. Ferd. Roemer has been selected to describe the life-forms of the palæozoic rocks, and in the work before us we have the first instalment of the result of his labours.

The work commences with a sketch of the succession and correlation of the palæozoic strata in all the different areas in which they have been studied. The author divides these rocks into the four groups of Silurian, Devonian, Carboniferous, and Permian, using the term Silurian, after the manner of Murchison, to embrace all the lower palæozoic strata. This plan is, of course, open to the objection that his first division is at least equal in value to the other three put together. The account of the palæozoic strata as developed in different areas, which extends to ninety-two pages, is generally very carefully drawn up. We notice on pages 11 and 29 an unfortunate error in the grouping together of the Lower Llandeilo and the Tremadoc slates, while in his account of the succession of strata in Sweden the author has failed to avail himself of the most recently-published results arrived at by the palæontologists of that country.

The next twenty pages of the work are devoted to the palæontological literature of the palæozoic rocks, 146 pages to the palæozoic plants, and seventy-seven pages to the Protozoa. The author describes each genus, and gives also an account of some of the more important species. In noticing the earliest palæozoic plants, Roemer follows Schimper in regarding the puzzling forms from Bray Head, called *Oldhamia* by Edward Forbes, as belonging to the Algae. With regard to the so-called *Eosoon canadense* of Dawson, Dr. Ferd. Roemer accepts the verdict of Möbius against its organic origin, and rejects it from the list of palæozoic fossils.

The atlas of the "Lethæa Palæozoica" was published four years ago, the plates, sixty-two in number, being well executed and of the same size as the text, thus getting rid of the inconvenient arrangement in the former work, where the text was in 8vo, and the plates in folio. It would almost appear as if the atlas were drawn up previous to, and quite independently of, the present work, so that the connection between the illustrations and the text is not so close as might be wished. We cannot help remarking, too, that unless much greater expedition is used in publishing the remainder of the work, the earlier portions will become obsolete before the later portions make their appearance.

Although the atlas appeared in 1876, the text has now only just reached the commencement of the Coelenterata. Possibly some unavoidable cause of delay has arisen, which, we may hope, is now removed. We look forward with interest to the completion of this most valuable work.

### OUR BOOK SHELF

*A Treatise on Elementary Dynamics, for the Use of Colleges and Schools.* By William Garnett, M.A. Second Edition. (Cambridge: Deighton and Co., 1879.)

MR. GARNETT'S second edition does not differ in appearance from its predecessor. There is the same number of chapters, the headings of which for the most part are also the same, but new matter and more detailed explanation have resulted in the addition of some twenty-five pages. It may be noted as a feature of Mr. Garnett's work that there is a chapter on "The Dynamical Theory of Gases," and a good one on "The Dimensions of Units." We have used the first edition with great advantage, as the author fully discusses and illustrates the *crucis* of this subject, which is often so difficult to beginners, and we commend this improved edition to such readers and to all others.

*Elementary Applied Mechanics.* By Thomas Alexander, C.E. (London: Macmillan, 1880.)

THE object of Mr. Alexander's work is to serve as a companion volume to the late Prof. Rankine's "Applied Mechanics and Civil Engineering." This *first part* treats of internal stress and strain, the divisions being elasticity, resilience; pure strain, simple and compound; the ellipse of stress; and the application of earthwork. All these points appear to us to be well illustrated by the numerous worked-out exercises, with carefully drawn figures, and by the exercises left for the student to try his skill upon. This small book, drawn up, we presume, with reference to Prof. Alexander's Japanese students at the Imperial Engineering College at Tokei, is likely to be of service, the more so as it appears, to the extent we have tried it, to be correctly printed.

### LETTERS TO THE EDITOR

[The Editor does not hold himself responsible for opinions expressed by his correspondents. Neither can he undertake to return, or to correspond with the writers of, rejected manuscripts. No notice is taken of anonymous communications.]

[The Editor urgently requests correspondents to keep their letters as short as possible. The pressure on his space is so great that it is impossible otherwise to ensure the appearance even of communications containing interesting and novel facts.]

#### The Recent Gas Explosion

"THE explosion took place by the conversion of potential energy into motion."

It may be fairly asked whether physicists are really satisfied with this account of the tremendous development of energy recently witnessed in the neighbourhood, or whether this phrase "potential energy" is not a useless bugbear which is closing the door to discovery. Why not believe rather that the motion exhibited was not really created (as motion) at all, but already existed in a concealed form? For we have plenty of proof that motion can be stored up to any intensity and yet be quite imperceptible to the senses, so long as all is in equilibrium. Why assume a supernatural (?) cause, when we have a natural one of transferred motion? Why rush into the inconceivable assumption of the existence of an energy *without motion*, when the conceivable remains for appreciation? An important and highly interesting problem in the discovery of the *modus operandi* of the transference of the motion from matter in space would thus be ever present to the mind (which is the sole condition for hoping to solve it) in place of an unrealisable and—may we not justly add?—therefore shallow and pretentious mysticism which obstructs the pathway of progress.

July 8

S. TOLVER PRATT

[It seems to us that Mr. Preston makes rather too much of a chance newspaper expression, probably employed (for the sake of appearing scientific) by a writer who had no notion of the tremendous metaphysical problem which underlies it. It is very probable that all energy is kinetic, but this has not yet been proved.—Ed.]

THE dangers of an explosion of gas, such as that which occurred on the evening of the 5th inst. in Bedford Street, are not, it would seem, limited to the immediate vicinity of the accident.

At about 7 p.m. on that day I was reading in a room, which from its position at the back of the house being rather dark, required a light, when I was startled by a sudden rush of the flame from the single gas-burner upwards for about two feet—it immediately subsided, again blazed up, and repeating this a third time sank, and went out altogether.

I thought something had gone wrong in the pipe, and that the passage of the gas was interrupted, but on applying a match it ignited and burned naturally, though with a feebler flame than before.

It was fortunate that I was in the room to turn off the escaping gas, or some serious mischief might have occurred when next any one had entered the room to find gas and air mingled into an explosive compound. I found that two other gas lights in passages had been extinguished at the same time, attention having been called to them by the smell of escaping gas.

As the distance of my residence—Granville Place, Portman Square—is more than a mile from the site of the explosion, it is interesting to note the distance to which the impulse extended.

As no further disturbance occurred, and as the phenomena noted happened synchronously or nearly so with the explosion, and as the gas-pipes here are, I believe, branches of the same source of supply, I assume that what I observed and have described was in some way caused by the explosion.

Fortunately it was at an hour when the gas was not generally burning, or other accidents might have resulted. It would be interesting to know if others observed similar effects of the explosion.

July 10

J. FAYRER

#### The Tay Bridge

THERE are two interesting scientific questions, apart from engineering proper, which are suggested by the late inquiry, although no reference seems to have been made to them in the reports.

The first is the origin of the extraordinary flash seen at the moment of the downfall of the bridge by many spectators several miles away. It is scarcely doubtful that an impact was the only possible cause.

The second is the important question of the amount of wind-pressure which would suffice to force a train bodily off from the top of the bridge at a place where it was *not within* the girder. No strength of columns could then prevent an accident.

The flash seems to prove that the train had been blown off the rails, and had come into violent contact with the sides of the high girders. Then, and not sooner, the piers were subjected to a strain they were unable to bear.

G. H.

#### "Geology of the Henry Mountains"

I LATELY received, through the Home Office at Washington, a "Report on the Geology of the Henry Mountains," by G. K. Gilbert, being a portion of the "Geography and Geology of the Rocky Mountains." With the merits or demerits of this paper I am not concerned. I am not prepared, however, to pass in silence and without protest the following paragraphs, which I find at p. 76:—"Bischof attempted, by melting eruptive rocks in clay crucibles, to obtain their ratios of expansion and contraction, but his method involved so many sources of error that his results have been generally distrusted. He concluded that the contraction, in passing from the molten to the crystalline state, is greater in acidic than in basic rocks. Delesse, by an extended series of experiments in which crystalline rocks were melted and afterwards cooled to glasses, showed that acidic rocks increase in volume from 9 to 11 per cent. in passing from the crystalline state to the vitreous, while basic increase only 6 to 9 per cent. Mallet concluded, from some experiments of his own, that the contraction of rocks in cooling from the molten condition is never more than 6 per cent., and that it is greater with basic than with acidic rocks; but considering that the substances which he treated were artificial and not natural products, that his methods were not uniform, and that he ignored the distinction between the vitreous and the crystalline, of which Delesse had demonstrated the importance, no weight can be given to his results."

It would be difficult to compress into the same number of lines a greater amount of erroneous statement than is to be found in the above quotation. Bischof's results were never distrusted by geologists, by whom they were repeatedly quoted, until in my paper on the "Nature and Origin of Volcanic Energy," read to the Royal Society, June, 1872, and printed in *Phil. Trans.*, I pointed out the errors incidental to Bischof's method of experiment, and at the same time directed attention to the strange arithmetical blunder of Bischof himself, by which his deductions from his own experiments are rendered still wider from the truth.

The experiments of Delesse, which I presume are referred to, were made on so small a scale that no deduction as to the total contraction between the liquid and solid state of any rock can be inferred from them. Coming now to Mr. Gilbert's summary condemnation of my own experiments on the total contraction of basic slags from the iron-smelting furnaces of Barrow (Cumberland), an account of which is given in my paper already referred to, and printed in the *Phil. Trans.* for 1873, some of the chief results of which are to be found in p. 201, I have to remark that no other experiments on the subject, conducted on the same great scale, and with equal precautions to insure exactness, have ever been made and published. No experiments have ever been made upon the contraction of lava as flowing from a volcano and its solidification on cooling, but I have given comparative analyses of natural lavas, and shown their almost identical composition with that of the slags employed by me. It is incorrect to state that I have ignored the difference between the vitreous and crystalline condition; all the melted matter experimented on by me having, from the large bulk of melted matter, cooled in the crystalline state. Whether then any justification can be adduced for Mr. Gilbert's sweeping and unsupported statement that "no weight can be given" to the results of my experiments I leave to the judgment of men of science who have impartially read my results.

ROBERT MALLETT

London, July 7

#### Intellect in Brutes

THE Central Prison at Agra is the roosting-place of great numbers of the common blue pigeon; they fly out to the neighbouring country for food every morning, and return in the evening, when they drink at a tank just outside the prison walls. In this tank are a large number of freshwater turtles, which lie in wait for the pigeons, just under the surface of the water and at the edge of it. Any bird alighting to drink near one of these turtles has a good chance of having its head bitten off and eaten; and the headless bodies of pigeons have been picked up near the water, showing the fate which has sometimes befallen the birds. The pigeons, however, are aware of the danger, and have hit on the following plan to escape it. A pigeon comes in from its long flight, and, as it nears the tank, instead of flying down at once to the water's edge, will cross the tank at about twenty feet above its surface, and then fly back to the side from which it came, apparently selecting for alighting a safe spot which it had remarked as it flew over the bank; but even when such a spot has been selected the bird will not alight at the edge of the water, but on the bank about a yard from the water, and will then run down quickly to the water, take two or three hurried gulps of it, and then fly off to repeat the same process at another part of the tank till its thirst is satisfied. I had often watched the birds doing this, and could not account for their strange mode of drinking till told by my friend, the superintendent of the prison, of the turtles which lay in ambush for the pigeons.

The same friend had a couple of Hill Mynahs (*Gracula religiosa*) the most wonderful bird for mimicry which I have come across, not excepting the grey parrot of the West African coast. One of these birds, when hung out in the verandah during the afternoons, used to amuse itself by calling the fowls together, imitating the call of their keeper so well that they used to flock together under the cage, when the bird would burst out into a very good imitation of a human laugh, as if it quite enjoyed the fun of taking in the fowls. Have birds the sense of amusement? This one certainly seemed to derive gratification from the way in which it had cheated the fowls.

Roorkee, June 21

W. W. NICHOLLS

#### The Volcanic Dust from Dominica

SOME months ago, through the kindness of Messrs. Alexander Agassiz and S. H. Garrison, some of the volcanic ashes which fell in Dominica on January 4 were placed at my disposal. On

account of the notices that have appeared in NATURE (vol. xxi. pp. 330, 372, and vol. xxii. p. 77) and in *Comptes rendus* (xc. 622-26), this note would be needless, were it not that some may regard these ashes as of recent origin.

Microscopically the material (already described by Prof. Delesse) is seen to be decomposed to a considerable extent. The materials evidently filled an old crater, and have been subjected to secondary action, so that of the original constituents only the feldspar and augite are left. The other constituents are the results of the alteration of this andesitic (probably) *débris*. No trace of recent volcanic material could be found in that examined by me. In no sense can these ashes be called a recent product; they have simply been transferred from one place to another. The transfer is recent, but the ashes have for ages been at or near the surface of the earth.

M. E. WADSWORTH  
Museum of Comparative Zoology, Cambridge,  
Mass., U.S.A., June 30

#### Large Meteor

ON Friday evening last, July 9, at 9h. 45m., I saw a very fine meteor about equal in brightness to Venus at her maximum, moving very slowly from nearly west to south-west. I did not see its origin. It passed about 4° above *Spica*, and disappeared soon afterwards, as nearly as I could estimate, in altitude 16° and azimuth 50° west of S. Its apparent course was only slightly inclined to the horizon, approaching it at an angle of about 1 in 10.

Its apparent angular velocity was about 8° in a second, its light yellowish till the moment of extinction, when it became blue and fainter, and disappeared without any sign of explosion. Its course was somewhat wavy, and the trail it left behind it very evanescent. My latitude and longitude was 51° 25' and 0° 14' W.

F. C. PENROSE  
Coleby Field, Wimbledon, July 14

#### Ball Lightning

ON Saturday night, the 17th inst., an instance of this form of lightning came under my observation.

The day had been hot, the thermometer registering a temperature of about 71° F. in the shade during the middle of the day, which was bright and clear. In the evening, however, a curious haze or mist spread rapidly over the landscape, while the temperature had fallen to about 68° F. This haze was very much denser and more analogous to the smoke-fog of a town than I have ever observed in the country at this time of year, yet the air did not seem particularly damp or chill.

About 9 p.m. frequent flashes of sheet-lightning occurred, with rumblings of distant thunder at intervals, both of which continued more or less up to midnight, about which time, the mist having somewhat cleared off, I saw when returning home, apparently about a quarter of a mile ahead, a ball or globe of fire of considerable size descend slowly from the clouds, and when near to or touching the earth suddenly disappear, its disappearance being accompanied by two slight but quick concussions, which may have been an explosion and its echo. The fire-ball could not have been visible more than five or six seconds. I cannot ascertain that any damage was done by it.

As this somewhat rare and curious phenomenon seems to be manifesting itself at this period, accompanying the thunderstorms we are having (see NATURE, vol. xxii. p. 193), may I be permitted to suggest that those interested in electrical science should be on the alert to observe any repetition of the occurrence with its concomitant circumstances?  
W. F. SMITH  
Sutton Valence, Kent

E. M. F. should read Prof. Ayrton's Sheffield lecture on "Electricity as a Motive Power" (see NATURE, vol. xx. p. 568); any decent text-book—Noad's, for example—will tell of the older attempts of Jacobi to propel boats by electricity.

#### THE RECENT EXPLOSIONS

ALTHOUGH it is difficult to say anything new on the subject, or give instructions more effective than such as have been given over and over again, still the

recent remarkable and destructive explosions in London, Wolverhampton, and Monmouthshire seem to call for some remarks at our hands.

Two serious explosions of gas following close on each other, in the streets of large towns, announce to every one that the difficulties of supplying gas to large numbers of consumers have not been completely overcome.

The special feature in the London accident was the occurrence of a series of explosions, at first at nearly regular, and then at increasing intervals, along the gas main. The first explosion blew out the "cap" of the main with great violence; the rush of heated air, doubtless mingled with more or less gas, in the other direction seemed to have carried the flame—probably by a rapidly occurring series of small explosions—to a point at which a mass of explosive gas was again reached and fired. The mass of gaseous mixture fired in the second explosion appears to have been about equal to that in the first, but towards the close of the series either the gas became much more diluted with air, or the air became much more charged with gas. It seems just possible that vibrations propagated by the first explosion passed rapidly through a gaseous medium, consisting of much air and little gas, until they came in contact with a mass of gas and air, which they threw into rapid vibration, and so caused to explode. But from the experiments of Abel and others one would scarcely expect this to occur under the conditions which—judging from the evidence given at the inquest—appear to have existed.

A second point, illustrated more markedly by the Wolverhampton explosion, is the apparent readiness with which a soil may be charged with coal-gas and retain this gas for long periods of time. The passage of such gas into drain-pipes, and perhaps even into unfilled gas-mains, seems to be of ready occurrence.

Experiments might well be instituted by the gas companies to determine the power of soils for absorbing and retaining coal gas, and secondly, the conditions of diffusion of mixtures of gas and air through the walls of pipes of different materials. If it can be shown with certainty that the valve at the junction of the main in which the explosion occurred with the Howland Street main was absolutely impervious to gas, then the explosion may almost be regarded as proving the permeability of the material of gas mains to mixtures of air and coal-gas.

The practical lesson of the explosions is that some means of certainly determining whether a gas main does or does not contain gas must be found at once, and that this means must *not* be the application of a light to an opening in the main. The foreman who applied the fatal match said that the pressure gauge showed the absence of gas in the main; but as the main contained a quantity of gaseous mixture at rest, and not flowing through the pipe, the gauge could not be expected to indicate the presence of this mixture.

It is almost amusing to read of the simple astonishment of the two foremen when the fact was announced to them that mixtures of coal-gas and air are explosive: twenty or twenty-five years' experience in gas-works had failed to teach them this fact. Yet the lives of the inhabitants in the neighbourhood of Tottenham Court Road were practically in these men's hands for the last three or four months.

With regard to the Risca disaster, of a different and unhappily more fatal kind than the former, clouds of smoke are said to have accompanied the explosion which devastated the pits soon after midnight on Thursday last (15th inst.), and we have it from the lips of a credible eye-witness that fused and coked coal-dust is found adhering to the timbers in those parts of the workings which have been already visited, though not so conspicuous as in some cases. In these respects therefore the recent explosion is only a repetition of similar events which have

taken place before, and we need not again go over the ground which we have already traversed several times in these pages, when we have endeavoured to point out their most probable origin and mode of propagation.

We propose, however, in this place to devote a few lines to the discussion of a question which we think has not as yet received the attention it deserves, namely: When is a mine in such a state that it may be termed *well-ventilated*? and our principal reason for doing so is that a statement has been already put forth to the effect that the ventilation of Risca Colliery was as perfect as it well could be, the total volume of air passing through it being considerably over 100,000 cubic feet per minute.

An air-current of given dimensions may be sufficient to thoroughly ventilate the workings of a fiery mine at one time, and it may be quite insufficient at another: for the degree of sufficiency is obviously wholly dependent on the amount of fire-damp given off per unit of time. Each unit of volume of coal contains a certain volume of fire-damp in a state of great compression—it may be in a liquid or solid condition—and this gas begins to be given off when the workings approach to within a certain distance of the space within which it is confined. The greater proportion of the fire-damp is probably given off immediately before the coal is laid bare, and at the instant it is being detached from the face; but some of it still continues in the coal long after it has left the mine.

If the workings of a fiery mine are stopped abruptly and allowed to remain unworked for a considerable time, we find that the amount of fire-damp given off gradually decreases, until in the course of a year or so it is not more than one-tenth of what it was when the mine was in full work. If, on the other hand, the output of a fiery mine is largely increased, we find that the workings soon lapse into a dangerous condition unless the ventilation has been largely in excess of its requirements in the first place. The character of the ventilation is thus dependent upon the output of coal for the time being as well as on the amount of air.

The daily output of Risca Colliery is stated to have been 1,000 tons, and supposing the amount of gas given off to have been 2,880 cubic feet per ton of coal, which is the actual amount we have found by observation and calculation in similar mines, then we know that, if the volume of the ventilating current had amounted to 30,000 cubic feet per minute, the whole of it would have been explosive as it returned from the workings; if it amounted to 50,000 cubic feet per minute it would show a cap half an inch high in the small oil-flame of a lamp, and when charged with coal-dust it would form a *highly explosive* mixture; if it amounted to 100,000 cubic feet per minute it would still show a small cap  $\frac{1}{2}$  to  $\frac{3}{8}$  inch, and it would still produce an explosion when mixed with coal-dust, and ignited.

It is notorious, however, that as a rule the volume of air which reaches and passes round the working faces is much less than that which descends the down-cast and ascends the up-cast shaft; and when we are told that the ventilation of a mine is represented by a certain number of cubic feet of air per minute, we are on the safe side if we estimate the useful volume to be little more than two-thirds of the stated one.

It is further notorious that the practical miner of almost every grade regards a small cap on the flame of the lamp, even if  $\frac{1}{2}$  to  $\frac{3}{8}$  inch high as a very trivial matter, so long as he finds little or no explosive gas in the mine; and he only begins to speak of the return air as being heavy or rather heavy when the size of the cap on the small oil-flame reaches or exceeds a height of  $\frac{1}{2}$  of an inch; but still even in this case he is not much troubled with thoughts of immediate danger.

What then constitutes a well-ventilated mine?

We say in reply that no mine containing dry coal-dust

is well-ventilated when the cap on the small oil-flame of a lamp is over  $\frac{1}{2}$  or  $\frac{3}{8}$  inch in height, that is to say, when the return air contains more than 2 per cent. of gas. Even with that amount, as we know, it will form an explosive mixture with coal-dust, and we should prefer to see a standard insisted upon in which not more than 1 per cent. was allowed.

This aspect of the question is well worthy of the attention of the Royal Commissioners on Accidents in Mines, and we hope they will not allow their present opportunity to pass without endeavouring to arrive at some definite settlement of such an important question.

#### NORTH AMERICAN GEOLOGY—IDAHO AND WYOMING<sup>1</sup>

IN spite of the revolution that was recently effected among the Government geological surveys of the American Union, provision has wisely been made for the completion of the Reports of the different corps which have been abolished. It is pleasant to welcome still another of the stout black volumes issued annually by the Geological and Geographical Survey of the Territories. On the completion of the Survey of Colorado in 1876 Dr. Hayden and his corps of active coadjutors moved northwards across the belt of country included in the Survey of the 40th Parallel under Mr. Clarence King, with the intention of mapping the territories of Idaho and Wyoming to the north and west. A number of reconnaissances had been made by various observers in these regions since the days of Bonneville and Fremont, some of the earlier work of Hayden's Survey having been accomplished there. But no general survey of the whole area had been attempted, and many parts of it had never been penetrated by white men. It was a vast territory, including within its borders the sources of the Green, Snake, and Yellowstone Rivers, and embracing the most varied forms of surface and the greatest diversities of geological structure. To survey this unknown domain and bring its geography, geology, mineralogy, ethnology, zoology, botany, and general economic capacity to the knowledge of the world was the aim with which Dr. Hayden and his staff started in the summer of 1877. During the season the primary triangulation was extended over an area of 28,000 square miles, from West Long. 107° to 112° and between North Lat. 41° 10' and 43° 50', and was connected with the stations made by the Survey of the 40th Parallel, and by the Boundary Survey of Wyoming. Topographical field-work was carried on by three parties, each having an area assigned to it of about 11,000 square miles. The total area thus surveyed amounted to about 29,000 square miles. The geological staff was likewise divided into three divisions, each being intrusted with a separate district, viz., the regions of the Sweetwater, Teton, and Upper Green River.

In the report of Dr. Endlich of the Sweetwater division, one of the most interesting features is his account of the structure of the Wind River Mountains. This important portion of the true Rocky Mountain range is formed of three parallel chains, of which the western, and chief, rises to heights of more than 13,000 feet and forms the watershed of the continent. Even now its huge snow-fields, which, through the clear summer air can be seen gleaming from a distance of more than 100 miles, suggest the presence of glaciers. When Dr. Endlich and his party traversed these mountains in 1877 they found, indeed, no recognisable glacier, but abundant freshly-grooved and polished rocks and moraine mounds, showing the comparatively recent existence of land-ice in these elevated regions. On the west side of the

<sup>1</sup> "Eleventh Annual Report (1877) of the United States Geological and Geographical Survey of the Territories, embracing Idaho and Wyoming." (Washington: F. V. Hayden, 1879.)



mountains the evidences of glacial action are specially striking, one valley in particular bearing witness to the former presence of a glacier sixteen to eighteen miles long, extending for several miles into the low country, where it threw down its heaps of moraine-stuff in mounds a mile and a half broad, and from 800 to 900 feet high. Next summer, however, the covering of snow having partially melted, true glaciers of small extent were found in the Wind River and Teton ranges.

East of the Wind River Mountains there lies a suite of palæozoic formations from the Potsdam sandstone to the top of the Permian group, having a united thickness of 3,350 to 3,750 feet, and covered by 2,500 to 2,920 feet of Triassic, Jurassic, and Cretaceous rocks. Dr. Endlich computes the total depth of stratified formations in the Sweetwater region at more than 16,000 feet. Underneath them in the Wind River range lies a great series of crystalline rocks. According to Dr. Endlich the Potsdam rocks have been converted into quartzites by the same metamorphic action which has changed the rocks immediately below them into granites and schists. His section shows three zones of granite in descending order, the lowest of all being what he terms prozoic, while the youngest, from its stratified or schistoid character, and the coincidence of the inclination of its strata with that of the overlying stratified formations, he classes as of metamorphic origin.

The researches of Prof. St. John were devoted to the exploration of that wonderfully interesting region round the head waters of the Snake River and the Teton Mountains. The traveller who journeys wearily over the vast desert lava-fields of the Snake River plains looks wistfully from time to time at the great snow-rifted peaks which the Teton range far to the east raises into the sky. What would he not give for a glass of the cool water which dashes down so profusely among these far mountains and disappears so utterly before it reaches that thirsty desert? Extending the observations of Hayden, Bradley, Comstock, and others, Mr. St. John has given us an interesting narrative of the structure of the mountain region and of the lower territory on its flanks. The core of the Teton range, culminating in Mount Hayden, consists of massive granites, gneisses, and schists, flanked by quartzites and slates. On these ancient rocks lie from 500 to 1,000 feet of limestones, shales, and sandstones, containing Lower Silurian fossils, and from 400 to 600 feet of a buff-coloured magnesian limestone referable to the Niagara group of the Upper Silurian. The Carboniferous system, consisting mainly of limestones and sandstones, reaches a thickness of from 2,500 to 5,000 feet. Secondary formations, referred to the Triassic, Jurassic, and Cretaceous systems, attain depths of from 2,300 to more than 5,000 feet. The volcanic history of this portion of America is specially noticeable. According to Mr. St. John's observations the usual chronological sequence obtains in the areas traversed by him. The early eruptions have been of a trachytic nature, great variety of aspect and lithological structure being traceable among the various outflows. The surface presented by the trachytic areas is markedly uneven—the result doubtless partly of original irregularities of extrusion and partly of subsequent extensive denudation. The latest eruptions were of basalt, which has flooded the bottoms of the valleys, and now covers an area of many thousand square miles. Mr. St. John speaks of the difference of level between different plateaux of basalt as being due to subsequent elevation. But it is not necessary to suppose that there ever was any common level for the outflows. Some were no doubt poured out at much higher elevations than others even in their vicinity. The same observer calls attention to the remarkable volcanic conglomerates described by Hayden from this and the Yellowstone region, and by Whitney from the Territories lying further west. These deposits, 3,000 feet or more in thickness, consist of

angular and subangular or rounded blocks of trachytes, basalts, and other volcanic rocks imbedded in a dull brown tuff-like matrix. They cover wide tracts of country in the volcanic districts, and point to a phase of volcanic or inter-volcanic action which is not yet well understood.

Dr. A. C. Peale contributes an interesting report on the varied region lying to the north of the 41st Parallel between Green River City, Wy., and Ogden, Utah. He estimates the total mass of stratified formations in that region from the base of the Lower Silurian system to the top of the Quaternary series at upwards of 30,000 feet. He has added some additional fossils to the list of Lower Silurian forms collected from the district in 1872 by the late Prof. F. Bradley. He has likewise made important additions to the Carboniferous fauna of that area, and has shown how dominant a part is taken by the 6,000 feet or more of Carboniferous limestones and quartzites. The Jura-Trias attains a depth of between 5,000 and 6,000 feet, consisting of the usual red sandy and argillaceous strata below, and passing up into laminated limestones and shales. A considerable number of organic remains were obtained from several zones in these beds, but they do not yet appear to be sufficient for drawing a satisfactory line between the Trias and Jurassic series in the Rocky Mountain region. To our knowledge of the Cretaceous and Tertiary geology of the district Dr. Peale was enabled to make some valuable additions.

Besides these geological reports, the labours of the Survey in 1877 included a detailed palæontological research in the field by Dr. C. A. White, who contributes an important report of his work, and the first of what we hope will be a series of papers on invertebrate palæontology. He specially treats of the Cretaceous fossils of the Western States and Territories. The topographical work of the year was well done by Messrs. Nelson and Gannett. As subsidiary but very valuable parts of the work accomplished by the Survey, reference may be made to the researches on fossil insects by Mr. Scudder of Boston, which have been aided by the Survey and will be published among its memoirs; to the great monograph by Dr. Leidy on the Rhizopods, which has already appeared as one of the Survey's quarto volumes; and to the interesting particulars collected by the Survey regarding the archæology of the San Juan and South-Western Colorado.

There will be, we presume, one further Report for 1878—the last year of the existence of the Geological and Geographical Survey of the Territories. Though this mode of annual publication necessarily involves incompleteness, and is apt to overload the reports with unimportant detail, there can be no doubt that the series of volumes issued by this Survey form a permanent record of great value, which for the districts to which they refer will serve as the basis of all subsequent work. It is not without regret that one can regard the cessation of these volumes. On this side of the Atlantic, where they can be calmly considered apart altogether from scientific rivalry and political entanglements, they have been received with general approbation. It is impossible not to be struck by the largeness of the plan conceived by Dr. Hayden for the scope of his survey. Not geology merely, but every branch of inquiry touching the natural history, archæology, geography, and meteorology of the Territories, was embraced within his plan, and has been illustrated as far as the means at his disposal would allow. To have conceived this broad and scientific scheme, and to have possessed the administrative power to secure and keep in working concert so large and able a body of observers, on qualities of no mean order, and deserve grateful recognition wherever an intelligent interest is taken in the general progress of science and in that human advancement which scientific progress insures.

ARCHIBALD GEMIE

THE RUSSIAN IMPERIAL YACHT,  
"LIVADIA"

IT is not surprising that the character of the great steam-yacht *Livadia*, just launched upon the Clyde for the service of the Emperor of Russia, is exciting widespread interest. Since Noah built the Ark, no floating and moving structure has been constructed in such direct contrast as this vessel with all that has gone before it. Every other ship afloat has, in its chief features, been a development of the ships that preceded it, not excepting even the circular ironclads of Russia, for they were not the first circular vessels that had been designed and constructed, and although they had some steaming pretensions, these were too moderate to challenge seriously either the principles or the practice of naval architects. In the new yacht of Admiral Popoff's design, however, we have a steamship that, by its very existence, challenges the fundamental principles upon which fast passenger steamers are constructed by all the rest of the world.

We give herewith illustrations, of which the first (Fig. 1) is an external view of the *Livadia* as seen out of water; it is taken from a model which was constructed under the care of Admiral Popoff, and shows at a glance the general form of the ship. Another (Fig. 2) is a cross section, showing among other things the transverse distribution of the boilers and machinery. The third (Fig. 3) is a plan showing the horizontal distribution of the same, and indicating more clearly than the other the positions of the three propelling screws. It is obvious that such a form of vessel, propelled in the manner exhibited, suggests many questions of scientific interest; but most of these will be best discussed after the steam trials of the vessel have taken place. For the present it will be sufficient to take notice of the general characteristics and qualities which she presents to view.

It is desirable at the outset for the reader to observe that the *Livadia* consists of a shallow hull 235 feet long, 153 broad, and drawing, when supporting all its burdens, but 6½ feet of water. From a foot or two above the water's surface arch upwards and inwards with considerable curvature until they each meet (at about one-sixth of the whole breadth of the ship from the side amidships) the fore and aft sides of a naval palace, which extends from stem to stern. Although the width of the ship at the water-line is 153 feet, her width at a few feet above the water-line is therefore much less—about 110 feet, we believe. In smooth water, therefore, the resistance to onward motion will be those encountered by a vessel 153 feet broad and 235 feet long; but when the ship gets into heavy seas they will be free to pass over her low sides, and the ship that will have to divide and encounter them will be 110 feet by 225. As the object of this vessel is to furnish ample accommodation for the Emperor and his suite at sea, it may be fairly presumed that the width of the superstructure has been kept greatly within that of the hull proper, and the accommodation thus restricted, for the purpose of materially improving the behaviour of the vessel at sea. The arrangement will doubtless contribute greatly both to the speed and to the steadiness of the ship in great waves, its value for diminishing rolling having already been demonstrated in the circular ironclads, which have superstructures of less width than the ship, and which are remarkably steady even in seas that roll freely along the decks of the hulls proper.

The primary and chief fact concerning the anticipated steadiness of this exceedingly short, broad, and shallow ship, is that it is to be secured by means the very opposite of those which have lately obtained in this country, viz., by aid of enormous stability. Since the general acceptance of Mr. Froude's theory of rolling, the aim of the naval architect has been to send his ship to sea with sufficient stability for safety, and with no more than is

second and third engravings to the kindness of the first has been specially engraved for us.

ample for that purpose; because steadiness at sea is, under the modern theory, promoted by keeping the stability or righting force as small as possible, within the limit just named. The metacentric height, which is from 12 to 15 feet in the American monitors, which have great proportionate breadth of water-line, has been restricted to 6, 5, 4, and even less than 4 feet in many of our large war ships; indeed the *Sultan*, which is one of the steadiest of our large ironclads, has a metacentric height of only 2½ feet, while the *Inconstant's*, the steadiest of our unarmoured ships, is but very slightly in excess of this. This reduction of metacentric height increases proportionately the "period of oscillation," and makes vessels reluctant to accept the disturbances which waves endeavour to impose upon them. But while the tendency of modern science has thus been to diminish metacentric height and stability, the effect of the *Livadia's* form and proportions will be to give her enormous metacentric height and stability, the object in both cases being identical, viz., improved steadiness in waves. Nor is this course pursued, strange as it may seem to some, and violently antagonistic as it is to modern practice, without the sanction of science. For while a ship with very small stability, and consequently very long natural period of oscillation, is ordinarily secured against rolling by her slowness to accept the wave impulses, the ship with very large stability, and consequent very short period of oscillation, is ordinarily secured against excessive rolling by the very readiness with which she accepts those impulses and conforms to the mean movements of the waves. It is true that in the latter case the exemption from rolling motions is not so great as in the former, because a certain considerable amount of rolling is undoubtedly and necessarily involved in this conformity to wave motions; but this amount of rolling is very much less than that to which a ship is exposed which has neither stability so small as to render her comparatively indifferent to wave-pressures, nor stability so large as to force her to keep her decks approximately parallel to the wave-surface. Ships with intermediate degrees of stability are liable to roll much and to accumulate large rolling motions, especially when subjected to successive impulses from similar waves, whereas the ship of enormous stability, while always obeying each wave, is by that very means exempted from the tendency to accumulate the effects of a succession of waves. In all this reasoning—the generality and meagreness of which we fully recognise—it is of course assumed that the waves in question are of sufficient magnitude in proportion to the size of the ship to stand in individual relation to her. The immense breadth of the *Livadia* will doubtless preserve her from being rolled by small waves, including under that designation waves which would cause many ordinary ships to roll with violence. As regards longitudinal rolling, which is usually called pitching, if we neglect the onward motion of the ship, and consider the matter from the same point of view as that just adopted in speaking of transverse rolling, we may say with confidence that the longitudinal stability of the *Livadia* will be in excess of the transverse, and that no excessive pitching need be feared. Owing to the shortness and light draught of the vessel, she would probably (if not advancing) tend to accompany pretty closely the motions of the wave-surface when heading to waves of sufficient size to cause her to pitch. As her length is so small (less than half that of several transatlantic steamships now at sea), the vertical motions of the bow and stern will of course be correspondingly small for given angles of pitching.

It is when we come to consider the case of her enormous steam power being applied to force her ahead through large waves that we experience some difficulty in predicting her behaviour. For we here touch upon a question which has been but very imperfectly investigated; we might even say, has scarcely been more than

mentioned. A few facts and figures bearing upon it may nevertheless be given. It is estimated that a wave with a 4-seconds period and 82 feet long advances at a speed of 12 knots an hour; an 8-seconds wave 328 feet long has a speed of 24 knots; a 12-seconds wave 740 feet long a speed of 36½ knots; and a 16-seconds wave 1,300 feet long a speed of 48½ knots. If the *Livadia* were steaming at 14 knots against waves equal in speed to her own, she would of course encounter them at a speed of 28 knots, and that is a speed corresponding to a length of wave of about 450 feet, whereas the waves which she would actually be meeting would be but little over 100 feet in length. Again, if we may for a moment imagine her to be steaming at 18 knots an hour, and encountering similar waves, she would of course be meeting them at a speed of 32 knots an hour. But a wave of that speed would be nearly 600 feet long, whereas that which she would, under the last hypothesis, be encountering would be only 100 feet long, as before. It is obvious, therefore, that so short a ship, steaming at high speeds, would develop conditions unknown alike to vessels of low speed (such as sea-going vessels of her small length usually are when steaming against head seas) and to vessels of high speed but of great length. If we take for example the case of waves about 500 feet long from hollow to hollow, and therefore of a half-length of about 250 feet, it is obvious that whereas a fast steamship 500 feet long would receive the support of a second wave while the crest of a previous one still gave her bodily support, the *Livadia* is so short as to be capable of steaming down the wave slope, at an angle to the horizon approximately equal to that of the slope itself. If doing this at a speed of 15 knots an hour, or 25 feet per second, with the on-coming wave advancing upon her, as it would be, at 30 knots an hour, or 50 feet per second, it is easy to see that the behaviour of the vessel would be of an unusual kind. We do not give this as by any means the most notable or critical of the cases which might be selected, but it will serve to show that Mr. Froude was not speaking heedlessly when he said that the purely circular ships would tend to "dive," and to indicate that those persons are probably correct who see in departure from the circular form in the present case evidence, not so much of a desire to diminish resistance, as of a desire to correct the diving propensities of very short ships.

And this brings us to notice the steaming qualities of the *Livadia*. The enormous steam-power with which she is being supplied has naturally excited much notice, and the *Times* gave an interesting comparison between her power and proportions and those of the *Shah*. It will assist the further elucidation of the subject if we invite attention to a different kind of contrast, and compare the *Livadia* with the largest and most powerful of our finished armoured turret-ships, the *Dreadnought*. This huge ship, which steams at 14½ knots per hour, although very much more than twice the immersed size (displacement) of the *Livadia*, has very much less steam-power. The following is a comparison between the two ships:—

	<i>Dreadnought</i> .	<i>Livadia</i> .
Length ... ..	320 feet	235 feet.
Breadth, extreme ... ..	64 "	153 "
Immersed depth of hull (mean) ... ..	23 "	6½ "
Displacement ... ..	9,100 tons	3,900 tons.
Indicated horse-power ... ..	8,200	10,500

Allowing for the curvature in the form of the hull at and near the bottom, we should of course more than double the *Livadia's* displacement by carrying her sides at the load-water line vertically upwards, and immersing her another 6½ feet; we should probably, by this process, bring her displacement up nearly to that of the *Dreadnought*. As between the two ships, all this extra displacement is, so to speak, saved in the *Livadia*, while, as regards the steam power, hers is in excess of that of the *Dreadnought* by more than 25 per cent. It will be seen

from these conditions under what immense advantages the experiment of driving a broad and shallow ship very fast is to be carried out in the Imperial Russian yacht. So far as is known, the designer of the *Livadia* has not promised more than 14 knots of speed; but if we allow her the same speed as the *Dreadnought* (14½ knots) she will have a large excess of steam power (no less than 2,300 I.H.P.) applied to the propulsion of a hull weighing very much less than one-half the weight of the ironclad. The speed reached by the latter vessel was sustained throughout a six hours' trial.

As the *Shah* is a long fine-lined ship, 15 feet longer than the *Dreadnought* and 12 feet narrower, with about the same mean depth, the *Dreadnought* may be regarded as a considerable departure from her in the direction which has been pursued so very much farther in the *Livadia*. It will be instructive therefore to compare these two vessels—

	<i>Shah</i> .	<i>Dreadnought</i> .
Length ... ..	335 feet	320 feet.
Breadth, extreme ... ..	52 "	64 "
Depth (mean) ... ..	23 "	23 "
Displacement ... ..	5,900 tons	9,100 tons.
Indicated horse-power ... ..	7,500	8,200
Speed ... ..	16½ knots	14½ knots.

If we compare the performances of these two extremely different ships—different as regards length and breadth, but not as regards depth—we shall find a material reduction in the steaming efficiency of the short and broad ship, but not one of so marked a character as many might anticipate. Applying to both the well-known formula for comparing displacements, powers, and speeds, viz. :—

$$\frac{\text{Speed}^3 \times \text{Disp.}^\dagger}{\text{Ind. H.-power}}$$

we have—

$$\text{Shah} \dots \dots 195 \quad | \quad \text{Dreadnought} \dots \dots 163$$

Or, viewing the matter with reference to the midship sections propelled through the water, or to the volumes of the excavated channels, and adopting the Admiralty formula—

$$\frac{\text{Speed}^3 \times \text{Mid. Sec.}}{\text{Ind. H.-power}}$$

we have—

$$\text{Shah} \dots \dots 587 \quad | \quad \text{Dreadnought} \dots \dots 480$$

Here we have a loss of, say, 16 per cent. upon the performance constants as regards displacement, and a loss of more than 20 per cent. as regards midship section, by passing from the fine narrow form of the *Shah* to the broader and bluffer form of the *Dreadnought*, observing that the loss would probably have been in greater proportion had the *Dreadnought* been of no more than equal size or displacement with the *Shah*.

Although the *Dreadnought*, as compared with the *Shah*, advances towards the *Livadia* type, the advance is but very small indeed, the *Livadia* being much more than double the breadth of the *Dreadnought* upon a length of 75 feet less. We have in the great Russian yacht an experiment lying far outside of all former experience, and ranging itself under no laws or formulæ with which naval architects are familiar. But it may be well to exhibit her in the guise of the formulæ which we have just employed, and to do this first upon the assumption of a 14 knots speed, and secondly upon that of a speed of 17 knots—the highest, perhaps, which Admiral Popoff has allowed himself to hope for even in his most sanguine moods, and equal probably to that which his ardent disciple and assistant, Capt. Goulaeff, has ever evolved from the most plastic of his calculations—although we must acknowledge that we cannot say this with any great confidence in view of the published paper of the latter

<sup>†</sup> The *Dreadnought's* breadth diminishes by some feet, we believe, at a depth of 6 or 7 feet below the water's surface, but this will not materially interfere with the comparison about to be given.

1887  
1888  
1889  
1890

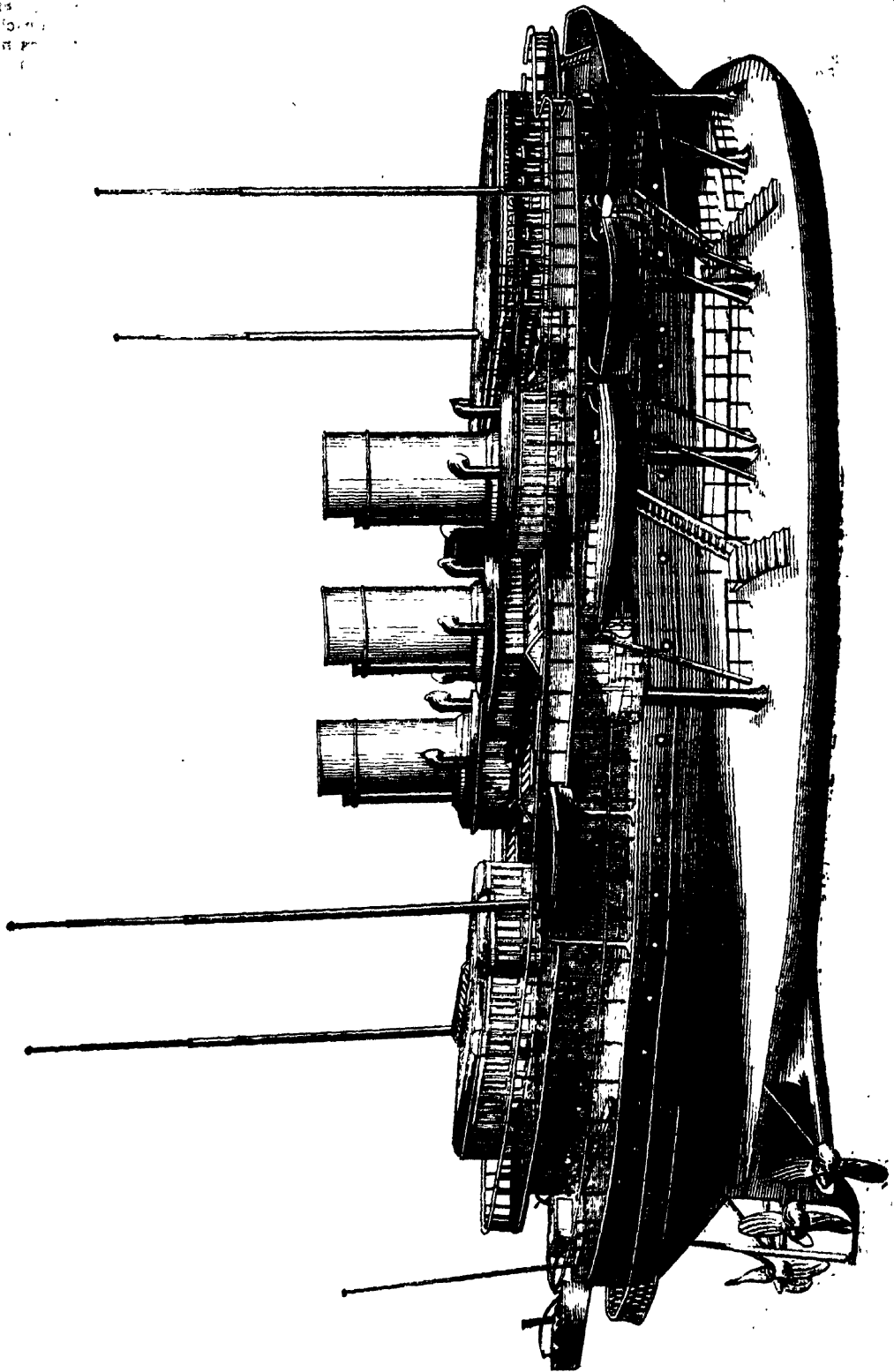

officer. The formulæ give the following results for the *Livadia* :—

	Speed 14 knots.	Speed 17 knots.
Displacement constants	65	116
Midship sec.	234	419

These figures illustrate the margins within which the

performances of the *Livadia* may range when steaming at above 17 knots and 14 knots respectively. It cannot be expected that her constants will fall so low as the former of the pair just given, and therefore it cannot be doubted that her speed will surpass 14 knots.

We have intimated that Capt. Goulaeff, in his paper on

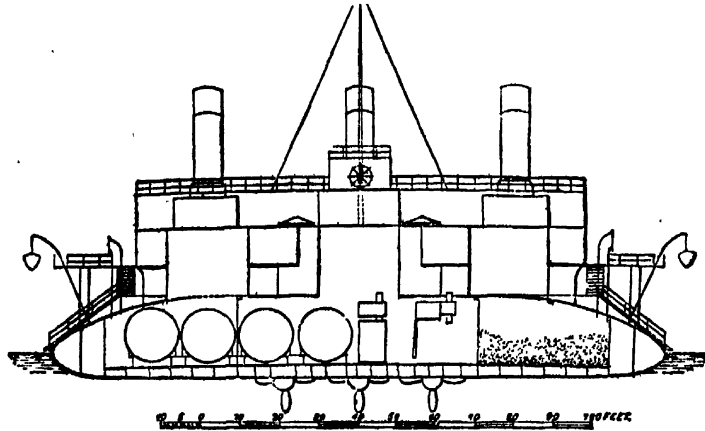

“the *Fairfield* yacht of the Czar,” has written with great confidence on the favourableness of this vessel's form to speed. He says that an addition of 25 or even 50 feet of length would not have reduced the resistance, the increase of friction being more than the improved form of the water-lines would have compensated for. But it is to her shallowness that he looks for her facility of propulsion,

contending that experiments on both a small and a large scale have shown that it is better for speed to have great breadth rather than great depth. He even says that “at certain speeds a very much broader vessel requires only half as much power compared with another vessel of similar form whose draught is double.” It is on this ground that he chiefly bases his anticipation that great

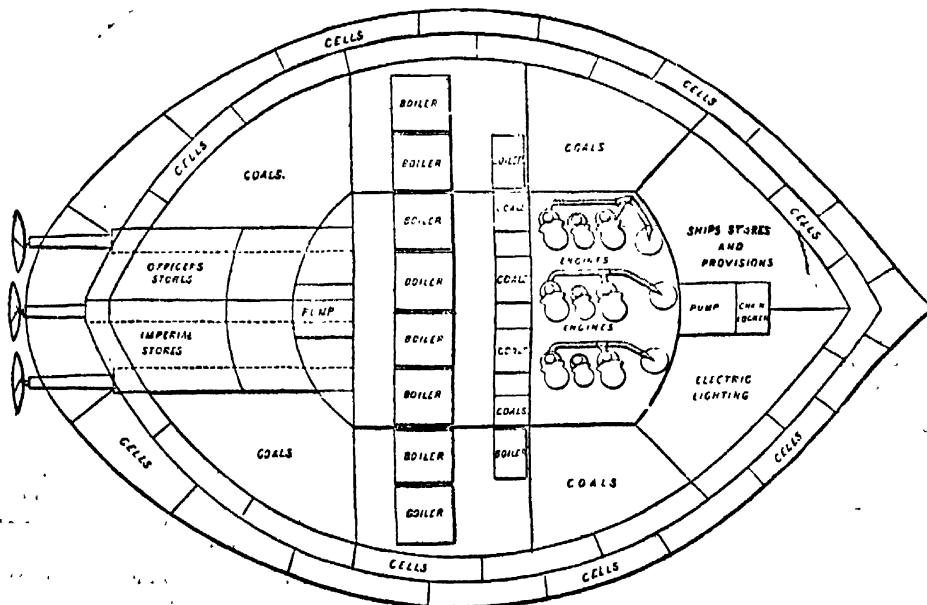

speeds are not incompatible with the form given to the *Livadia*. The form of the vessel below water has been very carefully considered. Capt. Goulaeff says :—  
“The form of underwater portion was made a subject of very careful study. Besides the great experience of the designer of the ship, Admiral Popoff—experience

which he derived by spending the greater portion of his lifetime either on the ocean or in constructing novel ships and trying them at sea—Dr. Tideman, member of the Academy of Amsterdam, was invited to assist in the determination of questions connected with the resistance of the yacht. In the case of this shallow-draughted

vessel, the fine lines must be the vertical sections, whereas the fine lines of the ordinary steamer are the water lines or horizontal sections. Such change has been brought about by passing from long, narrow, and deep forms of ordinary vessels to the proportions of short, broad, and shallow ones; and, as has been demonstrated by experiments with paraffin models, the sharpening of buttock lines is more essential in this case than sharpening of water lines. In other words, if the motion of an ordinary vessel may be compared with that of a wedge propelled vertically, the motion of the yacht ought to be compared with the same wedge propelled through the water horizontally. On looking at the stern of the actual vessel you will observe that the whole motion of the water between the stern tubes will be effected solely in the direction of the vertical sections, or the buttock lines."

It is needless for our purpose to consider the minor details of a vessel so fraught with features of extraordinary interest. It may be well to point to the fact that the ship is to be steered, not by rudders, but by her screw propellers only, of which she has three of equal diameter (16 feet), as illustrated in our engravings. These screws are spaced 18½ feet apart, the central one being in the line of keel. Each screw has its own engine of 3,500 I.H.P.

We need hardly say we shall watch the trials of this ship when her machinery is completed, and report the results to our readers. Meanwhile we join in the tribute of praise which is being freely accorded in this country alike to her bold and adventurous designers, and to His Imperial Highness the Grand Duke Constantine of Russia, a highly scientific and accomplished naval officer, by whose influence, and under whose personal care, some of the greatest problems in steam navigation are being developed.

### NOTES

THE ceremonies at Manchester in connection with the Victoria University last week were as successful as the momentous event deserved. The *conversazione* on Tuesday evening was brilliant and crowded. The meeting on Wednesday for the transaction of the business of the University was harmonious and satisfactory, while the banquet that succeeded was quite worthy of the Corporation, who acted as hosts. The address of that body to the Duke of Devonshire seemed to us to breathe the proper spirit, and to show that Manchester is quite alive to the importance of the great event which has been celebrated. But indeed we did not require any such evidence of the importance attributed to high education in Manchester; as Earl Spencer pointed out, the Manchester grammar and other schools are among the best in the kingdom, and the existence of Owens College itself is proof enough that Manchester thinks of something else besides the most effective way of loading cotton goods. The speeches were all good and appropriate; the Bishop of Manchester was as liberal and fair as he always is, and his claim for freedom of research and belief in his own line was heartily endorsed by Prof. Huxley, who replied to the toast proposed by the Bishop. Prof. Huxley hoped the time would come when such an institution as Owens would be found in every important centre—a hope we heartily echo. Mr. Freeman was forcible and sensible, and of course took occasion to correct the historical inaccuracy of some one who cherishes the belief that the University of Oxford was "inaugurated" in a desert instead of what was at the time a busy industrial centre.

It is comforting to receive the assurance given by Mr. Mundella at the opening of the Central Schools of Sheffield last week, that as long as he has the honour to occupy the place he does in her Majesty's Government the quality of education and the standard of education should not be lowered. The State,

he maintains, having decided that the children of the country should receive education according to their needs and capacities and prospects in life, ought to give that education not only thoroughly, but generously and with an unstinting hand. With such a sentiment actuating the Vice-President of the Council, we feel that elementary education is safe from the raids of Lord Norton and his friends.

A SOMEWHAT laboured and diffuse article on "Scientific Arrogance" in Monday's *Pall Mall Gazette* comes to the following very sensible conclusion:—"It would appear that scientific arrogance, in so far as it has any reality, is but the obverse of popular ignorance. Let the ignorance be dispelled, and the mystery bred of it will vanish. Let some rudiments of exact knowledge, some grounding in the methods of scientific reasoning, and some notions of the nature and ends of scientific work, be made part of our general scheme of instruction, and scientific dogmatism will be impossible. Let the mind be trained betimes to walk modestly and warily, as all true leaders of knowledge have walked, by the light of diligent and patient inquiry, and the spectre of scientific arrogance will disappear." One more argument for the retention of the Fourth Schedule. Perhaps even Lord Norton might put himself to school to some advantage after this recipe.

THE new Matriculation list of the London University bears ample evidence to the success of the step recently taken by the Council in admitting women to its degrees. In the Honours Division the third place is occupied by Edith Sophia Callet, from the North London Collegiate School. Altogether about one-sixth of the names on this Division are those of girls, and the proportion on the other Divisions is quite as great.

THE New South Wales Government have done a creditable thing in erecting an obelisk on the spot occupied by the Transit instrument in the old observatory at Parramatta, established by Sir Thomas MakDougall Brisbane in 1822. The building has long been swept away; many valuable observations were made in it by Mr. Charles Rumker and Mr. James Dunlop, and it was only right that the exact position of the Transit instrument should be permanently marked, so that, if necessary, future verification might be made. The first suggestion of the obelisk was made by Mr. Tebbutt so long ago as 1870, and it is gratifying that the New South Wales Government has so much regard for science as to act on Mr. Tebbutt's suggestion.

WE have a note from General Myer, dated July 1, stating that at the request of Prof. Wild, of St. Petersburg, the date fixed in his letter of May 4 changing the time of taking the International Simultaneous Meteorological Observations to a time thirty-five minutes earlier than at present, or to oh. 8m. p.m., Greenwich time, is changed from September 1, 1880, to January 1, 1881, a change with which the numerous observers over the world who make the observations from which the U.S. Weather Maps are constructed will doubtless concur.

WE regret to announce the death of Mr. W. A. Lloyd, who has done so much for the improvement of marine aquaria. Mr. Lloyd, it will be remembered, was for long connected with the Crystal Palace Aquarium.

FROM the *Gardeners' Chronicle* we learn that a committee, comprising some of the leading botanists and horticulturists of Berlin, has set on foot a project to erect a memorial stone on the grave of the late Karl Koch, and appeals through the press to his friends and admirers for subscriptions wherewith to carry out the project in a manner worthy of him whose memory it is desired to perpetuate. Subscriptions may be sent to Herr Spath, Baumschulbesitzer, 154, Köpenickerstrasse, Berlin, S.O., and will be publicly acknowledged.

PROF. MCK. HUGHES, of Trinity College, Cambridge, writes to us as follows:—"I am writing the life of Prof. Sedgwick, but I want much which I fail to find in the mass of MS. placed in my hands, especially letters from himself giving an account of contemporary persons and events. Can any of your readers help me in this matter?"

WE take the following from the *New York Nation*:—"For the English-speaking race, wherever planted, we should have supposed NATURE to be a sufficient scientific medium, and entitled to universal support. We are partly confirmed in this view by the quotations from NATURE in the first number of *Science*, a quarto weekly journal, edited by Mr. John Michels, and published at 229 Broadway, in this city. Nevertheless, the editor's statement that the enterprise has been begun 'after consultation with many of the leading scientists in this country,' and his list of co-labourers seem to point to a real want, and to entitle this new 'record of scientific progress' to a friendly welcome. Its present size is sixteen pages, including the advertising sheet. The opening article, on the United States Naval Observatory, is from the pen of Prof. E. S. Holden." We wish our new contemporary every success, and trust that it may be the means of spreading a wide interest in science on the other side of the water.

THE half-yearly general meeting of the Scottish Meteorological Society was held yesterday. The business was: (1) Report from the Council of the Society; (2) Proposed Inquiry by the Society into the Relation of Climates in Scotland to the Growth of Trees, by Sir Robert Christison; (3) Relations of Weather to Deaths from Scarlet Fever and Whooping Cough, in Thirty-one British Large Towns, by Dr. Arthur Mitchell and Alexander Buchan, secretary; (4) Anemometer for ascertaining the Direction of the Wind with reference to a horizontal Plane, by Alexander Frazer, M.A., optician.

PROF. A. H. CHURCH, late of the Royal Agricultural College, Cirencester, has begun a course of lectures on Agricultural Chemistry at the Wilts and Hants Agricultural College, Downton, near Salisbury. There are many characteristic features in the farming of the district, well illustrated on the extensive farm of the new college. These afford both valuable illustrations and important subjects of investigation to the agricultural chemist as well as to the botanist and geologists. We hope that this new institution, over which Prof. Wrightson presides, will occupy itself not only in agricultural teaching, but in agricultural research, and develop, after a time, into a "Versuch-Station" of no little value.

THE continued wet weather at Carlisle, which lasted without intermission from Monday evening to Thursday at noon, rendered it extremely difficult to do justice to one of the finest exhibitions ever held by the Royal Agricultural Society. Among the most important of the novelties was Mr. Darby's steam digger. This instrument is intended to supercede the steam-plough by producing at once a pulverising effect superior to that of the combined action of plough and cultivator, and equal to that produced by the spade. The idea is old, but up to the present time it has not been successfully applied. Mr. Darby's digging-machine consists of three sets of prongs of fourteen each, arranged on three cross-bars twenty-feet wide. Each cross-bar is worked independently and in succession by a separate crank-shaft. The earth is moved to the depth of six to ten inches, and by the action of the revolving crank-shafts the raised sod is pitched backwards and neatly inverted. The surface is left somewhat too flat for harrowing, but a second digging renders the work much more efficient. The greatest drawback to this ingenious machine lies in its weight. When charged with coal and water the engine and digger unitedly weigh fourteen to fifteen tons. Experiments in the trial fields showed that three-fifths of the

power were absorbed in moving the implement over the ground. There were no new forage plants exhibited, and the stands devoted to manures and feeding-stuffs contained no articles save those with which we were familiar. In the live stock sheds the most interesting exhibits were the mountain-sheep peculiar to Cumberland and the adjoining counties. The Herdwick sheep are hardier than the Scotch black-faced breed. They are able to thrive on the poorest land imaginable, and manage to leave a good profit in the hands of the Dalesmen who own them. Thanks to the Herdwick race of sheep, the bad times of which we have heard so much are unknown in the Lake district. Another excellent breed, not often seen out of their own locality, which lies in West Yorkshire and East Lancashire, is the Louks. This race, unlike other kinds of sheep, is well suited to the damp and mossy lands lying between the hills of mountain limestone which form this part of England. Their faces are speckled, black and white, and both sexes are horned. They are readily distinguished from the Highland black-faced breed by the evidently better quality of their wool. A third race unfamiliar to the bulk of English farmers is the "Crag" or "Limestone" sheep, which occupies the highlands of the same district as the Louks. The crag-sheep are adapted for a dry and poor pasture, and can do without water. The louk and the crag-sheep therefore offer good instances of the adaptability of different races of animals to their environment.

THE Zoological Station established last year in connection with the University of Aberdeen, at Stonehaven, is at present in process of erection near Cromarty. The work will be carried on throughout August and September, and part of October, under the superintendence of George J. Romanes, F.R.S., and Prof. J. C. Ewart. Those desirous of taking advantage of the station are requested to communicate with Dr. Ewart, Dunakaith, Ross-shire.

THE Sydney papers state that some important gold discoveries have been made in the Bathurst district near Tuena, and that in one claim a bushel of broken quartz yielded two pounds of gold. A very rich gold-field has also been found at the Margaret River, in the Northern Territory of South Australia.

THE Executive Committee of the International Medical Congress for 1881 made their report to the General Committee of this Congress, which met at the College of Physicians on Tuesday last week. The officers of the Congress were proposed and nominated. The sections were agreed upon, and the treasurer, Mr. Bowman, announced that large subscriptions had already been received. It was agreed that the time of meeting of the Congress should be from August 3 to 9, 1881. The president of the Council of the British Medical Association stated that the Council of that body had postponed their meeting to the following week. It was also announced that the Congress would meet in rooms granted for the purpose by the University of London, the Royal Society, and the other learned societies meeting in Burlington House, so that the sections will be all practically under the same roof. The president of the Congress will be Sir James Paget, and there will be fifteen sections in all.

It is intended to hold an International Congress of Commerce and Industry at Brussels, from September 6 to 11. M. Antoine Dansaert is to be the president, and the meeting will take place under the patronage of the King of the Belgians.

ACCORDING to the *Electrician*, a remarkable instance of telephony is exciting considerable interest throughout South Australia and among the scientific world in particular. By means of an improved telephone the Adelaide Post Office, which has been clearly heard at Fort Augusta, a distance of 940 miles.

MR. G. F. H. MILNE, owner of the fossil forest recently discovered at Oldham, and referred to in NATURE at the time,

has offered to allow the Oldham Corporation to have care of it, and make a charge to visitors, the money to be applied towards a public museum. No doubt the Corporation will accept this handsome offer.

At the Rheims meeting of the French Association M. Gariel will give a public lecture on Radiant Matter, with Mr. Crookes' experiments, and M. Perier on the Law of Selection. The meeting of 1881 will be held at Algiers, and an excellent paper has been published in connection therewith by M. Macarthy, president of the Society of Natural Sciences of Algiers. This physicist settled in Algiers thirty years ago, and holds the position of librarian of the National Library of Algiers; in his *brochure* he reviewed all the different topics which might be submitted to the several sections of the Association.

A VIOLENT shock of earthquake occurred at Manila and throughout the Island of Luzon on July 18, which did immense damage, totally destroying several government buildings and other houses. Some of the native inhabitants were killed, but no Europeans suffered any injury. A slight shock was felt also on the 17th inst.

ON July 14 the French Chamber of Deputies adopted a proposition of M. Lockroy, that a sum of 3,700,000 francs originally intended to rebuild the Palace of the Tuileries should be devoted to enlarge the national library, which will be quite isolated from other houses. The sanction of the Senate will be asked next session, but not a single representative having objected, the result is not dubious, and preparatory steps will be taken very shortly to execute this great measure of preservation and improvement.

IN an interesting article on "Mistakes about Snakes," by Mr. Arthur Stradling, in the *Field* of the 17th inst., the author gives an *exposé* of the famous Indian basket trick, in which a boy is shut up in a basket and apparently put to death by sword-thrusts, but suddenly appears among the company uninjured. The narrative is too long for quotation, and we recommend our readers to obtain a perusal of the original.

THE following is the title of the essay to which the "Howard Medal" of the Statistical Society will be awarded in November, 1881. The essays to be sent in on or before June 30, 1881. "On the Jail Fever, from the earliest Black Assize to the last recorded outbreak in recent times." The Council have decided to grant the sum of 20*l.* to the writer who may gain the "Howard Medal" in November, 1881. Further particulars or explanations may be obtained from the Assistant Secretary, at the office of the Society, King's College entrance, Strand, London, W.C.

M. HERVÉ-MANGON, the director of the Conservatoire des Arts et Métiers, has compiled a catalogue of the celebrated Vaucanson collection; it will be very shortly placed at the disposal of the public in the Portefeuille Industriel, a special library opened in the Conservatoire for the communication of designs and documents relating to industry. The course of public experiments is attracting an unprecedented number of visitors to the galleries. Every week a programme of the exhibits is posted on the walls outside the buildings.

THE Manchester Scientific Students' Association is a busy society, as its Report for 1879 shows. It contains reports not only of various lectures and papers read at its meetings, but interesting accounts of the numerous excursions made by the members; these are occasionally illustrated, the illustrations being sometimes rather rude.

SUPPLEMENT No. 5 to the U.S. *National Board of Health Bulletin* contains a report of the proceedings at a conference on

Vital Statistics held at Washington on May 6 last. There is an interesting discussion on the subject of a Standard Nomenclature, with special reference to that adopted by the Royal College of Physicians of England; and appended is a very detailed nomenclature of ophthalmology and otology, by Dr. S. M. Burnett, of Washington.

AMONG the papers in the forthcoming number (vol. lii. No. 1) of the *American Journal of Mathematics* are the following:—"Regular Figures in *n*-Dimensional Space," by W. J. Stringham; "On the Algebra of Logic," by C. S. Peirce; "On the General Equations of Electromagnetic Action, with Application to a New Theory of Magnetic Attraction, and to the Theory of the Magnetic Rotation of the Plane of Polarisation of Light," by H. A. Rowland; "On Certain Ternary Cubic-form Equations," by Prof. Sylvester.

THE additions to the Zoological Society's Gardens during the past week include a Rhesus Monkey (*Macacus erythraeus*) from India, presented by Mrs. C. Salvin; a Common Badger (*Meles taxus*), British, presented by Mr. Frank G. Haines; a Huanaco (*Lama huanacos*) from Bolivia, a Common Rhea (*Rhea americana*) from South America, presented by the Marquis of Queensberry; a Common Paradoxure (*Paradoxurus typus*) from India, presented by Col. Sturt; four Ring-tailed Coatis (*Nasua rufa*) from South America, presented by Lieut.-Col. J. A. Smith, 1st W.I. Regt.; a Common Hedgehog (*Erinaceus europæus*), British, a Greek Land Tortoise (*Testudo græca*), European, presented by Mr. L. C. Brook; two American Darters (*Plotus anhinga*) from Brazil, presented by Mr. Gerald Waller; a Goffin's Cockatoo (*Cacatua goffini*) from Queensland, presented by Miss Bartlett; two Red-legged Partridges (*Caccabis rufa*), two Common Buzzards (*Buteo vulgaris*), European, presented by Mr. W. H. St. Quintin; a Common Heron (*Ardea cinerea*), European, deposited; a Common Seal (*Phoca vitulina*), British Seas, two Japanese Pheasants (*Phasianus versicolor*) from Japan, a Bar-tailed Pheasant (*Phasianus reevesi*) from North China, purchased; a Burchell's Zebra (*Equus burchelli*) from South Africa, received in exchange; two Lions (*Felis leo*), an Eland (*Oreos canna*), born in the Gardens.

#### OUR ASTRONOMICAL COLUMN

THE COMET of 1668.—There is one point in the history of this comet which we do not remember to have seen mentioned since its supposed reappearance in 1843 revived the attention that was directed to it early in the last century, and it is one which, if accepted, bears materially upon the question of identity. Pingré has no reference to it in the account of the comet of 1668 in his "Cométographie." In the report of the observations made by the French Jesuit Valentin Estancel at San Salvador, in the *Philosophical Transactions*, No. 105 (1674, July 20), which is stated to be a translation from the *Giornale de' Letterati*, No. 9, published at Rome in September, 1673, we read after the description of the evening observations commencing March 5, 1668:—"It may be taken notice of that a month before, upon a report that a comet had been seen towards the morning in the horizon of the rising sun, and certain Carmelites that live upon a hillock of the said town having affirmed that they had observed it several times, our P. Estancel began to doubt whether the comet he saw were not the same which, more swift than the sun, according to the succession of the signs, might within that time have got clear of the solar rays; and his suspicion grew the stronger because the head was then turned towards the sun and the tail towards the west, opposite to the same." But if the comet of 1843 were in perihelion near the time which Henderson found it necessary to assume in order to satisfy the indications of his Goa chart, it would not have preceded the sun in the first week in February, but would have had considerably greater right ascension, so as to be visible only in the evening. Henderson's direct orbit, however, which upon the whole accords much better with his data, would place the comet in R.A. 311°, Decl. -7½° on February 5, at 2½h. San Salvador time, so that it would precede the sun, which was then in R.A. 320°.



If this circumstance is adverse to the identity of the comets of 1668 and 1843 there is another which would rather tend to support it, were it not that there appears to be an oversight in the record. Zach in an article, "Ueber einige unberechnete Cometen, deren Bahnen man vielleicht noch auffinden und berechnen könnte," in vol. xviii of his *Monatliche Correspondenz*, refers to the comet of 1668, and, after mentioning the observations of Cassini and others, he adds that in the *Philosophical Transactions* for 1668 there is an observation of a comet, which places it on March 7 in longitude 16°, with 20° 30' south latitude, and he asks, "Ist diess die Cassinische Spina?" referring to the title of the tract in which Cassini gave his observations of the phenomenon in March, 1668, viz: "Spina, Celeste meteora observata in Bologna, il mese die Marzo 1668" (Bologna, 1668 in fol.). If we suppose the comet of 1843 to have arrived at perihelion February 24, 284, Greenwich time, at 8 p.m., on March 7, its place would have been in longitude 16° 0', with 20° 4' south latitude, as observed, and the agreement gives an importance to the reputed observation, if it could only be traced. It was first remarked by Schumacher (*Astron. Nach.*, No. 484) that the observation mentioned by Zach does not occur in the *Philosophical Transactions*: his words are: "Diese Beobachtung 1668 März 7, Länge 16°, südliche Breite 21½° steht nicht in dem von Herrn v. Zach angeführten Bande der *Philos. Transactions* und, wenn das Register der *Phil. Transact.* genau ist, in keinem der ersten 70 Bände." We find on a careful examination of the volumes or numbers of this work containing reference to the comet of 1668 as indicated in Maty's Index, that there is no such observation recorded. There are two articles bearing upon this comet: (1) in vol. 3 for 1668, in No. 35, May 18, 1668—which gives a translation of Cassini's description of its appearance, from the Italian, and a notice of its having been observed at Lyons, Toulouse, Toulon, &c., though not at Paris, and (2) in vol. 9 for 1674, in No. 105, July 20, 1674 (though not occurring in the list of contents to this number on the first page): this second notice chiefly refers to the observations of P. Valentin Estancel in Brazil, taken from *Giornale de Letterati*, September 31 (*sic*) 1673—a journal printed at Rome.

Perhaps some of our readers may have opportunity of making further search in the libraries for information relating to the comet of 1668, though we are aware that much was done in this direction in 1843. It would be of interest more particularly if the observation which Zach would appear to have somewhere met with, could be traced.

**VARIABLE STARS.**—The following times of maxima and minima of variable stars during the ensuing two months are extracted from the ephemeris prepared by Prof. Winnecke for the first part of *Vierteljahrsschrift der astronomischen Gesellschaft* for 1880 (15. Jahrgang):—

Aug. 2. S Ursæ maj., <i>min.</i>	Aug. 30. R Comæ.
3. R Leonis.	Sept. 2. U Virginis.
4. S Sagittarii.	3. R Draconis.
11. S Pegasi.	5. W Scorpii.
12. R Sagittarii.	8. R Virginis.
15. V Tauri.	9. R Arietis, <i>min.</i>
16. R Persei.	10. R Vulpeculæ.
18. R Ursæ maj.	16. R Ophiuchi.
21. T Herculis, <i>min.</i>	19. R Camelopardi.
24. S Vulpeculæ, <i>min.</i>	20. T Virginis.
S Herculis, <i>min.</i>	20. R Aquilæ, <i>min.</i>
R Aurigæ.	21. S Cephei, <i>min.</i>
28. R Sagittæ, <i>min.</i>	21. S Vulpeculæ.
29. S Aquarii.	29. R Bootis, <i>min.</i>

Prof. Winnecke has August 2 for the date of approaching maximum of *Mira Ceti*; the formula in Prof. Schönfeld's last Catalogue gives August 10.8; perhaps some reader of NATURE may be able to say, in due course, when the maximum actually occurs. The amount of perturbation by the formula for Epoch 15 = + 37d.3.

M. Ceraski of the Moscow Observatory draws attention to an object which evidently deserves close observation. On June 23

Carrington estimated this star 7.9. Schwed observed it four times, and his estimates of magnitude are strongly indicative of variability; thus it is called 8 on December 11, 1827; 6.7 on March 11, 1828; 8 on the following night, and 10 on May 12 in the same year. It is No. 130 in Carrington's Catalogue, the

place for 1855.0 being in R.A. oh. 49m. 38.9s., Decl. 81° 5' 33". The star was also observed by Lalande in March, 1790, as an eighth magnitude (Fedorenko 145).

### BIOLOGICAL NOTES

**THE EVOLUTION OF DIBRANCHIATE CEPHALOPODS.**—Dr. J. Brock, in the last number of Gegenbaur's *Morphologisches Jahrbuch* (vol. vi. p. 185), gives his reasons for dissenting from von Ihering's conclusions on this subject. He has dissected spirit-preparations of many of the principal genera, and he discusses the evidence derived from the shell, the funnel, the muscular system, the radula, the nervous system, and the vascular excretory and reproductive systems. Three anatomically well-marked phyla or groups of genera are made out, of which the Cegopsidæ are the most ancient, and from this group the other two—the Myopsidæ and the Octopods—are derived. The Cegopsidæ he further divides into two groups—the Ommastrephidæ and the Loligopsidæ, the comparative antiquity of which cannot yet be determined; they are of great interest because they both show important connections with the two other phyla. The Cegopsid forms are primarily true Belemnites, and later developed into the Sepia type, from which stock also the decapods with simple horny shells sprang independently. The octopods, the most highly differentiated phylum, but with an organisation showing a very early origin, and branching from the main type, afford some evidence of relationship to the type of Loligopsid, although they cannot be regarded as having originated from them. Most probably they had a common origin from the primordial dibranchiate form with ten arms. Dr. Brock relies considerably on the oviduct being double in the Cegopsidæ, and single (by reduction) in Myopsidæ; but unless he can support his theory by more developmental facts it can hardly attain sufficient credit for practical use in classification.

**ON A CASE OF APPARENT INSECTIVORISM.**—Prof. Baillon, at a recent meeting (April 7) of the Linnean Society of Paris, read the following notes:—*Peperomia arifolia*, Miq., of which the variety *argyreia* is cultivated in so many greenhouses, has the leaves more or less deeply peltate. I have seen stalks on which the peltation on certain leaves was so exaggerated as to show on a cross-section a depth of nearly four centimetres. When the concave stalks take a suitable direction, water, principally that from sprinkling, would accumulate and rest in these receptacles, so well prepared to preserve it. Many small insects would fall into this water and be drowned. Last year, when the season was warm and when the windows of the house were often open, the number of insects was very considerable, and these, soaking in the water, gradually fell into decay, and it was remarkable that there was during this not the least sign of any putrescent odour. Those who believe in the doctrine of insect-eating plants may perhaps in this be led to find an argument favourable to such theories. They will add that the variety of colours so strikingly seen in these leaves constitutes the agent of attraction for the insects to come and be devoured. Three reflections, each of a different sort, here present themselves: 1. Is it not remarkable that the exaggerated peltation of these leaves is in this case accompanied by an apparent insectivorism, and that the leaves of the plants known up to this by botanists as carnivorous owe their sac-like, horn-like forms only to an excessive peltation of their limb, as we demonstrated in the evolution of the leaves in *Sarracenia* (*Comp. rend.*, lxxi. 630)? 2. How can it be considered as a proof of insectivorism, that plants such as the *Urticularia* grow better in a fluid containing albuminoid compounds, when other plants grow equally favourably in the same kind of fluid, which latter are never for a moment thought of as carnivorous? 3. How do the chief priests of our science reconcile the two ideas, that the surface of the leaves of plants are unable to absorb pure water in contact with them, and that the same surface daily absorbs water charged with albuminoid substances and the like?

**INTESTINAL WORMS IN THE HORSE.**—H. Krabbe has published in the *Oversigt over det K. Danske Videnskaberne Selskabs*, No. 1, 1880, p. 33, an interesting account of the occurrence of intestinal worms in the horse. As this animal is spread over the greater part of the habitable world, and under conditions of life very varied, it might be supposed that, like man and the dog, it would not be equally affected with these parasites, nor with the same species. For to determine with some degree of accuracy the worms which in Denmark are found in the intestinal

canal of the horse, Mr. Krabbe examined, during the last four years, the bodies of one hundred horses which were brought for anatomical purposes to the Veterinary College at Copenhagen, between the months of September and April in each session. In these horses he found *Tenia perfoliata*, 28 times; *T. mamillana*, 8 times; *Ascaris megaloccephala*, 16 times; *Strongylus armatus*, 86 times; *S. tetracanthus*, 78 times (in 67 horses out of 86); and *Oxyuris curvula*, twice. Of *T. perfoliata* the number found was mostly less than 25; sometimes it was over, and twice between 100 and 200 were found, while once no less than 400 were met with. In general they were lodged in the cæcum. *T. mamillana* of Mehlis, a species overlooked by Dujardin and most French writers on the subject, was described and figured by Gurlt in 1831; generally less than 25, but sometimes up to 72, were met with, mostly in the anterior part of the small intestines (*T. plicata*, R., was never met with). The *Ascaris* never occurred in larger numbers than 11. *S. armatus* was never met with in the small intestine; in the cæcum it was common; much less so in the first portion of the colon, where very fine specimens of a dark bluish red colour were found; generally the number met with was below 25, but once nearly 200 were found. Of 1,409 samples, 1,029 were females and 380 males. *S. tetracanthus* was found in the cæcum and throughout the colon. The literature of this subject would appear to be very scanty, and the author hopes that the attention of veterinary surgeons in other parts of the world may be attracted to this subject. Ample opportunities of following it up exist in British India, America, and the Cape of Good Hope district.

**THE DOMESTICATION OF DEER.**—A very interesting correspondence is published in the *American Naturalist* for June between Mr. Brown, the superintendent of the Philadelphia Zoological Gardens, and Mr. J. D. Caton. It relates chiefly to the question of the domestication of species of deer. Of the twelve species kept in the Philadelphia Gardens the mule deer (*Cervus macrotis*) have bred during 1878 and 1879; of five fawns one died when two days old; the other four, though most carefully nursed and fed with astringent food, as well as supplied with iron water and gentian powders, &c., all died of a diarrhoea caused by malignant disease. Five specimens of moose-deer and eight of caribou died at periods varying from three months to two years and five months in the moose and not beyond nine months in the caribou from hypertrophy of the heart. The pronghorn (*A. americana*) all died speedily from diarrhoea or hypertrophy of the heart; change of food and tonics seemed to have no effect upon them. Of ten or twelve individuals none lived more than fifteen months. The wapiti and common deer (*C. virginianus*), however, have done well, and several fawns were raised of *C. campestris*, *C. aristolelis*, and *C. dama*. Of *C. leucurus* the Gardens possessed but a single specimen. In the case of the mule deer Mr. Brown is disposed to account for the mortality by the difficulty of supplying them with a sufficient amount of their proper (arboreal) food, which has to be replaced by dry food and grass. Mr. Caton, writing from Ottawa, Illinois, states that he had lost the last of his stock of mule deer and also of *C. columbianus*, and that he is satisfied that they cannot be successfully domesticated in his grounds. He concludes that they get at something which does not agree with them; indeed all his experiments with ruminants, *fera natura* whose natural habitat is confined to the United States west of the Missouri River, have proved failures. Mr. Caton has succeeded well in hybridising the Virginian deer with the Ceylon deer and the Acapulco deer. The hybrids seem to be perfectly healthy and prolific, several of the hybrids from the Virginian deer and Acapulco buck having borne perfectly healthy twin fawns. On some of the hybrids the metatarsal gland is wanting, and on some it is present, while some have it on one hind leg and not on the other.

**THE FIDDLER CRABS.**—Mr. J. S. Kingsley, in a further contribution to the *Proceedings* of the Academy of Natural Sciences of Philadelphia, revises the genus *Galasimus*, and as a result he makes a great reduction in the number of species. This has been done, not with any desire to overturn the work of others, but as the result of a study of the forms known all over the world. The range of many species is greatly extended. He refers the genus to the family Macrophthalmidae of Dana; and it is characterised by its rhomboidal carapace, broad in front, elongated eye-stalks, and a great inequality of the chelipeds or nipping feet of the male. The latter is the most constant character of value. The species fall into two groups according as

the front between the eyes is very narrow or wide; and the latter have males with a five-jointed or seven-jointed abdomen.

**ORGANS OF DEEP-SEA ANIMALS.**—During his researches on the fauna of the Caspian Sea, M. O. Grimm has studied the modifications which are undergone by the organs of sense in animals which inhabit great depths. Among them several have well-developed organs of sight, which seems to prove that even at very great depths light is not completely absorbed. Such are the Caspian *Mysis*, the *Gammaracanthus caspius*, several *Becklie*, and others, but on the contrary, there are at the same depths many species whose eyes are quite atrophied, and in these species we observe that other organs of sense receive a greater development. Such is the case in *Niphargus* and *Onesimus*. But, whilst *Niphargus caspius* bears well-developed organs of smell and of touch on its antennæ, in *Onesimus*, which, as well as the former, has but rudimentary eyes, only organs of touch are to be found on its jaws. M. Grimm explains this last difference by the circumstance that the former species usually remains in water, whilst *Onesimus* likes to remain in the mud at the bottom, where it searches for its food very much like a mole.

#### CHEMICAL NOTES

IN the *Journal* of the American Chemical Society, vol. ii., Mr. P. Collier describes a new mineral from the Champlain iron region, which resembles thorite in its physical properties, but differs therefrom in containing a relatively large quantity of uranium. Analysis showed 9.96 per cent. of uranic oxide, and 52.07 per cent. of thoric oxide, with 19.38 per cent. of silica, the remainder consisting of oxides of lead, aluminium, iron, calcium, magnesium, and sodium, with moisture and combined water.

MR. COLLIER gives an account, in the same journal, of experiments he has made, which seem to point to a new possible source of crystallisable sugar. He finds that the juice of various varieties of fully ripe sorghums contains from 13 to 15 per cent. of sucrose, with 1 or 2 per cent. of glucose.

SPECIAL attention has been recently given to the liquids included in the microscopical pores of certain minerals, and it has been shown by Zimmeler that these pores contain not only water, but also sometimes carbonic acid. Prof. Karpinsky publishes now in the *Memoirs* of the St. Petersburg Society of Naturalists the results of his experiments on the liquid contained in the pores of the Uralian amethyst. The mineral having been broken in a tube filled with mercury, the fluid immediately evaporated, and being brought in contact with a solution of oxide of barium, proved to be carbonic acid (1.07 cubic millimetres at 30°). The pressure under which the carbonic acid was liquefied may be estimated as seventy-three atmospheres, which would correspond to a pressure of a column of water 2,336 feet high.

AT the meeting of the French Academy of May 17, 24, and 31, notes were read by MM. Ditte and Berthelot, on the cold produced by the action of acids on hydrated salts, e.g., hydrochloric acid on hydrated sodium sulphate. The action is regarded as complex: an exothermal chemical reaction occurs in accordance with Berthelot's "law of maximum work," but unless the products of this action are totally insoluble, secondary changes take place; these changes are chiefly conditioned by the amount of heat evolved in the primary action. In the special cases in question the heat disengaged in the chemical change is less than the heat absorbed in the liquefaction of the water of crystallisation which separates from the hydrated salt, hence the sum of the heat changes is negative.

THE densities of chlorine, bromine, and iodine at high temperatures cannot yet be regarded as determined. Victor Meyer, in a recent paper in the *Berliner Berichte*, admits the justice of Crafts' criticism of his determinations of temperature (see *NATURE*, vol. xxi. p. 561, letter by Dr. Armstrong); his latest results give for iodine at about 1,050°, a density equal to 11.2, and at an extremely high temperature (exact numbers not yet given), a density of 4.55, which nearly corresponds with that calculated on the supposition that at this temperature the iodine molecules are entirely dissociated into atoms (calculated number = 4.39). Meyer and Crafts, working by Dumas' method, and using an iodine thermometer, find the density at 1,468° to be 5.05 (calculated for I<sub>2</sub>, 5.83; for I, 4.39). The density for free chlorine seems to be normal (Cl<sub>2</sub>), even at extremely high temperatures; but if the chlorine be produced in the vapour-density

apparatus—by heating platinum chloride—the density at about  $1,400^\circ$  agrees with that calculated for  $\frac{1}{2}\text{Cl}_2$ . Bromine produced by heating platinum bromide in the apparatus gave a density equal to  $\frac{1}{2}\text{Br}_2$  at about  $1,400^\circ$ . Meyer and Crafts published numbers in *Comptes Rendus*, which gave for free bromine at about  $1,400^\circ$ , a density between that calculated for  $\text{Br}_2$  and that for  $\frac{1}{2}\text{Br}_2$ , viz.,  $4.43$  ( $\text{Br}_2 = 5.52$ ,  $\frac{1}{2}\text{Br}_2 = 3.64$ ). Meyer's vapour-density method is somewhat adversely criticised in the last number of the *Berliner Berichte* by Pettersson and Ekstrand, who give numbers which they regard as proving that the method does not give good results at high temperatures when the substance under examination is a solid. Solids, they say, condense on their surfaces considerable quantities of air, and when the solid is thrown into the highly-heated apparatus this air is evolved, is measured with the air representing the volume of the gasified substance, and so vitiates the result. It is certainly worthy of note that both Crafts and Meyer obtained a normal density for chlorine—the only halogen element gaseous before being brought into the apparatus—at the highest temperature at which they experimented. Pettersson and Ekstrand regard Dumas' method as the only altogether satisfactory one; they describe a modification of this process. It is to be remarked that the density of mercury vapour—which chemists generally regard as consisting of atoms—is shown by Meyer's results to be remarkably constant through a large range of temperature.

ALEXR. NAUMANN has arranged Meyer and Crafts' results on the density of iodine vapour in a table (in the *Berichte* for June 14) showing the percentage dissociation of iodine molecules at various temperatures; the results are in keeping with the deduction made by Naumann from the kinetic theory of gases, viz., that equal temperature-intervals correspond to a regularly increasing amount of dissociation up to 50 per cent. but after this to a decreasing amount of dissociation. Naumann regards this agreement between the theoretically-deduced, and the actual results as affording evidence in favour of the correctness of Meyer and Crafts' measurements of high temperatures. This subject is likely to receive a considerable amount of attention, as it has an all-important bearing on the question of the elementary nature of the so-called elements. Deville and Troost, in a recent number of *Compt. Rend.*, estimate the boiling-point of zinc as  $940^\circ$ , which is  $100^\circ$  lower than the number generally accepted on the evidence of older determinations by the same authors.

CHEMICO-PHYSICAL investigation has lately led to some important results. Schneider, in a recent number of the *Berliner Berichte*, has shown that any solution of malic acid containing more than 34.24 per cent. of the acid rotates the polarised ray to the right, whilst a solution containing less than this amount is levorotatory. Solutions of sodium malate are dextrorotatory when of greater strength than 47.43 per cent., but levorotatory when containing less than this quantity of the salt.

SOME little time since Brühl published—also in the *Berichte*—an important paper on the connection between the refraction equivalents and the chemical structure of carbon compounds; he showed that if the refraction equivalents are calculated for a number of carbon compounds, by the help of Cauchy's formula, for a ray of infinite wave-length, a distinct connection can be seen to exist between the numbers thus obtained and the number of "doubly-linked" carbon atoms in the compound. A further communication by the same author appears in a recent number of the same journal. The refraction equivalent of a carbon compound is equal to the sum of the atomic refractions of its constituent elements; the value of the atomic refraction of carbon varies according to the "linking" of the carbon atom—for every pair of doubly-linked carbon atoms present in a compound, the refraction equivalent of the compound is greater by 2 than that calculated by the use of the number expressing the ordinary atomic refraction of carbon. The atomic refraction of oxygen when doubly linked to carbon is 3.29, when in the group OH, or when linked to two atoms, it is 2.71. The atomic refraction of the halogen elements is constant. Brühl concludes that the atomic refraction of a monovalent element is independent of the atom-linking of its compounds, but that this statement does not hold good for polyvalent elements.

IN connection with this work of Brühl, the recent experiments of Prof. Janovsky (*Wien. Akad. Anz.*, June 3) are of interest. According to Janovsky the linking of carbon atoms is of subordinate influence in determining the refraction equivalents of carbon compounds, for isomers with similar linking have unequal refractive indices. In homologous series a similar differ-

ence of refractive indices corresponds to an equal difference of groups only where the series belong to similarly saturated hydrocarbons (alike in position). The refractive power of unsaturated hydrocarbons is greater than that of saturated. Lastly, the author shows that the determination of refraction-coefficients of solid bodies from their solutions is unreliable, as the refractive power depends on the state of aggregation.

IN the *Annals Chim. Phys.* Long shows that a connection exists between the velocities of diffusion and other physical constants, and the composition of various salts; thus the values of the velocity of diffusion, molecular volumes, and electric conductivity, are in the same order for the chlorides, bromides, and iodides of the alkali metals.

STÄDEL publishes in the *Berichte* the first part of an investigation on the vapour-tensions of substituted halogen derivatives of ethane; his researches, which are not however yet completed, seem to show that the increase of vapour-tension for  $1^\circ$  (between 400 mm. and 1,060 mm.) is equal for a bromo-derivative and that chloro-derivative which contains, in place of one bromine atom, two chlorine atoms linked to one carbon atom: e.g.  $\text{CH}_3 - \text{CH}_2\text{Br}$  and  $\text{CH}_3 - \text{CHCl}_2$ ;  $\text{CH}_2\text{Cl} - \text{CH}_2\text{Br}$  and  $\text{CH}_3 - \text{CCl}_2$ , &c.

J. VARENNE continues in *Compt. rend.* his researches on the passivity of iron, which have been already noticed in NATURE. He finds that if a piece of iron be immersed in nitric acid of sp. gr.  $1.325$ , oxides of nitrogen are evolved for a few moments; the escape of gas, however, suddenly ceases; after a time it begins again at one point of the metallic surface, spreads over the entire surface, again ceases, once more recommences, and so on intermittently. If an iron tube be very partially immersed in strong nitric acid, and after passivity is established, the passive part be placed in weaker acid for a time, it is found that by then slowly immersing the tube further in the acid the whole becomes passive, but that this passivity is very easily destroyed, e.g., by shaking the tube. The passivity is less the more dilute the weaker acid, the rougher the metallic surface, and the greater the diameter of the iron tube.

IN the *Berliner Berichte* experiments are detailed by Reinitzer and Goldschmidt, whereby these chemists have succeeded in preparing the compound  $\text{P}_4\text{O}$ , about the existence of which there has been much difference of opinion.  $\text{P}_4\text{O}$  is a reddish-coloured amorphous substance produced by the action of phosphorus, or of zinc, on  $\text{POCl}_3$ .

HOPPE-SEYLER publishes in the *Zeitschrift f. physiol. Chem.* a continuation of his work on chlorophyllan, a crystalline substance closely resembling chlorophyll, obtained from green grass. By treatment with alcoholic potash, chlorophyllan yields, amongst other products, an acid characterised by giving a splendid purple-coloured ethereal solution, which exhibits very marked rose-red fluorescence. For this compound— $\text{C}_{29}\text{H}_{40}\text{O}_5$ —Hoppe-Seyler proposes the name of *dichromatic acid*. The absorption spectrum of the acid in ethereal solution is marked by two bands between C and D, whilst the spectrum of the fluorescent light from the same solution exhibits two bright bands in exactly the same positions.

ACCORDING to Adolf Mayer's experiments described in the *Berliner Berichte*, oxygen has no direct influence on fermentation. The addition of potassium-hydrogen tartrate to a strong syrup containing yeast causes the yeast cells to grow rapidly, and fermentation to proceed with ease.

THE meeting of the French Academy of Sciences, held on July 5, presented some interesting incidents which are not likely to appear in the *Comptes rendus*. A very interesting discussion took place between M. Wurtz and MM. Dumas and St. Claire Deville on the occasion of the presentation of a memoir on the density of vapour of iodine by M. Troost. M. Dumas and M. St. Claire Deville asserted that it was impossible to accept the idea of a dissociation of vaporised iodine at a high temperature, as no permanent alteration resulted from this alleged change in the composition of this substance. M. St. Claire Deville said he was opposed to all theories of molecules and atoms, as science had only to deal with facts, and not with mere assumptions or speculations. It might be supposed that the coefficient of expansion of iodine increased rapidly with increase of temperature. M. Wurtz argued that the diminution of the density was too considerable to be accounted for otherwise than by a *dedoublement* of molecules. All the speakers agreed that these phenomena, which are very curious, should be carefully investigated with

increased attention and care. M. Wurtz having resumed his seat, M. Dumas presented a letter from Mr. Crookes, in which he summarises his theories of radiant matter, and submits them for discussion before the French Academy. After having explained the Crookesian view of the fourth state of matter, M. Dumas added that he felt confident these assumptions would be the occasion of discussions of the same character as that which the Academy had just witnessed.

### PHYSICAL NOTES

HERR DORN of Breslau has published a fresh series of experiments on the propagation of electricity by current water in tubes, and allied phenomena (*Wied. Ann.*, Nos. 4 and 5). In agreement with Helmholtz's theory, he finds the electromotive force from current water in capillary tubes independent of the cross section and the length of these. The value of the "electric moment" of water and glass (3'936 Daniell) deduced from this electromotive force corresponds nearly to that deduced by Helmholtz from Quincke's observations on the propagation of water in glass tubes by the electric current. Observations of the electric current produced by water flowing in capillary tubes lead to a somewhat smaller value. For wider tubes (within pretty wide limits) the current strength, with a given mean velocity of the streaming water, proves empirically to be nearly proportional to the radius of the tube. Traces of a sliding of the water on the glass-wall may perhaps co-operate in producing the variations of electromotive force observed in course of time. Through motion of material particles in a liquid, therefore, an electric current arises.

THE diffusion of salts in aqueous solution has been investigated by Herr Long (*Wied. Ann.*, No. 4), by a method similar in principle to that of Schuhmeister (though different in detail), viz., making a continuous water-current flow over the salt solution and measuring the amount of diffusion by the quantities of salt that pass over in given times. Various interesting relations were found, e.g., the chlorides, bromides, and iodides of the alkali metals form a series, in which  $\text{NH}_4$  stands between K (the higher) and Na; and KCl, KBr, KI, and KCy have nearly the same velocity of diffusion. Such is the case also with the corresponding  $\text{NH}_4$  and Na salts and with the chlorides of the bivalent metals Ba, Sr, Ca, and Mg, the nitrates, and the sulphates. It seems generally that those salts which diffuse most quickly also conduct best in aqueous solution. Salts with large molecular weight and volume seem to diffuse most easily, while among the waterless salts those which absorb most heat in dissolving or (the same thing) whose molecules, through the work done, finally reach the finest state of division, have the greatest velocity of diffusion. The chlorides of the alkalies stand in the same series with regard to molecular volumes, velocities of diffusion, conductivity, and absorption of heat. This is the case, too, with the corresponding bromides and iodides. Cyanide of potassium behaves as to diffusion and conductivity exactly like the chloride, bromide, and iodide of the metal. In the second group (nitrates) the order is the same as to conductivity and diffusion; but with regard to molecular volumes and heat-absorption the salts form a special series. In the group of sulphates the individual salts have the same order as to diffusion and conductivity, but the values for molecular volume and heat of solution are quite irregular; indeed as regards velocity of diffusion and absorption of heat the waterless salts seem to stand in inverse order. These results are fully discussed by Herr Long.

A CURIOUS physical phenomenon has been lately described by Dr. Grassi (*Reale Ist. Lomb. Rend.*, f. viii. and ix.). An apparatus is formed of three concentric vessels with an annular space of about two centimetres between the first and the second, and the second and the third. The outer space is filled with oil, the next with water. The oil is heated by a gas furnace to a little over  $100^\circ$ , and the water boils. Then hot oil, at e.g.,  $150^\circ$  is poured into the central space. This quickly cools to a temperature close on  $100^\circ$ . Dr. Grassi found that the central oil cooled more rapidly the higher the temperature of the outer oil; and with more delicate apparatus (in which the vaporised water was conducted and returned, and the outer oil kept at any required constant temperature) he arrived at definite numerical results, which he tabulates. With the outer oil at a mean temperature of  $129^\circ 9$ , e.g., the time of cooling of the inner oil from  $130^\circ$  to  $110^\circ$  was 45s.; when the former was  $105^\circ 1$ , the latter was 57s. Alcohol and ether gave more decided results. The maximum difference was got with ether; the outer oil being at  $57^\circ 5$ , the inner took

25s. to cool from  $57^\circ$  to  $50^\circ$  (7 degrees); whereas the former being  $39^\circ 3$ , the latter became  $39^\circ 5$ . In all the experiments the cooling of the inner oil commenced at a temperature little above the maximum of the external oil. When the outer oil is at a higher temperature, at a certain point the heat begins to prevail which is transmitted directly from the outer to the inner oil. An analogous phenomenon (to which Dr. Grassi refers) was that of some members of the Accademia del Cimento, who found that water in a vessel surrounded by ice cools more rapidly if the ice be heated to accelerate fusion.

DR. J. PULJ lately communicated a paper to the Scientific Club of Vienna on "Radiant Electrode-matter," in which he traverses the researches of Crookes, Hittorf, Goldstein, and others upon the phenomena of electric discharges in high vacua. He maintains at the outset that the discharges of "radiant matter" observed by Crookes at the negative pole are not residual gas at all, but are particles of metal torn off from the surface of the pole. He thinks this proved by the mirror-like deposits of metal that are formed on objects interposed in the path of the discharge. That aluminium in this way forms no mirror is a difficulty in the way of this theory; but Dr. Pulj gets over this by remarking that the cause of this lies in the chemical constitution of the metal, and that the particles of an aluminium electrode fly round so far that they deposit themselves on the electrode! All the magnetic effects of these discharges Dr. Pulj regards as explainable by ordinary electro-magnetic laws, assuming that a stream of electrified matter acts as an electric current; but he apparently is not acquainted with the theory put forward by Maxwell on this point. Dr. Pulj has also constructed what he calls an *electrode-lamp*, which gives a bright light when worked by an induction-coil capable of affording a spark of 10 cm. length. In this lamp the radiant discharges of electrode-matter are concentrated upon a piece of carbon which glows with a white heat, but remains unchanged and unconsumed.

DR. CUSCO, ophthalmic surgeon in one of the hospitals of Paris, has invented a lens of variable focus, in which the pressure of a column of water or other transparent liquid is made to alter the curvature of the flat faces of a cylindrical cell of brass closed with thin glass disks. The pressure can be regulated by a manometer gauge to any required degree within the limits of working. It is said that the lens gives a sharp, well-defined focus. It is constructed for Dr. Cusco by M. Laurent.

M. HENRI BECQUEREL continues his researches on the magneto-optic properties of gases. He has recently examined the gases oxygen, nitrogen, carbonic dioxide, nitrous oxide, and olefiant gas, and finds that, except in the case of oxygen, the magnetic rotation of the plane of polarisation due to a field of given intensity varies inversely as the square of the wave-length of the ray, as is the case with solids and liquids. In an older research of Becquerel's it was shown that for non-magnetic solids and liquids the rotation  $R$  was proportional to a function of the refractive index  $n$ , very nearly represented by the expression  $n^2(n^2 - 1)$ ; or, in other words, the quantity  $\frac{R}{n^2(n^2 - 1)} = c$ . For all non-magnetic solids and liquids the value of  $c$  lay between 0.26 and 0.59. In the case of gases in which the rotation is but a ten-thousandth part of that of most solids or liquids the same result holds good, and the values of  $c$  for gases fall between 0.26 and 0.59. The above law, that the magnetic rotation is *inversely* proportional to the square of the wave-length, implies that violet rays are more rotated than the red; or, in other words, that there is a positive dispersion. In the case of oxygen it is found that the red rays are rotated more than the green, affording an *inverse* or *negative* dispersion. This is the more curious as oxygen gives a positive rotation as if it were a diamagnetic body. In fact, Becquerel remarks, oxygen behaves as if it were a mixture of a magnetic and a diamagnetic body, the magnetic having small negative rotation and great negative dispersion, the diamagnetic having great positive rotation and small positive dispersion.

### GEOGRAPHICAL NOTES

IN a private letter addressed to Herr von Hesse-Wartegg, the well-known explorer, Dr. Nachtigall, writes from Berlin:—"The German African Society (Deutsche Afrikanische Gesellschaft) has at the present moment not less than six different expeditions travelling through Central Africa. The large funds necessary for the outfitting of these numerous travellers are raised partly

through private subscription, partly through subsidies of the German Government. Among the travellers I may name (1) Dr. M. Buchner, who, starting from San Paolo de Loanda in an easterly direction, may have already reached the large lakes of the Upper Nile or the Upper Congo; (2) Dr. Oscar Lenz, who is on the way from Marocco to Timbuctoo, whence he will proceed to Senegambia; (3) a large expedition, comprising Dr. Böhm, von Schöler, De Kayser, &c., which will establish a station near the Tanganyika lake, in connection with the stations of the International Association; (4) Gerhard Rohlfs and Dr. Stecker will soon proceed to Abyssinia, and thence the latter through the Gallas country to the sea-coast; (5) Dr. Pogge, together with several other travellers, will shortly start from San Paolo de Loanda for the interior, to establish a German station in the neighbourhood of the Muata Janvo, about in the middle of the Continent; finally (6) Herr Fliegel will follow the course of the Binué upwards, and explore the sources of that river." The German African Society has certainly developed under the presidency of Dr. Nachtigall a very unusual activity, and it is only to be hoped that these great efforts in the interest of the exploration of Africa may have good results.

THE French journal *L'Exploration* has much improved recently; its reports of geographical societies in all parts of the world are specially valuable. Its value would be still greater if it would aim at greater originality, and display more enterprise in the collection of news. It rarely gives any authorities for its numerous notes, thus minimising their value; and too much space is devoted to the translation of long articles from the *Times* and other popular sources. This may perhaps render it interesting to the general French public, but greatly detracts from its scientific and international value. However, if it goes on improving in the future as it has done during the last few months, it will ultimately become a really valuable geographical organ.

THE new number of *Le Globe* contains a useful account of geographical work in Central Asia, in 1878-1879, contributed by M. Vannikof.

IN view of the present importance of Asterabad, Her Majesty's Consul opportunely gives a brief geographical description of the province. It is situated in the south-east corner of the Caspian Sea; its inhabitants do not exceed 45,000, and the town can only boast of 8,000 souls. It is bounded on the south by the high range of mountains which separate the Caspian provinces from the other parts of Persia; on the north it is bounded by the Atrak as far as Chat, at the confluence of that river and the Sombak, while beyond that point the position of the boundary is doubtful. The west is bounded by the Caspian Sea and the province of Mazanderan, and in the east it adjoins the province of Meshed. Gez, Molla Kellé and Gumush Téppé are the only ports in use. The province is well-wooded, and is watered by numerous mountain streams. Its inhabitants belong to the Kajar tribe, of which the Shah is the personal head. The fertility of the soil is great, and the timber in the forests is magnificent, but unfortunately there are no roads worthy of the name.

M. BOUTHILLIER DE BEAUMONT, the President of the Geneva Geographical Society, has just published a pamphlet entitled *Choix d'un Méridien Initial Unique*.

THE *Colonies and India* publishes an interesting summary of a plan which Mr. G. J. Morrison, the engineer of the short-lived Woomung railway, has sketched for the restoration of the Grand Canal, which at present is usually impassable in places. The essential point in his scheme is the substitution of proper locks for the wasteful sluices now in use, with of course more extensive works at the crossing of the Yellow River.

THE same paper states that the Legislative Assembly of the Transvaal has before it a measure providing for a trigonometrical and geological survey of the country, in the course of which it is expected that abundant mineral wealth will be proved to exist in the colony.

ON July 13, at the end of the French legislative session, the Minister of Marine and the Colonies presented to the Lower House a credit of 1,300,000 francs for establishing fortified posts from Medina on the Senegal to Bafoulabe on the Niger, on the route which will be followed by the projected railway for connecting these two large rivers. It includes also several other items connected with the same scheme. It was adopted on the same day and voted by the Senate on the 15th, so that

the first step may be said to have been taken for the establishment of the connecting link between Algiers and St. Louis, *via* Timbuctoo.

### PLANTS OF THE COAL-MEASURES

M. RENAULT has recently published a memoir, in which he reproduces the views of M. Brongniart respecting the relations which the *Lepidodendra* bear to the *Sigillaria*, still insisting that the former are cryptogamic Lycopods, whilst the latter are exogenous Gymnosperms. In endeavouring to establish this position, the French palæobotanist concludes that if the exogenous Diploxyloid stems (*i.e.*, Sigillarian ones) are but matured states of some *Lepidodendra*, every Sigillarian type of organisation ought to be found in a young or *Lepidodendroid* form, because, he contends, the type of the central organisation, once established, undergoes no further change with advancing age. In support of his position he affirms that there are three such Sigillarian types, viz. (1) *Sigillaria vascularis*, (2) *Diploxyloid* stems, (3) *Favularia* and *Leiodermaria*. At present he contends that only the second of these forms has been discovered in *Lepidodendron Harcourtii*. He further believes that there are three types of *Lepidodendron* known, represented by (1) *L. rhodumense*, with a solid central vascular axis, in which the vessels are not intermingled with medullary cells; (2) by *L. Harcourtii*, in which the vascular axis is a cylinder surrounding a cellular medulla; and (3) an undescribed plant, which he names *L. Jutieri*, in which the vascular cylinder is broken up into detached bundles of vessels.

The author of the present paper considers that the above conclusions are not in accordance with the facts, and he proceeds to give his reasons for this conclusion by demonstrating that we certainly have two of the three supposed Sigillarian types represented in a young or *Lepidodendroid* state: the first by *Lepidodendron vasculare* of Binney, and the second by *L. Harcourtii*, whilst, judging from M. Renault's own description, the *L. Jutieri* represents the third type. On the other hand, the author believes that of M. Renault's three *Lepidodendroid* types the first is only a young state of the second, as illustrated by the development of the Burntisland and Arran *Lepidodendra* described in previous memoirs, whilst the able Frenchman appears not to have been acquainted with the existence of the very characteristic type of the *L. vasculare* of Binney.

The author gives the series of facts upon which his opinions are based by tracing the history of the development, first, of *Lepidodendron Selaginoides*, the *L. vasculare* of Binney, and second, of *L. Harcourtii*.

Commencing with the declaration that the *Lepidodendron vasculare* of Mr. Binney is but the young state of the *Sigillaria vascularis* of the same author, he proceeds to show the successive stages by which the vasculo-cellular medullary axis of the former becomes not only inclosed within the exogenous cylinder of the latter, but that this cylinder ultimately develops into a very conspicuous example of the Diploxyloid form of stem. The growth of the exogenous cylinder begins at one point of the periphery of the vasculo-medullary axis, from which point it extends both laterally and radially. The exogenous growth thus first appears in the transverse section of the *Lepidodendroid* twig as a small crescent, thickest at its centre, but whose two horns creep gradually round the medullary axis, its constituent vascular wedges also growing radially as the lateral growth advances, until at length the exogenous zone forms a complete ring, inclosing the vasculo-medullary axis, in which state it becomes the *Sigillaria vascularis* of Mr. Binney and M. Renault. The various stages of this growth are represented in the plates, in addition to which a section is described and figured of a branch about to dichotomise, in which process the vasculo-medullary axis has divided into two equal halves, one being destined for each branch. One of these halves of the vasculo-medullary axis displays, with the utmost distinctness, the characteristic crescentic commencement of an exogenous zone, whilst the other half retains its primary non-exogenous state. The latter condition thus belongs to the *Lepidodendron vasculare* of Binney, whilst the former as clearly represents the *Sigillaria vascularis* of the same author, and the Sigillarian character of which is recognised by M. Renault. We thus have in one stem two branches, one of which, according to the views of the French savant, is a Crypto-

"On the Organisation of the Fossil Plants of the Coal-measures. Part XI." Paper read at the Royal Society by W. C. Williamson, F.R.S., Professor of Botany in the Owens College, Manchester. Revised by the Author.

gametic Lycopod, and the other a Gymnospermous Sigillaria. The remarkable peculiarities characterising the central axis of these specimens make it absolutely certain that they all belong to one species of plant.

The typical *Lepidodendron Harcourtii* is then examined in a similar manner. In the details of its organisation it differs materially from *L. Selaginoides*; nevertheless, as its growth progresses, it displays typically similar changes. It attains to much larger dimensions than the latter plant does before developing its exogenous zone, corresponding in this respect with the Arran plant. Its earlier changes are chiefly seen in the rapid development of the bast or prosenchymatous layer of the outer bark and in the increase in the size and number of the vessels constituting its vasculo-medullary cylinder or medullary sheath—the “*dui medullaire*” of Brongniart; but in more advanced specimens a cylindrical zone of centrifugally developed vascular wedges begins to make its appearance in a quasi-cambian zone of the cells of the inner bark, these cells being arranged in more or less regular radiating lines. In this state the rudimentary vascular zone corresponds very closely to what is seen in young stems and roots of Cycads.

The author shows that, contrary to the views of M. Renault, very marked changes take place in the development of the vascular bundles destined for the secondary branches of the plant. In the first instance, each of these is but a concavo-convex segment of the entire vasculo-medullary cylinder, whose detachment leaves a large gap in the continuity of that cylinder, which, however, soon becomes closed again by the convergence of the disconnected ends of the broken vascular circle. The concavo-convex detached segment undergoes a similar change. Its two extremities meet, and before it escapes from the outermost bark it has assumed the cylindrical form of its parent stem.

The rootlets of *Stigmaria ficoides*, now well known to belong alike to *Lepidodendron* and to *Sigillaria*, present some peculiarities of structure which are only found in the Lycopodiaceæ and the Ophioglossæ, amongst living plants.

The vascular bundle in the interior of each Stigmarian rootlet is inclosed within a very regularly circular cylinder, composed of the cells of the innermost bark; but the position of the bundle in relation to the cylinder is always, unless accidentally disturbed, an eccentric one. This position has not escaped notice, but it was regarded as accidental; it now, however, proves to be a normal one. The bundle begins to appear in very young roots, as one or two very small vessels developed in close union with the innermost cells of one side of the cylinder within which it is located; newer and larger vessels are gradually added centripetally, until the bundle occupies a considerable portion of the area inclosed by the inner bark cylinder. The remaining space is usually empty, but occasionally specimens are found in which it is filled with small delicate cells that have escaped destruction. These represent what in the living Lycopods are liber-cells. The outer cortical layer of the root, composed of well-preserved and rather thick-walled cells, is usually separated from the inner cylinder by a similar lacuna; but in a few specimens the cells of this usually destroyed middle bark are retained in good preservation. They consist of very delicate thin-walled parenchyma, separated by a sharp line of demarcation equally from the innermost and outermost cortical cylinders. The number of the vessels in each of the vascular bundles given off from any one section of a Stigmarian root is found to vary but little, but they steadily increase, both in number and size, with the size and age of the root. Young specimens of Stigmarian roots are described, the smallest of which is not more than one-fifth of an inch in diameter, and the vascular bundles of its small rootlets consist each of from three to five minute vessels. In the largest rootlets from old roots they number about forty, most of the additional ones being of larger size; intermediate examples exhibit a regular gradation on all these points.

The only living plants which possess rootlets with this structure being Lycopodiaceæ and Ophioglossæ, and it being sufficiently clear that the *Lepidodendra* belong to the former and not to the latter order of cryptogams, the existence of this Lycopodiaceous feature in the rootlets of *Sigillaria* is another indication of the Lycopodiaceous affinities of these plants.

Many of the Diploxyloid forms of the Lycopodiaceous stems of the coal-measures have an abundant development of spiral or barred cells in their numerous medullary rays. Amongst living plants this characteristic seems to be almost, if not wholly, confined to the Gymnosperms.

Two important additional observations have been made in reference to the structure of the curious strobilus, *Calamostachys Binneyana*. The exact mode of the attachment of its sporangia to the Equisetiform sporangiophores has been ascertained; but what is still more important, it has also been discovered that it is provided with both micro- and macro-spores—an additional indication of its probable Lycopodiaceous affinities, already suggested by other features of the fruit.

The recently discovered Fungi of the coal-measures are investigated, especially the *Pernospores antiquiorum* of Mr. Worthington Smith. The author finds, in the specimens he has examined, including that described by Mr. Smith, no traces of septa in the hyphæ or of zoospores in the Oogonia. He concludes that its affinities are probably with the Saprolegniæ, and not with the Pernosporeæ.

### UNIVERSITY AND EDUCATIONAL INTELLIGENCE

THE Professorship of Zoology in the Royal College of Science, Dublin, is vacant by the resignation of Prof. Bridge. The salary is 200*l.* a year, and at present the professor is only required to lecture during one term, commencing in February and ending in June.

THE University Court of St. Andrews have elected Mr. Arthur Stanley Butler, B.A., of Exeter College, Oxford, to the Chair of Natural Philosophy in the United College, St. Andrews, in the room of Dr. William Swan, resigned.

THE Calendar of the University College of Wales for 1879-80 shows that that institution is fairly well equipped in its various departments, science occupying a prominent place in its curriculum.

AT the end of the Legislative Session the French Chamber of Deputies voted a law establishing free primary education. It must go through the Upper House before becoming a definitive Law of the State.

### SCIENTIFIC SERIALS

THE *American Naturalist*, June.—A. E. Brown and J. D. Caton, the domestication of certain ruminants and aquatic birds. J. S. Lippincott, the critics of evolution (concluded).—C. E. Bessey, the supposed dimorphism of *Lithospermum longiflorum* (the large flowers appear from April to May, the cleistogamous flowers from then until the autumn frosts).—Dr. J. Leidy, on some aquatic worms of the family Naides (describes and figures *Dero limosa*, perhaps = *D. digitata*, Oken; *Aulophorus vagus*, this forms a tube of the statoblasts of a species of *Plumatella*, and *Pristina flagellum*).—W. H. Dall, American work in the department of recent mollusca during 1879.

July.—G. Brown Goode, the use of agricultural fertilisers by the American Indians and the early English colonists (contains some interesting facts about fish manures).—C. S. Minot, sketch of comparative embryology (The Sponges).—O. B. Johnson, the birds of the Willamette Valley, Oregon.—J. F. James, a botanist in Southern California.—J. S. Kingsley, American carcinology in 1879.—A. S. Packard, jun., the structure of the eye of trilobites, with figures; concludes that the hard parts of the eye of the trilobites and of *Limulus* are throughout identical, while the nature of the soft parts of the former must ever remain problematical. There is good evidence that the retinal mass was like that of the king-crab; if so these forms as to their eye-structure will stand near each other and far apart from all other arthropods.

THE *Journal of the Royal Microscopical Society*, June, contains: Prof. Duncan, on a parasitic sponge of the order Calcarea (Plate 10), *Mobiusispongia parasitica*, growing within *Carpenteria raphidodendron*, from the reefs of Mauritius.—Dr. Cooke, on the genus *Ravenelia* (Plate 11).—Dr. H. Gibbes, on double and treble staining. An excellent suggestion is incidentally made by Dr. Gibbes, that the covering glasses used by microscopists should be of a known thickness. We would even go further, and advise that a fixed scale of thickness might be adopted. Dr. Gibbes uses two thicknesses, '006 and '004.—Dr. A. Grunow, on some new species of *Nitacchia* (Plates 12 and 13).—James Smith, on the illumination of objects under the higher powers of the microscope.—The most useful record of current

studies relating to invertebrates, cryptogams, &c., is condensed as usual.

THE *Revue des Sciences Naturelles*, June 15, contains: M. de Meuse, description of two new crustacea, male and female, of the genus *Dinemoura* (*D. mustela levis*) (Plate 1). The figures are copied from living specimens; the species lives not in the interior of the shark, but on its skin, and its mode of fixation is minutely described.—M. Duval-Jouve, on the species of *Vulpia* he found in France.—D. A. Godron, on the giant maize (*Zea mays* agavea).—M. Rietsch, on Bobretzki's studies on the formation of the blastoderm and germinal lamellæ in insects.—A. Villot, on the synchronism of the marls and clays with lignite of Hauterives in the group of St. Ariès.—M. S. Jourdain, on a very simple method of the group of worms *Prothelminthus hessi* (S. J.)=? *Inusia leptolana*, Giard (Plate 2).—Scientific review of recent French writings on zoology, botany, and geology.

SOCIETIES AND ACADEMIES  
LONDON

Royal Society, June 17.—“On the Spectrum of the Flame Hydrogen,” by William Huggins, D.C.L., F.R.S. Messrs. Living and Dewar state, in a paper read before the Royal Society on June 10, that they have obtained a photograph of the ultra-violet part of the spectrum of coal gas burning in oxygen, and in a note dated June 8 they add that they have reason to believe that this remarkable spectrum is not due to any carbon compound but to water.

Under these circumstances I think that it is desirable that I should give an account of some experiments which I made on this subject some months since without waiting until the investigation more complete.

On December 27, 1879, I took a photograph of the flame of hydrogen burning in air. As is well known, the flame of hydrogen possesses but little luminosity, and shows no lines or bands in the visible part of the spectrum, except that due to sodium as an impurity.

Prof. Stokes, in his paper “On the Change of Refrangibility of Light,” had stated that “the flame of hydrogen produces a very strong effect. The invisible rays in which it so much abounds, taken as a whole, appear to be even more refrangible than those which come from the flame of a spirit lamp.” I was not, however, prepared for the strong group of lines in the ultra-violet which, after an exposure of one minute and a half, came at upon the plate.

Two or three weeks later, about the middle of January, 1880, I showed this spectrum to Prof. Stokes, and we considered it probable that this remarkable group was the spectrum of water. Prof. Stokes permits me to mention that, in a letter addressed to me on January 30, he speaks of “this novel and interesting result,” and makes some suggestions as to the disputed question of the carbon spectrum.

I have since that date taken a large number of photographs of the spectra of different flames, in the hope of being able to present the results to the Royal Society, when the research was more complete. I think now that it is desirable that I should describe the spectrum of the flame of hydrogen, but I shall reserve for the present the experiments which relate to the presence of carbon and its compounds.

The spectrum of the flame of hydrogen burning in air is presented in the diagram. It consists of a group of lines which terminates at the more refrangible limit in a pair of strong lines,  $\lambda$  3062 and  $\lambda$  3068. At a short distance in the less refrangible direction, what may perhaps be regarded as a group proper commences with a strong line,  $\lambda$  3090. Between the strong line  $\lambda$  3068 and the line  $\lambda$  3090 there is a pair less bright,  $\lambda$  3080. Less refrangible than the line  $\lambda$  3090 are finer lines at about equal distances. The lines are then fine and near each other, and appear to be arranged in very close pairs. There is a pair of fine, but very distinct lines,  $\lambda$  3171 and  $\lambda$  3167. In this photograph the group can be traced to about  $\lambda$  3390. This group constitutes the whole spectrum, which is due probably to the vapour of water.

I then introduced oxygen into the flame, leaving a small excess of hydrogen. A spectrum in all respects similar came out upon the plate. I repeated the experiment, taking both spectra on the same plate. Through one-half of the slit the spectrum of the oxyhydrogen flame was taken. This flame was about 7

inches long, and the spectrum taken of a part of the flame 2 inches from the jet. The oxygen was then turned off, and the quantity of hydrogen allowed to remain unaltered. A second spectrum with an exposure of the same duration was then taken through the second half of the slit. On the plate the two spectra are in every respect similar, and have so exactly the same intensity that they appear as one broad spectrum.

In all these experiments a platinum jet which had been carefully cleaned was used.

In these experiments the two gases met within the blowpipe and issued in a mixed state.

The jet was removed, and a flame of hydrogen was surrounded with oxygen. This spectrum shows some additional lines. In this case the jet was brass, and in this or some other way impurities may have been introduced; and I should at present incline to the view that the additional lines about  $\lambda$  3429 and  $\lambda$  3473, and the groups more refrangible than  $\lambda$  3062, do not belong to the water spectrum, but to impurities.

Coal-gas was substituted for hydrogen in the oxyhydrogen blowpipe, and oxygen admitted in as large a proportion as possible. The inner blue flame rising about 2 inches above the jet showed in the visible part of the spectrum the usual “five-fingered spectrum.” The light from this part of the flame was projected upon the slit. The spectrum contains the water group already described, and in addition a very strong line close to G, and two lines,  $\lambda$  3872 and  $\lambda$  3890; this latter line is seen to be the more refrangible limit of a group of fine lines shading off towards K.

The ultra-violet group, when carefully compared with the group in the spectrum of pure hydrogen, shows several small

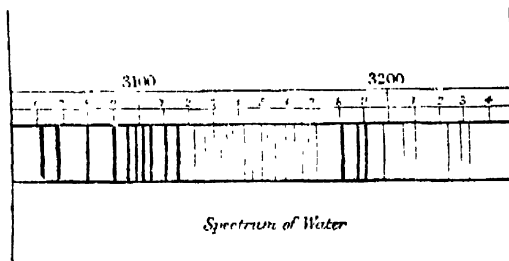

differences. I am inclined to believe that there is the supposition of a second fainter group. There is strong evidence of this in some spectra of hydrogen taken under other conditions. There is also a broad band less refrangible than the strong line at G, and the light extends from this line on its more refrangible side.

A double Bunsen burner (Fletcher's form) with a strong blast of air was then fitted up. The spectrum was taken of the intense blue flame. It resembles the one last described. All the distinctive features are intensified, and a continuous spectrum and groupings of very fine lines fill up all the intervals between the groups already described, so that there is an unbroken strong spectrum throughout the whole region which falls upon the plate.

A spirit lamp was arranged before the slit. The spectrum is essentially the same as when coal-gas is burned, but as it is less intense only the strongest lines are seen. The water group, the strong line at G, and the pair of lines rather more refrangible than K, are seen. Probably with a longer exposure the finer lines would also show themselves.

The distinctive features of the spectra of coal-gas and of alcohol appear to be connected with the presence of carbon.

Table of Wave-lengths of the Principal Lines of the Spectrum of Water. No. 1.

3062	3095	3135	3171	3217.5
3068	3099	3139	3175	3223
3073	3102	3142.5	3180	3228
3074	3105	3145	3184	3232
3077.5	3111	3149.5	3189	3242.5
3080	3117	3152.5	3192.5	3252.5
3082	3122.5	3156	3198	3256
3085	3127	3159.5	3201	3262
3090	3130	3163	3207.5	3266
3094	3133	3167	3211	3276

## Wave-lengths of other Lines in the Spectra described above.

2869'5	2910	2947	2991	3031
2872'5	2913	2951	2994	3039
2876	2917'5	2955	2999	3042
2880	2922'5	2959	3002	3046
2883	2925'5	2966	3005	3051
2887'5	2929	2967'5	3010	3057'5
2892	2932'5	2970'5	3013	3246
2895	2935'5	2975'5	3017	3271
2897	2940	2981	3019'5	3429'5
2904	2943	2989	3029	3473
2907'5				
3872	3890	4310		

## EDINBURGH

**Royal Society, June 7.**—Prof. Fleeming Jenkin, vice-president, in the chair.—The Council having awarded the Keith prize for the biennial period 1877-79 to Prof. Fleeming Jenkin for his paper on the application of graphic methods to the determination of the efficiency of machinery, the medal was presented to him by Prof. Balfour.—At the request of the Council Prof. Chrystal gave an address on non-Euclidian geometry, and discussed in a most masterly and lucid manner the consequences which the non-acceptance of Euclid's axiom of parallels involved. Defining a straight line as the curve completely determined by two points, the lecturer pointed out that there were three simple cases that called for discussion: first, the case where two straight lines cut in one point only and are infinite in extent; second, the case where two lines still cut in but one point, but each line is finite in length returning into itself; and third, the case where two straight lines cut in two points. Some of the peculiar properties of these three kinds of space, which might be called hyperbolic, single elliptic, and double elliptic space, were demonstrated, and many others pointed out, while Euclidian or homoloidal space was shown to be a limiting case of either hyperbolic or elliptic space.—Prof. Tait communicated a note on the theory of the 15 puzzle, in which he gave a rule for determining whether or no a particular arrangement could be solved.—Mr. de Burgh Birch, M.B., C.M., read a detailed paper on the constitution of adult bone matrix and the functions of osteoblasts.—Mr. Robert Gray exhibited two eggs of the Great Auk (*Alca impennis*), and read a short graphic account of the extinction of that bird within the present century.—Prof. Chrystal exhibited a new form of telephone receiver which was simply a fine wire, whose extension and contraction under the influence of the heating and cooling caused by the varying intensity of the current through the microphone transmitter were sufficient to communicate musical notes to a vibrating membrane. Mr. Blyth's recent communication to the Society, together with certain observations of his own on the rapid cooling and heating of thin wires which he had made several years before, had suggested the arrangement as one likely to succeed.

## PARIS

**Academy of Sciences, July 12.**—M. Edm. Becquerel in the chair.—The following papers were read:—Observations of the comet  $\delta$  1880 (Schaberle) made at Paris Observatory, by MM. Tisserand and Bigourdan.—On the pendulum, by M. Faye. He announces a new apparatus with which M. Govi's system (see below) and others may be studied. The reductions are limited almost exclusively to temperature.—Observations on the density of iodine vapour, by M. Berthelot. The increase of total energy of the halogen gases with the temperature, as also that of the *vis viva* of translation, exceed those of the three other simple gases hitherto studied (nitrogen, oxygen, and hydrogen); the two orders of effects seem correlative.—On the heat of formation of hydrocyanic acid, and of cyanides, by M. Berthelot.—Densities of vapour of selenium and tellurium, by MM. Sainte-Claire Deville and Troost. This gives details of operations in 1863.—On the etiology of anthrax, by M. Pasteur. Putrefaction of the animal's body destroys the parasite, but some infected blood and other liquid matter escapes into the ground about the body, and there germs may be produced and remain with latent life for years, ready to communicate anthrax on opportunity. Curiously, the bacteridium-germs may be found in the surface-earth over the body, and they appear to come thither by agency of earth-worms, carrying them in their alimentary canal. The dust of this earth, with the worms' excrement, gets blown about the plants, which the cattle eat, and are thus infected. Germs of other diseases may perhaps be conveyed similarly.—

Ammonia of the air and of water, by M. Lévy. *Inter alia* contrary to what is observed in meteoric waters, it is in the season that ammoniacal nitrogen seems to be most abundant in the air. The annual averages in the case of meteoric waters are nearly identical.—Alternance of generations in some Uredineæ by M. Cornu.—New theorems on the indeterminate equation  $ax^4 + by^4 = z^4$ , by M. Pepin.—On some remarks relative to the equation of Lamé.—New method for determining the length of the simple pendulum, by M. Govi. A pretty long, light, rigid rod is suspended by one end from a horizontal axis, and heavy runner, with centre of gravity in the axis of the rod, fixed at different points, and the pendulum set oscillating vacuo on solid supports.—Rapid synthetic method of establishing the fundamental formulæ relative to change of state, by Viry.—On the constitution of matter and the ultra-gaseous state by Mr. Crookes.—On monochromatic lamps, by M. Lauri. *Apropos* of M. Terquem's note, he recalls his modifications of gas-burners and his æolipyle.—Telephonic effects resulting from the shock of magnetic bodies, by M. Ader. Any mechanical action which disturbs the state of molecular equilibrium of a magnetic core has the effect of developing, when this core suddenly regains its equilibrium, an electric current capable of affecting the telephone.—On the fluorised compounds of uranium by M. Ditte.—On the atomic weight and on some characteristic salts of scandium, by M. Nilson. Atomic weight, 44.—Ultimate action of bromine on malonic acid; bromoform, by M. Bourj.—On the etherification of sulphuric acid, by M. Villiers.—Oviposition of *Pleurodeles wallisii*, by M. Vaillant.—Salivary glands in the Odonates (Neuroptera), by M. Poletiaeu. T. glands exist in all the species (though they are denied by entomologists).—Action of high and moist temperatures and of chemical substances (benzoate of soda, benzoic acid, sulphuric acid) on germination, by M. Heckel. Seeds of *Brassica* sown in a wet sponge and kept at 48° showed numerous radicles in less than twelve hours (while seeds kept in water at 48° did not germinate). After emitting their radicles the seeds stop but they developed quickly when the temperature was brought down to 20° or 17° 5'. The three chemical agents suspended germination of various seeds.—Action of strychnine in strong dose on mammals, by M. Richet. It acts somewhat curare and somewhat like chloral.—Alterations of the nerves of the anterior and posterior nerve-roots and of cutaneous nerves in a case of generalised congenital ichthyosis by M. Leloir.—On immunity against anthrax, acquired, the preventive inoculations, by M. Toussaint.

## CONTENTS

VICTORIA UNIVERSITY	.....
ON THE RELATION BETWEEN THE MOLECULAR WEIGHTS OF SUBSTANCES AND THEIR SPECIFIC GRAVITIES WHEN IN THE LIQUID STATE. By Prof. T. E. THORPE, F.R.S. (With Diagram)	.....
GORDON'S "ELECTRICITY AND MAGNETISM"	.....
STRATIGRAPHICAL GEOLOGY	.....
OUR BOOK SHELF:—	.....
Garnett's "Treatise on Elementary Dynamics, for the Use of Colleges and Schools"	.....
Alexander's "Elementary Applied Mechanics"	.....
LETTERS TO THE EDITOR:—	.....
The Recent Gas Explosion.—S. TOLVER PRESTON; Sir J. FAVERE F.R.S.	.....
The Try Bridge.—G. M.	.....
"Geology of the Henry Mountains."—ROBERT MALLETT, F.R.S.	.....
Intellect in Brutes.—W. W. NICHOLLS	.....
The Volcanic Dust from Dominica.—M. E. WADSWORTH	.....
Large Meteor.—F. C. PENROSE	.....
Ball Lightning.—W. F. SMITH	.....
THE RECENT EXPLOSIONS	.....
NORTH AMERICAN GEOLOGY—IDAHO AND WYOMING. By Prof. ARCHIBALD GEIKIE, F.R.S.	.....
THE RUSSIAN IMPERIAL YACHT "LIVADIA" (With Illustrations)	.....
NOTES	.....
OUR ASTRONOMICAL COLUMN:—	.....
The Comet of 1868	.....
Variable Stars	.....
BIOLOGICAL NOTES:—	.....
The Evolution of Dibranchiate Cephalopods	.....
On a Case of Apparent Insectivorous Intestinal Worms in the Horse	.....
The Domestication of Deer	.....
The Fiddler Crabs	.....
Organs of Deep-Sea Animals	.....
CHEMICAL NOTES	.....
PHYSICAL NOTES	.....
GEOGRAPHICAL NOTES	.....
PLANTS OF THE COAL-MEASURES. By Prof. W. C. WILLIAMS, F.R.S.	.....
UNIVERSITY AND EDUCATIONAL INTELLIGENCE	.....
SCIENTIFIC SERIALS	.....
SOCIETIES AND ACADEMIES	.....



THURSDAY, JULY 29, 1880

## CHEMICAL DYNAMICS

*Essai de Mécanique Chimique fondée sur la Thermochemie.*  
Par M. Berthelot. Two Vols. (Paris : Dunod, Editeur,  
1879.)

THE problems which the chemist attempts to solve may be broadly divided into two groups. In studying the heterogeneous distribution of molecules, the chemist finds that new relations of molecules, in other words, new substances, are produced; he must study the composition and properties of these substances. He also finds that these changes involve a consideration of the relative positions of the changing body and of other bodies, that is to say, he recognises the action of force. He must endeavour to determine the laws of action of this force. The study of the properties and composition of substances has received more attention than that of the general laws of chemical force; both methods of investigation must, however, be applied to chemical phenomena, before these can be fully explained.

The general properties of a compound may be regarded as depending chiefly on the composition of that compound, or chiefly on the function or "power of doing" of the compound. There have always been schools of chemistry which paid most attention to composition, as there have been schools which made function pre-eminent. Modern chemistry is attempting to connect both in a general scheme of classification; whilst at the same time she endeavours to learn the conditions under which chemical force is exerted, and hopes thus to elucidate general laws.

The atomic theory, which is one great outcome of the study of the composition and function of chemical substances, has of late years been merged in the wider molecular theory of matter.

This theory, assuming the existence of a grained structure in matter, proceeds to deduce, by dynamical reasoning, the amount of motion existing among these little parts of which matter is built up. The laws of Boyle and Charles are among the primary results of this deduction. But under certain conditions gases do not exactly obey these laws; hence the theory asserts that under certain conditions the molecules exert mutual action.

Another deduction from the theory is the statement usually known as Avogadro's law—"Equal volumes of gases at the same temperature and pressure contain equal numbers of molecules." This statement provides the chemist with a means for determining molecular weights. But the chemist in applying Avogadro's law is obliged to admit that in many reactions the parts of molecules really part company. He attempts to picture to himself this molecular splitting.

Let the molecule A consist of two parts,  $a$  and  $b$ , the molecule B of two parts,  $c$  and  $d$ ; let these parts be in motion. Under certain conditions the stress between  $a$  and  $c$  and the stress between  $b$  and  $d$  may be greater than that between  $a$  and  $b$ , and  $c$  and  $d$ ; the original molecules are decomposed, and new molecules, C and D, are formed. The stress between  $a$  and  $c$  considered from the

point of view of  $a$  or  $c$  alone is a force exerted by  $a$  on  $c$  or by  $c$  on  $a$ . This force is the force of chemical affinity.

The result of the action of this force is a new configuration of the system AB; the energy of the new system, C D, will be different from that of the original system.

Chemical action, thus regarded, is a re-arrangement of parts of molecules under the influence of the force called affinity. Chemical energy is thus regarded as potential energy.

Now a chemical action between A and B will take place under certain definite conditions only, hence although the absolute value of the affinity of A for B may be a constant, the course of the change and the entire result of the change will nevertheless be largely dependent on physical conditions. No force may be exerted except at high temperatures; the change of momentum of A will depend on its position relative to B; the relative positions at which this change occurs may only be gained at high temperatures. The force exerted may be small; still if a chemical change occur at all, there must be an action between the parts of A and the parts of B.

Now let this mutual action begin, let no energy be added to the system from without, but let the system as a whole lose energy; the energy so lost may be measured in the form of heat. But more than one re-arrangement of the parts of two molecules may frequently be possible; which will be produced? A system is in equilibrium when its entropy (using the term in the Clausian sense) has reached a maximum. Hence that system whose entropy is the greatest of the entropies of the possible systems will be produced.

This is substantially Berthelot's "law of maximum work," a law which lies at the foundation of his system of thermal chemistry. But a system not marked by possessing the largest amount of entropy of all the possible systems, may nevertheless be the most stable under the experimental conditions; the stability will depend on pressure, temperature, relative masses, &c. Hence in order to determine the actual result of a chemical action, the conditions of stability, in other words, the relations to temperature, pressure, &c., of the various possible products of the reaction must be known. The necessity of this knowledge is insisted on by Berthelot. To determine, therefore, the product of a given chemical action one must measure the quantities of heat evolved in the passage of the system from the standard state to each of the possible new states, and one must know the conditions of existence and stability of each of these states. This problem therefore presents both a chemical and a physical question for solution. The solution of the chemical question is much aided by a knowledge of the laws of atom-linking; but these cannot be here considered.

A measurement of the heat evolved in a chemical change evidently enables us to find the difference between the energy of the original and final chemical systems; the total heat change being independent of intermediate states through which the system may pass. So if work is done on a chemical system whereby it is caused to assume a new configuration, this work measures the energy transferred from the initial to the final system; in this case heat will be absorbed during the chemical change.

But in actual chemical reactions the action of the chemical force proper will be interfered with and complicated by physical, or secondary forces. So much is this the case, that for many years these actions were not distinguished.

One school simply measured the quantity of a substance A, which was needed to act on B to produce C; the greater the quantity of A required to act on a given weight of B, the greater was the affinity of A for B. With this school all was chemical. With Berthollet, on the contrary, all was physical; but facts have been discovered since the publication of the "Statique Chimique" which have necessitated a reconsideration of his laws.

Gradually the meaning of affinity has been made clear. The greatest contribution towards this end is undoubtedly the papers of Guldberg and Waage, whose work has been sketched by the present writer in this journal (vol. xx. p. 530). The Swedish naturalists disregard the action of secondary forces in their method of determining the ratios between the affinity coefficients of various substances.

The importance of a measurement of the change of energy accompanying the passage of a chemical system from one specified state to another; the importance, in other words, of a measurement of the heat evolved or absorbed in such a passage, is at once apparent. But this measurement—even taken along with a general knowledge of the conditions of existence of the various possible systems—does not enable us certainly to predict the result of the chemical action. If we had a complete knowledge of the mode of variation of the potential energy of a system with changes in the configuration of the system, then it *might* be possible for mathematicians to predict all possible arrangements of the system under the action of specified external forces. But having made heat measurements only, we are very far indeed from this point.

Indeed the fundamental assumption that chemical energy is wholly potential, and depends on the arrangement of the parts of a system, may be false; and even if this assumption be true we know nothing as yet of the relation between this energy and the configuration of the system.

The heat absorbed or evolved in a chemical change measures the total work done by the system in its passage from one specified state to another, but it is evident that it does not directly measure the true force of affinity. The stress between the parts of two molecules may be small, yet under certain conditions a chemical change may occur; the loss of energy in the formation of the new system may be considerable, and hence the heat evolved, considerable. Chemical affinity thus regarded is a kind of liberating force.

For the measurement of the ratios of the affinities of various systems, Guldberg and Waage's method is to be preferred to the thermal method of Berthelot. For a full consideration of chemical equilibrium Berthelot's method is altogether insufficient, although it has *largely* advanced the solution of this problem.

The method of Willard Gibbs seems the only feasible one in the present state of the chemical and mathematical sciences. In this method (see NATURE, vol. xxi. p. 516) the energy and entropy of a system are considered—the stability of a system depends on the component masses,

volume, and entropy (the *magnitudes* of the system); and on the temperature, pressure, and *potential* (the *intensities* of the system).

The stability of a system is chiefly dependent, according to Berthelot, on the amount of heat evolved in the passage to the given state from an initial state, and on the general properties of the given system as compared with other possible systems. This is evidently a much cruder statement than that of Gibbs. Berthelot's principle of maximum work is indeed one among many deductions made by the method of the American professor.

Both methods lead to a recognition of chemical equilibrium as an outcome of chemical action; the conditions of the latter are considered before those of the former; chemical kinetics precedes chemical statics. The usual method of the text-books is to make chemical equilibrium all-important, and barely to mention the subject of chemical kinetics.

It is evident that the time when it will be possible to treat chemical problems by a purely dynamical method is yet distant. The method of Gibbs leads the way in bringing chemical generalisations under the domain of the principles of energy, and it does this without assumptions about the action of the parts of molecules; the method is a thermo-dynamical one.

Berthelot's method, on the other hand, is thermo-chemical; but a thermo-chemical method seems to promise the largest development in the present state of the science.

Berthelot perhaps claims too much for his method: in his great work he is not always definite in his use of such terms as "force," "affinity," "energy," "work;" nevertheless the "Essai de Mécanique chimique" is undoubtedly a great work. To Berthelot (and to Thomsen) is due the honour of having steadily pursued the thermo-chemical method for many years, and of having collected masses of most important facts; and he has now enriched chemical science by the publication of these results in a collected and systematic form, in a treatise full of original ideas and suggestive of almost unlimited topics for future work and discussion. What a field of work is opened before one in this book! To determine that this body is produced by the action of these bodies is not enough; indeed it is scarce a beginning. Chemical science has higher aims. The changes of energy which accompany changes of configuration of matter must be measured; the physical and chemical constants of all the products of a chemical change must be determined with care, the velocity of the change must be measured, and an attempt must be made to apply dynamical reasoning to the results thus obtained.

The first volume of the "Essai," entitled "Calorimétrie," begins with general remarks on thermo-chemical work, and on affinity; after laying down certain general theorems concerning chemical reactions, and illustrating the application of these in the formation of insoluble and soluble salts, the formation of series of carbon compounds, &c., a detailed account is given of experimental calorimetric methods; this is accompanied by numerous tables of specific heats, heats of combination, heats of solution, heats of formation of salts in solution, heats accompanying isomeric changes, &c. The second volume—entitled "Mécanique"—is concerned with a

study of the conditions which determine chemical changes. This general study divides itself into two branches: chemical decompositions and recompositions—included under the title of “Dynamique Chimique”; and secondly those final distributions of matter which result from reciprocal actions between simple or compound bodies, grouped together as “Statique Chimique.” Would it not have been better to have entitled the general subject “Chemical Dynamics,” and the branches “Chemical Kinetics” and “Chemical Statics” respectively?

It would obviously be impossible to give here even an outline of Berthelot's treatment of this immense field of work; one or two instances must suffice.

The two fundamental generalisations of the French chemist have already been mentioned. Let us turn to his treatment of the specific heats of elementary bodies and of chemical equilibrium.

Berthelot refuses to accept the law of Dulong and Petit as applied to solid elements. He says that the actually-determined specific heats of the elements vary much with temperature, and that the products of these numbers into so-called atomic weights are of very different values. He gives a list of 11 elements, the specific heats of whose equivalents is about 6.4; and a list of 31 for which the product of specific heat into equivalent weight is about 3.2.

This result well illustrates what will probably be regarded by most chemists as a fundamental error on the part of the author of the “Essai”; Berthelot is still to be classed among the staunch supporters of the system of notation founded on equivalents. In this country we have no such phenomenon as a great chemist who writes the formula of nitric acid  $AzO_6$ . Nevertheless Berthelot's thermal chemistry is founded on a molecular theory. He constantly speaks of molecules and of action between the parts of molecules; he also speaks of the architecture of atoms, and seems to regard the modern atomic theory as utterly opposed to such an idea.

“The kinetic energy of the molecule may be regarded as made up of two parts—that of the mass of the molecule supposed to be concentrated at its centre of mass, and that of the motions of the parts relative to the centre of mass. The first part is called the energy of translation, the second that of rotation and vibration. The sum of these is the whole energy of motion of the molecule. The pressure of the gas depends on the energy of translation alone. The specific heat depends on the rate at which the whole energy, kinetic and potential, increases as the temperature rises.” (Clerk Maxwell, *Chem. Soc. Journ.*, 13, 502.)

In the present state of our knowledge of the internal motion of the parts of a molecule it is impossible to determine satisfactorily the ratio of the two parts of the energy of the molecule, and it is extremely difficult to reconcile the observed with the calculated ratios of specific heats.

Nevertheless, if we adopt the mean numbers found for the specific heats of the solid elements and multiply these into the maximum atomic weights as determined by the aid of Avogadro's law, we get a result which is too constant to be merely accidental. Taking Kopp's numbers, calculated from specific heats of compounds, for those elements which have not yet been obtained in the solid form, we find that the product of specific heat

into atomic weight (*not equivalent weight*) is about 6.4 for forty-four elements, about 5.5 for ten elements, less than 5 for two elements, and is yet unknown for eight elements. Furthermore we find that the specific heats of the elements are fairly constant, provided they be determined for a temperature-interval known to be considerably below the temperature of fusion of the elements.

We seem, therefore, fully justified in accepting the law of Dulong and Petit as an empirical statement of very considerable value, although not as a final statement of the connection subsisting between the ratio of the two parts of the energy of the elementary molecules, and the relative weights of the parts of the same molecules.

In treating the subject of chemical equilibrium Berthelot first of all examines processes of chemical combinations in general, and contrasts these with processes of decomposition; he then studies those changes which are made up of two parts—a direct and reverse—and which are characterised by the attainment of a limit dependent on conditions of temperature, pressure, relative masses, &c. The chemical equilibrium thus established he divides into two kinds: equilibrium of homogeneous bodies, *i.e.*, when the original and final substances are all liquid or gaseous and capable of complete admixture during the course of the change; and equilibrium of heterogeneous bodies, *i.e.*, when some of the substances are solid and some liquid, or some liquid and some gaseous, or when all are liquid or gaseous, but are nevertheless incapable of complete admixture. Examples are given of each kind of equilibrium, and of the conditioning influence of temperature, pressure, mass of solvent, contact with other substances, relative masses of reacting bodies, chemical functions of reacting bodies, velocity of the change, &c. The phenomena of equilibrium of heterogeneous systems lead to a discussion of dissociation; this to a consideration of precipitation, and thence to an instructive chapter on the state of salts in solution, and the meaning of the terms “feeble” and “strong” as applied to acids and bases.

Although, in considering Berthelot's treatment of chemical equilibrium, one misses the bold and fascinating results obtained by Gibbs in his great paper on the “Equilibrium of Heterogeneous Substances,” and the exactitude and simplicity of the beautiful theory of Guldberg and Waage, and although one cannot but much regret that he should not have written his formulæ and equations in a language more easily understood by the chemist of to-day, one must nevertheless admire the breadth of view, the felicity of illustration, and the suggestiveness of the work of the French chemist.

The publication of the “Essai” marks an important point in the advance of modern chemistry: it comes to the chemist with the message, amongst others, that his science demands more than the stereotyped so-called original investigation, in which are detailed a few properties of a number of new compounds produced by methods long ago marked out and defined; it tells him that he must revise and advance his methods, that he must try to explain his facts by appeal to principles, that he must not be afraid to strike off the beaten path into the by-ways of research, and that there is more to be hoped

for in a bold impatience than in the "Smooth diffused tranquillity of heartless pains."

M. M. PATTISON MUIR

### A JAPANESE ROMANCE

*Chiushingura, or the Loyal League; a Japanese Romance.*  
Translated by F. V. Dickins, B.Sc., of the Middle Temple, Barrister-at-Law. (London: Allen and Co., 1880.)

THIS book is one of great value and interest, both from a purely literary and from an anthropological point of view, and further as yielding a most instructive lesson in the meaning of Japanese pictorial art. Mr. Dickins is well qualified for the task which he has performed, being not only a practised Japanese and Chinese scholar, but a man of very wide attainments in various branches of natural science, and he has been able to supply a series of most valuable explanatory notes in the appendix of his work. It may be mentioned that he commenced his career by graduating in science and medicine at the University of London, and that after having served for some years as a surgeon in the navy he was called to the bar, and practised his profession for many years at Yokohama, where, by constant study, he became deeply versed in all that pertains to Japanese life and customs.

The present work is illustrated by the actual Japanese woodcuts with which the Japanese edition of the historical novel of which it is a translation is embellished. The woodcuts were printed in Japan by native workmen, and are now bound up with the English text. The reader is therefore able to form an exact conception of the ideas which the Japanese artist has intended to convey in the twenty-nine pictures which the work contains. It is most interesting to all who are in any way attracted by Japanese art to realise the mode in which the emotions, such as rage and despair, laughter and pain, are depicted, and to join as it were in a Japanese game of blind-man's-buff. The "Chiushingura, or Loyal League," is an historical romance which embodies the history of the forty-seven Ronin so well known from Mr. Mitford's account of it in his fascinating "Tales of Old Japan." The present romance is one of the most popular and best known in Japan, or rather was so, for its main object is to glorify "Chiushin," or loyal-heartedness, the supreme virtue of the Bushi class under the old order of things that passed away with the year 1868. Disloyalty was considered to be the meanest of crimes, rendering the person guilty of it unworthy of existence, and the Japanese self-despatch, seppuku, which occurs abundantly in the romance, was a self-inflicted atonement for this crime, and in no sense a mere ignoble suicide.

The action of the romance is laid in the fourteenth century, although the events on which it is founded really occurred at the beginning of the eighteenth, the author having been compelled to disguise barely the reality by diluting the history with a certain amount of fiction, and altering names and dates so as to evade the law which, under the Shogunate, attached severe penalties to the publication of recent or current events of a public character.

We cannot detail the plot of the story, but will give a few extracts. A highway robber after murdering an old

man soliloquises thus as he kicks the body aside: "Wretched piece of work. Well, I am sorry for it. I did not do it out of any malice, but you see you had money, that killed you. No money, and you'd be alive now. Your money was your enemy. I can't help pitying you. Which prayer are you for? Namu amida butsu, or Namu miyôhô renga-kiyô? Choose one, and let all end." The prayers are Buddhist, the words being Sanskrit ones which have undergone much Japanese alteration.

The story closes with the account of the attack of the forty-seven Ronin on the castle of Maronhao, the murderer of their lord Yenya (by "murderers" being meant the persons who compelled Yenya to perform seppuku). Their mode of proceeding is very quaint. In the very heat of the attack, just as they burst into the dwelling of their victim, the leader of the expedition, in true style of a Japanese general, calmly seats himself on a camp-stool and gives his orders. The neighbours on either side are roused by the noise and send their retainers to see what is going on. "Ya ya," they cry, "what means all this uproar and confusion, clashing of weapons and hurtling of arrows? Are you attacked by rioters or by robbers, or has a fire broken out somewhere? We have been commanded to find out what is going on, and inform our masters of the cause of disturbance." The Ronin answer, "We are liegemen of Yenya Hanguwan; some forty of us banded together to revenge our lord's death upon his enemy, and are now struggling to get at him. We are not rising against the Government, still less have we any quarrel with your lords. As to fire, strict orders have been given to be very careful, and we beg you not to be under any apprehension on that score. We only ask you to leave us alone and not to interfere with us. If as neighbours you should think yourselves bound to assist our enemy, we shall be obliged, despite our inclination, to turn our weapons against you."

To these bold words the retainers of the noblemen shout back approvingly, "Right well done, right well done; in your place we should feel ourselves bound to act as you are acting; pray command our services." So they desert the roofs and put out their lights.

When Maronhao is at last caught he is treated with ceremonious respect, and afforded the opportunity of performing suicide in the usual manner. "We pray you pardon our violence, and beg of you that you will present us with your head according to the usage of our country." But Maronhao is a vile, ungentlemanly ruffian, and drawing his sword under pretence of ripping himself up, he makes a treacherous lunge at the leader of the Ronin. So he is at once despatched without more ado. The head is cut off with the dagger with which Yenya committed "seppuku," and is struck at in frenzy, gnashed at, and cried over in grief and fury by the Ronin. Then it is washed, and presented on a small stand before the "ihai" (a tablet inscribed with the posthumous name of the deceased) of Yenya placed opposite to it on a similar stand. Incense is burnt before the "ihai," and a prayer is offered up to the dead Yenya "resting amid the shadows of the tall grass" (in the grave), that he will look with favour on the offering. Then all the Ronin betake themselves to his grave and perform "seppuku" themselves.

The Appendix contains an interesting account of a Japanese orchestra, many historical notes, and various information of great ethnological value. The notes throughout the book are very interesting, and some of them amusing. Thus, when the Ronin are crowding round the body of their victim they shout, "Happy are we as the Mōki when he found his waif." In the note we learn that "the Mōki, according to a Chinese fable, was a species of sea-tortoise with one eye in its belly. For three thousand years the monster had longed to see the light, but in vain. One day, while swimming about the surface of the sea, it came into contact with a piece of drift-wood, to which it immediately clung in such a manner that the belly was uppermost under the wood, a ragged hole in which fortunately allowed the tortoise the opportunity of at last satisfying its long-cherished desire. There is a curious note on p. 120 on an allusion in the text as follows:—"Allusion is here made to the practice of hacking at the dead bodies of criminals, by which the young Samurahi was wont to perfect himself in swordsmanship under the old order of things. Treatises exist upon this repulsive art—for an art it seems to have been considered—and one of the commonest of picture-rolls used to represent the various cuts, distinguished by special names, by practising which the aspirant could best learn on the dead subject to qualify himself for mangling the living one."

The Appendix contains a translation in verse of a popular Japanese ballad which is often sung as a kind of epithalamium, and which gives a pleasing conception of Japanese poetry. We commend the book to all our readers.

H. N. MOSELEY

#### OUR BOOK SHELF

*Loch Etive and the Sons of Uisnach.* With Illustrations. (London: Macmillan and Co.)

ALL sorts of epithets have recently been applied to Oban—the Brighton of Scotland, by those whose highest ideal of heaven is "London by the Sea"; the future Liverpool of the North, according to one of its most constant wooers, that enthusiastic Celt, Prof. Blackie; the "Charing Cross of the Highlands," a picturesque placard of one of the railway companies informs the public. But to those who have been there and know from impressive experience all the romantic beauties of island and loch and rugged coast to which the modern Argyllshire coast town is the key, no epithet however ingenious is half so expressive and beautiful as simple "Oban" itself, especially since the "Princess of Thule" has shed a glory over all the Western Islands from Stornoway southwards. But there is the glamour of a story much older than that which William Black has told so well hovering around some of the lochs and headlands in the neighbourhood of Oban. It is this old old story which is told in the anonymous volume before us, the author of which, were we at liberty to reveal his name, our readers would recognise as one occupying a very high rank in a certain department of physical science. The story is that of the early migrations of the Irish Scots to the land which for the last 800 years has borne their name. By the help of a somewhat clumsy dialogue the author takes the reader to some of the localities in and around Loch Etive mentioned in the half-legendary record which remains of these early migrations. He seeks to reproduce the stirring life of the time and localities, takes us to the spots where the Irish emigrants and their distant kinsmen came in contact, unearths the ruins of their houses and forts,

and the remains of their household utensils and warlike weapons. The work has, however, wider bearings than its immediate subject, and several important points connected with the early "Aryan" migrations are discussed in a style much more in accordance with the canons of scientific investigation, and therefore of common sense, than is usual with those who are in the habit of handling such subjects. The chapter on the Celts is specially interesting; its breadth of view is admirable. The author's discussion of the question of Celt and Saxon, Aryan and non-Aryan, and in connection therewith the subject of mixture of race, is an excellent specimen of close reasoning, and we strongly commend it to the study of "Saxon" and "Celtic" enthusiasts. To those who read this work with care and with the help of a good map a new interest will be added to Oban and its vicinity, which is now rendered so accessible by the opening of the Oban Railway. The numerous illustrations will be found really helpful; and grand and musical as the names of many of the places illustrated are in themselves, they will be clothed with a lively significance to those who take the trouble to study the legends of the Sons of Uisnach.

*The Birds, Fishes, and Cetacea commonly frequenting Belfast Lough.* By Robert Lloyd Patterson. (London: David Bogue, 1880.)

THIS work does not purport to be a scientific treatise, but to be a record of many years' observations on the cetacea, birds, and fishes found commonly frequenting Belfast Lough. This lough is, in its way, almost classic ground to the naturalist, and in connection with the treasures to be found around its shores or in its waters, the names of Thompson, Hyndman, Templeton, Haliday, and that of the father of the author of this volume, will ever be associated. The lough is favourably situated for receiving the visits of birds, though the great and still increasing traffic through it must to some extent frighten away many a species; and in grandeur of beauty and variety of life it will not favourably compare with the fine fjord-like bays of Western Ireland. Mr. Patterson tells us that the greater portion of the matter in this volume was originally brought together in the form of papers, which were read at different times before the Belfast Natural History and Philosophical Society, which will account in great measure for their style and for their being somewhat discursive; still the volume is for the most part pleasant reading, and every now and then we come across very interesting and novel facts. In the chapter about gannets we read a good deal about their great feeding powers, and the following estimate of how many herrings the Scotch gannets eat in a year is noteworthy; it is given on the authority of Commander M'Donald, of H.M. cruiser *Vigilant*. Of the five Scotch stations where the gannet breeds, the number of birds frequenting each is put down as follows:—Ailsa Craig, 12,000; the Bass Rock, 12,000; St. Kilda, 50,000; the Stack, 50,000; Gula Sgeir, 300,000, or a total of 424,000. Each of these birds would consume at least a dozen herrings in the day if it could get them; but estimating the daily average as six to each gannet produces 928,560,000 as the quantity consumed in one year, and reckoning 800 herrings to a barrel gives us 1,160,700 barrels captured by the gannets, as against 750,000 barrels, the total take by fishermen on the west coast of Scotland for 1872. Many more such extracts might we give, but our space is limited, and our desire is to send the reader to the volume itself. Almost everywhere throughout the work the author spells the specific names with capital letters, in this overlooking both the rules and practice of men of science. Sometimes, indeed, a specific name, if after a person or place, may be thus spelled without offence, but these exceptional cases should not be made the rule. The volume is dedicated to the memory of the author's father, Robert Patterson, F.R.S.

*Key to the Universe; or, a New Theory of its Mechanism. Founded upon a (1) Continuous Orbital Propulsion, arising from the Velocity of Gravity and its Consequent Aberrations; (2) Resisting Ethereal Medium of Variable Density, with Mathematical Demonstrations and Tables.* By Orson Pratt, Senior. Second Edition. (Salt Lake City, Utah Territory, 1879.)

MR. ORSON PRATT'S work is not a text-book for students, but an application of dynamical principles to the system of the Universe. "The aim of the author is to vindicate the UNIVERSALITY of the law (*i.e.*, of gravitation); to rescue it from the environed limits sought to be thrown around it, and to give it that unlimited freedom of action which the distinguished name 'UNIVERSAL' so appropriately and definitely imports." Mr. Pratt states that astronomical science needs a theory which will answer as far as possible nine questions, which he propounds; the second is, "Why do planetary bodies rotate upon their respective axes? Why do they rotate from west to east, instead of the contrary direction? Is there any law governing their diurnal periods?" The ninth, "Will cometary orbits ever be converted into those of a planetary form?" "Unaided and alone, he launches his humble barque upon this great unexplored ocean, with a compass of his own invention." The discussion occupies thirteen chapters, and his investigations result "in the development of the following beautiful law: *The cube roots of the densities of the planets are as the square roots of their periods of rotation.*" Without making any long comments of our own we can say that Mr. Pratt's book gives evidence of much hard work and, it may be, of ingenious speculation, and we quote as appropriate to the work before us the following remarks of Prof. Newcomb ("Popular Astronomy," p. 233): "It is true that many ingenious people employ themselves from time to time in working out numerical relations between the distances of the planets, their masses, their times of rotation, and so on, and will probably continue to do so; because the number of such relations which can be made to come somewhere near the exact numbers is very great. This, however, does not indicate any law of nature."

#### LETTERS TO THE EDITOR

[The Editor does not hold himself responsible for opinions expressed by his correspondents. Neither can he undertake to return, or to correspond with the writers of, rejected manuscripts. No notice is taken of anonymous communications.]

[The Editor urgently requests correspondents to keep their letters as short as possible. The pressure on his space is so great that it is impossible otherwise to ensure the appearance even of communications containing interesting and novel facts.]

#### The Recent Gas Explosion

THE explosion of the gas main in the neighbourhood of the Tottenham Court Road appears to be an example on a large scale of the phenomenon which occurs on the bursting of a eudiometer.

It is known (although I do not speak from experience) that when such an accident happens the glass gives way at the surface of the mercury in the tube, for at this point the explosion is most violent, in consequence of the gas being compressed by the explosion of that above it. When no accident takes place the flash of light is more brilliant at the surface of the mercury than in the upper part of the tube. In order to see if this fact would throw any light on the explosion of the gas main I tried a few experiments about a fortnight ago, an account of which may possess some interest. A piece of combustion tube 1.93 m. long and 13.5 mm. in diameter was closed at one end, and at 100 mm. from the open end of the tube a pair of platinum wires was sealed into the glass. The tube was filled over water with a mixture of hydrogen and oxygen obtained by the electrolysis of dilute sulphuric acid, and the mouth of the tube closed with a plug of wet cotton wool. The tube was placed on the lawn and secured to a heavy weight by a piece of string tied near the open end; a spark from an induction-coil was then passed

between the wires. The explosion of the gas blew out the plug of cotton wool and bent the platinum wires against the sides of the tube, but the glass was not broken. The tube was again filled with the mixed gases and closed with a cork, which was not forced tightly into the mouth of the tube. This time the tube burst in the middle, leaving .78 m. of the closed end and .59 m. of the open end without damage. The cork was projected some distance, but the wires were not bent by the rush of gas; the closed end of the tube was only slightly moved from its original position by the explosion.

Another piece of similar tube, but only about .88 m. in length, was next filled with gas and exploded in the same manner. The closed end was burst, and .475 m. of the open end remained. In this case the cork was also projected, but the wires were not bent. The experiment being made at night, it was noticed that the flash was much more brilliant at the closed than at the open end of the tube. A third tube of the same length as the first was next tried; the cork was blown out, but the tube did not burst. It was again filled and the cork forced in tightly, but it was again projected. The third time a block of stone was placed a few millimetres in front of the cork; this prevented its projection, but the tube did not burst, being apparently of thicker glass than the previous tubes. In the last three cases the flash was brilliant in the half of the tube towards the closed end.

The explanation of the experiments seems to be, that in the two tubes that burst the pressure produced by the explosion at a distance of about three quarters of a metre from the point at which the gas was fired was sufficient to overcome the resistance of the glass; and in the case of the long tube, which burst in the middle, the release of the pressure prevented the closed end from being destroyed. If the tube had been much longer there would probably have been another place where the violence of the explosion produced by the compression of the gas would have burst the tube.

The press of work at the end of the term has prevented my carrying the experiments farther, but I intend to try the effect of an explosion in a long lead or composition pipe, when I expect to find several swellings or burblings of the metal at the points where the pressure is greatest. When the experiments have been made I hope to be allowed to communicate them to you.

HERBERT MCLEOD

Cooper's Hill, July 24]

#### The Freshwater Medusa

IN NATURE, vol. xxii. p. 241, Prof. Lankester asserts that I had in a previous number (vol. xxii. p. 218) incorrectly represented him as holding that in *Limnocoelium* the radial canals terminate blindly, and as denying the presence of a marginal canal. In proof of my inaccuracy he makes the following statement:—

"A reference to NATURE, vol. xxii. p. 147, will show that in my first publication on the subject I gave as a character of the new genus, 'Radiating canals 4, opening into the marginal canal. Marginal or ring canal voluminous.' I made the same statement in my communication to the Royal Society on June 17, and have not since deviated from it."

I have read the article to which Prof. Lankester here refers, and which was published on the date of the reading of his paper at the Royal Society. The only allusions in it to this subject are the following:—

"RADIATING CANALS 4, terminating blindly at the margin of the disk."

"MARGINAL or RING CANAL obliterated (or, if present, of very minute size)."

GEO. J. ALLMAN

#### Storm Effects

THE storms about this part of Surrey have been lately local and violent, and the effects produced in some instances curious. Visiting a neighbour's farm on Wednesday evening (21st), we found a field of standing wheat considerably knocked about, not as an entirety, but in patches forming, as viewed from a distance, circular spots.

Examined more closely, these all presented much the same character, viz., a few standing stalks as a centre, some prostrate stalks with their heads arranged pretty evenly in a direction forming a circle round the centre, and outside these a circular wall of stalks which had not suffered.

I send a sketch made on the spot, giving an idea of the most

perfect of these patches. The soil is a sandy loam upon the greensand, and the crop is vigorous, with strong stems, and I could not trace locally any circumstances accounting for the peculiar forms of the patches in the field, nor indicating whether it was wind or rain, or both combined, which had caused them, beyond the general evidence everywhere of heavy rainfall. They were to me suggestive of some cyclonic wind action, and may perhaps have been noticed elsewhere by some of your readers.

Guildown, Guildford, July 23

J. RAND CAPRON

### The Inevitable Test for Aurora

I HAVE not long returned from abroad, and have only recently had the opportunity of perusing in *NATURE* (vol. xxiii. pp. 76, 96, 145) the correspondence of Messrs. De La Rue and Müller, Prof. Piazzzi Smyth, and Mr. Backhouse on this subject.

I do not understand Messrs. De La Rue and Müller as claiming their electric discharges to be in the nature of an actual auroral discharge, but rather that their experiments inform us inductively at what heights auroræ are to be found. This, however, doubtless assumes that the discharges in question and auroræ must have something very much in common; and Prof. Piazzzi Smyth is quite to the point in remarking that unless the citron line (and, I would add, the red line) are present in the spectrum, the identity of the discharges with the aurora has not even a foundation.

The fact is, that many of the electric discharges in air and the air gases, and the circumstances attending them—we may instance the ordinary tube glow, its change from rose-tint to violet under magnetic influence, the aura-arc accompanying the spark discharge under similar conditions, the dark space between the terminal and the glow, the change of colours in a hydrogen tube, and other appearances which I have not time to capitulate—so closely resemble auroral incidents, that one is quite disappointed to find on examination no concordance in the spectra. At the most, in a vague and unsatisfactory way one or two of the blue and violet lines in the aurora spectrum have been assigned to one or other of the atmospheric gases; but as Prof. Smyth points out, the red and green giant lines of the spectrum have up to the present time found no terrestrial analogues. I have examined the air spectrum and the spectra of the component gases of air under many various conditions, but always without success so far as these lines are concerned.

I have not, however, had the opportunity of doing this in the case of direct discharges from large secondary batteries; and it would undoubtedly be a valuable addition to our knowledge of facts relating to auroræ if Messrs. De La Rue and Müller would undertake this examination, and clear up matters in that respect. With regard to the heights at which auroræ obtain, the evidence is very conflicting. Certainly they have been seen very near the earth ("Auroræ, their Characters and Spectra," pp. 37 to 40. Height of the Aurora). It is unfortunate that simultaneous observations of the auroral corona are almost entirely wanting. I think I once saw one in print, but missed it subsequently, and would be glad if any particulars could now be furnished me. Prof. Newton, by calculations based on observations of auroral arches in 28 auroræ, has assigned a height of from 33 to 281 miles, with a mean of 130 miles.

Messrs. De la Rue and Müller, I notice, deduce experimentally that at 124 miles no discharge could occur. As to whether the red or the white aurora is the nearest to the earth, my impression certainly is that the apparently low-lying auroræ have generally been the white. I may instance the aurora seen by Mr. Ladd a Margate, "a white ray," and that seen by me in the Isle of Skye in September, 1874. In Lapland, too, the auroræ seem almost universally yellow, but it can hardly be assumed that they are all thirty-seven miles high. The apparently lower position of the red tint is by no means universal, and can hardly be relied upon as evidence on the point, especially when so many auroræ are seen in which it is wanting. I have great hopes, with a spectrocope specially prepared for the purpose, of getting the photographed spectrum of an aurora.

The red line is of course out of the question, but judging from experiments on gas tubes I think the green might be got, and the blue and violet I make in anticipation pretty sure of in the event of an aurora lasting some hours. The principle of the instrument is a long collimator, a single fluid prism, and a short focus-projecting lens, used with rapid dry plates.

Guildown, Guildford, July 23

J. RAND CAPRON

### Experiment with Glass Tubes

I HAVE just been repeating a very beautiful experiment of Prof. Quincke's which he showed me some weeks ago in his laboratory at Heidelberg. The experiment was, I believe, described in *Poggendorff* about two years ago, but I have not seen it noticed in English papers, and a few words about it may interest your readers.

Prof. Quincke, with a view to test the porosity of glass for gases, sealed up tubes in which hydrogen and carbonic acid were generated in great quantity, and weighed them from time to time. Up to the present time, as I learned from him, no loss of weight has been detected. He obtained, however, a very curious result. As I do not know precisely how Prof. Quincke filled his tubes, let me describe what I did myself three weeks ago, remarking that I have done nothing but attempt to repeat what he showed me in Heidelberg.

I took a glass tube, A B, about 5 inches long and  $\frac{3}{4}$  inch in external diameter, with good stout walls. I closed the end A, and let the glass fall in at C, keeping it still very strong, and annealing very carefully at A and C. I introduced some sulphuric acid into the part C A, carefully keeping the neck C dry, and dropped into the part B C some fragments of marble, previously washed, in order that no little particles should tumble down through the neck, C, and commence effervescing before I was ready. I then drew out the tube at B, making a small hook, by which the tube can be suspended if necessary, closed it very strongly, and annealed the extremity carefully, wrapped the tube in cotton wool, and inverted it. The sulphuric acid attacked the marble, and carbonic acid was given off no doubt in great quantity.

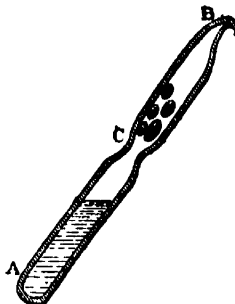

For the first few days there was nothing particular to be noticed. The tube was filled with a bubbling mass of liquid and white mud. Latterly, however, it has begun to show the phenomena which Prof. Quincke observed. The liquid now no longer wets the glass as it did at first, but creeps away from it, giving very much the appearance of the "tears of strong wine." Day by day this is getting more marked, and I expect that soon, as was the case in the Heidelberg tubes, the acid will roll about in the tube like so much quicksilver. Meantime it is most interesting to watch.

I believe Prof. Quincke considers that a thick layer of gas is condensed over the surface of the glass, and that it is this which gives rise to the very peculiar capillary phenomena that present themselves.

I feel bound to remark that the experiment is one that ought not to be attempted without great care and caution.

J. T. BOTTOMLEY

Physical Laboratory, University of Glasgow, July 15

### On the Colours of Double Stars

If any light whatever has its intensity increased the effect on the eye is to add to the sensation a certain yellow element which I have accurately defined by experiment (*Am. Jour. Sci.*, April, 1877, vol. xiii. p. 247). A red light brightened becomes yellow, a green light yellow, a yellowish white less white, a blue or violet light whiter. The phenomena are described at length in Prof. Rood's "Modern Chromatics." The fact that an incandescent body becomes less red and more yellow when it is heated is probably due to this physiological principle. That the incandescent body ultimately becomes white is probably owing to some not understood modification of the principle for excessively bright lights.

It follows that if two stars are of unequal brightness they will appear of different colours unless the qualities of the two lights have a peculiar relation to one another; and the brighter star will usually be the yellow. Accordingly, if we refer to Mr. Burnham's lists of binaries recently published by Prof. Holden (*Am. Jour. Sci.*, June, 1880, vol. xix. p. 467) we find that although differences of colour are so little distinguished that three-quarters of all the pairs are considered to be of the same colour, yet of the twenty-four pairs which differ in brightness by two magnitudes

or over, not one is considered to have components of the same colour. And of the forty-two pairs which are said to be of different colour all but two have more yellow in the brighter, so much so indeed that it is possible to suppose that the difference of brightness is the chief cause of the difference of colour. The two exceptions are:—

No. 23. *ε Bootis* A. eq. Cærulea B. eq. Cærulea  
No. 42.  $\alpha$  507 A. Blanche B. Cendriolivatre

There is evidently some error about No. 23. Either the colours are wrong, or it is wrongly stated to have differently coloured components. In No. 42 it is difficult to say which component is more yellow. Although, then, it is certain that other causes largely affect the colours of stars, yet differences of brightness seem to have the greatest effect in producing the apparent differences in the colours of double-stars.

Prof. Holden compares the colours of bright and faint stars to those of a more or less hot incandescent body. But in the latter case the dimmer light is accompanied with redness. We know that this is not the case with the light of our own sun; for of a white surface, upon part of which the sun shines, while the rest is in shadow, the darker part is bluer. In the same way, of the forty binaries of which the brighter component is the yellower, there are thirty-seven in which the fainter is bluer, and only three in which it is distinctly redder. It appears, therefore, that most double-stars do not differ greatly in colour from our sun, and do not shine with the strongly red light of an incandescent solid.

C. S. PEIRCE

Paris, July 20

#### Coffee-Disease in New Granada

THE following information about what appears to be a new disease of the coffee-tree is taken from an official letter written on April 29 last by Mr. C. Michelsen, Commissioner of Agriculture at Bogotá, to Mr. José Herrera, Vice-consul of New Granada in this city, who sent me a copy of it, requesting me to give him my opinion about the disease.

At first there appear on the leaves small spots of a light-greenish colour, which in two or three days turn brownish, and then appears on each of them a fungus *divided in three or more greenish-yellow branches*. This fungus is said to be phosphorescent at night, and in places where it is very common a phosphoric smell is noted (!). After some days the diseased leaves fall off; the fruits, which also are attacked by the parasite, follow very soon, and the trees are left quite bare. They form, however, new leaves after some months, but these are again attacked by the fungus.

The disease is reported to be more frequent in damp places than in dry ones, its ravages being greatest in plantations where the trees are planted rather close. The fungus has also attacked the shade trees, especially the *guamos* (*Inga* sp.).

Though the description is far from being satisfactory, I think it is pretty clear that the fungus is not the *Hemileia vastatrix* of Ceylonese celebrity. However it bears a great resemblance to it, so that I recommended to employ fumigations with sulphur under the kind of large umbrella proposed by Mr. George Wall (*NATURE*, vol. xix. p. 423). The unusually rainy weather in the last year has very likely much to do with the spread of the disease, which at the same time is a new proof of the eminently fatal consequences resulting from close planting.

I have asked for dried specimens of diseased leaves, in order to submit them for examination to a competent mycologist.

Caracas, June 26

A. ERNST

#### Toughened Glass

PROBABLY the accident mentioned by Mr. Noble Taylor is not exceptional, as a similar one happened to a member of my own family. She was about to take a seidlitz-powder, and had poured the contents of the blue paper into a tumbler of toughened glass half filled with cold water, and was stirring it gently to make the powder dissolve, when the tumbler flew into pieces with a sharp report. There was no fire or lamp in the room at the time. Some of the fragments flew to a distance of three or four feet. The bottom of the tumbler was not altogether fractured, but cracked into a number of little squares, which could be separated readily.

Edinburgh, July 20

T. B. SPRAGUE

THE same accident occurred to me a few nights ago as happened to your correspondent, and I cannot help thinking that the spoon had most to do with the phenomenon.

In a hot room I had just finished what is usually called a "lemon squash," *i.e.*, the juice of a lemon and a little white sugar, with a bottle of soda-water, a lump of ice being put into the mixture. I was talking at the time, and so held the empty glass with a spoon in it in my hand for a second or two, when suddenly it went off in my hand into thousands of pieces, none larger than an inch or so.

I picked up one of the largest and thickest pieces, and found it to be so thoroughly disintegrated that I broke it up with my fingers into about a hundred small pieces, and might have done more. This disintegration seems to be a natural property of toughened glass when broken, but I never before saw a case of its breaking up without being struck. I do not think that usually such occurrences are dangerous, on account of the entire destruction of the fabric.

J. C. J.

#### Large Hailstones

ON Tuesday, July 13, at 2.30 p.m., hail began to fall heavily in this neighbourhood. A thunderstorm was at the time approaching rapidly from the north-east. I was struck with the extraordinary size of the stones, and going into the open air I collected six—the first that came to hand—in an accurately-tared glass, and weighed rapidly. The six stones weighed 5.766 grams. The average weight for each stone was therefore .961 gram, or 14.8 grains. A pane of glass in a skylight window had a hole driven through it by one hail-stone.

GEORGE PATERSON

Borax Works, Old Swan, Liverpool, July 14

CHATEL, JERSEY.—Please send exact address.

#### PAUL BROCA

THE sudden death of the eminent French anthropologist, Dr. Paul Broca, which we announced a fortnight since, is an irreparable loss to science, and for the French medical and anthropological schools particularly.

Prof. Broca, born in 1824 at Ste. Foy la Grande (Gironde), was a senator, vice-president of the Academy of Medicine, officer of the Legion of Honour, and member of several learned societies. Since 1846, the year in which he was promoted Aide d'anatomie, till 1880, when he died as a professor of surgery, during nearly thirty-four years the life of Dr. Broca has been an uninterrupted consecration to science. A rapid review of his scientific work, especially of what he did for anthropology, will show how indefatigable was his zeal, how well his life has been spent.

Broca's publications on various subjects in anatomy, surgery, and anthropology are innumerable, especially his contributions to the last-mentioned subject. One has only to open the numerous volumes of the *Bulletins* of the Paris Anthropological Society, of the *Mémoires* and the *Revue d'Anthropologie* and other scientific journals, to get an idea of Broca's immense activity. In 1856 he published his famous "Traité des Anévrismes," which, with his "Traité des Tumeurs," published in 1866, constitute his principal medical works. The former opened a new era in the treatment of these affections; in the latter Broca expounded the historical evolution of the knowledge of tumours and their treatment in so able a manner that it has hitherto not been surpassed.

In 1861 Broca made his remarkable discovery of the seat of articulate language at the third frontal convolution of the left side of the brain. Moreover in later years Broca devoted himself to the study of the brains of man and animals, greatly contributing to our knowledge on that subject. The *Revue d'Anthropologie* contains many of the results of these studies; for instance, "Sur la Topographie cranio-cérébrale," "Étude sur le Cerveau du Gorille," "Anatomie comparée des Circonvolutions cérébrales," "Localisations cérébrales," &c.



His treatise "Des Phénomènes d'Hybridité dans le Genre humain" appeared in 1858 and 1859, and in 1864 was translated into English.

Among the great number of memoirs may further be mentioned: "L'Intelligence des Animaux et le Règne humain," "La prétendue Dégénérescence de la Population française," a brilliant plea for the French nation, "L'Ordre des Primates: Parallele anatomique de l'Homme et des Singes," "Recherches sur l'Indice Nasal," "Étude sur la Constitution des Vertèbres caudales chez les Primates sans Queue," "Les Troglodytes de la Vézère," "La Race Celtique ancienne et moderne," "Étude sur les Propriétés hygrométriques des Crânes," "Sur l'Origine et la Répartition de la Langue basque," "Recherches sur l'Indice orbitaire," "Sur l'Angle orbito-occipital."

The practical results of a good deal of Dr. Broca's anthropological researches are found in his "Instructions," forming two separate volumes; one, for the anthropological study of the living, appeared for the first time in 1864, and has been re-edited several times since; the other, particularly on craniology and craniometry, was published in 1875. Another valuable memoir is that on the "Indices de Largeur de l'Omoplate chez l'Homme, les Singes et dans la Série des Mammifères," in which he opened up new views on the comparative anatomy of races and mammals. One of Dr. Broca's last works was his important study on the "Variations craniométriques et de leur Influence sur les Moyennes," &c.

The greatest glory of Broca is perhaps the foundation of the Anthropological Society of Paris in 1859. The perseverance and talent of the founder surmounted all the difficulties and troubles of every kind which threatened in the beginning the existence of the society, which now, after nearly one-and-twenty years, is flourishing as one of the first learned societies in Europe. During these long years Broca was the soul of the anthropological movement in France; nay, we may say that his influence extended far beyond his own country, and that the study of man in other civilised countries has been followed after his method. In reality Broca was at the same time the founder of a new and excellent anthropological school: his method of anthropometry, &c., as expounded in the "Instructions" above-mentioned, is now followed by the great majority of anthropologists. But this was not enough for the indefatigable zeal of the eminent scholar; in 1872 he commenced to publish the *Revue d'Anthropologie*, one of the best organs on the science of man. Many of his own works have been published in it.

Broca's last and greatest work was the foundation in 1876 of the now celebrated École d'Anthropologie in Paris, with a first-rate museum, laboratories, library, and a complete course of anthropological lessons given by more than half-a-dozen professors, among whom are de Mortillet, Bertillon, and Topinard. Broca himself taught the comparative anatomy of the Primates.

The laboratories above-mentioned belong at the same time to the École pratique des Hautes Études since 1878.

Broca, the scholar, philosopher, and statesman, died on the field of honour, in the midst of his work, in the vigour of life. Though dead, his work will never perish; man dies, but science remains. His illustrious example will continue to enlighten the path of those who follow the imperishable footprints he has left.

H. F. C. TEN KATE

### THE WOOLWICH GUNS

A PETITION signed by several men well known in the field of mechanical science and presented to the House of Commons last week contains many points to which it is important that public attention should be directed. The memorialists state their belief that the system of heavy ordnance now in use and known as the Woolwich system is inefficient and dangerous, that, con-

sidering the increasing dependence of the nation for food supply upon its command of the sea, it is evidently unsafe to neglect any of the opportunities which the mechanical skill and manufacturing resources of the country afford for securing the best weapons of offence and defence for our fleet and our army; "that, having regard to the advances constantly being made by private manufacturers in this and other countries, and to the ordnance actually in use or in course of construction for the other Powers of Europe and America, your petitioners look with dismay upon the defects of the English heavy guns, and they are of opinion that these defects seriously endanger our naval supremacy and our national safety." Further the petitioners maintain that it is not right that the heads of the manufacturing department, which is in competition with outside manufacturers, should be the official advisers of her Majesty's Government as regards new inventions, and that the defects in our present system of ordnance arise and are likely to continue from the absence of independent criticism, and in consequence of the technical advisers of the Government being the same persons as those who either are or have been in charge of the manufactories responsible for these defects; that there are in existence several systems of ordnance superior to the Woolwich system, and that it is of national importance that private establishments for the production of arms of all kinds should be encouraged and should not be crushed by giving a virtual monopoly to the Government establishments, but that the private trade and the Government factories should rather serve as reserves to one another.

The principal issues thus raised may be very shortly stated. If we want the best guns, can they be obtained better from a Government manufactory carefully fenced round by official jealousy, or can a better article be procured by open competition amongst private manufacturers? Is it impossible for the technical advisers of the Government to select from the enormous mass of inventions and improvements offered to them those of real value? And further, do they, or would they make this selection if it were in their power? It has often been objected that the great quantity of suggestions and friendly advice constantly being received renders it quite impossible to treat them with adequate discrimination; but if the officials intrusted with this work were only possessed of a thorough scientific knowledge of mechanical principles, we believe that nine-tenths of the worthless schemes could be at once rejected, so inevitably does the mark of the circle-squarer appear in his work to one who knows where to look for it.

Respecting the remaining 10 per cent. of inventions and improvements, it would probably require somewhat greater practical judgment to decide which were worth further investigation; but while we do not for a moment suggest that the whole of these should be examined and tested at the expense of the tax-payer, it is at least not too much to expect that an obviously good design should not be rejected with an official reply. Inventors are probably the most persevering of all men, and, fortunately for the cause of progress, though not perhaps for their own advantage, they have a greater belief than any one else in the results they hope to obtain; but it is hardly to be expected that they will bestow their whole powers of persuasion on the authorities of their own country when they plainly see a more open field abroad.

For instance, there can be little doubt that the Whitehead torpedo might have been a secret exclusively the property of this country if the inventor had been afforded a fair investigation; again, it would be interesting to know whether the Russian Government required as much persuasion to induce them to adopt the Moncrieff hydro-pneumatic gun-carriage as has been expended in bringing it as far as the "experimental" stage in our own service.

That many inventors have had a short innings at the

hands of the War Department is to be plainly seen in the collections of what are merely regarded as useless eccentricities at Woolwich and Shoeburyness, but it is very improbable that most of the lessons to be learnt from these have ever been appreciated by those who were responsible for their rejection. Has it not taken twenty years for the system invented by Robert Mallet of building up a massive piece of ordnance capable of being taken to pieces to facilitate transport, to at length bring forth the present seven-pounder screw gun, which can be carried in halves on the backs of mules? It would be interesting to know whether any private firm in this country, if they had received the order, could have manufactured and proved a train of siege guns on similar principles, and capable of as easy transport as the modern field gun, and which would have considerably facilitated Gen. Stewart's advance to Cabul.

It can of course be urged with some show of reason that, considering the enormous supply of most patterns of guns and the vast quantity of ammunition required throughout the Empire, great inconvenience would result from too great a multiplicity of designs; but to continue the manufacture of an inferior pattern for this reason when a better one is procurable appears to us only to make the evil greater when the former has to be finally abandoned as obsolete. Thus we suppose it must have been obvious to a great many persons for the last five years that the days of heavy muzzle-loading guns for the navy were numbered, from the difficulty or impossibility of giving sufficient length of bore for the consumption of large charges of powder while still enabling the gun to be fought in a turret. All possible ingenuity was then expended on shortening the recoil and on mechanical systems of loading in a confined space, with results that might have been incalculably disastrous had this country been involved in war previous to the terrible accident on board the *Thunderer*; all this too while we believe a suitable pattern of breech-loader was in the hands of a private firm and had been tendered by them for adoption by the War Department. If it could be shown that a Government factory could alone turn out guns of the best manufacture, superior to anything that could be produced by private establishments, the logical sequence would be that armour plates and marine engines and the ships themselves should all be provided in the same way.

The effect of a Government monopoly on the foreign trade of a manufacturer is too well known to require demonstration; but if the encouragement of private establishments for the production of all kinds of arms and warlike stores should result, as it doubtless would, in a larger trade with foreign powers in these manufactures, while we should profit by their custom in time of peace, they would not only find themselves in the event of war with this country cut off from their supply of fresh arms and ammunition, but the whole of our own increased production would be available for national defence.

If such an inquiry as is sought for in this petition be instituted by the present Government, conducted not only by officers of the army and navy, but also under independent scientific advice, we believe that numerous articles of belief and revered principles of construction will be shown to have been long exploded and will have to be at once abandoned. We shall then probably find the Woolwich system of rifling with increasing pitch and studded projectiles giving place to the poly-groove of uniform pitch with rotation by gas-check which has been under consideration for years, and is yet scarcely recognised; we may even take a hint from the Chinese Government, who, by applying to Sir William Armstrong's firm, have for more than a year been in possession of four more powerful guns than any afloat in our most recent ironclads; we should perhaps find that a system of breech-loading is ready for adoption solving most of the difficulties of

turret and casemate defence, and that a trustworthy type of hammered steel is ready at hand to be substituted for the welded coils of wrought iron at present in use.

If it should be found that our Government establishments have been suffering from a slow process of crystallisation, they might be resuscitated by being placed in keen competition with private firms whose very existence depends on their unceasing activity, or at the least it would be ascertained whether in a critical time the country would have to depend entirely on the Royal Gun Factory, or whether some of the old firms who in former years fought so hard for a share in the work have not forgotten their skill.

#### LIVING ON WATER

HOW long a man can live on water alone is now the subject of an experiment in New York. A Dr. Tanner from Minnesota is devoting himself to this trial. Tanner declares that he can live for forty days without food, and is proving, or trying to prove, the truth of the hypothesis on his own unfortunate person. He is reported to have got through twenty-eight days of his endeavour, and still to be alive and comparatively well. On the twentieth day his pulse was 76, his temperature 98°405, and his actual weight 132 lbs. On the twenty-eighth day his weight was 130 lbs. He lost 27½ lbs. in the first nineteen days during which he fasted, and then ceased to waste at the same rate. The latest report we have of him states that he is cheerful, active, and, notwithstanding abundant medical opinion to the contrary, confident that he should continue to the end of the time named for the experiment. Of food of the solid kind he touches none; of drink he partakes of water and nothing else; water and air will, he maintains, sustain him, and that notwithstanding exertions from riding and other exercises. Dr. Tanner is not original in this mode of attempt upon his own life. In the *Transactions* of the Albany Institute for 1830 Dr. McNaughton reported the history of a man named Reuben Kelsey, who on July 2, 1829, declined eating altogether, assigning as a reason "that when it was the will of the Almighty that he should eat he would be furnished with an appetite." McNaughton's account of this man is singularly interesting. We have not room for all the details, but it may be told in brief that Kelsey continued to live for fifty-three days; that he went out of doors and walked about during the greater part of the time, and that he was able to sit up in bed until the last day of his life. During the first three weeks of his abstinence he fell away very fast, but afterwards did not seem to waste so sensibly. Towards the close of his days the colour of his flesh was blue, and at last blackish. His skin was cold, and he complained of chilliness. His general appearance was so ghastly that children were afraid of him. Of this he himself seemed to be aware, for it was not uncommon to observe him covering his face when strangers were passing by. At the time of his death Mr. Kelsey was twenty-seven years of age. The writer of this notice once attended a gentleman, who, for a nearly similar reason as that assigned by Mr. Kelsey, abstained from all food, except water, for even a longer period, viz., fifty-five days. In this instance the wasting was most observed in the first three weeks of the fasting. From this it will be gathered that Dr. Tanner may live to the full extent of forty days on water without being suspected of having been the subject of a miracle. It is against the success of his experiment that he should be exposed to an amount of excitement and vexation that must reduce greatly the vital power, but for all that he may possibly survive the ordeal. The grand question is how he will cry back again. The facts of these examples, painful as they are, are not without their use. They indicate that water being admitted into the body, life may go on for periods

far beyond any that might be expected, and they expose altogether the fallacy about the value of alcohol when with large quantities of water it has been administered as a supposed life-sustaining food.

B. W. R.

WATERFOWL<sup>1</sup>

ONE of the principal objects of these lectures being the illustration of the animals exhibited in the Society's Gardens, I have selected for my address to you this day the subject of "Waterfowl," by which I mean the *Anseres*, or family *Anatidæ*, of naturalists, commonly known as ducks, geese, and swans. Three familiar species of domestic birds, the names of which I have just cited, belong to this family, and have been known to us since the times of the Romans, and a fourth, the Muscovy duck, has been added to the series since the discovery of America. Besides these four domestic species nearly all waterfowl show great aptitude for semi-domestication. When pinioned and put in small ponds, and supplied with food and shelter, most of them will thrive, and many of them will breed in captivity.

The acquisition of waterfowl has long been a subject of special interest to this Society. In 1830, in the first list of our animals ever published, I find thirty species of waterfowl included, amongst which are the Orinoco goose, Mandarin duck, and the *Cercopsis* goose. In 1844 I find twenty-six species included in the catalogue of the animals then living in the Gardens. About that time the thirteenth Earl of Derby, then president of this Society, was the great patron of waterfowl, and, by means of collectors and agents in all parts of the world, brought together in his celebrated menagerie at Knowsley one of the finest collection of these birds ever made. At the disposal of the Knowsley menagerie by auction in 1851, examples of 51 different species of waterfowl were sold, many of which had been bred in the Knowsley Gardens.

Since that period the Zoological Society, having become the possessor of some of the choicest specimens sold at Knowsley, has taken up the subject of waterfowl with increased vigour, and has succeeded in adding considerably to the list of introduced species. During the past twenty years there have been exhibited in the Society's Gardens examples of 86 species of this group of birds, and at the present time the collection consists of not less than 270 individuals, referable to 53 different species, forming, as we believe, the finest living series of these birds now in existence. The zoological gardens of Amsterdam, Antwerp, and Berlin, and the Jardin d'Acclimatation of Paris have also excellent collections of waterfowl, and have succeeded in breeding some species which have obstinately refused to avail themselves of the inducements we have offered them in these Gardens. But in extent and variety I believe our series remains pre-eminent.

The total number of species of the family *Anatidæ* at present recognised by naturalists is about 175; of these some 94, or more than half, have been at various times represented by specimens held in captivity either in our Gardens or elsewhere, and of the species thus exhibited no less than 50 have paired and produced young.

Of the nine groups or sub-families into which, as will be seen by the Table, the *Anatidæ* are divisible, the *Anatina* or geese, swans, and river-ducks show the greatest aptitude for this kind of semi-domestication. The sea-ducks, lake-ducks, torrent-ducks, and mergansers are much more wild in their nature, and do not thrive nearly so well in confinement. Of the 31 known species of sea-ducks (*Fuligulina*) but 13 are known to have been exhibited in zoological gardens, and of these only 5 have reproduced in captivity. None of the

lake-ducks (*Erismaturina*) or torrent-ducks (*Merganetina*) have ever been introduced alive, and none of the Mergansers (*Mergina*) have been bred in captivity,

Table of Water-fowl

	Species		
	Known.	Exhibited.	Bred.
1. Anseranatinæ ... ..	1	1	—
2. Cercopsinæ ... ..	1	1	1
3. Anserinæ ... ..	38	25	14
4. Cygninæ ... ..	10	8	5
5. Anatinæ ... ..	75	43	25
6. Fuligulinæ ... ..	31	13	5
7. Erismaturinæ ... ..	9	—	—
8. Merganetina ... ..	—	—	—
9. Merginæ ... ..	6	—	—
	174	94	50

although examples of three species of the last-named group have been occasionally exhibited.

Of the geese (*Anserina*), on the other hand, which number some 38 known species, no less than 25 have been introduced at various times, and of these 14 have reproduced in captivity. Amongst these one of the best introductions effected by the Society is that of the Magellanic or upland goose, of which examples were first received in 1857, presented by Capt. Thomas Moore, at that time Governor of the Falkland Islands, in which settlement, as we know from no less an authority than that of Mr. Darwin, the upland goose is a familiar species. The upland goose commenced to breed with us in 1863, and has continued to do so with tolerable regularity ever since; it has also hybridised in this country with the closely-allied form from Chili, which has been called *Bernicla dispar*, and of which many examples have been received by the Society in recent years.

Besides the upland goose, the allied ruddy-headed and ashy-headed geese of Antarctic America have been acquired and successfully bred. The ruddy-headed goose has unfortunately been lost, and requires reintroduction, but its ashy-headed brother remains a denizen both of these Gardens and also of similar establishments on the Continent.

Passing on to the swans, we find that a still greater degree of success has been obtained in the acclimatization of these birds. Ten species of swans are recognised by naturalists, of which eight have been introduced into zoological gardens and five have been bred in captivity. Besides the common tame swan which is upon every piece of water, the ponds of our Gardens contain at the present time examples of the hooper, Bewick's swan, trumpeter swan, black swan, and black-necked swan, and but a short time ago we had also examples of the beautiful Coscoroba swan of Antarctic America, remarkable for its coral-red bill. Of all these the most engaging is perhaps the black-necked swan, originally obtained by the late Lord Derby from Chili, and first acquired by this Society at the dispersal of the Knowsley collection in 1851. A pair of these birds first bred with us in 1857, and the species has continued to do so with more or less regularity ever since that date.

The river-ducks (*Anatina*), which succeed the swans in the natural series, are the most numerous group of the family. Of the seventy-five known species of river ducks forty-three have been introduced into captivity, and twenty-five have been successfully bred. Of these I will call particular attention to two which have been recently added to the list of introduced species, and are charming representatives of the group.

The rosy-billed duck of South America was first introduced by this Society from Chili in 1867, but only, unfortunately, in the shape of a single male. In 1870, however, we obtained examples of both sexes from the same locality, which began to breed with us in 1873. Since then young ones have been hatched nearly every

<sup>1</sup> Abstract of a "Davis Lecture" given before the Zoological Society of London, July 8, 1880, by P. L. Sclater, F.R.S., Secretary to the Society.

year in the Society's Gardens, and we have been able to supply many of the gardens and collections on the Continent with pairs of this fine species.

Another successful introduction, from a very different quarter of the globe, has been the paradise duck of New Zealand. The so-called paradise duck belongs to the genus *Tadorna*, or shield-drake, and is remarkable, as I believe we were first certainly able to ascertain from our living specimens, for the black head of the male being replaced by a brilliant white in the female. What is still more remarkable however is that in this bird the young in both sexes, contrary to what usually obtains amongst the whole class of birds, have the plumage of the male parent, the female birds putting on the white head only after the first moult. The paradise duck was first obtained by the Society in 1863, when specimens of

both sexes were presented to us by Mr. J. G. Tetley; the species first bred in the Gardens in May, 1865, and, assisted by the arrival of subsequent specimens, has continued to do so ever since, so that we have been able to supply many of our friends and correspondents on the Continent with examples of this duck, which may now be considered as firmly established in the gardens of Europe. Amongst other fresh-water ducks which have been successfully acclimatised in the same way within recent years I should also notice the Chiloe widgeon and the Chilian pintail, of Antarctic America, the spotted-billed duck of India, and the Brazilian teal, all of which have of late years bred freely in the Society's Gardens.

I will conclude with a few remarks upon the geographical distribution of the Anatidæ.

In treating of this part of the subject I find it impos-

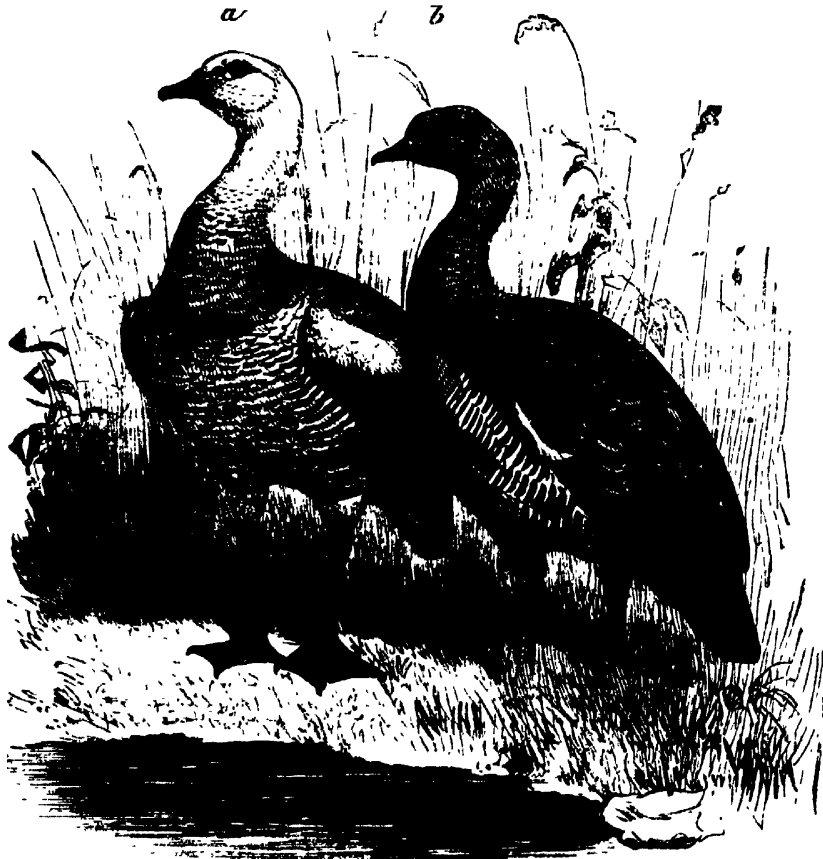

FIG. 1.—Upland Goose.

sible to separate conveniently the Palaearctic and Nearctic species, or those of the northern parts of the Old and New World. So many of the high northern species are circumpolar or common to both continents, and so many other of the Palaearctic species have closely allied (in some cases barely separable) representatives in the Nearctic area, that it is much more natural to unite these categories into one group as "Arctic Anatidæ." Adding to this the other four generally recognised divisions, we shall find the Anatidæ come out, somewhat as follows, in five great geographical groups:—

I. ARCTIC ANATIDÆ.—The Arctic Anatidæ are by far the most numerous of all the five groups, these birds with their thick covering of feathers, and aquatic habits, being naturally adapted to cold and wintry climates. Out

of the 38 known species of geese 20, out of the 10 known swans 7, and of the 31 known sea-ducks not less than 26 belong to this category. Of the whole number of 174 generally recognised species of Anatidæ, 77 may, I think, be best set down as Arctic, although some of them, such as *Tadorna rutila*, *Fuligula rufina*, and *Marmaronetta angustirostris*, cannot be strictly so termed, as they inhabit only the temperate portions of the Palaearctic region. Very many of the Palaearctic species also, as will be noted below, go far south in winter and intrude far into the Æthiopian, Indian, and Neotropical regions.

II. ÆTHIOPIAN ANATIDÆ.—Under this head I place only those species that live all the year round, and breed within the Æthiopian region. These are about twenty-two in number.

Amongst these are two generic forms not found elsewhere, *Plectropterus* and *Thalassornis*. Of the nine Anatidæ hitherto registered as met with in Madagascar two species only are peculiar to the island, *Anas malleri* and *A. bernieri*, the remaining seven being also found in Africa.

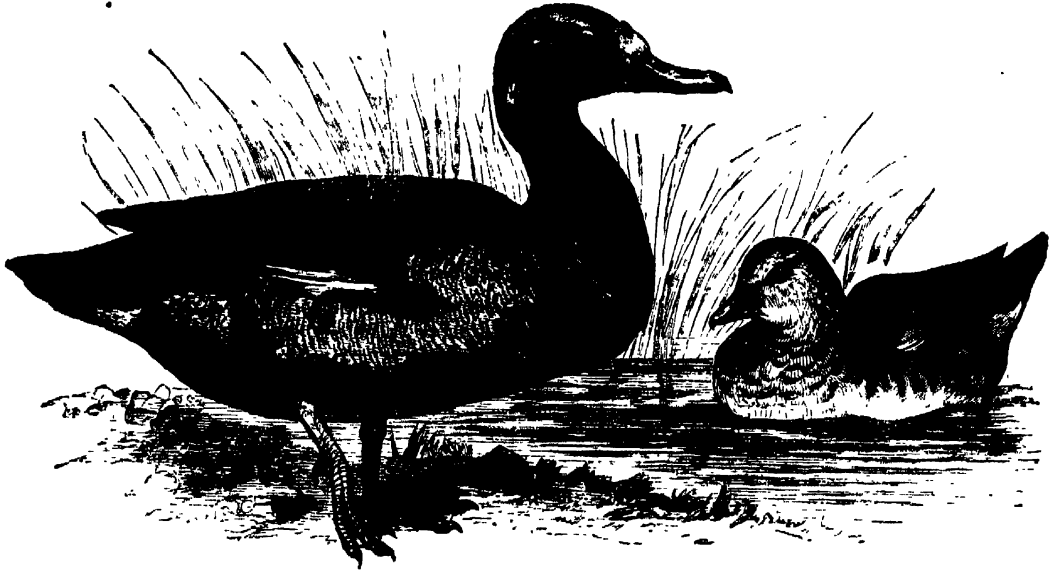

FIG. 2.—Rosy-billed Duck.

In winter, as will be seen by Heuglin's recent works, many of the Palearctic Anatidæ penetrate into Eastern Africa.

III. INDIAN ANATIDÆ.—In this category again I include only species that are permanent inhabitants of some parts of the region. They are not numerous, consisting only of twelve species.

Amongst these there is only one peculiar generic form, *Rhodonessa*.

In winter, however, a host of immigrants from the north invade the Indian region. Jerdon gives us accounts of upwards of twenty northern ducks and geese which are found in various parts of the Indian peninsula in the cold weather.

IV.—AUSTRALIAN ANATIDÆ.—As we advance farther south the Anatidæ commence to increase again. Instead of only twelve native species we find the number in the Australian region running up to twenty-nine. The greater

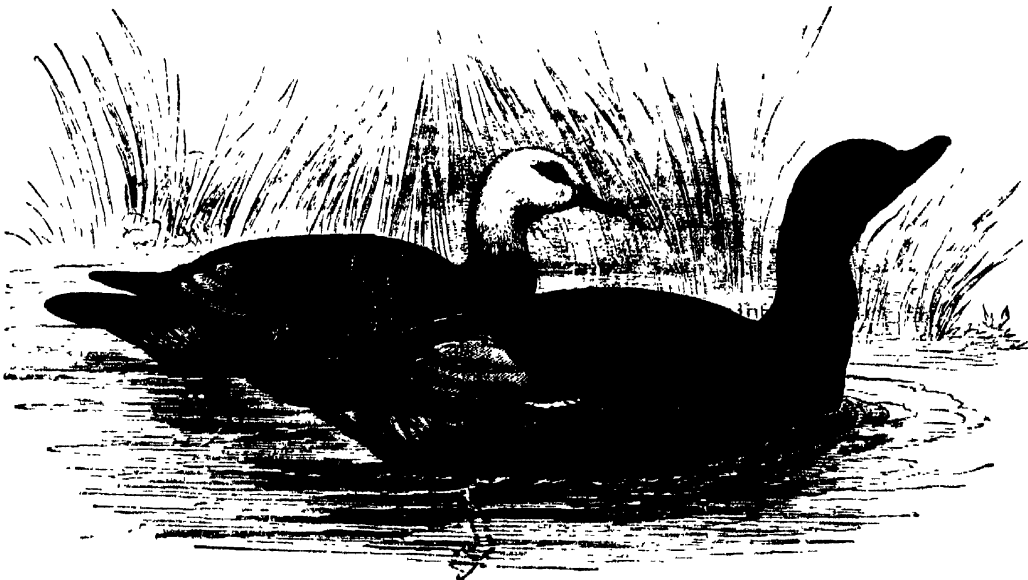

FIG. 3.—Paradise Duck.

number of these are found in Australia itself, that great continent, although so dry and arid, being well supplied with waterfowl.

Among these there are no less than five generic types peculiar to Australia, namely, *Anas*, *Cereopsis*, *Stictonetta*, *Malacorkynchus*, and *Baniwa*.

Proceeding to the outlying parts of the Australian region, we find New Zealand also well provided with Anatidæ, nine species being comprehended by Dr. Buller in his lately-published work on the birds of New Zealand, while the adjacent Auckland Islands are tenanted by two very peculiar ducks, quite unknown elsewhere, namely *Nesometta aucklandica* and *Mergus australis*.

In Polynesia Anatidæ are scarce, *Dendrocygna vagans* and *Anas superciliosa* being the only species known until we come to the Fanning group, where the peculiar *Chaulelasmus conesi* has lately been discovered.

In the Sandwich Islands two peculiar species occur, *Bernicla sandvicensis* and *Anas wyvilliana*.

V. NEOTROPICAL ANATIDÆ.—The Neotropical region is better supplied with Anatidæ than any other of the divisions here adopted except the Arctic, thirty-nine species being specially attributable to it. Besides these, as Mr. Salvin and I have shown in our articles on the Neotropical Anatidæ published in the Society's *Proceedings* for 1876, twenty-three of the Arctic Anatidæ are more or less regular visitants to it during the winter season.

The generic types of Anatidæ restricted to the Neotropical area are four, namely, *Heteronetta*, *Cairina*, *Tachyeres*, and *Merganetta*. There are, however, only six species belonging to these peculiar genera, so that the mass of the Neotropical Anatidæ belong to Arctic forms.

On the whole the Neotropical Anatifauna (if such an expression be allowable) is not so peculiar, as that of Australia, where there are five generic types not found elsewhere. In true Anatidæ the Neotropical region is specially rich, possessing twenty-three species against the Arctic eighteen.

In *Fuligulina*, on the other hand, it is very poor, having only one species against the Arctic twenty-six.

In concluding my lecture I would venture to urge those who have friends and correspondents abroad, or who are so fortunate as to travel themselves, not to let any opportunity pass of adding to the Society's living collection of Waterfowl. In a paper recently read before the Zoological Society I have given a complete list of the known species of these beautiful birds, and an exact account of the introduction of each species that has been obtained alive, and if not, where it is to be found. I shall be happy to supply any one interested in the subject with a copy of this paper when in type, as it will shortly be. Meanwhile I may venture to specify some of our principal desiderata in different parts of the world.

1. Freshly-imported examples of the *Cercopsis* goose of Australia to cross with the present European stock.
2. Examples of the *Bernicla cyanoptera* of the highlands of Abyssinia, never yet obtained alive.
3. Examples of David's swan (*Cygnus davidi*) from Pekin. Even skins of this little known bird would be very desirable for our museums.
4. Specimens of the canvas-backed duck and smaller white swan (*Cygnus americanus*) of North America.
5. The pink-headed duck of India, of which we have only yet received a single pair in 1874.
6. The Radjah shieldrake of Queensland (*Tadorna radjah*), a most beautiful species allied to our *Tadorna vulpanser*.

Any examples of these species would be most gratefully received by the Society for their living collection.

### NOTES

As we have already intimated, the German Association of Naturalists and Physicians meets at Danzig from September 18 to 24. Contributions from non-German workers in science are earnestly asked for, and we are sure that any foreigners who desire to be present at the meeting will receive a hearty welcome. Applications for quarters should be made before September 10 to Herr L. Biber, Brodbankengasse 13, Danzig. Besides the

<sup>1</sup> Revision of the Neotropical Anatidæ, *Proc. Zool. Soc.*, 1876, p. 358.

usual excursions, concerts, and other social gatherings which the Germans know how to manage so well, there will be plenty of work in the twenty-three sections. Among the public lectures to be given are the following:—On September 8, "On Writing, Printing, and the Prevailing Short-sightedness," by Dr. Hermann Cohn of Breslau; "On some Characteristics of Cell-life," by Dr. Strasburger of Jena. September 21—"The Food of Marine Animals," by Dr. Moebius of Kiel; "The Statics of Continents and the alleged decrease of the Water of the Ocean," by Dr. Jentzsch, of Königsberg; "The Scientific Standpoint of Psychiatry," by Dr. Wernecke of Berlin. September 24—"Polar Expeditions or Polar Observatories," by Dr. Neumayer of Hamburg; "Foreign Domestic Birds, with special reference to the scientific results of their Breeding," by Dr. Carl Russ of Steglitz.

MUCH capital is being made out of the reports of some of the inspectors in the new Education Report, who attempt to enliven their pages by giving some of the results of the recent attempts at higher education in elementary schools. The answers are certainly ludicrous enough sometimes, almost as ludicrous as those said to be given occasionally by the undergraduates of Oxford and Cambridge. But [the rational conclusion to be drawn from this state of things is not that which finds favour with Lord Norton and his friends, that the attempt to improve elementary education should be abandoned. As the *Times* well puts it:—"They are firstfruits of the attempt to put to a higher and more exacting work instruments fashioned for a lower and a simpler one. All such results are at first necessarily imperfect, and nothing is easier than to make them appear ridiculous. The true remedy, however, is not to reject the instruments, but to adapt them, or give them the means of adapting themselves, to the higher function." If science is to be taught in elementary schools, let it be taught in a proper manner by properly trained men.

EVIDENTLY the Government of New Zealand have no fear of over-educating the people. From the *Colonies* we learn that the New Zealand system of education has been characterised by the Governor, Sir H. Robinson, as "the most ambitious yet adopted in any country in the world." To quote the words of Sir Hercules:—"It is proposed in New Zealand to provide the whole juvenile population with instruction free of charge in the following subjects:—Reading, writing, arithmetic, English grammar and composition, geography, history, elementary science, drawing, object lessons, vocal music, drill, and, in case of girls, needlework and the principles of domestic economy. The scheme includes also provision at the public expense for a system of scholarships, for the maintenance of normal schools for training teachers, for the efficient inspection of public schools, and for the erection of suitable school buildings. As soon as sufficient school accommodation has been provided the Education Act contemplates that attendance at public schools shall be made compulsory on all children between the ages of seven and thirteen who may not be otherwise under efficient or regular instruction." While Sir Hercules thinks the programme may be too varied and too costly, he attaches little weight to the objection that there is a risk of over-educating the masses above their occupations and so making them discontented with their lot in life. While he criticises the scheme in some of its details, still he says:—"I think that your scheme of national education is one of which any country might well feel proud, and that it is being administered with an earnestness and an ability which is deserving of all praise. I have been much struck, in travelling about the country, with the deep interest which is universally taken in this most important question, and with the determination which pervades the whole community that the blessings of education shall for the future be placed within the reach of all."

With such a healthy, vigorous motive power, supervised and directed with so much intelligence, any defects [in the driving gear of the machinery] will soon be detected and corrected, until the object which all have equally at heart is fully attained, and New Zealand is placed in the front rank amongst the educated communities of the world."

THE Trustees of the British Museum appear to be determined to earn the reputation of hopeless incapacity for appreciating science. Everybody knows how completely successful has been the experiment of furnishing the reading-room of the British Museum with the electric light, and what an impetus this has given to the use of the British Museum Library. A few days ago a question was asked in the House of Commons by Mr. D. Grant, whether the Trustees were prepared to make arrangements for lighting the building so that the scientific collections and other portions of it might remain open to the public until 10 p.m. The answer returned by Mr. Walpole on behalf of the Trustees was unsatisfactory enough. The use of gas would be deleterious to sculptures and books; and experience would not "justify" a more extended use of the electric light in the exhibition-rooms and long galleries. The body of Trustees, though they may be admirable custodians of the national library, appear to have the most limited and provincial notions with respect to the scientific collections which are committed to their charge.

THE ways of official French science are somewhat inscrutable. Some months ago we notified our readers that the *prix Volta*, instituted by Napoleon, had been awarded to Graham Bell for the articulating telephone. It appears that this award was made in accordance with the report of a commission appointed in 1876, of which M. Dumas was president and M. Becquerel secretary, the Commission being unanimous in their award. In their report they also mentioned with high approval the names of M. Gramme, the inventor of the Gramme machines, M. Gaston Planté, whose researches on secondary batteries, &c., are now so well known, and Dr. Onimus, who has done much to advance our knowledge of electro-physiology. But in passing through the hands of the Minister of Public Instruction this report was manipulated in order to please the national vanity by lifting up the claims of M. Gramme above those of MM. Planté and Onimus, and eventually a grant of 70,000 francs was voted by the Chamber, 50,000 francs being the prize awarded to Prof. Bell, and 20,000 francs to M. Gramme. No one will grudge M. Gramme his prize, though we cannot help thinking that this secondary award will give rise to invidious comparisons of claims, for M. Gramme is not the first nor yet the last in the field amongst electrical engineers and inventors.

THE fund established by the Birmingham Philosophical Society for the endowment of scientific research now amounts to 820*l.*, which will be invested, the interest only to be used. The subscription list amounts to over 80*l.* a year. A donation of 25*l.* has been received from Mr. Charles Darwin, who, in a letter received from him by Mr. Lawson Tait, a member of the council of the Society, says:—"I saw something in the newspapers about the fund, and admire greatly the noble spirit of Birmingham."

WE have often referred to the enterprise of the Midland Union of Natural History Societies, and now they have gone in for the encouragement, if not the endowment, of original research. The Council, at the last annual meeting at Northampton, submitted for consideration a proposal to the effect that an annual prize should be provided for the purpose of recognising and encouraging original research by members of the societies in the Union. After careful consideration by the committee at a meeting held at Birmingham on July 15, the following scheme was adopted:—1.

That a prize (by permission of Mr. Ch. Darwin, F.R.S., to be called "The Darwin Prize") of the value of 10*l.*, to include a gold or bronze "Darwin Medal," at the option of the successful candidate, be given annually for a paper indicating original research upon a subject within the scope of the societies in the Union, contributed by a member for publication in the journal of the Union. 2. That the subjects for "The Darwin Prize" for the three years ensuing be limited as under:—In 1881 to Geology, in 1882 to Biology, in 1883 to Archæology. 3. That a committee of five, annually elected for the purpose by the Committee of Management, adjudicate the prize to such paper, of sufficient merit, on the subject of the year, contributed as aforesaid to the journal of the Union (the *Midland Naturalist*), either actually published or sent in for publication during the twelve months preceding March 31 of that year, and declare the adjudication at the annual meeting. 4. That right be reserved for the adjudicators to withhold the prize if in their opinion no contribution has been sent in of sufficient merit. The scheme is a happy one, and might with great advantage be adopted by other groups of societies all over the kingdom. Mr. Darwin, in giving permission for the use of his name in connection with the medal, says: "It is particularly pleasing to me to have my name connected, in however indirect a manner, with a scheme for advancing science—the study of which has been my chief source of happiness throughout life."

THE death is announced of M. Lissajous, the discoverer of the well-known Lissajous figures, and author of a number of elegant and valuable scientific memoirs. M. Lissajous, who was Professor of Physics at Toulouse, was one of the founders of the Société Française de Physique.

A COMMITTEE has been formed to erect a statue to the late Dr. Broca by public subscription.

WE have received the following details with reference to the career of the late Mr. W. A. Lloyd:—Born in Wales, he early developed a taste for study, and in his early years went deeply into such subjects as archæology, numismatics, and heraldry. In 1852 he turned his mind to natural history, especially as regards marine life. The first really successful marine aquarium was that at Hamburg, which was wholly devised by him, and in which the circulating principle was the great element of success. In 1870 he was engaged by the Crystal Palace Company to construct and superintend the fine aquarium there, which, although not large, is probably one of the best existing. His reputation spread, and he was consulted for almost every new aquarium that was projected. Besides his practical knowledge of the aquarium, he was a man of very considerable culture, and contributed largely to the literature of the subject. At the time of his death he was engaged on a work comprising all his life-long experience, which unfortunately he has not completed. His death, at the age of fifty-six (July 13), was the result of effusion of blood on the brain, and took place at his study table, where he was at work. Mr. Lloyd was connected with aquaria at Paris, Vienna, Dresden, Frankfort, Naples, New York, San Francisco, Melbourne, Adelaide, Calcutta, Rhyll, Yarmouth, Tynemouth, Nottingham, Morecambe, Edinburgh, Westminster, Southport, Rothesay, Aston, and possessed the only medals (gold, silver, and bronze) ever awarded for aquaria.

THE Committee of Council of the British Medical Association have awarded the gold medal of the Association to William Farr, C.B., M.D., F.R.S., D.C.L., "as an expression of their high appreciation of his long, unwearied, and successful labours in behalf of statistical and sanitary science; as a recognition of the light he has thrown upon many physiological and pathological problems; and on account of the extraordinary services

his work has rendered to the advancement of the health of the nation." The presentation will be made in the Senate House, Cambridge, on Thursday, August 12, at half-past twelve in the afternoon.

THE French Parliament has voted a sum of 300,000 francs for purchasing from the City of Paris the grounds which had been rented for a nominal sum to M. Leverrier by the Municipal Council, and had been already annexed by the great astronomer to the Observatory. The reason for this resolution is the impending erection of a new monument, which, according to the provision of the French law, cannot be built except on ground the freehold of which belongs to the Government.

THE first of the great annual Congresses, that of the Archaeological Institute, commenced proceedings at Lincoln on Tuesday.

THE summer meeting of the Institution of Mechanical Engineers will be held at Barrow-in-Furness from Tuesday to Friday next week. A number of technical papers will be read, and several interesting excursions have been arranged for.

SIR W. HARCOURT stated in the House of Commons on Thursday that the Commissioners on Explosions in Coal Mines hoped to make their report at the end of the present or beginning of next year.

THE first annual meeting in connection with the Parkes Museum of Hygiene was held at the Mansion House on Tuesday, when a number of eminent medical men were present. The Museum has so expanded that a building specially designed for it has become necessary. It has attracted a considerable number of visitors, and during the past winter a series of demonstrations have been given by members of the executive committee. The various speakers testified to the great educational value of such a museum, and the absolute necessity for all classes to know something about sanitary science.

THE Council of Public Hygiene of Paris, on the proposition of M. Pasteur, has decided to erect two establishments, one at each end of Paris, intended for the disinfection by steam of all furniture or clothing contaminated by individuals attacked by any contagious diseases.

AN official despatch from Manila of the 20th inst., giving some additional particulars of the earthquake, states that the first shock lasted seventy seconds, and that nine of the native inhabitants were killed and eleven others injured. A second shock, lasting forty seconds, occurred at four o'clock in the afternoon. At Leguno and Rabacan some of the public buildings were also thrown down. The earth opened in several places, and jets of boiling water and showers of ashes were ejected from the fissures. Another shock is stated to have occurred on the evening of the 24th. Other accounts received state that the period of seismic disturbance commenced on the 13th inst., and that repeated shocks have occurred since then, those of the 13th and 20th inst. being the most violent. The cathedral and the barracks at Manila have fallen in, and the troops are now encamped outside the city. Almost all the volcanoes of the island of Luzon are in full activity.

A SHARP shock of earthquake occurred at Naples at 3.30 on Sunday morning, preceded by lighter shocks at regular intervals, beginning at 9.30 the previous night. The principal shock was undulatory from east to west, lasting five seconds, and was sufficiently strong to awake all the inhabitants of Portici. Venuvius shows increased activity. Several new fissures have opened, sending lava streams eastwards.

THE Epping Forest and County of Essex Naturalists' Field Club held a meeting at Ilford last Saturday for the purpose of

visiting the well-known pits which have yielded such a rich harvest of Post-glacial mammals, &c. A well-preserved jaw of *Bos primigenius* was exhumed in the presence of the members. The zoology of the period and the geology of the district were respectively treated of by Sir Antonio Brady and Mr. Henry Walker, the conductors for the occasion. After spending some time in the pits the meeting adjourned for tea to the "Angel Inn." The president announced that as the result of the Field Meeting at the ancient earthworks in Epping Forest (already noticed in these columns) it was decided, in accordance with a suggestion made by Major-General Pitt-Rivers, to apply for permission to excavate in one or both of the camps, and to start a fund for this purpose. As the period of these camps was quite unknown, this would be the only method of arriving at any definite conclusion concerning them. A discussion upon the results of the afternoon's excursion then took place. Sir Antonio Brady brought for exhibition a large number of specimens from his valuable collection of Palæolithic and Neolithic remains; and remarks of great scientific interest were made by Mr. A. R. Wallace, Mr. Worthington Smith, &c. The Club appears to be in a flourishing condition, as it already numbers over 200 members.

M. GAUTHIER VILLARS is publishing, at the expense of the Laplace family, a new edition of the works of the illustrious astronomer. The reason of this republication is very singular. The widow of the Marquis de Laplace bequeathed a certain sum of money to the Academy in order to deliver every year a copy of the works of her husband to the youth who obtains the first rank in the leaving examinations at the Polytechnic School. But latterly it has become almost impossible to find these volumes in the trade. M. Gauthier Villars and executors *in perpetuo* are obliged to deliver gratis a copy every year to the Academy.

PROF. CHURCH was lecturing last week at the Cirencester Agricultural College on "Some Recent Advances in Agricultural Chemistry."

A FRENCH journal states that the first astronomical instruments intended for a great astronomical observatory, to be established at the Trocadéro, have been recently mounted on the first terrace of the east tower of the palace.

ON August 8 the pupils of all the schools of the Arts et Métiers of France meet at Liancourt to celebrate the 100th anniversary of the foundation by the Duc de la Rochefoucault-Liancourt of the first establishment of this kind at his private residence. There are four of these useful schools—Aix, Angers, Chalons, and Cluses—in existence in France, and one in Algeria, of very recent creation, at Delhys. It is said that each of the two provinces of Oran and Constantine will establish, at their own expense, a similar institution.

THE President of the Republic has conferred a knighthood in the Legion of Honour on M. Serrin, the inventor of the first regulator which could be used in lighthouses; and on M. Gariel, the general secretary of the French Association for the Advancement of Science, who will lecture on Radiant Matter at Rheims in the forthcoming session.

"TASMANIAN Friends and Foes, Feathered, Furred, and Finned," is the title of a work, illustrated by woodcuts and coloured plates, upon the Natural History of Tasmania, to be issued this autumn by Messrs. Marcus Ward and Co. The volume is from the pen of Mrs. L. A. Meredith, the author of several well-known works upon this colony, and gives in a popular style accounts of the kangaroos, bandicoots, wombats, and other marsupials, the birds and fishes. Several of the species described the author believes to be new to science, and the marvellous intelligence displayed by some of these lowly-



classified mammals when kept by the author as household pets will be both new and interesting to English readers.

THE additions to the Zoological Society's Gardens during the past week include a Green Monkey (*Cercopithecus callitrichus*) from West Africa, presented by Mr. Fred Peake, F.Z.S.; a Great Eagle Owl (*Bubo maximus*) from Nyland, South Finland, presented by Mr. Lindsay von Julin; two Ocellated Turkeys (*Meleagris ocellata*) from Yucatan, Mexico, presented by Mr. W. E. Sibth; a Crimson-crowned Weaver Bird (*Euplectes flammeiceps*), two Red-backed Pelicans (*Pelecanus rufescens*) from West Africa, two Common Blue Birds (*Sialia wilsonii*) from North America, two Great Eagle Owls (*Bubo maximus*) from India, five Four-rayed Snakes (*Elaphis quater-radiatus*), Black-spotted Snake (*Elaphis diene*), a Lacertine Snake (*Colepeltis lacertina*), four Dahl's Snakes (*Zamenis dahlii*), thirteen Vivacious Snakes (*Tachymenis vivax*), a Four-lined Snake (*Coluber quadrilineatus*—var. *leopardinus*), South European, deposited; five Australian Wild Ducks (*Anas superciliosa*), three Garganey Teal (*Querquedula circea*), three Common Teal (*Querquedula crecca*), two Horned Tragopans (*Cerionis satyra*), a Peacock Pheasant (*Polyplectron chinquis*) and a Bronze-winged Pigeon (*Phaps chalcoptera*), bred in the Gardens.

OUR ASTRONOMICAL COLUMN

FAYE'S COMET.—The following ephemeris of this comet is for Berlin midnight, and is calculated from elements accurately perturbed to the approaching perihelion passage, which were communicated by Dr. Axel Möller to the Academy of Sciences at Stockholm in September, 1878.—

Aug. 1	R.A.		Decl. N.	Log. dist. fr. Earth.
	h. m. s.			
1	23	16 14	10 35'5	0'1859
3	—	16 16	10 40'3	0'1784
5	—	16 12	10 44'3	0'1709
7	—	16 3	10 47'2	0'1635
9	—	15 48	10 49'2	0'1562
11	—	15 28	10 50'2	0'1490
13	—	15 3	10 50'1	0'1419
15	—	14 33	10 48'9	0'1349
17	—	13 57	10 46'6	0'1280
19	—	13 17	10 43'2	0'1213
21	—	12 31	10 38'6	0'1147
23	—	11 42	10 32'8	0'1083
25	—	10 47	10 25'8	0'1021
27	—	9 49	10 17'5	0'0961
29	—	8 47	10 8'0	0'0903
		23 7 41	9 57'3	0'0847

The theoretical intensity of light at the end of the month will be twice as great as at the beginning, when it somewhat exceeds that corresponding to the last observation at Pulkowa in March, 1866. At the return in 1873 the comet was observed on four nights only at Marseilles and at Clinton, New York; the admirable calculations of Dr. Axel Möller gave positions which exhibited hardly appreciable differences from the observations. In the present year it will be nearest to the earth on October 3 (distance = 1'09), and perhaps most favourably circumstanced for observation during the last ten days of the same month, though at no time does the intensity of light exceed its value on 16, 1858, when the comet was last observed at that appearance with the 10-inch Berlin refractor. The perihelion passage does not take place until January 22, 1881, and although Dr. Axel Möller's ephemeris does not extend beyond the end of the present year, it appears possible that the comet may be observed till quite the end of next February, when its place will still be commanded on a dark sky-ground, or perhaps later; indeed, on April 26, when the comet sets three hours after the sun, its intensity of light is equal to that at the last observation at Pulkowa in 1844.

THE OBSERVATORY, CHICAGO.—The "Annual Report of the Board of Directors of the Chicago Astronomical Society, together with the Report of the Director of the Dearborn Observatory," dated May 13, 1880, is before us. During the preceding year the Observatory had been in charge of Prof. G. W. Hough, formerly of the Dudley Observatory, Albany,

Prof. Colbert and Mr. S. W. Burnham taking part in the regular work with the 18½-inch Alvan-Clark refractor. Mr. Burnham's attention, as in previous years, was chiefly directed to the measurement of double stars, including the more interesting binary systems and objects beyond the scope of smaller instruments. A series of observations of the planet Jupiter was commenced on August 27, 1879, and continued on every fine night till February 11. With a magnifying power of 638 the disk was measured on eight nights by Prof. Hough, and six by Prof. Colbert, the resulting values for ellipticity being respectively 1-16'23 and 1-16'73, sensibly smaller than Struve's value, though not differing much from other more recent determinations. The measures further showed "the figure of Jupiter's disk to be a true geometrical spheroid." The belt system during the opposition of 1879 is indicated by the following numbers, the equatorial diameter at the planet's mean distance being 38"70, and the polar diameter 36"32.

No. 1 ...	+ 15"10	No. 5	— 6"94 Red spot.
" 2 ...	+ 9"78	6 ...	— 9"83
" 3 ...	+ 5"98	N. edge of	7
" 4 ...	+ 2"59	equat. belt.	
		S. edge of	
		equat. belt.	

An examination of which shows that the belts were symmetrically arranged on either side of the equator, the large red spot coinciding nearly with belt (5). Prof. Hough remarks that the faint belts are not seen with small instruments, in which there is merely a darkening towards the poles. The middle of the great equatorial belt was subject to gradual change in its appearance between September 1 and November 1. At first it was made up essentially of three separate belts, approximately of equal width; gradually it formed in two nearly equal portions with a rift extending through a large part of the planet's circumference. The colour of the equatorial belt was reddish-brown—brick colour. The red spot was studied from September 3 to February 10. Its colour was similar to that of the equatorial belt, but brighter, and appeared sensibly the same when only partially on the disk as when on the centre. The mean value of its length at the centre of the disk was 12"73, and its breadth 3"56, for Jupiter's mean distance; the length appeared to vary to the extent of two seconds, and the breadth about the same amount, but owing to the irregular outline of the object it was difficult to decide whether actual change took place, or whether the discordances in the measures were due to indifferent vision. By observations extending from September 25 to February 10 the time of sidereal rotation was found by Prof. Colbert to be 9h. 55m. 34'2s. The diameters of the satellites were measured on three nights with the following results for the planet's mean distance:—

I. 1"114	... II. 0"980	... III. 1"778	... IV. 1"457
----------	---------------	----------------	---------------

Prof. Hough states that the two interior satellites of Uranus reported by the Washington observers to be "the most difficult well-known objects in the heavens" can be "readily seen and measured under ordinary atmospheric conditions" with the Chicago refractor; micrometrical observations of *Ariel* were obtained on four nights, *Umbriel* appears to have been measured on one night only, but the weather was unusually adverse to this class of observations.

PHYSICAL NOTES

A SINGULAR phenomenon was seen (according to the *New York World*) recently off the coast of Florida by the officers of the brigantine *Fortunate*. Shortly after dark two columns of fire appeared, seemingly a mile away. They were fifty yards apart and about 500 feet high, arching towards one another at the top, but without meeting. They were of a dull red colour, without sparks; but the arching portions emitted tremulous rays or streamers of light like those of the aurora. They were visible all night, but faded at daybreak. The weather was fine, not a cloud being seen all night. The following day there was a gale of wind accompanied by thunder, but no rain. It is not stated in what quarter of the heavens the appearance was seen. Could it have been an *aurora*?

M. MARCEL DEPREZ, the ingenious inventor of many pieces of electrical apparatus, has just brought out a new electric motor, in which a piston of soft iron is attracted up and down in a hollow cylindrical electro-magnetic coil with a motion like that of an

ordinary steam-engine piston. This principle is not new, having been employed by Page, Bourbouze, and Du Moncel in the construction of electro-motors. The novel point however about the motor of M. Deprez is that the magnetism of the soft iron core is never either reversed or interrupted. This was the weak point of the earlier machines, but it has been obviated in the new form by the device of dividing the solenoidal coil into sections like the separate coils of the ring-armature of the Gramme machine, the current being thus transmitted first to one part of the cylindrical coil and then to another. The commutator which distributes the current successively to the various sections is worked by an eccentric on the shaft of the fly-wheel in the ordinary way, but the "lead" does not require to be so much as a quarter of a revolution.

THE phenomena of explosion of bombs by freezing of water (once studied by Major Williams at Quebec) have been further elucidated by Prof. Hagenbach of Bâle (*Archives des Sciences*, June 15), who exposed, last winter, two iron bombs 15 cm. exterior diameter and 2.2 cm. thickness, filled with water and closed by screw stoppers, at temperatures descending to  $-20^{\circ}$ . One bomb, placed out early in the afternoon, burst next morning about 7; the other, exposed about 10 a.m., exploded about 9 p.m. In the latter case the stopper was violently projected to a distance and could nowhere be found (the spotless snow around would have soon revealed its position, if anywhere near). Some parts of the screw thread were detached; there were several fissures round the orifice, and a cylinder of striated ice was forced out, having an irregular top and a curious upward curved filament of ice attached, narrowing from 9 mm. to 3 mm. diameter, and flattened on its upper concave surface. It is thought a little water in suspension got out by the first opening in the screw, flowed down the bomb, and froze; its freezing provoked crystallisation of the whole mass, and the stopper was expelled, the ice following and lifting the attached frozen vein. A little later some water within the expelled cylinder probably froze and burst the top of this cylinder into four pieces, which twisted like petals, causing the filament to turn upwards. The other case was perhaps even more curious. The stopper was not thrown out, but the bomb burst, a triangular piece next the stopper being raised. A round filament curving downwards was here found attached to the protruded ice, and it had some sixteen enlargements or nodes, equidistant 7 mm. The initial jet of water had probably come out with high velocity and straight course, and been solidified, afterwards curving down by the action of gravity. The nodes were doubtless due to the vibratory motion observed in liquid veins.

IN a recent paper to the Vienna Academy (June 10), Prof. Reilinger and Dr. Wächter throw some new light on the nature of "electrical ring-figures." They consider these to arise from two causes not clearly perceived before; first, a disruption of the metal, with projection of solid, fused, and vaporised particles from it by positive electric potential alone; and second, an electro-chemical decomposition of aqueous vapour present in the atmosphere in which the figures are produced, between point and plate. To the first-named cause is due the *disruption disk* (*Aufreissungsscheibe*) in the centre of positive or mixed figures, and appearing oxidised in air, but metal-bright in hydrogen (it affords a new mode of distinguishing positive electricity from negative). With a strong spark (from a Ruhmkorff strengthened with a Leyden jar) the authors got *dispersion and condensation rings* round the disk, presenting various metallic colourings in dry hydrogen. To the second cause (electro-chemical decomposition of water-vapour) are attributed the various-coloured *oxide rings*, giving the ring-figures observed by Priestley, Nobili, Grove, Riess, &c., and Peterin's *bright disks*. The former occur where positive, the latter where negative, electricity passes from the plate into the air. Thus all the ring-figures observed consist of four "form-elements," viz. (1) central disruption-disks; (2) oxide rings; (3) bright disks; and (4) dispersion and condensation rings. It is further found that all these kinds can be altered in form by a magnet.

ACCORDING to the dynamical theory of gases it is probable that the exponent characterising the relation of the coefficient of diffusion to the absolute temperature is higher by unity than in the case of coefficients of internal friction. This has been fully confirmed by experiments of Herr v. Obermayer (*Wien. Akad. Anz.*, May 7), which give, for permanent gases, approximately  $\frac{1}{2}$ , for coercible 2 (the lower exponents being  $\frac{1}{2}$  and 1). The experiments extended over too few gas-mixtures to determine how

the exponent is affected when a coercible and a permanent gas diffuse into each other.

DON EDUARDO LOZANO of Teruel, Spain, has lately published a modest little volume of ninety pages, entitled "Estudios Físicos," in which some of the more recent advances in physical science are explained in an easy and popular form. Amongst the topics are the blue of the sky, the mechanical equivalent of heat, atmospheric electricity, &c. It is interesting to observe such signs of a revival of interest in the physical sciences in Spain. It is somewhat of a novelty to find the names of Mayer, Hirn, Wells, Dove, and Tyndall in a Spanish treatise; and we draw a good augury from this sign that these names have already penetrated into a country where science has unfortunately been so long at a low ebb.

A BUNSEN burner of modified form has been contrived by M. Terquem which promises to be well adapted for spectrum work and for producing monochromatic light. Instead of the usual two lateral apertures to admit air, the air is allowed to penetrate between the foot of the lamp and the base of the vertical tube, which is for this purpose raised 6 or 7 millims. above the solid foot. The top of the tube is divided into four by a couple of vertical partitions, so that instead of the usual central cone in the flame there are four cones. It is claimed for this flame that it is more solid, and that the temperatures throughout the different parts of the flame are more nearly equal than in the usual Bunsen burner. To procure monochromatic light it suffices to place a small fused bead of sodic chloride between the four central cones of flame.

FOLLOWING out his recent discovery that the prolonged action of the actinic rays upon a sensitised photographic plate produces a reversal of effects, M. Janssen has obtained some interesting results. He has by direct exposure taken a positive photograph of the sun 10 centims. in diameter, showing the spots in their usual dusky tints. He has, after exposures varying from one hour to three hours, obtained perfect positives of landscapes. A view of the park of Meudon thus photographed shows the sun as a white round spot upon a dark sky. Moreover, from such positives other positives can be printed by prolonged exposure; and it is now possible to obtain negative prints of negatives by the same simple expedient. M. Janssen promises at an early date a complete and searching memoir on the whole subject of photography in relation to the different rays of the spectrum.

AN electrical stone-breaker is the latest American invention. A dynamo-electric machine furnishes the power to an electro-magnetic chopper capable of delivering from 1,000 to 2,000 blows per minute. Stone-breaking requires the exertion of very great forces through very small distances, in fact precisely the kind of work for which electro-magnetic machines on a large scale might be expected to be successful, if only the cost of generating the electricity were not so serious.

IN a recent valuable paper on the thermal and optical behaviour of gases under the influence of electric discharges (*Wied. Ann.*, No. 6), Herr E. Wiedemann first studies the thermal phenomena in the case of discharges of the influence-machine, and indicates a different behaviour of the positive and the negative electricity. He then describes an experimental attempt at numerical determination of the quantities which produce a change of the band-spectrum of hydrogen into the line-spectrum. He further investigates the nature of the discharge: from the negative electrode in greatly rarefied space. Then he discusses the applicability of other electrical sources, inductoria, large galvanic batteries, and Leyden jars, to spectrum-analytical researches, also the continuous and discontinuous discharges in gases. The paper concludes with theoretical considerations as to the phenomena of discharge in gases and the nature of spectra.

THE known abnormal variation of density of mixtures of acetic acid and water suggested to Herr v. Reiss (*Wied. Ann.*, No. 6) a means of ascertaining whether there were any perceptible relation between the densities and specific heats. He finds that, unlike solid bodies, those mixtures show in general, with increase of density, a proportional increase of specific heat.

AN example of anomalous dispersion by a glowing vapour, viz., that of sodium, has been recently observed by Herr Kundt (*Wied. Ann.*, No. 6). He was preparing for a lecture the well-known experiment of reversal of the sodium line, and per-

ceived that when the absorbent sodium-vapour was very dense and the dark line very broad a peculiar bend outwards appeared in the spectrum at the ends, and on opposite sides, of the line. The cone of sodium vapour in the Bunsen flame acts as a prism with upward horizontal refracting edges. If glowing sodium vapour give dispersion, this cone should give, with horizontal rays passing through it, a vertical (though necessarily impure) spectrum; and if the rays have also passed through a glass prism with horizontal refracting angle, a spectrum of the form above described should be got. From the position, the refractive index of the vapour is greatest for those rays which are most deflected downwards. In agreement with the author's researches on solid bodies and liquids, the refractive index increases greatly as you approach the band from the red side, is less on the green side than on the other, and then quickly increases again. If an actual prism of glowing sodium vapour could be produced, one might observe, even with little thickness of vapour, indications of anomalous dispersion in the narrow absorption lines. Herr Kundt's attempts, however, to change the cone-shaped flame, by means of lateral plates of glass or mica, to a prismatic one, led to nothing.

In a recent paper on the theory of inconstant galvanic elements (*Wied. Ann.*, No. 6) Herr Exner contends that the so-called galvanic polarisation in elements has no existence. The distinction between a Daniell and a Smee element is merely quantitative, not qualitative. What does he mean?

#### GEOGRAPHICAL NOTES

WE understand that a letter was received in London last Saturday from a member of one of the Belgian Expeditions in Central Africa, stating that he had met Mr. Thomson, with the African Exploration Fund's Expedition, on May 18, at a place some ten days' march from Simba's, so that the party had evidently found it necessary to return to the coast by the caravan route to Bagamoyo or Saadani instead of following the original plan of coming out at Kilwa. It is probable that the change of route was necessitated by civil wars among the native tribes. Mr. Thomson has thus had an opportunity, not contemplated at the outset, of passing through a considerable tract of unknown country between the south-east of Lake Tanganyika and Unyamwebe, and it is satisfactory to know that in so doing he has been able to visit Lake Hikwa and settle its proper position, which has been a puzzle to geographers for some time. In a map accompanying the account of Mr. H. B. Cotterill's journey with the late Capt. Elton northwards from the head of Lake Nyassa, this lake is placed with dotted lines in a position which is probably a good deal too much to the south and east of its true locality. The letter above referred to added that Mr. Thomson was in excellent health, and that he claimed to have traversed 2,000 miles of unknown country in the twelve months he had then been on the march. A telegram from H.M.'s Consul-General at Zanzibar, dated July 17, announces the safe return of Mr. Thomson and his party.

MR. ALFRED RABAUD, president of the Marseilles Geographical Society, has just published (Marseilles: Barlatier-Prissat) a brochure entitled "L'Abbé Debaise et sa Mission géographique et scientifique dans l'Afrique centrale," which is accompanied by a photograph of the deceased traveller.

PROF. R. J. VETH, president of the Dutch Geographical Society, has just issued in Italian (Turin: Guido Cora), "Notizia de Selajar et Isole Adiacenti," which is illustrated by an original map of Selajar and other islands of the Celebes group, together with a note by Signor Cora.

THE *Travailleurs*, with the French Government Expedition for the exploration of the Bay of Biscay, left Bayonne on July 17, having on board MM. Milne-Edwards, father and son, Vaillant, of the Natural History Museum; Fischer, assistant naturalist; Marion of Marseilles, Fohn, Perin, and the English naturalists, Dr. Gwyn Jeffreys and the Rev. Mr. Norman. The results of the expedition may be described at the Swansea meeting of the British Association.

#### NEW SCHEME FOR DIRECTING BALLOONS

M. GABRIEL YON, one of the directors of the great Giffard captive balloon, and Mr. E. A. Pearse of Bristol, have each published a pamphlet on the direction of aërostats.

The balloon of each inventor is to be elongated according to the principles of the experiments tried by Giffard in 1852 and by Dupuy de Lome in 1871. The propeller is to be moved by a gas-engine in the Pearse balloon, and by a steam-engine in the Yon balloon. M. Yon proposes to use the gas of the balloon as fuel, but only in proportion to loss of weight produced either by uncondensed steam or by consumption of petroleum.

Nothing can be said to be really impracticable in the Pearse scheme, although Mr. Pearse lacks the aeronautical training which distinguishes M. Yon, an aeronaut who ascended with M. Giffard in 1854, and has witnessed all his experiments. The only essential difference between M. Giffard's scheme and the new system is the place given to the fan, which M. Giffard attaches to the car. Practice will only decide whether the alteration projected is an improvement or otherwise. The reason alleged for the change is the bringing of the fan nearer to the centre of resistance. But it obliges the aeronaut to give to his fans a very small diameter, which requires an immense number of rotations in a second, and consequently represents a loss of power.

The calculations appear to have been made with care by M. Yon and Mr. Pearse. A trial would be greatly desirable, although it is impossible to suppose that the aerial carriage of Mr. Pearse or the directing balloon of M. Yon can possibly bring aeronauts to the North Pole for their inaugural trip, they may be instrumental in eliciting useful facts. We may add to the peculiarities of M. Yon's scheme that he uses a small globe inclosed in the lower part of the aërostat called a compensation sphere, and connected by a pipe with a ventilator, for keeping intact the form of his aerial machine. Mr. Pearse does not appear to be convinced of the urgent necessity of abstaining in any aerial construction from every complication which can be avoided at any cost, and he suggests the adoption of some accessory organs which, although designed to help aeronauts, would tax too much the lifting power or the attention of the aerial sailor. Mr. Pearse supposes that he will be able to navigate the air with an excess of weight, and does not pay attention to the intensity of motive power required to counteract gravitation even in a partial manner. He should certainly take advantage of the pamphlet written by his French competitor, who deals mostly with facts belonging to the public, and on which nobody can, in the present state of science, raise any claim as being his own property.

Both these pamphlets are greatly in advance of similar productions, and are creditable to their writers. Mr. Pearse's pamphlet has been only published for private publication. M. Yon's is printed with a number of plates representing many details; but a directing balloon is so complex a matter that this part of the publication can hardly be said to be complete.

Having been the builder of M. Dupuy de Lome's balloon and one of his crew, M. Yon may be said to have witnessed all the great aeronautical constructions of the age. Next to M. Henry Giffard, of whom he claims to be the pupil, he is the most completely qualified aeronaut to work out the solution of the great problem to which a recent success in photography has given unexpectedly in some respects a practical result.

W. DE FONVIELLE

#### EXPERIMENTS WITH THE WIRE TELEPHONE, CHIEFLY ON STRONGLY MAGNETIC METALS

BY a wire telephone is meant an instrument like that described in NATURE, vol. xxii. p. 168. In most of the experiments mentioned below, the mercury cups there figured were dispensed with, as they are unnecessary when stout wires are used. A small ear-piece with a ferrotypal plate was also used instead of the drum-head, whose special purpose was to reproduce music so as to be audible at a distance. For hearing close at hand the ferrotypal plate is much superior; indeed with the drum many of the sounds alluded to below could not be heard.

So far as I can see yet, the most probable cause of the sound in the wire telephone, when fine wires of ordinary weakly magnetic metals are used, seems to be variation of the longitudinal tension arising from the variation of the heating effect of the current. It is of course quite possible that there may be a lengthening of the wire due to the passage of the current over and above that arising from the heat developed, although such an effect can scarcely be said to be certainly established by experiment as yet.

Besides this cause three others were traced in the course of my experiments: Electrostatic action, external magnetic action, and internal magnetic action.

The following experiment was made with a very fine palladium silver wire, about 13 cm. long, as sounder. I connected the violin and microphone with four Bunsen's cells in circuit with the primary of a small induction coil (resistance of primary '27, resistance of secondary 44), while the wire telephone was put in

circuit with the secondary. With this arrangement the music was reproduced quite audibly, although the quality of the notes was "wiry." This small coil had a movable core, consisting of a bundle of iron wires, and the sound was louder with than without the core.

I next tried a more powerful induction-coil (resistance of primary '3, secondary 320), all the other arrangements being unaltered. The music could then be just heard, but no more.

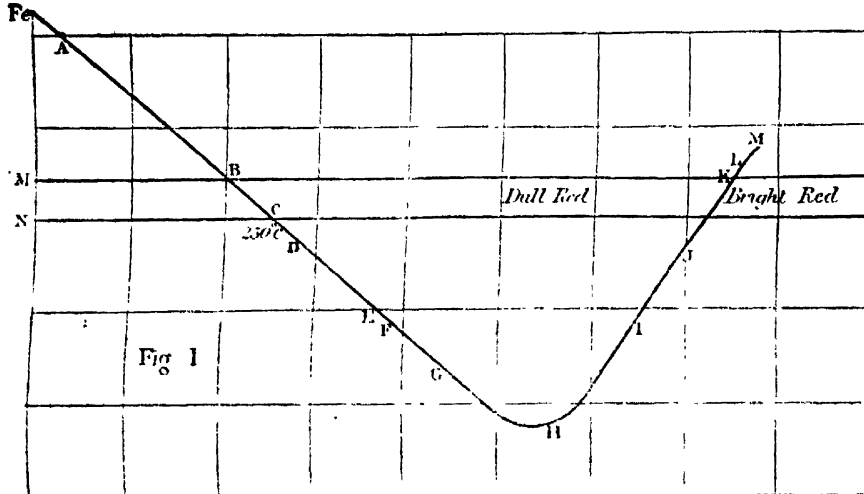

FIG. 1.—Iron.—A, sound very feeble at the temperature of the air; B, high note distinctly heard and increasing; C, feeble sizz now heard; D, sizz increased; E, quality of sound deepening; F, low note heard; G, sound very loud, low, medium, and high notes and buzz; H, no falling off; I, falling off now evident; J, marked diminution; K, sizz very soft, nearly gone; L, high note left; M, silence

A large and very powerful induction-coil (resistance of secondary about 10,000), tried under similar circumstances, gave no result whatever.

**Electrostatic Action.**—As I have said, nothing was heard with the large induction coil when the secondary circuit was closed; but when it was interrupted at a mercury break, a loud hissing, rattling noise was heard. This could not have come by mechanical transmission from the induction-coil, which was several rooms off, the line wires being hung to the walls and jammed over three doors. It had its seat at the mercury pool of the break, and was doubtless due to electrostatic action.

Similar sounds, only weaker, were observed with the smaller Ruhmkorf when the circuit was broken.

If two small disks separated by a small air-interval were made the terminals of an induction-coil, in the primary of which an interrupted current flows, they would form a condenser, and the difference of potential between them would vary in unison with the primary current. Consequently the electrostatic force of attraction would vary, and the disks, being set into vibration, would act as a telephone. The sounds in Thomson's singing condenser are probably due to this cause.

I have not attempted to carry this idea into practice, but I

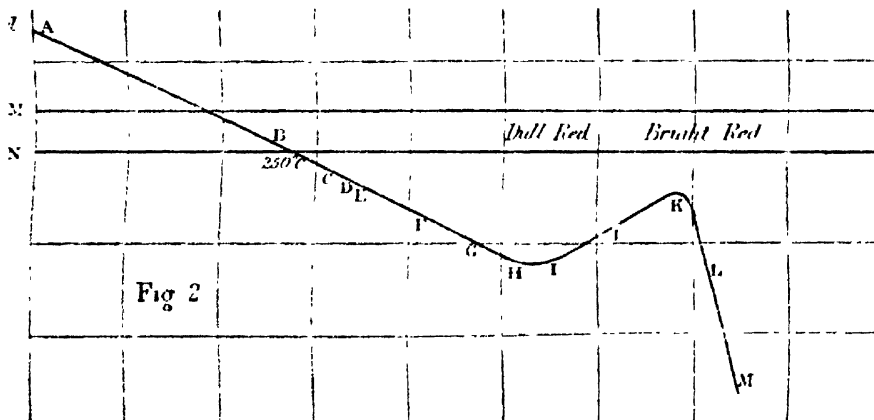

FIG. 2.—Steel.—A, sizzling sound and high note, neither loud; B, silence; C, high note comes in again; D, sharp sizz; E, buzzing sound and general increase of loudness. The other letters as with iron.

believe that telephones have been made on this principle by Edison and others.

**External Magnetic Action.**—If the stretched wire of the telephone be brought into a magnetic field so as to cross the lines of force, and an interrupted current passed, loud sounds are heard. I used a tuning-fork interrupter with two Bunsen's cells. When a thick copper wire was put into the telephone, at first nothing whatever was heard; but when a horse-shoe magnet

was brought up, and held with its plane perpendicular to the wire, the note of the fork was heard very loud (much louder than in the neighbourhood of the fork itself, in fact), and comparatively pure. Little or none of the hissing or buzzing sound of which I shall have to speak by and by can be got in this way. It makes no great difference to the sound produced in this way whether we use a wire of 2 mm. diameter or a wire '3 mm. in diameter. With the thin wire, however, the visible amplitude

of the transversal vibrations is much greater than with the thick. Using a brass wire 15 cm. long and  $\frac{1}{4}$  mm. in diameter, I obtained with a tolerably powerful horse-shoe magnet transversal vibrations of 2 mm. amplitude or more.

The wire telephone, when used in this way, is pretty sensitive

rough way. I found, for instance, that when I brought up a north pole on one side I could neutralise its effects by bringing up a north pole to a proper distance on the other side.

To get these sounds it is by no means necessary to have any elaborate arrangement of stretched wire and so forth. If a magnet be brought up to the wire leading to the telephone, the sound will be heard quite distinctly. If the wire be grasped tightly in the fingers between the magnet and the telephone wire, the sound is stopped, showing that it is transmitted mechanically along the wire. This experiment is certainly not new, but, although I have seen the possibility of such action mentioned (e.g. Wiedemann, "Galvanismus," Bd. ii. p. 602), I have nowhere seen any indication that the sounds are so marked and so easy to produce. I believe that this cause has been at work along with others in many experiments on the sounds obtained in magnetisation; for instance, in De la Rive's experiments. It is impossible, however, to decide with certainty, because no sufficient indications are usually given as to the nature of the magnetic field in which the wire conveying the interrupted current was placed.

The wire telephone arranged in this way with the wire in a strong magnetic field is well suited for reproducing music. Whether it could be adapted for articulate speech, I do not know.

The above experiments of course raise at once the question whether the sounds in the ordinary wire telephone and those I shall describe presently may not be due to the earth's magnetism. To settle this point, I stretched a brass wire 15 cm. long in the telephone; the wire was fine enough to give a feeble sound of itself when the interrupted current of two Bunsen's cells was passed through it. I shifted the apparatus about, so as to bring the wire as nearly as possible into the line of dip, and then placed it perpendicular to that position; but I could not detect the slightest change in the intensity of the sound. If it be borne in mind that here the distinction between wires as to their thickness is only important in so far as it affects their stiffness, it will, I think, be clear that this experiment settles that the earth's magnetism is not an operative cause with the current strengths I generally used. Another proof of this will be given by and by.

*Effects due to the Magnetism of the Telephone Wire itself.*—The following experiments were made with a view to test a conjecture of Prof. Tai's, referred to in a letter to NATURE, vol. xxii. p. 168, and to settle, if possible, the cause of the exceptional behaviour of iron wires in the experiments of De la Rive and Dr. Ferguson.

Two Bunsen's cells were used throughout, and the current was interrupted by a tuning-fork driven by an auxiliary battery.

My first experiment was made with an iron wire (A, 19 cm. long, .50 mm. diameter). It gave a moderately loud sound to begin with, a low note with a predominating fizz, not unlike the fizz heard at the mercury cup in the far room (owing, I suppose, to the volatilisation of the spirit by the heat of the spark, which passes when the dipper of the tuning-fork leaves the mercury).

When a portion of the wire was heated with a Bunsen flame the sound increased very much for a short time, and then died away again considerably after the wire got red hot. On allowing the wire to cool, the sound, after a short time, suddenly swelled out and then fell away again. The permanent sound was, however, louder than it had been at first.<sup>1</sup>

I soon satisfied myself, by cautiously bringing the flame up to the wire, that there is a certain temperature at which the sound is a maximum. The wire was heated up to white heat and allowed to cool pretty rapidly, and it was found that the sound was at its loudest at a dull red heat, just before the phenomenon of the re-glow occurred, along with which a peculiar crackling could be heard, due, no doubt, to the abnormal contraction and extension of the iron at that temperature.

Several causes at once suggested themselves. The alteration

<sup>1</sup> This phenomenon was observed by Dr. Ferguson independently, and exhibited to the Royal Society of Edinburgh at the meeting before that at which an abstract of the present paper was read.

of the elasticity of the wire was dismissed as probably not the principal cause at all events; for the increase of the sound begins at comparatively low temperatures. Although I did not expect to find any such thing, I looked for a maximum of resistance at a high temperature by placing the iron wire in one circuit of a differential galvanometer, balancing it with an equal resistance in the other, and then heating. I found, as is already known, that the resistance increases with great rapidity after dull red heat, but obtained no indication of a maximum.

The most probable explanation seemed to be the magnetic properties of the wire. It is well known that the magnetic susceptibility of iron (that is, loosely speaking, its power to become inductively magnetised under the influence of a given magnetic force) is at its maximum about dull red heat; that it declines very rapidly at higher temperatures, and is almost insensible at a bright red heat. The coercitive force of iron, that is, its power to retain magnetism permanently, unaided by external magnetic forces, disappears at a much lower temperature.

The sound in the above experiment depends, therefore, upon temperature in the same way as the magnetic susceptibility of the iron wire. This is strong proof that the sound is simply due to the fact that the iron is magnetised. I convinced myself by direct experiment that the effect extends throughout the whole of the wire, for I found that two flames at different places produced, when properly applied, more effect than one, and that, as I brought more and more of the wire to the proper temperature, the sound grew louder and louder. The fact that on cooling the permanent effect was greater than before probably corresponds to the fact that, under certain circumstances, the permanent magnetism is increased by heating and subsequent cooling,

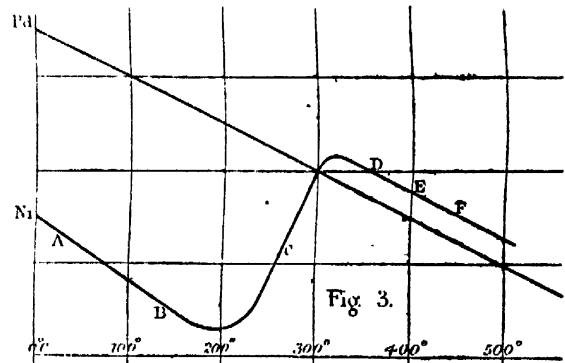

FIG. 3.—Nickel.—A, buzz and low note, both loud; B, low note, gone; C, buzz, tending to soften; D, buzz, gone; E, feeble high note; F, high note.

of which fact it was easy enough to make certain by testing the magnetism before and after heating.

I next took a piece of steel piano wire (B, 20 cm. long, .9 mm. diameter) and mounted it in the telephone. At first no sound whatever could be heard. On magnetising it longitudinally, by stroking once or twice with a pair of magnets, a sound was heard quite distinctly, viz., a gentle fizz accompanied by a high note. On magnetising more strongly this sound became somewhat louder, but retained the same character. Gentle heating with a spirit-lamp decreased the sound; but it recovered its intensity when the wire was allowed to cool, and remained permanently a little louder than at first. Repeated gentle heating and cooling increased the permanent sound somewhat.

The wire was then strongly heated with a Bunsen flame. At first the sound died away to a minimum, then it increased, and was very loud about a dull red, then it fell off again. When the wire cooled the sound rose to a maximum, and then fell off, no minimum being perceptible. After this the permanent sound was a good deal louder, but the diminution on slightly heating could no longer be observed with certainty.

I next heated the steel wire B to white heat throughout, so as to deprive it entirely of all magnetism, and tempered it by dropping it into cold water when dull red. When put into the telephone after this treatment it gave no sound whatever. One stroke with a pair of bar magnets caused it to sound quite distinctly. It gave a gentle fizzing sound along with a very high note. Repeated gentle heating and cooling gave the same

results as I had got before. I then gradually raised the temperature till part of the wire was bright red, and finally allowed it to cool. As the temperature rose, the original fizzing sound died out, then the high note became inaudible, then there was a short interval of almost complete silence; after that a high note came in, then the fizzing sound again, which very quickly changed into a deep buzz, accompanied by a very low note like that of the tuning-fork, a note of medium pitch, and a high note (and possibly others), then the buzz died out, and at last the high note was left. When the wire cooled, the phenomena recurred in the corresponding order. First the buzz came back along with the low and medium notes, then it died away, and the high note alone was left; then there was silence, then the high note again, and lastly the fizzing sound.

Most of the notes heard, certainly the most prominent of them, appear to have little relation to the tuning-fork. They seemed to be affected to some extent by the tension of the wire.

When a magnet was brought up to the wire the deep note, obtained in a similar way with wires of other metals, was heard along with those peculiar to iron and steel.

These experiments with the steel wire appear to me to settle the question as to the cause of the sound in thick iron wires. The fact that the wire can be put into a condition in which no sound is produced, and then made to sound by magnetising it, shows that the action is due to the magnetism of the wire, and is also an additional proof that the earth's magnetism had nothing to do with it.

This view is still further confirmed by the effect of heat on the tempered steel wire. The first effect of heat is to destroy the permanent magnetism of the wire, hence the initial diminution of the sound. At a temperature of about 250° C. the permanent magnetism is much reduced.

On heating farther, the magnetic susceptibility of the steel begins to increase rapidly, until it reaches a maximum about dull red, and then it falls off again very rapidly; hence the increase of the sound to a maximum and the final falling off.

The reason why the minimum cannot be observed with iron, and not always with soft steel, is that with them the permanent magnetism is less and the magnetic susceptibility in general greater at ordinary temperatures, so that the increase of the latter begins sooner and masks the decrease of the former. At a dull red all kinds of iron or steel are much on a par as to susceptibility; hence in the case of hard steel, whose susceptibility begins to increase rapidly only at a pretty high temperature, the phenomena are much more striking, as well as more varied than in the case of soft iron.

On cooling the sound came and went again as usual, leaving, however, a permanent sound of considerable loudness, which was increased by repeated operations of this kind.

As a test of the soundness of the above conclusions I was anxious to examine the behaviour of the other strongly magnetic metals, and Prof. Tait kindly put several pieces of nickel and cobalt at my disposal.

The piece of nickel used was 3 cm. long, 2 mm. broad, and about 6 mm. thick. It was hard soldered to platinum terminals, and mounted in the usual way, after being heated red hot and dipped in water at dull red.

At first it gave a very feeble high note, accompanied by a gentle fizzing sound. One stroke with a magnet caused it to emit a loud buzzing sound. On heating gently this sound was somewhat reduced, and on heating farther the hissing sound died away, and a high note was left, but it too was extinguished before the nickel was visibly hot.

I made some temperature determinations by means of an air-bath and a mercury-thermometer, and found that at 200° C. the buzzing noise first began to be softened down. After 250° C. the diminution appeared rather more rapid, but at 350° C. the sound was still quite loud; after that the falling off was very rapid, and somewhere (say 400° C.) beyond the range of the thermometer, the mercury in which just boiled at the end of the experiment, the sound died out rather suddenly.

The behaviour of nickel is therefore exactly what we should expect from its magnetic properties, for it loses its magnetic susceptibility, according to Faraday and others, somewhere between 350° C. and 400° C.

I found with nickel, as with iron, that the current itself at a certain high temperature could produce much the same effect as I got by magnetising. On testing a piece of nickel after being magnetised by the current I found it to be transversely magnetised. This induced me to try magnetising my nickel strip

transversely, but although I got results this way they were not so good as I had got by magnetising longitudinally.

I was thus led to try the following experiment, the result of which is at least curious. Instead of passing the current through the nickel itself as before, I passed it round two flat pieces of iron electro-magnet-wise. These were placed with their ends pretty close together, and the nickel was stretched between them so that it lay in a nearly uniform field of magnetic force, whose strength varied in unison with the interrupter.

I found that with this arrangement the nickel sounded very much as it did when the current was passed directly through it. The sound was not so loud, but its quality appeared to be the same. The sound, however, was loudest when the plane of the nickel strip was parallel to the lines of force, being very feeble when the plane of the strip was perpendicular to the lines of force.

A piece of watch-spring was tried in the same way, with exactly similar results.

This experiment is of course very nearly the same as some of those by which the sounds due to the magnetisation and demagnetisation of iron are usually demonstrated. A very full account of these sounds will be found in Wiedemann's "Galvanismus," Bd. ii. p. 565 *et seq.*

I tried a piece of cobalt 6 cm. long and 6 mm. broad, 7 mm. thick, in the ordinary way. In its original state it gave no sound whatever. After being magnetised longitudinally by a large number of strokes it gave a sound, very feeble, however, compared with that got in the same way from iron and nickel, or even from hard steel; it was, moreover, more of a pure note and less of a hissing noise. Heating in the first place diminished this initial sound, so that there came an interval of comparative silence, then the sound rose again, and by and by the familiar buzz came in; but up to a bright red heat no maximum was reached. On cooling, the phenomena reappeared in the proper order.

Cobalt behaves, therefore, just as we should expect from its refractory magnetic nature.

I may mention one curious phenomenon that appeared once or twice with cobalt and once or twice with a piece of steel. On cooling, after the maximum was past, the buzz had died away, and a period of comparative silence had come, strong beats began to be heard, which lasted for a considerable time, and then died away as the temperature fell. Various causes for these might be assigned. It might have happened that two parts of the metal were at different temperatures, and gave notes nearly in unison. It may very well have been interference between notes due to permanent and temporary magnetism; for in cobalt generally, and with the particular piece of steel in question, the minimum was not marked by the absolute silence which probably indicates cessation of the sound due to permanent magnetism before that due to temporary magnetism begins.

*Relation to Thermo-electric Properties.*—As it seemed to be of some interest to connect these magnetic sounds with the curious thermo-electric peculiarities of iron and nickel brought to light by the recent researches of Prof. Tait,<sup>1</sup> I asked the help of his assistant, Dr. C. G. Knott, who has had great experience in work of this kind.

The sounding-wire, a short piece of which was always used in order to get the phenomenon pure, was inclosed along with a double or triple thermo-electric junction in a small tube made by rolling up a piece of sheet-copper. The tube was then heated up in the blowpipe flame. This was a rough way of setting to work, but it was sufficient for our purpose.

The diagrams (Figs. 1, 2, 3), made by Mr. Knott, with the appended notes, will show the results. I have given the observations made during heating, as being on the whole probably nearest the mark. The cooling, except in the case of nickel, which was inclosed in a wide iron box, and did not require to be raised to a very high temperature, was much more rapid than the heating, and consequently inequalities of temperature due to the different positions of the sounding-wire and the junction would have been more apparent. In point of fact the discrepancy was not great.

The abscissa in the case of nickel is the temperature in centigrade degrees, in the other cases it is the electromotive force of a junction formed of a certain pair of platinum-iridium alloys (called M and N) much used by Tait in his thermo-electric researches, because their lines on his thermo-electric diagram are

<sup>1</sup> *Trans. R. S. E., 1879, 3, vol. xxvii. p. 134, &c.*

nearly parallel (see p. 140 of the paper above referred to). The ordinate in all these cases is the thermoelectric power.

The special feature here is the period of silence at the neutral point of N and steel, viz., about 250° C.

This observation agrees remarkably well with the theory that the initial force in the case of steel is due to its permanent magnetism. According to Faraday, steel loses its coercitive force about the temperature of boiling almond oil. See also Marshall (*Proc. R. S. E.*, 1871-72, p. 605). On cooling, owing doubtless to the fact that exposure to a high temperature had softened the steel, which was very hard to begin with, no period of absolute silence appeared, and beats were heard.

It was difficult to distinguish whether the note at E and F was or was not due to the singing of the Bunsen flame. The observations, on cooling, exactly corroborated those taken during heating.

It appears to me that these experiments establish that a series of sounds are produced by the passage of a varying current through magnetised iron, nickel, and cobalt, which depend on the fact of their magnetism. They are apparently of the same nature as those observed heretofore in magnetising and demagnetising iron.

I believe that the phenomena above described explain the exceptional power of iron wires of considerable thickness, as sounders in the wire telephone. When the iron wire is very thin it is most likely that the effect obtained with thin wires of ordinary metals predominates, and it is possible that the magnetic effect may in that case be very small. I cannot say, however, that I have settled this point, which clearly involves an experimental difficulty.

At all events I hope the above observations will be of sufficient interest to attract notice to a subject which has not been much studied lately, notwithstanding its important bearings on the theory of the telephone, and what is of more scientific importance still, the theory of magnetism in strongly-magnetic bodies, a department of physics which stands in as much need of additional light as any that I know.

G. CRYSTAL

### INTERNATIONAL METEOROLOGY

THE International Meteorological Committee appointed by the Congress of Rome (1879), will hold its first meeting at Berne on the 9th proximo.

The following is the programme of questions to be considered by the Committee:—

1. Report on the action of the Committee since the date of the Congress at Rome.
2. Report of the Polar Conference (Weyprecht's project) held at Hamburg in October, 1879.
3. Proposed Conference for Agricultural Meteorology, summoned for September 6 at Vienna.
4. Proposed comparison of the Standard Instruments of the chief Observatories of Europe.
5. Proposed Catalogue of Meteorological Observations and of Meteorological Works and Memoirs in all languages.
6. Proposed International Tables for the reduction of observations.
7. Proposal for an International Meteorological Dictionary.
8. Report on the Meteorological Organisation of England in 1877, being a Supplement to the Fifth Appendix to the Report of the Roman Congress.
9. Proposal by Capt. Hoffmeyer for an International Telegraphic Service for the North Atlantic.
10. Proposal respecting the exchange of Meteorological Publications by post.

The Circular concerning the meeting, which is issued by Prof. Wild and Mr. Scott, requests all persons wishing to make any communications to the Committee to address them to Mr. Scott, at 116, Victoria Street, during the current month.

A private Conference on the relations of Meteorology to Agriculture and Forestry will be held at Vienna on September 6. The following is the programme of subjects for discussion:—

1. What are the mutual relations of the meteorological elements on vegetation, not only those which are proved to exist, but those which are theoretically supposed to be probable?
2. What observations of meteorological elements are to be particularly attended to, with especial reference to their influence on vegetation?
3. How far, and in what way, can meteorological observa-

tories and stations, without interfering with their other work, include these observations in their sphere of operation?

4. Would it not be useful with a view of establishing special systems of observations for this object, as, for instance, phenological observations, to prepare general instructions?

5. Can, at the present moment meteorological central offices issue weather forecasts for the use of agriculture, with reasonable prospects of utility, and if this question is answered in the affirmative, how can the service be organised as fully as possible?

Preliminary materials for the answers to these questions will be found in the Reports of Dr. Lorenz and Dr. Bruhns to the Roman Congress on Article 35 of the Programme. These Reports have also been published separately in German, and partially in French in the collection issued by the Central Office at Rome of all Reports presented to the Congress. In the latter volume the Report of M. Denza on the same subject is to be found.

### UNIVERSITY AND EDUCATIONAL INTELLIGENCE

A TOWN'S meeting was held at Liverpool last week for the purpose of hearing a report from the committee appointed a year or two ago as to the progress of a scheme for establishing a University College in Liverpool. The report showed that in spite of bad times a very gratifying readiness had been exhibited on the part of a number of the leading residents of Liverpool to contribute to the necessary funds, several of whom had promised sums of 10,000*l.* each for the endowment of different chairs. The Earl of Derby had also promised a similar sum, the result being that 80,000*l.* was already insured. The college is to be upon the broadest basis, being non-sectarian, and offering no disabilities of any kind to intending students. A resolution was moved thanking donors to the fund, pledging the meeting to the furtherance of the scheme, and recommending that the different classes and businesses of the town should form themselves into committees for the purpose of canvassing.

IN reply to a question by Sir J. Lawrence on Monday as to the embarrassed position of the United College of St. Andrews, Sir W. Harcourt stated that the Government would consider the report during the recess, with a view to making some proposal early next session.

A COMMITTEE is to be appointed to inquire as to the existing establishments which are available for intermediate and higher education in Wales.

THE Superior Council of Instruction in France has terminated its second session. The most notable feature has been the introduction of descriptive natural history in the eighth class, that is, in the first step of classical education.

### SCIENTIFIC SERIALS

*Annalen der Physik und Chemie*, No. 6.—On electric expansion, by G. Quincke.—On the thermal and optical behaviour of gases under the influence of electric discharges, by E. Wiedemann.—On the electro-magnetic rotation of the plane of polarisation of light in gases, by A. Kundt and W. C. Röntgen.—On the theory of inconstant galvanic elements, by F. Exner.—On the specific heat of water, by A. Willner.—On the specific heat of mixtures of acetic acid and water, by M. A. von Reiss.—On a changed form of my proof of Maxwell's law of distribution of energy, by O. E. Meyer.—Researches on heat-conduction in liquids (continued), by H. F. Weber.—On anomalous dispersion in glowing sodium-vapour, by A. Kundt.—On a simple method of galvanic calibration of a wire, by V. Strouhal and C. Barus.—Explosive actions by ice, by Ed. Hagenbach.—On the funnel-valve in evacuated tubes, by W. Holtz.

No. 7.—Experiments on stationary vibrations of water, by G. Kirchhoff and G. Hansemann.—On the nature of galvanic polarisation, by W. Beetz.—Key for electric circuits, by the same.—On electric expansion (continued), by G. Quincke.—Experiments for determination of an upper limit for the kinetic energy of the electric current, by H. R. Hertz.—On fluorescence, by E. Lommel.—Researches on heat-conduction in liquids, by H. F. Weber.—On the transverse vibrations of a bar of variable cross-section, by G. Kirchhoff.

## SOCIETIES AND ACADEMIES

## LONDON

Entomological Society, July 7.—J. W. Dunning, M.A., vice-president, in the chair.—Mr. Jenner Weir, on behalf of Mr. J. W. Douglas, exhibited a female specimen of *Noctua cinigrum*.—Mr. McLachlan exhibited a piece of sugar-cane from Queensland much eaten by some undetermined lepidopterous larvæ, of which specimens were shown. Mr. W. L. Distant was able to state that this was a quite distinct larva from that infesting sugar-canes in Madras, of which he had lately received specimens.—Miss Ormerod exhibited specimens of various sugar-cane borers from British Guiana, and read notes thereon.—Mr. Distant exhibited a specimen of the larva of *Hepialus virescens*, the so-called vegetable caterpillar of New Zealand. The spores of *Cordiceps robertsii*, falling on this caterpillar, become parasitic, destroying it, and growing therefrom in the form which has caused many erroneous statements to be made.—Mr. Billups exhibited a larva of *Plusia chrysitis* and some specimens of an ichneumon (*Paxyloma sp.*) that was parasitic thereon.—Mr. Phipson exhibited a remarkable variety of *Tyrannus carolinus*.—A note was read from Mr. Sidney Churchill of Teheran on *Argas persicus*.—Mr. Roland Trimen communicated notes on the pairing of a butterfly with a moth, and on a supposed female of *Dorylus helveticus*, Linn.—Messrs. Godman and Salvin communicated a paper entitled "A list of Diurnal Lepidoptera collected in the Sierra Nevada of Santa Marta, Columbia, and the vicinity."

## VIENNA

Imperial Academy of Sciences, May 13.—On the theory of Volta's fundamental experiment, by Prof. Exner.

June 3.—On a method of indicating the variations of volume of the heart, by Prof. Knoll.—The variation of molecular weight and molecular refractive power (second part), by Dr. Janovsky.—On preliminary determination of the orbit of the planet (178) Belisana, by Herr Ruling.

June 10.—Preliminary communication on the spermogonia of *Acidiomyces*, by Prof. Rothy.—On electrical ring-figures and their change of form by the magnet, by Prof. Reitlinger and Dr. Wachter.—On the magneticability of iron at high temperatures, by Prof. Wassmuth.—On the development of gases from metals, by Prof. Suess.—On the path of the comets 1843 I and 1880a, by Herr Weiss.—On so-called chemical repulsion, by Dr. Lecher.

June 17.—Contributions to an investigation of the phylogeny of plant-species, by Prof. v. Ettingshausen.—Optical notices, by Prof. v. Lang.—On the localisation of functions in the periphery of the human brain, by Prof. Exner.

## PARIS

Academy of Sciences, July 19.—M. Edm. Becquerel in the chair.—The following papers were read:—Researches on the organic alkalis, by M. Berthelot. This relates to ethylamine and trimethylamine, their heat of combustion, &c.—Modifications of respiratory movements by muscular exercise, by M. Marey. The respiratory curves obtained from young soldiers with a (so-called) *pneumograph* show that after a gymnastic course they breathe about twice as much air as before; the number of respirations is reduced from twenty to twelve per minute, but their amplitude is more than quadrupled. At the outset the respiration is considerably modified by running (600 m. in about four minutes), but after from four or five months' exercise this running has no perceptible effect.—On strengthening the immunity of Algerian sheep against splenic fever by preventive inoculations; influence of inoculation of the mother on the receptivity of the foetus, by M. Chauveau. Direct contact of the animal organism with the bacteridian elements is not necessary to its ulterior sterilisation. Preventive inoculations act on the humours proper, which are rendered sterile and sterilising, either by removal of substances necessary to bacteridian proliferation, or rather by addition of matters adverse to this proliferation.—On the construction of the dam of Gileppe, Belgium, by M. de Lesseps.—Ephemerides of comet  $\delta$  1880 (Schäberle), by M. Bigourdan.—Reply to a remark of Mr. Sylvester's concerning the lessons on the theory of numbers of Dirichlet, by M. Dedekind.—On the cause of the fugitive spectra observed by M. Trouvelot on the solar limb, by M. Tacchini. He has often observed such spectra (attributed by M. Trouvelot to solar disturbances) on passage of swallows and other birds across the sun. In simultaneous ob-

servations on these days, by Prof. Ricco, at Palermo (where birds are very rare), such spectra were recorded; and M. Tacchini finds, as one might expect, that they become less frequent as the sun rises in the sky.—On atmospheric electricity, by M. Mascart. His observations at the College of France are recorded by Thomson quadrant electrometer, the deflections of which are being transmitted to a pencil. The two pairs of electrodes are kept at equal potentials of contrary sign by two poles of a battery which communicates with the ground; the needle is connected with a vessel letting flow a continuous stream of water into outer air. Generally the potential of the air, always positive, is found much higher and more uniform by night than by day. From 9 p.m. to 3 a.m. it varies little, falls at daybreak, reaches a minimum about 3 p.m., then rises rapidly to a maximum about 9 p.m. (It is commonly thought there are two maxima, morning and evening; and two minima, one in the day, the other at night. M. Mascart considers insulation has been too much neglected.)—On the alternative currents and the electromotive force of the electric arc, by M. Joubert. When the current intensity is *nil* there is no difference of potential between carbons, but the difference quickly reaches 40 to 50 volts, which is preserved nearly constant till the current is again very weak. The final fall is very sudden. The difference of potential remains the same during the period of the current, though the mean intensity of this is largely varied.—On a new air-thermometer, by M. Witz. This is a sort of Leslie's thermometer with one air-globe kept at constant temperature by means of a thermal regulator of special form.—On some fluorine combinations of uranium with the alkaline metals, by M. Ditte.—On the atomic weight and the principal properties of glucium, by MM. Nilson and Pettersson. The atomic weight is 13.65 if the earth is equal to  $Gl_2O_3$ .—On some combinations belonging to the group of creatines and creatinines, by M. Duvillier.—Action of chloride of ethyl on ethylamine, by MM. Duvillier and Buisine.—Action of electrolysis on borazine, by M. Renard. A new body named isobenzoglyoxal,  $C_6H_4(OH)_2$ , is obtained.—On a peculiar alteration of butcher's meat, by M. Poincaré. He has found cylindrical points, elements, with cuticles crossed by lines which seem outlines of cells, and granulated. He thinks they may be phases or metamorphoses of tannoides, causing tænia in some eaters of raw meat.—On the production of charbon by pasturages, by M. Poincaré. The disease was traced in one case to the grass of meadow being constantly wet with a liquid of marshy look; in this were found numerous bacteria like those in the blood, on injection of it into a guinea pig produced charbon.—Observations on the origin of fibrille in the bundles of connective tissue, by M. Laurantié.—On the Echinida of the tertiary strata of Belgium, by M. Cotteau.

## CONTENTS

CHEMICAL DYNAMICS. By M. M. PATTISON MEIR . . . . .	
A JAPANESE ROMANCE. By H. N. MOSELEY, F.R.S. . . . .	
OUR BOOK SHELF:—	
"Loch Etive and the Sons of Uisnach" . . . . .	
Patterson's "Birds, Fishes, and Cetacea commonly frequenting Belfast Lough" . . . . .	
Prait's "Key to the Universe" . . . . .	
LETTERS TO THE EDITOR:—	
The Recent Gas Explosion.—Prof. HERBERT McLEOD . . . . .	
The Freshwater Medusa.—Dr. GEO. J. ALLMAN, F.R.S. . . . .	
Storm Effects.—J. RAND CAPRON . . . . .	
The Inevitable Test for Aurora.—J. RAND CAPRON . . . . .	
Experiment with Glass Tubes.—J. T. BOTTOMLEY (With Illustration) . . . . .	
On the Colours of Double Stars.—C. S. PEIRCE . . . . .	
Coffee-Disease in New Granada.—Dr. A. ERNST . . . . .	
Toughened Glass.—T. B. SPRAGUE; J. C. J. . . . .	
Large Halitones.—GEORGE PATHERSON . . . . .	
PAUL BROCA. By H. F. C. TEN KATE . . . . .	
THE WOOLWICH GUNS . . . . .	
LIVING ON WATER . . . . .	
WATERFOWL. By P. L. SCLATER, F.R.S. (With Illustrations) . . . . .	
NOTES . . . . .	
OUR ASTRONOMICAL COLUMN:—	
Frye's Comet . . . . .	
The Observatory, Chicago . . . . .	
PHYSICAL NOTES . . . . .	
GEOGRAPHICAL NOTES . . . . .	
NEW SCHEME FOR DIRECTING BALLOONS. By W. DE FONVILLE . . . . .	
EXPERIMENTS WITH THE WIRE TELEPHONE, CHIEFLY ON STRONGLY MAGNETIC METALS. By Prof. G. CRYSTAL (With Diagrams) . . . . .	
INTERNATIONAL METEOROLOGY . . . . .	
UNIVERSITY AND EDUCATIONAL INTELLIGENCE . . . . .	
SCIENTIFIC SERIALS . . . . .	
SCIENTISTS AND ACADEMIES . . . . .	



THURSDAY, AUGUST 3, 1880

MULTIPLE SPECTRA<sup>1</sup>

## II.

I CONCLUDED my last article under the above heading with a reference to the case of carbon, and gave the results successively arrived at by Attfield, Morren, Watts, and others; these went to show that besides the line-spectrum of carbon mapped by Ångström there exists a fluted spectrum of this substance.

Now comes my own personal connection with this matter.

In the year 1878<sup>2</sup> I communicated to the Royal Society a paper in which the conclusion was drawn that the vapour of carbon was present in the solar atmosphere.

This conclusion was founded upon the reversal in the solar spectrum of a set of flutings in the ultra-violet.<sup>3</sup> The conclusion that these flutings were due to the vapour of carbon, and not to any compound of carbon, was founded upon experiments similar to those employed in the researches of Attfield and Watts, who showed that the other almost exactly similar sets of flutings in the visible part of the spectrum were seen when several different compounds of carbon were exposed to the action of heat and electricity. In my photographs the ultra-violet flutings appeared under conditions in which carbon was the only constant, and it seemed therefore reasonable to assume that the flutings were due to carbon itself, and not to any compound of carbon; and this not alone from the previous work done in the special case of carbon, but from that which had shown that the fluted spectra of sulphur, nitrogen, and so forth were really due to these "elementary" substances.

Professors Liveing and Dewar have recently on several occasions called this result in question. Prof. Dewar, in a paper received by the Royal Society on January 8, 1880, writes as follows:—

"The almost impossible problem of eliminating hydrogen from masses of carbon, such as can be employed in experiments of this kind, prove conclusively that the inference drawn by Mr. Lockyer, as to the elementary character of the so-called carbon spectrum from an examination of the arc in dry chlorine, cannot be regarded as satisfactory, seeing that undoubtedly hydrogen was present in the carbon used as the poles."

Subsequently in a paper received by the Royal Society on February 2, Messrs. Liveing and Dewar wrote as follows:—

"Mr. Lockyer (*Proc. Roy. Soc.*, vol. xxvii. p. 308) has recently<sup>4</sup> obtained a photograph of the arc in chlorine, which shows the series of fluted bands in the ultra-violet, on the strength of which he throws over the conclusion of Ångström and Thalèn, and draws inferences as to the existence of carbon vapour above the chromosphere, in the coronal atmosphere of the sun, which, if true, would be contrary to all we know of the properties of carbon. We cannot help thinking that these bands were due to the presence of a small quantity of nitrogen."

It will be seen that on January 8 Mr. Dewar alone attributed the flutings to a hydrocarbon, while on February 2 Mr. Dewar, associated with Mr. Liveing, attributed them to a nitrocarbon.

<sup>1</sup> Continued from p. 7.  
<sup>2</sup> The approximate wave-length of the brightest member on the least refrangible edge is 3880.  
<sup>3</sup> *Proc. R. S.*, No. 127, 1878.  
<sup>4</sup> That is, in 1878.—J. N. L.

In fact in the latter paper Messrs. Liveing and Dewar published experiments on the spectra of various carbon compounds, and from their observations they have drawn the conclusion that the set of flutings which I have shown to be reversed in the solar spectrum is really due to cyanogen, and that certain other sets of flutings shown by Attfield and Watts to be due to carbon are really due to hydrocarbon.

As Messrs. Liveing and Dewar do not controvert the very definite conclusions arrived at by Attfield, Morren, Watts, and others, I can only presume that they took for granted that all the experimental work performed by these men of science was tainted by the presence of impurities, and that it was impossible to avoid them. I therefore thought it desirable to go over the ground again, modifying the experimental method so as to demonstrate the absence of impurities. Indeed I have started upon a research which will require some time to complete. Still, in the meantime, I have submitted to the notice of the Royal Society some results which I have obtained, which I think settle the whole question, and it is the more important to settle it as Messrs. Liveing and Dewar have already based upon their conclusions theoretical views which appear to me likely to mislead, and which I consider to have long been shown to be erroneous. To these results I shall now refer in this place.

The tube with which I have experimented is shown in Fig. 1: A and B are platinum wires for passing the spark inside the tube; E is a small tube into which carbon tetrachloride was introduced; it was drawn out to a long narrow orifice to prevent the rapid evaporation of the liquid during the exhaustion of the tube. The tube was bent upwards and a bulb blown at C in order that the spark might be examined with the tube end-on, as it is found that after the spark has passed for some time a deposit is formed on the sides of the bulb immediately surrounding the platinum, thus obstructing the light. After a vacuum had been obtained the tube was allowed to remain on the Sprengel pump, to which it was attached by a mercury joint for the purpose of obtaining a vacuum for a long time, in order that the last traces of air and moisture might be expelled by the slow evaporation of the liquid.

The carbon tetrachloride was prepared by Dr. Hodgkinson, who very kindly supplied me with sufficient for my experiments.

On passing the spark without the jar in this tube, the spectrum observed consists of those sets of flutings which, according to Messrs. Liveing and Dewar, are due to hydrocarbon, and the set of flutings which is reversed in the sun, and ascribed by Messrs. Liveing and Dewar to cyanogen, also appears in a photograph of the violet end of the spectrum, Fig. 2. On connecting a Leyden jar with the coil and then passing the spark the flutings almost entirely vanish and the line spectra of chlorine and carbon take the place of the flutings without either a line of hydrogen or a line of nitrogen being visible.

As a long experience has taught me that these tubes often leak slightly at the platinum after they are detached from the pump, so that the evidence of such a leak is not satisfactory is only good for a short time, I took the occasion afforded by a visit of Dr. Schuster to my laboratory while

the experiments were being made to get my observations confirmed. He has been good enough to write me the following letter and to allow me to give it here:—

" March 21

"MY DEAR LOCKYER,—The following is an account of the experiment which I saw performed in your laboratory on Monday, March 15:—

"A tube containing carbon-tetrachloride was attached to the Sprengel pump. As exhaustion proceeded the air was gradually displaced by the vapour of the tetrachloride. The electrodes were a few millimetres apart. If the spark was taken without a condenser in the vapour the well-

known carbon bands first observed by Swan in the spectrum of a candle were seen with great brilliancy; I also saw the blue band which you said was identical in position with one of the blue bands seen in the flame of cyanogen or in the spectrum of the electric arc. When the condenser and air-break were introduced this spectrum gave way to a line spectrum in which I could recognise the lines of chlorine. *The lines of nitrogen were absent, not a trace of the principal double line in the green being seen.* The hydrogen line Ha(C) was faintly visible when I first observed the spectrum, but it got gradually weaker and *finally disappeared altogether.* *When this line was no longer visible the condenser was taken out of circuit*

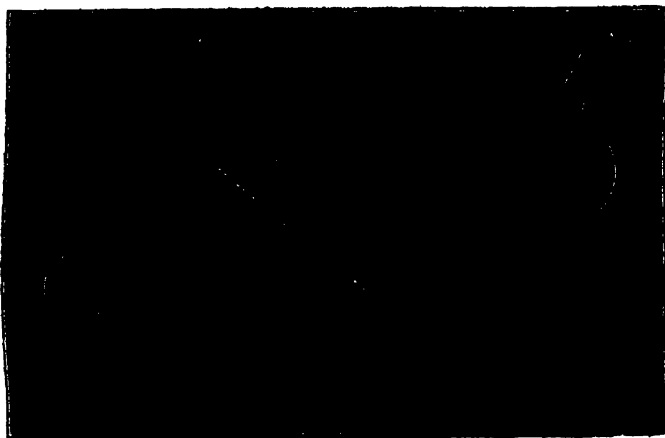

again, and the same carbon bands were seen as before. These bands, therefore, show themselves with great brilliancy when a strong and powerful spark does not reveal the presence either of hydrogen or nitrogen.

" March 21, 1880 (Signed) ARTHUR SCHUSTER "

This result, which entirely endorses the work of Atfield and Watts, has been controlled by many other experiments. I have also repeated Morren's experiment and confirm it, and I have also found that the undoubted spectrum of cyanogen is visible neither in the electric arc nor in the surrounding flame.

Hence then in the case of carbon, as in the prior cases

of hydrogen, nitrogen and the like, those who hold that the flutings are due to impurities must, it would seem, abandon their position; for the flutings are undoubtedly produced by carbon vapour. Nor is this all; the sugges-

acknowledged to attend observations of this substance may in all probability be due to the fact that the sets of carbon flutings represent different molecular groupings of carbon, in addition to that or those which give us the line spectrum, and that the tension of the current used now brings one set of flutings into prominence and now another, seems also justified by the facts. This suggests

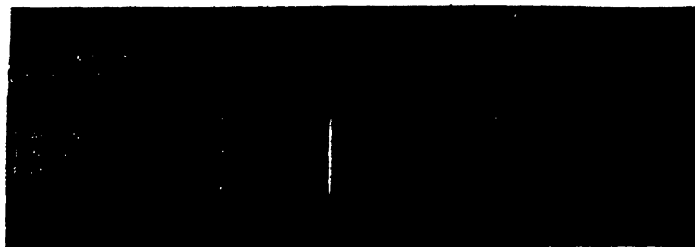

the view that a body may have a fluted spectrum of compound origin as well as a line spectrum.

This conclusion is greatly strengthened by the preliminary discussion of a considerable number of photographs of the spectra of various carbon compounds.

A general comparison of the photographs first enables us to isolate the lines in the blue and ultra-violet portions of the spectrum (wave-lengths 4300-3800) of the substance associated with the carbon in each case.

In this manner the lines seen in the photographs of the spectra of  $\text{CCl}_4$ ,  $\text{C}_{10}\text{H}_8$ ,  $\text{CN}$ ,  $\text{CHI}_3$ ,  $\text{CS}_2$ ,  $\text{CO}_2$ ,  $\text{CO}$ , &c., have been mapped, and both the common and special lines and flutings thus determined.

The phenomena seen with more or less constancy are a blue line, with a wave-length of 4266; a set of blue flutings, extending from 4215 to 4151; and another set of ultra-violet flutings, which extend from 3885 to 3843 (all approximate numbers).

In a photograph of the spectrum of the electric arc (with a weak battery) between carbon poles in an atmosphere of chlorine, the blue flutings alone are visible, whilst, when the spark is similarly photographed, the ultra-violet

flutings and the blue line (4266) are also visible, whilst the blue flutings become fainter.

From this we may assume, in accordance with the working hypothesis of a series of different temperature



Highest temperature.  
Intermediate.  
Lowest temperature.

FIG. 3.—Action of three different temperatures on a hypothetical substance, assuming three stages of complete dissociation.

furnaces, as set forth in the paper of December, 1878 (see Fig. 3), that the different flutings and the line correspond to different temperature spectra, the blue flutings to the lowest and the blue line to the highest temperature, whilst the ultra-violet flutings occupy an intermediate position.

series of horizons forming a perfect gradation between the spectrum which contains the blue line alone and that which contains the blue fluting alone (Fig. 4). In comparing the spectra of carbon under different conditions, I find this to be true. *The blue line never appears in conjunction with the blue flutings, unless the ultra-violet flutings are also*

According to this working hypothesis there should be a

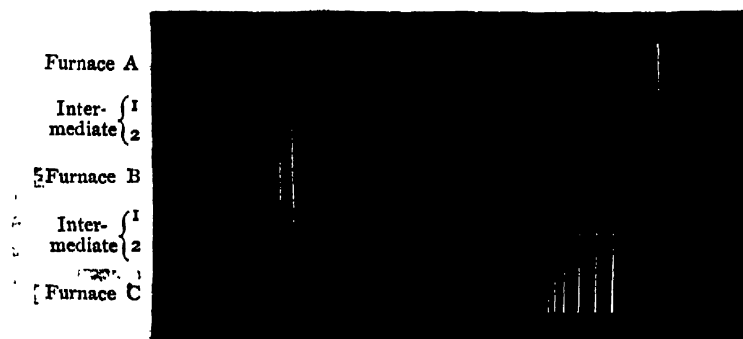

Furnace A  
Inter- {  
mediate } 2  
Furnace B  
Inter- {  
mediate } 2  
Furnace C

Highest Temperature.  
Lowest Temperature.

FIG. 4.—Spectra of the hypothetical substance in intermediate furnaces, assuming that the vapours are not completely dissociated.

present. In other words, the highest and the lowest hypothetical temperature spectra are never visible together without the spectrum of the intermediate hypothetical temperature.

to construct a map, which not only indicates the mere presence or absence of the lines and their relative intensities, but shows a perfect gradation between the spectrum which contains the line alone and that which contains the blue flutings alone (Fig. 5). I would point out that there is nothing theoretical in this map. All the

But this is not all. By placing the spectra of the substances at different heat-levels, so to speak, I was enabled



Highest temperature.  
Lowest temperature.

Spark in  $C_{10}H_8$  and  $CHI_3$ .  
Spark CO.  
"  $CO_2$ .  
" CN.  
" CS.  
Arc in Cl (B).  
" Cl (C).

FIG. 5.—The photographed spectra of some carbon compounds.

horizons depicted are copied from photographs of carbon under the conditions indicated, and theory has merely enabled me to arrange them in order.

seen that, while the blue line gradually thins out, the ultra-violet flutings appear first and grow in intensity. As these increase the blue flutings become visible, and further, as the latter augments and the line disappears, the ultra-violet flutings gradually die out altogether.

This map I submit, therefore, bears out the hypothesis of differences of temperature indicated above, for it is

It is philosophical to infer from these observations that not only are the line and flutings in question produced by carbon, but that the blue line (4266), since it is visible at the highest temperature, corresponds to the most simple molecular grouping we have reached in the experiments, and the flutings to others more complex.

The result to which attention is most to be directed in this place is that touching the two sets of flutings, and should future research justify the double conclusion (1) that these flutings are truly due to carbon, a result I accept, though it is denied by Ångström and Thalèn; and (2) that the different flutings really represent the vibrations of different molecular groupings; a great step, and one in the direction of simplification, will have been gained.

Indeed it is much to be hoped that this ground will be at once worked over again by men of science who are both honest and competent: that the truth is sure to gain by such work is a truism.

I have so often taken occasion to refer with admiration to the work of Ångström and Thalèn that I shall not be misunderstood when I say that their conclusions, to which such prominence is given, and on which such great stress is laid by Messrs. Liveing and Dewar, rest more upon theory and analogy than upon experiment.

Their work, undertaken at a time when the existence of so-called "double spectra" was not established upon the firm basis that it has now, and when there was no idea that the spectrum recorded for us the results of successive dissociations, gave, as I have previously taken occasion to state, the benefit of the doubt in favour of flutings being due to compounds, and it was thought less improbable that cyanogen or acetylene should have two spectra than that carbon or hydrogen should possess them.

Indeed, later researches have thrown doubt upon the view that the fluted spectra of aluminium and magnesium are entirely due to the oxides of those metals instead of to the metals themselves—and this is the very basis of the analogy which Ångström and Thalèn employed.

The importance of the observations to which I have referred is all the greater because of the general conclusions touching other spectra which may be drawn from them. Thus from what I have shown it will be clear that if my view is correct the conclusions drawn by Messrs. Liveing and Dewar from the assumed hydrogen-carbon bands touching both the spectrum of magnesium and the spectra of comets, are entirely invalid. These conclusions are best given in their own words:—

"The similarity in the character of the magnesium-hydrogen spectrum, which we have described, to the green bands of the hydrocarbons is very striking. We have similar bright maxima of light, succeeded by long drawn-out series of fine lines, decreasing in intensity towards the more refrangible side. This peculiarity, common to both, impels the belief that it is a consequence of a similarity of constitution in the two cases, and that magnesium forms with hydrogen a compound analogous to acetylene. In this connection the very simple relation (2 : 1) between the atomic weights of magnesium and carbon is worthy of note, as well as the power which magnesium has, in common with carbon as it now appears, of combining directly with nitrogen. We may

with some reason expect to find a magnesium-nitrogen spectrum. . . .

"The interest attaching to the question of the constitution of comets, especially since the discovery by Huggins that the spectra of various comets are all identical with the hydrocarbon spectrum, naturally leads to some speculation in connection with conclusions to which our experiments point. Provided we admit that materials of the comet contain ready-formed hydrocarbons, and that oxidation may take place, then the acetylene spectrum might be produced at comparatively low temperatures without any trace of the cyanogen spectrum or of metallic lines. If, on the other hand, we assume only the presence of uncombined carbon and hydrogen, we know that the acetylene spectrum can only be produced at a very high temperature, and if nitrogen were also present that we should have the cyanogen spectrum as well. Either, then, the first supposition is the true one, not disproving [the presence of nitrogen, or else the atmosphere which the comet meets is hydrogen only, and contains no nitrogen."

The importance of the question here treated of comes out very well from these two extracts. We find the same spectral phenomenon at once called into court, and very properly called in, both to suggest the existence of chemical substances of which the chemist has never dreamt, and to explain the chemical nature of a large group of celestial bodies.<sup>1</sup>

There is little doubt that when a complete consensus of opinion is arrived at among the workers, other suggestions more far reaching still will be derived from the prosecution of these inquiries. For the present, however, the chief point to bear in mind is that both in line-spectra and in fluted spectra we have indications which I think favour the view that in each case the origin is compound rather than simple.

J. NORMAN LOCKYER

Oban, July 20

### THE EDUCATION DEBATE

THE chorus of approval with which Mr. Mundella's report on the progress of elementary education was received on Monday cannot but be gratifying to all who have at heart the highest welfare of the country. With one or two unimportant exceptions—members whose vision is so bizarre as to discern communism in the education of the children of the working classes, and who connect the increase of weeds with the spread of education—what criticism there was referred to details of method. All the members whose opinions are of any weight agreed that vast good had resulted to the country by the working of the Code. As to the special subjects, among which science is included, the weight of opinion was decidedly in favour of their retention. The greatest friends of the Fourth Schedule will admit that there is still much room for improvement in the teaching of these subjects; it cannot be expected that so great a novelty in the system of elementary education in the country can all at once be taught to perfection. About the success of the compulsory system of education it may be said that the House was all but unanimous. The analogy between the treatment of

<sup>1</sup> With special reference to this last question, that of cometary spectra, one of acknowledged difficulty, I may perhaps be permitted to add here by way of note that the view I put forward some years ago touching the relation of this spectrum to that of the nebulae has been lately strengthened by the observation that at a low temperature one of the brightest lines in the spectrum of iron is that coincident with the chief line in the nebulae spectrum.

paupers and the free education of the children of the working classes will not hold water. In the one case we are simply keeping from starvation people whose improvidence or misfortune have made them a dead burden on their fellows; in the other case we are feeding the minds of those who one day will have to bear the brunt of the work of the nation. The better these future workers are educated, the more intelligently and the more effectively are they likely to do their work, and the less likely are they to become inmates of our workhouses and prisons. As Serjeant Simon testified, even already is there a marked decrease of embryo criminals in our streets. The conclusion comes to Mr. Mundella and those who, like him, have the interests of education at heart, is not that we have gone too far, but that we have not gone far enough; not that we have reached finality, but that we have only made a good beginning. The figures he adduced to prove the success of the existing Education Act were practically admitted to be irrefutable; and we only trust the progress in the next ten years will be at an equal ratio to that achieved during the past decade. "Many of us," he truly said, "would pass away without seeing the full effect of the work we are doing." As to the propriety of encouraging the retention of exceptionally clever boys in elementary schools beyond the regulation age, the figures showed that it would be cruel and unjust to forbid this. Until we have a State system of secondary education in England similar to that about to be sanctioned in Scotland, until an equally decisive step is taken with regard to educational endowments in the one country as in the other, the nation would be doing a gross injustice to force exceptionally clever boys to leave school just when their intellects were beginning to shoot into full vigour. Mr. Mundella showed by his figures that Scotland is still ahead of England in the matter of education; that extra or special subjects are more widely sought after and with greater success, and that a larger percentage of children in elementary schools proceed to secondary education. But it should be remembered that this is the result of many generations of universal education, and that in Scotland it has long been considered as great a disgrace to be uneducated as in England it is considered to be immoral. There among the great majority of the working classes compulsory education was scarcely needed, and this will no doubt be the case in England in the course of a century or so, when education will have become as great a necessity as decent clothing. Again during the debate was it shown by those who have the best means of knowing that where science is properly taught there the children are as a rule more intelligent and bright, and better up in the ordinary subjects than in schools where science is neglected. Sir John Lubbock gave a remarkable instance of the favour with which properly conducted science-teaching is received by the children themselves:—

"He had lately," he said, "visited some of the Lambeth schools, and in one of the last he asked the children which subject they themselves preferred. Out of 229 children in the upper standards, 2 liked grammar best, 11 geography, 31 arithmetic, 38 history, and 147 elementary science. He did not quote this from any wish to exclude the other subjects, but because it seemed conclusive evidence against the proposal to omit elementary science.

He knew that many hon. members, when they thought of children learning these extra subjects, pictured to themselves anxious and weary children poring over a difficult and distasteful task. He wished they would go and see the reality—the bright, happy, intelligent faces of the children, and their delight as they found themselves able to answer the questions rapidly asked them by the master."

We have no intention of repeating the arguments we have so often adduced in favour of the teaching of at least such elementary science in our national schools as will be of practical use in after life and help to render the hard lives of the working classes brighter and nobler, and thus elevate the whole nation. The debate on Monday confirms all that has been adduced in favour of such education, and is the best possible reply to the attack of Lord Norton in the Upper House, an attack which the debate showed to be an anachronism. The whole tone of Mr. Mundella's address must convince all but the most prejudiced that the education of the country could not be in better or safer hands, and that he is not in the least likely to take any step that could be considered rash.

Quite in keeping with the tone of his Education address were his remarks in connection with the vote for the Science and Art Department. With regard to the vote of 4,000*l.* for scientific research, Mr. Mundella said that it was expended under the advice of the Committee and members of the Royal Society, and that of the presidents of the various other scientific bodies. He thought the country could well afford to spend 5,000*l.* on the matters that had been alluded to. "As it was we did not spend too much on science and art." This is a remarkable admission to make by our Minister of Science, for such the Vice-President of the Council is in reality if not in name. We do not wish a penny to be deducted from the grant for elementary education, which we hope to see gradually increased; indeed we would strongly urge Mr. Mundella to devote his energies, so long as he has opportunity, to perfecting the teaching of science in our elementary schools. When once a proper system is fairly established, there will be no danger of retrogression—rapid progress will be certain. Not only so, but we are sure that the nation will be convinced that at the other end of the scale the neglect to encourage by national funds scientific research is quite as disastrous to the highest welfare of the country as the neglect of elementary education. In Germany and France the national necessity of both is practically recognised, and they are both amply provided for. If Mr. Mundella is of opinion that we do not spend too much on science, that can only mean that the nation must suffer for this parsimony. It was admittedly as an experiment that the 4,000*l.* was added to the 1,000*l.*, which, by the by, but for the want of faith of the scientific nabobs of the time, might have been 10,000*l.*, and that many years ago. Over and over again have we pointed out the benefit which the nation would reap from research when adequately encouraged, and that we can never hope to hold our own in this matter with foreign countries under existing conditions, in which some of our best men are compelled to waste their exceptional powers in teaching for the sake of bread and butter; while some among the "professors" whom in the view of some we were exclusively to look for research

not only neglect research, but even their students in the most unblushing manner, in their greed of gold. We hope that when next Mr. Mundella has to ask for a vote for the Science and Art Department, he will present as strong a case for the encouragement of advanced science as he has done for the teaching of elementary science. The facts and figures in favour of the one are as strong as those in favour of the other.

#### EUROPEAN CADDIS-FLIES

*A Monographic Revision and Synopsis of the Trichoptera of the European Fauna.* By Robert McLachlan, F.R.S., F.L.S., &c. (London: Van Voorst, 1874-1880.)

**M**OST persons have seen those curious aquatic insects called caddis-worms, which live at the bottom of the water, protected by tubular cases formed of bits of stick, stones, sand, or shells, and are much used as bait by anglers; being, as Izaak Walton remarked, "a choice bait for the chub or chavender, or indeed for any great fish." It is also generally known that these caddis-worms are the larvæ or grubs of winged insects, known as caddis-flies or water-moths, which abound in the vicinity of rivers or ponds and often fly into houses attracted by the light; but few persons except entomologists are aware that there are nearly a hundred and fifty different species in the British Isles, while between four and five hundred are known from various parts of Europe—that they constitute a distinct order of insects, named "Trichoptera," from their hairy wings—and that they possess peculiarities of structure of the greatest interest as serving to connect, however imperfectly, such distinct and highly specialised orders, as the Hymenoptera and the Lepidoptera.

The perfect insects are characterised by four ample membranous wings, of which the hind pair are usually the largest, while the front pair are somewhat more leathery in texture. The wings are always more or less clothed with hair, sometimes to such an extent as to form a dense coat which completely hides the nervures; and it is this peculiar hairy covering which has given the name to the family. The neuration of the wings consists of longitudinal branching veins with a few cross veins forming cells, very different from the netted veins of most of the Neuroptera, with which the Trichoptera were formerly united, but bearing a considerable resemblance to those of some of the smaller moths. The body is also hairy, the legs long and spined, while the antennæ are usually longer than the body, slender and thread-like; and when the insect is in repose these are directed forward, and so closely pressed together as to appear like one. The mouth is very small with quite rudimentary mandibles, and Mr. McLachlan thinks that the insects usually take no nutriment whatever in the perfect state, "existing on the superabundant vitality acquired during their long larval stage," but he adds: "some of the larger species frequent flowers at night after the manner of moths, and are even attracted by the mixtures used by lepidopterists to attract their favourite insects, facts which prove that some, at any rate, partake of liquid nutriment." The exact mode in which this is effected is not yet clearly ascertained.

The eggs are gelatinous, and stick together in a mass which is attached to aquatic plants below the surface of the water, into which the female is said sometimes to enter for the purpose of depositing them in a proper situation. The cases formed by the larvæ are built up of various substances fastened together by silken threads spun from the mouth in the same manner as caterpillars spin their cocoons—another curious point of resemblance to the Lepidoptera. These cases vary greatly in the different families and genera, and though at present very imperfectly known it seems probable that every species has a distinctive form of case. The Phryganeidæ, for example make cylindrical cases of morsels of leaves or fibres arranged in a spiral manner, the cases are open at both ends, and it is believed that the larvæ have the power of turning in them. When about to change into a pupa the larva closes up the ends with vegetable matter and attaches the case to an aquatic plant. They live only in ponds, lakes, or marshes. Another family—the Limnophilidæ—have some genera which live in still, others in running waters, and their cases vary greatly, the most curious being those formed entirely of shells, often taken while their inmates are alive. One genus of this family—*Enoicycla*—is altogether anomalous, since the female has rudimentary wings and its larva lives in moss, often in woods far away from water, forming a case of fine sand intermixed with vegetable matter. One species is found in England. In the next family—*Sericostomatidæ*—the larvæ live generally in streams, forming cylindrical cases of sand or small stones, but sometimes the cases are broad and flattened, in others quadrangular, while in one genus—*Helicopsyche*—they are spiral, formed of sand grains, and often so closely resembling the shells of fresh-water molluscs, that some of them have been described as species of *Valvata*, *Paludina*, &c.! In the *Hydropsychidæ* and *Rhyacophilidæ* the larvæ are carnivorous, and form irregular cases of small stones fixed to larger stones at the bottom of the water, and sometimes several larvæ appear to live in company under a common covering of vegetable and other *d'bris* fastened together with silk. These are obliged to quit their retreats when wandering about in search of food, and they accordingly have the body and abdomen of a firmer consistency. The *Rhyacophilidæ* especially frequent torrents. Lastly, the *Hydrophilidæ* live in more or less seed-like, movable cases, formed of silk with minute sand-grains, and having a slit at each end forming two apertures, from either of which the larva can protrude its head. They are found among water-plants, on the surface of stones at the bottom of streams or ponds, and have the power of spinning a silken thread by which both the case and its inhabitant can float securely in the water. The insects produced from these larvæ are the smallest of the order, and often appear in great numbers.

When the larvæ of Trichoptera are about to change into pupæ they close up the apertures of their cases either with a network of threads or with other materials, and some of them besides spin an inner cocoon. The pupæ, though quite motionless, bear a considerable resemblance to the perfect insect, the antennæ, legs, and wings being fully formed, but shorter, and all inclosed in separate sheaths and arranged on the breast. The head is however armed with a pair of strong horny hooks or jaws

quite different from those of the larva or the rudimentary jaws of the perfect insect. These are to enable the pupa to cut its way through the cocoon and outer case, when it is ready to assume the perfect state. It then becomes active, swimming by means of its two middle legs, the tarsi of which are densely fringed with long cilia, forming admirable oars. By means of these the pupa reaches the stem of some aquatic plant, up which it creeps out of the water, and then sheds its pupa-skin, and lives a short aerial life which seems wholly devoted to the duty of continuing the species.

From the foregoing brief sketch of the main features of this order of insects, it will be seen that they form what is probably a very ancient group, which has preserved some of the characteristics of several distinct orders. Though, owing to the structure of the rudimentary mouth, the Trichoptera have to be classed among the mandibulate or gnawing insects, and are supposed to be allied to both the Neuroptera and the lower Hymenoptera, yet in the neurulation of the wings, their hairy clothing, the silk-spinning and case-bearing larvæ, and the form and habits of the perfect insect, they more nearly resemble some of the smaller moths, with which Mr. McLachlan believes they have a real affinity. So, in the curious activity of an otherwise quiescent pupa, which possesses special organs for gnawing and for swimming, these insects seem intermediate between the groups with an imperfect and those with a perfect metamorphosis, though far more closely allied to the latter; and owing to these various peculiarities the Trichoptera may be said to constitute a "critical" group, whose study cannot fail to throw light on the affinities and genealogy of insects generally. Owing however to their obscure colours and slightly varied forms they have attracted comparatively little attention, though a few ardent workers have for many years devoted themselves to this branch of entomology; but the appearance of the present elaborate work, which is a model of conscientious labour and research, will form an important era in the study of the group.

This large and handsome octavo volume is devoted to a complete description of all the species of Trichoptera which have been discovered in Europe and Northern Asia, or in what is now termed the Palearctic Region. These descriptions have all been drawn up from specimens of the insects themselves—often of the greatest rarity—and the fact that the chief museums and private cabinets of Europe and America have placed their collections in Mr. McLachlan's hands for the purposes of this work, is the best proof of the high reputation he has attained as a master in this branch of entomology. The book is illustrated by fifty-nine plates containing about 2,000 distinct figures (all drawn by the author himself), illustrating generic and specific characters mostly derived from the neurulation of the wings and the structure of the anal appendages. These latter organs are wonderfully varied from species to species while constant in each; and by carefully delineating them by means of the *camera lucida*, species have been shown to be distinct which appear in all other respects to be identical; and the fact of such distinctness in a considerable number of cases is one of the most curious and interesting results of Mr. McLachlan's researches.

The work has occupied nearly six years in its publica-

tion, and it has had the effect of stimulating inquiry to such an extent that a large number of new species have been discovered during its progress, rendering the book half as large again as was anticipated; yet the author believes that a comparatively small portion only of the European species are yet known, while in less familiar regions there is a wide field for the discovery of new and remarkable forms. There remain also a number of larvæ which have not been identified with the perfect insect, and an interesting and useful line of observation is thus open to entomologists both at home and abroad. Under these circumstances every naturalist will appreciate the value of a work which has collected together and thoroughly worked up all the material available to the latest date. Such a book cannot, from its nature, be a popular one. Its production has been a labour of love, and is to that extent its own reward; but the expense of producing such a volume is very great, and in order to encourage and even to render possible the production of such works it becomes the duty of all who wish to advance the study of nature to do what in them lies to relieve such enthusiastic workers from the pecuniary burthen which their self-denying labour brings upon them. If every scientific institution and every Naturalist's Field Club in the kingdom were to purchase a copy of this admirable volume for the use and instruction of their members, they would do much to render the production of such works more common, besides really furthering the progress of research, perhaps even more than by the publication in full of their own Proceedings.

This is undoubtedly the most important British work on Entomology since the completion of Mr. Stainton's "Natural History of the Tineina" thirteen years ago, and it is well worthy of the high reputation of its author; while the clearness of the type, the excellent systematic arrangement, the full indices, and the beautifully engraved figures, are equally commendable. Any detailed criticism on such a book could only be given by a worker in the same group; but as one who has often to refer to natural history volumes for information, the present writer would suggest that the absence of any *family* names as headings to the pages is a great inconvenience, as there is no means of ascertaining what group a genus belongs to or of finding the commencement or end of a family without constantly turning to the index. So far as the typography and general arrangement of the volume are concerned this is the only defect that has been noticed, and that it is so small a one may be taken as an indication of the care and attention which has been bestowed upon the publication, no less than on the composition of this notable volume.

A. R. W.

#### OUR BOOK SHELF

*Ornithological Journal of the Winter of 1878-79; with Collected Notes regarding its Effects upon Animal Life, including Remarks on the Migration of Birds in the Autumn of 1878 and the Spring of 1879.* By John A. Harvie-Brown, F.Z.S., M.B.O.U. (*Proc. Nat. Hist. Soc., Glasgow, 1879.*)

MR. HARVIE-BROWN, well known as one of the most active and practical of our home-ornithologists, has endeavoured to chronicle the abnormal effects of an

unusually severe winter on bird-life. To this end the scattered notices on this subject which have appeared in various journals and periodicals have been collected, and are supplemented by communications from private correspondents and by personal investigations. The result is the memoir now before us, in which the observations thus collected are arranged in a systematic form.

The southern migration in the autumn of 1878 was by all accounts unusually early and rapid. The outer Hebrides appear to have been almost cleared of their smaller birds. Visitors to Tyree in December remarked on the "extraordinary scarcity of common birds," and on the "unusual number of winter visitants." On the Solway Firth also "early notice of the coming winter was afforded by the arrival of vast numbers of wild fowl." Herr Gaetke of Heligoland reports that while in ordinary seasons the autumnal migration in that wonderful island often continues until the end of February, in the autumn of 1878 every migratory bird had sped past by the close of November.

Numerous other testimonies to these facts which are adduced by Mr. Harvie-Brown, leave no doubt as to the general effects produced on bird-life by the unusually severe winter of 1878-79, in which a January "colder than any for forty-one years" followed a December "the coldest of any for twenty-one years." The bulk of the memoir is taken up by a series of notes on the different species systematically arranged, a perusal of which is sufficient to show without doubt that the author's general conclusions are amply borne out by the particulars which he has collected.

*On Mining and Mines in Japan.* By C. Netto. (Tokio, 1879.)

THE substance of this pamphlet was given as a lecture by the author before the German Natural History and Ethnological Society of Eastern Asia, and it now appears with the above title as vol. ii. of the *Memoirs of the Science department of the University of Tokio*. It is mainly a discussion of the present state of mining and metallurgical industry in Japan, with suggestions for improvements by the introduction of machinery, the establishment of model dressing and reduction works, the formation of private companies, and more particularly the introduction of foreign capital, which is at present prohibited by the Japanese law. These points are treated in some detail, and the moderation with which the author expresses his conclusions shows a practical familiarity with the subject such as is likely to command the confidence of those persons who may be interested in the subject. It is however to be regretted that the author has not been fortunate enough to receive the co-operation of some of his literary colleagues in the production of the work in its present form, as the text, even by the greatest stretch of international courtesy, can scarcely be called English, and the directors of the University must certainly have been unaware of its character when they allowed it to appear among their Records. It is necessary to mention this, as an impression is to some extent current that the translation is of Japanese origin.

*The Automatic Multiplier: for Performing Multiplication without Calculation and without Writing down any Figures except the Answer.* By John Sawyer (London: George Bell, 1880.)

*The Automatic Calculator, for cwt.s. qrs. lbs. at per lb., Supplying the Cost of any Weight at any Price up to 11s. 11 $\frac{1}{2}$ d. per lb.* By the same.

IN NATURE, vol. xviii. p. 327, we noticed "Automatic Arithmetic" by the same author. We need only endorse the remarks we previously made with regard to the former work, and commend the present admirably compact and handy calculators to practical men who, after a little time spent in getting over the manual difficulty to beginners in

manipulating the vertical and horizontal slips, will find these works very serviceable as ready reckoners. Multiplication is reduced to a mere addition of digits: the earlier work facilitated the operation of division as well. We may add that the "Multiplier" is issued in three forms, *i.e.*, for multiplying 4 figures by 4 figures, 6 figures by 4 figures, and, as in the specimen we have, 8 figures by 6 figures.

#### LETTERS TO THE EDITOR

[The Editor does not hold himself responsible for opinions expressed by his correspondents. Neither can he undertake to return, or to correspond with the writers of, rejected manuscripts. No notice is taken of anonymous communications.]

[The Editor urgently requests correspondents to keep their letters as short as possible. The pressure on his space is so great that it is impossible otherwise to ensure the appearance even of communications containing interesting and novel facts.]

#### The Freshwater Medusa

THE explanation of the discrepancy between Prof. Allman's and my own citation of my article in NATURE, vol. xxii. p. 147, appears to be that Prof. Allman has unfortunately received a copy of NATURE differing from the majority of the issue of that date in the fact that it was printed off before the final corrections, sent to the office of NATURE on Wednesday, had been inserted. These corrections were made before the greater number of the issue was struck off, and I have only just ascertained, to my great surprise, that any of the uncorrected copies had been circulated. The error as to the marginal canal was also present in the proof of my paper, marked "uncorrected proof, confidential," which was circulated among the Fellows at the meeting of the Royal Society on June 17, but the error was corrected by me before the reading of the paper.

Accordingly, so far as any publication or the public expression of my conclusions is concerned, I have not committed myself to the erroneous notion that the marginal canal is absent, although in the course of my inquiry I did entertain that and many other provisional conceptions as to the structure of Limnocoelium.

I shall be glad to see some explanation from the publishers of NATURE of the curious and highly inconvenient phenomenon of dualism in NATURE which has mystified both Prof. Allman and myself.

E. RAY LANKESTER

[Premising that we are supposed to leave NATURE in the printer's hands ready for press at 2 p.m. on Wednesday, we have no difficulty in giving the explanation asked for by Prof. Lankester.]

His revised proof was received by us on Wednesday morning, June 16, with numerous corrections, which were given effect to. After the paper had been made over to the printer on the afternoon of that day a postcard was received by the printer with an additional correction, which was also duly made. On the morning of Thursday, the 17th, the following note, dated "Wednesday afternoon," was received by the printer after the printing of the American edition had been completed and that of the English one had commenced:—

"DEAR SIR,—If there is time please alter in my diagnosis—  
'MARGINAL or RING CANAL obliterated or much reduced'  
into 'MARGINAL or RING CANAL voluminous.'

"Similarly please alter  
'RADIATING CANALS terminating caecally' into 'RADIATING CANALS opening into the marginal canal.'

"Truly yours,  
"E. RAY LANKESTER"

Although one-third of the edition had been printed off, the printer, knowing our anxiety to give contributors every facility for corrections, stopped the press, and made the alterations which were asked for "if there is time." Possibly Prof. Lankester has no idea of what is involved in stopping a steam press. However this may be, the press was stopped in order to carry out to our utmost what we considered to be Prof. Lankester's wishes, and we are astonished that he can have put any other interpretation upon what happened. Prof. Lankester's letter given above is undated, but it was received on July 31 at mid-day. On the 28th he wrote, stating that he had found there were "two issues of NATURE of June 17," and requesting us to "state this if necessary." This does not



seem to accord well with the statement above (July 31) that he had only "just ascertained" the fact to his "great surprise."  
—Ed.]

#### Subterranean Kaolinisation

A YEAR ago Mr. John Arthur Phillips, in criticising, before the Geological Society, my theory of kaolinisation as a source of superficial rock temperatures, made a point which is interesting in its bearing upon the composition of derived or secondary lithological products. He endeavoured to ascertain the number of tons of felspathic rock that must be yearly kaolinised in order to supply the quantity of alkalis known to be contained in the mine waters of the Comstock silver lode in Nevada, and in doing so he began with the supposition that in the process of kaolinisation *all* of the alkali in the felspar goes into solution and is removed. This assumption is undoubtedly incorrect, for even the surface clays which are deposited from running water, and therefore must have been subjected to a maximum leaching, almost invariably contain potassic and sodic salts, as any one may learn by studying the subject of fireclays.

But when the clay is formed by the alteration of rock at great depths, beyond the line of ready drainage and in the presence of a minimum quantity of water, the product is, or may be, quite different from the clay of sedimentary deposition. It is in fact merely the original rock hydrated, and from the example given in the Comstock region the alteration product does not seem to lose much, if any, of its original alkalis. This is demonstrated by the analyses given in Mr. King's Report on the Fortieth Parallel. All the existing analyses of the clays in this region were made on specimens obtained in the first thousand feet of depth, and most of them were taken within 500 feet of the surface. That is, they all come from the region of active drainage, the oxidising and other effects of atmospheric action being well marked in this lode down to the depth of 600 feet. The mean of four analyses of clays shows 4.72 of alkalis and 10.86 of water, CO<sub>2</sub> and P<sub>2</sub>O<sub>5</sub>. One of the specimens has been very strongly altered, having lost about 10 per cent of silica, while another seems to have gained about half as much of the same constituent. As to the composition of the original rocks (propylite and andesite,) it is impossible to be exact, for the alteration in the region has been so extensive and thorough that all attempts to obtain an unaltered specimen have failed. The least altered specimen of propylite from the Virginia range of mountains in which this lode is found contains 5.08 per cent of alkalis, with 1.02 loss by ignition. The most altered specimen contained 5.26 per cent. of alkalis, and 6.53 loss by ignition. Andesite showed in the least altered specimen 4.7 alkalis and 2.8 loss; in the most altered specimen 7.37 alkalis and 4.35 loss. It is impossible to compare the clays of this district with unaltered rock from other localities, for the reason that the composition of these eruptive rocks varies strongly, especially in the percentage of alkalis. On the whole I think that any one who will compare the tables of analysis given in vols. i. and iii. of Mr. King's work will be convinced of the truth of what I have asserted above—that subterranean kaolinisation is merely the hydration of a rock in place without other serious alteration. The fact has importance in its relation to the origin of some hydrated aluminous rocks.

Mr. Phillips calculates that the average proportion of alkalis in these rocks is 6.4 per cent., that 813 tons of alkalis are removed yearly in the mine waters, and that "it consequently follows" that the felspar in 12,703 tons of rock "must be annually kaolinised, and the whole of the alkalis removed in solution." It seems to me that a metallurgist of Mr. Phillips' experience should have known that the alkalis are never completely removed in kaolinisation. That he is not acquainted with the peculiar and remarkable conditions of the Comstock is not surprising, for the lode receives but little attention, and that of the most hasty kind, from visitors. I ask your permission to add the following summary of facts which rebut Mr. Phillips' criticism:—

1. The removal of alkalis in subterranean kaolinisation, if it is judged by the existing incomplete series of analyses, seems to vary from less than one-fifth of the quantity of alkalis in the present rock down to almost nothing.

2. The whole results of kaolinisation are not represented in the mine waters. In the vast areas of dry rock alteration has been extensive, and seems to be going on now by means of water-vapour, and none of this action supplies alkalis to the mine waters.

3. The liberation of hot gas which is an accompaniment of

kaolinisation by atmospheric waters conveys the heat produced in the dry areas to all parts of the mass, and especially to such channels as watercourses and mine-openings.

4. Kaolinisation in the Comstock region is not produced by the action of cold water on cold rock, but by the combination of water and rock, both already heated before the action to very nearly the temperature they attain after it. The heat of the rock is cumulative, its present temperature being mainly the result of ages of previous kaolinisation, the heating effects of which were preserved from dissipation by a blanket of rock 1,000 feet thick. The water which takes part in the action at existing depths of the mine has been heated by its percolation through 1,000 to 1,500 feet of hot rock lying below the blanket spoken of. Mr. Phillips calculates that 85° are added to the temperature, but in fact the actual increment of temperature by kaolinisation is, in the locality given, but a small fraction of this quantity. Considering the small rainfall of Nevada, and the depth at which the waters are now drawn from the rocks, and the perfect correspondence of depth and temperature, it is more probable that the actual gain of heat does not exceed one or two degrees, and may even be less.

5. Mr. Phillips' calculation that 330 tons of water are heated by the kaolinisation of one ton of rock has no foundation in the known facts, but is probably more than 99 per cent. from the truth. His further error in supposing that the increment of heat is 85° F. instead of being in the neighbourhood of 1°, as is more probable, relieves his criticism of whatever weight it might have if it had been adjusted to the well-known facts of the case.

115, Broadway, New York, June 17 JOHN A. CHURCH

#### "On a Mode of Explaining the Transverse Vibrations of Light"

I VENTURE to call attention to what appears to me to be (possibly) an objection to the views advanced by Mr. S. Tolver Preston in his interesting article, "On a Mode of Explaining the Transverse Vibrations of Light" (*NATURE*, vol. xxi. p. 256). Mr. Preston's hypothesis I understand to be a special modification of Lesage's, the speciality being that the corpuscle, which by their impact on the cage-atoms of ordinary matter cause gravitation, are also the carriers of some vector property, the changes in which constitute radiant energy, and that in fact there is no ether except just this assemblage of minute corpuscles co-existing in the ultra-gaseous state (*i.e.*, with a mean free path of great length). Now, as far as I can see, it is a strict corollary from this exceedingly fascinating hypothesis that the velocity of propagation of gravity must be identical with that of light. In other words, the acceleration of a material particle at any instant (I) caused by the attraction of a second particle must be directed to the spot occupied by that second particle, not at the instant I, but at some instant prior to I, the interval between the two instants being the time taken by the ultramundane corpuscles, and therefore by light, to travel from the one particle to the other. But do not the observed planetary motions necessitate the assumption that gravity, even if propagated in time at all, is propagated with a velocity vastly in excess of that of light? At any rate this statement is frequently met with in discussions on the nature of gravity, and is much prized by advocates of "action at a distance." If it is true, does it not constitute a fatal objection to Mr. Preston's hypothesis?

Some two years ago it occurred to me that the ether might consist of particles in the ultra-gaseous state, and might thus, in accordance with Lesage's hypothesis, give rise to the mutual gravitation of the grosser atoms immersed in it. I was then unaware of the late Prof. Clerk Maxwell's suggestion that these particles, by being the carriers of some vector property undergoing periodic reversal, might account for the propagation of light; and vaguely hoped that it might receive some explanation from the fact, also discovered by Clerk Maxwell, that a body in the ultra-gaseous state behaves like a solid towards any confining boundaries to the extent that, like a solid, it opposes a certain resistance to change of shape. But I deemed the whole theory to labour under the fatal objection of not giving a sufficient velocity of propagation to gravity.

I write in the hope that Mr. Preston or another of your readers will inform me whether my objection is a valid one.

J. W. FRANKLAND  
Registrar-General's Office, Wellington, New Zealand, May 6

### Expansion of Glass by Heat

THE reproduction in your "Physical Notes" (*NATURE*, vol. xxiii. p. 157) of Mr. R. H. Ridout's neat experiment for illustrating the "Expansion of Glass by Heat" (*Phil. Mag.* for June, 1880), recalls to mind an equally striking method of exhibiting this property of glass to a class of students in physics. Select a straight glass tube 50 or 60 centimetres in length and 1 or 2 centimetres in diameter. Place it transversely in front of a fire, in a horizontal position, properly supported near its two ends on two horizontally-adjusted rods of hard smooth wood of about the same diameter as the tube; the glass tube will gradually roll towards the fire. Now let the supporting rods be transferred to either side of the centre of the tube, so as to support it near its middle; the tube will now gradually roll from the fire.

It is scarcely necessary to remind the reader that the greater dilatation of the glass on the side of the tube which is nearer the fire renders it curved, with the convexity next to the source of heat, so that, when supported near the ends, the falling of the central parts of the curved tube rolls it towards the fire; but when supported near the middle the falling of the ends of the similarly curved tube rolls it from the fire. These experiments, it is evident, succeed better when the cold tube is first adjusted near the fire than when it has been so long exposed to the action of the heat as to have become heated throughout its mass.

It seems that about the year 1740 this behaviour of glass tubes under similar conditions was noticed by Mr. C. Orme, of Ashby de la Zouch, while heating some barometer tubes. The Rev. Granville Wheler, who carefully verified the experiments of Mr. Orme, very correctly ascribes the phenomena to the distortion of the tube due to the action of heat (*vide Phil. Trans.*, No. 476; also *Edinburgh Encyclopaedia*, 1st Am. ed., 1832, vol. ix., article "Glass," p. 773). Nevertheless in the United States this behaviour of glass tubes, when placed before a fire, has been frequently classed among the unexplained mysteries of glass! As recently as 1865 Mr. Deming Jarves, of Boston, in his little volume entitled "Reminiscences of Glass-Making," p. 10 (2nd ed., N.Y., 1865), refers to the phenomena, but with not one word of explanation. In fact not long ago some of our semi-scientific journals characterised these phenomena as mysterious and inexplicable. Hence I have for the last twenty or thirty years employed such experiments, not only as exhibiting visible manifestations of the expansion of glass, but also as affording an instructive and significant illustration of how completely the most obvious mechanical results may be overlooked or obscured under the inspiration of the propensity to seek for the marvellous in nature!

JOHN LECONTE

Berkeley, California, July 8

### Fascination in Man

HAVING frequently seen it stated in popular works on natural history as well as in some books of travels (chiefly Australian) that certain snakes possessed the power of so fascinating, with their gaze, birds and other creatures as to be able to seize upon and devour them without any difficulty, I am induced to inquire if such a power is peculiar to the serpent tribe or not, and incidentally to ask if any instances of its influence or extension can be traced, up the scale of creation, to man himself. Being of opinion that such is the case, while it has occurred to me that many of the fatal accidents that occur in the streets of large cities, such as London, &c., might be ascribed to some such agency or sensation, I am induced to call attention to the circumstance in these pages, and to submit the following as my own personal contributions towards the inquiry:—

Describing certain incidents of the siege of Gibraltar, Drinkwater says, "History," p. 75, that "on the 9th Lieut. Lowe . . . lost his leg by a shot on the slope of the hill under the castle," and the italics are mine throughout. "He saw the shot before the fatal effect, but was fascinated to the spot. This sudden arrest of the faculties was not uncommon. Several instances occurred to my own observation where men totally free have had their senses so engaged by a shell in its descent that, though sensible of their danger, even so far as to cry for assistance, they have been immediately fixed to the place. But what is more remarkable, these men have so instantaneously recovered themselves on its fall to the ground as to remove to a place of safety before the shell burst."

Alluding to the first casualty that occurred at Cawnpore during the siege of the entrenchment there in 1857, Mowbray Thom-

son says ("The Story of Cawnpore," p. 66) that "several of us saw the ball bounding towards us, and he (McGuire) evidently saw it, but, like many others whom I saw fall at different times, he seemed fascinated to the spot"; and an old and now deceased departmental friend, who went through the whole Crimean campaign, assured me that he was once transfixed (fascinated, he called it) after this fashion in presence of a shell that he saw issuing from Sebastopol, and whose every gyration in the air he could count. Other military friends have discussed the point with me in this same wise, and I think there is some allusion to it in one or other of the works of Larry, Guthrie, Ballingall, or others of that ilk.

W. CURRAN

Warrington

### Monkeys in the West Indies

IN consequence of my removal from the West Indies to the West Coast of Africa, and of illness since my arrival here, I have not until now had time to read in the back numbers of *NATURE* the controversy on the subject of "Monkeys in the West Indies," which, it may be said, I created by my communication in *NATURE*, vol. xxi. p. 131. I trust, therefore, I now may be permitted to reappear on the scene and to sum up my case.

In my communication I quoted, from Prof. Mivart's lecture on "Tails," an extract which appeared in your columns (*NATURE*, vol. xx. p. 510), viz.: "Monkeys are scattered over almost all the warmest parts of the earth save the West Indies, Madagascar, New Guinea, and Australia," and I added, with the utmost respect for Prof. Mivart, that the above statement was not "quite correct," adducing as proof the fact that they were found in St. Kitts, Nevis, and Trinidad. Mr. Sclater, F.R.S., the distinguished zoologist, answered my letter (*NATURE*, vol. xxi. p. 153), explaining that Prof. Mivart was correct in his statement; that the monkeys of St. Kitts were not "indigenous" to that island, and that Trinidad originally was part of the mainland of South America. Mr. Sclater said nothing about the Nevis monkey. Dr. Imray of Dominica followed with a quotation from Père Labat (*NATURE*, vol. xxi. p. 371), and as regards St. Kitts and Trinidad, the monkey question was closed.

But it subsequently came to my knowledge, through hearsay evidence, that monkeys existed in large numbers in Grenada, one of the Windward group of islands, although travellers and historians from the time of Père du Tertre to that of Bryan Edwards seemed to be ignorant of the fact. As I had left the West Indies when I obtained this information, I at once called Dr. Imray's attention to it, begging him to ascertain its accuracy and then to communicate with *NATURE*. Dr. Imray has done so (*NATURE*, vol. xxii. p. 77), and, by a curious coincidence, his letter appears in the same number in which a Grenada correspondent, signing himself D. G. G., charges me with being "quite as much in error as Prof. Mivart," and makes me say that "the only islands in the West Indies where monkeys are to be found are St. Christopher [*i.e.*, St. Kitts] and Nevis." The italics are my own, but I think D. G. G. should at least be careful to quote accurately.

I have no wish to trespass further on your valuable space. What I desired to show and what I have shown is that monkeys do exist in many of the West India Islands, and that, although nearly four hundred years have passed away since the discovery of the islands, their natural history is still very imperfectly known. And yet these islands are within easy steaming distance

England; they are inhabited by people whose kindness and hospitality to visitors are proverbial. Their mountains afford the most varied varieties of healthy climate, and for the botanist, the ologist, the entomologist, and the man of science generally, are few, if any, richer fields of instruction and enjoyment. Government House, Cape Coast Castle, EDMUND WATT  
Gold Coast, July 3

### Utricularia

CAN any of the readers of *NATURE* inform me whether the sharp clicking noises produced on removing Utricularia from the water (particularly for the first time) have been noticed or described? I have not succeeded in determining the species, as the plants are not yet in flower.

J. W. CLARK

R.I.E. College, Cooper's Hill, July 30

### The British Association and Provincial Scientific Societies

THE list of delegates of provincial scientific societies prefixed to the list of members attending the annual meeting of the British Association having appeared to me to be practically useless, being in reality merely a list of "temporary members," of the general committee—with the object of making it of some value to the societies represented, and also eventually to the Association, I suggested, at the meeting at Bradford last year, an alteration in the rule of the Association which affects this list of delegates. My suggestion being favourably received by the Council, the alteration proposed was adopted at a meeting of the General Committee.

The effect of this alteration is to admit as a temporary member of the Committee the *secretary* of any scientific society publishing *Transactions* as well as the president, or in his absence a delegate representing him. My object in proposing it was, as I then stated, to admit of a meeting or conference of the presidents and secretaries of societies thus represented being convened under the auspices of the Association, at which matters concerning such societies (their management more especially) might be talked over and arranged, &c., a thing which could not be attempted in the absence of the secretaries, they, as a rule, having almost the entire management of their societies.

As the revised rule first comes into operation at the approaching meeting of the Association at Swansea, I should be glad if you will draw attention to it, either by the insertion of this letter or in any other way.

JOHN HOPKINSON

Hon. Sec. Herts. Nat. Hist. Soc.

Wansford House, Watford, July 24

### Intellect in Brutes

THE following story was told me by the mistress of the dog herself. The event occurred in a small village in Essex, some years ago.

"A little black and white King Charles, beloved by its mistress, but not by its master, was one day lying on a rug in the drawing-room when the master came in, having just paid its tax. He said: 'I have just paid that dog's tax'; and looking at it with a severe expression added: 'and he's not worth his tax.' The little dog immediately got up, and with a crestfallen appearance put its tail between its legs and left the room. It was never seen afterwards, nor was it ever heard of again, although inquiries were made at the time in every direction."

GEORGE HENSLOW

### Chipped Flints

A FEW days ago a man who had been cutting turf in this neighbourhood came to tell me that he found a quantity of small flints at the bottom of the "bog-hole," and he brought some of them for my inspection. Seeing that they all bore very obvious marks of handicraft, while a few were more or less rudely shaped like arrow-heads, I immediately went to the place, accompanied by the man, and succeeded in getting a number of specimens, of which some fifty or sixty show pretty plainly the design of the workman. Among them are a few white flints, evidently from the Chalk, and indeed with some chalk attached to them. This is worthy of remark, as there is no chalk nearer than the North of Ireland, nor are there any chalk flints among the boulders here, where the drift was unmistakably derived from the limestone, silurian, mica slate, and syenitic rocks of the west and south-west. The other flints are black, like the chert, which occurs plentifully enough in the carboniferous lower limestone formation of the district. Several pieces of charcoal were mixed with the flints, showing probably that fire was used in breaking them up in the first instance. The final operation of chipping seems to have been done with a very delicately-pointed instrument, not thicker than a large sewing-needle. Its marks, both where it struck off the chip and where it failed to do so, are as plain and fresh-looking as if they were made quite recently. It must have been used as a punch and worked with a hammer, and there must have been some contrivance like a vice to hold the flint during the operation. It is really hard to think that the instrument with a point at once so minute and powerful could be other than metallic; but then, if there was metal available, why have recourse to flint? Perhaps these flints might be referred to a time late in the neolithic period, during the

transition from stone to metal, when the latter, being scarce, was used only for tools. At one time I fancied that I made a capital discovery of metallic particles struck off and lodged in the stone, but with a pocket lens they were found to be only specks of pyrites. A small sandstone slab, quite smooth on one side, lay among the flints, but it was either taken away or thrown into one of the turf holes filled with water before I came to the place, and I failed to find it. By its impression in the turf which remained untouched it appeared that one surface was quite polished. The other was described as rough. Whether it was used in the manufacture of the arrow-heads or not I cannot surmise. The shape of a large sandstone pebble that I found might suggest its use as a hammer, but it showed no signs of abrasion. At one time there must have been at least twelve feet of turf over the flints. They lay immediately above the roots of a pine close to a short piece of the stem that remained. The tree was most probably growing when the flints were worked, and it may be of some interest to note that the craftsman selected the shade or solitude of a wood for his *atelier*.

In this bog is found the striking phenomenon of two growths of trees, one overlying the other. The lower was chiefly pine, identical with, or nearly allied to, the *P. sylvestris*, and rooted in the drift clay or gravel. The upper trees were principally oak, and grew in the turf formed from the prostrate wood that preceded them. This is remarkable, showing a wide difference in the habitats of both kinds and those of their representatives of the present day, when we find the oak growing in clayey soils, while in general the moor agrees well with the firs and pines.

J. BIRMINGHAM

Milbrook, Tuam, July 12

### Lunar Rainbows

THE following communication has been forwarded to me by a lady of considerable ability, and can be relied upon. As a lunar rainbow is a rare phenomenon, perhaps you may deem the notice worthy of a place in NATURE.

J. KING WATTS

St. Ives, Hunts., July 30

"On July 19 a most brilliant lunar rainbow was visible in this village of Over, Cambridgeshire, and was observed by other persons as well as by myself. For several days previously there had been a succession of violent storms, with much thunder and lightning, and the falling of vast quantities of rain. The whole atmosphere was evidently in a very perturbed condition, with considerable electrical disturbance. The wind had for several days previously been exceedingly variable, veering from point to point with rapidity, and on the day in question it had veered much from one point to another. At 10 p.m. the wind blew strong and steadily from the south-west, thereby driving the great masses of cloud to the north-east. To the front of the position I was in, the clouds had been pushed or rolled up into a dark mass extending from the north, north-east, east, and nearly to the south-east, up to the zenith, so that one portion of the horizon was cloudless and the other portion black and sombre. The moon was very clear and nearly to the full. The sky had a singular appearance, one part being most brilliant and clear, and the moon riding in it free from every particle of cloud, and the other part to the north-east was most intensely dark. At 10.35 a beautiful and brilliant silvery white arch was formed (north-east), extending nearly from the zenith down to the horizon. The arch was most perfect in all respects. The force of the wind had abated. There were no prismatic colours visible, but the whole arch, standing out, as it were, in bold relief on the black cloud, had a most awe-like but beautiful appearance, and the sight can never be forgotten. The singular phenomenon was brilliantly visible for a considerable length of time, thereby clearly indicating the slow progress at which the shower was then moving onward. Such a phenomenon is very seldom to be seen. The sky continued clear during the remainder

"ANNE GIFFORD

"Over, Camb."

W. E. WILLINK.—The "substance" you send us is a well-known alga, *Nostoc commune*. See the "Treasury of Botany," *sub voce* Nostoc.

BRICKMAKING.—A "Brickmaker" asks if any of our readers can tell him of a book on Brickmaking which gives good and trustworthy information about the operations, machines, &c. He has a book by E. Dobson, but it is thirty years old, and therefore of very little use.

### CARBON AND CARBON-COMPOUNDS

THE wayward and inconstant train of coloured light-bands that spectroscopists have noted and distinguished in the spectra of various carbon-compounds in flames and gas-vacuum tubes are as yet far from having all received their full and appropriate interpretations. The extent to which they abound as impurities in almost all spectral vacuum-tubes is a common observation, and in a survey of this kind, aiming at no systematic exploration, of a variety of end-on vacuum-tubes in the large and perfect spectroscope erected by Prof. Piazzì Smyth for the examination of auroræ, I have had from time to time, at his kind invitation, excellent opportunities for discriminating some of the component groups and clusters of the carbon-denoting series from each other pretty clearly.

Among the least alterable and changeful in its appearance of these coloured ranks is the five-tongued spectrum of wedge-like bands best seen in the end-on prismatic view of a coal-gas blow-pipe flame. Its bands have shaft-lines at the edge and on their fading slopes, with the exception of the last or violet one, just including within its bright edge the solar line of Fraunhofer's spectrum, G. This has a fine-line precursor, nearly coincident with H $\gamma$ , and a faint haze-band preceding it. Close to the place of  $\delta_1$  in the solar spectrum appears the bright edge or chief shaft-line of the green band, fitly styled the "green giant," as it is the real Anak of the coal-gas flame-spectrum. Its less refrangible similitudes in the yellow-green and orange-red are quite subordinate groups, the latter being only discernible in spectroscopes of large aperture and of very great transparency. The fifth finger of this spectral gauntlet is a blue band, or quintett of five close lines pretty equally spaced and pretty equal in brightness, with little haze between them, lying once or twice its own breadth on the more refrangible side from H $\beta$  (F.). The frontispiece of Watt's "Index of Spectra" contains a figure of this spectrum; and wave-length positions and symbols and descriptions of its groups are given in the body of the work, under the title "Carbon, Spectrum I."  $a, \gamma, \delta, \epsilon, f$  ( $\beta$  and  $\eta$  *arent*) are the five familiar potentates of the blow-pipe flame; but the two line-bands  $\zeta, \theta$ , one on each side of  $f$ , added in the figure and in the text of Watt's "carbon-spectrum I.," are not visible in the blow-pipe flame-spectrum. Along with a similar ultra-violet cluster just following H K in the solar spectrum, they form a triumvirate, the spectral origin of which Professors Liveing and Dewar have recently affirmed to be cyanogen. A reason to question the correctness, however, of Messrs. Liveing's and Dewar's surmise presented itself to me in my examination of the end-on tubes by the spectacle of the six-lined violet cluster  $\theta$  rearing itself, without any accompaniment of its blue associate  $\zeta$ , into extraordinary magnificence in a Marsh-gas tube. The grey or ultra-violet member of the trio was indeed weakly discernible at the same time; and in just this relative brightness and condition of extreme isolation from every other spectral feature I have recently observed these two violet and ultra-violet line-clusters in the blue flame part of the arc between particularly pure carbon poles in the Brush's or Anglo-American Company's electric light.

Another reason for suspecting multiplicity of form in the carbon-spectrum by itself occurred to me in an examination of the spectrum of cyanogen in an end-on tube. A perfect counterpart, it is well known, of the blow-pipe flame spectrum is producible by the induction-spark in vacuum-tubes of olefant gas. Accompanying it however is another spectrum which in its fullest purity and intensity is equally well known to be produced by a weak induction-spark in tubes of carbonic oxide and carbonic acid gas. The blue quintett and the violet G-band are wanting in this spectrum. The edges of the green, citron and orange-red bands are displaced, and

these bands are devoid of shaft-lines, being composed entirely of haze and fine linelets which smoothly shade them off. The olefant gas and "carbonic oxide" spectra mingle together, usually in divers proportions in the carbon-impurities of gas-vacuum tubes.

Two cyanogen tubes (one of them of hardest glass) prepared by M. Salleron betrayed alike only the smallest trace of hydrogen by its red line, when they were lighted up by the induction-coil. Aqueous and atmospheric oxygen may therefore be presumed to have been pretty completely expurgated from these tubes, and the gas which charged them to have been an exceptionally pure compound of nitrogen and carbon. Far brighter, notwithstanding this, than in any other vacuum-tube, the smooth-shaded "carbon-oxide" bands made their appearance; and equally splendid with them was the close-ribbed red and yellow fluting forming the less-refrangible part of the spectrum, figured and described by Ångström and Thalén as that of "nitric oxide." The coincidence with the same spectrum of the bright cyanogen-tube lines in the blue and violet spectral regions was not closely examined; but as far surpassing in brightness the red-end view of it obtained in any other nitrogen-holding vacuum-tube (nitric oxide itself not excepted), the rasp-like ridges of the so-called nitric oxide spectrum were immediately measured with great care and accuracy. Ångström's positions and *tableau* (exactly reproducing that of Plücker and Hittorf) of this region were completely verified; and the discussion of the well-based determinations left no doubt that while a simple order reigns sensibly among the small linelet features of each separate ridge, the ridges have no perceptible connection with each other or with the linelet-intervals upon them in the pitch of their wave-frequencies, although they follow each other closely in a gradually narrowing succession. In the rest of the nitrogen-spectrum, where the ridge-intervals are much wider, it is again not possible to trace between the ridges any simple wave-period connection.

Were I not from these measures, and from the foregoing considerations disposed to regard shaded spectral bands as independent systems of vibration, indicating most probably particular atomic groupings in a molecule, I should have beheld with some surprise the complete and thorough metamorphosis shown me by Mr. Lockyer since the above particulars were noted, which the smooth-banded "carbon-oxide" spectrum undergoes by introducing a condensing-jar, or better, a jar and air-break, into the circuit of the induction-coil. The smooth shadings disappear, the shaft-lines, the "Anak and the sons of Anak" of the olefant-gas or blow-pipe-flame spectrum make their appearance in their place; even the blue quintett of that spectrum comes forth from its hiding-place; and, as far as I could examine the spectral appearance of the carbonic-oxide tube in the now condensed discharge with complete precision, the whole blow-pipe flame, or so-called "hydro-carbon" spectrum, is perfectly reproduced. If we cannot admit, as I think that the cyanogen-tube experiment forbids us to do, that a chemical transformation has taken place, then we must acknowledge that among the forms which the spectrum of carbon is capable of assuming, there may, by subdivision of its molecule into separate vibrating systems, exist not one, but as many different "low-temperature" spectra of that Briareus-like, hundred-fisted, or Proteus-like, hundred-visaged element, as the electric discharge is capable of dividing its evidently complex gaseous molecule into separate spectroscopically individual groups.

A. S. HERSCHEL.

### PHYSICS WITHOUT APPARATUS

#### I.

IT is almost a proverb in science that some of the greatest discoveries have been made by the most simple means. It is equally true that almost all the

more important facts and laws of the physical sciences can be illustrated and explained by the help of experiments made without special or expensive apparatus, and requiring only the familiar objects of common life for their performance. The greatest exponents of popular science—and amongst them notably Faraday—delighted in impromptu devices of this kind. It is indeed surprising how throughout the whole range of natural philosophy the hand of the master can turn to account the very simplest and rudest of apparatus. A silver spoon, a pair of spectacle lenses, a tumbler of water, and a few sheets of paper suffice to illustrate half the laws of geometrical optics. A few pieces of sealing-wax, some flannel, silk, writing paper, pins, and glass tumblers will carry the clever experimenter a long way into the phenomena of electricity. These are things which any person can procure, and which any person can be taught to use. But their right use depends on the possession of accurate

scientific knowledge and a clear understanding of what the various experiments are to prove. In fact the art of experiment and the science of inductive reasoning are the essential qualifications necessary to make *Physics without apparatus* profitable.

The short series of papers which it is now proposed to publish in NATURE under the title of *Physics without apparatus* will deal with some of the more important and interesting of these simple matters of experiment. The subject of them has been more immediately suggested by the publication in our contemporary, *La Nature*, of a kindred series of articles by Mons. G. Tissandier, from which a number of the illustrations we present to our readers are taken. The matter of the present series is however new.

Amongst the simple mechanical laws with which a beginner in physics must acquaint himself is that commonly referred to as the *law of inertia*, which is, however,

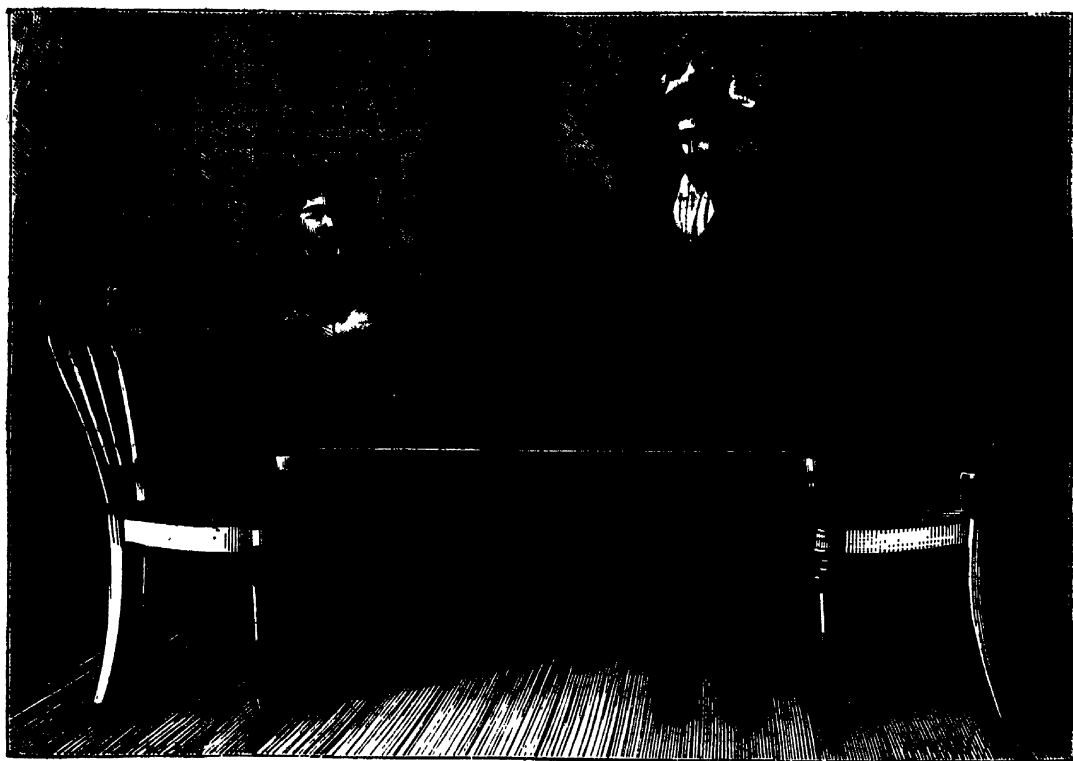

FIG. 1.

very often so imperfectly expressed as to be misapprehended. It requires force to move matter, not because matter is inherently lazy or sluggish, but because it possesses *mass*. The greater the mass of matter in a ball, the harder work is it to send it rolling. Force is also required to stop matter that is moving, the reason again being that a mass moving under the impulse of an impressed force possesses a certain moving energy which cannot be at once reduced to nothing. In either case—either to move a mass or to alter the motion of a mass—force must be employed and energy expended. Of this law of inertia many examples might be given: and there are many curious facts which this law serves to explain. Some of the most striking of these are those in which the effect of sudden forces is different from that which might have been expected. In Fig. 1 we give an illustration of an experiment of this nature. A wooden rod—say a broomstick—has a couple of needles fixed

into its ends, and it is then supported upon two wine-glasses resting upon two chairs. If a heavy poker is now brought down very violently upon the middle of the stick it will break in two without the needles or the glasses being broken. A feeble or indecisive blow will fail to do this, and will break the glasses or the needles, or both. Here the moving energy of the heavy mass, the poker, is suddenly transferred to the middle of the stick, so suddenly that it is broken asunder before the thrust has *time* to reach the fragile supports.

Another simple experiment on inertia is equally instructive. Lay any ordinary visiting-card upon the knuckle, or upon the top of an inkstand or other convenient support. On the card place a brass weight, or a spool of thread, or any other small heavy object. Now away the card with the finger and thumb; it will fly, leaving the heavy object where it was. In the same way if a dozen draughtmen are piled up one upon another

in a column, the lowest one can be removed without making those above it fall, by hitting it aside with a very rapid stroke with a table-knife. Here again a feeble stroke will fail.

Our second figure illustrates inertia in another way. A heavy metal ball is hung by a thread to the ceiling on to a shelf, and another thread is attached below. Tug at the lower thread, and it will break. If the tug be slow the ball will come down too; but if the tug be sharp and fierce



FIG. 2.

the thread will break off *below* the ball, breaking, in fact, before the pull has time to impart to the mass of the heavy ball a sufficient moving energy to enable it to rupture the string by which it hangs.

Many other illustrations of a similar kind might be narrated. Of these probably the most telling is that of firing a tallow candle from a gun through a deal board, in which it leaves merely a hole, as the writer can testify from several repetitions. Here, however, we are passing into the region of "apparatus," and must not pursue the matter further.

#### COUNT POURTALES

IN the death of Louis François de Pourtales science has met a heavy loss. He was the Swiss representative of an old family, which had branches also in France, Prussia, and Bohemia. Trained as an engineer, he emigrated in early manhood to the United States at nearly the same time as the late Prof. Agassiz, to whom he was much attached, and whose pupil and fellow-worker he was. He entered the Government service in the department of the Coast Survey, and continued in it many years. His talents and industry made him a man of mark, to whom was intrusted much work that required original thought. Especially did he show interest in the problems of deep-sea soundings and the structure of the ocean bottom, an interest that led to profound observations on the physical geography of the Caribbean Sea and the Gulf Stream. His papers on this

subject were of the first order, and established his reputation in Europe as well as in America.

"By the death of his father he succeeded to the title, and received a fortune which enabled him to devote himself wholly to his favourite studies, and to do much in continuing the great work of Louis Agassiz. Appointed keeper of the Museum of Comparative Zoology, he gave himself, with untiring devotion, to carrying out the arrangement so laboriously planned by his friend and master. Dividing the task with the curator, Alexander Agassiz, he pushed forward his part of the work with the easy power of a strong and highly-trained intellect. Every day and all day at his post—now pursuing special investigations, and now directing the details of the museum—he was the model of an administrative officer.

"He had not an enemy, and could not have had one; for, although firm and persevering in temper, he possessed the gentleness of a child and a woman's kindness. His modesty amounted almost to a fault; and people wondered why a man who was master of three languages should talk so little. But with intimate friends he would speak freely, and never without giving information and amusement. His range of learning was very wide, and his command of it perfect; nor was it confined to mathematics, physics, and zoology. He did not scorn novels and light poetry, and was knowing in family anecdotes and local history. Indeed, it was a saying in the Museum 'hat if Count Pourtales did not know a thing it was useless to ask any one else.

"His strong frame and temperate mode of life gave hope of a long period of usefulness, for he was only fifty-seven, and in the prime of his powers. But it was not to be. Stricken, without apparent cause, by an obscure internal disease, he succumbed, after some weeks of suffering heroically endured. In seven short years he has followed Louis Agassiz, and there seems no hand to take up his burden."

The above account of Count Pourtales appears in the *Boston Daily Advertiser* of April 20, and is, we believe, from the pen of Prof. Theodore Lyman. We would here, in addition, refer briefly to some of Count Pourtales' scientific work. Almost from the commencement of his connection with the United States Coast Survey he deeply interested himself in deep-sea questions, and some of the earliest observations on the nature of the deep sea bottom and of Globigerina mud were made by him. He wrote on the structure of Globigerina and Orbulina, and described the occurrence of the small Globigerina-like shells bearing spines in the interior of certain Orbulinæ, which he concluded were the swollen terminal chambers of Globigerinæ containing young in progress of development. The first step in deep-sea investigation in the United States was taken by the late Prof. H. D. Bache on his assuming the duties of the United States Coast Survey in 1844, when he ordered the preservation of specimens brought up by the lead. Every specimen was carefully preserved and labelled, and deposited in the Coast Survey Office in Washington. The microscopical examination of the specimens was commenced by the late Prof. J. W. Bailey, and after his death this work passed into the hands of Pourtales, who devoted his time to it in the intervals of other duties. That most important deposit, Globigerina mud, was first discovered by Lieutenants Craven and Masfit, U.S.N., during Gulf Stream explorations in 1853. In 1867 systematic dredging in deep and shallow water was commenced on the assumption of the superintendence of the Survey by Prof. B. Pierce, who ordered the dredging. At the suggestion of Louis Agassiz, dredgings were made down to a depth of 1,000 fathoms. In Prof. Agassiz' report one of the richest grounds for deep-sea corals, lying off Cape Florida, was named Pourtales Plateau. In 1871 Pourtales published what is probably his best-known work, namely, his "Deep-Sea Corals" ("Ill. Cat. Mus.

Comp. Zool.," Harvard, No. iv.), a most excellent memoir, containing valuable disquisitions on the affinities of various genera, and excellent notes on the geographical distribution of the species and the nature of the bottom on which the dredgings were made. The memoir contains the results of some interesting researches on the relations of the Rugose to the Henactinian corals, in connection with the account of the aberrant genus *Haplophyllia*. The deep-sea Antipallaria and Actinidæ are described in it, as well as the stony corals, and the genus *Pliobothrus*, with great acumen, referred to its proper place amongst the Hydrozoa. A second memoir on deep-sea corals was contributed by Count Pourtales to the account of the zoological results of the *Hasler* Expedition, and many others on this and other zoological subjects are to be found in the *Bulletin* of the Harvard Museum of Comparative Zoology. The last work which appeared from his pen is the description of the plates of corals in the Report on the Florida Reefs, by the late Prof. Agassiz, which has just been published by Alexander Agassiz, by the permission of the superintendents of the U.S. Coast Survey. These plates are the most perfect and beautiful representations of corals that have as yet been published anywhere. They were drawn under the immediate direction of Prof. Agassiz.

Count Pourtales' name is indissolubly connected with deep-sea zoology by means of the genus *Pourtalesia*, named after him. *Pourtalesia*, a sea-urchin, one of the *Spatangidæ* allied to *Ananchytes*, was found by the *Challenger* expedition to be one of the most ubiquitous and characteristic deep-sea animals. Numerous species of the genus new to science were obtained by the expedition in deep water, some of them being of most extraordinary shapes. In conclusion it need only be added that Count Pourtales' kindness and good-nature were as much appreciated by English naturalists as elsewhere. He was most generous, always ready to give advice to naturalists working in the same most difficult field as himself, to supply them with specimens for investigation, and to discuss in the freest manner, with perfect impartiality, any question of systematic arrangement. He will be regretted by many friends in England, to which he paid frequent visits on his way to his native country, his last visit having been made in the spring of the present year.

H. N. MOSELEY

#### THE BRITISH ASSOCIATION AT SWANSEA

PREPARATIONS of the most unstinted kind are now being made at Swansea to insure to the members of the British Association a hearty, hospitable welcome, a good opportunity for the interchange of scientific results, and an instructive and healthful summer holiday during their visit in the week commencing on Wednesday, August 25 next. The Excursion Committee have already made arrangements for visiting the more interesting places in the district. The presidential address will be delivered on Wednesday, and a portion of Thursday, August 26, will be devoted to an excursion, limited to 200 members, to the celebrated iron-works and collieries at Dowlais, by special invitation of G. T. Clark, Esq., of Dowlais House. As this excursion will take place so early, members who intend joining in it should send in their names to the Local Committee as soon as possible before their arrival in Swansea. The return will be made in time for the reception *soirée*, which the Mayor of Swansea (Alderman John Jones Jenkins) will give in a fine wooden pavilion capable of accommodating 6,000 people.

Saturday, August 28, will be almost entirely devoted to excursions to the Gower Coast, Penrice Castle, Oxwich Bay, Arthur's Stone, Worm's Head, Bishopstone Valley and its underground river; Bacon Hole and other bone-caves, with the Bays; the Via Julia at Langhor, with ruins

of castle, hospitium, sanctuary, and collieries and tin-works; Llandilo, Golden Grove, Carreg-Cennen, and Dynevor Castle; and by sea to Lundy Island and Ilfracombe.

Among the sciences geology this year takes the foremost place in the person of the distinguished president, Prof. Ramsay. There are few districts which comprise, within so small an area, so many geological formations as Swansea, and fewer still that offer such problems for solution and such advantages for useful study. To the west of the town an axis of old red sandstone is thrust up through lower shales and limestones, and the stratifications of the whole neighbourhood have been dislocated and curiously denuded. Along the coast of the Bristol Channel for twenty miles the grand limestone cliffs are fissured and distorted until they exhibit almost every variety of dip and strike. Here are bold projecting torrs, inhabited by sea-birds; undisturbed sandy bays, the realised dream of the bathing enthusiast; and the celebrated bone caves, explored by Buckland and Col. Wood, and described by Falconer. The list of their fossil contents is a long one, including, with the exception of the *Drepanodon* (*Machairodus*) of Kent's Hole, all the larger-sized extinct carnivorous and herbivorous mammalia found in all the caves of England put together. Of the smaller-sized genera, too, Bacon Hole and its neighbouring caverns contained representatives of every one save *Lagomys* and *Spermophilus*. In Mewslade Bay Mr. Prestwich discovered a fine example of raised beach, and beneath the sands of Swansea Bay are well-exposed beds of peat—roots, stems, branches, and leaves of the silver birch, and larger vegetation, the remains of a forest still retained in local tradition. On the other side of the bay, in these deposits, have been found antlers of splendid proportions, and British and Roman implements. The *Pholas candida* is found in the decayed wood, and the rocks at the western extremity of the bay abound with *Lithophagi*, the most numerous being *Saxicava rugosa*. The South Wales coalfield, the largest but one in Britain, is brought within easy workable range by a great east and west anticlinal and several smaller axes, and is so cut into by deep river valleys that the coal is generally worked by means of adits and galleries. As a consequence of this fortunate conformation of carboniferous strata and surface, the deepest coal-pit in the whole basin—Harris's Deep-Navigation Steam Colliery, in the Aberdare Valley—does not exceed 700 yards of vertical depth. There is still considerable difference of opinion as to the identity of certain beds which occupy the place of the millstone grit. To the north and east of the basin the grit is of the usual kind, save where the sands and gravels are compacted into a hard, whitish, quartz-like rock; but to the west of Swansea the equivalent beds change into siliceous under-clays, with coal-seams above them. At Lilliput, in Swansea Bay, there are two interesting outcropping ridges of this kind; and a little farther west still the coal-measures are found to lie conformably on the limestone, with the exception of those in the neighbourhood of Oystermouth Castle, where Sir Henry de la Beche found a section "of a kind of lenticular mass which fines off to the east and west," and "was formed under minor conditions of a different nature." At the head of the Swansea Valley there is said to be "a seam of coal occurring in the millstone grit." The Town hill sandstones, which form the highlands in the neighbourhood of the town, and the high bold escarpments of which may be traced almost all round the Basin, are equivalent to the Pennant rocks of the Bristol district. They are peculiarly interesting for the great quantity of *detrital* coal they contain. A few minutes' walk from the town to the quarries enables the geologist to see the curiosity *in situ*. Even the same coal pebble is sometimes seen to consist of coal of two distinct ages. The markings beautifully show how the newer plants were pressed down

around the coal-pebbles, which, from their greater hardness, have left their impress in the plants; but the crystallisation of the former has a uniform parallelism with the faces of its cleavage, while the cleavage of the older coal is parallel with the sides of pebbles, which occur in all positions, sometimes in the form of a rhomboid, with its edges and corners rounded by attrition. To the east of Swansea, near Southern Down and Dunraven Castle, there are remarkably fine exposures of Lower Lias full of *Gryphea incurva*, with large ammonites and belemnites. Last year an enormous slab was dug out of the Trias rocks at Shortlands, which bears five trifold impressions in a clear series. The length of each footprint is  $9\frac{1}{2}$  inches, and it appears to have been made by "some solidly-built short-legged creature." A little further east the Rhætic Passage Beds are laid open for a distance of more than twenty miles to Penarth Headland, where *Cardium rhaticum* and numerous other characteristic fossils are found. Through these strata there are many railway cuttings and no less than six passenger stations, so that this district is perhaps the best in the whole country for the study of Rhætic strata in the fields. The peninsula of Gower, west of Swansea, besides offering such scientific attractions as bone-caves, underground water-courses, raised beaches, &c., is remarkable for the great beauty and variety of its scenery. Bold highlands and beetling cliffs alternate with heathery downs and commons, well wooded valleys through which trout streams flow, and rocky gorges, half hidden by luxuriant growths of fern. Tumuli, Druidic stones, Roman and Danish earthworks, and a round dozen Norman castles, dating for the most part from the days of William Rufus, lend additional charm to the district, which is peopled by the descendants of a colony of Flemings, who still retain many characteristic words, idioms, and customs, which the ethnologist may profitably study. The lonely granitic rocky island at the entrance to the Bristol Channel is associated with the geology of the Barnstaple district; but it has a history all its own, and a peculiar species of rat. Ilfracombe, on the Devonshire coast, is only two hours from Swansea Pier by a fast-going steam-boat. At Pembroke Dock, on the occasion of the visit, there will be a considerable number of notable ships and corvettes of war, and the *Great Eastern*. Minor excursions will run through the magnificent haven of Milford, and to Tenby, while arrangements are made to take fifty persons by road to St. David's City and Cathedral, with the ruined palace and colleges of the see of Menevia, in the utmost limits of Pembrokeshire.

All these excursions are fixed for Saturday, the 28th, and the Local Committee exact that all applications be sent in before 1 p.m. of the previous Thursday.

On the succeeding Thursday, September 2, the excursions, which are very numerous, will be for the most part to collieries and works. Perhaps the chief interest attaching to Swansea is its metallic industries, of which the district is a chief centre. The copper trade has flourished here for a century and a half to two centuries, but though various new processes have been tried from time to time, practically the oldest dry process, called the Welsh method, is still in use. It is affirmed that nine-tenths of the copper-smelting of the kingdom is done here. The sulphurous and arsenious fumes from these works have entirely denuded the hill-sides of verdure, but it cannot be shown that they injure human health. Among the many inventions for the consumption of this smoke, are washing it with water, collecting the sulphurous acid and converting it into sulphuric acid, and the use of deposit chambers and high chimneys. These processes may be seen at Hafod, the works of Mr. H. H. Vivian, M.P. The other excursions on the same day include various large tin works, where the whole of the processes of making the iron sheets and

tinning them may be seen, and the visitors will be entertained at luncheon by the Worshipful Mayor at his Cwmbwrla Tin-plate Works; to the Landore Siemens Steel Works, where steel is made in gas regenerative furnaces by the Siemens-Martin process, and hammered and rolled and tested for rails, armour-plates, ship and boiler plates, knives, needles, wire, and all other commercial purposes, and visitors will be entertained at lunch by Dr. Siemens; to the Dyffwyn Collieries at Neath, the Navigation Colliery at Quaker's Yard, the Penrhwceiber Colliery, Mountain Ash, &c., the most important coal winnings in the district, at each of which places visitors will be entertained. Visitors to Neath Abbey and district will take luncheon in the ruined refectory, and those to the Vale of Neath Waterfalls in the caves. At their Melyn Decorative Tin Works Messrs. Leach, Flower and Co. will show their extremely interesting processes and give a luncheon; Mr. J. T. D. Llewelyn, of Penllergare, will receive 100 visitors at his ancient and beautifully-situated residence five miles from Swansea; and Mrs. Crawshaw will entertain on this day fifty visitors at Langorse Pool, Brecon. The oyster-dredging expedition in the Bay will start from Swansea Piers, and visit the Lighthouse Rock and Battery, luncheon being served on board. The neighbouring works, which may be easily reached from the town, include the manufacture of patent fuel in the old and in a perfectly new perforated form; sulphuric acid, phosphate manures, cobalt, silver, nickel, lead, spelter, sulphate of ammonia, oxalic acid, distillation of wood, alkalies, &c., &c.

Applications for tickets for these excursions on Thursday, September 2, must be made not later than the forenoon of the previous Monday.

Among the special attractions which will take place concurrently in Swansea are an agricultural show, a flower show, and especially an exhibition of local productions and processes. The exhibition of machinery will be on an extensive scale, and the greater part will be in motion. The more interesting portions of the machinery in motion and the loan exhibition of scientific instruments will be retained as an additional attraction to the second *soirée*.

The accommodation in the town and in the picturesque suburban watering-place of Oystermouth or The Mumbles is in every way ample, and the hospitality will be generous, but it would much facilitate the work of the Local Committee and add greatly to the satisfaction of visitors themselves if they would give timely and sufficient notice of their intention to be present on the occasion.

#### THE HIGH PLATEAUX OF UTAH<sup>1</sup>

UNTIL a few years ago the geography of the high grounds of the western part of North America was depicted, even on the best maps, in a manner which now appears almost like a caricature of nature. So much had been said and written about the Rocky Mountains that the popular imagination was wont to picture them as a colossal, rugged, and almost impassable range, extending continuously down the backbone of the continent, and serving generally as the watershed between the Atlantic and Pacific Oceans. The progress of research, however, dissipated this delusion by showing that, instead of one continuous chain of mountains, a vast area of country, extending from the British possessions far down into the Southern States, has been upraised into elevated plains or table-lands, and that these at various distances have been ridged up by lenticular mountain-chains, sometimes parallel, sometimes *en échelon*, and trending generally in a meridional direction. The term "Rocky Mountains" is now commonly restricted to the most easterly line of

<sup>1</sup> "Report on the Geology of the High Plateaux of Utah." With Atlas. By Capt. E. Dutton, U.S.A. Geographical and Geological Survey of the Territories. J. W. Powell in charge. (Washington, 1880.)



mountains, which serves as a divide or water-parting between the Atlantic slope and the regions lying to the west. But though the traditional glories of the Rocky Mountains have thus been dimmed, and though the most enthusiastic traveller through their still little-known solitudes must in fairness admit that they cannot boast among their innumerable ranges, hitherto visited and described, one which for variety and majesty of outline can be named with the Bernese Oberland, yet this merely nominal degradation is more than compensated by the discovery that these western territories contain a type of high ground to which there is probably no adequate parallel elsewhere on the face of the globe—a type so strange and overwhelming in its first aspect, so weird and almost incredible in its history, that the ordinary language of scenic description fails to convey the impression which the overawed beholder wishes to produce, and he finds himself obliged to borrow a new vocabulary, yet even with its aid is conscious that his narrative, exaggerated as it may seem, falls infinitely short of doing justice to the marvels he has seen.

To the portion of this region which, bounded by the Colorado Park Mountains on the east and by the ranges which border the Great Basin on the west, stretches from Southern Wyoming far into New Mexico and Arizona, the name of the Plateau Country has been given. It is drained mainly by the Colorado River and its tributaries. Its surface at lower levels than 7,000 feet above the sea is a blazing desert, bright with strange mineral colours—glaring red, livid purple, verdigris green, toned white, and ashy grey. On these plains hardly any vegetation grows. Not a solitary tree, save here and there a gnarled cedar, affords a scanty shade, and little but stunted sagebrush or prickly cactus in scattered tufts varies the eternal monotony of the burning soil. It is a region of perpetual drought, for the springs are believed not to average one in a thousand square miles. Yet the land is traversed by a network of rivers, which, however, wind along in profound chasms, to be crossed only by the birds of the air. So deep and sombre are many of these gorges (that of the Colorado being in some places more than a mile deep), that the very sound of their running waters never reaches the level of the plateau above. Only a dim daylight reaches the bottom, and the stars are said to be visible in certain narrow gorges at midday. But where the level of the plateaux rises high enough to condense some of the moisture which the air-currents carry across them the verdureless aspect of the lower plains is replaced by luxuriant forests and open glades carpeted with rich grass and wild flowers. So colossal, however, are the table-lands that some of them slope gradually out of the range of tree-growth to a height of from 11,000 to 12,000 feet above the sea, and almost lie within the limit of perpetual snow.

So far as yet known, the Plateau country reaches the fullest development of its extraordinary features in the southern portions of the Territory of Utah. This region was partially explored by Prof. Powell during his surveys from 1869 to 1874, and by the parties under Capt. Wheeler, especially by Mr. Howell and Mr. Gilbert, whose published reports form a valuable portion of the third volume of the "Geographical and Geological Explorations west of the One Hundredth Meridian," conducted by Capt. Wheeler. In 1875 Mr. Powell secured the services of Capt. Dutton for the investigation of a large volcanic tract among the Utah Plateaux as part of the survey under his direction. Capt. Dutton spent the seasons of 1875, 1876, and 1877 at the task assigned to him. We have now the result of this labour in the handsome quarto volume and beautiful atlas which have just appeared. This publication is undoubtedly one of the very best of the many admirable contributions to geology which have recently been made by the official surveys of the United States. With the aid of the letterpress, maps,

and sections any geological reader can follow and realise to himself the almost incredible magnificence, as well as simplicity, of the structure of these high Plateaux.

The geology of the area may be briefly described as presenting a succession of nearly horizontal sedimentary formations from the upper Carboniferous up to the Eocene lacustrine deposits of the West, thrown into a succession of broad folds, cut into segments by a series of important faults, and overlaid towards the north by vast sheets of volcanic ejections, the whole of the rocks, aqueous and igneous, having been carved into valleys, gorges, escarpments, outliers, and isolated plateaux of the most imposing magnitude.

From the Carboniferous up to the top of the Cretaceous series there does not appear to be any general physical break in the continuity of the stratification. The Carboniferous rocks are only partially exposed, but their overlying beds—the singular deep purple, chocolate, slate, and brownish-red Shinarump group—attain a greater development, exhibiting their peculiar regularity of sedimentation and their sculptured terraces and outliers. These characteristic strata have been classed as Permian or Lower Triassic, but the researches of last year have, we believe, brought to light fossils which point unmistakably to their Permian age. An occasional want of conformability is observed between them and the overlying Trias, but as a rule the latter follow without discordance, and rise into the succession of bright red and orange sandstones and shales which constitute the great cliff-forming series throughout the Plateau country. A geologist accustomed to the scenery of the "New Red" plains of Central England may find it hard to believe that the Trias of Western America forms ranges of vermilion-coloured cliffs 1,000 or 1,500 feet high, projecting in vast promontories, retiring into deep bays, and stretching with the same brightness of colour and the same regularity of front for hundreds of miles. No very satisfactory line has yet been drawn between the Trias and the Jura. The latter series consists in the Plateau country of two members, the lower being a massive grey or white sandstone of great thickness, the upper a series of calcareous and gypsiferous shales from 200 to 400 feet thick. This sandstone, according to Capt. Dutton, was laid down over an area which cannot fall much short of 35,000 square miles, with an average thickness of more than 1,000 feet. Yet so persistent were the conditions of its deposit that from bottom to top, sometimes through a depth of nearly 2,000 feet, it everywhere consists of intricately false-bedded sandstone without layers or partings of shaly or other heterogeneous matter. From the Upper Jurassic calcareous beds distinctive fossils have been obtained.

The Cretaceous system presents here the usual massive development of sandstones and shales which form so prominent a feature in the geology of the West. The Lower Cretaceous Dakota group is recognised by its lithological resemblance to the corresponding beds in Colorado and elsewhere, and by the occurrence of species of *Ostrea*, *Gryphaea*, *Exogyra*, *Plicatula*, &c. The overlying shales are identified with the Laramie group, which the author places as Upper Cretaceous. The whole of the Cretaceous series is more or less lignitiferous; a considerable number of workable coal-seams in it being already known. At the close of the deposition of the Laramie group the first important break in the succession of the rocks occurs. Extensive disturbance took place along the old Mesozoic shore-line which now bounds the Great Basin on the east, and this was accompanied and followed by such enormous denudation that the Cretaceous series, several thousand feet in thickness, was entirely removed and the oldest Tertiary strata accumulated on the exposed surface of Jurassic beds. Yet so local were these movements that in adjacent tracts the whole Cretaceous series of the region is present, and

appears to be followed without interruption by a conformable suite of Eocene strata.

The geographical changes that closed the Cretaceous period in the West were among the most important in the evolution of the American continent. Over many thousand square miles the floor of the sea was raised into land which has never since been again submerged. The lacustrine conditions which began in Cretaceous times now received a far greater development. The waters of the ocean, inclosed into inland seas, from brackish became fresh, and one or more lakes, of perhaps even greater dimensions than those of Eastern America, stretched between the heights of the Great Basin and the Rocky Mountains for as yet an unknown distance to the south. The history of these lakes has been studied by Hayden, King, Powell, and other geologists, and their marvellously rich ichthyic, reptilian, and mammalian fauna has been described by Leidy, Marsh, and Cope. Much remains to be done before the history can be regarded as even approximately filled in. In the meanwhile it is certain that this lacustrine area was undergoing slow subsidence during Eocene time, that sediment was being continually washed into it from adjoining mountains, that eventually 5,000 feet or more of strata were laid down over its site, and that the area of fresh water progressively diminished.

A new chapter in this eventful history is revealed by Capt. Dutton. He tells how in Southern Utah the lake, even as far back as the time of the Middle Eocene, was the theatre of volcanic discharges, and how these, after vast intervals of quiescence and almost incredible denudation, have been from time to time renewed down even to a period so recent that it can hardly be believed to date so far back as the days of Cortez and the Spanish Conquest. He shows that this volcanic district discloses a remarkable variety of phenomena, nearly every form of eruption being exhibited, and every great group of volcanic rocks being represented in it. The earliest volcanic rocks are tuffs, which he regards as probably derived in chief measure from the degradation of older lavas and the deposit of the resulting sediment on the floor of the lake. The next phase of volcanic activity was marked by the outpouring of masses of propylite and hornblende-andesite, and was succeeded by the third and grandest of all, when floods of trachytes and rhyolites, alternating with augitic andesites and dolerites, rolled far and wide over the plateaux. The author is doubtful whether these extravasations proceeded from Ætna-like summits or craters, and is rather inclined to look upon the larger deluges as having issued from local fissures. Certainly if any true lofty volcanic cones existed, all external trace of them has been completely effaced by denudation. The closing event in this long volcanic period, if indeed the record can be properly regarded as even yet closed, consisted in the emission of abundant streams of lava round the larger areas of previous activity. Capt. Dutton notices some remarkable examples of a feature which occurs on a much smaller scale in the volcanic region of the Rhine and Moselle. The basalt cones and craters whence the streams have emanated seldom appear at the base of the great cliffs or at the bottoms of the deep cañons. They are often crowded together near the crests of the terrace walls, or the lava has broken out from the face of a wall. They commonly lie near lines of fault, yet appear almost always on the uplifted instead of the depressed side of the dislocation. "The least common place for a basaltic crater is at the base of a cliff." Among the volcanic masses special attention is given to the enormous accumulations of conglomerate and tuff, which cover nearly 2,000 square miles of area, and range from a few hundred feet to nearly 2,500 feet in thickness. These vast piles of coarse detritus the author attributes to the atmospheric disintegration of previously erupted lavas, and he describes in detail the process by

which similar conglomerates are at the present moment being formed by frost, rain, and mountain-torrents. The highly important observation was made by him among the older tuffs, that in some places they have been so metamorphosed that the product of alteration is a rock possessing all the ordinary characters of a lava.

The chronological sequence of volcanic rocks among the Plateaux of Utah has been recognised as obeying generally the order enunciated by Richthofen. Capt. Dutton, starting from this observed sequence, devotes two long chapters to theoretical discussion—one on the classification, the other on the origin of volcanic rocks. To his work in the field he has added careful labour indoors, especially studying the microscopical and chemical characters of volcanic rocks. No one can read his pages without recognising their suggestiveness, even though the conclusions reached in them may sometimes appear doubtfully valid. His remarks upon the texture of volcanic rocks (pp. 91–99) offer an excellent sample of his critical treatment. Pointing out how different may be the texture assumed by the same original magma according to whether the mass has cooled and consolidated at the surface or beneath it, he is disposed to regard the intrusive condition as a kind of intermediate stage between volcanic rocks which have issued above ground and non-eruptive masses which have remained inactive deep beneath it, and he regards the porphyritic texture as especially characteristic of this "qualified eruption." This generalisation is only partially supported by the volcanic history of Britain. Among our older Palæozoic rocks, indeed, the intrusive or injected masses very generally possess the porphyritic structure. But from the time of the Lower Old Red Sandstone onwards to the Miocene volcanic period inclusive, the intrusive sheets are for the most part non-porphyritic, while the porphyritic structure is found among the superficial lavas. The classification our author proposes is as follows:—

#### ACID SERIES—Group I. RHYOLITES.

- Sub-group 1. Nevadite or granitoid rhyolite.
2. Liparite or porphyritic rhyolite.
3. Rhyolite proper, or hyaline rhyolite.

#### SUB-ACID SERIES—Group II. TRACHYTES.

##### Sub-group A. Sanidinic Trachytes.

1. Granitoid Trachyte.
2. Porphyritic Trachyte.
3. Argilloid Trachyte.
4. Hyaline Trachyte.

##### Sub-group B. Hornblendic Trachytes.

5. Hornblendic Trachyte.
6. Augitic Trachyte.
7. Phonolite.
8. Trachytic Obsidian.

#### SUB-BASIC SERIES—PROPYLITE AND ANDESITE.

##### Sub-group 1. Hornblendic Propylite.

2. Augitic Propylite (?).
3. Quartz-Propylite.
4. Hornblendic Andesite.
5. Augitic Andesite.
6. Dacite or Quartz-andesite.

#### BASIC SERIES—BASALTS.

##### Sub-group 1. Dolerite.

2. Nepheline-dolerite.
3. Basalt.
4. Leucite-basalt.
5. Nepheline-basalt.
6. Tachylite.

The fifth chapter is entitled "Speculations concerning the Causes of Volcanic Action." The author propounds a very ingenious trial hypothesis, by which he believes the sequence of volcanic phenomena throughout at least the Rocky Mountain region may be explained. He assumes that volcanic phenomena are brought about by a

local increase of temperature within certain subterranean horizons. But, as he himself admits, this way of putting the case brings us no nearer to what may be the ultimate cause of such a local increase of temperature. He seeks to prove that all the phenomena of volcanic action point to local excitation, and that the observed order of appearance of lavas is what on this view might theoretically be anticipated. It would be beyond the necessary limits of this article to follow him into the details of his argument. But one or two points may be briefly referred to. He regards lavas as mainly derived not from primeval subterranean magmas, but rather from the fusion of such rocks as the crystalline schists and sedimentary formations. In the mechanics of eruptions he believes that the outpouring of lava does not arise from the expansion of vapours absorbed within the molten magma, but is merely a hydrostatic problem of the simplest order—the lava being forced out by the weight of the rocks overlying its subterranean reservoirs.

According to this hypothesis two preliminary conditions are requisite for an eruption of lava—the rocks must be fused, and their density in the molten state must be less than that of the overlying rocks. The author regards the observed order of appearance of the lavas to be determined by their relative density and fusibility, the more siliceous requiring a higher temperature to fuse them, and the more basic, though less refractory, demanding a higher temperature to give them such a diminution of density as will permit them to be erupted. At an early stage of eruption he holds that the acid rocks may be light enough to be ejected, but are not yet melted, while the basic rocks may be melted but must await further expansion by access of heat before they are capable of being poured forth. Hence some intermediate rock will be selected as the first to issue, and this rock the author believes to be *prophyllite*. A further increase of temperature produces hornblended *andesite* and *trachyte*, and so on to the *rhyolites*, and finally the *basalts*. All rocks more basic than *prophyllite* are stated to present evidence of *superfusion*, these rocks, according to the theory, being those which possess so high a density as to demand a much greater accession of heat than that required for mere fusion, in order that they may become lighter than the overlying crust, and thus be erupted. *Basalt* in particular is cited as an example of a *superfused* rock.

The author tacitly assumes that the density of a lava at the time of its outflow is necessarily less than that of the rocks through which it ascends, otherwise it could not be erupted. It is a pity that no experimental demonstration of this assertion was given, for it forms so fundamental a postulate in the hypothesis. But even on the supposition that the lava is forced out by the descent of heavier overlying rock, what ought to be found as proof of this action? Ought we not to meet with abundant evidence of subsidence at volcanic foci? Every mass of lava derived from the local fusion of rocks at no great depth beneath the surface and driven out by the weight of rock overlying it, should have an accompanying and proportionate subsidence of the crust over the site of its source. Occasional proofs of collapse at volcanoes have long been known indeed, but admit of other explanation, such as "evisceration," to use Mr. Mallet's phrase. Instead of subsidence, the emission of volcanic material has generally been accompanied with upheaval. Capt. Dutton's own magnificent Plateaux of Utah should furnish copious proofs of a sinking or sagging of the nearly horizontal strata round the eruptive vents. But there is no trace of any structure of this kind in his instructive and carefully-drawn sections.

Again, the alleged *superfusion* of the basic rocks can hardly be admitted upon the evidence here brought forward in its support. The fact that thin streams of *basalt* have had a greater liquidity and have retained it for much greater distances than the acid lavas, has long been

recognised. But as Reyer has recently suggested, it is capable of a different interpretation from that of *superfusion*. The author appeals also to the microscopic structure of *basalt* as favouring his view of former intense ignition. He cites, for example, the presence of glass particles, the absence of water-cavities, the isotropic base, the compactness and vitreous structure of this rock. But are not these characters present in far more striking development among the vitreous acid rocks, which he supposes to have had a temperature little more than sufficient for fusion? The exceptions which the author candidly admits to occur in the normal succession of lavas—*basalts*, for example, appearing before *rhyolites*, or *quartz porphyllite* and *quartz-andesite* simultaneously with the hornblended members of their respective groups—seem fatal to the hypothesis.

From another point of view the idea that the order of emission of lavas has been determined in the way supposed presents great difficulties. The author affirms that "we must at least admit that the source of lavas is among segregated masses of heterogeneous materials," and he supposes that "this arrangement would be well satisfied by a succession of metamorphic strata [gneiss, hornblended and augitic schist] resting upon a supposed primitive crust or magma having a constitution approximating that of the basaltic group of rocks." But every known mass of metamorphic strata presents endless interstratifications of very various materials. By what process of selection are the elements of these diverse rocks grouped successively into definite volcanic compounds? How is it that out of the simmering subterranean broth just so much silica and alumina as are needed for one type are ladled out at one time, while a careful hand is kept on the lime, alkalies and iron-oxides, only the right proportions being dealt forth for each lava?

The remarkable persistence of type among the different species of lava all over the world has long been recognised. It is not easy to see how this persistence should exist, nor why there should not be far more varieties of lava and transitional grades between the varieties if they are due to the local melting up of various masses of heterogeneous materials within the crust.

The volume is illustrated by a series of heliotype plates, from photographs taken in the course of the survey, representing some of the more remarkable external forms assumed by the sedimentary and volcanic rocks. The Atlas contains a valuable series of topographical and geological maps. Among these a relief-map of the Plateaux, on the scale of five miles to an inch, is specially instructive. There are likewise two plates of sections, which bring before the eye in a clear and concise form the structural details of the region. In point of execution the plates of the atlas are altogether admirable. In his preface Capt. Dutton states that he undertook the task of exploration assigned to him with considerable diffidence in his ability to accomplish it. He must be congratulated on having achieved a signal success. His work bears everywhere marks of the most conscientious and painstaking industry, great acuteness of observation, and not a little literary skill in the marshalling and presentation of the facts observed. Let us hope that the arrangement by which he was enabled to exchange the routine duties of an army officer for geological field-work may be prolonged, and that in further prosecution of his explorations in the West he may live to issue other volumes as interesting and valuable as that which is noticed here.

ARCH. GEIKIE

#### TWO NEW PLANETARY NEBULÆ

A PLANETARY nebula in R.A. 18h. 25<sup>m</sup>. and Dec. — 25° 13' was discovered at the Harvard College Observatory on the evening of July 13. A second

nebula was found on the following evening in R.A. 18h. 43m. and Dec.  $-28^{\circ} 12'$ . Both, but particularly the first, are only minute, and can be with difficulty distinguished from stars, except by their spectra. The discovery was not the result of accident but of a search with a direct vision prism inserted between the objective and eyepiece of the 15-inch telescope. A star appears as a coloured line of light, while a planetary nebula forms a bright point, and is recognised instantly in sweeping. Many hundred or thousand stars can thus be examined very rapidly, and a single nebula picked out from among them. This method promises to add very greatly to the list of known planetary nebulae, which now number about fifty. Probably a systematic search for these objects crossing a considerable part of the heavens will be made at this Observatory. Our knowledge of that distribution will thus be greatly increased, and we shall know that their absence in certain parts of the sky is not due to an omission to look for them. Any planetary nebula as bright as a twelfth-magnitude star would probably be detected by the method proposed. Bright lines or other peculiarities in the stellar spectra will also be looked for.

Doubt has been thrown on many of the attempts to measure the parallax of planetary nebulae owing to the haziness of the borders of these bodies. The minuteness of the disks of the nebulae noted above could permit their positions to be determined with great precision, and would thus show a very minute parallax.

Cambridge, U.S., July 15 EDWARD C. PICKERING

#### NOTES

AN influential committee has been formed from among the members in the Section of Zoology of the Paris Academy of Sciences and others eminent in that department, to obtain subscriptions for a medal in honour of M. Milne-Edwards, the *doyen* of French zoologists.

A MOVEMENT has been set on foot to obtain subscriptions to a memorial fund in honour of the late Rev. J. Clifton Ward, whose name must be well known to our readers as a working geologist who made valuable contributions to his science. Mr. Ward, moreover, did great service in promoting a love of science in Cumberland, and the Association for the Advancement of Literature and Science, for which he did so much, has taken the fund heartily up. It ought to receive many subscriptions outside of the Association, and we commend it to the liberality of our readers. Subscriptions should be sent to the Rev. Canon Battersby, St. John's Parsonage, Keswick, and to Mr. Edwin Jackson, hon. treasurer, Keswick Library and Scientific Society. It is proposed to expend the fund in the erection of a mural tablet in the church of St. John, Keswick, and the remainder in laying the foundation of a fund for the education of Mr. Ward's two daughters.

IN answer to a question in the House of Commons as to the cause of the delay in the removal of the Natural History Collection from the British Museum to South Kensington, and when that removal would be completed, Mr. Walpole said he believed the delay had been caused by the facts that the building in which the collection was to be placed was not handed over to the Trustees of the British Museum until June, and that the grant made by the Treasury was not sufficiently large to cover the whole estimated expense for the cost of the removal. He believed the removal of the mineralogical, geological, and botanical collection would be completed by the end of the year or in the spring of next year; and that as far as the zoological collection was concerned, its removal would depend very materially upon the grant which the Treasury might feel itself at liberty to make for the purpose.

PROF. ED. VAN BENEDEN is at present at Bergen for the purpose of working out the embryonic development of the Lemming,

which is likely to prove extremely interesting, because that of the guinea-pig is so abnormal.

A FEW months after Leverrier's death a commission was established for determining the best means of protecting collieries from fire-damp. The Commission has written a very long report recording the causes of 420 accidents. Sixty-four projects presented by private individuals have been examined, and some new instruments have been designed and are being constructed, viz., an anemometer by Vicaire, a manometer by Le Chatellier, and a registering apparatus for the quantity of air introduced into the galleries. But the composition of coal explosive dust has not been determined, nor the extent of its influence on catastrophes; the chemical analysis of Grisau has not been completed, and the salvage question has not been exhausted. The only substantial benefit is a compilation of mining regulations and a series of propositions which have been transmitted to the French Ministry, and will be laid before Parliament next session.

THE detailed programme of the annual meeting of the Iron and Steel Institute, to be held at Düsseldorf on August 25, 26, 27, and 28, is now published. The proceedings commence with a concert at the Tonhalle on Tuesday evening, August 24. On Wednesday there is to be in the morning a general meeting of members at the Tonhalle, where the institute will be received by the local authorities; in the afternoon a visit to the exhibition and to works near Düsseldorf; and in the evening the annual dinner of the institute at the Tonhalle. On Thursday and Friday there are to be general meetings in the morning for the reading and discussion of papers; the afternoons are to be devoted to excursions by special trains to various iron and steel works in the neighbourhood of Düsseldorf, followed by concerts in the evenings. The whole will be brought to a close by a Rhine excursion on Saturday, which is timed to bring members by 10.30 p.m. to Cologne, *via* Rolandseck, Bingen, and Coblenz. The general secretary is Mr. J. S. Jeans, whose address up till August 19 is 7, Westminster Chambers, Victoria Street; and after that date, Tonhalle, Düsseldorf.

THE Aldini gold medal (worth 1,000 lire) will be awarded by the Academy of Sciences of the Institute of Bologna to the best memoir on galvanism (animal electricity). Memoirs to be written in Italian, Latin, or French, and sent in before June 30, 1882.

THE Beneke prizes (first, 1,700 marks; second, 60 marks) of the Philosophical Faculty of Gottingen University are offered for investigation, theoretical and experimental, of diffraction phenomena in the case of non-homocentric light sources, especially, a circular and a square luminous surface of uniform brightness of the emitted simple or compound white light. Memoirs to be written in German, Latin, French, or English, and sent in before March 11, 1883.

A NEW process for obtaining stereotypes for printing has been discovered by M. Emile Jeannin, a sculptor of Paris, who proposes to employ for that purpose the material known as *celluloid*. The process of preparation takes only half an hour, when the types are once set up, and the plates thus produced are remarkably suitable for working on cylinder machines running at a high speed, being very light, flexible, and very durable. In this last respect indeed they surpass metal plates, affording, it is said, 50,000 impressions, whereas even an electrotyped copper plate backed with lead will only last for 30,000.

THE astronomical observatory established on the Trocadéro, is not the only scientific establishment which has found a home in the palace of the last Universal Exhibition. A number of microscopes have been arranged in a special room for the benefit of public instruction. The instruments lent by M. Joubert have been placed on the top of one of the towers, where a lift

has been arranged for helping visitors to find their way to this exalted situation.

A VERY curious telephonic experiment has been made in Switzerland on the occasion of the Federal *fête* of singers. A telephone had been placed in the Zürich Festhalle and two conductors connected with the Bâle telegraphic office, where a large audience had congregated. The distance from Bâle to Zürich is about 80 kilometres. The Bâle audience enjoyed the singing about as well as if they had been placed in the upper circle of an ordinary Opera House. At the end of the performance they proved their satisfaction by clapping hands, which the telegraphic wires transmitted with perfect fidelity to the Zürich performers.

A CREDIT of 25,000 francs has been voted by the French Parliament for establishing, on solid foundations, one signal at each extremity of the Melun base line, which was used by Delambre for measuring the distance from Dunkerque to Perpignan, and establishing the length of the metre. This operation was begun by Delambre and Laplace on 17 Vendémiaire, An VI. (October 1797) and terminated in six weeks. This base has a length of 6,000 toises, and was situated on the margin of a public road going from Lieusaint to the crossing of the Brie and Paris roads.

A STRONG shock of earthquake was felt at Smyrna at 5.10 a.m. on July 29. The walls of the telegraph office were split in two or three places. Four or five houses were thrown down, and many others were much damaged by the oscillation. Two of the inhabitants were killed, and five or six injured. Much damage has also been done in the country near Smyrna. At Burnabat the shock caused eleven houses and several cafés to fall in. Two minarets were also thrown down and two people were killed, and ten more or less injured. Slight shocks continued to be felt from time to time.

THE new edition of the "Guide to the Gardens of the Zoological Society" brings the notices of the tenants of the Gardens up to the latest date. Mr. Sclater's name as editor of the Guide is a sufficient guarantee for its accuracy, while the numerous illustrations render it both attractive and instructive. By means of this very cheap Guide a visit to the Gardens will be rendered doubly enjoyable and profitable.

THE *Gardeners' Chronicle*, in advocating the establishment of school gardens where practicable, as an instrument of useful scientific education, refers to the success of such gardens in Bavaria, Belgium, Sweden, and other countries. In Sweden alone there are nearly 2,000 school gardens.

WE have received a copy of the *American Antiquarian*, No. 3, vol. II., published at Chicago by Jameson and Morse, and edited by the Rev. S. D. Peet. It seems to us to be doing useful work in collecting information on early America, though several other serial publications in the States are doing the same thing to a greater or less extent. Excessive subdivision of labour of this kind in any special department is apt to embarrass the student.

THE subject of a depraved taste in animals is an interesting one, which has not been studied as much perhaps as it might. In human beings it would seem to depend on ill-health of either body or mind, but in animals it would seem as if it might be present and the animal enjoy good health. One remarkable instance in an herbivorous animal we can vouch for. It occurred in a sheep that had been shipped on board one of the P. and O. steamers to help to supply the kitchen on board, but while fattening it developed an inordinate taste for tobacco, which it would eat in any quantity that was given to it. It did not much care for cigars, and altogether objected to burnt ends; but it would greedily devour the half-chewed quid of a sailor or a

handful of roll tobacco. While chewing there was apparently no undue flow of saliva, and its taste was so peculiar that most of the passengers on board amused themselves by feeding it; to see for themselves if it were really so. As a consequence, though in fair condition, the cook was afraid to kill the sheep, believing that the mutton would have a flavour of tobacco. Another very remarkable case has just been communicated to us by Mr. Francis Goodlake: this time a flesh-eating animal in the shape of a kitten, about five months old, who shows a passionate fondness for salads. It eats no end of sliced cucumber dressed with vinegar, even when hot with cayenne pepper. After a little fencing it has eaten a piece of boiled beef with mustard. Its mother was at least once seen to eat a slice of cucumber which had salt, pepper, and vinegar on it. The kitten is apparently in good health, and its extraordinary taste is not easily accounted for. Even supposing it once got a feed of salmon mayonnaise, why should it now select to prefer the dressing to the fish?

THE *American Journal of Microscopy and Popular Science* (vol. iv., 1879, of which is before us) is now published monthly. Besides various original articles, some of which are illustrated, it contains from time to time abstracts of the transactions of many of the microscopical societies of the United States. This journal, without aiming at a standard to be compared with the European journals relating to microscopical science, seems to perform its part well, and we are glad to know that it has done much to encourage the use of the microscope in the States. We may trust soon to see some results from all this work, and to find the chief articles in the *American Journal of Microscopy* the result of original researches among the minute algae, fungi, rhizopods and infusoria of America, and that the extracts from the various European journals may be relegated to a second place. There is without doubt an abundant field for work of this nature in America—witness Leidy's volume on rhizopods—nor do we understand why the labourers should be so few.

THE *Ceylon Observer* has published letters from Mr. Morris, who was recently transferred to the Botanical Gardens, Jamaica, detailing his recent experiences with regard to the cultivation of cinchona, and his views on the coffee-leaf disease in Ceylon. He still maintains the usefulness of dusting with lime and sulphur.

FURTHER rich discoveries of gold are reported to have been made in Northern Queensland and Tasmania. It is also stated that gold has been discovered under the basalt in the Brook Mountains, in New South Wales, the first instance of the kind in the colony.

IN a memoir published by the *Revue Scientifique*, M. Ernest Maindron, archivist of the Academy of Sciences, shows that the Academy is possessed of an income of 116,000 francs, to be awarded in about thirty prizes, of which the periodicity varies from one year to ten.

FROM the Fifth Annual Report of the Hertfordshire (formerly the Watford) Natural History Society, we are glad to learn that that society is now prosperous, its membership having greatly increased during the past year.

THE *Proceedings* of the Nottingham Literary and Philosophical Society for 1879-80 is mainly occupied with the president's (Rev. R. A. Armstrong) address on "What is Science?" papers on "Sandstones," by Mr. J. H. Jennings; "Philosophy in the Middle Ages," by Mr. G. B. Kidd; and "Structure of Molecules," by Mr. J. J. Harris Teall. A large number of lectures on scientific subjects were given during the session, and several special papers read in the Natural History Section.

THE *Transactions* of the Norfolk and Norwich Naturalists Society for 1879-80 contains a favourable report of the present

condition of the Society. The address of the president, Mr. T. Southwell, is on the Extinction of Native Races. Among other papers of interest are: "Notes on Collecting Lepidoptera in Norfolk, 1878," by Mr. F. D. Wheeler; "Discovery of Remains of *Emys lutaria* in the Mundesley River-bed," by Mr. H. B. Woodward; The Bird-Life and the Geology of the Shiant Isles, by Mr. Harvie-Brown and Prof. Heddle respectively; Notes on Hawking in Norfolk, by Prof. Newton and Mr. J. E. Harting; Ornithological Notes and Meteorological Observations.

THE *Proceedings* of the Liverpool Naturalists Field Club for 1879-80 contains notes of the excursions and meetings of the Society. The only papers given are by the president, the Rev. H. H. Higgins, one being "Biographical Sketches in Zoology, from its Origin to its Union with Botany in the Science of Biology."

THE additions to the Zoological Society's Gardens during the past week include a Macaque Monkey (*Macacus cynomolgus*) from India, presented by Mr. J. Anson; a Side-Striped Jackal (*Canis lateralis*) from East Africa, presented by Commander Owen, R.M.S. *Anglian*; a Common Ocelot (*Felis pardalis*) from Mexico, presented by Mr. A. L. Schütte; two Common Peafowls (*Pavo cristata*) from India, presented by Mrs. Joseph Hoare; four Globose Curassows (*Crax globicera*), a Little Guan (*Ortalis motmot*) from British Honduras, presented by Mr. F. P. Barlee, C.M.G.; ten Amaduvade Finches (*Estrela amandava*) from India, presented by Mr. J. W. Wilson; a Mississippi Alligator (*Alligator mississippiensis*) from North America, presented by Mr. T. L. M. Rose; two Horrid Rattlesnakes (*Crotalus horridus*) from Nicaragua, presented by Messrs. Holt, Lord, and Co.; an Anaconda (*Eunectes murinus*) from South America, presented by Mr. G. H. Hawtayne; a Bonnet Monkey (*Macacus radiatus*) from India, an Arctic Fox (*Canis lagopus*) from the Arctic regions; a Nilotic Crocodile (*Crocodilus vulgaris*) from Africa, deposited; a Nylghaie (*Boselaphus pictus*) from India, a Collared Peccary (*Dicotyles tajaçu*) from South America, two Common Otters (*Lutra vulgaris, fr.*), British; a Ground Hornbill (*Bucorvus abyssinicus*), an Elate Hornbill (*Buceros elatus*) from West Africa, a Virginian Eagle Owl (*Bubo virginianus*) from North America, a White-necked Crow (*Corvus scapularis*) from Africa, purchased; and a Collared Fruit Bat (*Cynonycteris collaris*), born in the Gardens.

#### ON CURRENTS PRODUCED BY FRICTION BETWEEN CONDUCTING SUBSTANCES, AND ON A NEW FORM OF TELEPHONE RECEIVER<sup>1</sup>

IN a communication to the Royal Society of Edinburgh of date January 6, 1879, I showed that "electric currents were produced by the mere friction between conducting substances." The existence of these currents can be easily demonstrated either by a telephone or a Thomson's galvanometer. I have since found that these currents are, for all pairs of metals which I have yet tried, in the same direction as the thermo-electric current got by heating the junction of the same two metals. They are also, approximately at least, stronger in proportion as the metals rubbed are far apart on the thermo-electric scale—the strongest current, as far as I have yet observed, being got by rubbing antimony and bismuth together. These observations clearly point to a thermo-electric origin for the currents; but it is possible that they may be due partly to the currents suggested by Sir William Thomson as the cause of friction, and partly, also, to contact force between films of air or oxide adhering to the surfaces of the metals.

Having ascertained that these friction-currents are of some strength and fairly constant, I proceeded to make several kinds of machine for producing currents on this principle. One of them consists of a cylinder of antimony, which can be rotated rapidly, while a plate of bismuth is pressed hard against it by a

<sup>1</sup> Abstract of a paper read before the Royal Society of Edinburgh by James Blyth, M.A., F.R.S.E., on May 3, 1880.

stiff spring. When this machine is included in the same circuit with a microphone and a Bell telephone, the current got from it is quite sufficient to serve for the transmission of musical sounds and also loud speaking. The transmitter, which I have found most serviceable in my experiments, is made by screwing two small cubes of gas-carbon to a violin, and placing between them a long stick of carbon pointed at both ends, the points being made to rest in conical holes in the carbon cubes. The looseness of the contact is regulated by a paper spring. This forms an excellent and handy transmitter for all kinds of musical sounds, and also serves very well for transmitting speech.

Seeing that friction between metals clearly produces a current, it seemed natural to inquire if the converse held good, that is, if a current from a battery sent across the junction of two metals affected the friction of the one upon the other. I have tested for this in a variety of ways, and the results obtained leave me in doubt whether to attribute them to variations in the friction, or to actual sticking produced by fusion of the points of contact, through which the current passes. The most noticeable effect is produced when one of the rubbing bodies is a mere point, and the other a smooth surface of metal. This led me to make a modification of the loud-speaking telephone of Mr. Edison, in order to get audible indications of changes of friction produced by the passing of a variable current. It consists of a cylinder of bismuth accurately turned and revolving on centres. The rubbing-point is made of a sewing-needle with its point bent at right angles, and its other end attached to the centre of the mica disk of a phonograph mouthpiece. It is evident that this is only a loose contact, which can be perpetually changed. When this apparatus is included in the circuit with the violin microphone and three or four Bunsen cells, the violin sound, as was to be expected, are heard proceeding from the loose contact, even when the cylinder is not rotated. They are increased, however, in a remarkable degree by rotating the cylinder slowly, so much so that a tune played on the violin can, with proper care, be distinctly heard all over an ordinary room.

With regard to the explanation of this effect, it is evident, that electrolysis can in no sense come into play, as is supposed to be the case in Edison's instrument. I am inclined to look for the explanation rather in the direction of the Trevelyan rocker, although the circumstances are considerably different in the two cases. In the rocker we have the heat passing from a mass of hot metal through two points of support to a cold block, whereas, in the other case, the heat is only intense at the points of contact, the rest of the metals being comparatively unaffected. The variations in the current produced by the transmitting microphone must cause corresponding variations in the heat at the point of contact of the needle with the cylinder, and this again produces a mechanical movement of the pressing point, as well as of the air surrounding it, sufficient to give forth sound-waves. If such be the case the effect should be different for different metals, those answering best which have the lowest thermal conductivity and also the lowest specific heat. That this is really so is shown by substituting cylinders of other metals for the bismuth, all other things remaining the same. In this way I have compared lead, tin, iron, copper, carbon, and find that they all give forth the simple loose contact-sound when the cylinder is stationary, but that it is only with bismuth that there is any very great intensification of the sound when the cylinder is rotated. Now, by consulting the appropriate tables I find that bismuth is a fraction lower than any other common metal in specific heat, while it is much below them all in thermal conductivity. This seems to bear out my explanation to a certain extent.

#### UNIVERSITY AND EDUCATIONAL INTELLIGENCE

CAMBRIDGE.—The subject for the Sedgwick Prize essay, 1883, is "The Classification of the Cambrian and Silurian Rocks." The prize is open to all graduates of the University of Cambridge who have resided sixty days during the twelve months preceding October 1, 1882. The essays must be sent in to the Registrar, on or before October 1, 1882.

#### SCIENTIFIC SERIALS

*Proceedings of the Academy of Natural Sciences of Philadelphia*, Part 1, January to April.—Thomas Meehan, on disarticulating branches in *Ampelopsis* (the annual growth is dis

culated at just one node above that one made the previous year, the branch thus gaining but one node in the year. This reminds one of the South Pacific Vitis, which produces tubers at the end of the branches, and at the end of each season disticulates them).—On germination in acorns (in *Quercus virens*, fr. Maryck has noticed that the two petioles instead of being short were produced to a length of 1½ inches before the plumule and hypocotyledonary portions of the young plant commenced air growth, and a small tuberous projection nearly one-fourth the size of the acorn preceded the growth downwards of the stipe and upwards of the plumule. The cells in all of these were gorged with starch).—Dr. Leidy, notice of *Filaria immitis* in the dog, and on a *Filaria* reported to have come from a man. W. N. Lockington, on the Pacific species of *Caulolatilus*.—Bellprin, Angelo, on the stratigraphical evidence afforded by the tertiary fossils of the peninsula of Maryland.—J. S. Kingsley, ornithological notes: I. (chiefly relates to the genus *Thelphusa*, describes two new species from Ceylon and one from West Africa; also a new species of *Dilocarcinus*. II. Revision of the *Plasmi*, plates 9 and 10).—Dr. Allen, description of a foetal *Alrus*, and on the mammae of bats.—Dr. R. Bergh, on the subbranches of the North Pacific Ocean, with special reference to those of Alaska, Part 2, plates 1 to 8.—Howard Kelly, on a sartorius muscle in the gorilla. This muscle was reinforced six inches from its origin by a muscular slip a quarter of an inch in breadth; it arose at the lower part of the middle third of the os humeri, between the origin of the quadriceps extensor and the insertion of the adductors joining the sartorius opposite the knee joint.—J. I. Redfield, on *Rochelia patens* (Nuttall), decided by Dr. Gray to be *Echinosperrnum floribundum*.—Report on plants introduced by means of the International Exhibition 1876.

*Bulletins de la Société d'Anthropologie de Paris*, tome 3, fasc. 1, 1880.—The present number contains the address of M. Sanson, president of the Society for 1880.—A communication from M. Fantegazza, on the Lapps.—A paper by M. Emile Goldi, on the migration of races in Egypt, which gave rise to an animated discussion, in which Mad. C. Royer opposed the author's view of the Asiatic origin of the Egyptian races.—M. Topinard proposed new methods for obtaining means differing from those suggested by M. Broca, which he considers to be based upon too small numbers.—M. Robin, Inspector of Primary Instruction in the Département de Loir-et-Cher, invites the attention of the Society to the question whether it would not be desirable, to require from teachers in the public schools reports of the stature, growth, &c., of the pupils under their observation. M. Broca was of opinion that anthropological characteristics are of little value except in the case of adults, and that the important question of growth can only be satisfactorily considered when large numbers of children are simultaneously submitted to observation.—This number of the *Bulletins* devotes nearly seventy pages to the reprint of the "Inventory of the Megalithic Monuments of France," in which we have the combined result of the carefully-conducted observations of the General Commission for the registration of these remains, which was formally appointed by the Minister for Public Instruction in November, 1879. In this survey the country was divided into six sections, each of which was placed under the direction of one of the commissioners, while the general work was further subdivided into two groups, those of erratic boulders and megalithic monuments.—The last paper, by M. Paul Broca (on a new instrument invented by himself, and named "le goniomètre d'inclinaison et l'orthogone"), has a specially melancholy interest from the fact that it is connected with some of the latest work done by this eminent savant before his death.

*Journal of the Franklin Institute*, July.—The belt-dynamo-meter of Dr. C. W. Siemens, by R. Briggs.—High railway speeds, by W. B. Le Van.—Economic vaporisation of a boiler, by Chief Engineer Isherwood.—Progress of the dephosphorisation of iron, by F. Gautier.—The involute of the circumference of a circle, by L. D'Auria.—A new pendulum suspension, by L. H. Speller.—The puddling process, past and present, by P. Roberts, jun.

*Bulletin de l'Académie Royale des Sciences (of Belgium)*, No. 5.—On a whale caught on the coast of Charleston (South Carolina) on January 7, 1880, by M. Van Beneden.—An application of accidental images, by M. Plateau.—Note on the illumination of mines with phosphorescent sulphides, by M. Montigny.—Researches on the property possessed by solid bodies

of welding by the action of pressure, by M. Spring.—On the line of (so called) helium, by Abbé Spée.—Excretory apparatus of the Trematodes and Cestoides, by M. Fraipont.—Discovery of hæmoglobin in the aquiferous system of an Echinoderm, by M. Foeltinger.

## SOCIETIES AND ACADEMIES

EDINBURGH

Royal Society, June 21.—Prof. MacLagan, M.D., vice-president, in the chair.—Prof. Chrystal read a paper on a differential telephone, and on the application of the telephone to electrical measurements. A differential telephone was exhibited. It differed from an ordinary telephone in much the same way that a differential galvanometer differs from an ordinary single-coiled one. Two thin wires were twisted together and wound round the magnet in the usual way. It was shown that when an interrupted current passed in opposite directions through the two coils of the differential telephone no sound was heard. In using the instrument, its two coils were put into the two branches of a multiple arc, which was inserted in the circuit of the interrupted current. The interrupted currents of the two branches passed in opposite directions through the coils. The conditions for perfect compensation were not only that the resistances of the two branches must be equal, but also that their co-efficients of self-induction must be the same. If only one of these conditions was fulfilled a minimum of sound could be got, but absolute silence was impossible. The necessity for this twofold adjustment had not been hitherto sufficiently recognised; and it was to its neglect that the main difficulties in using Hughes' induction-balance were no doubt to be referred. Some years ago Prof. Chrystal had worked out the mathematics of the subject, but had been unable till recently to corroborate his results by experiment. Prof. Chrystal then proceeded to indicate how such a differential telephone could be applied to the measurement of coefficients of self-induction in terms of an arbitrary unit. Two coils were prepared of exactly the same resistance, but one was so wound as to have practically no self-induction. The self-induction of the other was the arbitrary unit mentioned above. In the rough model shown, two coils, whose distance apart could be varied at will, were introduced into each branch of the multiple arc above referred to, and were first adjusted so as to produce perfect compensation in the differential telephone. The other two equal resistance-coils were then introduced, one into the circuit of each induction pair, with the necessary effect of destroying the compensation. By a readjustment of the induction of one of the pairs, compensation was again secured, the change of distance of the coils of the altered pair corresponding therefore to the arbitrary unit. The two single coils were then removed, a fresh compensation obtained by alteration of the other induction pair, the single coils again introduced, a fourth compensation effected and a second stage reached in the formation of a graduated scale of self-induction in terms of an arbitrary unit; and so on till a complete scale was formed. Prof. Chrystal further pointed out how his instrument might be used for measuring capacities, and for investigating the real nature of the opposition offered by electrolytes to the passage of electric currents.—Prof. Tait communicated a paper on the determination of the specific heats of saline solutions, by Mr. Thomas Gray, B.Sc.—Mr. J. Y. Buchanan described a "navigational sounding-machine" of very simple construction. A glass tube, closed below by a plug kept sufficiently tight by a close-fitting india-rubber band, was provided above with a peculiarly-formed capillary orifice. The tube was first allowed to fill with air, and then sunk to the required depth in the sea. The air was compressed under the increased pressure, and the water began to trickle in from above. The quantity of water which so gained admittance was the datum from which the pressure, and therefore the depth, could be calculated. The water was removed by taking away the bottom plug; and the instrument was once more in a state suitable for use. Mr. Buchanan also communicated some experiments on the compressibility of glass. The value he obtained was greater than that obtained by Grassi by 2½ per cent.—Dr. Macfarlane read a short paper entitled "Suggestions on the Art of Signalling." He advocated the use of three qualities or symbols in preference to the dot-and-dash or two-symbolled alphabet of Morse, arguing that such a system would be found more rapid than the latter.—Dr. R. M. Ferguson communicated a note on the wire telephone, following

up the results obtained formerly by himself and those more recently arrived at by Preece and Chrystal. He showed that the sound emitted by a stretched iron wire through which an interrupted current was passing varied in a remarkable way with temperature, reaching a most evident maximum about a dull red heat. This variation he regarded as being in some way connected with the magnetic properties of iron, and on that ground criticised Prof. Chrystal's explanation of the De la Rive phenomenon as being due to rapid contractions and dilatations of the thin wires through which the current passed. In the remarks which followed Prof. Chrystal admitted the influence of magnetism in the case of the iron, a thick wire of which was as efficient as a thin wire; but in the case of what are usually reckoned non-magnetic metals, only thin wires of which are efficient for reproducing continuous sounds, he still thought that the true explanation was to be found in their changes of length. The altogether peculiar action of iron—though probably nickel and cobalt would have a similar action—seemed to him rather to favour this view than the other.

BOSTON, U.S.A.

**American Academy of Arts and Sciences, June 9.**—Prof. Joseph Lovering, vice-president, in the chair.—Dr. A. Auwers of Berlin, and Prof. Descloizeaux of Paris, were elected Foreign Honorary Members.—The Rumford medal was conferred on Prof. Josiah Millard Gibbs for his researches in thermodynamics.—The Hon. Charles Francis Adams resigned the office of president of the Academy, and Prof. Joseph Lovering was elected to the chair.—Dr. Oliver Wendell Holmes was chosen vice-president, Prof. Josiah P. Cooke corresponding secretary, and Prof. John Frowbridge recording secretary.

PARIS

**Academy of Sciences, July 26.**—M. Edm. Becquerel in the chair.—In name of a committee lately formed, M. de Quatrefages asked the Academy to open a subscription with the view of striking a medal in honour of M. Milne-Edwards' services to science. Agreed.—Apparatus for measuring the heat of combustion of gases by detonation, by M. Berthelot. It consists essentially of a bomb suspended in a calorimeter.—On the dissolution of chlorine in water, by M. Berthelot. His observations point to the existence of a perchloride of hydrogen, probably a trichloride.—On the theory of the sines of superior orders, by M. Villarceau.—On the same, by M. Farkas.—Substances addressed to the Museum mistakenly as meteorites, by M. Daubrée. Most frequently they are scoræ from works, and pyrites; but iron ores and a variety of substances are sent, and the senders are often men of scientific note. Bolides are often thought to fall near, while really far away.—On the successive transformations of the photographic image by prolongation of the luminous action, by M. Janssen. Beyond the second neutral state he gets a second negative image (requiring a million times the luminous intensity for the first), and a third neutral state, with uniform dark tint.—Report on the project contained in documents deposited by M. de Lesseps for the interoceanic canal. This reviews the past history of the question.—Report on a memoir by Dr. Compagno, entitled "Project of Organisation of the Service of Health of the Panama Interoceanic Canal," by M. Larrey.—M. Boutigny described some new experiments on the spheroidal state.—On the transformation of linear differential equations, by M. Appell.—On a property of algebraic functions and curves, by M. Piccard.—On the causes of interior alteration of steam boilers, by M. Lodin. From experiments with iron wire in sealed tubes holding various waters, he finds the predominant cause of oxidation to be the oxygen of dissolved air, and that this is not more intense in the case of distilled water than of calcareous, but the opposite. The action of some disinfectants is studied.—On a method of direct autocollimation of objectives and its application to measurement of indices of refraction of the glasses composing them, by M. Martin.—On the employment of the spherometer, by the same. He has improved it in certain points.—On the causes of terrestrial magnetism, by M. Lemström. He magnetises a vertically-suspended bar of soft iron, by rapid rotation of a paper tube, with two concentric walls round it. The earth he supposes similarly magnetised by rotating in a space of ether.—On an electrodynamic paradox, by M. Gérard-Lesquer. When the current of a dynamo-electric machine (Siemens) is sent into a magneto-electric machine (Gramme), the latter moves with increasing

speed; then it slackens, stops, and turns in the opposite direction; this action is reversed in turn, and so on. The polarities of the inductors are reversed.—Researches on the formation of M. Hautefeuille and Chappuis. The tension of ozone in oxygen under the silent discharge increases rapidly with fall of temperature. In passing from production of ozone. On a new isomeric modification of hydrogen by M. Tommasi.—Observations on M. Bour Petrieff.—On the ultimate action of bromine on malonic acid, and their sulphates, the molecular heat and volume of rare earths fermentation of glucose, by MM. Nilson and Petersson.—On a fermentation in a glucose, by M. Boutroux. What he called "Absorption and elution on March 4, 1878, he now calls *glucose* Yung. Absorption and elimination of poisons in cephalopoda, by (very weakly by the gills) place most promptly by the brachial substances, Elimination, and according to osmotic power liquid.—Velocity of transmission is by the liver and the sac of nerves of the lobster, by MM. Issigonis of the motor excitation about 6m. per sec. at + 10° C., Fredericq and Vandevelde. + 18° to + 20°.—On the difference, + 12° C., and 10 to 12 small luminous surfaces, by M. Chantrel. Sensibility of the eye to light is greatly increased. Contributions to paleontology of distinguishing—The Loire, the Loiret, and subterranean Cretaceous flora, by M. de Orleans, by M. Sainjon.—On the bed currents of the V. Ilassi (Algerian Sahara), by M. Rolland.—On cut flints as obtaining photographic negatives in a free bath, the meat Desmarts. In a recent ascent he used an obturator, for like Janssen's.

GÖTTINGEN

**Royal Society of Sciences, April 7.**—On the conditions of integrals, by H. O. Lang.—On the extension of Abel's theory to integrals of any differential equations, by L. Koenigsberger. May 1.—Notices on some Australian volatile oils, by Baron von Müller.—Analysis of electric discharges, by W. Holtz.—Improved centrifugal machine for charges, by the same. June 5.—On three-point contact of curves, by H. Schubert. On those algebraic equations between two variable quantities which allow a number of rational univocal reversible transformations into themselves, by G. Hettner. July 3.—Voltaic element of aluminium, by F. Wöhler.—The functions which arise by inversion of solutions of linear differential equations, by L. Fuchs.—On algebraic logarithmic integrals of non-homogeneous linear differential equations, by Koenigsberger.—On a new arrangement of the magnets of galvanometer, by K. Schering.

CONTENTS

MULTIPLE SPECTRA, II. By J. NORMAN LOCKYER, F.R.S. (With Illustrations) . . . . .	1
THE EDUCATION DEBATE . . . . .	2
EUROPEAN CADDIS-FLIES . . . . .	3
OUR BOOK SHELF:—	
Harvie-Brown's "Ornithological Journal of the Winter of 1878-79" . . . . .	3
Netto's "Mining and Mines in Japan" . . . . .	3
Sawyer's "Automatic Multiplier," and "Automatic Calculator" . . . . .	3
LETTERS TO THE EDITOR:—	
The Freshwater Medusa.—Prof. E. RAY LANKESTER, F.R.S. . . . .	3
Subterranean Kaolinisation.—JOHN A. CHURCH . . . . .	3
"On a Mode of Explaining the Transverse Vibrations of Light."—J. W. FRANKLAND . . . . .	3
Expansion of Glass by Heat.—Prof. JOHN LECONTE . . . . .	3
Fascination in Man.—Surgeon-Major W. CURRAM . . . . .	3
Monkeys in the West Indies.—EDMUND WATT . . . . .	3
Utricularia.—Lieut. J. W. CLARK . . . . .	3
The British Association and Provincial Scientific Societies.—JOHN HOPKINSON . . . . .	3
Intellect in Brutes.—REV. GEORGE HENSLAW . . . . .	3
Chipped Flints.—J. BIRMINGHAM . . . . .	3
Lunar Rainbows.—J. KING WATTS . . . . .	3
CARBON AND CARBON-COMPOUNDS. By Prof. A. S. HERSCHEL . . . . .	3
PHYSICS WITHOUT APPARATUS, I. (With Illustrations) . . . . .	3
COUNT FORTALES. By H. N. MOSELEY, F.R.S. . . . .	3
THE BRITISH ASSOCIATION AT SWANSEA . . . . .	3
THE HIGH PLATEAUX OF UTAH. By Prof. ARCH. GEIKIE, F.R.S. . . . .	3
THE NEW PLANETARY NEBULÆ. By EDWARD C. PICKERING . . . . .	3
NOTES . . . . .	3
ON CURRENTS PRODUCED BY FRICTION BETWEEN CONDUCTING SUBSTANCES, AND ON A NEW FORM OF TELEPHONE RECEIVER. By JAMES BLYTH, M.A., F.R.S.E. . . . .	3
UNIVERSITY AND EDUCATIONAL INTELLIGENCE . . . . .	3
SCIENTIFIC SERIALS . . . . .	3
SOCIETIES AND ACADEMIES . . . . .	3



THURSDAY, AUGUST, 12, 1880

## ANCIENT GEOGRAPHY

*A History of Ancient Geography among the Greeks and Romans from the Earliest Ages till the Fall of the Roman Empire.* By E. H. Bunbury, F.R.G.S. With Twenty Illustrative Maps. Two Vols. (London: John Murray, 1879.)

THIS is one of that class of monumental and scholarly works which have almost died out in these days of multitudinous magazines and rapid publication, when authors have not patience to wait the completion of a work before they begin to publish. Mr. Bunbury's work is the work of a lifetime, and he well deserves the laurels bestowed upon him by the Geographical Society. It is both scholarly and scientific, the product of patient, wide, and thorough research, and treats a complicated subject with such completeness, clearness, and sound sense, that it is difficult to see how it can be supplemented or superseded. Much has been written on the subject of ancient, and especially classical geography, in Germany and France, and with all that has been written Mr. Bunbury is evidently familiar; his work, however, is in some respects superior to anything that has preceded it. His method is thoroughly scientific; he wastes but little space in endeavouring to extract a grain of sound geography from a bushel of legendary chaff, as so many of his pedantic predecessors have done. He weighs his evidence with rigid impartiality, is never content with second-hand authorities when the originals are attainable, and accepts no conclusions of previous writers unless led thereto by his own researches. He is thus compelled to reject much that has been hitherto accepted by those who have written on the subject.

Mr. Bunbury's book is no light reading. To do it justice requires long and patient study, and to review it fully and fairly would require the scope of a Quarterly. Every page bristles with learned notes, which cannot be read over except at the risk of losing some important part in his well-knit narrative and close argument. Besides the foot-notes there are appendages of larger size to each chapter, in which disputed questions are discussed, and the scattered fruits of long research brought together. As the work is a History of Geography among the Greeks and Romans, the geographical knowledge of Egyptians, Jews, and Phœnicians is discussed in a brief introduction. We should like to see Mr. Bunbury treat the geography of these two last interesting peoples in the same thorough manner as he has done that of the Greeks and Romans, and free it from the accretions of conjecture and fable that have encrusted it. It would be a matter of great interest if scholars as diligent as Mr. Bunbury has shown himself to be in his department would bring together for us in any compact and accessible form all that is known of the knowledge of geography possessed by all the old peoples who have left a literature. The Chinese especially, who believe, had a much more extensive knowledge of the geography, not only of Continental Asia, but of the Asiatic Archipelago, than any but a few special scholars have

an idea of. It is a pity also that our Celtic and Teutonic forefathers had no permanent means of recording the tale of their wanderings westwards from their Asiatic fatherland; but surely the experiences they met with during these wanderings have left some impressions upon their extensive folk-lore. Still the first beginnings of solid geographical knowledge and theory rest with the Greeks and Romans, and even in a complete History of Ancient Geography everything must be made to centre in them.

Of course Mr. Bunbury in carrying out his weighty task is compelled to speak of the knowledge which those two peoples were likely to acquire from the nations with whom they came into contact, the Egyptians, the Carthaginians, the Persians, and the Indians. His discussion of the extent of the ancient Egyptian knowledge of the Nile and of the African interior is broad and interesting, and he shows a healthy scepticism as to the extent of the wanderings of the Phœnicians. This wholesome scepticism is a praiseworthy characteristic of his work throughout, from the *Voyage of the Argonauts* down to the *Irish Annals*. The Argonautic legend he dismisses as of really no geographical importance, but devotes considerable space to the geography of the *Iliad* and *Odyssey*. This he reduces to a very narrow compass of certainty, and dismisses as trivial the laboured attempts to identify the many names of places introduced into the *Odyssean* legend. Indeed the first certain knowledge of any countries beyond their own immediate shores came to the Greeks through the numerous colonies they founded, and even this scarcely extended beyond the environs of the settlements. The Greeks were doubtless enterprising enough in certain directions, but as a people they seem not to have been much given to exploration for its own sake. The knowledge of the regions beyond the confines of the Greek colonies on the Mediterranean and Euxine was for the most part extremely vague, consisting mainly of a multitude of names of tribes exceedingly difficult now to identify. They had for centuries the vaguest and most erroneous notions of the great physical features of Europe, Asia, and Africa, beyond the immediate neighbourhood of the shores of these continents; though by the time of Hecataeus of Miletus (520-500 B.C.) a wonderful amount of information had been accumulated in an unsystematic way. This knowledge had greatly increased and become more definite and accurate by the time of Herodotus in the next century. Mr. Bunbury's treatment of this large-minded and cautious historian is especially full and satisfactory, and betokens a vast amount of original research and full and accurate knowledge of the geography of the countries concerned. He clears away many erroneous opinions attributed to Herodotus, clearly proving by reference to the original that many statements attributed to Herodotus himself are really given by him as only second-hand reports to be received with caution. We all know how poor Livingstone met his death in a Quixotic search for the fountains in which the Nile was supposed to have its origin, an idea he attributed to Herodotus; but Mr. Bunbury shows clearly that the cautious historian held no such opinion himself, but merely related it as an incredulous story he had heard when in Egypt. With regard to the famous story of the circumnavigation of Africa by Necho, related by

Herodotus, Mr. Bunbury thinks it extremely improbable, but that it cannot be disproved.

Neither Greeks nor Romans, as we have said, troubled themselves much about exploration for its own sake; their geographical knowledge, which after the time of Herodotus accumulated at an increasing ratio, came to them mostly through their military expeditions. The wars of Alexander made vast additions to this knowledge, for he, like Cæsar, fond as he was of military glory, seems to have had a real love of acquiring a knowledge of new lands and peoples. Alexander brought within the sphere of fairly exact knowledge much of Western, Central, and Southern Asia, and the coast voyage, under his orders, of Nearchus from the Indus to the Persian Gulf is a landmark in ancient geography. Cæsar did for about one-half of Europe what Alexander did for Asia, and the merits of the former as an accurate observer are done ample justice to. The extension of the Roman Empire, begun under Cæsar, was continued by his successors, and how vast had been the strides in geographical knowledge during that period is shown by the careful and full examinations by Mr. Bunbury of the works of Strabo, Pliny, and Ptolemy.

Of the few genuine exploring expeditions of the ancient world Mr. Bunbury writes at length and with his usual caution and attention to accuracy and detail. The famous voyage of Hanno the Carthaginian, for example, along the west coast of Africa, about the end of the sixth or early part of the fifth century B.C., is done ample justice to, so far as the meagre records admit. This enterprise, when we consider the state of knowledge at the time and the means at the command of the leader, deserves all the praise that has been bestowed upon it. In a single voyage this daring navigator accomplished what the Portuguese of the fifteenth and sixteenth centuries took years to do. Mr. Bunbury is, we think, unusually successful in identifying most of the points named and clearing up the apparent difficulties in the brief existing account of this voyage that has come down to us; and there is no doubt that Hanno succeeded in reaching as far south as Sherboro, on the Sierra Leone coast, something like six degrees from the equator. Yet his example does not seem to have stimulated any one to complete his work. Pytheas is another well-known name in the history of ancient geography, and a name that should have a special interest for us, as he was the discoverer of Britain to the cultured nations of the period. (It is rather strange, by the by, that no enthusiastic geographer has ever suggested the appropriateness of erecting a monument to the venturesome Massilian.) Mr. Bunbury rightly defends Pytheas from the attacks that have been made upon his veracity, and, as in the case of Herodotus, carefully distinguishes between what he states as the results of his own experience and the information he gives from the reports of others. It is not probable that he ever left the mainland of Scotland. Mr. Bunbury thinks it extremely difficult to identify the "Thule" of Pytheas, "six days voyage to the north of Britain;" he distinctly states that it belonged to the British group, which would certainly seem to exclude Iceland. Pytheas is well entitled to be considered a scientific observer; he added greatly to the knowledge which the Greeks had of tidal phenomena, and as might be expected was greatly

struck with the astronomical phenomena of northern latitudes. Pytheas, moreover, as we know, set up a gnomon at his native town of Massilia, and thus determined the latitude of that place with a wonderful approach to accuracy.

Mr. Bunbury by no means devotes all his space to a record of the gradual extension of a knowledge of the earth's surface among the Greeks and Romans; he gives due attention to what is known as scientific geography, to the attempts of philosophers to discover the form and extent of the earth. At a comparatively early period it was conjectured that the shape of the earth must be spherical; by the time of Aristotle indeed it had become a generally received tenet among philosophers. Mr. Bunbury, however, considers Eratosthenes (born B.C. 276) the famous Alexandrine librarian, as the true parent of scientific geography; Strabo tells us that he made it the object of his special attention to "reform the map of the world" as it had existed down to his time, and to reconstruct it upon more scientific principles. "The materials at his command," Mr. Bunbury continues, "were still very imperfect, and the means of scientific observation were wanting to a degree which we can, at the present day scarcely figure to ourselves; but the methods which he pursued were of a strictly scientific character, and his judgment was so sound that he proved in many instances to be better informed and more judicious in his references than geographers of two centuries later." Eratosthenes set himself to make a careful measure of the magnitude of the earth; his method was thoroughly scientific, though the data he had to start with were, as might be expected by no means accurate. Under the circumstances the approximation he made to the measure of the earth's circumference was really wonderful. Mr. Bunbury's discussion of the method and results of Eratosthenes shows that he has mastered the scientific side of his subject as well as the historical; it is a fine example of careful and close reasoning. For an account of the work of Eratosthenes and other ancients in this direction we refer the reader to the series of articles on the Figure of the Earth in NATURE, vol. xviii. p. 356 *et seq.*

After all, even in the time of Ptolemy, the map of the world, after something like 800 years work, was of comparatively limited extent. Anything like accurate knowledge did not extend beyond Central and Southern Europe, Western and South-western Asia on the one side, and a small stretch of North Africa on the other. True a vague knowledge was on record of regions far beyond this, a knowledge however which had a vast amount of error mixed with a small modicum of truth. Still when we consider the limited means at the command of the Greeks and Romans, and that they had to overcome all the initial difficulties of the pursuit of knowledge the results which they achieved are creditable to their enterprise.

Mr. Bunbury's history of these first beginnings of geographical exploration and geographical science is well worth a careful study, and will gain for him a high and permanent position in the literature of geography. No the least valuable feature, we should say, are the numerous map illustrations of the progress of geographical knowledge at various periods.

## THE MENHADEN

*The Menhaden; being a History of the Fish.* By G. Brown Goode. *With an Account of the Agricultural Uses of Fish.* By W. O. Atwater. (New York: Orange Judd Company, 1880.)

IN money value the American menhaden ranks fourth in the list of the fishes of the United States. First comes the cod, secondly the salmon, thirdly the mackerel, and then the menhaden. In absolute pounds' weight caught it would seem to come first of all, upwards of 460 millions of pounds' weight having been taken in 1876, whereas there was considerably less than half this weight of cod taken in that year, and all the salmon and mackerel taken if weighed together would not amount to much more than one-sixth of the weight. As its money value must depend on its economic value, it may be as well at once to briefly hint at its uses. As a table fish it is in favour in many parts of the United States, when perfectly fresh being considered superior in flavour to most of the common shore fishes. In the Washington fish market, when in season, they meet with a ready sale. Large quantities are salted, and there is a great export of these to the West Indies, where they serve as food for the negroes upon the plantations. Immense numbers are preserved in oil and spices and sold as sardines. Goodale's extract of fish is made out of menhaden, and the qualities of this preparation are testified to as being agreeable in flavour and decidedly nutritive as food for cattle. Menhaden scrap is a great success; sheep get rapidly fat on it. Hens, ducks, and turkeys prefer it to corn, and it need not be added that pigs greedily devour it. For bait it is extensively used in the cod and mackerel fisheries in New England and the British Provinces. Its popularity is no doubt chiefly due to the ease with which it may be obtained in quantity. As an article of commerce menhaden bait, it will be remembered, came under the consideration of the Halifax Commission of 1877; but perhaps even a greater future is open to the menhaden fisheries by the recently-established manufacture of oil and guano from these fish. The State of Maine claims to have been the first to discover its value, and now large factories turn out immense quantities of these materials. In 1874 from 50,000 to 75,000 gallons of oil was turned out from the Maine Works. The manufacture is simple in the extreme, consisting of three processes: boiling the fish, pressing and clarifying the expressed oil. The final operation is pumping it into immense bleaching tanks, where it becomes whiter and clearer in the rays of the sun. When well refined the oil is light-coloured, sweet, and of prime quality. The uses of this oil are manifold. It is chiefly employed, we are told, as a substitute for the more costly and popular oils, and to adulterate them. It is sold largely to tanneries for currying leather. The principal market for it is in Boston and New York, but considerable quantities are shipped to London, Liverpool, and Havre. But menhaden has still further uses. So far back in American history as 1621 we read that the Plymouth colonists learnt from an old Indian that they should use these fish as manure on their ground; and one Edward Johnson, writing in 1652, says, "But the Lord is pleased to provide for them [the New England colonists] great store of fish in the spring time. Many thousands of these they used to put

under their Indian corn, which they plant in rills five foot asunder." Now as a result of the profitable utilisation of the menhaden for the manufacture of oil, the use of the whole fish as a fertiliser has gradually and almost entirely ceased, and the refuse from which the oil has been expressed is used instead. This is known as "fish-scrap" and "fish guano." In a wheat-growing country like North America the importance of the subject of artificial manures is great, and we quote from Prof. Cook's, of New Jersey, report to the State Board of Agriculture as follows: "Those who have tried a mixture of this fish guano with barn-yard manure and a little lime, say that it is superior to any guano in the market. When applied on corn the crop is considered as certain. The value of fish as manure is due mainly to the presence in it of nitrogen and phosphoric acid. The crops most assisted by fish manures are such as grass, grain, and corn, while leguminous crops, like clover, beans, and peas, are more benefited by mineral manures."

The above is but a brief *résumé* of one portion of Messrs. Goode and Atwater's interesting work, the title of which is quoted above. Their history was prepared for the Fifth Annual Report of the Commissioner of Fisheries for 1877. As reprinted, it forms an octavo volume of 540 pages and 30 plates.

The menhaden (*Clupea menhaden* of Mitchell) is, when adult, a most beautiful fish; its colour is pearly opalescent; each scale has all the beauty of a fine pearl, and the reflections from the mailed side of a fish just taken from the water are superb; the scales of the back and top of the head are of a purplish hue. Its importance to the States may be compared to the importance of the herring to Northern Europe. It is to be found at the same period during the year in the coast waters of all the Atlantic States from Maine to Florida. A surface temperature of about 51° is necessary for its appearance in waters near the shores. Its food is apparently for the most part minute algæ. The geographical range of the species, the arrival and departure of the "schools," the migration question, the peculiar movements of the "schools" of menhaden, are all subjects discussed at great length in this report, and from it many facts of great value to those interested in our own shore-fisheries are to be learnt.

The strange and unaccountable absence of the menhaden last year from the waters of Cape Cod are briefly alluded to in the Introduction. This absence was disastrous to many, and proved by a sad experience that the harvest of the sea will sometimes fail. The oil and guano factories lost a year's work; the factory hands and steamer's crew were entirely thrown out of employment; those were all on hand to begin work on June 1, and kept working, in the hope that the fish would "strike," until late in August. When they at last gave up all hope it was too late to engage in any other occupation to make money to carry them over the winter. This absence of the fish north of the Cape did not appear to be compensated for by any remarkable abundance in southern New England, but a much larger number of fish were captured in these waters in 1879, as so many more vessels went there to fish. We hope soon to hear of a good season's fishing at Cape Cod, and we strongly recommend this important report on the menhaden to the reader's notice.

## OUR BOOK SHELF

*Alphabetical Manual of Blowpipe Analysis.* By Lieut.-Col. W. A. Ross. (London: Trübner and Co., 1880.)

OF late years the blowpipe has been very little used in practical chemistry. It has been felt that efficiency in qualitative analysis is not the final aim of the chemist; and this branch of chemical art has been more and more relegated to the position of an instrument for examination purposes.

There is however little doubt that a thorough training in qualitative analysis—such a course, for instance, as is furnished by Mr. Dittmar's manual—is of much service to the learner of chemistry; but even here the methods which are of most general application are founded on reactions "in the wet way."

The blowpipe, however, is beginning to reassert its claims to the favourable recognition of the chemical mineralogist. The little book in which Col. Ross condenses the results of his own and others' work is well calculated to advance these claims.

No regular course of analysis is given in this book beyond an outline of a method for classifying minerals for blowpipe examination, and an account of the Freiberg scheme of qualitative analysis of minerals. But under such headings as "Alloys," "Minerals," "Phosphoric Acid Reagent," &c., most useful information is presented to the worker in tabulated form. The table of "Reactions of ordinary Oxides at one View" is also useful.

Any mineralogist who has acquired some command of the blowpipe and has a fair elementary knowledge of chemistry must find this work of service to him; it contains in a small compass almost all that is required to be known in order to study the composition of minerals by "pyrological" reactions. Very many of the reactions described by Col. Ross are not to be found in other books. Not a few of his statements are opposed to generally-accepted facts. He gives a flat contradiction to the statement made in the text-books, that most metallic oxides are soluble in boric acid, or boron trioxide, at a red heat, whilst of course admitting their solubility in fusing borax; indeed he bases his system of blowpipe examination, or pyrology, to a large extent, on the non-solubility of metallic oxides in this reagent.

As is often the case with one who has undoubtedly advanced any branch of scientific work, Col. Ross is too ready to value his favourite method more highly than it deserves. Thus he is inclined to regard the blowpipe as "a more delicate analytical weapon than the spectro-scope," and thinks that by its use he has proved that the production of D-lines is not always due to sodium!

*U.S. Coast and Geodetic Survey. Pacific Coast Pilot. Coasts and Islands of Alaska. Appendix I. Meteorology and Bibliography.* By W. H. Dall. (Washington, 1879.)

THE complicated title of this large quarto volume gives very little idea of the nature and value of its contents. In the first sentence of the Letter of Transmission we meet with a new and amusing use of an old enough English phrase, when Mr. Dall coolly informs the superintendent of the Survey that he has "the honour to turn in the results of an inquiry into the meteorology of Alaska and the adjacent regions." The results of which Mr. Dall speaks in this irreverent manner must have cost him stupendous labour; indeed they might very well have taken years of research by a small international staff of inquirers. The publication comprises an abstract or summary of all accessible meteorological material relating to the district in question; both of that which has been published and is widely scattered through numerous proceedings, annuals, and transactions of learned societies, buried in periodicals in the Russian and other languages, and otherwise difficult of access; and also of a very large amount of

unpublished material from the archives of the U.S. Coast Survey, the Medical Department of the U.S. Army, the U.S. Signal Service, and numerous contributions from private sources. With the abstracts are included the fullest references to the sources from which the materials are derived, and all the data which could be obtained as to the conditions of observation. The list of charts, maps, and publications relating to Alaska and the neighbouring regions, and occupying something like 200 quarto pages, is a wonderful piece of well-arranged work, and must prove valuable for many purposes besides that for which it has been immediately compiled. The volume also contains charts representing the monthly and annual means of temperature and pressure, graphic figures of the direction of the winds at each locality, and of the annual curves of pressure, precipitation, and temperature. Mr. Dall probably knows more about the region to which this volume refers than any other man living, and is able from his own observations and experience to contribute greatly to the value of his report. Altogether this is one of the most creditable of the many creditable scientific publications of the United States, and Mr. Dall is evidently one of the most valuable scientific servants of that Government. We hope, both for the good of the States and the interests of science, that he will be afforded every facility for utilising his exceptional ability as a scientific observer.

*The Tree Planter.* By Samuel Wood, Author of "Good Gardening."

*The Tree Pruner.* By the same Author. (London: Crosby Lockwood and Co., 1880.)

THESE two books form Nos. 209 and 210 of Weale's Rudimentary Series. Considering the numerous books Mr. Wood has written, the titles of which are set forth on the first pages of the little volumes before us, it is clear the author is suffering from a continued attack of *Cacoëthes scribendi*. Agreeing with the author, for the sake of argument, that there was a real necessity for the information he desires to impart, we cannot see why the matter contained in the two books should not have been combined in one, for the subjects of propagation and pruning are so closely associated that they would have gone better together rather than being separated; besides which a good deal of useless repetition would have been saved. Writing in the first book of what the author calls plants of the "Hibiscus Class—the *Athæa frutex*," he says they are "deciduous shrubs of great beauty, comparable to carnations on trees." In the second book, under the head of "The Hibiscus," it is said—"These plants are among our most beautiful flowering shrubs; many of them will compare with the carnation." As an illustration of the author's method of imparting botanical knowledge, we will quote only two paragraphs from the article on the holly. He says—"There are a great many varieties of the holly, and nearly all of them are natives of Great Britain. There is also one commonly called *knee holly*, which is not a holly at all. The holly belongs to the natural order *Aquifoliaceæ*, while the *knee holly*, or *Ruscus aculeatus*, belongs to the natural order *Liliaceæ*, i.e., flowers resembling a diminutive lily, while the flowers of the former belong to a class quite different, Linn. class 4, and order 3, the latter having 6 stamens and 1 style.

"*Aquifoliaceæ* conveys no idea of the class, but simply refers to the plant belonging to those with prickly leaves. This being the case, I am disposed to look upon the term '*Aquifoliaceæ*' as misleading, because there are some other genera possessing prickly leaves, and some hollies that have leaves with no prickles, and in the case of the *Ruscus*, which has prickly leaves, it may be and is called a holly, while it is of another genus." It is impossible to comment on this. The author may be practical, but he is not scientific.

*Tables for the Analysis of a Simple Salt.* By A. Vinter, M.A. (London: Longmans and Co., 1880).

MANY tables for the qualitative analysis of simple salts already exist; another set is just added to the list by Mr. A. Vinter. It is very probable that students who—like those for whom Mr. Vinter's tables are arranged—can only devote one hour a week to practical chemistry, would do well to add that hour to those allotted to some other study; but if school-teachers will give their boys so insignificant a smattering of practical chemistry, these tables will, we think, be found useful and generally accurate so far as they go, which is certainly but a very little way indeed.

#### LETTERS TO THE EDITOR

[The Editor does not hold himself responsible for opinions expressed by his correspondents. Neither can he undertake to return, or to correspond with the writers of, rejected manuscripts. No notice is taken of anonymous communications.]

[The Editor urgently requests correspondents to keep their letters as short as possible. The pressure on his space is so great that it is impossible otherwise to ensure the appearance even of communications containing interesting and novel facts.]

The late Count L. F. de Pourtales

EVERY naturalist must have noticed with regret the news of the death of M. de Pourtales, of Cambridge, Mass., U.S., but those who have had the pleasure of his friendship and who have been fellow-labourers with him feel a most sincere sorrow at the loss which science has sustained.

The exploration of the deep sea brought Pourtales prominently before the scientific world, and his practical knowledge of the art of dredging not only produced results which were of great importance to Alexander Agassiz and Lyman, but they also provided him with a wonderful series of deep-sea corals, upon which he laboured with great success. The floor of the Gulf Stream in the Straits of Florida, the dredgings of the *Hassler* Expedition, and lastly, the examination of the results of the work done in the Caribbean Sea during the voyage of the U.S. steamer *Blake*, gave the opportunity, which was readily seized and utilised, of contributing largely and thoroughly to the knowledge of the interesting Madreporarian fauna of the depths. I can testify to the solid merit of the work done by my friend, and I can never forget his generous assistance, kindly criticisms, and desire to obtain the perfect truth. He spared no pains, and was ever at work in the difficult subject he especially chose; and he speedily grasped the relations of the past and present deep-sea coral faunas, and, besides adding largely to our knowledge of forms, contributed in a most important manner to the study of the generic and specific value of certain structures. Of his knowledge of the Crinoidea I need not write, but of the great value of the researches of the grave, courteous, and most genial man who is no longer amongst us I shall ever speak in terms of great admiration and gratitude.

Athenæum, August 8

P. MARTIN DUNCAN

#### The Recent Gas Explosion

ACCORDING to promise, I write to describe the continuation of the experiments on the above subject.

At present there is little else than failure to report, but as I am leaving home to-day and shall not be able to try any additional experiments for the next three or four weeks, I will merely mention the results obtained.

A piece of composition gas-pipe 10m. long, 15mm. internal diameter, and 2 mm. thick, was filled with a mixture of 2 vols. of hydrogen to 1 vol. of oxygen, and the gas exploded. The tube was not affected, the cork which closed it being projected.

It was then filled with a mixture of 10 volumes of coal-gas and 12 of oxygen, and in this case the tube withstood the explosion; a piece of india-rubber tube covered with calico tightly bound round it, which was used to connect the farther end of the tube to a metal stopcock, was however burst and the calico torn.

To-day I tried a tube made of paper. The tube is 7 mm. in diameter, and consists of eight layers of thin paper, stuck together with paste, and varnished on the outside with shellac.

This I have not succeeded in bursting with the mixture of hydrogen and oxygen; one of the caoutchouc stoppers which closed the glass tubes cemented to the end of the paper tube was blown off.

I hope to repeat the experiment with another paper tube which is not so strong.

HERBERT MCLEOD

Cooper's Hill, August 9

#### Heat of the Comstock Lode

IN May, 1878, Mr. Church, who was at that time Professor of Mining at the University of Ohio, read a paper before the American Institute of Mining Engineers on the heat of the Comstock mines, which was subsequently, in an extended form, included in the author's volume on the Comstock lode, of which a review appeared in NATURE (vol. xxi. p. 511).

In this paper Mr. Church states that the temperature of the waters issuing from the mines worked upon the Comstock lode has always been somewhat high, but it was not until they had attained a very considerable depth below the surface that the workmen first became inconvenienced by extraordinary heat. At their present greatest depth (about 2,700 feet) water issues from the rock at a temperature of 157° F. (70° C.), and at least 4,200,000 tons of water are annually pumped from the workings at a temperature of 135° F. Mr. Church estimates that to elevate such a large volume of water from the mean temperature of the atmosphere to that which it attains in the mines would require 47,700 tons of coal. In addition to this, he calculates, 7,859 tons of coal would be required to supply the heat absorbed by the air passing along the various shafts and galleries through which it is diverted for the purposes of ventilation. It follows that to develop the total amount of heat necessary to raise the water and air circulating in these mines from the mean temperature of the atmosphere to that which they respectively attain, 55,560 tons of coal, or 97,700 cords of firewood would be annually required.

Mr. Church, in his paper, quotes four analyses of waters from the Comstock lode taken at different depths; these vary somewhat as to the relative proportions of the various substances present, but they contain on an average 42.62 grains of solid matter to the gallon. Of this amount 20.74 grains are calcic sulphate, 12.13 grains carbonate of potassium, 4.85 grains carbonate of sodium, and .66 grain of chloride of sodium.

In order to ascertain approximately to what extent the production of the large amount of heat absorbed by the water may be ascribed to oxidation of sulphur and iron, the author first calculates the quantity which would be developed by the oxidation of pyrites equivalent to the calcic sulphate in solution. But having found that this amounts to only about  $\frac{1}{10}$ th part of that required, he seeks another solution for the difficulty, and without any calculations in support of the hypothesis, attributes this enormous development of heat to the kaolinisation of felspar in the subjacent rocks.

In a communication to the Geological Society of London, published in their *Quarterly Journal*, August 1879, entitled, "A Contribution to the History of Mineral Veins," I endeavoured to show that the kaolinisation of felspars is as inadequate to produce the effects observed as is the oxidation of pyrites, and a recent paper read by Mr. Church before the American Institute of Mining Engineers, as well as his letter on Subterranean Kaolinisation in last week's NATURE, have been written with a view of answering these objections.

In my communication to the Geological Society I applied to the kaolinisation of felspars a similar line of reasoning to that adopted by Mr. Church with regard to the oxidation of pyrites.

The average proportion of alkalies contained in the rocks of the district is 6.40 per cent., while the mean of the published analyses gives 11.30 grains of alkalies in the U.S. gallon of water. It follows that the 4,200,000 tons of water annually pumped out must contain 813 tons of alkalies, and that, as these are present in the rocks in the proportion of 6.40 per cent., the felspar in 12,703 tons of rock must be annually kaolinised and the alkalies removed in solution.

The amount of rock in which the felspar has been kaolinised being 12,703 tons, and the number of tons of water pumped out of the mines 4,200,000, it follows that  $\frac{4,200,000}{12,700} = 330$  is the num-

ber of tons of water heated by each ton of completely altered rock.

In order, therefore, that one ton of rock should be enabled to heat 330 tons of water only 1° Fahr., and the specific heat of these rocks be taken at 1.77, that of blast-furnace slags, it would require to be heated by the kaolinisation of its felspar to a temperature above that of molten gold. Consequently to raise the water 85°, or to a temperature of 135°, at which it issues, the

kaolinisation of the felspar in each ton of rock would require to elevate it to an extent it would be difficult to estimate.

To this Mr. Church, who derives his heat from the hydration of silicate of aluminium during the formation of kaolin, objects that the whole of the alkalis liberated by the decomposition of felspar do not become dissolved in water, and that their amount cannot consequently be taken as a measure of the quantities of that mineral which have been decomposed.

In support of this argument he states that clays from the immediate neighbourhood of the Comstock lode still contain above 4½ per cent. of alkalis, and ignores the fact that the final result of kaolinisation is the production of a hydrated silicate of aluminium free from alkalis. The clays in question must consequently be regarded as containing undecomposed felspar which cannot have contributed to any increase of temperature.

Admitting however for the sake of argument that all the felspar has been decomposed, and that three-fourths of the alkalis present have been retained by the resulting clay, the heat corresponding to the decomposition and hydration of the felspar in a ton of rock must be reduced by three-fourths. If, therefore, as before, to simplify our ideas, we regard the heat required to produce the observed effects as due to a single variation of temperature, the original temperature must have been above twenty times higher than the melting point of gold, which appears as improbable as that found on the assumption of the whole of the alkalis entering into solution.

The assumption now made, namely, that much of the kaolinisation of the felspar is accomplished by aqueous vapour which is entirely absorbed by the rock, and which does not give rise to any aqueous solutions, involves conditions of which we have no known example, and of which it is difficult to conceive the existence at such great depths below the water-level of the country.

This view of the question was not advanced by Mr. Church in his original paper of 1878, and has probably occurred to him subsequently to the publication of my observations in the *Quarterly Journal of the Geological Society* in the following year. If however the possibility of such an alteration were admitted, it certainly could not be ascribed to kaolinisation, since the removal of the alkalis in felspars is an essential factor in that transformation.

With regard to the hot spring which formerly issued from between slate rocks and an elvan dyke at Wheal Clifford Mine in Cornwall containing notable quantities of chloride of lithium and other alkaline salts, cited by Mr. Church in his recent pamphlet in support of his views with respect to kaolinisation, the effect has probably been taken for the cause. Hot water is known to be a better solvent of mineral matter than cold water, and it has been shown by Daubrèe that at high temperatures and under great pressure it is even capable of rapidly dissolving silica out of glass, and of leaving it in the form of crystallised quartz.

We have no direct evidence that the dissociation of the constituents of felspar and the subsequent hydration of the clay produced give rise to any liberation of heat. It is well known that the temperature of mines situated in granite, where kaolinisation is constantly going on, is lower than that of those worked in clay-slate, while high temperatures or thermal springs are not more frequently observed in masses of kaolinised granite than elsewhere.

The mines on the Comstock lode are situated in a highly-volcanic region of very late tertiary age, and in the almost immediate vicinity of lava-flows and boiling springs. Until, therefore, stronger evidence than that yet furnished shall have been brought forward, it is probable that the majority of geologists may continue to ascribe these phenomena to the action of volcanic agencies.

J. ARTHUR PHILLIPS

18, Fopstone Road, Kensington, S.W., August 9

#### British Museum Attendants

As you are a free lance in British Museum matters, will you not make some remarks on the attendants? They are, as a body, intelligent and desirous of learning, but no attempts seem ever to be made to instruct them in the subjects of their departments; and all the information they possess is picked up by scraps, from overhearing the remarks of their chiefs to distinguished visitors.

Many of them do what they can to teach themselves; but why should they not have some regular training, and be competent to give simple and informal description-lectures to parties who

really go for instruction? It cannot be said that it would imperil their charges by occupying their attention, when we see how a far scantier supply of care-takers completely guard South Kensington.

The object is not to get a higher paid and superior class of men, but to give them the advantages they might reasonably enjoy, and use them as rational beings. I have heard some of them deplore the way in which they are treated, "like so many watch-dogs"; the snuff-taking to keep awake; the lapses of the stouter ones into afternoon naps; the forbidden conversations, even on the objects of their care, with visitors; the reading of all the advertisements of the *Times*, for lack of better interest; all these are familiar subjects, as you will find if you once tap the flow of forbidden talk successfully.

Some attention to them might prevent such a colloquy as I once had with a flashy-looking fellow on one of the many unlabelled objects in his department. I asked, "Do you know where that squared block is from that stands on that terminal ornament?" Gallio (with a flower in his button-hole): "Which do you mean?" "That one which has another rough block standing on it." Gallio (impatiently): "Well! what about it?" "Do you know where it came from?" Gallio (with ineffable contempt): "No! indeed; I don't know where it's from. I don't know anything about it." If you should care to quote this, I can vouch for its accuracy, as I noted it at the time.

Bromley, Kent

WM. FLINDERS PETRIE

#### Quassia and Mosquitos

IN NATURE, vol. xxii. p. 11, I read a letter in which the employment of a wash made from a decoction of quassia wood was recommended as a protection from the attacks of mosquitos and other insect pests. After reading the above-named letter I sent some of the quassia to my son, who is a surveyor camping out on the prairie in Dakotah Territory, U.S.A., in a part much infested in hot weather by mosquitos. In a recent letter my son states that he has repeatedly tried the wash with quassia, but without any beneficial results, the mosquitos having attacked him even before the solution had dried on his skin.

I have suggested that he should try carbolic acid ointment, if he can procure any, as English insects do not like the carbolic odour.

Possibly the mosquitos referred to in your correspondent's letter may have been much better fed than the North American tormentors.

If any of your numerous readers could communicate some effectual protection against the attacks of these pests, it would be a great boon to those who suffer so much from them.

Manchester, August 9

J. B. DANCER

#### Fascination

A VERY simple explanation may be offered of the seemingly mysterious facts of fascination, whether in man or the lower animals. Every one knows the old and ludicrous problem requiring us to decide what would happen to a hungry donkey placed at a spot exactly equidistant from two quite equally attractive bundles of hay. In theory the creature starves, being unable to make up its mind to choose one bundle rather than the other without any reason for such choice. In practice it is generally supposed that the unsteadiness of this world's affairs would speedily destroy the equilibrium of motives and leave the donkey free to make its meal of one or other of the bundles. But in critical emergencies, such as those mentioned in Mr. Curran's letter, when shot and shell are flying rapidly towards their victims, almost instantaneous decision is necessary. The circumstances are such that movement either to the right or to the left would be equally salutary and efficacious, but for the very reason that one movement would be just as good as the other, the mind makes its fatal pause of indecision. A man standing in the path of an advancing express train, and a small bird eyed by a snake, are probably affected both in the same manner. There need be no occult influence in the eye of the basilisk, as there can be no magical power in the iron and brass of the steam-engine, to transfix and fascinate the prey. Terror may no doubt in some instances paralyse the brain and make it incapable of choosing the method of escape, which to an intellect unembarrassed and free from panic would be the one obviously worthy of choice, but in the military examples cited by Mr. Curran it would be indecent to suggest such an explanation of the facts, and needless when the simpler solution is available.

Tunbridge Wells, August 9

THOMAS R. R. STEBBING

### Strange Method of Crossing a Torrent

HAVING seen something very like, if not quite identical with, the following in the Himalayas, I am anxious to know if it is not a commoner device under similar conditions than is generally supposed everywhere. The story occurs in Gerard Boote's (Doctor of Physik) "Inland's Natural History," p. 59, and is related on the authority of "one Theophilus Buckworth, a Bishop of Dromore," in whose presence the feat was performed. His description of it runs as follows. After mentioning that the brook or river "that passeth by that town was greatly risen," he adds that "A country fellow who was travelling that way having stayed three days in hope that the water would fall, and seeing that the rain continued, grew impatient, and resolved to pass the brook whatever the danger was, but to do it with the less peril and the more steadiness he took a great heavy stone upon his shoulders, whose weight, giving him some firmness against the violence of the water, he passed the same without harm and came safe to the other side, to the wonderment of many people who had been looking on and given him up for a lost person."

Warrington

W. CURRAN

### Intellect in Brutes

NOT having seen any reference to Cowper's famous hares in any of the notices under this heading that have appeared in NATURE, I am induced to refer to them, the more so as the creature is rarely credited with much gratitude or intelligence. My information is from Tegg's edition of "The Life and Works of William Cowper," p. 633. Describing, at this place, the capers of his favourite hare named "Puss," who "would suffer me to take him up and to carry him about in my own arms," our poet adds that "he was ill three days, during which time I nursed him, kept him apart from his fellows, . . . and by constant care, &c., restored him to perfect health. No creature could be more grateful than my patient after his recovery, a sentiment which he most significantly expressed by licking my hand, first the back of it, then the palm, then every finger separately, then between all the fingers, as if anxious to leave no part of it unaltered; a ceremony which he never performed but once again upon a similar occasion. Finding him extremely tractable, I made it my custom to carry him always after breakfast into the garden. . . . I had not long habituated him to this taste of liberty before he began to be impatient for the return of the time when he might enjoy it. He would invite me to the garden by drumming upon my knee and by a look of such expression as it was not possible to misinterpret. If this rhetoric did not immediately succeed, he would take the skirt of my coat between his teeth and pull it with all his force." He "seemed to be happier in human society than when shut up with his natural companions," and if these traits do not betoken something more than instinct, it is hard to say where this ends and intellect begins.

Warrington

W. CURRAN

### Anchor-Ice

HAVING lately read with much interest several letters to NATURE on the subject of the formation of anchor- or ground-ice, I beg leave to inform your readers that it forms here every season in the Rock Island rapids of the Upper Mississippi River; any one desirous of studying its mode of formation would here have a good opportunity. Some observations of mine upon this phenomenon may be found in vol. ii. of the *Proceedings of the Davenport Academy of Natural Sciences*, p. 349.

Davenport, Iowa, U.S., July 10

R. J. FARQUHARSON

### Depraved Taste in Animals

WHILE in Australia I kept at different times several koalas—all taken young. Of these three were inordinately fond of tobacco in any form. They would chew and swallow the strong Victorian black tobacco with the greatest gusto, and one, to which I gave a foul clay pipe saturated with tobacco oil, devoured the whole of the stem. Sitting on the nape of my neck, his usual place when I was writing or reading in the evening, "Ka-koo" would frequently stretch out one hand, take the pipe from my mouth, and begin to chew it if not promptly interfered with. During the day he passed most of his time rolled up on the rafters of the roof, bush houses being devoid of a ceiling, and on hearing the clinking of glasses, which betokened the preparation of the evening glass of grog, hurried down from

his perch to receive his modest share of whisky and water. If a spoon were dipped in the raw spirit and given to him, he would take it in both his paws and lick it dry with manifest appreciation, and could only be prevented from making a raid upon every glass on the table by being tied with a handkerchief by the leg to the back of a chair. No ill effects ever followed these indulgences.

ARTHUR NICOLS

### THUNDERSTORMS<sup>1</sup>

WHEN I was asked to give this lecture I was also asked to give a short list of subjects from which your directors might select what they thought most fit. I named three. Regarded from the scientific point of view, one of them was to be considered as fully understood in principle, and requiring only additional experimental data to make it complete. This was the *Conduction of Heat in Solids*. Another was to a certain extent scientifically understood, but its theory was, and still is, in need of extended mathematical development. This was the popular scientific toy, the *Radiometer*. The third was, and remains, scarcely understood at all. Of course it was at once selected for to-night. I might have foreseen that it would be. You may well ask, then, why I am here. What can I say about a subject which I assert to be scarcely understood at all? A few years ago no qualified physicist would have ventured an opinion as to the nature of electricity. Magnetism had been (to a certain extent, at least) cleared up by an assumption that it depended on electric currents; and from Ørsted and Ampère to Faraday and Thomson, a host of brilliant experimenters and mathematicians had grouped together in mutual interdependence the various branches of electro-dynamics. But still the fundamental question remained unsolved, *What is electricity?* I remember Sir W. Thomson, eighteen years ago, saying to me, "Tell me what electricity is, and I'll tell you everything else." Well, strange as it may appear to you, I may now call upon him to fulfil his promise. And for good reason, as you shall see.

Science and Scotland have lately lost in Clerk-Maxwell one of their greatest sons. He was, however, much better known to science than to Scotland. One grand object which he kept before him through his whole scientific life was to reduce electric and magnetic phenomena to mere stresses and motions of the ethereal jelly. And there can be little doubt that he has securely laid the foundation of an electric theory—like the undulatory theory of light admirably simple in its fundamental assumptions, but, like it, requiring for its full development the utmost resources of mathematical analysis. It cannot but seem strange to the majority of you to be told that we know probably as much about the secret mechanism of electricity as we do about that of light, and that it is more than exceedingly probable that a ray of light is propagated by electric and electromagnetic disturbances. It is one of the most remarkable advances made during this century.

But to know what electricity is, does not necessarily guide us in the least degree to a notion of its source in any particular instance. We might know quite well *what* is electricity and yet be, as I told you at starting *we are*, almost entirely uncertain of the exact source of *atmospheric* electricity.

To come to my special subject. I am not going to try to describe a thunderstorm. First, because I am certain that I could not do it without running the risk of overdoing it, and thus becoming sensational instead of scientific; and secondly, because the phenomenon must be quite familiar, except perhaps in some of its more singular details, to every one of you.

Science has to deal with magnitudes which are very much larger or smaller than those which such words as huge, enormous, tiny, or minute are capable of expressing. And though an electric spark, even from our most

<sup>1</sup> Abstract of a lecture, delivered in the City Hall, Glasgow, by Prof. Tait.

powerful artificial sources, appears to the non-scientific trifling in comparison with a mile-long flash of lightning, the difference (huge, if you like to call it) is as nothing to others with which scientific men are constantly dealing. The nearest star is as much farther from us than is the sun, as the sun is farther from us than is London. The sun's distance is ninety-three millions of miles. If that distance be called enormous, and it certainly is so, what adjective have you for the star's distance? Ordinary human language, and especially the more poetic forms of it, were devised to fit human feelings and emotions, and not for scientific purposes. A thoroughly scientific account of a thunderstorm, if it were possible to give one, would certainly be at once ridiculed as pedantic.

Let us therefore, instead of attempting to discuss the phenomenon as a whole, consider separately some of its more prominent features. And first of all, what are these features when we are *in* the thunderstorm?

By far the most striking, at least if the thunderstorm come on during the day, is the extraordinary darkness. Sometimes at mid-day in summer the darkness becomes comparable with that at midnight, very different in kind as well as intensity from that produced by the densest fog. Objects are distinctly visible through it at distances of many miles, whether when self-luminous or when instantaneously lit up by lightning. The darkness, then, is simply intense *shadow*, produced by the great thickness and great lateral extension of the cloud-masses overhead. Seen from a distance, the mass of cloud belonging to the storm usually presents a most peculiar appearance, quite unlike any other form of cloud. It seems to boil up, as it were, from below, and to extend through miles of vertical height. The estimated height of its lower surface above the ground varies within very wide limits. Sausure has seen it as much as three miles; and in one case noticed by De l'Isle it may have been as much as five miles. On the other hand, at Pondicherry and Manilla it is scarcely ever more than half a mile. Haidinger gives the full details of an extraordinary case, in which the thundercloud formed a stratum of only twenty-five feet thick, raised thirty yards above the ground. Yet two people were killed on this occasion. Other notable instances of a similar extreme character are recorded.

Careful experiment shows us that the air is scarcely ever free from electricity, even in the clearest weather. And even on specially fine days, when large separate cumuli are floating along, each as it comes near produces a marked effect on the electrometer. Andrews obtained by means of a kite, on a fine clear day, a steady decomposition of water by the electricity collected by a fine wire twisted round the string. Thanks to Sir W. Thomson, we can now observe atmospheric electricity in a most satisfactory manner. I will test, to show you the mode of proceeding, the air inside and outside the hall. [The experiment was shown, and the external air gave *negative* indications.]

On several occasions I have found it almost impossible, even by giving extreme directive force to the instrument by means of magnets, to measure the atmospheric potential with such an electrometer, and had recourse to the old electroscope, with specially long and thick gold-leaves. On February 26th, 1874, when the sleet and hail, dashing against the cupola of my class-room, made so much noise as to completely interrupt my lecture, I connected that instrument with the water-dropper, and saw the gold-leaves discharge themselves against the sides every few seconds, sometimes with positive, sometimes, often immediately afterwards, with negative electricity. Such effects would have required for their production a battery of tens of thousands of cells. Yet there was neither lightning nor thunder, and the water was trickling from the can at the rate of only two and a half cubic inches per minute. Probably had there not been such a violent fall of sleet steadily discharging the

clouds we should have had a severe thunderstorm. Falling rain-drops are often so strongly charged with electricity as to give a spark just before they touch the ground. This "luminous rain," as it has been called, is a phenomenon which has been over and over again seen by competent and trustworthy observers. In the *Comptes Rendus* for November last we read of the curious phenomenon of electrification of the observer's umbrella by a light fall of snow, to such an extent that he could draw sparks from it with his finger.

In calm clear weather the atmospheric charge is usually positive. This is very commonly attributed to evaporation of water, and I see no reason to doubt that the phenomena are closely connected. [A few drops of water were sprinkled on a heated crucible, insulated, and connected with the electrometer.]

There can be no doubt that, whatever be the hidden mechanism of this experiment, the steam has carried with it a strong charge of positive electricity, for it has left the rest of the apparatus with a strong negative charge. We will now try that form of the experiment in another way. [High-pressure steam escaping from a little boiler was made to play upon an insulated conductor furnished with spikes, and connected with the electrometer, which then showed a strong positive charge.]

There are many substances which produce on evaporation far greater electric developments than water does, some of positive, others of negative, electricity. By far the most remarkable in this respect to which attention has yet been called is an aqueous solution of sulphate of copper. (*Proc. R.S.E.*, 1862.) The smallest drop of this solution thrown on a hot dish gives an intense negative effect—so great, in fact, that it may be occasionally employed to charge a small Leyden jar. But this, like the smaller effect due to water under similar circumstances, is not yet completely explained.

The next striking features are the flashes of lightning which at intervals light up the landscape with an intensity which must in the majority of cases far exceed that produced by the full moon. To the eye, indeed, the flash does not often appear to furnish more than the equivalent of average moonlight, but it must be remembered that it lasts for a period of time almost inconceivably short, and that the full effect of light on the eye is not produced until after the lapse of a considerable fraction of a second. Prof. Swan has estimated this interval at about one-tenth of a second; and he has proved that the apparent intensity of illumination for shorter intervals is nearly proportional to the duration. (*Trans. R.S.E.*, 1849.) I can illustrate this in a very simple manner. [Two beams of light were thrown upon the screen by reflection from mirrors, each of which was fixed *nearly* at right angles to an axis. When matters were so adjusted that the brightness of the two illuminated spots was the same, one mirror was made to rotate. The corresponding light spot described a circle about the other, and its brightness became less the larger the circle in which it was made to revolve.] The lightning flash itself on this account, and for the farther reason that its whole apparent surface is exceedingly small, must be in some degree comparable with the sun in intrinsic brilliancy—though, of course, it cannot appear so. The fact that its duration is excessively short is easily verified in many ways, but most simply by observing a body in rapid motion. The spokes of the wheels of the most rapidly-moving carriage appear absolutely fixed when illuminated by its light alone. One can read by its light a printed page stuck on a disc revolving at great speed. But the most severe test is that of Sir Charles Wheatstone's revolving mirror. Seen by reflection in such a mirror, however fast it may be rotating, a flash of lightning is not perceptibly broadened, as it certainly would be if its duration were appreciable.

The apparatus which, in our laboratories, enables us to measure the time which light, moving at nearly 200,000



miles per second, takes to pass over a few feet, is required to prove to us that lightning is not absolutely instantaneous. Wheatstone has shown that it certainly lasts less than a millionth part of a second. Take this, along with Swan's datum, which I have just given you, and you see that the apparent brightness of the landscape, as lit up by a lightning flash, is less than one hundred thousandth part of what it would be were the lightning permanent. We have thus rough materials for instituting a comparison between the intrinsic brightness of lightning and of the sun.

Transient in the extreme as the phenomenon is, we can still, in virtue of the duration of visual impressions, form a tolerably accurate conception of the form of a flash; and in recent times instantaneous processes of photography have given us permanent records of it. These, when compared with photographic records of ordinary electric sparks, bear out to the full the convictions at once forced by appearances on the old electricians, that a flash of lightning is merely a very large electric spark. The peculiar zig-zag form, sometimes apparently almost doubling back on itself, the occasional bifurcations, and various other phenomena of a lightning flash, are all shown by the powerful sparks from an electric machine. [These sparks were exhibited directly; and then photographs of some of them were exhibited.]

The spectroscope has recently given us still more convincing evidence of their identity, if any such should be wanted.

The bifurcations of a flash can puzzle no one who is experimentally acquainted with electricity, but the zig-zag form is not quite so easily explained. It is certainly destroyed, in the case of short sparks, by heating the air. [Photographs of sparks in hot and in cold air were



exhibited. One of each kind is shown in the woodcut. The smoother is that which passed through the hot air. The other passed through the cold air nearer the camera, and is therefore not quite in focus.]

Now heating in a tube or flame not only gets rid of motes and other combustible materials but it also removes all traces of electrification from air. It is possible, then, that [the zig-zag form of a lightning flash may, in certain cases at least, be due to local electrification, which would have the same sort of effect as heat in rarefying the air and making it a better conductor.

A remark is made very commonly in thunderstorms which, if correct, is obviously inconsistent with what I have said as to the extremely short duration of a flash. The eye could not possibly follow movements of such extraordinary rapidity. Hence it is clear that when people say they saw a flash go upwards to the clouds the ground, or downwards from the clouds to the ground, they must be mistaken. The origin of the mistake seems to be a subjective one, viz., that the central parts of the retina are more sensitive, by practice, than the rest, and therefore that the portion of the flash which is seen directly affects the brain sooner than the rest. Hence a spectator looking towards either end of a flash very naturally fancies that end to be its starting-point.

(To be continued.)

#### OBSERVATIONS ON ARCTIC FOSSIL FLORAS WITH REGARD TO TEMPERATURE

THE first feelings of surprise caused by the discovery of remains of warmer-temperate, sub-tropical, and even tropical plants within the Arctic circle, of, geologically speaking, comparatively recent age, have now died away, and we no longer find that their presence there forms so favoured a theme for speculation. The time appears to have arrived when we may critically examine the botanical evidence upon which estimates of the past degree of warmth enjoyed by the Arctic regions have to be formed. The method open to us is very simple: we have, it seems, only to first set aside determinations that are clearly little more than guesses; then ascertain the minimum mean temperature required by the remaining groups of plants to flourish at the present day; and the sum of these temperatures should furnish reliable results for each period.

I am not yet able myself to carry this inquiry beyond the ferns and conifers, but the determinations of these are probably so very much more accurate than those of the higher orders of plants as to comprise most of the safer data, and they are sufficiently numerous for the purpose.

My present remarks are limited to the Komeschichten, a horizon supposed in the "Flora Fossilis Arctica," to represent in Greenland the Urganian or Neocomian of Central Europe. In this Komeschichten two genera of ferns occur which deserve especial consideration, for Prof. Heer makes use of their presence to infer that at that period the Arctic regions were favoured with a sub-tropical or even tropical climate. These genera are *Gleichenia* and *Oleandra*. The correctness of the determination of the supposed Arctic *Oleandra* is doubtful, and it is best for the present to place them among the guesses. The very sparse indications of sori are not satisfactory, and there are no less than twelve widely-distinct genera possessing species with approximately the same venation. *Oleandra* is a small genus with but six species, almost confined to the tropics, but two of them grow in Northern India at altitudes of 6,000 and 7,000 feet.

It is quite otherwise with the remains of *Gleichenia*, for these preserve every characteristic of that genus. But while it is perfectly obvious that these are really fragments of *Gleichenias*, neither the number of species into which Prof. Heer has divided them, nor the inferences as to climate which he draws from them, can be admitted. He has quite unnecessarily, it seems to me, separated the fragments from the Komeschichten into fourteen species, and to these has added two from the Ataneschichten. The prevailing species, *G. Zippelii*, if considered to represent the type in its average size, might be made to embrace eight or ten of them without even then approaching the limits of variation seen in the corresponding existing species. *G. Gieskiana* receives the rather larger pinnæ and *G. gracilis* the smaller, and many others seem separated on trifling or fancied peculiarities, as *G. acutipennis*, which is merely a small, indistinct fragment, with a few rounded depressions, conjectured to mark sori, but which, from their position on the mid-rib, could not well be such. *Gleichenia* is a particularly variable fern. Berkeley mentions (Introd. to "Crypt. Bot.," p. 516, Fig. 110, b) that he had seen at Kew the minute pinnules of one of them expanded to three times its normal length, and the margins unfolded by exposure to a warm damp atmosphere. In two full-grown specimens of *G. dichotoma* from Khasia, in the Kew Herbarium, the longest pinnules respectively are one and nine centimetres in length. The Arctic species are, however, closely represented by *G. glauca* (*G. longissima*, Hook., "Syn. Filicum"), and in this species the pinnules in different plants vary, from a single locality, between 25 and 2 mm. in length. In making species out of fragments of fossil plants the greater or less liability of the living forms to vary should, it seems to me, be kept in mind, and for general convenience the

greatest possible number, if from one locality and horizon, be included together.

There are not wanting altogether, however, indications of other species, and among them *G. rigida*, *G. rotula*, and *G. micromera* seem to be distinct, but the great majority are simply pectinato-pinnatifid, and possess no really distinctive specific characters. In addition to this, fourteen species from one locality and horizon appear a very unlikely number to have existed together, for although the plants are sociable and grow massed together, but few species are ever met with living together in the same vicinity. The whole of America, which is the richest continent in species, contains but nine, the varied lands grouped as the Malayan region but seven, New Zealand five, Australia four, &c.; the total number recognised by Hooker in the "Synopsis Filicum" being but twenty-three. The greatest number growing in a restricted area is in North Caledonia, where there are four; but I am not aware whether these are actually associated together.

These *Gleichenias* are repeatedly alluded to by Prof. Heer as indicating a tropical nature for the Arctic cretaceous flora, but so far as their presence goes, they by no means imply that a high temperature prevailed. Although no *Gleichenia* now ranges into high northern regions, they flourish south in the rigorous climates of the Magellan and Falkland Isles, S. lat. 53°, which have an isotherm of less than 45°, and are also found on the high mountains of Tasmania and on the Andes at 10,000 feet, which is, according to Humboldt, the level of gentians and near the limit of arborescent vegetation. The group of *Gleichenias* from the colder regions of South America all resemble each other in much the same degree as those of the Arctic regions did, and all possess small, hard, rigid, pectinato-pinnatifid pinnæ. Among them are *G. pedalis*, *G. cryptocarpa*, and *G. quadrifartita*, all of which, but especially the former, vary considerably, being either long or shortly pectinate. It is a suggestive fact that the existing representative of these Arctic *Gleichenias* is the only one that still ranges into northern temperate regions, such as China and Japan, while the representative of the English Eocene species is an essentially tropical form.

The Arctic group of *Gleichenia* appears to have very little affinity with European fossil plants of similar age, except through *G. Zippelii*. Heer connects one with *G. comptoniaefolia*, from Aix-la-Chapelle, although there is little discoverable resemblance between them. To do so he has to point out a discrepancy between the drawing and the description, and although he had never seen the specimens, prefers to rely on the drawing which Dr. De Bey now disclaims as incorrect. The Aix-la-Chapelle types are really quite different and more varied, and link them with our own eocene species. This latter is an essentially tropical type, and completely distinct from either the fossil Arctic group or the existing forms from the cold southern latitudes, since it closely approaches *G. dichotoma*, the only type of a well-defined section of the genus, now almost universally distributed over the tropical world.

The *Gleichenias* seem first to have appeared in the Jurassic, to have passed away from Europe before the close of the Eocene period, and to be now decidedly characteristic of the southern hemisphere—very few species crossing the equator, although the representative of the fossil Arctic species still extends as far north as Japan. It is obvious that we need not, from their presence, assign a very high mean annual temperature to the older cretaceous period in Greenland. J. S. GARDNER

#### METEOROLOGY IN JAPAN

WE have read carefully and with great pleasure the *Memoirs* of the Science Department of the University of Tokio, Japan, vol. iii. Part i., which gives the

report of the meteorology of Tokio for 1879, by Prof. T. C. Mendenhall. The observations, which are carried on in the west wing of the small observatory attached to the University, were commenced in January 1879, and this is the first report issued by the Observatory. The instruments are from Negretti and Zambra, and, with the exception of the thermometers, they appear to have been placed in suitable positions. The thermometers are mounted outside the north window of the second floor, and are separated from the observing room by glass doors, which are opened for observation. This position of the thermometer is in several respects objectionable, but particularly as it precludes any comparability, beyond a rough one, between the temperature observations at Tokio and at other stations which are or may be established in Japan.

The hours of observation are 7 a.m., 2 and 10 p.m., an arrangement of hours, it may be remarked, which states the mean temperature of the six warmest months of the year about three-fourths of a degree too high, and further does not approximate with the desired closeness to the important diurnal turning-points of the barometric pressure. It is however right to add that it is declared desirable to increase the number of the observations to at least five or six during the day as soon as the necessary arrangements can be made, and to institute a series of hourly observations for approximately determining several of the diurnal curves. An arrangement, if possible to be carried out, for the erection of continuously-recording instruments, would be an important gain to Japan meteorology.

The observations are published *in extenso*, and are illustrated with great fulness by excellent diagrams, which show in a clear manner the main results of the year's observations, the diagrams being lettered and numbered so as to serve for both the English and the Japanese editions which are issued.

The mean pressure for the year at 32° and sea level is given at 29.952 inches, the monthly maximum, 30.093 inches, having occurred in January, and the minimum, 29.809 inches, in August, thus showing a tendency in the atmospheric pressure to be assimilated to the annual march of pressure in the continent adjoining. There having occurred no typhoon during the year, the lowest barometer was only 29.087 inches, which happened on February 23, and the highest, 30.515 inches, on April 21, the range for the year thus being 1.426 inch. The mean diurnal range from 7 a.m. to 2 p.m. is large, being 0.059 inch for the year, regarding which Prof. Mendenhall remarks that "this same relation exists in each set of monthly means with two exceptions." These exceptions are May and September, the ranges for which being, as printed in the means, 0.028 inch and 0.019 inch. On comparing these ranges with those for the other months, they are at once seen to be physically impossible; but by averaging the observations themselves for these months these exceptionally low ranges turn out to be due solely to errors of computation. The true range given by the observations for May and September are 0.047 inch for each month. The exceptionally large range for July, viz., 0.085 inch, is also an error of computation; the true range was only 0.052 inch, the mean range at Tokio being, as in corresponding latitudes of the Atlantic, less in the summer than in the winter months.

The lowest temperature for the year was 24.1° on January 2 and 7, and the highest 93.0° on August 15. The temperature fell to or below freezing (32°) on 46 days, 27 of these days being in January, and rose to or above 90.0° on 12 days, 7 of these days being in July and 5 in August. The mean annual temperature deduced from the 7 a.m., 2 and 10 p.m. observations was 58.5°, and from the maximum and minimum observations 58.0°, the higher temperature of the former being due to the 7 a.m. observations. If this were changed to 6 a.m. the hours of observation

would then be equidistant, which would furnish data for a more exact determination of the mean temperature.

Perhaps the most interesting part of the Report is what relates to the wind which is discussed with no little ability and fulness. The results establish beyond doubt that the wind blows more frequently from N. and N.W. than from any other directions, and that these are especially the directions from which winds of high velocity come. This is strikingly shown by the fact that 75 per cent. of all the high winds which occurred during 1879 came from N. and N.W. The N. and N.W. winds prevail from November to March, and S. and S.E. winds from May to August, the other months being transitional; and with reference to these S. and S.E. summer winds it is clearly shown that they blow with a much less absolute velocity than do the N. and N.W. winds of the winter months.

Of almost equal importance are the facts of the rainfall. The amount for 1879 was 58.98 inches, the rainiest months being May, June, September, and October, and the driest, November, December, January, July, and August. The rainfall is sorted according to the direction of the wind with which it fell; and the highly interesting results are arrived at that the greater number of rain-storms come from N. and N.W., that the heaviest rains come with N.W. winds, and that in no season are the S. and S.E. winds, not even in summer when they are the predominating winds, accompanied with the maximum rainfall as compared with other wind-directions. The rainfall partitioned in percentages according to the winds with which it fell were N. 18, N.E. 9, E. 9, S.E. 5, S. 7, S.W. 3, W. 17, and N.W. 32, there falling thus 67 per cent. of the whole rainfall with N., N.W., and W. winds.

Among the changes it is proposed by Prof. Mendenhall to be introduced are improved hygrometric observations, which were evidently not trustworthy for 1879; observations of earth-temperatures down perhaps to a depth of 40 feet; an extension of the anemometrical observations; observations of variations in the velocity of sound under different meteorological conditions, the data being obtained from the time-gun, which is fired at noon daily; and a systematic investigation of the phenomena of earthquakes.

But what is urgently required in developing the meteorology of Japan is, beyond all question, the establishment of a network of stations over the Islands equipped with trustworthy instruments. The sub-tropical situation of Japan between the largest continent and the largest ocean of the globe is, from a meteorologist's point of view, unique; and the report now under review points to meteorological peculiarities in its climate of the highest interest. A satisfactory statement of its climatic peculiarities is, as our readers are aware, a desideratum; and the information which could not fail to prove of the highest utility to the Japanese, and is certain to cast important lights on the meteorology of Asia and the Pacific, and particularly on the meteorology of this ocean about latitude 33°, south to which the islands extend, can be furnished from no other source than from a network of meteorological stations overspreading Japan.

#### MINERAL STATISTICS OF VICTORIA

FOR some years past the yield of gold in the colony has been steadily decreasing. In 1868 the quantity of the precious metal obtained from alluvial deposits amounted to 1,087,502 ounces, and from quartz-veins 597,416 ounces, making in all 1,684,918 ounces of gold. Last year the quantities were respectively—alluvial, 293,310; quartz, 465,637: making a total of 758,947 ounces. The comparatively rapid diminution in the supply from alluvial sources is quite intelligible, as these would necessarily be soonest exhausted, though it is important to observe that in 1879 for the first time for eleven years the return from this source shows a decided

advance on that of the preceding year, which is attributed to a better supply of water for sluicing operations, and to the opening up of deep mining ground. It is to quartz-mining, however, that the colony must look for the further development of her gold-fields. There has been a gradual decline in the yield from quartz-mines since 1872, when the amount obtained was 691,826 ounces. But the Secretary for Mines in his recent report speaks hopefully of the probable future of this important industry. Up to the end of 1879 the total quantity of gold raised in Victoria is estimated to have been 48,719,930 oz. 11 dwts., valued at 194,879,722*l.* The proportion of gold in the quartz varies considerably in different districts. Thus, last year at Castlemaine the average yield of each ton of quartz was 5 dwts. 18.45 grs., while in Gippsland it amounted to 1 oz. 2 dwts. 18.66 grs. The quartz of the latter locality is by much the most auriferous in the colony. The decrease in the supply of gold has been accompanied by a falling off in the number of miners. The men who found employment in gold mining in 1874 was 45,151; last year they numbered 37,553, which was an increase, however, of 917 over the number for 1878. The mining population includes an industrious and unpopular contingent of Chinamen, who last year amounted to 9,110, or 528 fewer than in the previous year. Taking the total annual yield of gold and dividing its value among the miners employed, the earnings of an alluvial miner are rated last year at 48*l.* 10*s.* 1*d.* per annum., while those of the quartz miners are given as 118*l.* 8*s.* 7*d.* Deep mining in quartz reefs continues to make progress, and the mines are becoming every year deeper. Some shafts are now more than 2,000 feet deep. The revenue derived by the colony from the gold districts amounted last year to 15,641*l.* 16*s.* 9*d.*, being a slight advance on that of 1878.

#### PHYSICS WITHOUT APPARATUS<sup>1</sup>

##### II.

AMONGST the elementary principles of mechanics which are capable of easy illustration without special apparatus is that of the centre of gravity. In every solid mass a point can be found such that the resultant of all parallel forces acting on the individual particles passes through it, and such forces balance themselves around this point. The gravitation-force of the earth is exerted towards its centre, but this being 4,000 miles away, the individual forces acting on the separate particles of a body on the earth's surface may be regarded as parallel forces. Hence the centre of the parallel gravitation-forces is termed the centre of gravity. If the centre of gravity be supported, that is to say, if the resultant force be met by an equal and opposite force of resistance, then the body will not fall. The leaning tower of Pisa does not fall because, in the first place, the mortar is strong enough to bind the masonry into a substantial whole, and, in the second place, because the obliquity of the inclination of the tower is not so great as to throw the centre of gravity beyond the supporting base. A vertical plumb-line dropped down from the centre of gravity of the tower would meet the ground inside the base. It is very easy to imitate the leaning tower by taking a common wooden roller and sawing off a piece with oblique ends. The toys which are sold under the name of the Toy Blondin also illustrate the principle of the centre of gravity. A metal figure slides or walks down a stretched string, being kept upright by means of a weight fixed to the end of the rod held in the hand of the figure, thus causing the centre of gravity of the whole to fall below the point of support. A simple way of showing the same thing with improvised material is illustrated in Fig. 3. A couple of forks are stuck into a cork.

<sup>1</sup> Continued from p. 322.

Their weight being considerable, the centre of gravity of the combination is below the cork, and if the cork be placed on the tip of the figure or on the lip of a wine-bottle, it will stand there securely even while the bottle is

while the snipe's head nods at the various members of the company in turn, and finally stops opposite one of them (Fig. 4).

A pretty mechanical toy formerly sold in many shops, but now rather rarely met with, is explained upon the principle laid down above. Two small wooden figures with large feet, and holding a couple of poles palanquin-wise between them, are set at the top of a flight of toy stairs. They descend performing summersaults over one another. Fig. 5 shows how the two figures are set at starting. The poles which they grasp are in reality glass tubes plugged at the ends and containing a small quantity of mercury. The figures are themselves made of very light wood, and the quantity of mercury is adjusted to a nicety, so that its position in the tubes determines the position of the centre of gravity of the combination. Fig. 6 shows the position of the mercury in the end *a* of the tube. At this stage of the movement the figure marked *R* is still standing on the topmost step. The other figure, *S*, is descending, as shown by the arrow. The position of the figure *S*, with the feet foremost, is determined by light silk threads which connect the shoulders of *R* with those of *S*, and in this position *S* has the advantage in weight over the counterbalancing mercury at *a*, hence *S* continues to descend until the tubes have passed the position in which they are level. Once past this position the mercury runs down from *a* to *b* and brings down *S* firmly on to his feet on the second step. At this juncture the arrangement of the various parts will be that indicated



FIG. 3.

emptied. M. Tissandier has revived another illustration of the same principle which is capable of evoking roars of laughter at a dinner-table. If a dish of snipe has been served up the head with its long beak may be fixed in a

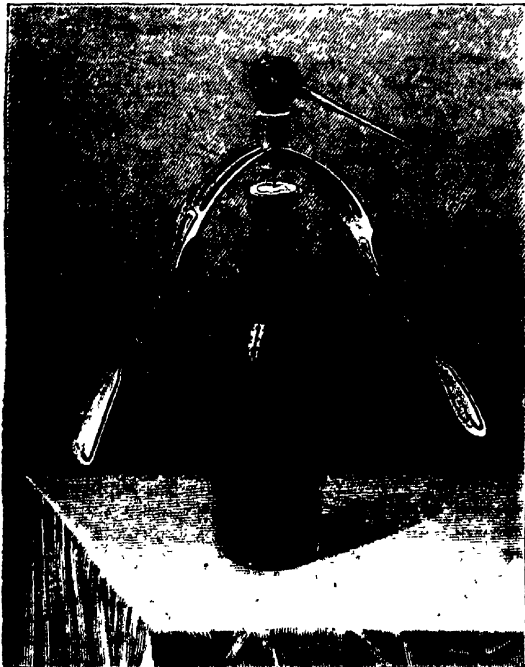

FIG. 4.

cork; and then, two forks being thrust into the sides of the cork and a needle having been fixed into the lower end of it, the cork can be balanced upon a coin laid on the top of a wine-bottle, and can be spun slowly round

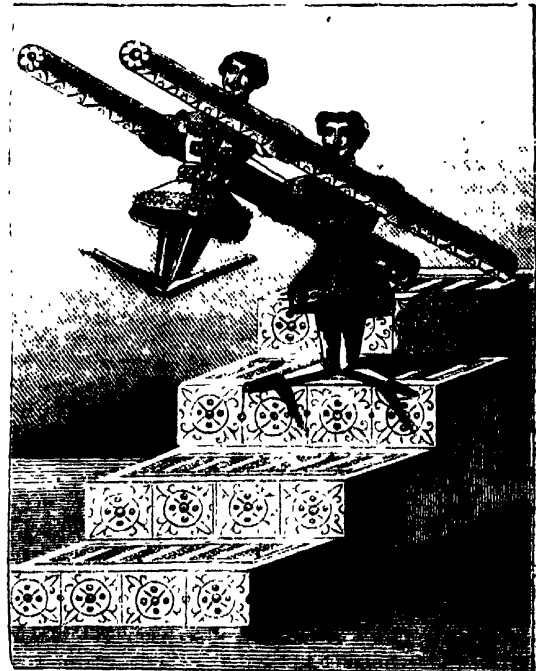

FIG. 5.

in Fig. 7. The hands of *S* now become the pivot about which the poles can turn and the mercury in *b* is collected right in the bottom of the tube, where it has the greatest leverage. The feet of *R* (which are

proportionally the heaviest part of him) are near to S, and his centre of gravity is therefore comparatively near to the pivot about which the combination is going to revolve. Hence while *b* sinks, R rises, and as he performs his

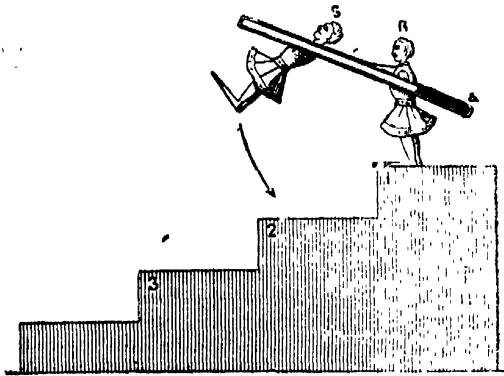

FIG. 6.

flight through the air over the head of S the silken strings gradually bring his feet forward until at last he has turned them forward so much that he has the greater leverage over the counterbalancing mercury at *b* and

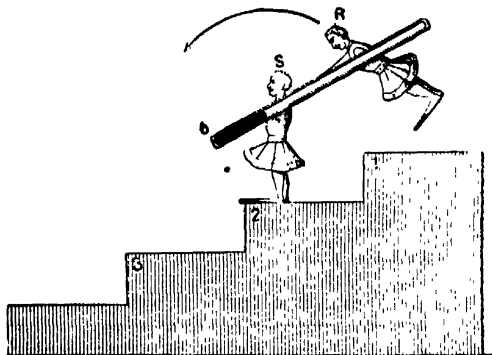

FIG. 7.

descends ready to take his stand on the third step. In this way the two manikins vault over one another's heads until they have descended from top to bottom of their tiny flight of stairs.

(To be continued.)

NOTES

THE French deep-sea exploring expedition off the North Coast of Spain in the Bay of Biscay, last month, appears to have been very successful, and to have fully confirmed the great reputation formerly earned by our neighbours in similar undertakings throughout the wide ocean. No less than 103 soundings were taken. The fauna agrees with that which was observed in the Porcupine cruise of 1870 along the western coasts of Spain and Portugal; and there are corresponding inequalities in depth. We understand that, with the approval of the French Commission, Dr. Gwyn Jeffreys will give an account of this expedition at the Swansea meeting of the British Association. The Paris report in the *Times* of August 5 is not quite correct.

THE American Association for the Advancement of Science meets this year at Boston, on the same day as our own does at Swansea, August 25. From the Local Committee's circular,

which has been sent us, it is evident that a "good time" is in store for those who attend the meeting, and they are likely to be many. It seems to us that the organisation of the American Association is much better than ours, though it will be seen from last week's NATURE that the Swansea Committee have taken great pains to give the British Association an agreeable reception. The Boston Local Committee contains many well-known names, and is subdivided into a Committee-at-Large, Reception Committee (which includes the names of numerous ladies, headed by Mrs. Louis Agassiz), Committees on Finance, Railroads, Hotels and Lodgings, Rooms for Meetings, Mails, Express, and Telegraph, and Excursions. On these committees we find such names as Ralph Waldo Emerson, Asa Gray, Oliver Wendell Holmes, Henry W. Longfellow, A. Graham Bell, A. Agassiz, and many others eminent both in science and literature. The arrangements for excursions and receptions seem admirable, and the *swans* will have a terrible round of pleasure to undergo. Among other provisions by the Local Committee is a daily free public luncheon between the morning and afternoon sectional meetings, for the purpose of keeping the members together. The circular contains all information about hotels and lodgings, receptions, excursions, meetings, &c., and ample provision has been made in the various rooms for experiments and illustrations. The rooms will be connected by telephone with each other, with the hotels, and with the general telephone circuit of Boston and Cambridge. Indicators in each of the sectional rooms, as well as in the secretary's room and in the hotel selected for head-quarters, will show at any moment what papers are under discussion in each of the sections. Among the public addresses to be given during the meeting are those of the retiring president, Prof. G. F. Barker, the vice-president of Section A, Prof. Asaph Hall, and the vice-president of Section B, Mr. Alexander Agassiz.

THE Annual Meeting of the British Medical Association was opened at Cambridge on Tuesday, under the presidency of Prof. Humphry.

THE Institution of Mechanical Engineers had a very successful meeting last week at Barrow-in-Furness. Every facility was afforded the members for inspecting the many objects of engineering interest in Barrow and its vicinity. The [papers read were all of more or less technical interest.

ON Thursday last the Anthropological Congress was opened at Berlin in the presence of the Crown Prince and Princess of Germany and of many distinguished literary and scientific men. Prof. Virchow delivered an eloquent speech. Dr. Schliemann afterwards gave an account of his discoveries and excavations. On Monday a banquet was given in honour of Dr. Schliemann and Prof. Nordenskjöld, who, on Tuesday, were entertained by the Crown Prince.

IN connection with the vote for the British Museum on Monday there was some talk as to the organisation of that institution and of the new Natural History Museum. Mr. Walpole spoke hopefully of the early transference of all the collections destined for the South Kensington buildings, while Mr. Story-Maskelyne, tenderly remembering his former colleagues, advocated the erection of houses for the officials. There was a good deal of vague and unsatisfactory talk about the distribution of duplicates to provincial museums. This is evidently a matter that requires clearing up, and it might be well to take means to decide once for all what are duplicates and what would be the best method of disposing of them. Mr. M'Cullagh Torrens thought there was great room for reform in the method of appointing the Trustees of the British Museum, who are far from being representative; there should, he thinks, be a larger infusion of the scientific element among them.

A CORRESPONDENT sends us some notes as the result of a visit to the Belgian National Exhibition at Brussels. The total

extent of the ground is 300,000 square metres, and the area covered by the palace 70,000. The number of exhibitors is 7,000, or more than one for each 1,000 inhabitants in a population of about 6,000,000. Two of the pavilions are occupied by the two principal telephonic companies, who are competing at Brussels, Antwerp, and Verviers, where rival central offices have been built, and are besieged by a crowd of experimenters. The number of tickets sold at the gate is about 10,000 a day, which is considered a success. It was attempted to establish a captive balloon on the model of the large Giffard captive balloon on a reduced scale, the rope being only 300 metres long instead of 1500, and the volume 8,400 cubic metres instead of 25,000. But in spite of this diminution the balloon refused to go up, the hydrogen having been mixed with a large quantity of common air. The Belgian balloon has been disinflated, and fresh efforts will be made to fill it with better gas, but success is considered rather doubtful. Except this disappointment, which it shares with Berlin, Vienna, and New York, where attempts to start a captive balloon failed, everything is going on remarkably well at Brussels. It is difficult to give a brief description of all the objects worthy of notice in this wonderful display of Belgian enterprise and skill. In the engine hall a facsimile of the first locomotive constructed on the continent has been placed. It bears the date of 1835, and an inscription shows it was made by Cockerill for the Belgian Government Railway. One of the wonders of the Exhibition is the collection of models of mining, showing all the incidents of underground workings and living. Scientific societies and Government exhibit complete collections of the mineral and vegetable kingdoms within the limits of Belgian territory. Every provincial Government is an exhibitor, and also the various Central Government Departments. The Belgian Photographic Society has organised a very good display. The Brussels Observatory has sent a model of van Rysseberghe's self-registering meteorograph. This apparatus is in operation at the Brussels Observatory, in Antwerp, at Ostend, and at Arlon. When the Belgian Observatory is moved to a new situation at some distance from the city, all these instruments will be connected with it by a special telegraph wire, so that the physicists of the Meteorological Office will write their predictions in a room where they will be able to watch the development of meteorological phenomena all over their native country. An electrical railway has been established in the gardens, and is working all day long with perfect regularity. The number of waggons is three, each of them carrying six passengers, with a velocity of 3 metres per second, to a distance of 300 metres, for 3d. The locomotive, of which the weight is 800 kilogs., carries a Gramme machine, worked by another machine, which is stationary. There is also in another part of the city a so-called International Exhibition, but this, although opened in state by the King, is merely a private speculation, without having any special feature or deserving any particular notice.

SIR WILLIAM HARCOURT stated in the House of Commons the other day that it is hoped that the work of the Cambridge University Commissioners will be completed before the Christmas Vacation.

PROF. MENDELEEF is at present in the Caucasus. He intends to visit Vladikavkaz, Tiflis, Batoum, and Poti, whence he proposes to proceed to Kertch to inspect the sources of petroleum.

The ladies continue to keep well to the front in the University of London Examinations. In the first division of the first B.Sc. examination the fourth on the list is Miss Sophia Bryant. The other five ladies are well up in this division, there being none so low as the second. In the first division of the first B.A. Examination the second on the list is Miss Catherine Eyre Anelay.

GREAT activity prevails at the Meudon aeronautical school, where the French Government has established extensive works for the construction of a large number of war balloons. Each of these, 10 metres in diameter, will be made of silk, varnished by a process invented in 1794. The valve is to be made of metal, and the shape will be quite spherical. Not less than forty of them will be sent to the several French armies for the purpose of making captive or free ascents when required. Of these more than half have been already constructed. The construction of furnaces for the preparation of pure hydrogen has not begun yet. The warehouse is large enough to contain inflated balloons, which can find exit by the roof. All the men and officers (except one) belong to the corps of Military Engineers. All the works for building directing balloons have been stopped.

THE *Daily News* Naples correspondent writes that Prof. Silvestri wrote from Catania on July 15 that since his report on May 1 last about the eruption of ashes from Mount Etna he has observed many other interesting phenomena. On May 16 and 17 last some slight shocks of earthquake were felt on the east side of Mount Etna, especially in the district of Acireale. About a month later the shocks commenced again and were repeated on several consecutive days—that is on June 15, 16, 17, and 18. The motion was undulating. About two days before these manifestations a new and very active phase of mud eruptions set in at Paterno, on the south-east of Etna. Two craters opened, which violently ejected gaseous matter with abundant torrents of mud, more consistent than usual, and of a higher temperature (140 degrees Fahrenheit), which, accumulating in the basins in large masses, finally broke through all barriers, overflowed and destroyed the adjoining fields, and buried several mills and farmhouses. In this eruption Prof. Silvestri noticed an abundant development and pressure of gaseous matter, of such force that it produced oscillations strong enough to tear up the old lava, forming rents out of which the gas rushed with the noise of a boiler letting off its steam. Coincident with these phenomena clouds of vapour issued from the eruptive fissure of last year, confirming the opinion formed by the Professor before—namely, that this fissure, lying between the two principal craters of 1879 and the great central one, had not been blocked with lava, but was still in communication with the central eruptive axis, for vapour, mixed with ashes which fell all over the cone, also issued from the central crater. This activity continued during several days, and still continues with decreased intensity, seen from Catania in the shape of dense clouds covering the whole summit of Etna in a clear sky. Changes have taken place which have entirely altered the form of the central crater. The old ravine, which formerly crossed the crater and made two-thirds of it into an ample and easily accessible basin, a natural laboratory for the study of the products of the volcano, now exists no longer. The central crater, from the effects of violent commotions, has crumbled, and, with part of its sides and the high point whence it was formerly possible to enjoy the sunrise, has been precipitated into the ravine, diminishing the height of the mountain by about 40 feet, while the circumference of the crater has become wider by half a kilometre. The general destruction of the old sides has in a certain way rejuvenised the crater, which has regained its characteristic form of a funnel, at the bottom of which is now the eruptive mouth.

A LETTER from San José, de Guatemala, dated July 2, to the *Panama Star and Herald*, says:—"At 3 a.m. on June 29 the volcano Fuego suddenly became active, throwing out vast showers of fire and cinders, with great darts of flame shooting up from 350 feet to 500 feet above the mouth of the crater. The whole country to the east and south was magnificently illuminated. At 3.40 a.m. two streams of lava could be seen running down the sides of the volcano, one to the south and east, the

other to the westward. Dense masses of steam and smoke rose from the courses of the lava streams, as the shrubbery and foliage were burnt. The river Guacalate rose suddenly, and its waters were quite warm. Fuego continued to belch fire until daylight, by which time the whole northern horizon, looking from San José, was dark with the smoke from the volcano. The lava streams continued in view until 4.30 a.m. The first grand column of fire rose at least 500 feet in height, solid and smooth, and then the top, expanding, opened out like an umbrella, the sparks coruscating like those from a brilliant rocket. The pulsations of flame during the first two hours of the eruption were about 50 seconds apart, strong and regular. The eruption was less active until, at 7.30 p.m. on July 1, a column of flame rose to a height, probably, of 150 feet or more. At the hour of writing Fuego smokes away steadily."

A REMARKABLE thunderstorm is reported as having occurred on July 24 last at Moylough, county Galway, Ireland. The storm, which was very vivid and accompanied by a most destructive fall of enormous hailstones, lasted about an hour and a half. One of the strongest discharges took place in a field about a mile from Moylough Church. The spot is described as presenting on a large scale an appearance like that of a sheet of cardboard that has been pierced by the discharge of a battery of Leyden jars. A long branching furrow, upturned as if by a plough, was found, a deep hole being bored at each end of six terminal branches, the earth round the holes being raised as if pushed up from below. Tufts of grass were scattered thirty and forty yards from the place.

MR. W. BRANKSTON RICHARDSON, writing from 61, Sutherland Gardens, Maida Vale, sends the following dog-story to the *Times*:—"Concurrently with the forty days' fast of the misguided American doctor, another fast has been in progress in our own country, for the truth of which I myself can vouch. A friend of mine who lives in Devonshire left home some weeks since on a series of visits to his friends in distant parts of the country. A few days after he left his servants wrote him that a favourite Skye terrier was missing. My friend, after every search had proved fruitless, considered that the dog had been stolen. On his return home, after an absence of one month and five days, he unlocked the library, the doors and windows of which had been bolted and barred during his absence, and to his astonishment the missing dog crept out into the light, a living skeleton and totally blind. He was well cared for, and has now quite recovered his health and sight. But his existence was wonderful. He had had no food and no water, and had not gnawed the books or obtained sustenance from any source whatever."

It is at present too early to offer an opinion as to whether "Brook's Popular Botany: comprising all the Plants, British and Foreign, most useful to Man in Medicine, Food, Manufactures, and the Garden," is likely to answer to its title, since so much depends on its completeness. In the two numbers which we have at present received the letterpress seems fairly accurate, if not scientifically precise; but the illustrations are on too small a scale, and altogether wanting in detail. The publication is at all events cheap enough.

THE City of Nancy has instituted at its own expense a competition among aeronauts. A premium of 80*l.* has been offered to the aeronaut who on an ascent made from Nancy shall have made the best observations. MM. Eugène Godard and Duraof have entered the lists.

IN the beginning of September a statue erected to Pascal by public subscription will be inaugurated at Clermont. The principal address will be delivered by M. Bardoux, ex-Minister of Public Instruction, and member for Clermont.

EVERY year the laureates of the Municipal Schools of Paris travel during their holidays at the expense of the Municipality. The pupils of the Turgot School will visit Chambéry, those of the Lavoisier School, Havre, and those of the Colbert School, Chambéry. The pupils of the J. B. Say School will go to Clermont Ferrand and witness the inauguration of Pascal's statue.

M. MAURICE KOECHLIN of Mulhouse, although born deaf and dumb, has passed successfully his examinations for baccalaureat at Rouen. He was educated by M. Hugentobler, director of an institution for such unfortunate persons. This young man is only sixteen years old, and his wonderful success has created quite a sensation.

THE Sixth Annual Report of the Yorkshire College for 1879-80 speaks with satisfaction of the progress of that institution. Instruction is now given in fourteen distinct subjects by twelve professors, lecturers, and instructors, aided by nine assistants. The number of students had increased to 142 from 113 of the previous year; there were besides 52 medical and 148 occasional students.

THE additions to the Zoological Society's Gardens during the past week include two Lesser Black-backed Gulls (*Larus fuscus*), British, presented by Mr. Beazley; a Horned Lizard (*Phrynosoma cornutum*) from Texas, presented by Mr. Luiz de Tavaris Ozorio, a Red-handed Tamarin (*Midas rufimanus*) from Surinam, two Russ' Weaver Birds (*Quelea russi*) from West Africa, deposited; a Servaline Cat (*Felis servalina*), a Coquetoon Antelope (*Cephalophus rufilatus*) from West Africa, a White-cheeked Capuchin (*Cebus lunatus*) from Brazil, four Brown Capuchins (*Cebus fatuellus*) from Guiana, two Swainson's Lorikeets (*Trichoglossus nove-hollandiae*) from Australia, an Anaconda (*Eunectes murinus*) from Demarara, purchased; a Mesopotamian Fallow Deer (*Cervus mesopotamicus*), a Gaimard's Rat Kangaroo (*Hypsiprymnus gaimardi*), born in the Gardens.

#### OUR ASTRONOMICAL COLUMN

COMETS OF SHORT PERIOD.—Faye's comet was detected by Mr. Common at Ealing, with his large reflector, on August 2, in the position given by Dr. Axel Moller's ephemeris. The theoretical intensity of light at this date was 0.078, which rather exceeds that at the first and last observations at the appearance in 1850-51. The comet was very small and extremely faint when the sky was not quite black. The perihelion passage does not take place until January 22, 1881, but although long visible, the faintness of the comet will prevent its being well observed at any time with ordinary telescopes. Since its last appearance in 1873, when only four observations were secured, the effect of perturbation has been to lengthen the period 56.5 days, and to retard the arrival at perihelion by 38 days, the main part of this perturbation having been produced by Jupiter in 1875.

Prof. Oppolzer has published an ephemeris of Winnecke's comet from elements brought up to the next perihelion passage (December 4). The track of the comet will be so unfavourable that it is very doubtful if observations can be obtained at this return. If the comet be glimpsed at all, it is most likely to be during the month following December 20, for which period, that nothing may be wanting on his part, Prof. Oppolzer has given an accurately-calculated ephemeris, which he thinks will indicate the position within two minutes of arc. The three returns in 1858, 1869, and 1875 were connected, taking into account the perturbations by Jupiter and Saturn, and Herr A. Palisa determined the effect of the same planets (first-power perturbations) from 1875 to December 1, 1880. The effect of a resisting medium was likewise included, Prof. Oppolzer having, as we lately recorded, found evidence of its sensible influence on the motion of this comet, unless a correction be applied to the received mass of Jupiter, which seems hardly admissible to the extent required.

Encke's comet will again arrive at perihelion about the first week in November, 1881, after which no one of the comets of short period will be due until January, 1884, but before that time it may be anticipated that the comet of 1812 will have

arrived in these parts of space. A search for this body with the aid of Prof. Winnecke's sweeping ephemerides is desirable forthwith, the length of the revolution not appearing to be determinable within very narrow limits from the observations of 1812, and there being no other recognised appearance.

IS  $\gamma$  CYGNI A VARIABLE STAR?—Writing in September, 1842, Sir John Herschel drew attention to this star, which he said appeared to have increased very considerably in magnitude since the date of Piazzì's observations. In 1842 it was "the principal star in the neck of the Swan, and of nearly the fourth magnitude, very conspicuous to the naked eye, and making in fact the only very distinctly seizable point between *Albireo* in the beak and the bright star  $\gamma$  in the body."

Piazzì, who observed the star nineteen times in right ascension and eleven times in declination, calls it 6.7 m. D'Agelet had estimated it 4.5 on July 29, 1783, and 5 on September 17, 1784; Lalande, 5 on August 12, 1793, and 4 on July 14, 1797; Bessel in his zone 436 on September 8, 1828, calls it 3 m. (!); Argelander and Heis, 4.5. Thus Piazzì's estimate appears to be lower than in the case of any other modern observer, but it is to be noted that Flamsteed reckoned the star no higher than the sixth magnitude.

$\gamma$  Cygni seems to deserve some attention at the hands of observers of the variable stars.

### GEOLOGICAL NOTES

GEOLOGY OF BELGIUM AND THE NORTH OF FRANCE.—M. Monron of Brussels has just published a work devoted to the general geology of Belgium. It describes the formations in chronological series, and is illustrated with maps, sections, and plates of the microscopic structure of rocks. A useful feature in it is a full bibliography of Belgian geology brought up to date. The new Government Geological Survey of Belgium has just published three sheets of maps, with sections, and explanatory notices. The maps, on a scale of 1:100,000, are printed in chromolithography and on a novel plan. The ordinary topographical features—roads, fences, trees, houses, &c., are printed in different colours, according to the tertiary formation lying underneath. Thus the Wemmellen (Eocene) areas are at once recognisable by an orange topography, the Oligocene tracts by one in slate colour and the Anversian (Miocene) by one in crimson. The quaternary deposits overlying these formations are expressed by broad tints of colour. The maps are accompanied by "Notices Explicatives," which in the case of the Hoboken and Contich sheets appear as a well-printed 8vo pamphlet of 256 pages, and a sheet of superficial sections on a scale of 1:100,000 for length and 1:100,000 for height. The country delineated and described lies on the low ground drained by the Escaut and Rupel, where, as little can be seen at the surface, a large series of borings has been made. The work has been accomplished by the Baron O. van Erborn, with the co-operation of M. Cogels. Prof. Gosselet of Lille has just issued the first fasciculus of an essay on the geology of the North of France and the neighbouring regions. It deals with the palæozoic formations, and is accompanied with an atlas of plates of fossils, maps, and sections. No one is so competent as M. Gosselet to describe the older formations of that district which he has so sedulously studied for many years. His volume will be welcomed not only by students in Belgium and the North of France, but by geologists in other countries, who will find in it an admirable résumé of all that is known on this subject up to the present time, and references to the more important original memoirs where fuller information can be had.

THE RIGHT OF PRIORITY IN PALÆONTOLOGICAL NOMENCLATURE.—M. Gosselet, in a communication to the Société Géologique du Nord, calls attention to the great inconveniences which arise from the multiplication of names for the same species. He suggests the establishment of an international tribunal for judging of the value of each new species, and for registering it, with its name and the exact date of its publication. He thinks that the expenses of the journal of such a commission would be easily met by the subscriptions of scientific men, and that the duties of the commissioners would not be heavy, as they would need to be consulted only occasionally in doubtful cases, the ordinary routine work being performed by a secretary. As illustrations of the evils of the present system, or, rather, want of system, he cites the history of some Spirifers.

1. GEOLOGICAL SURVEY OF NEW JERSEY.—Mr. George H. Cook, State Geologist of New Jersey, has issued his unpretend-

ing but useful Annual Report for 1879. It contains a record of the development of the mineral industries of the State for last year, and is accompanied with a good map, on which are delineated the various soils as distributed over the area. The iron-bearing rocks of the Archaean series extend from the north across New Jersey, and for several generations iron has been worked in this State. It is chiefly magnetic ore, and is searched for by means of the compass-needle, the attraction of which is noted. The commercial depression which began in 1873 has told heavily on the iron manufacture in the State. Of 200 mines and localities for ore only thirty have been kept in operation during the whole period of depression. There are now hopeful indications however of a revival of the trade. In the midst of information about building-materials, soils, mines, water-supply, and other topics, the writer of the Report continues to find a place for occasional interesting geological facts. His chapters are likely to be of much service to his fellow-citizens, who, it is pleasant to learn, show their appreciation of these Annual Reports, of which many of the former volumes are out of print.

GEOLOGICAL SURVEY OF ALABAMA.—The Geological Survey of this State is very modestly equipped. Its director, Prof. Eugene A. Smith, issues Annual Reports, which show, as minutely as the resources at his command will allow, the geological structure and economic resources of the different counties of the State. But he cannot make bricks without straw. It is short-sighted policy to require a Geological Survey to be made, and to equip it so economically that it cannot efficiently perform its work. In a country where the mineral resources remain in great measure undeveloped, it would be a wise expenditure of public funds to furnish means for making cuttings or borings where the crop of a seam of coal or vein of ore might be revealed at a short distance below the surface.

CENTRAL ASIAN GEOLOGY.—We find in the last number of the *Izvestia* of the Russian Geographical Society information as to the geological structure of the tracts to be crossed by the Southern Central Asian Railway. Altogether it is a flat and dry desert, covered with recent alluvial formations; the land becomes hilly only in the Mugojar Mountains. At Orenburg, and as far as Mertyvia Soli, there appear Trias sandstones and clays, which cover the Permian limestones, and gypsum with salt-springs (Sletskaia Zashchita). In the neighbourhood of Khanskiy Post we find a formation which probably will have an importance for the railway, namely, the Jura, which contains coal. At Ak-tube the shores of Teres-bvutak, Yakshi, and Djaman-kargal Rivers are craggy, and consist of Permian and Trias rocks. The Mugojar Mountains are formed of pretty green and red jades, and the Djaman-tau Mountains of an augitic porphyry of syenite and granite; gneiss and mica-slate cover the granite on the eastern slope. A kind of fine white clay, being a product of the trituration of rocks, is found at the foot of the Mugojar Mountains on both slopes, and large accumulations of gravel in the form of mounds appear at a short distance from the mountains to the east. The Karakorum steppe affords a series of mounds of sand mostly covered with vegetation and often with very old trees. These mounds are usually motionless, only those which are quite devoid of vegetation (such being exceptional) are set in motion during heavy storms. Altogether the structure of the steppe appears thus: At the base a sandstone, probably Tertiary, horizontally stratified; above this, a clay with gypsum borrowed by former watercourses, and above it the sandy mounds. Water is found at a small depth. Sandstone and clays forming low elongated terraces, and belonging possibly to the Jurassic formation, appear in the neighbourhood of Kara-tougay on the Syr-daria River.

GEOLOGY OF GENEVA.—The Geological Map of the Canton of Geneva, on the scale of 1 to 25,000, together with a "Geological Description of the Canton," in two volumes, by Prof. Alphonse Favre, have been published under the auspices of the Geneva Agricultural Society—the map a year ago, and the "Description" only now. The map is well printed with eight colours very agreeable to the eye, and sufficiently transparent not to obstruct the topographical details. As to the geological value of this work, the name of M. Favre is a sufficient warrant. The learned professor has spent no less than twenty-seven years in the study of the formations of his Canton. The "Description" consists of four parts. The first gives general notions in geology; the second contains a detailed description of the formations of the Canton, namely, the Molasse, the glacial and the post-glacial deposits



with numerous analyses of soil which give to this part a great importance for agriculture. The third part deals with erratic blocks as to their composition and origin; the fourth part describes subsoils, and contains a description of Lake Lemna.

**JURASSIC ROCKS OF THE ALTAI MOUNTAINS.**—According to the researches of M. Schmalhausen, noticed in the *Memoirs (Troud)* of the St. Petersburg Society of Naturalists, vol. x., the fossils of the Kouznetzk Carboniferous basin in the Altai Mountains, which fossils were described until now as palæozoic by Göppert in Tchikhatcheff's "Travels," by Eichwald, and by Heinitz in Cotta's "Altai," are identical with the Jurassic (Bathonian) plants which Heer has recently described in the Jurassic Flora of Eastern Siberia and Amour. M. Schmalhausen describes them as *Phyllothera*, *Asplenium whitbiense tenuis*, *Pterophyllum inflexum*, *Podocanistes lanceolatus*, Lindl., *Brachyphyllum*, and *Czekanowskia rigida*, Heer.

**MIOCENE FLORA.**—In his work, "Die Miocene Flora von Sakhalin," just published by the St. Petersburg Academy of Sciences, Prof. Schmidt describes 74 species of plants he has discovered, of which 43 were formerly known in other countries, and 31 are new; 27 are identical with Arctic Tertiary plants, 25 with Swiss, 18 with those of Alaska, and 21 with those of North America. The eighteen Alaska species are the most common of the Sakhalin Miocene flora, which circumstance, as well as the intermediate characters of the Tertiary flora of Kamchatka, is a new argument in favour of Asia, having formed, with America, one continent at this geological period. It is important to observe that the Tertiary flora of Sakhalin has more likeness to that of Greenland, of Spitzbergen, and of Switzerland, than to that of Central Siberia; thus, out of the eighteen species of Tertiary plants discovered by M. Lopatin on the banks of the Choulym River (not far from Krasnoyarsk), none were found among the Miocene fossils of Sakhalin, whilst the Tertiary flora of the southern shores of Lake Baikal is very like that of Sakhalin and of Alaska. To explain these differences Prof. Schmidt supposes that the fossil plants which are all described by Heer as Miocene ought to be considered as belonging to an older substage, all the more that the Sakhalin plant-beds are very intimately connected with the marine chalk which they concordantly cover.

### CHEMICAL NOTES

THE influence of sewage on potable waters is again being discussed. Herr R. Emmerich—in *Bied. Centralblatt*—makes an original contribution to the subject. He has for a long time daily drunk from a half to one litre of water from one of the Munich brooks which receives sewage of every kind; he has satisfied himself that there were cases of typhoid in some of the houses which drained into the brook. No bad effects having followed the consumption of this beverage, Herr Emmerich invites other experimenters to pursue investigations similar to his own! The same observer, however, finds that sewage water produces death in rabbits when injected subcutaneously in quantities of from 6 to 60 c.c., rabbits of a similar size being killed by the injection of 200 c.c. of distilled water. The injection of the residue from the evaporation of 500 c.c. of sewage water produced strong convulsions and death in rabbits. He proposes that suspected water may be examined by injecting 40 to 80 c.c. under the skin of a full-grown rabbit; if no rise of temperature greater than 1° occurs, or if death does not quickly follow the injection, the water would probably be uninjurious to human beings drinking it.

CITRIC acid has been formed synthetically by Grimaux and Adam. The process, which is described in the *Comptes rendus*, consists in forming dichloroacetic acid  $\text{CH}_2\text{Cl}-\text{COH}$   $\left\{ \begin{array}{l} \text{CO}_2\text{H} \\ \text{CH}_2\text{Cl} \end{array} \right.$  from symmetrical dichloroacetone, itself produced from glycerin through the intermediate stage of dichlorohydrin. By saponifying, by means of hydrochloric acid, the sodium salt of dichloroacetic acid, citric acid is produced; this synthesis confirms the generally accepted structural formula of citric acid.

DOUBT as to the elementary nature of sulphur is expressed by Th. Gross because of recent experiments wherein he claims to have produced a black, nonoxidisable, chemically indifferent substance by heating perfectly pure sulphur with linseed oil, dissolving the product in sulphuric acid, and precipitating by sulphuretted hydrogen.

THE influence of very small quantities of foreign substances in modifying processes of chemical change is a subject of much interest to the chemist, although as yet no full explanation has been given of this class of phenomena. In the course of his researches at high temperatures Victor Meyer has given one or two instances of such reactions. Thus he finds that ferric chloride, aluminium chloride, and zinc chloride are decomposed with evolution of chlorine at much lower temperatures when the vapour-density apparatus is previously filled with nitrogen gas than when no foreign gas is present. Meyer cannot trace any connection between the temperature, or amount of decomposition, and the chemical nature of the foreign gas.

THE long-protracted discussion between Berthelot and Wurtz regarding the dissociation of the vapour of chloral hydrate appears at length to be closed; Berthelot admits in the *Comptes rendus* that the vapour is partly dissociated at 100°, and that if the pressure is small the dissociation is probably complete.

AN interesting experiment, and one likely to lead to further results, is described by Berthelot in the *Comptes rendus*. He finds that such unstable compounds as ozone, hydrogen peroxide, &c., are not affected by sonorous vibrations of the rapidity of 100 and 7,200 per second.

M. MEUNIER claims, in *Comptes rendus*, to have produced spinel crystals, and thinks he has also produced periclase and corundum by the action of steam on aluminium chloride, at a red heat, in presence of magnesium.

AMONG other results accruing from V. Meyer's recent determinations of vapour densities is the addition of six or eight substances to the small list of gaseous metallic compounds. From the densities, and analyses, of these compounds the following numbers may be deduced as representing the *smallest possible valency* of the element placed opposite each number:—Arsenic, 2; cadmium, 2; copper, 2; iron, 4; indium, 3; tin, 2; zinc, 2. The formula of stannous chloride is shown by Meyer to be  $\text{Sn}_2\text{Cl}_4$  at about 700°, but  $\text{SnCl}_2$  at 900°. Hence the valency of tin varies at different temperatures.

IN the last number of the *Berliner Berichte* an attempt is made by Wiebe to trace a connection between the atomic weights of elements and the molecular weights of carbon compounds, and the coefficients of expansion of the same substances. He shows that for many elements the ratio between the reciprocal of the number obtained by multiplying the atomic weight of an element into the mean coefficient of cubical expansion from 0° to 100°, and the heat required to raise unit weight of the same element from absolute zero to the melting-point, is a nearly constant number. For elements crystallising in the regular system the mean value of the constant is 2.6; other elements show considerable divergences. For certain classes of carbon compounds the following equation is shown to hold:  $\frac{A \cdot a}{d} \cdot T = n \cdot \text{const.}$ , where  $A$  = molecular weight,  $a$  = mean cubical expansion from 0° to 100°,  $d$  = density of liquid compound,  $T$  = absolute boiling-point, and  $n$  = number of atoms in the gaseous molecule of the compound. The constant for the fatty acids and ethereal salts is from 3.1 to 3.8.

IN the *Proceedings* of the Asiatic Society of Japan R. W. Atkinson gives the results of his analyses of several Japanese porcelain clays; these results show that the opinion of H. Wurtz, viz., that Japanese porcelain is prepared from decomposed felspathic rocks alone, without admixture of kaolin, is not generally correct. Many of the clays analysed by Atkinson contained from 54 to 59 per cent. of silica, with 26 to 32 per cent. of alumina; others again contained from 73 to 79 per cent. of silica. In the clays exhibited in the Philadelphia Exhibition Wurtz found only one containing less than 74.5 per cent. of silica.

IN a series of papers by Nilson, and by Nilson and Pettersson, in the last number of the *Berliner Berichte*, important additions are made to our knowledge of the rarer earth metals. The existence of ytterbium seems proved. The atomic weight of this metal is 173 (mean of seven closely-agreeing determinations), assuming the formula of the oxide to be  $\text{Yb}_2\text{O}_3$ . The chief reasons for this formula are the isomorphism and general analogy of the sulphates of ytterbium, erbium, and didymium; the close analogy between the selenite of ytterbium and the selenites of metals which form oxides of the formula  $\text{M}_2\text{O}_3$ , and the molecular heat and molecular volume of  $\text{Yb}_2\text{O}_3$  compared with the same constants for the group  $\text{M}_2\text{O}_3$ .

REASONS are given for adopting the formula of scandium oxide as  $\text{Sc}_2\text{O}_3$ , and the atomic weight of scandium is determined to be 44.0 (mean of four closely-agreeing results). Scandium is undoubtedly identical with Mendelejeff's ekabor.

THE specific heat of beryllium has been determined by Nilson and Pettersson. Between  $0^\circ$  and  $100^\circ$  the specific heat is 0.4246; between  $0^\circ$  and  $300^\circ$ , 0.5060. These chemists have likewise made a new determination of the combining weight of beryllium, and find it to be 4.55, which is a very little less than the number found by previous observers. They think that the atomic weight of beryllium is undoubtedly 13.65, and not 9.1, as generally supposed; oxide of beryllium is therefore  $\text{Be}_2\text{O}_3$ , and this metal is not to be placed, in Mendelejeff's system, as the first member of the magnesium group. Neither can beryllium form the first member of the aluminium group, as suggested by Lothar Meyer. Nilson and Pettersson detail many facts which lead them to regard beryllium as the first member of the group of cerite and gadolinite metals, which comprises the metals, Be, Sc, Y, La, Ce, Di, Tr, Yb, Soret's x, Er, Tu, Yb. The paper contains many most important chemical and physical data concerning the salts of the metals of this group.

FROM the specific heats of the oxides of beryllium, scandium, gallium, indium, and aluminium, the specific heat of oxygen in combination is deduced by Nilson and Pettersson as being 2.3 to 3.1; the mean specific heat of oxygen in combination is 4.0; the oxides named are therefore somewhat anomalous.

THE "molecular volume," *i.e.*,  $\frac{\text{molecular weight of gas, of}}{\text{sp. gr. of solid}}$  the various molecules of water of hydration has been recently shown by Thorpe and Watts to vary in the magnesium group of sulphates; Nilson and Pettersson obtain nearly the same number (8.5) as representing the mean volume of each water-molecule in the sulphates of yttrium, erbium, and ytterbium; but a somewhat larger number (11.5) for the mean volume in the sulphates of cerium, lanthanum, and didymium.

### PHYSICAL NOTES

IN liquids small particles often show dancing motions under the microscope, and similar motions have been attributed to dust-particles in air, and accounted for by the shock of molecules with the particles. In a recent paper treating fully of the movements of very minute bodies (*Munch. Ber.*, 1879, p. 389) Herr Nageli calculates from data of the mechanical theory of gases as to the weight and number and collisions of molecules, the velocity of the smallest fungus-particles in the air that can be perceived with the best microscopes, supposing a nitrogen or oxygen molecule to drive against them. It is, at the most, as much as the velocity of the hour hand of a watch, since these fungi are 300 million times heavier than a nitrogen or oxygen molecule. The ordinary notes would move 50 million times slower than the hour-hand of a watch. Numbers of the same magnitude are obtained for movements of small particles in liquids. In both cases a summation of the shocks of different molecules is not admissible, as the movements are equally distributed in all directions. Herr Nageli therefore disputes the dancing motion of solar dust-particles, and attributes the Brownian molecular motion to forces active between the surface-molecules of the liquid and the small particles; but he does not say how he conceives of this action.

THE absorption of heat-rays by powders has been lately investigated by Herr van Deventer (*Inaug. Diss. Leid.*, 1879, p. 78, or *Wied. Beibl.*, 6) without use of any binding material. Under a copper cube kept at  $100^\circ$  was brought a thermo-element consisting of a brass plate, on the lower side of which was soldered a piece of bismuth and antimony (paralleloiped shape). On the plate was strewn the powder to be examined. A second similar element, with thermo-element lampblack, served for control. Briefly, the results were these: (1) Powdered substances in the same physical state have different absorptive power; (2) this depends on the thickness of the absorbing layer: each powder has its maximum absorption layer; (3) quite comparable values for the absorption cannot be had, as the thickness of the powder layer cannot be exactly determined; (4) the divergences proved in Tyndall's results with different binding materials are attributed to his not having taken into account the maximum emission layer; (5) whether the binding material affects absorption, and if so, how, can be demonstrated by the author's method (the element being painted over with the liquid holding the

powder in suspension): but experiments are here wanting; (6) the author's series of powders arranged according to absorption is quite different from Tyndall's emission series.

DR. PULUJ observes that if an electric radiometer is worked for some minutes and then the circuit is broken, a reversed motion is immediately set up, which continues for four or five minutes with an enormous rapidity. This he explains by assuming that there are really two actions tending to produce rotation: the electric reaction between the vanes and the molecules, and the heating of the metallic side of the vanes; that these two actions oppose one another, but that at small pressures, such as the high vacua, the electrical forces are in excess. When however they are brought to an end the heat-forces assert themselves, producing the opposite rotation.

FROM recent experiments (described in *Wied. Ann.*, No. 7) Herr Heitz concludes that the kinetic energy of the electric current in 1 cubic millimetre of a copper conductor, traversed by a current of unit electromagnetic density, is less than 0.008 milligramme-millimetre. As the kinetic energy is equal to half the mass multiplied by the square of the velocity, the mass of the positive electricity in 1 cub.-mm. is  $< \frac{0.008 \text{ mg.}}{v^2}$ . *E.g.*, if  $v = 1 \text{ mm.}$ , 10 mm., &c., the mass of the positive electricity  $< 0.008 \text{ mg.}$ ,  $< 0.00008 \text{ mg.}$ , &c. The limits here assigned, however, are exceeded where the densities of the electricity in the materials used are as their conductivities. (The experiments were made both with straight wires and with spirals, the former giving the more reliable results.)

THE results of theory regarding stationary vibrations of water are, in a recent paper (*Wied. Ann.*, No. 7) by Herr Kirchhoff and Herr Hansemann, compared with those of experiments in which a prismatic glass vessel, whose vertical cross-section consisted of two straight lines meeting at a right angle and equally inclined to the vertical, formed part of a pendulum, and was vibrated by electromagnetic means about that angle as axis. In the *Journal de Physique* (June) M. Lechat studies the surface vibrations of a liquid in a rectangular vessel, a small vertical rod having been adjusted to any point of the surface, and vibrated in the direction of its length by an electro-magnetic arrangement. The resultant forms were thrown on to a screen by means of a reflected beam of light.

IN a recent paper to the Belgian Academy (*Bull.*, No. 5) Abbé Spicé contends that the spectral line  $D_3$ , with wave-length about 588, observed in the chromosphere and protuberances, and assigned to a hypothetical body, helium, which some suppose to have a still more simple molecular constitution than hydrogen, probably belongs in reality to this gas. As to its non-reversibility, he considers that at a very small distance from the chromosphere the solar hydrogen may be so far cooled as to be comparable to that which we manipulate, and so, unable to extinguish waves which it can no longer produce, just as a stretched cord loses the property of vibrating in sympathy if its tension have been altered.

PURSUING his researches on the welding of solid bodies by pressure, M. Spring has subjected to various strong pressures (up to 10,000 atm.) more than eighty solid pulverised bodies; this was done in vacuo, and in some cases at various temperatures. The results are highly interesting. All the crystalline bodies proved capable of welding, and in the case of bodies accidentally amorphous the compressed block showed crystalline fracture; crystallisation had been brought about by pressure. Softness favours the approximation of the particles and their orientation in the direction of the crystalline axes. The amorphous bodies, properly so called, fall into two groups, one of substances like wax (*ciroid* bodies), which weld easily, the other of substances like amorphous carbon (*acroid* bodies), which do not weld. The general result is that the crystalline state favours the union of solid bodies, but the amorphous state does not always hinder it. M. Spring says the facts described do not essentially differ from those observed when two drops of a liquid meet and unite. Hardness is a relative, and one may even say subjective, term. Water may appear with a certain hardness to some insects, and if our bodies had a certain weight we should find the pavement too soft to bear us. Again, prismatic sulphur is changed by compression to octahedric sulphur; amorphous phosphorus seems to be changed to metallic; other amorphous bodies change their state, and mixtures of bodies react chemically if the specific volume of the product of the reaction is smaller than the sum of specific volumes of the reacting bodies. In all

cases the body is changed into a denser variety, whence may be inferred that the state taken by matter is in relation to the volume it is obliged to occupy under action of external forces. This (M. Spring points out) is merely the generalisation of a well-known fact. Some curious results are deduced from it. The researches described have important bearings on mineralogy and geology.

MR. R. CROWE of Liverpool communicates to the *British Journal of Photography* an account of some attempts to photograph a landscape by the aid of lightning-flashes. A gelatine plate, requiring by day an exposure of two seconds, was exposed from 10.15 p.m. to 10.45 p.m., during which time there were 120 brilliant flashes and about half as many minor ones. Most of these were in a horizontal direction, and five or six of them were imprinted on the negative. A perpendicular flash which struck a church-tower half a mile away was rendered with extraordinary sharpness and brilliancy. The surrounding objects, in spite of the long exposure, were but feebly impressed; whence Mr. Crowe argues that though the light of a flash of lightning is of a very actinic character, there still is not sufficient volume of light to illuminate a landscape or building to allow a successful photograph to be taken. Mr. Crowe further suggests that an attempt should be made to photograph, for scientific purposes of reference, the varied forms assumed by lightning at different times and in different countries.

### GEOGRAPHICAL NOTES

NEWS has been received from Zanzibar that Capt. Carter and Mr. Cadenhead, of the Belgian Exploration Expedition, have been killed by the chief "Wrambo." This is probably the chief Mirambo, who formerly caused so much trouble to explorers between Zanzibar and Lake Tanganyika, but of whom Mr. Stanley gives so good a report in his last work. It was Capt. Carter who was so successful in the introduction of Indian elephants into Africa.

THE August number of the Geographical Society's *Proceedings* contains Mr. im Thuyn's paper on his journey in British Guiana, already noticed in our columns, but the principal feature this month is of course the paper on Kuldja by Major F. C. H. Clarke, R.A., a well-known military writer on Eastern affairs. After a useful historical sketch, Major Clarke deals successively with the geography, orography, rivers, communications, towns, population, climate, vegetable products, and minerals of the region, and furnishes much interesting information, collected with evident care. This paper is followed by an account of M. Severtsoff's journey in Ferghana and the Pamir, from a translation by M. Alexis Lomonosoff, of the Russian Geographical Society. The geographical notes furnish information respecting the East African Expedition, the climate of Matabele-land, the recent observations of Dr. Matteucci in Kordofan, and Dr. Gerhard Rohlfs' account of the Jofra oasis. After notes on American Arctic expeditions and the position of the Crozet Islands, we have Mr. Whympers account of his ascent of the famous Antisana mountain in South America, and lastly Mr. A. Forrest's own narrative of his journey through North-Western Australia. Two maps are given with the present number, one of British Guiana, which is very acceptable, and the other of the Kuldja district and the Russo-Chinese frontier in Turkistan.

WITH the August number of their *Herald* the Baptist Missionary Society publish a map of Equatorial Africa, which, though presumably not laying claim to scientific accuracy, is of interest as showing what an immense region can be reached by means of the River Congo and its affluents. The map is intended to illustrate the scheme which Mr. Arthington has sketched out for the application of his last munificent donation to the Society. The geographical part of this great task consists in the exploration of the Nkutu and Ikelemba Rivers, the two principal tributaries of the Congo from the south, after passing Stanley Pool, and the opening of a route towards Lake Albert, along the Mburu River, which enters the Congo above Stanley's Arawiml.

M. C. E. DE UJFALVY left Paris in July to undertake a new and important journey in Central Asia. He goes in the first instance to Orenburg, and thence to Tashkend, where he hopes to arrive at the end of next month. He contemplates staying the winter at Samarkand, and will commence his explorations next spring. His programme is an extensive one, and embraces

a considerable part of the Southern Pamir region. In the course of his labours he will visit the Upper Zarafshan valley, Karategin, Wakhan, Shiguan, Badakshan, and probably Afghanistan. The return journey will, if possible, be made through Persia and the Caucasus.

NEWS has arrived in Paris that a French mission has reached Segon Sokkova and has been well received by King Ahmadan. M. Soleillet, who is on his way to Senegal, is not a member of this expedition, and will proceed by another route to the same city.

THE *Weimar Gazette* states that Dr. Gerhard Rohlfs is about to set out for Abyssinia, accompanied by Dr. Stecker, who will attempt a new exploration in Central Africa.

It is stated that a fifth Belgian Expedition is about to start for Africa, intended to reinforce the expedition on the Congo under Mr. Stanley. It will be commanded by Lieut. Braconnier.

THE August number of *Petermann's Mittheilungen* contains an exhaustive article by Dr. Behm on the Island of Rodriguez, accompanied by a very clear map. Bernhard v. Struve discusses the question of an inland trade-route through Siberia. An excellent hydrographical article, with a large-scale chart, on the Lower Weser from Bremen to Bremerhaven, is contributed by Oberbau-Director L. Franzius of Bremen. The results of the various East African International Expeditions are described. The researches of the Danish schooner *Ingolf* in the seas around Iceland in 1879 are described by H. Wiehmann.

THE London Missionary Society have received intelligence of the safe arrival of their new Tanganyika Expedition at Zanzibar on May 29. The party is composed of the Revs. A. J. Wookey and D. Williams, with Dr. Palmer as medical assistant. When the last mail left, an efficient leader and some of the head-men had already been engaged, and they hoped to start for the interior early in July.

THE Church Missionary Society are sending out further reinforcements for their Nyanza mission. The Rev. P. O'Flaherty, an able Oriental scholar, who was an interpreter on Lord Raglan's staff in the Crimean war, left for Zanzibar early in July, and will probably accompany the Waganda chiefs on their journey back to Lake Victoria. Mr. W. E. Taylor, of Hertford College, Oxford, who has been trained as a medical missionary, and Mr. A. J. Biddlecombe have, we believe, just started for East Africa, and will in the first instance join Mr. Copplestone at Uyui.

*L'Exploration* for August 5 contains some interesting extracts from the letters of Col. Prejevalsky, describing the difficulties he had to encounter in attempting to reach Lhasa, in which he was foiled. The intrepid Colonel has evidently succeeded in making considerable natural history collections.

### THE STRUCTURE AND ORIGIN OF CORAL REEFS AND ISLANDS<sup>1</sup>

**DARWIN'S THEORY.**—During the voyage of the *Beagle* and subsequently, Mr. Darwin made a profound study of coral reefs, and has given a theory of their mode of formation which has since been universally accepted by scientific men.

Darwin's theory may be said to rest on two facts—the one physiological, and the other physical—the former, that those species of corals whose skeletons chiefly make up reefs cannot live in depths greater than from 20 to 30 fathoms; the latter, that the surface of the earth is continually undergoing slow elevation or subsidence.

The corals commence by growing up from the shallow waters surrounding an island, and form a fringing reef which is closely attached to the shore. The island slowly sinks, but the corals continually grow upwards, and keep the upper surface of the reef at a level with the waves of the ocean. When this has gone on for some time a wide navigable water channel is formed between the reef and the shores of the island, and we have a barrier reef. These processes have but to be continued some stages further, when the island will disappear beneath the ocean, and be replaced by an atoll with its lagoon where the island once stood.

According to this simple and beautiful theory, the fringing

<sup>1</sup> Abstract of paper read at the Royal Society of Edinburgh by Mr. John Murray. (Published by permission of the Lords Commissioners of the Treasury.)

reef becomes a barrier reef, and the barrier reef an atoll by a continuous process of development.

*Object of the Present Paper.*—Prof. Semper,<sup>1</sup> during his examination of the coral reefs in the Pelew group, experienced great difficulties in applying Darwin's theory. Similar difficulties presented themselves to the author in those coral-reef regions visited during the cruise of the *Challenger*.

The object of the present paper is to show, first, that, while it must be granted as generally true that reef-forming species of coral do not live at a depth greater than 30 or 40 fathoms, yet that there are other agencies at work in the tropical oceanic regions by which submarine elevations can be built up from very great depths so as to form a foundation for coral reefs; second, that while it must be granted that the surface of the earth has undergone many oscillations in recent geological times, yet that all the chief features of coral reefs and islands can be accounted for without calling in the aid of great and general subsidences.

*Nature of Oceanic Islands and Submarine Elevations.*—It is now known that, with scarcely an exception,<sup>2</sup> all oceanic islands other than coral atolls are of volcanic origin. Darwin, Dana, and others have noticed the close resemblance between atolls and ordinary islands in their manner of grouping as well as in their shapes. In a previous paper the author pointed out the wide distribution of volcanic debris over the bed of the ocean in tropical regions, and the almost total absence of minerals, such as quartz, which are characteristic of continental land.<sup>3</sup> There is every reason for believing that atolls are primarily situated on volcanic mountains, and not on submerged continental land, as is so often supposed.

The soundings of the *Tuscarora* and *Challenger* have made known numerous submarine elevations: mountains rising from the general level of the ocean's bed, at a depth of 2,500 or 3,000 fathoms, up to within a few hundred fathoms of the surface. Although now capped and flanked by deposits of Globigerina and Pteropod ooze, these mountains were most probably originally formed by volcanic eruptions. The deposits in deep water on either side of them were almost wholly made up of volcanic materials.

Volcanic mountains situated in the ocean basins, which during their formation had risen above the surface of the water, would assume a more or less sharp and pointed outline owing to the denuding action of the atmosphere and of the waves, and very extensive banks of the denuded materials would be formed around them. Some, like Graham's Island, might be wholly swept away, and only a bank with a few fathoms of water over it be left on the spot. In this way numerous foundations may have been prepared for barrier reefs and even atolls.

Those volcanoes which during their formation had not risen above the surface of the sea (and they were probably the most numerous) would assume a rounded and dome-like contour,<sup>4</sup> owing to the denser medium in which the eruptions had taken place, and the deposits which had been subsequently formed on their summits.

In order to clearly understand how a submarine mountain, say half a mile beneath the sea, can be built up sufficiently near the surface to form a foundation on which reef-forming corals might live, it is necessary to consider attentively the

*Pelagic Fauna and Flora of Tropical Regions.*—During the cruise of the *Challenger* much attention was paid to the subject. Every day while at sea tow-nets were dragged through the surface waters; and while dredging they were sent down to various depths beneath the surface. Everywhere life was most abundant in the surface and sub-surface waters. Almost every haul gave many calcareous, siliceous, and other Algae; great numbers of Foraminifera and Radiolaria, Infusoria, Oceanic Hydrozoa, Medusae, Annelids; vast numbers of microscopic and other Crustacea, Tunicates, Pelagic Gasteropods, Pteropods, Heteropods, Cephalopods, Fishes, and fish-eggs; larvæ of Echinoderms, and of many of the above creatures, &c.

Most of these organisms live from the surface down to about 100 fathoms.<sup>5</sup> In calm weather they swarm near the surface,

but when it is rough they are to be found several fathoms beneath the waves. They are borne along in the great oceanic currents which are created by the winds, and meeting with coral reefs, they supply the corals on the outer edge of the reefs with abundant food. The reason why the windward side of a reef grows more vigorously appears to be this abundant supply of food, and not the more abundant supply of oxygen, as is generally stated. The *Challenger* researches showed that oxygen was particularly abundant in all depths inhabited by reef-forming corals.

When these surface animals die, either by coming in contact with colder water or from other causes, their shells and skeletons fall to the bottom, and carry down with them some organic matter which gives a supply of food to deep-sea animals. The majority of deep-sea animals live by eating the mud at the bottom.

An attempt was made to estimate the quantity of carbonate of lime in the form of calcareous Algae, Foraminifera, Pteropods, Heteropods, Pelagic Gasteropods, in the surface-waters. A tow-net, having a mouth 12½ inches in diameter, was dragged for as nearly as possible half a mile through the water. The shells collected were boiled in caustic potash, washed, and then weighed. The mean of four experiments gave 2·545 grammes. If these animals were as abundant in all the depth down to 100 fathoms as they were in the track followed by the tow-net, this would give over 16 tons of carbonate of lime in this form in a mass of the ocean one mile square by 100 fathoms.<sup>6</sup>

*Bathymetrical Distribution of the Calcareous Shells and Skeletons of Surface Organisms.*—Although these lime-secreting organisms are so abundant in tropical surface waters, their cast-off shells and skeletons are either wholly or partially absent from by far the greater part of the floor of the ocean. In depths greater than 3,000 fathoms we usually met with only a few shells of Pelagic Foraminifera of the larger and heavier kinds; a few hundred fathoms nearer the surface they became more numerous, and we got a few of the smaller kinds and some Coccoliths and Khabdololiths. At about 1,900 or 1,800 fathoms a few shells of Pteropods and Heteropods are met with; and in all depths less than a mile we have a deposit in which the shell and skeletons of almost every surface organism is to be found. In the equatorial streams and calms the calcareous Algae, Pelagic Foraminifera, Pteropods, and Heteropods are more abundant in the surface waters than elsewhere; and it is in these same regions that we found their dead shells at greater depths than in the deposits of other parts of the ocean. Another circumstance influences the bathymetrical distribution of these surface shells. When there is a complete and free oceanic circulation from the top to the bottom, these dead shells are found at greater depths in the deposits than where the circulation is cut off by submarine barriers.

The agent by which these shells are removed is, as Sir Wyville

<sup>1</sup> Among the varieties of Foraminifera recognised by Mr. Brady in the *Challenger* collections, the following have a Pelagic habit.

<i>Favosites Murrayi.</i>	<i>Hastigerina pelagica.</i>
" <i>caurivensis.</i>	<i>Orbulina umbrosa.</i>
" <i>crassa.</i>	<i>Globigerina bulloides.</i>
" <i>Murchisoniana.</i>	" <i>aequilateralis.</i>
" <i>lunata.</i>	" <i>sacculifera (hirsuta).</i>
<i>Pullena obliquibulcata.</i>	" <i>dubia.</i>
<i>Sphaerulina dehisens.</i>	" <i>rubra.</i>
<i>Caudinea nitida.</i>	" <i>conglobata.</i>
<i>Hastigerina Murrayi.</i>	" <i>inflata.</i>

It is the dead shells of these Pelagic Foraminifera which chiefly make up the calcareous ooze of the deep sea. The living shells of all the above varieties swarm in the tropical and sub-tropical waters near the surface. It is especially in the region of the equatorial calms that the largest and thickest shelled specimens are found. As we go north or south into colder water they become smaller, and many varieties die out. In the surface-waters of the Arctic and Antarctic regions, only some dwarfed specimens of *Globigerina bulloides* are met with. The author is unable to agree with Dr. Carpenter and Mr. Brady in thinking that these Pelagic Foraminifera also live on the bottom. This question was made the subject of careful investigation during the cruise. The shells from the surface and from the bottom were compared at each locality, and it was found, by micrometric measurement, that surface specimens were as large and as thick-shelled as any average specimens from the soundings. It is quite unlikely that the same individuals should pass a part of their lives in the warm sunny surface-waters, at a temperature of from 70° to 80° F., and another part in the cold dark waters two or three miles beneath, at a temperature of 30° or 40° F. The geographical distribution of these Pelagic forms over the bottom coincides exactly with the distribution of the same forms on the surface, that is to say, both on the surface and on the bottom the distribution is ruled by surface-temperature. No specimens of these Pelagic varieties were ever obtained from the bottom with the shells filled and surrounded with sarcode. Whereas creeping and attached forms (like *Truncatulina*, *Disorbina*, *Anomalina*, and some *Textularia*) were taken in this condition in almost every dredge. These last-mentioned forms, which we know live on the bottom, have a distribution quite independent of surface-temperature.

<sup>1</sup> *Zeitschr. für Wissen. Zoologie*, vol. xiii. p. 363.

<sup>2</sup> New Zealand, New Caledonia, and the Seychelles have primitive rocks, if these can be regarded as oceanic islands. Some of the islands between New Caledonia and Australia may have primitive rocks, and the atolls in these regions may be situated on foundations of this nature.

<sup>3</sup> *Proc. Roy. Soc. Edin.*, 1876-77, p. 247.

<sup>4</sup> *Scrope on "Volcanoes,"* chap. viii.

<sup>5</sup> The *Challenger* series, and many of the other members of Mäeckel's new

order *Phaoderia*, certainly live deeper, as we never got them in the tropics except when the net was sent down to a depth of 200 or 300 fathoms.

Thomson suggested, carbonic acid. Analysis shows that carbonic acid is most abundant in sea-water, and especially so in deep water. Pteropod and Heteropod shells are very much larger than the Foraminifera, yet are very much thinner; and hence, for the quantity of lime contained in them, they present a much greater surface to the action of the sea-water. This seems to be the reason why all large and thin shells are first removed from the deposits with increasing depth, and not the fact that some shells are composed of arragonite and some of calcite, as has been suggested.

There is a continual struggle in the ocean with respect to the carbonate of lime. Life is continually secreting it and moulding it into many varied and beautiful forms. The carbonic acid of ocean-waters attacks these when life has lost its hold, reduces the lime to the form of a bicarbonate, and carries it away in solution. In all the greater depths of the ocean these surface shells are reduced to a bicarbonate either during their fall through the water or shortly after reaching the bottom.

In the shallower depths—on the tops of submarine elevations or volcanoes—the accumulation of the dead siliceous and calcareous shells is too rapid for the action of the sea-water to have much effect. Long before such a deposit reaches sufficiently near the surface to serve as a foundation for reef-forming corals, it is a bank on which flourish numerous species of Foraminifera, Sponges, Hydroids, deep-sea Corals, Annelids, Alcyonarians, Molluscs, Polyzoa, Echinoderms, &c. All these tend to fix and consolidate such a bank, and add their shells, spicules, and skeletons to the relatively rapid accumulating deposits. Eventually coral-forming species attach themselves to such banks, and then commences the formation of

*Coral Atolls.*—Mr. Darwin has pointed out that "reefs not to be distinguished from an atoll might be formed" on submerged banks such as those here described. However, the improbability of so many submerged banks existing in the open ocean caused him to reject this mode of formation for atolls. As here stated, recent deep-sea investigations have shown that submerged banks are continually in process of formation in the tropical regions of the ocean, and it is in a high degree probable that the majority of atolls are seated on banks formed in this manner.

Mr. Darwin has also pointed out that the corals on the outer margin of a submerged bank would grow vigorously, whilst the growth of those on the central expanse would be checked by the sediment formed there, and by the small amount of food brought to them.<sup>1</sup> Very early in the history of such an atoll, and while yet several fathoms submerged, the corals situated on the central parts would be placed at a disadvantage, and this would become greater and greater as the coral plantations approached the surface. When the coral plantation was small there was a relatively large periphery for the supply of food to the inner parts, and also for the supply of sediment; and hence in small atolls the lagoon was very shallow, and was soon filled up. For the same reasons coral islands situated on long and narrow banks have no lagoons. An atoll one mile square has a periphery of four miles. In an atoll four miles square—the periphery increasing in arithmetical progression and the area as the square—we have for each square mile only a periphery of one mile over which food may pass to the interior, and from which sediment is supplied for filling up the lagoon.

With increasing size, then, the conditions become more and more favourable to the formation of lagoons, and as a consequence we have no large or moderate sized coral islands without lagoons. Tow-net experiments always showed very much less Pelagic life (food) in the lagoon waters than on the outer edge of the reef. The lagoon becomes less favourable for the growth of all the more massive kinds of coral as the outer edge of the reef reaches the surface, and cuts off the free supply of ocean-waters. Many species of corals die.<sup>2</sup> Much dead coral, coral rock, and sediment is exposed to the solvent action of the sea-water. Larger quantities of lime are carried away in solution as a bicarbonate from the lagoon than are secreted by the animals which can still live in it; the lagoon thus becomes widened and deepened.<sup>3</sup>

On the other hand a vigorous growth and secretion of lime takes place on the outer margins of the reef; and when the water outside becomes too deep for reef-forming corals to live,

<sup>1</sup> "Coral Reefs," p. 118.

<sup>2</sup> "Coral Reefs," p. 134.

<sup>3</sup> There are no living corals or shells in some small lagoons, the waters of which become highly heated, and in some cases extremely saline.

<sup>4</sup> Complete little Serpula-atolls, with lagoons from 3 to 50 feet in diameter, and formed in this way without subsidence, were numerous along the shores of Bermuda.

these still build seawards on a talus of their own debris.—the whole atoll expands somewhat after the manner of a fairy ring.

It is not necessary to call in disseverment of large atolls in order to explain the appearances presented in the Great Maldiva group of atolls.<sup>1</sup> The coral fields rising from very many parts of these extensive submarine banks form atolls. The marginal atolls have from the first the advantage of a better supply of food. They elongate in the direction of the margin of the bank where the water is shallower than to seaward. Many of these marginal atolls have coalesced, and as this growth and coalescence have continued, a large part of the food-supply has been cut off from the small atolls situated towards the interior of the bank. Ultimately a large atoll-like Suadiva atoll would be formed. The atolls in the interior would be perhaps wholly removed in solution, and the atoll-like character of small marginal but now coalesced atolls would be wholly or partially lost by the destruction of their inner sides.<sup>2</sup> A study of the charts shows all the stages in this mode of development.

In the case of the Lakadivh, Caroline, and Chagos archipelagos we have submarine banks at various stages of growth towards the surface, some too deep for reef-forming species of coral, others with coral plantations, but all submerged several fathoms, and scattered amongst these some of the oldest and most completely-formed atolls and coral islands. It is most difficult to conceive how these submerged banks could have been produced by subsidence, situated as they are in relation to each other and with respect to the perfectly-formed atolls, barrier or fringing reefs of the groups.

It is a much more natural view to regard these atolls and submerged banks as originally volcanoes reaching to various heights beneath the sea, and which have subsequently been built up to and towards the surface by accumulations of organic sediment and the growth of coral on their summits. It is a remarkable fact that in all coral atolls which have been raised several hundred feet above the sea, the base is generally described as composed of solid limestone, or "of various kinds of coral evidently deposited after life had become extinct."<sup>3</sup> This base is probably often made up of such a rock as that brought by the missionaries from New Ireland, and described by Prof. Liveridge,<sup>4</sup> as composed chiefly of Pelagic foraminifera, the same as those taken by the *Challenger* in the surface waters of the Pacific.

Microscopic sections of a rock taken from 50 feet below sea-level at Bermuda show that a deposition of carbonate of lime is going on. The small shells are filled with, and the broken pieces of shells and corals are cemented by, calcite. The wells in coral islands rise and fall with the tide, so that the whole atoll is filled like a sponge with sea-water. This water is very slowly interchanged, and by the solution of the smaller and thinner particles becomes saturated, and a deposition of lime follows. In this way we may explain the absence of many of the more delicate shells from some limestones.<sup>5</sup>

*Barrier Reefs.*—During the visit of the *Challenger* to Tahiti a careful examination was made of the reefs by dredging, sounding, &c., in a steam pinnace, both inside and outside the reefs. Lieutenant Swire, of the *Challenger*, made a careful trigonometrical survey of the profile of the outer reefs on six different lines; and while associated with him in this work the author was indebted to that officer for many valuable suggestions.

A ledge ran out from the edge of the reef to about 250 yards, where we got a depth of from 30 to 40 fathoms. It was covered with a most luxuriant growth of coral bosses and knobs.

Between 250 and 350 yards from the edge of the reef there was generally a very steep and irregular slope; about 100 fathoms was got at the latter distance, and the angles between these last-mentioned distances often exceeded 45 degrees. The talus here appeared to be composed of huge masses and heads of coral, which had been torn by the waves from the upper ledge and piled up on each other. They were now covered with

<sup>1</sup> Mr. Darwin's application of his theory to this group—where the disseverment of large atolls is called in, and a destructive power attributed to oceanic currents, which it is very unlikely they can ever possess—has often been considered unsatisfactory.

<sup>2</sup> In speaking of Bow Island, Belcher mentions the fact that several of its points had undergone material change, or were no longer the same when visited after the lapse of fourteen years. These remarks refer particularly to islets situated within the lagoon. I could myself quote many instances of the same description.—"Wilkes' Exploring Expedition," vol. iv. p. 372.

<sup>3</sup> U.S. Ex. Exp. vol. iv. p. 269.

<sup>4</sup> *Geol. Mag.*, December, 1879.

<sup>5</sup> Fuchs, "Ueber die Entstehung der Aptychankalke," *Sitzb. der Akad. der Wissensch.*, 1877.

living Sponges, Alcyonarians, Hydroids, Polyzoa, Foraminifera, &c.<sup>1</sup>

From 350 to 500 yards from the edge of the reef we had a slope with an angle of about 30°, and made up chiefly of coral sand. Beyond 500 yards the angle of the slope decreased till we had at a distance of a mile from the reef an angle of 6°, a depth of 590 fathoms, and a mud composed of volcanic and coral sand, Pteropods, Pelagic and other Foraminifera, Coccoliths, &c.

In the lagoon channel the reefs were found to be fringed with living coral, and to slope downwards and outwards for a few feet, and then plunge at once to a depth of 10 or 16 fathoms. Many portions of these inner reefs were overhanging, and at some places overhanging masses had recently fallen away. Everywhere much dead coral rock was exposed to the solvent action of the sea-water. The reefs of Tahiti are at some places fringing, at other places there is a boat passage within the reef, and at Papiete there is a large ship channel with islets within, and the outer edge of the reef is a mile distant from the shore. The island itself is surrounded with a belt of fertile low land, frequently three or four miles wide; this shows that the island has not in recent times undergone subsidence; there are indeed reasons for supposing it has recently been slightly elevated. Everything appears to show that the reefs have commenced close to the shore and have extended seawards, first on a foundation composed of the volcanic detritus of the island, and afterwards on a talus composed of coral debris and the shells and skeletons of surface organisms.<sup>2</sup>

The lagoon channel was subsequently slowly formed by the solvent action of the sea-water thrown over the reefs at each tide, and the islets in the lagoon channel are portions of the original reef still left standing. The reefs have extended outwards from the island and have been disintegrated and removed behind in the same way as the atoll has extended outwards after reaching the surface.

Where reefs rise quite to the surface, and are nearly continuous, we find relatively few coral patches and heads in the lagoons and lagoon channels. Where the outer reefs are much broken up, the coral growths in the lagoon are relatively abundant. Where the water was deep and the talus to be formed was great, the outward growth has been relatively slow,<sup>3</sup> and the disintegrating forces in the lagoons and lagoon channels gaining in the struggle, the reefs would become very narrow, and might indeed be broken up. This, however, would admit the oceanic waters and more food, and growth would again commence on the inner as well as the outer sides of the still remaining portions. In the great barrier reef of Australia, where the openings are numerous and wide, the reefs have a great width. Where the openings are few and neither wide nor deep (as in lat. 12° 30') the reefs are very narrow and "steep to"—on their inner side.

At the Admiralty Islands, on the lagoon side of the islets on the barrier reefs, the trees were found overhanging the water, and in some cases the soil washed away from their roots. It is a common observation in atolls that the islets on the reefs are situated close to the lagoons. These facts point out the removal of matter which is going on in the lagoons and lagoon channels.

**Elevation and Subsidence.**—Mr. Darwin has given many reasons for believing that those islands and coasts which have fringing reefs had recently been elevated, or had long remained in a state of rest. Throughout the volcanic islands of the great ocean basins the evidence of recent elevations are everywhere conspicuous. Jukes has given most excellent reasons for believing that the coast of Australia fronted by the barrier reef, and

<sup>1</sup> This ledge and steep slope beyond where a depth of 30 or 40 fathoms was reached, was characteristic of a large number of atoll and barrier reefs, and caused due to wave action. Experiments had been made with masses of broken coral, and it was found that these could (on account of their rough and jagged surface) be built up into a nearly perpendicular wall by letting them fall on each other. A talus formed in water deeper than 40 fathoms, where there was little, if any, motion, would be different from one formed on land. In the latter case the disintegrating forces at work always tended to set the talus in motion; in the former case everything tended to consolidate and to fix the blocks in the positions first assumed. A removal of lime in solution would take place from the blocks forming this steep slope, but except in very deep water this would not be sufficient to check the outward extension of the reef.

<sup>2</sup> A dredging in 155 fathoms, close to the barrier reef of Australia (between it and Raine Island), gave a coral sand, which was, I estimate, more than two-thirds made up of the shells of surface animals.

<sup>3</sup> Hence in barrier reefs, where the depth outside is very great, we find the reefs running closer to the shore than where the depth is less, and consequently the talus to be formed is smaller.

even the barrier reef itself, have recently been elevated.<sup>1</sup> Dana and Conthony have given a list of islands in almost every barrier reef and atoll region which have recently been elevated.<sup>2</sup>

This is what we should expect. Generally speaking, all the volcanic regions which we know have in the main been areas of elevation, and we should expect the same to hold good in those vast and permanent hollows of the earth which are occupied by the waters of the ocean. It must be remembered that probably all atolls were seated on submarine volcanoes. Areas of local depression are to be looked for in the ocean basins on either side of and between groups of volcanic islands and atolls, and not on the very site of these islands. This is what the deep-sea soundings show if they show any depression at all. Subsidence has been called in in order to account for the existence of lagoons and lagoon channels, and the narrow bands of reef which inclose these; but it has been shown that these were produced by quite other causes—by the vigorous growth of the corals where most nourishment was to be had, and their death solution and disintegration by the action of sea-water and currents<sup>3</sup> at those parts which cannot be, on account of their situation, sufficiently supplied with food.

All the chief and characteristic features of barrier reefs and atolls may indeed exist with slow elevation, for the removal of lime from the lagoons and the dead upper surface of the reefs by currents, and in solution by rain and sea-water, might keep pace with the upward movement.

The most recent charts of all coral reef regions have been examined, and it is found possible to explain all the phenomena by the principles here advanced; while on the subsidence theory it is most difficult to explain the appearances and structures met with in many groups; for instance, in the Fiji islands, where fringing reefs, barrier reefs, and atolls all occur in close proximity, and where all the other evidence seems to point to elevation, or at least a long period of rest. In instances like the Gambier group the reefs situated on the seaward side of the outer islands would grow more vigorously than those towards the interior; they would extend in the direction of the shallower water, and ultimately would form a continuous barrier around the whole group. The distinguishing feature of the views now advanced is that they do away with the great and general subsidences required by Darwin's theory,<sup>4</sup> and are in harmony with Dana's views of the great antiquity and permanence of the great ocean basin, which all recent deep-sea researches appear to support.

**Summary.**—It was shown (1) that foundations have been prepared for barrier reefs and atolls by the disintegration of volcanic islands, and by the building up of submarine volcanoes by the deposition on their summits of organic and other sediments.

(2) That the chief food of the corals consists of the abundant Pelagic life of the tropical regions, and the extensive solvent action of sea-water is shown by the removal of the carbonate of lime-shells of these surface organisms from all the greater depths of the ocean.

(3) That when coral plantations build up from submarine banks they assume an atoll form, owing to the more abundant supply of food to the outer margins, and the removal of dead coral rock from the interior portions by currents and by the action of the carbonic acid dissolved in sea-water.

(4) That barrier reefs have built out from the shore on a foundation of volcanic debris or on a talus of coral blocks, coral sediment, and Pelagic shells, and the lagoon channel is formed in the same way as a lagoon.

(5) That it is not necessary to call in subsidence to explain any of the characteristic features of barrier reefs or atolls, and that all these features would exist alike in areas of slow elevation, of rest, or of slow subsidence.

In conclusion it was pointed out that all the causes here appealed to for an explanation of the structure of coral reefs are proximate, relatively well known, and continuous in their action.

<sup>1</sup> "Voyage of the Fly," vol. i. p. 335.

<sup>2</sup> Dana's "Corals and Coral Islands," p. 345; Couthouy's "Remarks on Coral Formations," *Dost. Journ. Nat. Hist.* See also Stutchbury, *West of England Journal*.

<sup>3</sup> Very strong currents run out of the entrances into lagoons and lagoon channels, and when the tow-net was used in these entrances it showed that a large quantity of coral detritus was being carried seawards.

<sup>4</sup> "We may conclude that immense areas have subsided, to an amount sufficient to bury not only any formerly existing lofty table-land, but even the heights formed by fractured strata and erupted matter."—"Coral Reefs," p. 190.

The author expressed his indebtedness to all his colleagues, to Prof. Geikie, to the Hydrographer and officers of the hydrographic department, and in a special manner to Sir Wyville Thomson, under whose direction and advice all the observations had been conducted.

Challenger Office, 32, Queen Street, Edinburgh.

### THE JAMIN CANDLE

A NEW system in addition to those already prominent in the extensive field of electric lighting is shortly to be introduced into this country in the form of a candle devised by the well-known French electrician M. Jamin. This invention brings with it a considerable reputation, and how far this may be justified we shall probably soon have the opportunity of judging.

It has not yet had a trial in England, and until this is done we can only rely on the results of experiments, apparently of a not very exhaustive or conclusive character, which have taken place in Paris, and which must be accepted with a considerable amount of reservation.

The following description of the new candle is that given by M. Jamin himself in his paper to the French Academy of May 31, 1880:—

"I have had the honour to submit to the Academy during its sitting of March 17, 1879, the principle of a new electric burner.

"I have since succeeded in constructing a practical lamp, which I will describe. It rests on a slate base, which can be fixed into the globes or lanterns, according to the requirements of the decorations, and which supports at the base a gutter of copper, wide, but not very thick, in order to avoid shadows, and at the top is a gutter of soft iron, intended to be magnetised and to attract a movable armature or plate. The alternating current of a Gramme machine passes first through a wire of thin copper folded round the gutter some fifteen or twenty times, and which constitutes the directing circuit. In the middle of this frame and in the same plane are placed the candles or pairs of carbon rods between which the electric arc is to play. There are three, but a larger number can be inserted if the lighting is to be prolonged. Each carbon rod is inserted in a metal socket, in which they stand vertically, point downwards, and are retained in this position by means of a spring.

"The working offers no difficulties and demands no skill. There is no insulating material between the carbons. Those on the right are fixed and vertical; those on the left, hang freely from hinges; and the tops of their supports are connected by a small bar, which gives them a movement in common; the armature is attached by a lever to this bar, which it pushes towards the left by its weight, which brings the carbons together until one of them touches its companion. It is to be remarked that the contact will only be made in one of the candles, the longest, or the one whose points hang nearest together; that one will be lighted.

"The electric current, after having traversed the directing circuit, arrives simultaneously at the movable carbons, and can return indiscriminately by the three fixed carbons; it passes between those which touch, and lights them. Immediately the magnetism is made the armature is attracted, the three couples of carbons spring apart at the same time, two remaining cold, and the arc being established in the third. As long as there is any matter to burn it continues maintained at the points by the action of the directing current, and necessarily returning to it if any foreign cause should drive it away. When the current stops the armature falls back, and the contact is re-established; if it passes through again, the carbons are relighted, and spring apart as at first. Thus the lighting is automatic, instantaneous, and renewable at will.

"When the first candle is consumed, another must succeed it. For this purpose the left carbon-holder, which remained fixed, is jointed at the top and can be displaced, not in the plane of the frame, but perpendicularly. It is pushed by a spring, R, which tends to force it away, but it is kept vertical by a wire, B, bent round like a hook at its end, and which slides tightly in a receptacle where a spring presses it. When the combustion of the candle has brought the arc up to this point, the wire is melted, the carbon-holder is released, the two carbons spring suddenly apart, and the arc is extinguished, but immediately relights in the neighbouring candle. The change is so rapid that the action is hardly perceptible, and the other lamps in the same circuit are not at all affected.

"Besides, it must be remarked that this substitution of a fresh candle for the one consumed only happens every two hours, that

the wire is only melted at its extremity, that it is sufficient to cut off the point to bend it again and to draw it a little further from its receptacle, when new carbons are to be inserted, and that it serves for a great number of times. One of the greatest inconveniences of electric lighting is the possible sudden extinction of one of the lamps, which immediately causes that of the other candles in the same circuit, although they may be in good condition. Ours are very little subject to this danger, but it must, however, be foreseen and remedied. For this purpose one of my pupils has devised a system, the description of which would be too long. Its effect is (1) to open, at the moment of accident, a secondary circuit, which continues the current across the faulty candle; (2) to replace the extinguished lamp by an equal resistance, which leaves the others in the condition in which they were at first.

"This addition is very important, as it permits of our lighting many or few candles without changing their brilliancy.

"To sum up, our lamp contains many essential qualities. It lights and relights itself as often as required; it only requires one circuit for all the neighbouring candles; it replaces automatically those which are entirely consumed, by new carbons; it employs no insulating material which might alter the colour of the flame; and it requires no preliminary preparation of the carbons, which considerably diminishes the expense. If at first it underwent, like all others, variations of brilliancy that were owing, not to the construction, but to the defective preparation of the carbons, these variations have disappeared since, thanks to M. Carré, to whom so much is already due, and who has just given to his carbons the necessary solidity."

In the summer of 1878 the writer, in conjunction with Mr. McEniry, carried out a series of experiments with various forms of electric candles for Mr. Robert Sabine; the result is embodied in his provisional specification of November 27, 1878, part of which runs as follows:—

"My third improvement in regulating the distance between the carbon electrodes of a regulator or lamp consists in taking advantage of the well-known fact that parallel conductors attract or repel each other according as the currents in them go in the same or in opposite directions. For this purpose I place the carbons vertically side by side, one of them being fixed and the other balanced over a fulcrum or centre. The frames carrying the two carbons form portions of the common electric circuit in such a way that when the current circulates the parallel portions of the balanced frame (which carries the movable carbon) are deflected and the carbons separated. The degree of deflection of the flame depending upon the current, it follows that, should from any cause the electromotive force in the circuit increase, the frame is thereby deflected more, and the electric arc is correspondingly increased in length, which reduces the current again and maintains the light more steadily than when the carbons are placed immovably side by side without any such adjustment."

It is presumed by the writer that M. Jamin's paper to the French Academy of March 17, 1879, explaining the principle of his new candle, was the first public notice of it, and it will be therefore clearly seen that the part of the apparatus which he claims as particularly his own, viz., the directing frame, is in reality due to Mr. Sabine, and that while giving every credit to M. Jamin for independence of thought, it is only in common justice to Mr. Sabine that he should receive the merit of an idea which, in the words of a very flattering notice of the origin of Jamin's candle in a recent number of *La Lumière Electrique*, constitutes an elegant application of Ampère's laws.

Mr. Sabine's arrangement is also of a more simple nature than the candle just described, for it not only regulates the arc but separates the carbons without the aid of magnetism, and this could be as easily accomplished for a combination of three candles as for one.

It is probable that this latter candle was never constructed beyond the experimental stage, but that it could be put into a very simple and practical form is obvious.

Having thus shown that the two systems are identical, we will turn our attention to the consideration of the claims of this particular form of candle as now perfected and brought forward by M. Jamin.

It is questionable whether the surrounding frame of wire is as efficacious as we are led to believe, but that it exerts a certain influence on the electric arc is beyond doubt; but whether this favours the light or acts detrimentally by blowing and expanding the arc remains to be proved. Again, the fact of burning an

electric candle point downwards cannot be claimed as anything new, for the candles of Mr. Wilde have been successfully used in this position and without any directing frame. This latter, being of fine wire, must offer a considerable resistance to the current, and cannot be overlooked. It is claimed as an advantage in this system that the leading wires used are of the smallest description even for considerable distances, but the same may be said of any other system where the current-producing machine has a very high electromotive force. The size of wire for the circuit is not dependent upon any particular form of candle or regulator, but upon the current-producing strength of the machine employed for working the system.

The automatic lighting and re-lighting of the Jamin candle shows no advance over the means employed by others, nor does the insertion of a resistance in the place of an extinguished lamp constitute anything new. In any construction of candle where the two carbons are separated by the action of magnetism (one carbon being movable and attached to an armature influenced by an electro-magnet) it is impossible to keep the distances of the carbons apart always constant. Any variation in the current produces a corresponding variation in the magnetism which affects the movable carbon, this being especially the case in using alternating currents where the carbon must necessarily be in a continual state of vibration from the rapid changes of polarity.

Those candles of the Jablochhoff type are free from such a fault, owing to both carbons being made quite rigid by the insulating material between them, and the distance apart, therefore, being invariable throughout the whole length, which conduces greatly to the steadiness of the arc.

It is probable that the brilliancy of the light may be increased by burning the candle point downwards, but it must consume more rapidly than when in the reverse position, as the arc would tend to warm the carbon rods throughout their length. It is however certain that improvements will be made, and that probably this system will eventually compete favourably with other, already established, although at present it is difficult to see much advantage over such candles as Wilde's, Rapiéff's, &c.

T. E. G.

SOCIETIES AND ACADEMIES

PARIS

**Academy of Sciences, August 2.**—M. Edm. Becquerel in the chair.—The following papers were read:—On the preparation of chlorine, by M. Berthelot. The formation of the brown soluble compound (preceding the liberation of chlorine) requires not only chlorine and manganese, but a considerable excess of hydrochloric acid; it is a perchlorised chlorhydrate of manganese.—On heats of combustion, by M. Berthelot. This relates to the agreement between Thomsen's results and his own.—Synthesis of hexamethyl benzene and of mellic acid, by MM. Friedel and Crafts.—On human walking, by M. Marey. With his odograph he proves that the step is longer in mounting than in descending for an unburdened man than for one carrying a load, for one with very low-heeled, than for one with high-heeled shoes, for one with a thick sole prolonged slightly beyond the foot than when the sole is short and flexible. It seems as though the heel might be lowered indefinitely with advantage, but soles must not be elongated beyond a certain limit, nor made quite rigid. Sometimes (as in ascending) the length of the step is increased, and the rhythm retarded; at other times (as in more rapid walking) the step both lengthens and is accelerated.—Report on the interoceanic canal project. (Second Part.) M. de Lesseps' documents are approved.—On the gallicolicar phylloxera and *Phylloxera vastatrix*, by M. Laliman.—M. Zazareff described a battery in which electricity is produced by passage of a solution of glycerine, under pressure, through a mixture of coke and anthracite.—On the theory of sines of superior orders, by M. Farkas.—Researches on the electric effluvia (silent discharge), by MM. Hautefeuille and Chappuis. M. Thenard's apparatus (with alternative discharges) is well fitted to show the rain of electric fire in various gases. Fluoride of silicium gives the best effects; nitrogen comes next; hydrogen and chlorine also present the phenomenon.—Researches on batteries, by M. D'Arsonval. He indicates two methods of obviating the chemical action which goes on in batteries with two liquids when the circuit is open. The first consists in use of animal charcoal, substituted e.g. for the sand in a Minotto battery; the second, in using, as a depolariser, a liquid which gives a precipitate by its mixture with the liquid which attacks the zinc (there are many ways of doing this; and the author

mentions some). In the latter case the diaphragm is rendered impermeable by means of a conducting and electrolysable precipitate.—On the optical properties of mixtures of isomorphous salts, by M. Dufet. Let  $N$  be the index of the mixed salt,  $n$  and  $n'$  those of the components,  $p$  and  $p'$  the numbers of equivalents of the two salts; then  $N = \frac{pn + p'n'}{p + p'}$ . This

law is demonstrated, at least, for sulphates of the magnesium series.—Influence of temperature on the distribution of salts in their solutions, by M. Soret. The concentration of the heated part diminishes, that of the cold increases. The difference grows with the original concentration, and nearly in proportion. In the series of the alkaline chlorides the difference is greater (for the same concentration), the higher the molecular weight of the salt. The phenomenon seems to have no relation to solubility of the salt.—On the rise of the zero point in mercury thermometers, by M. Crafts. This rise (through heating) is quicker and greater in crystal thermometers than in those of glass without oxide of lead; it is quicker at first, and tends to a limit (with heating at fixed temperature). The zero point becomes fixed at the new height, when the instrument is kept at ordinary temperature and the thermometer becomes more stable.—Development, by pressure, of polar electricity, in hemihedral crystals with inclined faces, by MM. Jacques and Curie.—On the pyridic bases, by M. de Coninck.—On the heats of combustion of some substances of the fat-series, by M. Louguine.—Identity of acute experimental septicæmia with the cholera of fowls, by M. Toussein.—Formation of new races; researches in comparative osteology, on a race of domestic oxen observed in Senegambia, by M. de Rochebrune. The animal—a zebu—is specially distinguished by a conical nasal horn.—Action of poison on cephalopoda, by M. Yung. The effects of curare, strychnine, nicotine, &c., are described.—On a hailstorm at Paris on July 30, 1880, by M. Ferrière.—On determination of crystallisable sugar in presence of glucose and dextrine, by M. Pellet.

VIENNA

**Imperial Academy of Sciences, July 1.**—The following, among other papers, were read:—Development and formation of the glands of the stomach, by Prof. Toldt.—Tuberculosis, by Prof. Heschl.—On the absorption of radiant heat in gases and vapours, by Herr Lecher and Herr Penner.—On an optical property of the cornea, by Prof. Fleischl.

CONTENTS

	PAGE
ANCIENT GEOGRAPHY . . . . .	333
THE MENHADEN . . . . .	335
OUR BOOK SHELF:—	
Ross's "Alphabetical Manual of Blowpipe Analysis" . . . . .	336
Dall's "U.S. Coast and Geodetic Survey" . . . . .	335
Wood's "Tree Planter" and "Tree Pruner" . . . . .	335
Vinter's "Tables for the Analysis of a Simple Salt" . . . . .	337
LETTERS TO THE EDITOR:—	
The late Count L. F. de Pourtales.—Prof. P. MARTIN DUCAN, F.R.S. . . . .	337
The Recent Gas Explosion.—Dr. HERBERT McLEOD, F.R.S. . . . .	337
Heat of the Comstock Lode.—J. ARTHUR PHILLIPS . . . . .	337
British Museum Attendants.—WM. FLINDERS PETER . . . . .	338
Quansia and Mosquitoes.—J. B. DANCER . . . . .	338
Fascination.—THOMAS R. R. STEBBING . . . . .	338
Strange Method of Crossing a Torrent.—Surgeon-Major W. CURRAN . . . . .	339
Intellect in Brutes.—Surgeon-Major W. CURRAN . . . . .	339
Anchor-Ice.—R. J. FAQUOMARSON . . . . .	339
Depraved Taste in Animals.—ARTHUR NICOLS . . . . .	339
THUNDERSTORMS. By Prof. TAIT (With Illustration) . . . . .	339
OBSERVATIONS ON ARCTIC FOSSIL FLORAS WITH REGARD TO TEMPERATURE. By J. S. GARDNER . . . . .	341
METEOROLOGY IN JAPAN . . . . .	341
MINERAL STATISTICS OF VICTORIA . . . . .	343
PHYSICS WITHOUT APPARATUS, II. (With Illustrations) . . . . .	340
NOTES . . . . .	345
OUR ASTRONOMICAL COLUMN:—	
Comets of Short Period . . . . .	347
Is $\gamma$ Cygni a Variable Star? . . . . .	348
GEOLOGICAL NOTES:—	
Geology of Belgium and the North of France . . . . .	348
The Right of Priority in Palæontological Nomenclature . . . . .	348
Geological Survey of New Jersey . . . . .	348
Geological Survey of Alabama . . . . .	48
Central Asian Geology . . . . .	348
Geology of Geneva . . . . .	348
Jurassic Rocks of the Altai Mountains . . . . .	349
Miocene Flora . . . . .	349
CHEMICAL NOTES . . . . .	349
PHYSICAL NOTES . . . . .	350
GEOGRAPHICAL NOTES . . . . .	351
THE STRUCTURE AND ORIGIN OF CORAL REEFS AND ISLANDS. By JOHN MURRAY . . . . .	351
THE JAMIN CANDLE . . . . .	355
SOCIETIES AND ACADEMIES . . . . .	356



THURSDAY, AUGUST, 19, 1880

## COLOURS IN ART

*A Handbook for Painters and Art Students on the Character and Use of Colours, their Permanent and Fugitive Qualities, and the Vehicles proper to Employ. Also Short Remarks on the Practice of Painting in Oil and Water-Colours.* By W. J. Muckley. (London: Baillière, Tindall, and Cox, 1880.)

THAT a book for the instruction of artists as to the composition and purity of their pigments is much needed can hardly be denied. The difficulty, however, in writing such a book is very great; for it must either be very incomplete or contain a large amount of matter which but very few artists can understand. And no one is competent to write such a book but he who has some knowledge of painters' manipulations and a very good knowledge of chemistry; to drop the chemistry and take upon faith what has been written about the purity and nature of pigments, is hardly the method which should be adopted, and the person who does it is not likely to be a very safe guide to the artist, although he may give very many useful hints, and state much that is true. To treat of colours properly their composition must be described and the adulterations to which they are liable should be explained, which cannot be done without a certain amount of chemistry and chemical terms, and if the persons who read a book on pigments know nothing about chemistry, how can they be benefited by it? And this is difficulty number two. How is it to be overcome? Why, simply by artists learning something of chemistry? There is no other way for it. A book so incomplete as that under consideration is very misleading, because a person after reading it will know but little more about pigments than when he began. Of what use is it to know that cadmium yellow is a "sulphide of the metal cadmium," and that "emerald green is a preparation of copper," unless it be known that the elements which compose each have a decided liking for changing places, and that if these pigments are brought into contact the change will assuredly take place to the entire destruction of the tint of both of them? The real truth of the matter is that until artists will consent to become, to a certain extent, students of science, they will never get out of their difficulties, and if they will consent to this, to some of them we fear derogatory task, they will find that there is more help for them from science than they imagined: chemistry will lead to physics, and then for the first time perhaps many of them will learn what colour is, and what light and shade *really* are, and new views will burst upon them, and new methods of using their pigments will become necessary, and then pictures will be resplendent with nature's tints, and transparency will replace opacity, and nature will have some chance of being fairly represented. There are many artists who are scientific men, and there are others to whom nature has given special powers; and these show by their works that they understand or appreciate the true nature of colour and of light and shade. Look at Mr. Brett's sea-pieces (he is a scientific man of note), they are bright, luminous, and true to nature, although they may not please painters of the old

VOL. XXII.—No. 564

school, one of whom once, when asked what he thought of one of this artist's pictures, was heard to say he did not like rocks. As an illustration of one who lays no claim to be a scientific man, take Mr. Herbert's painting of *Moses* in the House of Lords, where bodies of the colour nearly of the sandy back ground stand out from it without any tricks, with all the vivid distinctness of a stereoscopic picture.

To those who know nothing of chemistry what directions can be given for the use of paints which in themselves are stable, but which cannot be mixed with certain others? It would take a huge volume to record all the cases in which they could be used, and to note all the contingencies which might arise to influence them, and yet a little sound chemical knowledge would make the matter easy and brief. Good champagne is a good and wholesome wine, and good old port is a nectar fit for the gods, and hock and claret are cooling drinks which, with their fragrant bouquets, appeal to the imagination: all are good and wholesome; but mix them all in the same stomach at a great feast, and what will be the result, at least in most cases? Vermillion is a good and safe pigment, so is cadmium yellow, and so is emerald green; but mix them all together, and what will happen? Keep the emerald green and the cadmium apart by some hard and quick-drying vehicle, and all will be well; allow a day's interval to elapse between taking the champagne and hock, and port and claret, and no inconvenience will be experienced.

It is very refreshing to read from the pen of Mr. Muckley the warning which he gives to artists to restrict the number of colours which they employ. It is to the use of bright and new tints with which the French colour-makers tempt our artists that much of the evil complained of is due, and moreover the adulteration practised abroad, but rarely in this country, has added to it. Mr. Muckley has divided pigments into "permanent colours" and "useless pigments." Speaking of "whites," he very justly recommends zinc white as being permanent, but then he speaks of "flake white" as permanent, but confesses that it loses "its opacity by age," and that "impure air and sulphuretted hydrogen turn white lead" (*i.e.* flake white) "to a dirty brown in a short time." One would hardly rank this among permanent colours. Amongst yellows he mentions "lemon yellow" as not altogether trustworthy. Now lemon yellow is chromate of baryta, and, like all other chromates, is liable to reduction by organic matter, and then, as it becomes reduced, its tint changes to green. Although he ranks this pigment among "permanent colours" he does so with a caution; why then place it in this list? "Aureolin" is also included in it; but very grave doubts are entertained of its stability in oil by many artists. It certainly resists the action of alkalis fairly well.

"Naples yellow," a pigment which portrait and figure painters have a great affection for, is now a compound made in imitation of the old paint, which consisted of antimony and lead; it was usually some time ago made with white lead tinted with some yellow pigments. If made with zinc white and cadmium, as Mr. Muckley asserts, there is not much danger in using it.

Amongst the "useless pigments" which are said to be "stable" it should be remarked that the whites, "Blanc

R

d'Argent or silver white," "London and Nottingham white," are both white lead, and therefore subject to the same influences as "flake white." "Scheele's green," which is an arsenite of copper, can hardly be called a "stable" colour, "but unnecessary."

"Semi-transparent colours." Amongst these is placed "cremintz white." Why this should be it is difficult to understand, if flake white is to be ranked among permanent colours, for cremintz white is white lead produced by precipitation.

"Prussian blue" is spoken of as not being durable; it is quite certain that it stands well sometimes, but that its hue does often fade. This must surely cause a reflecting mind to ask himself how this can be? The colour is so beautiful and useful to the artist that some effort should be made to prevent its total expulsion from his palette, and here we have an instance of the importance of chemical knowledge to the artist. It is impossible in this place to go into the question; it is however manifest if a pigment stands well at one time but not at another that it must be mixed, in the latter case, with something which does not agree with it. Now this is true; from its composition prussian blue is affected by anything which will change the state of oxidation in which part of its constituent iron is held. Terra verte, for example, is, or ought to be, an earth tinted with the protoxide of iron; if this is mixed with prussian blue it will in time change the condition of the oxide of iron in the prussian blue, and therefore its colour. In concluding these remarks on pigments treated of in Mr. Muckley's book one feels great pleasure in being able to state that with the few exceptions noticed there is nothing incorrect, only one feels how terribly wanting it is in completeness when a thoroughly scientific treatment of the subject is required. One of the points which artists have to guard against is adulteration of pigments; now this is a thing of constant occurrence, where cheap colours are bought, but in this work nothing is said about this important matter. However well an artist may select his paints, impurities in one or two of them may upset all his calculations and render of no value a work which might, if sound, represent a considerable sum of money. From the present position of art in this country this is probably the most touching way of putting it. It would be well, in a future edition, if Mr. Muckley would attend to this, and give some simple methods by which the impurities could be detected.

It is as important to the artist that he should understand the nature of the vehicles with which he paints as the composition of his pigments, and here one wishes that Mr. Muckley had gone more into detail, and that he had given reasons why such substances as maguilps, mastic, sugar of lead, &c., are so very objectionable. The reason why pictures crack is because two or more media are used which dry differently; if the vehicle employed is homogeneous there is no fear of cracking. Maguilp is made by mixing linseed oil with mastic varnish, and mastic varnish is gum mastic dissolved in turpentine. When these are mixed together the turpentine goes to the oil and leaves the mastic in a jelly-like condition; the whole mass is then rubbed up together, and in proportion as the mixture is more or less complete so will the vehicle be more or less liable to crack, because it is made up of substances which take different times in drying. All

maguilps are bad; here Mr. Muckley is right, and he is also right in advising the use of amber varnish and of good copal varnish tempered with nut (better with poppy) oil. No better media can be used than these, but the picture must be painted from first to last with one of them, whichever the artist selects, but the amber is the best. Six years ago the then Professor of Chemistry at the Royal Academy urged Messrs. Winsor and Newton to get amber varnish made, and that firm did so, therefore amber varnish has been to be had for that space of time, and several artists of distinction, viz., Mr. Brett, Mr. Vicat Cole, R.A., and others, have painted with it to their entire satisfaction; nor have they complained that it is too dark to mix with their lighter colours. When a picture is perfectly hard which has been painted with this vehicle, no better varnish can be used, when required, than amber varnish properly applied, that is, in as thin a coat as possible. Mr. Muckley speaks of mastic varnish blooming, but he does not tell us why it does so. It is because the substance is hygroscopic, and taking up moisture is the cause of blooming, therefore it should never be used. All driers, as he says, are unnecessary, they are all ruinous to pictures; under certain conditions crystallisable driers crystallise out and make the picture spotty. It would have been much more satisfactory if Mr. Muckley had treated this part of his subject at greater length and with greater minuteness; it is evident that he is quite competent to do so. Copal is a name used by varnish makers for several kinds of gum, and some of the cheap varnishes do not contain any of the better or harder gum. The kind used for artists' varnishes is what is termed a fossil gum, and is found largely at Zanzibar; it is almost, if not quite, as hard as amber, and almost intractable. The best copal varnishes sold by the best artist colourmen are, as a rule, made from this gum, and can be obtained from them with confidence. It is however pleasing to learn that so conscientious and respectable a firm as Messrs. Mander Brothers of Wolverhampton have undertaken to manufacture vehicles "in accordance with the old formulæ supplied by the author." There is no need whatever to use sandrac, it is very brittle and unmanageable.

In the work before us "turpentine" is spoken of as being, in conjunction with colours, "detrimental to their permanence." Turpentine, which is distilled with water from coniferous trees, oxidises and forms a resin, this it does most readily in the presence of moisture and sunlight. If then turpentine be kept free from moisture, in a well-corked bottle, in the dark, this will not happen, and the way to keep it free from moisture is to put into it lumps of quicklime or fused chloride of calcium; when so treated it may be used with safety. One does not like to have so old a friend banished without saying a word in his defence. The suggestion made to use oil of lavender is a very good one, but it need not displace turpentine, but both must not be used together.

"The conditions under which a painter commenced his education in former times were totally different from what they are now." It would be better for art if they were the same, though perhaps not better for art regarded as a trade. The paintings of the old masters certainly be most of the modern works in this country, both in art and durability. Mr. Muckley's remarks on this point

very good; one only wishes that he had treated this part of his subject more fully.

The chapter on "Mixing and Nature of Colours" is not as complete as it should be, from the almost entire absence of chemical illustrations, which on such a subject are invaluable. One remark, however, which often occurs in this book is most admirable. "The painter should always make an effort to use as few colours as possible, and they should be of the most permanent kind."

On damage to oil-paintings by gas and damp, it is stated that painter's canvas is usually prepared by first covering one side of it with a coat of whiting, to which glue size has been added. This is hardly a correct statement of the method employed by the best firms. The canvas is treated with size rubbed in with long knives, in the jelly form, it is then scraped off as bare as possible. This is done to protect the canvas from the disintegrating effects of the oil used in the preparation of the surface, for oil oxidises and speedily rots canvas, and therefore a coat of oil paint would not be, as stated, a protection to the back of prepared canvas: better use paraffin, which does not oxidise. Space will not allow a further notice of the concluding chapters of this work. One or two points, however, seem to require remark. "If darkening of a picture is due to some chemical action in the colours themselves, which is not unfrequently the case, the original condition of the work cannot be restored." If the darkening be due to the action of sulphuretted hydrogen or white lead, the whiteness can be restored by washing with peroxide of hydrogen.

In the directions given for painting the walls of the painting-room it is advised to use prussian blue, and the vehicle to be employed is spoken of as distemper colour. Prussian blue is immediately decomposed by lime or chalk, and therefore cannot be used with these materials.

On the whole, one feels great pleasure in recommending this book as useful to art students. As has been before stated, it is matter for regret that parts of it have not been more fully treated, and at the same time it must be observed that, as regards scientific questions involved in the composition of pigments and on their action on one another, as well as the adulterations with which they are contaminated, the subject is almost wholly untouched, and we must look for some further treatise to illustrate and explain these points, either from Mr. Muckley or from some other author.

#### A VISIT TO ETNA

*Un Viaggio all' Etna.* Del Prof. Orazio Silvestri, di Firenze, Presidente del Club Alpino Italiano a Catania. (Torino: Ermanno Loescher, 1879.)

THE Italian Alpine Club has branches in all the principal cities of the kingdom, and a good deal of useful work is done every year by its members. The work before us is designed not only for the benefit of the Club, but to foment and foster a greater taste among Italians for exploration, by setting before them a history of their most famous mountain, and detailing the very incidents to be met with in a journey to its summit. It is divided into eight chapters, and is furnished with an appendix, which contains a list of the principal peaks on the slopes of Etna, with their altitude and

position; the altitude of the principal towns on and around the mountain; and (to prevent imposition) the tariff established by the Catanian branch of the Alpine Club for the ascent of the mountain, and for visiting points of interest on its flanks.

The population of the mountain is rapidly increasing. In 1871 it amounted to 314,092, divided between thirty-nine cities, towns, and villages. The largest of these—Catania—contains 84,397 inhabitants; the smallest—S. Agata di Battiati—507.

The first chapter of the "Viaggio" carries the traveller from Turin to Naples, from Naples to Messina, and from Messina to Catania. The passing glimpses of Vesuvius and Stromboli are described, and the beautiful coast scenery between Messina and Catania, which embraces the Capo di Taormina, one of the most picturesque spots in Europe. The second chapter describes the ascent as far as Nicolosi, the last village on the route to the summit. In its immediate neighbourhood are the Monti Rossi, formed during the eruption of 1669, which is described at some length.

Starting from Nicolosi (Chapter III.), the traveller passes over the lava of 1537, and presently enters the *Regione Selvosa*; he notes the numerous groups of monticules scattered in various directions, rests at the Casa del Bosco, 235 metres higher than Vesuvius; and later on continues his journey through a region in which the vegetation becomes more and more sparse until he arrives at the Casa Inglese, near the foot of the great cone. Here the author bursts out into an "Inno alla Natura" improvised by the poet Mario Rapisardi on the occasion of his visit to the summit, and of which the following is a specimen:—

"Sorrìdi a noi, sorrìdi,  
O Dea! sia che de l'Etna  
T'amiamo oggi invocar,  
O dai pietrosi lidi,  
Ove fuggente e pavido  
Scagliossi il poveretto Aci nel mar."

About two o'clock in the morning the traveller leaves the Casa Inglese for the summit (Chapter IV.). The severe climb up the cone of cinders (angle from 32° to 35°) is attended by some difficulty of respiration, both from the rarity of the atmosphere, and the presence of volcanic exhalations. The phenomena preceding sunrise are described, the gradual illumination of the scene, and the projection of the shadow of the mountain over Sicily. An account of the appearance of the great crater concludes this chapter. A description of the eastern flank of Etna and the Val del Bove furnishes the matter for the two succeeding chapters. The geology of the mountain is herein discussed; specially the theory of two axes of eruption, warmly supported by Lyell and other geologists.

After resting a night at Giarre, the traveller visits the eruptive craters of 1865, passing by the villages of S. Giovanni and S. Alfio, and through the wood of Carpinetto, which contains the celebrated *Castagno del Cento Cavalli*. A detailed account of the eruption of 1865 which was minutely studied by Prof. Silvestri, is given in this part of the book (Chapter VII.). The last chapter is a very comprehensive one. It takes the reader completely round the northern, western, and southern flanks

of the mountain, by way of Randazzo, Bronte, Aderò, Paterno, and Monte Ste. Anastasia, and so back to Catania. Reflections on the results of the journey are concluded by a perfervid peroration, in which the author reminds us that from the top of Etna we may see nearly the whole of that beautiful island which the ancient poets symbolised as "La bionda e leggiadra figlia di Cerere e del sole," and the moderns yet more happily as "la fulgida perla dell' Italice diadema circondata da tre puri zaffiri; il Tirreno, il Jonio, l'Africano" . . .

The book is not illustrated, but it contains a clear and very accurate map of Etna, reduced from that of von Waltershausen, and with the addition of the eruptions subsequent to 1843. Prof. Silvestri's style, while it is accurate and precise from the scientific standpoint, is never dull or lagging. He carries his reader with him, and excites a genuine enthusiasm, which all who know him can well understand.

G. F. RODWELL

#### OUR BOOK SHELF

*Methods and Theories for the Solution of Problems of Geometrical Construction, Applied to 410 Problems.*

By Julius Petersen.

*Text-book of Elementary Plane Geometry.* By the same. (London: Sampson Low, 1880.)

SOME months since we noticed Prof. Petersen's "Theorie der algebraischen Gleichungen," and now we desire to draw attention to two more works by the same writer. The former, in its Danish garb, appeared so long ago as the year 1866, and having been tried and found to be a successful text-book, the author naturally desired to offer his work to a wider circle of geometers and students. The "Methods" has been rendered also into French; it is "an attempt to teach the student how to attack a problem of construction." Solutions in most cases are merely indicated, the following up the author's remarks being left to the student or teacher. The first chapter treats of "Locii" (method of similitude and inverse figures); the second of "Transformation of the Figures" (parallel translation, replacing, and revolution around an axis); the third of "The Theory of Revolution," with an appendix on systems of circles and on the possibility of solving a given problem by the straight edge and pair of compasses. It is a work of considerable merit. The "Text-book" we do not value so highly, though there are points of interest and novelty about it also; it contains besides 228 geometrical exercises. We hail Prof. Petersen as a valuable coadjutor in the work of improving geometrical teaching, and shall be glad if his little books meet with a fair measure of acceptance in this country. We could point out what we consider blemishes, but in the main commend both books. The respective translators (both, we presume, Danish students) have done their part intelligently, and English students will have no difficulty in understanding the language, though they may not be able to master the matter.

*Practical Chemistry. The Principles of Qualitative Analysis.* By W. A. Tilden, D.Sc. (Longmans and Co., 1880.)

OF making books on practical chemistry there is no end. If it were necessary that another should be added to the list, the publication of this little book by Dr. Tilden has surely removed the necessity.

There is no special feature to be noted in this book: it is clearly and accurately written, and proceeds on the well-beaten paths. The adoption of a general table printed on strong paper and protected by cloth backing is to be commended.

It is, we think, doubtful whether anything is to be

gained by attempting to teach mere outlines of the methods for analysis of mixtures; a more thorough grounding in qualitative analysis may, as a rule, be given by limiting the student's work for some time to simple salts—which is not such an extremely easy branch of analysis as may at first sight appear; then proceeding to mixtures of metals with one metal only in each group; then to mixtures of various metals of the same group; and lastly to complex mixtures.

The detection of acids—even of a simple acid—is made, as is usual in elementary text-books, to appear a much less difficult undertaking than it really is.

#### LETTERS TO THE EDITOR

[The Editor does not hold himself responsible for opinions expressed by his correspondents. Neither can he undertake to return, or to correspond with the writers of, rejected manuscripts. No notice is taken of anonymous communications.]

[The Editor urgently requests correspondents to keep their letters as short as possible. The pressure on his space is so great that it is impossible otherwise to ensure the appearance even of communications containing interesting and novel facts.]

#### A Rotatory Polarisation Spectroscope of Great Dispersion

I HAVE just had an opportunity of trying, on a fine aurora, an instrument for measuring the wave-length of monochromatic light in terms of quartz-rotation of its plane of polarisation. My apparatus is, as yet, very roughly put together, so that I got no measurements of any value, but to-night's experience has shown me that the method, while simple in application, is capable of very great accuracy.

The construction of the instrument will be easily understood from the annexed rough sketch. The course of the light is with the arrows. N is a Nicol, S an adjustable slit, L a lens at its focal distance from S, Q a plate of quartz cut perpendicularly to the axis, P a double-image prism, and E a small direct-vision spectroscop, which may be dispensed with when absolutely monochromatic light is to be examined.

When the instrument is properly adjusted by daylight the two images of S formed by P are parts of a straight line, so that E gives two spectra side by side. These are crossed by dark bands, which are numerous in proportion to the thickness of Q, and which move along the spectra as N is made to rotate.

In observing a bright-line spectrum the slit is to be made as wide as possible, subject to the condition that no two of the

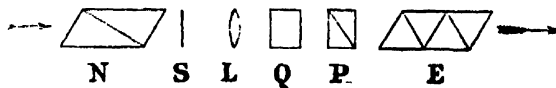

differently-coloured images shall overlap. We have thus a pair of juxtaposed rectangles for each of the bright lines, and the angular positions of N, when the members of the several pairs are equally bright, are read off on a divided head. I find by trial that a division to 2° is quite sufficient.

A first set of readings is taken with a plate Q (permanently fixed in the instrument) 5 or 6 millimetres thick. Then an additional plate of quartz 100 millimetres or more thick is introduced between Q and L, and a second set of readings is taken. From the readings with the thin plate we find approximately the positions of the spectral lines, and the more exact determination is obtained from the readings with the thick plate.

This is the chief feature of the instrument. The actual error of any one reading is not more than 2°, but when a thick plate is used the whole rotation may be from ten to twenty or even thirty circumferences. By thus increasing the thickness of the quartz plate very little additional loss of light is incurred, while the inevitable error forms a smaller and smaller fraction of the whole quantity to be measured.

The graduation of the instrument is to be effected by very careful measurements upon a hydrogen Geissler tube, and comparison with the known wave-lengths of the hydrogen lines.

An observer furnished with this instrument (which is not much larger than a pocket spectroscope) and with a long red of

quartz, will be able to make measurements of any required degree of accuracy.

P. G. TAIT

The Club House, St. Andrews, N.B., August 12

#### Dimorphism of "Nature" on June 17

WITH reference to the statement in an editorial note in NATURE, vol. xxii. p. 317, that one statement of mine "does not accord well" with another, I must request to be allowed to show that this observation is incorrect.

I was told by a friend on July 27 (five weeks after the event) that there had been apparently two issues of NATURE of June 17, and that Prof. Allman was intending to write to NATURE quoting the uncorrected issue (which was unfortunately the one which had been supplied to him) in support of his statement, in NATURE, vol. xxii. p. 218, which I had declared to be a misconception (NATURE, vol. xxii. p. 241), viz., that I differed from him as to the existence of a marginal canal in the new medusa. Accordingly I wrote on July 28 to the editor, requesting him to state, "if necessary," that there had been two issues, and expecting that this explanation would be inserted immediately after Prof. Allman's letter, published in NATURE, vol. xxii. p. 290. The explanation was not, however, given, and it was left to me to write my letter of two days later date (July 30), which was published in NATURE, vol. xxii. p. 316. I had in that two days interval "ascertained" by further evidence that there were actually two issues of No. 555 of NATURE, and my "great surprise" was due to the fact that the editor of NATURE should have allowed Prof. Allman's letter to appear without offering any explanation of the direct opposition between his quotation and mine—the cause of which was well known at the printing office of NATURE.

It is thus clear that my letter of July 30 is consistent with my letter of July 28.

E. RAY LANKESTER

[We willingly give space to the above letter, and, accepting the interpretation of the former one which Prof. Lankester now gives us, we regret having made the observation to which Prof. Lankester alludes. We may further add that the insertion of the reference to the letter in question was due to an oversight.—ED.]

#### Magnetic and Earth-Current Disturbance

IT may be of interest to point out that a magnetic disturbance has just been experienced at the Royal Observatory greater in magnitude than any that has occurred for some years.

On August 11, at 10.30 a.m., active disturbance suddenly commenced, and continued until midnight, accompanied, as usual, by the exhibition of earth currents. The magnets were then generally quiet until about noon of August 12, when disturbances of still greater magnitude began to be shown, continuing till 6 a.m. of August 13. During the latter period the variations in the magnetic declination and horizontal force were frequent and large, especially between noon and 4 p.m., and between 7 and 9 p.m. Between noon and 4 p.m. there was also a considerable increase of vertical magnetic force. During the whole period, from noon of August 12 to 6 a.m. of August 13, earth-currents were continuous and strong, and especially strong at those times at which the magnets were most disturbed.

It seems well at the present time to warn telegraph engineers, and especially those concerned in the laying of submarine cables, that disturbances of the character of that described above may now become not unfrequent as compared with the quietness of recent years. I may perhaps be permitted here to refer to a short paper, "Note on Earth-Currents," to be found at p. 214 of vol. viii. of the *Journal of the Society of Telegraph Engineers*, as containing information on the question of magnetic disturbances and earth-currents, probably not without interest at this time.

WILLIAM ELLIS

Royal Observatory, Greenwich, August 14

P.S.—During the evening and night of August 13–14 large magnetic disturbances again occurred, accompanied as before by strong earth-currents.

#### Aurora Borealis and Magnetic Storms

THE epoch of grand auroras and magnetic storms has again returned, as was evident from the fine displays seen here on the evenings of the 11th and 12th, and these are as usual accom-

panied by an increase in the number and size of the sun-spots, and in the development of the solar prominences. The aurora on the 11th was grand, but that which followed it on the 12th recalled vividly the magnificent displays of 1869, 70, and 71.

On the 12th my attention was first called to the phenomenon at 10h. 25m. p.m., when the northern horizon was skirted by a bright white haze terminating in an ill-defined arch, from which sprang a large number of broad streamers stretching towards the zenith. The bank of white light on the horizon extended from about 15° E. of N. to 45° W. of N., and some of the streamers attained an altitude of fully 60° or 70°. The brilliancy of the individual streamers was varying rapidly, but there was little variety in the character of the phenomenon.

At 10h. 30m. the brightest streamer was 3° W. of N. Ten minutes later this brilliant white band of light had moved gradually westward, and was some 25° W. of N., when it faded away. Some streamers were still more W. of N., and others again were slightly E. of N.

At 10h. 46m. there was nothing remaining of the aurora except a cloudy whiteness in the north, the rest of the heavens appearing a deep blue. A minute later streamers were again appearing.

At 10h. 56m. a very bright streamer formed 2° E. of N., and then a similar band of light appeared 5° W. of N., followed in rapid succession by other streamers 10°, 20°, and 45° W. of N., each streamer fading away before the succeeding one became very bright.

At 11h. 0m. a single narrow band of intense white light stretched from the horizon towards the zenith, passing through Cor Caroli.

At 11h. 7m. the light in the N. and N.N.W. again brightened up, but there was no further appearance of streamers.

The magnetic storm that accompanied the aurora of the 12th was one of the most violent ever recorded at this observatory, and was very similar in character to the magnificent storm of 1869.

On the evening of the 11th the magnetic needle was very irregular in its movements, but it was only towards midday of the 12th that the storm really began. The oscillations from the beginning were very rapid and extensive. The first great movement began at 11h. 34m. a.m., and between 12h. 18m. and 12h. 24m. the declination magnet moved 1° 6' 45" eastward. It then returned westward, and at 1h. 4m. the reading had increased by 1° 18' 13". Between 7h. 9m. and 7h. 29m. p.m. the needle moved 59' 18" eastward, when it attained its minimum; it then returned quickly towards the west, and after a double sweep it reached its maximum at 8h. 13m., the change of declination in 46m. being 1° 27' 23".

The oscillations of the V.F. magnet were as great as those of the declination. The chief maximum occurred at 3h. 40m. p.m., and there were three decided minima at about 10 p.m. midnight and 2 a.m., the two latter of which were lost from the oscillation being too great to be recorded on the photographic cylinder, and the first showing a change of 1.9 inch of ordinate in 5m.

The variation of the H.F. magnet was very large, but not so remarkable as that of the V.F.

On the 13th the magnetic storm continued greatly to disturb all the magnets, but it was less violent than on the preceding day.

Stonyhurst Observatory, August 15

S. J. PERRY

THERE was a beautiful display of the aurora here last night. Between ten and eleven o'clock the streaks extended from the horizon to the zenith. The colour was principally pale blue, but a reddish tinge was occasionally discernible. I observed what I thought was a lateral movement of some of the streaks. A bright spot suddenly made its appearance to the westward of a small black cloud, seemed to move slowly eastward and disappear. There was a slight breeze from the east at the time, but I do not think that the clouds were moving sufficiently rapidly to account entirely for the phenomenon.

J. A. B. OLIVER

Springburn, Glasgow, August 13

A FINE display of aurora was visible here on the night of Thursday, August 12, about 10.30. White streamers, stretching vertically from the horizon nearly to the zenith, occupied the north-west segment of the heavens from the pole to Arcturus. There was a narrow bank of cloud along the horizon, and I thought at first that the streamers might be shadow-phenomena from the sun; but the hour was too late, and the rapid variations of form and

intensity were characteristic of aurora, which is not very common at this season of the year, I think.

Birstal Hill, Leicester, August 13

F. T. MOTT

We had a fine aurora here last night (11th). There was a bright bank of uniform glow till 11 p.m., when it suddenly broke into streamers, some of which reached 40° or 45° in height, the glow extending along 100° or 120° of the horizon. There was no colour, and by midnight it had all faded out.

Whitby, August 12

B. W. S.

#### Height of the Aurora

I SHALL be glad if you will allow me the use of your columns to point out that there is really less uncertainty about this element than is usually supposed, and that there are two methods of measuring auroral heights which give accordant results. The first is that based upon the measurements of the altitude and amplitude of auroral arches, and which gives the results mentioned by Mr. Rand Capron. That these results should have so wide a range is probably owing to the fact that they proceed upon an assumption which may or may not be correct, viz., that the arch is part of a circle having the magnetic pole for its centre. Still the mean result from this method would seem to be reliable, especially if care were taken to exclude doubtful measurements from the list. Possibly we may assume that this method gives a height not far from 100 miles for the ordinary arch. I speak particularly of the white auroral arch with or without uncoloured streamers that forms, I suppose, 95 per cent. of the auroral phenomena visible in this country. These arches are formed for the most part over a portion of the earth considerably to the (magnetic) north of these islands, but occasionally they would seem to be formed over our heads. Mr. Capron in his work on "Aurora and their Spectra" mentions one such instance, though he appends no explanation of the phenomenon, but in the course of ten years' observations I have myself seen three such arches. Indeed they are perfectly well known to observers in Scotland and the north of England, though I have never seen them in the south. As early as the year 1843 the height of these zenithal arches had been trigonometrically computed from observations made in different localities in Britain, with the result of proving them to be at an uniform height of 70 to 74 miles above the earth.<sup>1</sup> There is much less liability to error in these results than in the determination of the height of a meteor, and a single pair of satisfactory observations will yield a value within one or two miles of the actual elevation.

That auroral arches are ever formed much below this limit I beg leave to doubt. I am aware of the accounts which would place them between the eye and natural objects, but such assertions are far from having the weight of accurate measurements, and I have yet to find a case of a supposed low aurora, the evidence of which is above criticism.

I do not wish to assert that the streamers at right angles to these arches may not be frequently visible at a *less* height, just as they undoubtedly reach to a much *greater* elevation in the region where the auroral crown is formed. But to fix either the superior or inferior limit is precisely one of those questions which we can have no hope of solving by direct measurement, since the length of the streamer varies with the force of electric discharge. This is shown by the fact that in an active aurora some streamers extend only a short distance from the arch, while others will climb up to the vanishing point, or crown.

To carry these remarks so as to include the question of coloured aurora would oblige me to trespass more upon your space than I am willing to do on this occasion.

Orwell Park Observatory, Ipswich

JOHN I. PLUMMER

#### Fire-Ball

ON the evening of the 12th a very brilliant fire-ball fell at 8h. 30m. G.M.T. It was first observed at an elevation of about 25° above the E.S.E. horizon, and its path was inclined at an angle of about 35° to the horizon. It was lost in the mist near the south horizon. There was no explosion or noise of any kind. The daylight was still fairly strong, and yet the light of the meteor was very dazzling.

S. J. PERRY

Stonyhurst Observatory, August 15

<sup>1</sup> I give these figures from memory, as I have no library at hand to which to refer, but I have no doubt that they are strictly correct. Mr. Capron may perhaps find some information on the point in the published works of the late Prof. Phillips, who was one of the observers engaged in these investigations about the date I have named, or they may be verified upon the first appearance of the aurora.

#### Atmospheric Phenomenon

A CURIOUS phenomenon was observed here after sunset the night before last, and again in a less degree last night.

Looking across from this point to the position of the sun at and after setting, the line of sight crosses about three miles of sea, then about the same distance or rather less of projecting high ground, and beyond that many miles of sea again. On Tuesday (10th) the sun set in a hot haze, and half an hour after there appeared on the edge of the projecting land what looked like tongues of flame fifteen to thirty minutes in height, lasting from two to four seconds each, and then disappearing in different places, sometimes half a dozen at a time. At the same time there was more or less of a flickering light along the whole line of projecting land.

My first impression was that it was an optical illusion, and the second that a moor was on fire behind the ridge, and that these were points of flame. The first was negated by the fact that four others beside myself (two of them with very keen sight) saw the lights independently in the same places; and the second by the gradual fading of the light as the evening became darker, the "tongues" retaining pretty much their relative brightness to the general glow until both faded out.

The day had been extremely hot, and the evening was sultry, with motionless air. I imagine the appearance was due to irregular refraction, arising from heated currents of air from the cooling land, and that the circumstance of the *slice* of land with its currents occurring between the two stretches of homogeneous air over the sea allowed the effect to be seen without being masked, as it would have been had there been intervening land. But I never saw it before, and don't remember to have seen it described.

B. W. S.

Whitby, August 12

#### Intellect in Brutes

INSTINCT apart, cases of intelligence in animals are very numerous, of the affections still more numerous. Comte was of opinion that the affections were even more highly developed in animals than in men. The dog will lay down life for the man he loves, the horse will do so likewise. We have all heard of Greyfriars Bobby, if that be the creature's name. But instances crowd on the memory. A few years back, during a heavy gale, a sweep of the spanker-boom drove the master of a Leith and London smack into the sea. Instantly the ship's dog bounded in after, and, sustaining the drowning man, both passed grandly into the eternities together. I have known cats who let themselves into the dwelling-house at pleasure, and at least three dogs who were wont to deposit the pennies given them on the counter of some baker or pastry-cook in return for values received. I used to meet on the highway a dog who rode behind his master's groom. The hardest trot never seemed to discompose his seat. Even birds—not merely trained birds—sometimes display singular attainments. I knew a lady who had a singing duck, but being one day at a loss for a couple, she sacrificed the songstress to make up a pair. One wishes that she had displayed a little more humanity; as also a clergyman, not a hundred miles from where I sit, who ordered a goose that had evinced the warmest attachment to be slain by reason of the poor bird having followed him on the occasion of paying a visit into a friend's drawing-room.

When a boy I used to spend many a holiday at a farmer's house in the County Armagh. I there experienced great kindness, enjoying myself as much as was well possible in the open air, the garden, and the stubble fields. Besides human beings, I had numerous playmates too in the kine, swine, dogs, fowl, horned cattle, and horses about the place, and indeed was never tired in observing their modes of living and acting. The great house-dog used often to play with a large hog. They alternately chased and faced one another till the hog's chaps would froth again actually with the excitement of the sport. At first I supposed that the pig did not like it, but in this I was mistaken. One day a strange dog, an immense brute, made his appearance, and attacked the house-dog, who was evidently getting the worst of it, when who should come to the rescue but the hog, who instantly jumped on the strange dog's back, assailing him at the same time with hoof and tooth. Placed thus between two fires, the stranger beat a speedy retreat, leaving the friends complete masters of the situation.

I think I was about ten years old when my parents resided at a place called Fairlawn, situated on a gentle eminence

Charlemont. Facing the house, a stone's throw or two in front of the lawn, was a river called the Tall, which ran into the close-at-hand Callan, which again ran into the Black Water, which, in turn, emptied itself into that immense puddle which bears the name of Lough Neagh. The waters of Lough Neagh, unable, by reason of the obstructions in the Lower Bann, to escape rapidly enough into the sea, swell up and cause backwater in the rivers I have named, and others as well. The result is the periodic flooding of thousands and tens of thousands of acres of valuable land, to the immense prejudice of the occupants and country at large. The Tall, I should observe, was banked or dyked up on both sides. In some places, however, the dyke had given way, so that at flood-time—and it was flood-time at the period I speak of—the waters of the Tall were awash with those of the flooded meads on both sides. There was further a rapid current in the Tall, and before it merged into the Callan the stream had to pass under the arch of a bridge which it filled to the crown. In fact the battlements themselves were nearly covered, and the country, as far as the eye could reach from the position which I at the moment occupied at the foot of the lawn, wore the aspect of a sea. At this precise juncture two horses, whilom occupants, I presume, of the then flooded meads, were to be seen slowly wading in the direction of the Tall. The green summit of the dyke was for the most part visible, and upon this the poor brutes mounted, in quest, I suppose, of some outlet. They had not gone very far when, owing to the treacherous footing, one of the horses lost his balance and fell, rolling over and over into the Tall. He swam on bravely, the other horse stretching down at intervals a sympathising muzzle, making indeed repeated efforts to escape, but falling back each time into the surging current. I was alone, surveying the transaction, from which I never removed my eyes, with the deepest interest. All at once the horse that was on the dyke, keeping pace at a sort of half-trot with the other, burst into a hand-gallop, and when he had got sufficiently beyond his struggling comrade, bounded himself into the Tall. Swimming briskly onwards for a few fathoms, he then made his way out through what he must have seen beforehand was a practicable breach in the dyke, followed on the instant by his friend, evading, not a moment too soon, the submerged bridge, where they would have otherwise inevitably gone under. So long as my eyes could follow them they dashed onwards at a gallop, throwing up their exultant heels and flourishing their tails across the flooded meadows. It is now many years since I beheld this astonishing spectacle, which my memory recalls as freshly as if it had happened yesterday, awakening, as I think it is well calculated to do, serious reflections in regard of our mysterious associates and the wondrous Power which has called them into being, and now sustains them and ourselves alike in this transitory state which we term life.

HENRY MACCORMAC

Belfast, August

#### Radiation.—A Query

In Baily's experiments with the torsion-rod and two leaden balls weighing 380½ pounds each, it was found that the radiation of heat from the leaden masses affected the vibrations of the torsion-rod. These masses were thereupon gilded, and the torsion-rod protected by a gilt box covered with thick flannel, and the disturbing influence overcome. How did radiation affect the motion of the torsion-rod? F. G. S.

#### "On a Mode of Explaining the Transverse Vibrations of Light"—The Expression "Radiant Matter"

WITHOUT wishing at all to underrate the apparent difficulty noticed by your New Zealand correspondent, Mr. J. W. Frankland (*NATURE*, vol. xiii. p. 317) in regard to my paper under the above heading (*NATURE*, vol. xxi. p. 256), as it would be against the interests of truth to do so; I may nevertheless call his attention to a letter of mine (*NATURE*, vol. xxi. p. 369), where an attempt is made to meet the difficulty in question. The point is to account for the circumstance (admitting that it is rendered necessary by physical evidence) that the velocity of propagation of gravity must, at least, be very much greater than that of light. I will merely confine myself here to recapitulating one of the main conclusions in a somewhat different form, viz., it appears to be necessary to look to a separate medium for gravity, or (more accurately) to one medium with particles of two grades of dimensions; the one set of particles having very

minute mass, and consequently enormous velocity, and concerned in the effects of gravity; the other set, of much greater mass and slower velocity, concerned in the phenomena of light. It will, I think, be so far tolerably evident that if the number of the more minute set of particles be comparatively very great, the pressure produced by them would be correspondingly great, and therefore these particles would be mainly (*i.e.*, almost exclusively, if their number were sufficiently great)<sup>1</sup> concerned in producing gravity. On the other hand, on account of the extreme velocity of these particles, they could not apparently be appreciably concerned in the phenomena of light, since the molecules of gross matter would vibrate among them without appreciable resistance. For it is a well-known dynamical fact that the resistance opposed to the motion of a body in a medium *diminishes* as the velocity of the particles of the medium increases. It may be worth observing perhaps that this idea of three grades of dimensions in matter (*viz.* gross matter, light-carrying matter, and gravific matter) appears to be an old one. Thus a book was published in 1827 by Dr. Blair, formerly Regius Professor of Astronomy in the University of Edinburgh, entitled "Scientific Aphorisms" (to which my attention was called by Prof. Tait), where the idea of three grades of dimensions in matter is set forth, and a theory of gravity very similar to that of Le Sage expounded. Also M. Prevost ("Deux Traités de Physique mécanique") expresses, I believe, the view that matter exists fundamentally in three grades of magnitude.

It may be rather a curious fact to notice that if the theory, that the æther consists merely of finely sub-divided matter in the ultra-gaseous state, light being regarded as a vector property carried off by the atoms in their passage through the open structure of the vibrating molecules of gross matter, as suggested by the late Prof. Clerk Maxwell, article "Æther," new edition of the "Encyclopædia Britannica" (*i.e.*, with range of free path greater than planetary distance, *NATURE*, vol. xxi. p. 256),<sup>2</sup> should ultimately turn out to be substantially true; then the term "radiant matter," employed by Mr. Crookes in connection with his experimental researches, would have its practical application in nature on a large scale—or light would be actually propagated by "radiant matter." If, on an examination of the theory in that spirit of good-humoured impartiality representing entire freedom from the predilections of any school of thought (the best guarantee of truth)—the difficulties attaching to it should not be considered insurmountable; then it may be worth remarking that the theory, without violating in the least the essential principles of the firmly-established undulatory theory, contains nevertheless (in its corpuscular essence) one of the ideas of Newton; so that it would appear that the latter might not have been entirely wrong, nor the upholders of the opposite view completely right, but that a partial reconciliation of their rival ideas might be possible.

S. TOLVER PRESTON

London, August 10

#### Earthquake in Smyrna

ACCOUNTS are freely coming forward, but they are of popular interest, seismological details being scanty. I must premise that in 1862 I took great interest in promoting Abyssinian wells in Smyrna, and that large numbers were put down. When the French Company built the quay the new works there were similarly supplied, and the result has been that for some years the surface and pipe-wells in the parallel Marina and Frank Streets have been wanting in water.

Within a few hours after the earthquake it was noticed that both classes of wells, say 600 feet from the sea, were freely supplied with water. This fact appears to me deserving of record.

It is said that the earthquake was most felt near the Greek Cathedral of St. Photius, at the Three Corners in Frank Street. It was here the ground opened in the last century earthquake and swallowed up two men, as I heard by tradition; and I always walked across the churchyard in full remembrance.

Of late years some kind of a landslip took place on Mount Pagus, or the Castle Hill, where Alexander the Great fell asleep.

<sup>1</sup> It may be worth noting in connection with this that (according to a principle developed by Sir W. Thomson, *Phil. Mag.*, May, 1873) it appears that if the "elastic rigidity" of the larger particles were such that they suffered no appreciable diminution of velocity at rebound from gross matter, they would not be appreciably concerned in the effects of gravity, if their number were comparable to that of the smaller set of particles.

<sup>2</sup> Also previous papers by the present writer (on the same subject) *Phil. Mag.*, September and November, 1877, February, 1878, April and May, 1880.

In this new earthquake springs are said to have burst out on the side of Mount Sipylos.

HYDE CLARKE

32, St. George's Square, S.W., August 9

### New Biological Term

IN writing certain parts of a book on water-beetles, I find myself frequently desirous of indicating briefly but emphatically that some particular genus I may be mentioning consists of only a single species. If we take a rational or theoretical view of classification rather than an empirical one, it must be admitted that a genus consisting of only one species is almost as great an anomaly as a species that should consist of a single individual; and a special term to indicate the fact would be desirable. Mr. Pascoe has suggested to me that the expression "monotypical genus" meets the want: but I am not satisfied with this, for in the first place it is a phrase, not a word; and in the second place the use of the "typical" interferes with concentration of thought by the introduction of an alien suggestion. I therefore propose to use either the word "autogenus" or the word "monogenus" for the purpose, and on the whole prefer the former. Perhaps some one else may be able to suggest a better term, and I shall be very glad of an expression of opinion on the point.

Thornhill, Dumfriesshire

D. SHARP

### Depraved Taste in Animals

YOUR correspondent, Mr. Nicols, draws attention this week to what he terms the "depraved taste" for tobacco exhibited by several individuals of that species of Phalangistidæ known as the koala.

Whilst in Australia some years ago I myself remarked the same propensity amongst numerous wild specimens of the *Pharcolarcus cinereus*, in an abandoned tobacco-clearing not far from my residence, and, like Mr. Nicols, I also observed that no ill effects seemed to follow the consumption of the tobacco by the Koalæ. Now since the Phalangistidæ I had the opportunity of observing were perfectly wild, I cannot agree with Mr. Nicols that their taste for tobacco is a depraved one, although the desire for spirits which he mentions is of course decidedly unnatural.

These observations induced me to make several analyses of the Victorian tobacco, with the result of isolating an hitherto undiscovered vegetable alkaloid. A detailed account of my various experiments is contained in a paper read by me before the Melbourne Medical and Chemical Society, and printed in the fourteenth volume of the Society's *Transactions*.

F. R. GREENWOOD

St. Bartholomew's Hospital, E.C., August 14

### Firing a Tallow Candle through a Deal Board

WILL the writer of "Physics without Apparatus" be good enough to specify the conditions of success for the above experiment?

C. J. WOODWARD

Birmingham and Midland Institute, August 9

[Set up a  $\frac{1}{2}$ -inch or  $\frac{3}{4}$ -inch plank of deal in the ground. It should be 6-8 inches wide. Ram small charge of gunpowder into gun with wad. Select a *dip* candle just fitting bore; cut down to about 5 inches long, with flat end. Be very particular to ram it down well; for if there is air space between it and the wad there is risk of bursting gun. Take care that the rest of barrel is cleared of bits of tallow. Fire at say 3 yards from plank. If you don't miss aim, there will be a hole *torn*, about 2 inches in diameter.—The WRITER of "Physics without Apparatus."]

✓-1 must send his name and address.

## THUNDERSTORMS<sup>1</sup>

### II.

BEFORE I can go farther with this subject it is necessary that I should give some simple facts and illustrations connected with ordinary machine electricity. These will enable you to follow easily the slightly more

<sup>1</sup> Abstract of a lecture, delivered in the City Hall, Glasgow, by Prof. Tait. Continued from p. 341.

difficult steps in this part of our subject which remain to be taken.

Since we are dealing mainly with *motion* of electricity, it is necessary to consider to what that motion is due. You all know that winds, *i.e.* motions of the air, are due to differences of pressure. If the pressure were everywhere the same at the same level we should have no winds. Similarly the cause of the motion of heat in a body is difference of temperature. When all parts of a body are at the same temperature there is no change of distribution of heat. Now electricity presents a precisely analogous case. It moves in consequence of difference of *potential*. Potential, in fact, plays, with regard to electricity, a part precisely analogous to the *role* of pressure, or of temperature, in the case of motions of fluids and of conducted heat. Now the power of an electrical machine may be measured by the utmost potential it can give to a conductor. The greater the *capacity* of the conductor the longer time will be required for the machine to charge it; but no electricity passes between two conductors charged to the same potential. Hence the power of a machine is to be measured by using the simplest form of conductor, a sphere, and finding the utmost potential the machine can give it. It is easily shown that the potential of a solitary sphere is directly as the quantity of electricity, and inversely as the radius. Hence electricity is in equilibrium on two spheres connected by a long thin wire when the quantities of electricity on them are proportional—not to their surfaces, nor to their volumes, as you might imagine—to their radii. In other words, the capacity is proportional to the radius. This, however, is only true when there are no other conductors within a finite distance. When a sphere is surrounded by another concentric sphere, which is kept in metallic connection with the ground, its capacity is notably increased, and when the radii of the spheres are nearly equal the capacity of the inner one is directly as its surface, and inversely as the distance between the two spheres. Thus the capacity is increased in the ratio of the radius of one sphere to the difference of the radii of the two, and this ratio may easily be made very large. This is the principle upon which the Leyden jar depends.

It is found that the work required to put in a charge is proportional to the square of the charge. Conversely, the damage which can be done by the discharge, being equal to the work required to produce the charge, is proportional to the square of the charge, and inversely to the capacity of the receiver. Or, what comes to the same thing, it is proportional to the square of the potential and to the capacity of the conductor directly. Thus a given quantity of electricity gives a greater shock the smaller the capacity of the conductor which contains it. And two conductors, charged to the same potential, give shocks proportional to their capacities. But in every case, a doubling of the charge, or a doubling of the potential, in any conductor, produces a fourfold shock.

The only other point I need notice is the nature of the distribution of electricity on a conductor. I say *on* a conductor, because it is entirely confined to the surface. Its attractions or repulsions in various directions exactly balance one another at every point in the *substance* of the conductor. It is a most remarkable fact that this is always possible, and in every case in one way only. When the conductor is a single sphere the distribution is uniform. When it is elongated the quantity of electricity per square inch of its surface is greater at the ends than in the middle; and this disproportion is greater the greater is the ratio of the length to the transverse diameter. Hence on a very elongated body, terminating in a point, for instance, the electric density—that is, the quantity per square inch of surface—may be exceedingly great at the point while small everywhere else. Now in proportion to the square of the electric density is the outward pressure of the electricity tending to escape by forcing a passage



through the surrounding air. It appears from experiments on the small scale which we can make with an electrical machine, that the electric density requisite to force a passage through the air increases under given circumstances, at first approximately as the square root of the distance which has to be traversed, but afterwards much more slowly, so that it is probable that the potential required to give a mile-long flash of lightning may not be of an order very much higher than that producible in our laboratories.

But from what I have said you will see at once that under similar circumstances an elongated body must have a great advantage over a rounded one in effecting a discharge of electricity. This is easily proved by trial. [The electric machine being in vigorous action, and giving a rapid series of sparks, a pointed rod connected with the ground was brought into the neighbourhood, and the sparks ceased at once.] In this simple experiment you see the whole theory and practical importance of a lightning conductor. But, as a warning, and by no means an unnecessary one, I shall vary the conditions a little and try again. [The pointed rod was now insulated, and produced no observable effect.] Thus you see the difference between a proper lightning-rod and one which is worse than useless, positively dangerous. There is another simple way in which I can destroy its usefulness, namely, by putting a little glass cap on the most important part of it, its point, and thus rendering impossible all the benefits it was originally calculated to bestow. [The pointed rod was again connected with the ground, but furnished with a little glass cap. It produced no effect till it was brought within four or five inches of one of the conductors of the machine, and then sparks passed to it.] You must be strangely well acquainted with the phases of human perversity if you can anticipate what I am now going to tell you, namely, that this massive glass cap, or *repeller*, as it was fondly called, was only a year or two ago taken off from the top of the lightning-rod employed to protect an important public building. [The repeller was exhibited. It resembled a very large soda-water bottle with a neck much wider than the usual form.] From the experiments you have just seen it must be evident to you that the two main requisites of an effective lightning-rod are that it should have a sharp point (or, better, a number of such points, lest one should be injured), and that it should be in excellent communication with the ground. When it possesses these, it does not require to be made of exceptionally great section; for its proper function is *not*, as is too commonly supposed, to parry a dangerous flash of lightning: it ought rather, by silent but continuous draining, to prevent any serious accumulation of electricity in a cloud near it. That it may effectually do this it must be thoroughly connected with the ground, or (if on a ship or lighthouse) with the sea. In towns this is easily done by connecting it with the water mains, at sea by using the copper sheathing of the ship, or a metal plate of large surface fully immersed. Not long ago a protected tower was struck by lightning. No damage was done in the interior, but some cottages near its base were seriously injured. From a report on the subject of this accident it appears that the lower end of the lightning rod was "jumped" several feet into the solid rock! Thus we see, in the words of Arago, how "False science is no less dangerous than complete ignorance, and that it *infallibly* leads to consequences which there is nothing to justify."

That the lightning-rod acts as a constant drain upon the charge of neighbouring clouds is at once proved when there is, accidentally or purposely, a slight gap in its continuity. This sometimes happens in ships, where the rod consists of separate strips of metal inlaid in each portion of the mast. If they are not accurately fitted together, a perfect torrent of sparks, almost resembling a continuous arc of light, is seen to pass between them whenever a thunderstorm is in the neighbourhood.

I cannot pass from this subject without a remark upon the public as well as private duty of having lightning-rods in far greater abundance than we anywhere see them in this country. When of proper conducting power, properly pointed, properly connected with the ground and with every large mass of metal in a building, they afford absolute protection against ordinary lightning—every single case of apparent failure I have met with having been immediately traceable to the absence of one or other of these conditions. How great is their beneficial effect you may gather at once from what is recorded of Pietermaritzburg, viz., that till lightning-rods became common in that town it was constantly visited by thunderstorms at certain seasons. They still come as frequently as ever, but they cease to give lightning-flashes whenever they reach the town, and they begin again to do so as soon as they have passed over it.

A knight of the olden time in full armour was probably as safe from the effects of a thunderstorm as if he had had a lightning-rod continually beside him; and one of the Roman emperors devised a perfectly secure retreat in a thunderstorm in the form of a subterranean vault of iron. He was probably led to this by thinking of a mode of keeping out missiles, having no notion that a thin shell of soft copper would have been quite as effective as massive iron. But those emperors who, as Suetonius tells us, wore laurel crowns or sealskin robes, or descended into underground caves or cellars on the appearance of a thunderstorm, were not protected at all. Even in France, where special attention is paid to the protection of buildings from lightning, dangerous accidents have occurred where all proper precautions seemed to have been taken. But on more careful examination it was usually found that some one essential element was wanting. The most common danger seems to lie in fancying that a lightning-rod is necessarily properly connected with the earth if it dips into a mass of water. Far from it. A well-constructed reservoir full of water is *not* a good "earth" for a lightning-rod. The better the stonework and cement the less are they fitted for this special purpose, and great mischief has been done by forgetting this.

A few years ago the internal fittings of the lighthouse at Skerryvore were considerably damaged by lightning, although an excellent lightning-rod extended along the whole height of the tower.

The real difficulty in these situations, exposed to tremendous waves, lies in effecting a permanent communication between the lightning-rod and the sea. But when this is done the sea makes far the best of "earths."

When a lightning-rod discharges its function imperfectly, either from insufficient conducting power or because of some abnormally rapid production of electricity, a luminous brush or glow is seen near its point. This is what the sailors call St. Elmo's Fire, or Castor and Pollux. In the records of mountain climbing there are many instances of such discharges to the ends of the alpenstocks or other prominent pointed objects. One very remarkable case was observed a few months ago in Switzerland, where at dusk, during a thunderstorm, a whole forest was seen to become luminous just *before* each flash of lightning, and to become dark again at the instant of the discharge.

Perhaps the most striking of such narratives is one in the memoirs of the Physical and Literary Society of Edinburgh, on Thunder and Electricity, by Ebenezer McFait, M.D.

The destructive effects of lightning are familiar to all of you. All the more ordinary effects can easily be reproduced by the help of Leyden jars on a small scale. How small you may easily conceive when I tell you that a three-foot spark is considered a long one, even from our most powerful machines, while it is quite certain that lightning flashes often exceed a mile in length, and sometimes extend to four and five miles. One recorded observation,

by a trustworthy observer, seems to imply a discharge over a total length of nearly ten miles.

When a tree is struck by a violent discharge it is usually split up laterally into mere fibres. A more moderate discharge may rupture the channels through which the sap flows, and thus the tree may be killed without suffering any apparent external damage. These results are usually assigned to the sudden vaporisation of moisture, and the idea is probably accurate, for it is easy to burst a very strong glass tube if we fill it with water and discharge a jar by means of two wires whose extremities are placed in the water at a short distance from one another. The tube bursts even if one end be left open, thus showing that the extreme suddenness of the explosion makes it act in all directions, and not solely in that of least resistance. When we think of the danger of leaving even a few drops of water in a mould into which melted iron is to be poured, we shall find no difficulty in thus accounting for the violent disruptive effects produced by lightning.

Heated air is found to conduct better than cold air, probably on account of the diminution of density only. Hence we can easily see how it is that animals are often killed in great numbers by a single discharge, as they crowd together in a storm, and a column of warm air rises from the group.

Inside a thundercloud the danger seems to be much less than outside. There are several instances on record of travellers having passed through clouds from which, both before and after their passage, fierce flashes were seen to escape. Many remarkable instances are to be found in Alpine travel, and specially in the reports of the officers engaged in the survey of the Pyrenees. Several times it is recorded that such violent thunderstorms were seen to form round the mountain on which they were encamped, that the neighbouring inhabitants were surprised to see them return alive.

Before the use of lightning-rods on ships became general great damage was often done to them by lightning. The number of British ships of war thus wholly destroyed or much injured during the long wars towards the end of the last and the beginning of the present century is quite comparable with that of those lost or injured by gales, or even in battle. In some of these cases, however, the damage was only indirectly due to lightning, as the powder magazines were blown up. In the powder magazine of Brescia, in 1769, lightning set fire to over 2,000,000 lbs. of gunpowder, producing one of the most disastrous explosions on record.

A powerful discharge of lightning can fuse not only bell wires, but even stout rods of iron. It often permanently magnetises steel, and in this way has been the cause of the loss of many a good ship; for the magnetism of the compass-needles has been sometimes destroyed, sometimes reversed, sometimes so altered that the compass pointed east and west. And by the magnetisation of their steel parts the chronometers have had their rates seriously altered. Thus two of the sailor's most important aids to navigation have been simultaneously rendered useless or, what is worse, misleading; and this, too, at a time when, because of clouds, astronomical observations were generally impossible. All these dangers are now, however, easily and all but completely avoidable.

A very singular effect of lightning sometimes observed is the piercing of a hole in a conducting-plate of metal, such as the lead-covering of a roof. In such a case it is invariably found that a good conductor well connected with the ground approaches near to the metal sheet at the part perforated.

(To be continued.)

#### HUMAN HYBERNATION

DR. TANNER is scarcely off the field when another physiological wonder breaks out in the form of a sleeping girl of Grambke, near to Bremen. This young

lady lies, it is said, in a profound slumber night and day, resting on her left side and never asking for food, but swallowing liquid food when it is put into her mouth. The trance lasts an average of fifty days, during which time she is pale, but does not lose in weight. Her sleep is not cataleptic in the proper sense of the term, inasmuch as she is sufficiently conscious to swallow, and presents none of the indications of death. She merely sleeps. Instances of this kind are not so uncommon as those of true catalepsy, though some of them are sufficiently remarkable. In the *Transactions* of the Royal Society Dr. W. Oliver has recorded the history of an extraordinary sleeping person named Samuel Chilton of Tinsbury, near Bath, who, on May 13, 1694, being then "of robust habit of body, not fat, but fleshy, and a dark brown hair," happened, without any visible cause or evident sign, to fall into a very profound sleep, out of which no art used by those who were near him could rouse him until after a month's time; then he rose of himself, put on his clothes, and went about his business of husbandry as usual; slept, could eat and drink as before, but spoke not one word till about a month after. In 1696, on the 9th of April, this youth fell off to sleep again, and although a heroic apothecary, Mr. Gibbs, bled him, blistered him, cupped him, and scarified him, he slept on for seventeen weeks, waking up on August 7, not knowing he had slept above a night, and unable to be persuaded he had lain so long, until going out into the fields he found everybody busy getting in the harvest, and then remembered very well that when he fell asleep they were sowing of the barley and oats which he now saw ripe and ready to be cut down. For six weeks of this sleep he had fasted, but after he awoke he went to work in his ordinary way, and continued to work until August 17, 1697, when, after complaining of shivering and cold in his back, and vomiting once or twice, he fell into one of his long sleeps once more, and being visited by Dr. Oliver and many others, was subjected to further bleeding and extremely sharp treatment indeed, but without being roused. So he lay sleeping until November 19, when he awoke, said he "felt very well, thank God," ate some bread and cheese, and dropping off still another time, slept on until the end of January, 1698, and "then waked perfectly well, not remembering anything that happened all this while." He was observed to have lost flesh, but only complained of being pinched by the cold, and presently fell to husbandry as at other times. The known phenomenon that is nearest to this is hybernation in some of the inferior animals; but it is worthy of remark that the persons affected take food unconsciously when it is offered them, the lower nervous centres seeming to remain in a continued state of activity.

#### PHYSICS WITHOUT APPARATUS<sup>1</sup>

##### III.

THE laws of the behaviour of liquids, their pressure and their flow, are very readily demonstrated without special apparatus by the aid of simple articles of everyday use. First amongst the laws of liquid pressure comes the all-important principle that the pressure exerted by a liquid at any point is proportional to the depth, below the surface, of the point under consideration. This pressure is exerted upwards or downwards according to circumstances. We can show first a case of pressure exerted in an upward direction. Take the glass chimney of a lamp, that of a paraffin-lamp will answer, though the straighter form of chimney used in an Argand or a Silber lamp is preferable. Cut out with a pair of scissors a circular disk of stout cardboard, and attach a thread to it by means of a drop of sealing-wax. Provide yourself also with a deep dish of water. Such a glass trough as is

<sup>1</sup> Continued from p. 345.

used for a drawing-room aquarium will answer capitally for this purpose; but if no deep glass vessel is available, a pan or tub of stone-ware or of tin-ware will serve the purpose. The disk of card should be pressed against the lower end of the lamp-chimney (as in Fig. 8) by pulling up the thread through the glass tube. If it is then lowered into the water in the glass trough, the upward force of the water outside pressing up against the card disk will keep it against the end of the lamp-glass. The deeper it is plunged the more tightly it is pressed up against the end of the tube, for the pressure of the liquid becomes greater and greater as the depth of the disk below the surface is increased. A case of downward pressure is even more simply shown. Take the lamp-chimney in your hand and hold it vertical as before, and fix to the lower end another disk of card, this time fixing it to the bottom of the glass by means of soft bees'-wax or of a little stiff tallow. Now pour in some water from above. At first the disk is held on by the wax, and you may pour in water until the chimney is perhaps half full. But as you go on pouring in water the

on opening a tap in a lower storey the water rushes out with very great force, so great, perhaps, that we cannot



depth of the water inside gets greater and greater, and the pressure exerted by the column of liquid becomes also greater, until the adhesive force of the wax is overcome, and the water bursts off the card and rushes out. This second experiment may be combined with the first one, as is shown in Fig. 8. After having lowered the empty lamp-chimney closed by the card disk into the rough of water, slowly pour in water into the inside. As long as the level of the water *outside* is higher than that of the water *inside*, the outer pressure upwards will be greater than the inner pressure downwards; but as soon as enough water has been poured in to raise the inner level to that outside, the internal and external pressures will be equal, and when a few more drops are added inside the card will be forced away. The fact that liquid pressure depends upon the height of the column of liquid that is pressing, is made familiar to us in the arrangements for supplying our houses with water; for when the cistern is at the top of the house we find that



FIG. 9.

possibly stop it with our hand, however tightly we press it against the mouth of the tap.



Another important law of liquid pressure, not so easy of illustration without apparatus, is the famous principle

of Pascal, that when a liquid is put into a closed vessel, and then subjected at any point to a pressure, this pressure is transmitted equally in all directions. If the vessel be a strong one and provided with two movable pistons, a large and a small one, the area of the large piston being many times as great as that of the small one, any pressure exerted upon the small piston to the liquid will be transmitted equally over equal amounts of surface, and hence the total pressure on the large piston will be many times as great as the original force, just in proportion as its area is greater than that of the small piston. This is, in fact, the principle applied in the hydraulic press of Bramah and in the hydraulic machinery of Sir W. Armstrong, by which heavy bridges, dock-gates, and elevators are set in motion. The writer of this article, when sore-pressed to devise an experimental illustration of the principle of the hydraulic press, contrived the following arrangement. The lid of a coffee-pot was removed and a piece of sheet-indiarubber was tied tightly over the open top. Into the spout a piece of lead-pipe about six feet long was inserted, firmly fixed with sealing-wax, and then turned up vertically. The pot was filled with water, and a heavy book placed upon the top. Water was poured into the lead tube until it was filled up to the top. A column of water six feet high affords a pressure of nearly three pounds per square inch, and this, exerted over the whole area of the rubber-covered top, gave a sufficient total pressure to raise the heavy book.

The air also possesses weight, and exerts a pressure which may be upwards or downwards according to circumstances. Let a wine-glass or a tumbler be filled full of water and a thin card laid upon the top of it, so that bubbles of air are excluded. Now invert the whole, pressing the card lightly on to the glass during the operation, to prevent accidents, and it will be found (see Fig. 9) that the water will remain in the wine-glass, and will not fall out. In fact the pressure of the air upwards against the card is much more than sufficient to counterbalance the downward pressure of the water in the wine-glass.

Most of the experiments upon the pressure of the air require, however, the aid of an air-pump for their performance. With the air-pump a large variety of interesting properties of the air can be demonstrated, which otherwise cannot be shown. A few, however, do not require the aid of this instrument. The effect of the external pressure of the air in raising the level of a liquid in a tube from which the air has been partially exhausted, thereby reducing its pressure, can be shown by sucking with the mouth at the top of a glass tube, the lower end of which dips into the liquid in question. Thus it is possible to suck up mercury to a height of fifteen inches into a tube; for the lungs are strong enough to reduce the air in the tube to about half the ordinary pressure. If a glass tube of sufficient length were available it would be possible to suck up water in it to a height of about sixteen or seventeen feet; for a column of that height would be sufficient to counterbalance the difference between the inside and outside pressures.

The rising of a liquid into a space from which the air has been partially removed may also be illustrated in the following pretty way. Take a small bit of card and let it float upon the surface of water in a shallow dish. Upon it place a few shavings of wood and light them with a match; or place a small red-hot coal upon it, and on this sprinkle a little brimstone to burn. Then quickly invert over the blazing mass a wine-glass or a tumbler, as in Fig. 10. As the shavings or the brimstone, as the case may be, burn away, they withdraw the oxygen of the air inclosed in the space above, until only the nitrogen (about four-fifths of the whole) remains. The gases inside, therefore, will not exert so great a pressure as before, and consequently the pressure of the air outside will

force the water to rise in the glass as the remaining gases cool down to the temperature at which they were at first.

(To be continued.)

## ON THE ABSORPTION BANDS IN CERTAIN COLOURLESS LIQUIDS

[PRELIMINARY NOTICE]

HAVING occasion to examine the absorption spectra produced by considerable thicknesses of alcoholic solutions of certain cobalt salts, we were led accidentally to observe that alcohol alone gave a very distinct band, and afterwards, on examining water, found that it also, when a column of six feet was used, gave a very distinct absorption band in the orange, a little on the less refrangible side of D. By graphical interpolation we find the centre of this band to be about 600, and that the band extends from 607 to 596. This position corresponds very closely, if it be not identical, with Piazzi Smyth's rain band,<sup>1</sup> and also with the band seen in 330 feet of high-pressure steam by Janssen.<sup>2</sup>

Fig. 1 represents this spectrum. It will be seen that the absorption at the red end extends up to the line C, and the end of the shadow is so sharp that it is probable there is a band at this point also, but masked by the general absorption. To convince ourselves that this band belonged to water and not to any accidental impurity, we experimented with different samples of water, using ordinary tap-water, ordinary distilled water, also water which had been made with much care absolutely pure; in all these samples this same band was visible, and as long as the water was clear, as far as we could judge, it was of the same degree of intensity. A column of water eight feet long shows the band clearer than one only six feet; still greater lengths we have not yet tried. We next tried the effect of increase of temperature on the water. For this purpose the glass tube containing the water was fitted into an air-bath, and the temperature was raised from 20° to 60° without removing the tube from before the spectroscope; no change in the band, either in position or intensity, as far as we could see, occurred. Further, it seemed to us that it would be interesting to try whether, on dissolving different colourless substances in water, the band would be affected. We consequently examined saturated solutions of the following substances in a tube 8 feet long:—Ammonium chloride, ammonium nitrate, ammonium carbonate, potassium nitrate, lead nitrate, sodium chloride, and sugar. In all these cases the band was as visible as in pure water, and no additional band was seen. With a mixture of 1 volume of sulphuric acid and 5 of water the band was unaffected, but if pure commercial hydrochloric acid was examined in a 6-foot tube the band was invisible, but with 8 feet a faint indication of it was seen.

This absorption with water being so marked, we naturally went on to try whether other so-called colourless liquids gave, when depths of 6 or 8 feet of them were examined, absorption bands, and at first really our difficulty was to find any liquid which did not show clearly one or more bands.

The ordinary solution of ammonia gave a very clear and marked spectrum (Fig. 2). It consists of four bands, the centres of which are at 650, 630, 610, and 556. The band at 650 is much the darkest, and the band at 630 is remarkably sharp. Then with regard to the 610 band, it is characterised by sharpness only on the least refrangible side, but shades off gradually on the other side, the shade extending as far as 596; this shade is probably due to the water band; and lastly, the band at 556 is by far the

<sup>1</sup> Piazzi Smyth, "Edinburgh Astronomical Observations," vol. xiv.

<sup>2</sup> In this and the following experiments a Desaga's spectroscope with a single heavy glass prism was used, and the source of light was an Argand gas-burner. The measurements are expressed in the millionths of a metre.





faintest, and is only visible in a column of 8 feet. With the exception of the 556 band, the other bands are so distinct that in a nearly saturated solution  $4\frac{1}{2}$  feet in depth, they are clearly seen. This spectrum was so marked and intense that at first we were sceptical with regard to its belonging really to ammonia, thinking that possibly some coal-tar product might be still clinging to the commercial ammonia solution which in the first instance we used. To satisfy ourselves that this was not the case, first we added lime, and distilled the ammonia gas into pure water; this acted in exactly the same way as the former solution; then we obtained from Messrs. Hopkins and Williams what they guaranteed to be volcanic ammonia. A solution of this gave exactly the same spectrum as the former solutions. And lastly we prepared pure ammonia by Stas' method, by the action of caustic potash and zinc—free from

carbon—on potassic nitrite; this also gave precisely the same bands as the other ammonia solutions; there could therefore be no doubt that this spectrum belonged to the ammonia solution. Thirty-six feet of ammonia gas did not give us any indication of bands. Obviously this is only a mere trace of gas as compared with the amount held in the solutions before examined. To have as gas the same amount as there was of solution in our 6-foot tube, we should require a tube nearly a mile long. If absolute alcohol instead of water be saturated with ammonia, a spectrum (Fig. 3) still sharper than that with water is obtained, but similar to it, excepting that the band at 610 is wanting and the two bands at 650 and 630 now are of equal intensity, instead of the 650 band being decidedly and constantly the darker of the two. Ammonia giving so definite a spectrum it was evidently

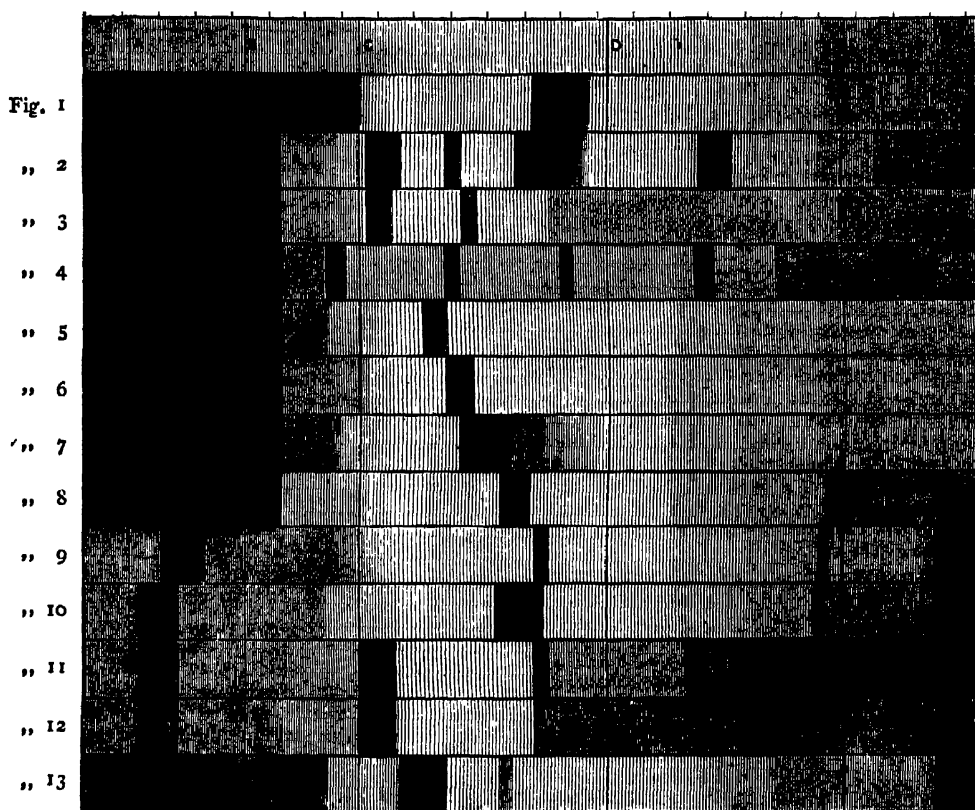

1, Water; 2, Ammonia; 3, Ammonia in Alcohol; 4, Ethylamine; 5, Amyl Alcohol; 6, Ethyl Alcohol; 7, Aldehyde; 8, Acetic Acid; 9, Benzene; 10, Toluene; 11, Aniline; 12, Toluidine; 13, Turpentine.

of much interest to ascertain what spectra would be given by bodies of allied chemical constitution. Ethylamine was the next substance we tried. Using a 33 per cent. solution, this gave a spectrum (Fig. 4) similar in character to that of ammonia, but the dominant band, as far as we could ascertain, has clearly moved towards the red. It was now at 665 to 656. The next band is also somewhat nearer the red than the corresponding ammonia band. The position of the third band is very nearly identical with that of the water-band, but instead of being a wide band shading off on both sides, is now narrow and perfectly sharp. It will be noticed that in the alcoholic ammonia solution it is this band and the next more refrangible one that are absent.

For lack of material we have not yet examined the spectra of other organic ammonias, but intend doing so.

A solution of peroxide of hydrogen was also examined, using the commercial 20-volume solution. The liquid was not absolutely free from colour, and consequently there was a very appreciable amount of absorption over the whole spectrum. The water band was not visible, and in fact no sharp band could be seen; there was however a decidedly marked absorption commencing about 674, then the absorption is both dark and sharp; it extends, diminishing gradually, to 638; very probably this absorption may prove to be a band, but the experiment was not altogether satisfactory.

We naturally returned to alcohol and other typical organic liquids. Alcohol gives in the six-foot tube a very visible and fairly-defined band, more sharply defined than the water band and nearer the red. It extends from 632 to 624. The spectrum is given in Fig. 6. It will be

seen that a faint absorption extends as far as 650, and very likely the termination of this shade is a band. Fig. 6 represents the spectrum of a sample of pure absolute alcohol. Ordinary methylated spirit gives a very similar spectrum, differing only in the presence of some general absorption, and with a mixture of equal parts of methylated spirit and water the alcohol band was still clearly visible, and only a faint indication of the water band.

On referring now to the alcoholic solution of ammonia (Fig. 3), it will be seen that the probable explanation of the darkening of the 630 band is owing to the coincidence of the alcohol band with that of the ammonia, so that really the marked difference of the two ammonia spectra is in the absence of the 610 band, and this, we have seen, may be accounted for by one being an aqueous and the other an alcoholic solution.

Ethyl alcohol giving this definite band, it was a matter of much interest to examine other alcohols belonging to the same series. We found that amylic alcohol ( $C_5H_{11}HO$ ) gave a single visible band (Fig. 5), which in character is like the one given by ethylic alcohol, but differs in position; it extends from 638 to 630, the centre being 634, so that it is decidedly nearer to the red end of the spectrum.

A sample of amylene ( $C_6H_{14}$ ) gave also a band in the same position as that of the alcohol, but it differs apparently in being broader and less defined at the edges.

The sample of methyl alcohol was not quite pure nor free from colour, but it gave a band quite similar to that of the other two alcohols. Its position is certainly very nearly the same as that of the ethylic alcohol, but as far as our measurements went it was a little nearer the blue, but with our method of measuring hardly discernible.

It seems—pending further investigations—highly probable that this band—and of course there may be others not visible—is common to all the alcohols of the ethylic series, and that its position is a function of the density of the particular alcohol. Apparently however the significance of this line does not stop here, for in ordinary ether there is a band coincident with this alcohol-band—in fact practically the visible spectrum produced by alcohol and ether are identical; but in all cases that we have seen the ether spectrum is clearer and sharper than the alcohol one. We thought it of importance to examine a sample of ether which should be as far as possible rendered pure by ordinary means, especially that it should be free from all traces of moisture: this sample gave a band precisely similar to the band in the ordinary commercial ether. Another sample of ether was saturated with water: in this case the ether band was as marked as ever, but the water-band was not visible.

We have also examined two other bodies which belong to the ethylic series, namely, aldehyde and acetic acid. Both give bands, but they are not so clear or definite as the alcohol or ether bands. Figs. 8 and 9 show these bands. The aldehyde band commences sharply at 628, but on the other side it shades gradually off and ceases at 620. The band in acetic acid is very faint, in fact at first, when using the 6-foot tube, we were led to think there was no visible band.

We also tried a few of the saline ethers, and, as far as our investigations have gone, the ethyl compounds give a band coincident with the alcohol- and ether-band. And the band of the amyl compounds is coincident with that of amylic alcohol. There appears, however, to be this general difference between the bands in the alcohols and those in the corresponding saline ethers, namely, that in the latter the bands are always broader and less distinct; the saline ethers we have examined are ethyl oxalate, amyl acetate, amyl iodide, and amyl nitrate.

Passing now to the aromatic series, we find that they give very marked absorption bands. Fig. 9 represents the bands given by benzene; the spectrum is remarkably

sharp and clear, quite as clear as the ether spectrum; the figure is drawn from the spectrum produced by 8 feet of the liquid. The absorption extends as far as 656; the first band is from 707 to 698, the second from 609 to 605, both are very dark and distinct. The third band extends from 531 to 528, and is very much fainter.

Toluene, the next higher member of this series, gave also a similar spectrum, and it is equally sharp (Fig. 10). As in the case of the alcohols, with increase of density the bands have moved nearer the red. It will be seen that the band in the red differs in position from the corresponding benzene band more than either of the other two bands do.

Cresol, unfortunately at present, we have not been able to examine for want of a sufficient quantity of the pure substance.

Phenol gives a spectrum very similar to the benzene spectrum; possibly the band about 610 is somewhat nearer the blue, but beyond this we could see no difference. In the first instance we tried melting the phenol, but afterwards found it far preferable to keep it liquid by the presence of a mere trace of water.

We looked with much interest to the two following experiments, with bodies of this series, namely, aniline and toluene, to see how far their constitution might be indicated by their spectrum. Figs. 11 and 12 give respectively the spectra of these bodies. There is a band in the red in the same position as the toluene band, and in the case of aniline a band agreeing in part with the 606 benzene band. With toluene, however, this band was not visible, but probably this arose from its being hidden by general absorption, the liquid used being slightly coloured. However, besides these two bands, both of these amido compounds gave a very clear band from 656 to 645, and it is certainly not without interest that this is coincident with one of the bands given by ammonia; whether any other band coincidences occur between these bodies we cannot say, as in both cases there was sufficient general absorption to hide them even if present.

Among other liquids we have tried turpentine, which appears to give a definite spectrum. This is shown at Fig. 13. With a thickness of 8 feet of carbon disulphide and a similar thickness of carbon tetrachloride, we could see no bands. However, with the former liquid it may prove that there is a band in the green, but as far as we could tell this is doubtful. One other experiment, which has some interest, is that the benzene spectrum is unaltered when the liquid is saturated with sulphur.

Such are the principal observations which we have made up to the present time. As stated at first, we look upon these results as preliminary, and as having to be repeated with more accurate means. Of course we have only dealt with the bands visible under ordinary conditions; still, the above results, as far as they go, have been made with much care, and we think show that most interesting relations exist between the chemical composition and constitution of a body and its absorption spectrum. Obviously a far more extended series of observations must be made before any general conclusions of value can be deduced.

WILLIAM J. RUSSELL  
Chemical Laboratory,  
St. Bartholomew's Hospital

WILLIAM LAPRAIK

#### CELLULOID

THE product of the action of strong nitric acid upon cellulose has of late years met with many applications in the arts.

When cotton wool, linen, paper, or other substance largely consisting of cellulose, is immersed in strong nitric acid, a mixture of two or more nitro-celluloses is produced; a solution of this mixture in alcohol and ether has been long known as collodion.

About three or four years ago it was shown that this



product may be dissolved under pressure and at moderately high temperatures in camphor, and that on cooling hard, compact mass closely resembling ivory is produced. This observation furnished the starting-point in the manufacture of "Celluloid," a substance which has already been put to many and varied uses, and promises to be of much importance in the future.

In the process of Tribouillet and Besaucèle—patented January, 1879—the raw material, consisting of paper, linen, cotton wool, hemp, or white wood, is dried at 20°, and is then nitrated in vessels of glass, clay, or glazed sheet-iron, furnished with a double bottom, between the parts of which water is constantly flowing. The nitrating acid consists of a mixture of 3 parts concentrated sulphuric acid (sp. gr. = 1.834) and 2 parts concentrated nitric acid, containing nitrous acid. The dry and finely-divided material is first treated with acid which has been already once used for nitrating; the materials are mixed for ten or fifteen minutes by the help of a kind of trowel; the mass is pressed in a glazed iron cylinder with perforated sides and bottom, through which the acid runs out. The material is again treated with a fresh mixture of acids in the proportions already mentioned; it is then washed with water in a series of wooden vessels with perforated bottoms placed one beneath the other on an inclined plane. The last particles of acid are removed by washing with very dilute soda or ammonia, and again with water. The material is then dissolved in appropriate solvents, from which it is again recovered in a paste-like form, by distilling off the solvent.

For making artificial ivory and similar opaque substances, about 100 parts of the prepared nitro-cellulose are intimately mixed with from 42 to 50 parts of very finely-divided camphor, and the mixture pressed in a steam press, into which steam is conducted, and which is connected with a moist chamber wherein the fumes from the press are condensed. After being for some time in a warmer press, the material is dried in a chamber containing calcium chloride or sulphuric acid, and connected with an air-pump.

Other manufacturers appear to mix ivory-dust, nitro-cellulose, and camphor, and to press the mixture when moist, heat it with ethyl nitrite in a closed vessel until perfectly homogeneous, and distil off the nitrite.

Celluloid is a hard, perfectly homogeneous substance, which is not attacked by ordinary reagents (it dissolves slowly in cold concentrated sulphuric acid), cannot be easily broken, and becomes plastic at about 125°. It may be obtained in thin layers 0.5 millims. in thickness, which may be encrusted on wood, marble, &c. At about 140° celluloid suddenly decomposes, emitting a reddish vapour; this liability to complete decomposition may be prevented by washing the celluloid with sodium silicite solution and then immersing it in a solution of sodium ammonium phosphate; thus treated, the material is non-inflammable.

If colouring materials be mixed with the celluloid during the manufacture, artificial coral, amber, malachite, and lapis lazuli may be prepared.

Celluloid is an admirable material for forming the backs of brushes, handles of knives or umbrellas, combs, playthings for children, &c.; it is also employed in America as a substitute for linen in the manufacture of collars, scarves for the neck, &c. Articles made of it may be washed with soap and a brush, and are practically indestructible.

M. M. P. M.

#### L. F. DE POURTALES

OUR readers will be glad to have the following further notice of the late Count Pourtales from his intimate friend and colleague, Prof. A. Agassiz.—ED.]  
Louis François de Pourtales died at Beverly Farms, Massachusetts, in the fifty-seventh year of his age, on

July 17, 1880. Spite of a magnificent constitution and a manly vigour of body and mind which seemed to defy disease and to promise years of activity, he sank, after a severe illness, under an internal malady.

Educated as an engineer, he showed from boyhood a predilection for natural history. He was a favourite student of Prof. Agassiz, and when his friend and teacher came to America in 1847, he accompanied him, and remained for some time with the little band of naturalists who, first at East Boston, and subsequently at Cambridge, shared his labours.

In 1848 Pourtales entered the U.S. Coast Survey, where his ability and indefatigable industry were at once recognised, and he remained attached to that branch of our public service for many years. He then became deeply interested in everything relating to the study of the bed of the ocean. Thanks to the enlightened support of the then Superintendent of the Coast Survey, Prof. Bache, and of his successors, Prof. Peirce and Capt. Patterson, he was enabled to devote his talents and industry to the comparatively new field of "thalassography" and the biological investigations related to it. The large collections of specimens from the sea-bottom accumulated by the different hydrographic expeditions of the U.S. Coast Survey were carefully examined by him, and the results were published, in advance of their appearance in the Coast Survey Reports, in *Petermann's Mittheilungen*, accompanied by a chart of the sea-bottom on the east coast of the United States.

So interesting and valuable were the results obtained, not only as an aid to navigation, but in their wider bearing on the history of the Gulf Stream and on the distribution of animal life at great depths, that in 1866 he was sent out by Prof. Peirce, then superintendent of the Coast Survey, to continue these investigations on a larger scale. During 1866, 1867, and 1868 he was in charge of the extensive dredging operations carried on by the U.S. Coast Survey Steamer *Bibb*, acting-master Platt, along the whole line of the Florida reefs and across the Straits of Florida to Cuba, Salt Key, and the Bahama Banks. The results of these expeditions, published in the *Bulletin* of the Museum of Comparative Zoology, excited great interest among zoologists and geologists. M. Pourtales was indeed the pioneer of deep-sea dredging in America, and he lived long enough to see that these expeditions had paved the way not only for similar English, French, and Scandinavian researches, but had led in this country to the *Hassler*, and finally to the *Blake* expeditions, under the auspices of the Hon. Carlisle P. Patterson, the present Superintendent of our Coast Survey. On the *Hassler* expedition from Massachusetts through the Straits of Magellan to California, he had entire charge of the dredging operations; owing to circumstances beyond his control, the deep-sea explorations of that expedition were not as successful as he anticipated.

At the death of his father M. Pourtales was left in an independent position, which allowed him to devote himself more completely than ever to his zoological studies. He resigned his official connection with the Coast Survey and returned to Cambridge, where he became thenceforth identified with the progress of the Museum of Comparative Zoology. To Prof. Agassiz his presence there was invaluable. In youth one of his favourite pupils, throughout life his friend and colleague, he now became the support of his failing strength.

The materials of the different deep-sea dredging expeditions above-mentioned had been chiefly deposited at the Museum in Cambridge, and were thence distributed to specialists in this country and in Europe. A large part of the special reports upon them have already appeared. M. Pourtales reserved to himself the Corals, Halcyonarians, Holothurians, and Crinoids. A number of his papers on the deep-sea corals of Florida, of the

Caribbean Sea, and of the Gulf of Mexico have appeared in the Museum publications. He had begun to work at the magnificent collection of Halcyonarians made by the *Blake* in the Caribbean Sea, and had already made good progress with his final report on the Holothurians. The Crinoid memoirs published by him relate to a few new species of Comatula and to the interesting genera *Rhisocrinus* and *Holopus*.

The titles of his memoirs indicate the range of his learning and his untiring industry. His devotion to science was boundless. A model worker, so quiet that his enthusiasm was known only to those who watched his steadfast labour, he toiled on year after year without a thought of self, wholly engrossed in his search after truth. He never entered into a single scientific controversy, nor ever asserted or defended his claims to discoveries of his own which had escaped attention. But while modest to a fault and absolutely careless of his own position, he could rebuke in a peculiarly effective, though always courteous, manner ignorant pretensions or an assumption of infallibility.

Appointed keeper of the Museum of Comparative Zoology after the death of Prof. Agassiz, he devoted a large part of his time to the administration of the museum affairs. Always at his post, he passed from his original investigations to practical details, carrying out plans which he had himself helped to initiate for the growth of the institution. As he had been the devoted friend of Prof. Agassiz' father, he became to his son a wise and affectionate counsellor, without whose help in the last ten years the Museum could not have taken the place it now occupies.

If he did not live to see the realisation of his scientific hopes, he lived at least long enough to feel that their fulfilment is only a matter of time. He has followed Wyman and Agassiz, and like them has left his fairest monument in the work he has accomplished and the example he leaves to his successors.

Cambridge, Mass., August 2 ALEXANDER AGASSIZ

### NOTES

THE honour of a Knight-Commandership of the Bath has been conferred upon Mr. E. J. Reed, C.B., F.R.S., late Chief Constructor of the Navy.

WE give this week, by the continued kindness of General Myer, the International Monthly Chart for October, 1878, showing mean pressure, temperature, force and prevailing direction of wind at 7.35 a.m. Washington mean time, for that month. The lessons which it teaches may be learned by comparison with the chart for the previous month; any remarks we may have to make upon it we reserve for the issue of the next chart.

WE are happy to state that the Worshipful Company of Drapers have intimated their intention of continuing, at all events for the present, their annual subscription of one hundred guineas to the Research Fund of the Chemical Society.

THE eighth session of the French Association for the Advancement of Science was opened on August 11 at Rheims, under the presidency of M. Krantz, senator and ex-director of the Universal Exhibition of 1878. In his opening speech M. Krantz paid a tribute to the memory of Paul Broca, and spoke of the late Universal Exhibition as well as the construction of the Trocadéro Palace. The General Secretary, M. Mercadier, according to the routine of the French Association, reviewed the work done last year at Montpellier. Addresses were also delivered by M. Diancourt, Mayor of Rheims, and M. Paulane, ex-Mayor, President of the Local Committee. The report read by M. Georges Masson, the treasurer, shows that the French Association is very prosperous, numbering 3,000 members, with a

capital of 300,000 francs. The income is 60,000 francs. The attendance is considered to be very good, the local attractions being really unexceptionable in a city whose wines are famous in the whole world, and which is the centre of interesting excursions. On the 12th M. Perrier delivered, in the General Session, an address on the law of selection.

THE Cambridge meeting of the British Medical Association last week is considered to have been one of the most successful which the Association has held. The presidential address by Prof. Humphry traced the history of medical science in the English universities, and showed the causes of the gradual divorce between university and medical studies up to the last few years. He reiterated his advocacy of university residence for medical students, and of continual advance and expansion of good teaching and examining. He claimed that in no other branch of knowledge were true science and sound practice so perfectly conjoined; in no other was there so much that was calculated to give strength and balance to the thinking and the observing faculties; nor was there any in which mental and bodily effort were more required or more telling. What problems were harder of solution than those relating to the aberrations of the human organism? The very difficulty of the problems caused them to be overlooked. Clearer knowledge of physiology and pathology, of heredity, of the effects of social laws and climatic variations, would have a vast influence on the whole framework of civilisation; and thus he was led to conclude with Descartes that all great movements in the world of thought, of philosophy, or of morals, and of government, were to come out of medicine. Cambridge ought not to fail in doing its share in the great work, and renewed life would come to all its best interests from a wise encouragement of medicine. The British Medical Association brings together in one aim an enormous power, and ought to aid in wearing away false dogmas and false notions of conflicting interests. Dr. Humphry further urged on the vast mass of members of the Association a hearty participation in the collection of facts bearing on the effects of temperature, climate, soil, &c., on disease, under the guidance of a medical investigation committee. The latter proposal awakened a cordial response, and the Council were requested to see it carried out. The honorary degree of LL.D. was conferred on Doctors Brown-Séquard, Donders of Utrecht, Gross of Philadelphia, Sir W. Jenner, Sir W. Gull, Sir George Burrows, Prof. Haughton of Dublin, Mr. Wm. Bowman, Mr. Joseph Lister, Dr. Denis O'Connor of Cork (the retiring president of the British Medical Association), Mr. John Simon, C.B., and Dr. Andrew Wood. Dr. Chauveau of Lyons was unavoidably absent from the meeting, and consequently could not receive in person the degree which would otherwise have been conferred upon him; and Prof. Broca's lamented death caused another variation from the list as originally settled.

THE International Congress of Hygiene will meet at Turin on September 6 under the presidency of King Humbert, who will give the inaugural address. The general meeting will take place in the Carignan Palace. The Congress will end by an excursion to Milan, where a cremation will take place.

IN a brief report of the recent French scientific cruise in the *Travailleur*, in the Bay of Biscay, M. Alph. Milne-Edwards says the weather was very good, allowing them in the last fortnight of July to dredge twenty-four times, sometimes using two dredges at once. The bottom has a thick layer of greenish-grey ooze, which was apt to fill the dredges, so recourse was had largely to weighted rods with hemp or twig bundles, swabs, &c., attached, to sweep the bottom. Sir William Thomson's wire apparatus proved very serviceable in sounding. The greatest depth reached was 2,700 m., and the least exceeded 300 m. An important collection of marine

organisms was obtained, including, besides most of the species described by English and Scandinavian naturalists, many new animals not previously known. Some large Gorgonians of the genus *Isis*, once brought up from 600 m., about midnight presented a curious sight: the whole of the sarcosoma between the zooids emitted a green phosphorescent light so strong that on agitating these animals they seemed to produce a shower of fire, and with the light emitted one could read the smallest type. The collections are distributed thus: M. Vaillant examines the fishes, nemertians, and sponges; M. Fischer, the molluscs; M. Marion, the annelids, echinoderms, and other zoophytes; M. de Folin, the foraminifera; M. A. Milne-Edwards, the crustacea; while M. Perier has made thermometric observations, and will analyse the samples of sea-bottom.

AMONG our letters this week are some referring to the recent remarkable displays of auroræ. Another correspondent writes that similar displays were seen from Caithness-shire on the evenings of Wednesday the 11th, and Thursday the 12th inst. The finer of the two displays was on the Thursday, lasting from about 10 p.m. to midnight. The outburst of streamers at 10.15 p.m. was very fine, the streamers appearing like wavy swaying curtains from the zenith to near the horizon, with a development of tints of the loveliest green near the zenith. The aurora of the 11th was to the north-west of Wick, but that of the 12th chiefly to the north-east. From Kirkwall also fine displays were seen on the 13th till past midnight. Reports in the daily papers also show that the phenomena have been seen from many parts of England as well as Scotland. Fine displays of this beautiful meteor may very confidently be looked for during the next three months, and if our spectroscopists bestir themselves a large extension of our knowledge of the aurora is close at hand.

PROF. SILVESTRI writes to the *Daily News* Naples correspondent that in a short time the Observatory on Etna will be an accomplished fact. The Italian Government contributes half of the expenses, the Province of Catania a fourth, and the Commune of Catania the remaining fourth. The object of the observatory is the study of vulcanology, and therefore it has been built at the base of the central cone, exactly on the former site of the well-known refuge called the "Casa degli Inglesi." It will be in connection with several small seismic stations posted on the slopes of the mountain, and the whole will communicate telegraphically with another volcanic station which he proposes to establish in Catania. In the central observatory, so favourably situated about 3,000 metres above the level of the sea on the isolated mountain, where the extent of view is unlimited, and the sky peculiarly transparent, meteorological observations most interesting to science will be carried on, and Prof. Tacchini, the astronomer, proposes to make there experiments in physical astronomy, particularly relating to the spectroscopical study of the fixed stars. The Observatory will therefore be divided into three scientific branches—vulcanology, astronomy, and meteorology, connected with the University of Catania, and dependent on the Minister of Public Instruction. It was intended that the inauguration should take place during the Congress of the Alpine Club at Catania, but unforeseen delays in the execution of the works will defer it to next year.

THE United States Government has taken prompt and vigorous action on the basis of the recent conclusions come to by scientific investigators as to the prevalence of colour-blindness. Both in the army and the navy, and in the case of pilots, systems of examination have been devised and are enforced to secure the detection of colour-blindness in all cases in which such a defect would be likely to lead to inefficient discharge of duty. As we formerly intimated, also, the State of Connecticut insists that all railway employes within its borders be tested for the same purpose, and doubtless in time a similar law will be passed in all

the other States. The following are the rules for conducting the examinations in the State of Connecticut—Rule 1.—For the qualitative estimation of colour-blindness the following tests are to be employed: Holmgren's worsteds, the tables of Stilling, Donders' colour-test patterns, Pflüger's letters with tissue papers. Däac tests and Woinow's revolving cards may also be used. For the quantitative test for colour-blindness, Donders' reflected spots, Donders' method with transmitted light, Holmgren's shadow-tests shall be employed. Rule 2.—The following are the requirements for a certificate in the first class: 1. Healthy eyes and eyelids without habitual congestion or inflammation. 2. Unobstructed visual field. 3. Normal visual acuteness. 4. Freedom from colour-blindness. 5. Entire absence of cataract or other progressive disease of the eyes. The second class shall have:—1. Healthy eyes and eyelids without habitual congestion or inflammation. 2. Unobstructed visual field. 3. Visual acuteness at least equal to three-fifths without glasses and normal with glasses in one eye, and at least one-half in the other eye with glasses. 4. Freedom from colour-blindness in one eye, colour-perception at least equal to three-fourths in the other eye. Rule 3.—In the case of employes who have held their positions five years or more, the standards required in each class shall be determined under special instructions from the Board of Health.

THE third instalment of Dr. Elliott Coues's "Ornithological Bibliography" is, we learn from the *New York Nation*, still in the press, having been delayed by its unexpected extent. Meantime, extracted from the *Proceedings* of the United States National Museum, we have the fourth instalment, being a "List of Faunal Publications relating to British Birds." Such a list, of course, could not possibly be made complete out of England, and the compiler himself points out its inadequacy. Nevertheless, it embraces something like a thousand titles, only in a comparatively few cases taken at second-hand, and is so accurate and punctilious as far as it goes that to call it a "published proof-sheet" is almost an excess of modesty. The titles are given in full, and even, as in the first two (different editions of the same book), with the typographic errors and inconsistencies of the originals. Further, they are arranged chronologically, and copiously annotated, not seldom with the aid of Prof. Alfred Newton, of Magdalene College, Cambridge.

"PALÆONTOLOGISTS and naturalists generally," the *Nation* states, "will learn with satisfaction of the appearance in connected form of the results of a portion of Prof. Marsh's wonderful palæontological discoveries in the Western Territories. The series of explorations so successfully carried on by this distinguished naturalist in the Rocky Mountain region since 1868, undertaken at no inconsiderable personal risk and no less considerable outlay of private capital, has resulted in the acquisition by Yale College of the most extensive collection of fossil vertebrate remains in the world. Huxley's visit to this country in 1876 was largely, if not mainly, brought about by his desire to examine personally this collection. Some notion of its extent may be gleaned from the fact that of Pterodactyls (flying reptiles) alone it embraces fragments belonging to at least 600 individuals, and of Mesozoic birds—a class of remains which, as far as number is concerned, has thus far yielded the most barren results in extra-American countries—fragments representing more than 100 individuals. The work before us, which is intended to form vol. vii. of the geological reports of the Fortieth Parallel Survey, deals with the *Odontornithes*, or extinct toothed birds of North America. These, belonging to the middle-cretaceous period, are the oldest ornithic remains as yet discovered on this continent, and, with the exception of the three specimens of the *Archæopteryx* unearthed from the Jurassic lithographic limestone of Solenhofen, Bavaria, represent the oldest known form of

birds altogether, for the footprints in the Triassic sandstones of the Connecticut valley are now generally referred to Dinosaurian reptiles. Despite their strongly reptilian characters—among others, the presence of teeth in the beaks—which point to a position low down in the avian branch of the Sauropoda, Prof. Marsh argues, from the structural differences existing between such forms as *Hesperornis* and *Ichthyornis*, and between these and *Archaeopteryx*, which appear greater than those presented by any two living birds, that they represent comparatively highly specialised types, and that we must look for the earliest appearance of birds in strata possibly as old as the Permian (Palæozoic). The magnificent engravings which accompany the work render it a *livre de luxe*, and place it in the category of recent American scientific works next to Leidy's 'Rhizopods,' to which we lately had occasion to call attention. We are informed that another important work on the extinct vertebrata of the West is shortly to appear, from the pen of Prof. Cope."

MR. THOMAS BOLTON of Birmingham has sent us No. 3 of his "Portfolio of Drawings and Descriptions of Living Organisms (Animal and Vegetable) Illustrative of Freshwater and Marine Life," which have been sent out by him with the living specimens.

AN interesting paper by Mr. G. M. Dawson on the distribution of some of the more important trees of British Columbia is reprinted from the *Canadian Naturalist*. In connection with this subject we learn from the *Gardener's Chronicle* that three of the most distinguished botanists of America—Dr. C. C. Parry, Dr. George Engelmann, and Prof. C. S. Sargent—are now on their way to Vancouver's Island; thence they propose to return and ascend the Columbia River as far as it is necessary to settle vexed tree questions in the extensive forest region along its shores; they will thence journey southward *via* Portland through the centre of Oregon to the great Fir forests of Shasta. We may hope that much "clearing-up" in the nomenclature of certain Conifers will accrue from the visit.

WE have received the five Annual Reports of the Little Miami Natural History Society, which was founded in 1875 at Antioch College, Yellow Springs, Ohio. The objects of this Society are:—(1) To develop among the students a habit of accurate observation and patient investigation rather than mere acquisition in studying the natural sciences, and thus to accustom them to the methods and rules of scientific study; and (2) to work out the natural history of the district in which the college is situated, especially the valley of the Little Miami and its tributary streams. The membership of the Society is open to all students of the College who wish to join for the purpose of doing actual work in furtherance of this purpose. Each of the Reports covers only one side of a sheet of paper, but from the catalogue of papers and reports contributed to the Society, it is evidently doing good work in the natural history of its district.

DR. R. F. HUTCHINSON of Mussoorie, N. W. P., India, writes with reference to NATURE, vol. xxii. p. 119, that he has frequently seen Mercury with the naked eye out there, especially in the cold weather when the atmosphere is clear and dry. He has also twice seen two of Jupiter's satellites under the same circumstances.

SEVERAL important changes have been made in the method of conducting the technological examinations in connection with the City and Guilds of London Institute; those interested should apply for a programme of the changes to the Secretary, Gresham College, E. C.

TELEPHONE experiments with a new apparatus by Dr. Herz have been made with the French Atlantic cable between Brest and Penzance, and are said to have yielded satisfactory results.

ON Sunday, August 8, a young man named Brest ascended at Marseilles in a balloon he had constructed himself. He was lost to view in the direction of the sea, and his aerial craft was found by fishermen close to Bastia, in Corsica. It is feared that the unfortunate aeronaut was drowned.

THE lady who took so high a place in the London University B.Sc. examination, referred to last week, was not Miss, but Mrs. Bryant, the well-known teacher at the North London Collegiate School for Girls.

THE additions to the Zoological Society's Gardens during the past week include a Rhesus Monkey (*Macacus erythraeus*) from India, presented by Mr. J. E. Kincaid; a Black-handed Spider Monkey (*Atles geoffroyi*) from South America, presented by Capt. Woolward; a Common Squirrel (*Sciurus vulgaris*), British, presented by Capt. Tholandir; a Spotted Ichneumon (*Herpestes auro-punctatus*) from India, presented by the Hon. L. S. Jackson; four Richardson's Skuas (*Lestris crepidatus*), Shetland Isles, presented by Mr. Robt. T. C. Scott; three Abyssinian Guinea Fowls (*Numida pitlorhyncha*) from Abyssinia, presented by Mr. Gerald Waller; two Common Nightjars (*Caprimulgus europæus*), British, presented by Mr. E. Ockenden; a Common Chameleon (*Chameleon vulgaris*) from North Africa, presented by Mr. Percy Howard; an Areolated Tortoise (*Homopus areolatus*), a Geometric Tortoise (*Testudo geometrica*) from South Africa, presented by the Rev. G. H. R. Fisk, C.M.Z.S.; three Richardson's Skuas (*Lestris crepidatus*), Shetland Isles, four Glass Snakes (*Pseudopus pallasi*) from Dalmatia, deposited; a Yellow-collared Parrakeet (*Platycercus scintillorquatus*) from West Australia, received in exchange.

#### OUR ASTRONOMICAL COLUMN

THE AUGUST METEORS.—The meteors annually encountered by the earth on arriving at the descending node of the third comet of 1862, in the orbit of which they are found to travel, are reported to have been less numerous this month than in most recent years. The earth arrived in the longitude of the node about midnight on the 9th inst., and in this position is only 430,000 miles, or less than twice the moon's distance from the comet's track. Even if less frequent than in several past years, a considerable number was observed on August 9, 10, and 11, and on the latter night a conspicuous Aurora Borealis, which phenomenon has so often accompanied meteoric displays, was witnessed in the north of England. Early on the evening of August 12 the meteors were sufficiently frequent and bright to attract the attention of persons in the suburbs of London who were not looking for them, but there were very few later in the evening.

It has been frequently remarked that the August meteors, or, to call them by their astronomical designation, the *Persæids*, must be much more widely distributed along the cometary orbit than are those of the November period—the *Leonids*—moving in the track of the first comet of 1866. The comet which appears to generate the August meteors, or at any rate to be followed by them, has now receded beyond the orbit of Neptune, and will continue to recede until about the year 1923. It was last in aphelion, according to Prof. Oppölzer's investigation, about 1801 or 1802, and, notwithstanding the great distance of the comet, there was a remarkable meteoric display. Herrick reports a letter from Dr. Joseph Priestley describing the phenomenon as he witnessed it on August 8, 1801, amongst the meteors being "a prodigious number of fire-balls." He compared the whole to a brilliant display of fire-works.

It is rather singular that in the history of comets we should not have been able to recognize any previous appearance of the body connected with the *Persæids*, notwithstanding its close approach to the earth's orbit when the perihelion passage takes place in the summer. Perhaps for many past centuries the perihelion may have fallen in the winter, when the comet would have greater chance of escaping notice.

CAPE OBSERVATIONS OF COMET 1880 (I).—Mr. Gill sends us the fully reduced observations of the great comet of the present year made at the Royal Observatory, Cape of Good

Hopé. A ring-micrometer was used, the aperture of the telescope and the unsatisfactory illuminating arrangements not permitting the use of the parallel-wire micrometer. The stars of comparison have been observed in the early morning with the meridian circle; also the  $7\frac{1}{2}$  mag. star used by Mr. Ellery on February 14. Mr. Gill expresses himself as by no means proud of his observations, the comet's nucleus being an object which could not be satisfactorily observed, but he did his best with the available means. He also writes disparagingly of the ring-micrometer, a tool which we incline to agree with him has been very much over- lauded. As Mr. Gill will no doubt communicate the details of his observations and reductions to the Royal Astronomical Society or the *Astronomische Nachrichten*, we shall confine ourselves to appending his final results:—

	Cape M.T.			App. R.A.			App. N.P.D.		
	h.	m.	s.	h.	m.	s.	°	'	"
Feb. 10	8	50	2	0	3	58.59	123	43	15.53
—	8	52	49	—	—	—	—	—	—
11	8	33	4	0	20	22.16	—	—	—
—	8	45	42	0	20	31.53	123	31	30.78
12	8	42	18	0	36	28.06	123	11	33.93
—	8	42	18	0	36	28.29	—	—	23.44
13	8	30	57	0	51	39.32	122	44	20.93
14	8	23	5	1	6	7.89	122	11	17.23
—	8	42	51	1	6	19.25	122	10	52.86
—	8	42	51	1	6	19.79	—	—	57.19
15	8	24	31	1	19	54.92	121	32	52.17

On February 12 two, and on February 14 three, comparison stars were employed. The observations are not yet corrected for parallax.

PHYSICAL NOTES

PROF. O. N. ROOD claims to have produced a *new* improvement into the Sprengel pump, by which he says he can easily exhaust to  $\frac{1}{1000000}$  or  $\frac{1}{10000000}$ . The alleged improvement is in two parts; the first being an arrangement whereby "the mercury, instead of being at once introduced into the pump, passes beforehand through an exhausted bulb"; the second being a "theoretically perfect fluid valve," formed by bending the fall-tube into a crenellated form at one point. It is hardly necessary to point out that neither of these improvements is new. The first has been adopted in the Sprengel pumps sold by instrument makers in London for the last ten years, and the second, in a form superior even to that of Prof. Rood (since the fall-tube was furnished with more than one fluid valve of a form identical with that devised by Prof. Rood), was to be seen in one of the improved Sprengel pumps exhibited in the Loan Collection at South Kensington in 1876.

M. TROUVÉ has suggested a new improvement in the old and simple longitudinal armature employed by Siemens in his earlier magneto-electric machines, and lately revived by M. Marcel Deprez in his little motors. M. Trouvé's improvement consists in constructing the armature, not with parallel sides, but with sides forming part of a skew-cylinder. Thus one part of the armature is ready to leave the poles of the field magnets when the other is approaching it, and the currents produced are therefore much more nearly continuous than with the parallel form. This will probably be a considerable advantage in the case where the armature is employed in a small motor, which will be driven much more steadily than has hitherto been possible. With three cells of Reynier's new battery this little motor will drive a sewing-machine.

M. J. PLATEAU proposes a method of estimating approximately the apparent distance at which the moon seems to different people to be in the sky. This means consists in looking at the moon steadily until the retina is sufficiently fatigued to produce an "accidental" image or ghost. The observer must then turn his gaze to a blank wall, on which he will see the accidental image projected as a tinted patch of the same shape as the moon. He is then to retreat from, or advance to, the wall until this image appears to him to be of the same size as the moon itself did. The distance measured off between the observer and the wall will be the same as that at which he unconsciously takes the moon to be. One of the sons of the author having made this experiment, found the distance to be in his case about fifty metres. This seems a small distance, but it was the result of a single experiment under circumstances which were not very favourable. M. Plateau concludes the brief memoir on the

subject, presented by him to the Belgian Académie, by cautioning all persons who may be interested in the subject to take care in repeating the experiment lest the great brilliance of the luminary should damage their sight.

M. REYNIER recommends a powerful and constant battery for electric light work a modified Daniells' cell, in which the zinc is immersed in a solution of caustic soda placed in a rectangular porous cell of parchment paper. The electromotive force of this combination varies from 1.47 to 1.35 volts, and the resistance may be less a Thomson's tray battery. The actual energy which a cell of this battery would furnish is calculated to be twice that of the ordinary round Bunsen cell.

A FEW months ago Prof. Boltzmann of Vienna published a calculation of the velocity of the electric current in a conductor based upon the discovery of Mr. E. H. Hall that a magnet acts upon a current in a conductor, tending to alter its path in the substance of the conductor. In the July number of the *American Journal of Science* Mr. Hall combats Boltzmann's calculation, and shows that by parallel reasoning a current should tend to urge forward with considerable force the conductor through which it flows; which mechanical effect is certainly non-existent. Mr. Hall now gives us the very interesting additional piece of information that the displacing force exercised by the magnet upon the current in the conductor is in an opposite direction in gold to what it is in iron—which is also quite irreconcilable with Boltzmann's theory.

AN improved centrifugal machine for schools is described in the *Nachrichten* of the Göttingen Society of Sciences (No. 9), by Herr W. Holtz. The driving-wheel runs in a vertical plane, and the quick axis may (with one and the same length of cord) be set either in a horizontal or a vertical plane, and higher or lower, also at varied distance from the frame of the machine; further, it can be so rotated that an object to be rotated with it can be suspended from it. On the same axis and of equal size with the large driving-wheel, but independent of it, runs another grooved wheel. The endless cord passes under these and round two smaller wheels higher up, one of which is on the axis to be quickly rotated (which is set in a movable support). The machine has been patented in Germany.

IN a communication to the Göttingen Society of Sciences (*Nachr.*, No. 13), Herr Wöhler states that with aluminium alone and with very few elements, a galvanic battery may be formed of strength sufficient to deflect a magnetic needle strongly, decompose water, and raise a thin platinum wire to glow. In a cylindrical glass vessel holding very dilute muriatic acid or dilute soda lye, is placed a roll of sheet aluminium, and within this a porous cell containing concentrated nitric acid and a smaller roll of aluminium. A projecting piece of the metal from each roll is inserted in a circular cover of ebonite.

DURING a recent thunderstorm at Hamburg the British Consul, Mr. Pogson, observed the phenomenon of St. Elmo's fire playing above the tip of the spire of a church three-quarters of a mile away. Twenty times within one hour a pale bluish ball of light resembling in tint the flame of burning potassium was seen. It appeared to be spherical in form, and from three to six feet in diameter. It seemed to hover above the spire without touching it, and lasting about forty seconds at each time of appearance.

*Apropos* of the approaching meeting of the British Association at Swansea, we may note that on the occasion of the last meeting at Swansea of the Association, in 1848, a paper was read by Mr. F. Wishaw "On the Telekoupion, or Speaking Telegraph." This antedates Philip Reis's "Telephon" by several years.

ANOTHER improved bichromate battery is announced, this time by the Silvertown Company. In no essential respect does this battery differ from the form known as "Fuller's battery," save in the addition of certain "exciting powders" to the liquids, a "grey compound" being dissolved in the inner cell in which the amalgamated zinc is placed, and a "red compound" in the outer cell with the carbon-rod. The use of dilute sulphuric acid is avoided by employing the "grey compound," the avowed aim of this change is the increase of internal conductivity. The result is certainly an increase of cost.

SPEAKING of bichromate batteries, it appears to us that the true function of the porous cell now usually employed with them is entirely misunderstood. The bichromate solution, as prepared by the zinc in the cell on standing, is a colloidal substance. The

porous cell prevents this from mixing with the fresher strong solution outside, and thus enables the operator to remove the exhausted portion.

AN adaptation of the telephone to the needs of deaf persons has been brought out by one H. G. Fiske of Springfield (Massachusetts). To the centre of the disk of the receiving telephone is attached a short rod of wood, ebonite, or other elastic hard material which can be held between the teeth. The sonorous vibrations imparted to the disk by the magnet are thus transmitted mechanically to the auditory nerves through the teeth and the bones of the skull. The advantages are probably limited, since, as experiments with the audiphone have shown, only a small percentage of truly deaf persons retain the power of hearing through the teeth. In the greater majority of cases it is the auditory nerve itself, not the mechanical adjustments and auditory apparatus of the ear, that is the cause of deafness.

### GEOGRAPHICAL NOTES

SOME modifications have been made in the composition of the fifth International Expedition to Central Africa. Lieut. Harou, who was to have formed part of the expedition, will only join his companions at a later period on the Upper Congo. He is charged, meantime, with a secret mission to Africa, for the accomplishment of which about ten months are necessary. After the termination of this mission he will join the expedition. M. Harou will embark about the 23rd for his new destination. We learn that Dr. Dutrieux, who had to return from Africa to Belgium to recruit his health, is about to return to Africa to take part in the service for the abolition of slavery, at the head of which is Col. Sala. He had begun when in Africa a dictionary of the Suaheli language, so common all over Central Africa. Although incomplete, the Executive Committee of the Association have decided to print the dictionary as it is, and put it in the hands of travellers for correction and completion.

THE *Bereg* states that next autumn Baron Nordenskjöld will visit St. Petersburg to make preparations for his proposed expedition to the New Siberian Islands in 1882, the expenses of which will be borne by the Russian merchant, M. Sibirakoff. Nordenskjöld will go to the mouth of the Lena overland, and thence embark for his destination.

THE Congress of French Societies of Geography was held this year at Nancy during the first week of August. M. Levasseur, honorary president, gave an address, in which he reviewed the progress realised by the creation of so many geographical societies. In the evening the members were invited to the Town Hall, where they were entertained by M. Volland, the mayor. A number of toasts were delivered by his Worship, as well as by M. Levasseur and others.

A LETTER from Dr. Matteucci, written in May last, intimates the arrival of the expedition under Prince Borghese at El Fasher, the capital of Darfur, and the approaching departure for Wadai. Dr. Matteucci remarks on the almost absolute want of water in Darfur, and the consequent recent cultivation of water-melons by the natives as far as the arid soil will permit. They also utilise the Baobab tree in a curious manner. Hollowing out the huge trunk of the older trees by fire, they by some prehistoric primitive method get the hollow trunk filled with water during the rainy season, the water keeping sweet for eight months. The people of Darfur, Dr. Matteucci says, are still in a primitive uncultured condition, a contrast to the Egyptianised natives of Kordofan.

M. BISCHOFFSHEIM pays the expenses of M. G. Capu, a young geologist and botanist, who will accompany M. de Ujfalvy on his new mission to Central Asia, referred to last week; M. Gabriel Bovalt, as topographer and naturalist, will also accompany the mission.

### THE ALGÆ OF THE SIBERIAN POLAR SEA<sup>1</sup>

BEFORE the voyage of the *Vega* our knowledge of the algae of the Siberian Polar Sea outside the Kara Sea was limited to the fact of their existence in Tschann Bay and along the coast between that bay and the mouth of the Kolyma. This information was obtained by Baron Maydell, the leader of a scientific expedition sent out in 1869, under the auspices of

<sup>1</sup> Abstract of preliminary communication by Dr. F. R. Kjellman in "Öfvers. af Kongl. Vet. Akad. Förhandl.," 1879.

the Russian Geographical Society, to explore the Tschukchi Peninsula. A statement previously made by Mattiushin, one of Wrangel's companions during his Siberian journey, that algae exist at Tschann Bay, was thereby confirmed. Maydell brought home with him only three incomplete specimens of algae, which he obtained from a native living at Cape Schelagakoj. From the description given by him they appear to belong to the genera *Alaria* and *Laminaria*.

From observations made during the voyage of the *Vega* it appears that algae exist at several places along the whole coast of the Siberian Polar Sea. They occur almost exclusively within the sublittoral region. In the littoral area, which was the best and most completely examined during the expedition, Dr. Kjellman found only at two places, viz., between Port Dickson and Tajmur Island, an exceedingly scanty flora consisting of three species, two Floridæ—*Lithothamnion polymorphum* and *Phyllophora interrupta*—and a Phaeozoosporæ—*Lithoderma fatiscens*. The littoral region along the north coast of Siberia is, like that of the coasts of Novaya Zemlya and clearly for the same reasons, nearly everywhere devoid of algae. Only at two places did Dr. Kjellman find traces of a strand vegetation. They consisted of two small green algae, *Enteromorpha compressa* and *Urospora penicilliformis*, both known from the same region in other parts of the North Polar Sea. Fucaeæ occur nowhere within the littoral region, not a single individual of this group having been found at any of the places visited between Port Dickson and Koljuschin Fjord near Behring's Straits. To the east of this fjord there was found in the sublittoral region in limited quantity *Fucus evanescentis*, which is extensively distributed in the North Polar Sea. In the sublittoral belt of the bottom, too, the vegetation in the Siberian Polar Sea is very scanty. Dr. Kjellman had not an opportunity of examining any region where the flora was not considerably poorer in individuals than in those places on the coasts of Spitzbergen and Novaya Zemlya where algae are pretty abundant. The eastern portion of the sea appears to be somewhat less poor in algae than the western. The places where they most abounded were Cape Irkajppij—Cook's North Cape (N. L. 68° 55' W. L. 179° 25'), and the mouth of Koljuschin Fjord. From the natives settled between this fjord and Cape Serdze, situated about fifty miles to the east of it, Dr. Kjellman repeatedly obtained during the first half of 1879 very large masses of algae, which appears to show that a pretty abundant vegetation of algae is to be found at certain places along this part of the coast. There are not wanting, however, in the western part of the Siberian Sea some comparatively very good places for algae. One such at least was found, viz., the region round Tajmur Island, between Port Dickson and Cape Chelyuskin.

The species that occurred most frequently were *Polysiphonia arctica*, *Rhodomela tenuissima*, a variety of *Rhodomela subfusca*, *Sarcophyllis arctica*, *Phyllophora interrupta*, species belonging to the family Laminariæ, *Sphaelaria arctica*, and *Phloeospora tortilis*. The Laminariæ give in general their stamp to the vegetation; at one place however *Phyllophora interrupta*, at another the above-mentioned variety of *Rhodomela subfusca* occurred in quantity surpassing that of the Laminariæ.

Of this family six species were found, viz., four species of Laminaria: *L. Agardhii*, *L. cuneifolia*, *L. solidungula*, and one belonging to the digitata group, in which Dr. Kjellman believed that he recognised the *L. atro-fulva* of J. G. Agardh, and two species of Alaria, one standing near to *A. esculenta*, the other corresponding in much to *A. muscifolia*, but probably belonging each to species allied to these, and yet incompletely known, which occur in the north part of the Pacific. The distribution of the Laminaria along the north Siberian coast is different. *Laminaria solidungula* occurs both east and west of Cape Chelyuskin. *Laminaria Agardhii* was found only at that promontory and at a couple of places west, but nowhere east of it. Eastward it is replaced by *L. cuneifolia*, found first at Irkajppij and afterwards east of it in comparatively large quantities. Both the two species of Alaria and *Laminaria atro-fulva* appear also to be confined to the eastern portion of the Siberian Polar Sea. None of them were seen west of Irkajppij. Some of the species already mentioned as occurring most frequently enter into the composition of the vegetation in different proportions east and west of Cape Chelyuskin. *Polysiphonia arctica* and *Phyllophora interrupta* were more common west; *Rhodomela tenuissima* again more numerous east of the northernmost point of Asia. *Phloeospora tortilis* was nowhere seen east of Tajmur Island, nor *Sarcophyllis arctica* and the variety of *Rhodomela subfusca* west

of Irkajpij. Hence it follows that the algal flora differs in its composition in a noteworthy degree in the eastern and western portions of the Siberian Polar Sea.

It has been stated that an abundance of large-sized luxuriant plants is a characteristic of the Arctic algae. In this respect the vegetation of the Siberian Sea is considerably behind that in other parts of the North Polar Sea. The largest alga seen by Dr. Kjellman was a *Laminaria Agardhii*, whose length was 210 and greatest breadth 37 centimetres. Among the many specimens of *L. cuneifolia* examined there was none more than half so large as this. *L. solidungula* is about as large as middle-sized specimens of this plant from the coasts of Spitzbergen and Novaya Zemlya, about 90 centimetres long and 15 to 20 broad. The two species of *Alaria*, when they are largest, are about a metre in length. Other algae almost without exception are stunted in comparison with plants of the same species from other portions of the North Polar Sea.

The collections of algae made by Dr. Kjellman, according to the examination to which it has been possible to subject them, consist only of thirty-five species, of which there belong to the

Floridææ ... ..	12
Fucoidææ ... ..	16
Chlorophyllophyceæ ... ..	6
Phycochromophyceæ ... ..	1

These are not more than half as many as are known from the Murman and Spitzbergen Seas. With the exception of two, or possibly three, species, all also occur in other parts of the North Polar Sea.

The western part of the Siberian Polar Sea, at least to Cape Chelyuskin, must doubtless be considered to belong to the territory of the Spitzbergen marine flora, though poorer in individuals and species and more stunted than it. The algae in the eastern part of the same sea also in a considerable degree correspond with those on the coasts of Spitzbergen and Novaya Zemlya, but in the composition of its *Laminaria* vegetation it has a trait foreign to the latter, and indicating a connection with the algae in the north part of the Pacific.

ON THE COMPRESSIBILITY OF GLASS<sup>1</sup>

THE following experiments were undertaken with a view to determine by actual observation the effect produced on solids by hydraulic pressure. The instrument was constructed according to my directions by Mr. Milne, of Milton House, about two years ago, but it is only now that I have been able to devote myself to its application to the purposes for which it was designed. It consists of a hydraulic pump, which communicates with a steel receiver capable of holding instruments of considerable size, and also with a second receiver of peculiar form. This receiver consists essentially of a steel tube terminated at each end by thick glass tubes fitted tightly. It is tapped at the centre with two holes, the one to establish connection with the pump, and the other to admit a pressure-gauge or manometer. The steel tube may be of any length, being limited only by the extent of laboratory accommodation at disposal. The tube which I am using at present has a length of a little over six feet, and an internal diameter of about three-tenths of an inch. The solid to be experimented on must be in the form of rod or wire, and must, at the ends at least, be sufficiently small to be able to enter the terminal glass tubes, which have a bore of 0.08 inch, and an external diameter of 0.42 inch. The length of the solid is such that when it rests in the steel tube its ends are visible in the glass terminations.

When the joints have all been made tight the experiment is conducted as follows:—

A microscope with micrometer eyepiece is brought to bear on each end of the rod or wire. These microscopes stand on substantial platforms altogether independent of the hydraulic apparatus. The pressure is now raised to the desired height, as indicated by the manometer, and the ends of the rod are observed and their position with reference to the micrometer noted. The pressure is then carefully relieved and a displacement of both ends is seen to take place, and its amplitude noted. The sum of the displacements of the ends, regard being had to their signs, gives the absolute expansion in the direction of its length, of the glass rod, when the pressure at its surface is reduced by the observed amount, and consequently also by the compression when the process is reversed. As in the case of non-crystalline bodies, like glass, there is no reason why a given pressure should

produce a greater effect in one direction more than in another, we may, without sensible error, put the cubical compression at three times the linear contraction for the same pressure.

As yet I have only experimented on glass, and only on one sort, namely, that made by Messrs. Ford and Co. of Edinburgh. It contains lead, and is very suitable for glass-blowing purposes. I have not yet analysed it. I have observed its compressibility up to a pressure of 240 atmospheres, and before proceeding to higher pressures I intend to determine the compressibilities of other solids, especially metals at pressures up to 240 atmospheres. The reason for taking this course is that having got two glass tubes to stand this pressure I am anxious to utilise them as far as possible before risking them at higher pressures.

The pressure in these experiments was measured by a manometer, which consists simply of a mercurial thermometer with a stout bulb, which is immersed in the water under pressure, whilst its stem projects outside.

The values of the readings of this instrument were determined by comparing it with a piezometer containing distilled water. This piezometer had been compared with others which had been subjected to the pressure of very considerable and measured columns of water on the sounding-line.

The mean apparent compressibility of water in glass was thus found<sup>1</sup> to be 0.0004868, or, multiplying by 1,000, to reduce the number of figures 0.04868 per atmosphere at temperatures from 1° to 4° C.

The manometer (No. 2) was compared with this piezometer. The temperature of the manometer was 12.5° C., while the piezometer was enveloped in ice in the receiver. The ice was thus melting under the same pressure as the instrument was undergoing, consequently the piezometer was not exposed really to precisely the same temperature at each succeeding experiment.

For our present purpose the effect of the possible variation in volume due to this thermic cause is negligible, and we assume that the indications of our piezometer are comparable with those obtained in deep ocean waters. In a future communication I hope to return to this point.

In Table I. we have in the first column the number of observations meaned for each pressure from which the average values of the manometer-reading under A, and of the piezometer-indication under H are computed.

Manometer No. 2, when treated simply as a thermometer, showed at atmospheric pressure a rise of one division for a rise of 0.233° C. in temperature. Piezometer K, No. 4, was filled with distilled water, and contained 7.74 cubic centimetres at 0° and atmospheric pressure. It is made of Ford's glass, though not drawn at the same date as the experimental rod.

TABLE I.—Comparison of Manometer No. 2 at 12.5° C. with Piezometer K, No. 4, in ice melting under pressure

Piezometer K, No. 4, contains at 0° and atmospheric pressure 7.74 cub. cent. of water.	Pressure in divisions of manometer No. 2.	A.	H.
Temperature of manometer 12.5° C.	4	26.08	4.0228
Piezometer immersed in ice ... ..	4	30.28	4.6534
Melting under pressure A ... ..	1	36.20	5.5972
Probable temperature between - 1° and 0° C. ... ..	5	40.08	
	3	50.08	7.6043
	3	60.20	9.1057
	3	70.08	10.5163
Total number of observations ... ..	23		
Mean reading of manometer ... ..	43.61		
Mean apparent contraction of water in piezometer ... ..			6.6495

Dividing the mean apparent contraction of the water in the piezometer by the apparent compressibility of water in glass (0.04868), we have for the pressure corresponding to a rise of 43.61 divisions on manometer No. 2 at 12.5° C.

$$\frac{0.04868}{0}$$

<sup>1</sup> Proc. Royal Society of London, 1876, p. 16a.

<sup>2</sup> Substance of a paper read before the Royal Society of Edinburgh, June 21, by J. Y. Buchanan.

But this pressure produces a rise of 43.61 divisions on manometer No. 2. We have then for the value of one division on the manometer—

Hence to convert readings of manometer No. 2 into atmospheres we have to multiply by 3.132 the difference between the manometer reading under pressure and that at atmospheric pressure.

In another series of experiments piezometer K, No. 4, was compared with manometer No. 2, both being at a temperature of 12.5° C., and the following results were obtained as the mean of nineteen observations:—

Mean rise of manometer No. 2 ... (A) 41.35 divisions.  
 Mean apparent contraction per thousand of water in piezometer } (H) 5.8782  
 K, No. 4 ... .. .

But from the results in Table I. we have for the pressure in atmospheres—

$$P = 3.132 \times A = 3.132 \times 41.35 = 129.5 \text{ atmospheres.}$$

And the apparent compressibility of water in glass at this temperature (12.5° C.) in volumes per thousand per atmosphere is—

$$M = \frac{H}{P} = \frac{5.8782}{129.5} = 0.04539.$$

We see then that at pressures up to 240 atmospheres the property peculiar to water of diminishing in compressibility with rise of temperature is preserved unimpaired, and the amount of change corresponds closely with that found at low pressures in the experiments of Regnault and Grassi.

In Table II. the results obtained are summarised. In the first column we have the number of the series, and in the second the number of observations which constitute the series. Under T we have the temperature of the receiver and therefore of the rod in it. The experiments were made at the temperature of the room, which varied very slightly. The arithmetical mean of the values of T is 12.77° C. Under A we have the pressure in terms of the scale of the manometer; that is the difference between the readings of the manometer when the pressure was up and when it was equal to that of the atmosphere. Under P (3.132 × A) we have the pressure in atmospheres which is obtained by multiplying A by 3.132 (see Table I.) Under D we have the sum of the expansions observed at each end in terms of the micrometer, divisions which had identical values. Under F we have the values of D reduced to parts of an inch by multiplying them by 0.000417. Under Q we have the greatest deviations from the mean amongst the individual observations forming this particular series. R represents this deviation as a percentage of the total expansion (F). Under H we have the linear compression (in inches) of a rod one million inches long under a pressure of P atmospheres. K is the corresponding value for one atmosphere, and N = 3K is the cubical compression of the glass per million per atmosphere.

The total expansion on D was determined by observing the expansion at each end and adding them together. These partial expansions were not always, nor indeed often, of exactly the same extent; the excess was sometimes on the one side and sometimes on the other. The effect of the rise of pressure is to extend the containing tube and to compress the contained rod. On the relief of pressure the tube shortens again and the rod recovers its length, and there is necessarily a sliding of the one or the other, and it depends entirely on minute local circumstances whether the rod finds it easier to return to its original relative position or to another. In some experiments made previously to those quoted in Table II. the rod had greater freedom of motion longitudinally, and it happened several times that it crept bodily to the one end, necessitating the opening of the apparatus to replace it in a position suited to observation. Afterwards stops were placed in the tube, which, while setting limits to the crawling motion, did not in any way interfere with the expansion and contraction. The results of these previous experiments are not included in the table, because they were merely tentative with a view to learning the details of the kind of experimentation; and further, because in the microscope at the east end the power used was very low, and the micrometer insufficiently delicate.

The micrometers used were: at the east end a photographic copy of Hartnack's eyepiece micrometer, and at the west end one of Morz's. They were both compared, and the values of their divisions as used determined by comparison with a stage micrometer of Smith and Beck, obligingly lent me by my friend

Dr. William Robertson, who had very carefully verified its graduations. It is remarkable as a coincidence that the values of the divisions turned out to be identical, namely, 0.000417.

In the observations recorded I made no attempts to subdivide the micrometer divisions further than to estimate a half. As the micrometer readings are not affected directly by the pressure,

TABLE II.—Summary of Experiments on the Compression produced on a Glass Rod by Pressures up to 240 Atmospheres

Series No.	Number of observations included.	Temperature. Centis.	Pressure.		Compression of rod.		Greatest deviation from mean.		Linear compression per million per atmosphere.	Cubical compression per million per atmosphere.
			Manometer No. 2.	Atmospheres.	Micrometer divisions.	Inch.	Inch.	Per cent.		
1	6	13.5	A	P	D	F	Q	R	K	N
2	2	12.2	20.40	64	11.13	0.0047	0.00047	10.0	0.98	3.0
3	8	13.7	34.81	109	18.05	0.0075	0.00044	5.8	0.92	2.8
4	10	12.3	37.51	118	19.81	0.0083	0.00034	4.1	0.94	2.9
5	10	12.3	50.30	157	27.00	0.0113	0.00042	3.7	0.96	2.9
6	13	12.8	50.49	158	26.84	0.0112	0.00056	5.0	0.96	2.9
7	8	12.5	56.88	177	32.00	0.0133	0.00042	3.2	1.00	3.0
8	7	12.5	62.21	195	33.71	0.0140	0.00033	2.3	0.96	2.9
9	10	12.8	63.97	197	35.39	0.0148	0.00046	3.1	1.00	3.0
10	6	12.9	68.94	216	37.10	0.0155	0.00058	3.7	0.96	2.9
			76.53	240	40.08	0.0167	0.00059	3.5	0.93	2.8
									0.960	2.92

The micrometers used were eye-piece scale micrometers. The values of their divisions as used were identical. One division in the eye-piece corresponds to 0.000417 inch on the stage. Length of glass rod experimented on 75.95 inches. Diameter of ditto. 0.28 inches. Weight of rod 209.5 grammes. Date of experiments June 3, 4, and 7, 1880.

the deviation per cent. should be, as it is, the less the higher the pressure; and there is no doubt that the higher the pressure is the greater is the accuracy of the observation. The only way in which the pressure affects the reading of the micrometer is that when it is sufficiently high it produces a microscopic distortion of the tube which throws the point very slightly out of focus. This is remedied by a slight touch of the fine-adjustment screw of the microscope.

The general result of these experiments is that the linear compressibility of the glass experimented on is 0.96 and its cubical compressibility 2.92 per million.

Grassi<sup>1</sup> gives as the means of his observations at pressures up to ten atmospheres:

Glass ... 2.25 ... Crystal ... 2.804 and 2.8584  
 So that our results agree closely with those found by him for crystal.

<sup>1</sup> Ann. Chim. Phys., (1857) (3), 31, p. 477.



We have then the apparent compressibility of water in glass at 2.5° C. ... ..	0.04868	
Add compressibility of glass ... ..	0.00292	
True compressibility of water at 2.5° C. ...		0.05160
And the apparent compressibility of water at 12.5° C. is ... ..	0.04539	
Add compressibility of glass ... ..	0.00292	
True compressibility of water at 12.5° C. ...		0.04831
Grassl gives the following values for the true compressibility of water at various temperatures:—		
At 4.1° C. ... ..	0.0515	
Mean ... ..	0.0499	0.0507
At 10.8° C. ... ..	0.0480	
At 13.4° C. ... ..	0.0477	
Mean ... ..		0.0478

My results agree very closely with these. Before concluding I would call attention to a very curious phenomenon which I have never seen noticed, namely, the peculiar noise which accompanies the relief of pressure in a mixture of ice and water.

In comparing the Piezometer K No. 4, in melting ice with the manometer at 12.5° C., I proceeded gradually from lower to higher pressures. When the pressure which was relieved was 100 or 120 atmospheres, I thought I noticed a slight noise. On raising the pressure higher the noise became more and more distinct, until when the pressure relieved was over 200 atmospheres, it was distinctly audible at a distance of 5 feet or 6 feet. It resembles the noise produced by bending a piece of tin backwards and forwards, and is markedly intensified by accelerating the relief, just as the noise made by blowing off steam is intensified by enlarging the outlet. When the relief valve is opened very carefully it whispers gently but very distinctly, till the pressure is all down. If opened comparatively briskly, but still with great care, the noise is comparatively loud but more rapidly used up. I forbear making any reflections until I have been able to study this phenomenon more closely.

Pieces of clear ice which had been subjected to high pressure in the receiver were finely laminated in parallel planes. In each plane there was a central patch surrounded near the sides of the block by a ring of spherules.

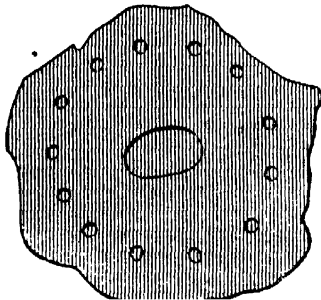

The annexed figure gives an idea of the arrangement in a plane of lamination; the size of the spherules is greatly rated.

Lamination of ice by pressure in one direction is well known. I am not aware that its production by pressure in all directions has been noticed. I hope to pursue my observations on this subject.

J. Y. BUCHANAN

THE CONGRESS OF BOHEMIAN PHYSICIANS AND NATURALISTS

and M. Studnicka. The first general meeting was opened by M. Krejci, Professor of Geology, who delivered an inaugural address "On the share of the Bohemian Nation in the Development of Natural Science." He showed that not only Bohemian workers in science were in the field up to the seventeenth century, but that when the Bohemian nation, after two centuries of political and national slavery, awoke to life again, it very soon

took its part in the progress of natural science. The of Purkyne, Rokytanský, Skoda, Bohdátek, Pitha, Blazina, Safarik, Celakovský, Fric, Krejci, Helmbacker, and of many others, are known even beyond the boundaries of Bohemia. Many obstacles were placed in the way of these promoters of science; they were not assisted by Government, and even the ancient university of Prague was, and indeed is, almost exclusively German. But in spite of all difficulties scientific progress went on steadily, and at present the number of workers in science is very fair. Knowing the cosmopolitan character of science, the Bohemian nation values equally the progress made in England, France, Germany, Italy, and Russia; it wishes only that its own share—if proportionately small—may be recognised by others. The great languages of the world are like the sea, which carries the ships and steamers of all nations; but the languages and literature, of small nationalities—of the Danes, Swedes, Dutch, and Bohemians—resemble so many rivers irrigating and fertilising the continents by which the sea is surrounded.

On May 15 and 17 sectional meetings took place. On the 16th the members visited the village Chuchel, where Prof. Krejci explained to them the very interesting distortions of the silurian strata on the left bank of the river Vitava (Moldau). In the evening of the same day the members assembled at a banquet, where especially the healths proposed by Prof. Safarik were heartily responded to. He spoke first of the progress of science in Bohemia and its relation to scientific investigation in England and France; he then proposed the health of the distinguished Russian naturalists, referring chiefly to Mendeleeff, Butleroff, Menshutkin, Chebysheff, Shecheneff, Mechnikoff, and Kowalewski; finally he drank to the Nestor of paleontological research, to Joaquin Barrande, who at Prague has carried out the chief part of his scientific work.

In the first section (medicine) papers were read on purely professional subjects.

The second section was devoted to mathematics. Besides several mathematical papers Prof. Augustin spoke on cyclones and anticyclones; M. Doubrava read a paper on electricity; M. Domalip explained the action of a magnet on a current of electricity traversing a rarified medium; Prof. Charles Zengef gave an account of his method of constructing achromatic lenses by means of a combination of crown-glass and certain liquids. Excellent microscopic photographs made by the aid of these lenses were shown. For astronomical purposes lenses with an opening of 2 inches and a focal distance of only 9 inches have been constructed according to this method with complete success.

In the third section (Natural Science) the following papers were read:—Prof. Borický, on the structure of the Bohemian porphyries. He showed that they frequently contain the mineral "cordierite," which hitherto had not been found in Bohemia. According to Prof. Borický a great part of the Bohemian porphyries must be classed as siliceous porphyrites. Prof. Fric demonstrated a new genus of the ganoids found at Kounová, near Rakovník. This fish resembles the genus Palæoniscus, but its scales are very different. He gave to the new genus the name of *Trissolepis kounoviensis*.

M. Bayer gave a report on the characters of the skulls of some batrachia. Comparing the skull of the genus *Pelobates* with that of other genera, he found that the skull of *Pelobates* differs essentially from all others, and that this genus does not form the connecting link between the *Ranidæ* and the *Bufo*idæ. M. Hellich read a report on the genital apparatus of the genus *Cypris*. He supplemented the data given by Zenker, and corroborated in a certain sense the new observations of Weissmann. A series of plates belonging to a new work on Bohemian cretaceous Echinodermata was shown by Dr. Ottomar Novák, and their peculiarities were explained. M. Ladislav Duda gave a preliminary account of the anatomy of the Bohemian hemiptera, especially of the section *Scutata*. He has discovered on the fore feet of these insects a comb-like apparatus, by means of which the insect cleans its tentacles. In Bohemia as yet 401 species of hemiptera have been found. Prof. Borický showed to the members many interesting novelties in mineralogy, as, e.g., the *Rösserit*, a mineral of which as yet only three specimens are known. Dr. Vejdovsky exhibited the second part of his work on the comparative morphology of the annelids, containing a new system of the *Oligochaeta* and their anatomical details, together with their affinities to the *Turbellaria* and *vertebrata*. Dr. Vejdovsky proposes the following arrangement of the new families of the *Oligochaeta*: (a) *Chetopoda*, (b)

Diacodrilida (Branchiobdella), (4) Naidea, (5) Echytraeida, (6) Tubificida, (7) Lumbriculida, (8) Phreorsetida, (9) Criodrilida, (10) Lumbricida. M. V. Fric showed to the members a specimen of the body of a chimpanzee, four years old, which was prepared by the injection of Wickersheim's conserving fluid. He explained all methods hitherto known and used to preserve the bodies of animals, and he declared the method of Wickersheim to be the best of them.

In chemistry some interesting papers were read and an animated discussion took place on educational and scientific questions.

On the 17th the second general meeting took place, Prof. Albert, of the Innsbruck University, delivering an address "On Theory and Practice in University Education."

During the session of the Congress a journal was published containing the abstracts of the papers read before the Congress. The addresses of M. Krejci and Dr. Albert, however, were printed *in extenso*, and of the former afterwards also a German translation appeared in print.

SCIENTIFIC SERIALS

*Archives des Sciences Physiques et Naturelles*, July 15, No. 7.—Note on the equilibrium of solids of great dimensions, by M. Cellier.—Geological description of the Canton of Geneva, by M. Favre.—Phytography, &c. (M. de Candolle), by M. Micheli.—A differential thermometer for demonstration, by M. Dufour.—On the casting of the beak of birds of the Mormonides family, by M. Bureau.

*Reale Istituto Lombardo di Scienze e Lettere Rendiconti*, vol. xiii. Fasc. xiii. June 17.—On some trigonometric series, by Prof. Beltrami.—Morphological studies on the human body, by Prof. De Giovanni.—On the part taken by the pneumogastric in death by hanging, by Prof. Tamassia.—Iconography of the Laplanders, by Prof. Mantegazza.—On reflex arthropathia of urethritis, by Prof. Scarenzio.—On a geological congress held at Rome, by Prof. Taramelli.

Fasc. xiv., July 1.—Ossiferous breccia and neolithic station in Corsica, by Dr. Major.—On the present geographical distribution of *Nyctinomus cestonii*, Gavi., by Dr. Beltoni.—On a shower of falling stars observed at Milan on June 22, 1880, by S. Fornioni and Prof. Schiaparelli.—On univocal plane transformations and particularly on involuntary, by Prof. Bertini.—Notes on the fishes, and in particular on the male eels, observed at the Berlin Exhibition, by Prof. Pavesi.

SOCIETIES AND ACADEMIES

PARIS

Academy of Sciences, August 9.—M. Wurtz in the chair.—The following papers were read:—Summary report of a zoological exploration in the Bay of Biscay in the Government ship *Le Travailleur*, by M. A. Milne-Edwards.—Experiments tending to prove that fowls vaccinated for cholera are refractory for *charbon*, by M. Pasteur.—Results of observations of solar spots and faculae during the first two quarters of 1880, by P. Tacchini. The numbers indicate rapid increase of solar activity. The days without spots form five groups separated by a mean interval of twenty-nine days, showing that in one hemisphere (which is that visible in the end of last December) the spots were formed with difficulty.—On a class of linear differential equations of the second order, by M. Brioschi.—Experiments on the discharge in rarefied gases, by M. Righi. *Inter alia*, the glass seems to become luminous at the point where it acts as positive electrode. During discharge the negative electrode is probably much more heated than the positive. The cause of mechanical action of the negative electrode is the same as in the radiometer.—On some properties of flames, by M. Meyreneuf. The gas which feeds a flame is subject to two opposing influences, one creating a draught outwards, the other (expansion through combustion) tending to drive the gas back. By diminishing the rate of outflow without modifying the combustion, one may regulate these movements so as to get vibrations of the nature of sound. Better sonorous effects are had by making a flame impinge on a round rod or on another flame.—Indices of refraction of aqueous solutions of acetic acid and of hyposulphite of soda, by M. Damien.—On an improvement of the Bunsen battery by M. Azapi, by M. Ducretet. For acidulated water is substituted

a 15 per cent. solution of cyanide of potassium, caustic potash, marine salt, or ordinary sal ammoniac. The zincs need not be amalgamated. They are less consumed than in the Bunsen; the intensity of the current is no less, and its constancy is remarkable.—On the spectra of ytterbium and erbium, by M. Thalén.—On thulium, by M. Clève.—Researches on the heats of combustion of some substances of the fat-series, by M. Louguinine.—Secondary reaction between sulphuretted hydrogen and hyposulphite of soda, by M. Bel'amy.—On the acid obtained by M. Boutroux in the fermentation of glucose, by M. Maumené.—On a new process for producing malleable nickel of different degrees of hardness, by M. Garnier. This consists in incorporating phosphorus with the nickel (to take up oxygen); e.g., adding to the bath of nickel a phosphide of nickel containing about 6 per cent. phosphorus. Very thin sheets of the material can be produced.—On propylnerve, by Mr. Morley.—Influence of light on transpiration of plants, by M. Comes. Plants transpire more in light than in darkness, and more the intenser the light. The more intense the colour of the organ, the greater the transpiration. The luminous rays absorbed alone favour the transpiration.—On the source of muscular work and on supposed respiratory combustions, by M. Sanson. The liberation of energy is due greatly, if not wholly, to phenomena of dissociation similar to those in fermentations; in presence of anatomical elements (blood-corpuses specially) the immediate principles of the plasma are dissociated, give carbonic acid and doubtless other compounds which borrow oxygen from the haemoglobin for their formation, and yield their energy to the muscular elements, which then manifest it by doing work in contracting, or to the blood for maintenance of animal heat.—On the use of nitrite of ethyl for rendering contaminated places healthy, by M. Peyrussou. It acts like ozone, but more powerfully.—Complement of the biological evolution of pucerons of galls of poplar (*Pemphigus bursarius*, Lin.), by M. Lichtenstein.—On the affinities of the genus *Polygordius* with annelids of the family of *Opheliidae*, by M. Giard.—Discovery of new mammalia in the phosphate of lime deposits of Quercy (Upper Eocene), by M. Filhol.—On the structure and functions of the embryonal suspensor in some leguminous plants, by M. Guignard.—On deforming pilosism in some plants, by H. Heckel.—On a new instrument for pointing guns, by M. Arnoux.

CONTENTS

PAGES

COLOURS IN ART . . . . .	357
A VISIT TO ETNA. By G. F. RODWELL . . . . .	359
OUR BOOK SHELF.—	
Petersen's "Methods and Theories for the Solution of Problems of Geometrical Construction, applied to 410 Problems," and	
Text-book of Elementary Plane Geometry . . . . .	360
Tilden's "Practical Chemistry" . . . . .	360
LETTERS TO THE EDITOR.—	
A Rotatory Polarisation Spectroscope of Great Dispersion.—Prof. P. G. TAIT ( <i>With Diagram</i> ) . . . . .	360
Dimorphism in NATURE on June 17.—Prof. E. RAY LANKESTER, F.R.S. . . . .	361
Magnetic and Earth-Current Disturbance.—WILLIAM ELLIS . . . . .	361
Aurora Borealis and Magnetic Storms.—Rev. S. J. PERRY, F.R.S.; J. A. B. OLIVER; F. T. MOTT; B. W. S. . . . .	361
Height of the Aurora.—JOHN I. PLUMMER . . . . .	362
Fire Ball.—Rev. S. J. PERRY, F.R.S. . . . .	362
Atmospheric Phenomenon.—B. W. S. . . . .	362
Intellect in Brutes.—Dr. HENRY MACCORMAC . . . . .	363
Radiation—A Query.—F. G. S. . . . .	363
"On a Mode of Explaining the Transverse Vibrations of Light"—The Expression "Radiant Matter."—S. TOLVER PRESTON . . . . .	363
Earthquake in Smyrna.—HYDE CLARKE . . . . .	363
New Biological Term.—D. SHARP . . . . .	364
Depraved Taste in Animals.—F. R. GREENWOOD . . . . .	364
Firing a Tallow Candle through a Deal Board.—C. J. WOODWARD . . . . .	364
THUNDERSTORMS. II. By Prof. TAIT . . . . .	364
HUMAN HYBERNATION . . . . .	366
PHYSICS WITHOUT APPARATUS, III. ( <i>With Illustrations</i> ). ON THE ABSORPTION BANDS IN CERTAIN COLOURLESS LIQUIDS. By Dr. WILLIAM J. RUSSELL, F.R.S., and WILLIAM LAPRAIK ( <i>With Diagram</i> ) . . . . .	368
CELLULOSE . . . . .	370
L. F. DE FOURTALES. By Prof. ALEXANDER AGASSIZ . . . . .	371
NOTES . . . . .	372
OUR ASTRONOMICAL COLUMN:—	
The August Meteors . . . . .	374
Cape Observations of Comet 1880 (I) . . . . .	374
PHYSICAL NOTES . . . . .	375
GEOGRAPHICAL NOTES . . . . .	376
THE ALGÆ OF THE SIBERIAN POLAR SEA. By Dr. F. R. KJELLMAN . . . . .	376
ON THE COMPRESSIBILITY OF GLASS. By J. Y. BUCHANAN . . . . .	377
THE CONGRESS OF BOHEMIAN PHYSICIANS AND NATURALISTS . . . . .	379
SCIENTIFIC SERIALS . . . . .	380
SOCIETIES AND ACADEMIES . . . . .	380

THURSDAY, AUGUST, 26, 1880

## DR. BASTIAN ON THE BRAIN

*The Brain as an Organ of Mind.* By H. Charlton Bastian, M.A., M.D., F.R.S. International Scientific Series. (London: Kegan Paul and Co., 1880.)

WITHOUT preface or other proposition than that suggested by the title of his book, Dr. Bastian commences to deal with his subject by an inquiry into the Uses and Origin and the Structure of a Nervous System. His motive, as expressed farther on, in giving such a wide scope to himself in his method of exposition was to ascertain whether the general similarity in structure of the nervous system in the lower animals as compared with that of man, "carried with it a general similarity in mode of action." To all those who, like Dr. Bastian, look upon mental phenomena from the evolutionary aspect—aiming as they do at reducing psychology to a more or less transcendental branch of physiology—this, if not a necessary, seems at least to be a favourite plan. Such readers as require to be initiated into the earliest mysteries of zoology and physiology must find this method a useful one, inasmuch as by submitting themselves to the guidance of an accomplished and trustworthy guide such as Dr. Bastian, they are led with ease and interest through a field of attractive information to the consideration of the main problem which the author keeps continually in view. To the author himself, however, the method is one which is not free from disadvantages. It leads him, for instance, at the very beginning of his task into the most hypothetical region of evolutionism, namely, that which has to do with the commencement of divergences from the homogeneous to the heterogeneous in structure and function; and so affords to sceptics and even to others who may have a stronger predisposition to accept his views, an opportunity of assigning to his argument a weakness which is inherent not in the argument itself but in the present state of a rapidly-progressing branch of science, of which he has submitted a sketch for the guidance of his readers. When Dr. Bastian, for instance, discusses the method in which muscular tissue may be produced by recurring contractions, his language is necessarily so hypothetical that his readers may incline to think that a work which commences in such a nebulous form can scarcely end in the satisfactory exposition of a new philosophy. It is a pity that false conclusions should be suggested by sentences which have no direct or essential connection with the author's argument.

When, however, Dr. Bastian has disposed of the preliminary parts of his work he enters with emphasis into the statement of his views regarding the Scope of Mind. He considers it a "legitimate inference" that the term "Mind" no more corresponds to a definite self-existing principle than the word 'Magnetism.' He repeats the demonstration of the fallacy which pervades every region of introspective metaphysics (H) that, namely, of regarding all mental phenomena as being limited or bounded by the sphere of consciousness; and, with admirable clearness, expands into a definition the title of his work.

"In treating of 'The Brain as an Organ of Mind,'" he says "it will be understood that we use the word 'organ' merely in the sense that it is a part whose molecular

changes and activities constitute the essential *correlatives* (the italics are ours) of those phases of Consciousness known as Sensations, Emotions, Thoughts, and Volitions, as well as of a considerable part of the sum total of those other related nerve actions which are unattended by Consciousness, and whose results form, in accordance with the views above stated, so large a proportion of the phenomena comprehended under the general abstract word 'Mind.'"

This sentence expresses admirably the position which has been arrived at by all who have studied psychology from the biological point of view, and it is difficult to understand how such a moderate statement of the relationship of Mind to Brain should require in Dr. Bastian's and other recent books to be supported by an imposing presentation of facts relating to the comparative anatomy and physiology of the nervous system.

Dr. Bastian's volume is a valuable and opportune addition to the International Scientific Series. It will supply a want which has been much felt by specialists as well as by general readers who have been desirous of obtaining a knowledge of the opinions held by exponents of this line of thought—a class of writers whose style is apt to be obscure, and whose writings are too frequently contained in scattered and unattainable periodicals. The writer of this work deserves to be complimented on the success with which he has propounded his own special views regarding brain functions without assigning to them such an undue predominance as to rob his work of the credit of being a fair and comprehensive statement of what has been discovered and believed by other workers in the same field. Dr. Bastian writes in all departments of his subject with that ease and clearness which are indicative of perfect knowledge. If in anything this statement does not hold good the exception could be made only with regard to an apparent tendency to do some little injustice to the views of Hughlings-Jackson by attaching a meaning to some of his terms which is too bald and mechanical. Dr. Bastian excludes the processes taking place in the Motor Centres of the Cerebrum from "the cerebral substrata of Mind," and he cannot consequently be expected to lavish much sympathy on doctrines of an opposite tendency.

"The Cerebral substrata of Mind," he says, "in no way include, as the writer believes, the processes taking place in the Motor Centres of the Cerebrum wheresoever they may be situated. Mental operations, in other words, can no longer be legitimately postulated as being in part immediately due to the activity of Motor Centres. Nor can 'ideal' words be rightly described as 'motor processes.' This is a point so fundamental that in regard to it there should be no misunderstandings or ambiguities other than those which may be inherent in the subject itself."

Similarly the author speaks of "Mind as comprising the results of all nerve actions, other than those of outgoing currents." To us this exclusion of the motor element from the constitution of mind and the range of mental phenomena appears somewhat arbitrary, and, from an evolutionary point of view, unnatural; but the opponents of Dr. Bastian's views will prefer to fight their own battle, and the question is one which as yet has not been sufficiently discussed to justify a critical judgment.

Some of the last chapters of this excellent work are specially rich in information and suggestiveness. That on "Will and Voluntary Movements" deals lucidly with a difficult subject; and the chapters on "Speaking, Reading, and Writing," and on "The Cerebral Relations of Speech and Thought" contain much valuable information regarding the physiology and pathology of intellectual expression and the light which they throw upon the nature of mind as a function of the brain—a phrase which must be read subject to the explanation which Dr. Bastian gives of the title of his work. There may be some reason to doubt whether transcendental metaphysicians will be prepared to admit that their belief in mind as an entity has been so completely destroyed, as Dr. Bastian thinks, by the demonstration of the doctrine of unconscious cerebration and the consequent vitiation of all deductions drawn exclusively from within the range of consciousness; but there is no room for doubt that metaphysicians of all shades must make themselves familiar with such researches as those embodied in Dr. Bastian's work. Should they fail to do so they must be prepared to find their carefully-nurtured speculations exposed to many severe rebuffs, and open at all times to that kind of merciless danger which theories experience when they run against conflicting facts.

This work is the best book of its kind. It is full, and at the same time concise; comprehensive, but confined to a readable limit; and though it deals with many subtle subjects it expounds them in a style which is admirable for its clearness and simplicity.

#### LETTERS TO THE EDITOR

[The Editor does not hold himself responsible for opinions expressed by his correspondents. Neither can he undertake to return, or to correspond with the writers of, rejected manuscripts. No notice is taken of anonymous communications.]

[The Editor urgently requests correspondents to keep their letters as short as possible. The pressure on his space is so great that it is impossible otherwise to ensure the appearance even of communications containing interesting and novel facts.]

#### Eozoic and Palæozoic

PERMIT an old worker in fossils to protest mildly against the slapdash manner in which writers sometimes hit off great palæontological questions. In your review of Roemer's valuable "Lethæa Palæozoica" it is stated that in regard to *Eozoön canadense*, he "accepts the verdict of Möbius against its organic origin, and rejects it from the list of palæozoic fossils." Now as to the acceptance of the "verdict" in question, I have nothing to say, except that the naturalist to whom are assigned the functions of judge and jury in the case very obviously lacks some of the qualifications for that high office, and has not been recognised by those best qualified to understand the case of *Eozoön*. But why Roemer or your reviewer should "reject *Eozoön* from the list of palæozoic fossils" I am at a loss to understand. As a writer on palæozoic fossils, Roemer has nothing to do with *Eozoön*. It belongs to that great series of eozoic or archæan formations which precedes the palæozoic, and which probably represents quite as long a period. Little comparatively is known of the fossils of these oldest rocks; but what we do know of their *Eozoön*, *Archæospherina*, *Spiral arenicolites*, and *Aspidiella*, and of their immense deposits of graphitised plants, is sufficient to assure us that the life of the eozoic period was very different from that of the palæozoic; *Eozoön*, whatever its nature, is one of the most characteristic of these eozoic fossils. It has been recognised through a great vertical thickness of beds, and over so wide areas, that it is now equally characteristic of eozoic rocks in Canada and Brazil, in Bavaria and in Scandinavia. Further, it has obviously been connected with the accumulation of some of the greatest limestones of the eozoic time.

One can excuse a palæontologist familiar only with mesozoic or kainozoic fossils, when he doubts as to the organic nature of such obscure markings as *Oldhamia*, or even as to those wrinklings and scratchings on Cambrian slates which are recognised as trilobites and sponges; but we never think of asking him to accept or reject them as mesozoic fossils. In like manner those who are working out the dim traces of life remaining in the eozoic rocks will be content if geologists who scarcely condescend to recognise these great formations in their arrangements will abstain in the mean time from pronouncing judgment on eozoic remains supposed to be organic.

To us in Canada who have long regarded the eozoic formations as being quite as important in a physical point of view as the palæozoic, it is a matter of congratulation that they are now attracting so much of the attention of British geologists. Their palæontology, it is true, is still meagre, but our knowledge of it is gradually increasing, and those who have lived to see the Cambrian fauna grow from nothing to its present satisfactory condition need not despair of the Laurentian or Huronian.

Montreal, August 5

J. W. DAWSON

#### Algæ

I NOTICE in NATURE, vol. xxii. p. 319, that amongst other subjects you answer inquiries about minute "algæ."

I venture to send you herewith specimens of one of the Oscillatoriaceæ, which I believe is rare. In form it is nearest to what is described in the "Micrographical Dictionary" as "*Spirulina oscillarioides*" (Turp.?), but it is very much larger. When two join and intertwine they form a cable. Under an  $\frac{1}{4}$ th objective it is a most striking object; it has the characteristic deep blue-green colour, and also its movements.

I shall be glad to know if it has been described by any one.

G. F. CHANTRELL

St. James's Mount, Liverpool, August 6

[The alga is *Spirulina jenneri*, Kütz., and the *Spirillum jenneri*, Hassall. It is described in the "Fresh Water Algæ" of the latter author, and the description occurs also in Rabenhorst's "Algæ aquæ-dulcis."

During this year, in a paper read by the Rev. J. E. Vize at the Montgomery Society, and printed in their *Proceedings*, it is called *Spirulina oscillarioides*, but it is larger, and more distinctly articulated than that species. The figure given by Mr. Vize is accurate. It is not very common, but we have heard of it in two or three localities during the past twelve months.—ED.]

#### Lightning Conductors

I SHALL feel exceedingly obliged if you will have the kindness to reply to the following question:—The painter of my villa (Villa Calpe) having taken the liberty to paint the chain of the lightning conductor attached to my house, I should like to know whether it will interfere with the efficiency of the apparatus.

CATHERINE MCPHERSON DE BREMON

Biarritz, August 5

[A coat of paint on a lightning conductor will not at all affect its efficiency. It will protect it from rust, which of course is an advantage. But if the note is to be read literally and a *chain* is used as a conductor, it is the worst possible form, and it ought to be changed for a continuous conductor. The links of a chain only touch each other at *points*, so that even a link made of half an inch in diameter of metal is reduced to the size of  $\frac{1}{4}$ th than  $\frac{1}{4}$ th of an inch of metal. We would rather trust to a copper wire of  $\frac{1}{4}$ th than to a *link* of much larger size. A point of great importance is to have a good discharge in the earth, either wet soil or a large quantity of metal joined to the conductor.—ED.]

#### Strange Method of Crossing a Torrent

REFERRING to the inquiry of your correspondent as to the existence in modern times of the practice of carrying a stone to steady oneself whilst crossing a torrent, I may state that it is well known to the inhabitants of mountainous districts, and though practically it may not often have to be resorted to in Switzerland, where the streams are mostly well bridged, I have myself been glad to adopt it in Dauphiné. As, however, a weight on the head or shoulders would, by raising the centre of gravity, rather diminish than add to the steadiness of the bearer, it is more usual to fill the lower side pockets of the coat, at

haps take a large stone in each hand, and I have certainly found this useful in traversing rapid glacier streams when mid-thigh deep. Frenchay, near Bristol, August 18 F. F. TUCKETT

#### Fascination

Is it a fact that snakes can fascinate birds? With reference to the fascination of man, the ingenious explanation offered in NATURE, vol. xxii. p. 338, seems to me unsatisfactory, in that it supposes the individual fascinated to be self-conscious in a degree necessary for the consideration which of two courses to adopt to escape danger. This supposition implies an amount of self-consciousness which surely is absent in such cases as narrated? I have frequently experienced this fascination when standing on the railway platform as the engine was steaming in, and with myself at those times it was to be accounted for by the *absorption of attention by the external object, little being left for self*. That cries for assistance showed consciousness of danger, as in cases mentioned by Mr. Curran in NATURE, vol. xxii. p. 318, might be explained by the fact that these would follow on a much less attention to self than would be required for movement to carry the body out of danger. Indeed they would be the outcome of *feeling* rather than of *thought*. This view seems to be borne out by the very description of those fascinated, e.g., "have had their senses so engaged by a shell in its descent," "whose every gyration in the air he could count" (NATURE, vol. xxii. p. 318), and it is expressed definitely by Mr. Spencer ("Principles of Psychology," vol. ii. p. 438) :—

"When the external object or act is an astounding one, the observer partially loses consciousness of himself. He is, as we say, *lost* in wonder, or has *forgotten* himself; and we describe him as afterwards *returning* to himself, *recollecting* himself. In this state, the related impressions received from the external object, joined with representations of the objective changes about to follow, monopolise consciousness, and keep out all those feelings and ideas which constitute self-consciousness. Hence what is called 'fascination;' and hence the stupefaction on witnessing a tremendous catastrophe. Persons so 'possessed' are sometimes killed from the inability to recover self-consciousness in time to avoid danger." RICHARD HODGSON  
Cambridge, August 17

#### "Hyper-Space"

If some one learned in many dimensions would throw some light on *rudimentary contour lines in hyper-space*, it would doubtless interest many readers of NATURE, and inconceivably yours,  
August 9

$$\sqrt{-1}$$

#### THE BRITISH ASSOCIATION

THE fiftieth Annual Meeting of the British Association was opened yesterday evening at Swansea, when Prof. Allman resigned the presidential chair to Prof. Ramsay, who gave his inaugural address.

At midday on Monday the reception rooms at the Agricultural Hall, St. Helen's Road, were formally opened for the transaction of the business of the Association, under the direction of Mr. Gordon, the permanent under-secretary of the general staff, and the local honorary secretaries, Dr. Wm. Morgan and Mr. James Strick, and their efficient local staff. The hall, our Swansea correspondent informs us, is admirably situated on the borderline that separates the business part of the town from the west end residential suburbs, and the conveniences of the place are augmented by a good line of tramway and a temporary cab-stand in front, and telegraph, telephone, and post-office within the building. The arrangements had been brought to a very creditable state of completion by Monday, and the visitors have been pouring into the town steadily since Saturday. The suburban watering-place of Oystermouth, or The Mumbles, and many others of the favourite summer resorts of Gower are full to overflowing, but in the more immediate out-  
the town, on the gently-sloping hill-sides that excellent fresh air and such extended prospects  
one and sea-view, there is ample accommoda-

tion for all comers, thanks to the really warm local hospitality and to the careful arrangements of the Local Committee.

A fair number of papers are down for reading in the various sections, the usually popular section of geography, however, exhibiting a sad dearth of contributions; we trust things may look brighter here before the end of the meeting.

INAUGURAL ADDRESS OF ANDREW CROMBIE RAMSAY, LL.D., F.R.S., V.P.G.S., DIRECTOR-GENERAL OF THE GEOLOGICAL SURVEY OF THE UNITED KINGDOM, AND OF THE MUSEUM OF PRACTICAL GEOLOGY, PRESIDENT

#### On the Recurrence of Certain Phenomena in Geological Time

IN this address I propose to consider the recurrence of the same kind of incidents throughout all geological time, as exhibited in the various formations and groups of formations that now form the known parts of the external crust of the earth. This kind of investigation has for many years forced itself on my attention, and the method I adopt has not heretofore been attempted in all its branches. In older times, Hutton and Playfair, in a broad and general manner, clearly pointed the way to the doctrine of uniformity of action and results, throughout all known geological epochs down to the present day; but after a time, like the prophets of old, they obtained but slight attention, and were almost forgotten, and the wilder cosmical theories of Werner more generally ruled the opinions of the geologists of the time. Later still, Lyell followed in the steps of Playfair, with all the advantages that the discoveries of William Smith afforded, and aided by the labours of that band of distinguished geologists, Sedgwick, Buckland, Mantell, De la Beche, Murchison, and others, all of whom some of us knew. Notwithstanding this new light, even now there still lingers the relics of the belief (which some of these geologists also maintained), that the physical phenomena which produced the older strata were not only different in kind, but also in degree from those which now rule the external world. Oceans, the waters of which attained a high temperature, attended the formation of the primitive crystalline rocks. Volcanic eruptions, with which those of modern times are comparatively insignificant, the sudden upheaval of great mountain chains, the far more rapid decomposition and degradation of rocks, and, as a consequence, the more rapid deposition of strata formed from their waste—all these were assumed as certainties, and still linger in some parts of the world among living geologists of deservedly high reputation. The chief object of this address is, therefore, to attempt to show, that whatever may have been the state of the world long before geological history began, as now written in the rocks, all known formations are comparatively so recent in geological time, that there is no reason to believe that they were produced under physical circumstances differing either in kind or degree from those with which we are now more or less familiar.

It is unnecessary for my present purpose to enter into details connected with the recurrence of marine formations, since all geologists know that the greater part of the stratified rocks were deposited in the sea, as proved by the molluscs and other fossils which they contain, and the order of their deposition and the occasional stratigraphical breaks in succession are also familiar subjects. What I have partly to deal with now, are exceptions to true marine stratified formations, and after some other important questions have been considered, I shall proceed to discuss the origin of various non-marine deposits from nearly the earliest known time down to what by comparison may almost be termed the present day.

*Metamorphism*.—All, or nearly all, stratified formations have been in a sense metamorphosed, since, excepting certain limestones, the fact of loose incoherent sediments having been by pressure and other agencies turned into solid rocks constitutes a kind of metamorphism. This, however, is only a first step toward the kind of metamorphism the frequent recurrence of which in geological time I have now to insist upon, and which implies that consolidated strata have undergone subsequent changes of a kind much more remarkable.

Common stratified rocks chiefly consist of marls, shales, slates, sandstones, conglomerates, and limestones, generally distinct and definite; but not infrequently a stratum, or strata, may partake of the characters in varied proportions of two or more of the above-named species. It is from such strata that meta-

morphic rocks have been produced, exclusive of the metamorphism of igneous rocks, on which I will not enter. These may be looked for in every manual of geology, and usually they may be found in them.

As a general rule, metamorphic rocks are apt to be much contorted, not only on a large scale, but also that the individual layers of mica quartz and felspar in gneiss are bent and folded in a great number of minute convolutions, so small that they may be counted by the hundred in a foot or two of rock. Such metamorphic rocks are often associated with masses of granite both in bosses and in interstratified beds or layers, and where the metamorphism becomes extreme it is often impossible to draw a boundary line between the gneiss and the granite; while, on the other hand, it is often impossible to draw any true boundary between gneiss (or other metamorphic rocks) and the ordinary strata that have undergone metamorphism. Under these circumstances it is not surprising that when chemically analysed there is often little difference in the constituents of the unmetamorphosed and the metamorphosed rock. This is a point of some importance in relation to the origin and non-primitive character of gneiss and other varieties of foliated strata, and also of some quartzites and crystalline limestones.

I am aware that in North America formations consisting of metamorphic rocks have been stated to exist of older date than the Laurentian gneiss, and under any circumstances it is obvious that vast tracts of pre-Laurentian land must have existed in all regions, by the degradation of which, sediments were derived wherewith to provide materials for the deposition of the originally unaltered Laurentian strata. In England, Wales, and Scotland attempts have also been made to prove the presence of more ancient formations, but I do not consider the data provided sufficient to warrant any such conclusion. In the Highlands of Scotland, and in some of the Western Isles, there are gneissic rocks of pre-Cambrian age, which, since they were first described by Sir Roderick Murchison in the North-west Highlands, have been, I think justly, considered to belong to the Laurentian series, unconformably underlying Cambrian and Lower Silurian rocks, and as yet there are no sufficient grounds for dissenting from his conclusion that they form the oldest known rocks in the British Isles.

It is unnecessary here to discuss the theory of the causes that produced the metamorphism of stratified rocks, and it may be sufficient to say, that under the influence of deep underground heat, aided by moisture, sandstones have been converted into quartzites, limestones have become crystalline, and in shaly, slaty, and schistose rocks, under like circumstances, there is little or no development of new material, but rather, in the main, a re-arrangement of constituents according to their chemical affinities in rudely crystalline layers, which have very often been more or less developed in pre-existing planes of bedding. The materials of the whole are approximately the same as those of the unaltered rock, but have been re-arranged in layers, for example, of quartz, felspar, and mica, or of hornblende, &c., while other minerals, such as schorl and garnets, are of not infrequent occurrence.

It has for years been an established fact that nearly the whole of the mountain masses of the Highlands of Scotland (exclusive of the Laurentian, Cambrian, and Old Red Sandstone formations) mostly consist of gneissic rocks of many varieties, and of quartzites and a few bands of crystalline limestone, which, from the north shore to the edge of the Old Red Sandstone, are repeated again and again in stratigraphical convolutions great and small. Many large bosses, veins, and dykes of granite are associated with these rocks, and, as already stated, it sometimes happens that it is hard to draw a geological line between granite and gneiss and *vice versa*. These rocks, once called Primary or Primitive, were first proved by Sir Roderick Murchison to be of Lower Silurian age, thus revolutionising the geology of nearly one-half of Scotland. To the same age belongs by far the greater part of the broad hilly region of the south of Scotland that lies between St. Abb's Head on the east and the coast of Ayrshire and Wigtonshire on the west. In the south-west part of this district, several great masses of granite rise amid the Lower Silurian rocks, which in their neighbourhood pass into mica-schist, and even into fine-grained gneiss.

In Cornwall the occurrence of Silurian rocks is now well known. They are of metamorphic character, and partly associated with granite; and at Start Point, in South Devonshire, the Silurian strata have been metamorphosed into quartzites. In parts of the Cambrian areas, Silurian rocks in contact with

granite have been changed into crystalline hornblende gneiss and in Anglesey there are large tracts of presumed Cambrian strata, great part of which have been metamorphosed into chlorite and mica-schist and gneiss, and the same is partly the case with the Lower Silurian rocks of the centre of the island where it is almost impossible to disentangle them from the associated granite.

In Ireland similar metamorphic rocks are common, and of the authority of Prof. Hull, who knows them well, the following statements are founded:—"Metamorphism in Ireland has been geographical and not stratigraphical, and seems to have ceased before the Upper Silurian period.

"The epoch of greatest metamorphism appears to have been that which intervened between the close of the Lower Silurian period and the commencement of the Upper Silurian, taking the formations in ascending order.

"It is as yet undecided whether Laurentian rocks occur in Ireland. There are rocks in north-west Mayo very like those in Sutherlandshire, but if they are of Laurentian age they come directly under the metamorphosed Lower Silurian rocks, and it may be very difficult to separate them.

"Cambrian purple and green grits are not metamorphosed in the counties of Wicklow and Dublin, but the same beds at the southern extremity of county Wexford, near Carnsore Point have been metamorphosed into mica-schist and gneiss.

"In the east of Ireland the Lower Silurian grits and slates have not been metamorphosed, except where in proximity to granite, into which they insensibly pass in the counties of Wicklow, Dublin, Westmeath, Cavan, Longford, and Down but in the west and north-west of Ireland they have been metamorphosed into several varieties of schists, hornblende-rock, *gneiss, or foliated granite.*"

It would be easy to multiply cases of the metamorphism of Silurian rocks on the continent of Europe, as, for example, in Scandinavia and in the Ural Mountains, where, according to Murchison, "by following its masses upon their strike, we are assured that the same zone which in one tract has a mechanical aspect and is fossiliferous, graduates in another parallel of latitude into a metamorphic crystalline condition whereby not only the organic remains, but even the original impress of sedimentary origin are to a great degree obliterated. The same kind of phenomena are common in Canada and the United States; and Medicott and Blanford, in "The Geology of India," have described the thorough metamorphism of Lower Silurian strata into gneiss and syenitic and hornblende schists.

In Britain none of the Upper Silurian rocks have undergone any serious change beyond that of ordinary consolidation, but in the Eastern Alps at Gratz, Sir Roderick Murchison has described both Upper Silurian and Devonian strata interstratified with separate courses of metamorphic chloritic schist.

Enough has now been said to prove the frequent occurrence of metamorphic action among Cambrian and Lower and Upper Silurian strata.

If we now turn to the Devonian and Old Red Sandstone strata of England and Scotland, we find that metamorphic action has also been at work, but in a much smaller degree. In Cornwall and Devon five great bosses of granite stand out amid the stratified Silurian, Devonian, and Carboniferous formations. Approaching or near these bosses the late Sir Henry De la Beche remarks that "in numerous localities we find the coarser slates converted into rocks resembling mica-slate and gneiss, a fact particularly well exhibited in the neighbourhood of Meavy, on the south-east of Tavistock," and "near Camelford we observed a fine arenaceous and micaceous grauwacke turned into a rock resembling mica-slate near the granite." Other cases are given by the same author of slaty strata turned into mica-schist and gneiss in rocks now generally considered to be of Devonian age.

The Devonian rocks and Old Red Sandstone are of the same geological age, though they were deposited under different conditions, the first being of marine, and the latter of fresh-water origin. The Old Red Sandstone of Wales, England, and Scotland has not, as far as I know, suffered any metamorphism, excepting in one case in the north-east of Ayrshire, near the sources of the Avon Water, where a large boss of granite rises through the sandstone, which all round has been rendered crystalline with well-developed crystals of felspar.

On the continent of Europe a belt lies on both banks of the Rhine as ago Sedgwick and Murchison described chlorite, and mica-schist, and gneiss.

and from personal observation I know that the rocks in the country on either side of the Moselle are, in places, of a foliated or semi-foliated metamorphic character. In the Alps also, as has already been noticed, metamorphic Devonian strata occur interstratified with beds of metamorphic schists, and, Sir Roderick adds, "we have ample data to affirm that large portions of the Eastern Alps . . . are occupied by rocks of true palaeozoic age, which in many parts have passed into a crystalline state."

I know of no case in Britain where the Carboniferous strata have been thoroughly metamorphosed, excepting that in South Wales beds of coal, in the West of Caermarthenshire and in South Pembrokeshire, gradually pass from so-called bituminous coal into anthracite. The same is the case in the United States, in both instances the Carboniferous strata being exceedingly disturbed and contorted. In the Alps, however, Sir Roderick Murchison seems to have believed that Carboniferous rocks may have been metamorphosed; a circumstance since undoubtedly proved by the occurrence of a coal-measure calamite, well preserved, but otherwise partaking of the thoroughly crystalline character of the gneiss in which it is imbedded, and which was shown to me by the late Prof. Gastaldi, at Turin.

I am well acquainted with all the Permian strata of the British Islands and of various parts of Continental Europe, and nowhere, that I have seen, have they suffered from metamorphic action, and strata of this age are, I believe, as yet unknown in the Alps. This closes the list of metamorphism of Palaeozoic strata.

I will not attempt (they are so numerous) to mention all the regions of the world in which Mesozoic or Secondary formations have undergone metamorphic action. In Britain and the non-mountainous parts of France they are generally quite unaltered, at in the Alps it is different. There, as every one knows who is familiar with that region, the crystalline rocks in the middle of the chain have the same general strike as the various flanking stratified formations. As expressed by Murchison, "as we follow the chain from north-east to south-west we pass from the nearest types of sedimentary rocks, and, at length, in the Savoy Alps, are immersed in the highly-altered mountains of Secondary limestone," while "the metamorphism of the rocks is greatest as we approach the centre of the chain," and indeed any one familiar with the Alps of Switzerland and Savoy knows that a process of metamorphism has been undergone by all the Jurassic rocks (Lias and Oolites) of the great mountain chain.

I will not attempt (they are so numerous) to mention all the regions of the world in which Mesozoic or Secondary formations have undergone metamorphic action. In Britain and the non-mountainous parts of France they are generally quite unaltered, at in the Alps it is different. There, as every one knows who is familiar with that region, the crystalline rocks in the middle of the chain have the same general strike as the various flanking stratified formations. As expressed by Murchison, "as we follow the chain from north-east to south-west we pass from the nearest types of sedimentary rocks, and, at length, in the Savoy Alps, are immersed in the highly-altered mountains of Secondary limestone," while "the metamorphism of the rocks is greatest as we approach the centre of the chain," and indeed any one familiar with the Alps of Switzerland and Savoy knows that a process of metamorphism has been undergone by all the Jurassic rocks (Lias and Oolites) of the great mountain chain. Not any strata of Neocomian and Cretaceous age have been metamorphosed in this region I am unable to say; but it seems to be certain that the Eocene or Lower Tertiary Alpine formation, known as the Flysch, contains beds of black schists which pass into Lydian stone, so that in the Grisons it has been converted into gneiss, schist, a fact mentioned by Murchison. I have seen in the country north of Le Oldenborn nummulitic rocks so far foliated that they formed an imperfect gneiss.

In Tierra del Fuego, as described by Darwin, clay slates of early cretaceous date pass into gneiss and mica-slate with quartz, and in Chonos Islands, and all along the great Cordillera of the Andes of Chili, rocks of Cretaceous or Cretaceous age have been metamorphosed into foliated mica-slate and gneiss, accompanied by the presence of granite, syenite, and pegmatite.

This ends my list, for I have never seen or heard of metamorphic rocks of later date than those that belong to the Eocene period. Enough however has been said to prove that from the Laurentian epoch onward the phenomenon of extreme metamorphism of strata has been of frequent recurrence all through the Eocene and Mesozoic times, and extends even to a part of the Tertiary series equivalent to the soft unaltered strata of the formations of the London and Paris basins, which, excepting for their fossil contents, and sometimes highly-inclined positions, look as if they had only been recently deposited.

**Volcanoes.**—The oldest volcanic products of which I have personal knowledge are of Lower Silurian age. These in Wales consist of two distinct series, the oldest of which, chiefly formed of basaltic lavas and volcanic ashes, lie in and near the base of the Llandello beds, and the second, after a long interval of time, were ejected and intermingled with the strata forming the middle part of the Bala beds. The Lower Silurian rocks of Shropshire, Shropshire, Radnorshire, Pembrokeshire, and Westmoreland are to a great extent also the products of volcanic eruptions, and the same kind of volcanic rocks are also seen in the Lower Silurian strata of Ireland. I know of no volcanic rocks in the Upper Silurian series.

In the Old Red Sandstone of Scotland lavas and volcanic ashes are of frequent occurrence, interstratified with the ordinary lacustrine sedimentary strata. Volcanic rocks are also intercalated among the Devonian strata of Devonshire. I know of none in America or on the continent of Europe.

In Scotland volcanic products are common throughout nearly the whole of the Carboniferous sub-formations, and they are found also associated with Permian strata.

I now come to the Mesozoic or Secondary epochs. Of Jurassic age (Lias and Oolites), it is stated by Lyell with some doubt, that true volcanic products occur in the Morea and also in the Apennines, and it seems probable, as stated by Medicott and Blanford, that the Rajmahal traps may also be of Jurassic age.

In the Cordillera of South America, Darwin has described a great series of volcanic rocks intercalated among the Cretaceous strata that forms so much of the chain; and the same author, in his "Geological Observations in South America," states that the Cordillera has been, probably with some quiescent periods, a source of volcanic matter from an epoch anterior to our Cretaceous formation to the present day. In the Deccan volcanic traps rest on Cretaceous beds, and are overlaid by Nummulitic strata, and, according to Medicott and Blanford, these were poured out in the interval between Middle Cretaceous and Lower Eocene times.

In Europe the only instance I know of a volcano of Eocene age is that of Monte Bolca near Verona, where the volcanic products are associated with the fissile limestone of that age.

The well-preserved relics of Miocene volcanoes are prevalent over many parts of Europe, such as Auvergne and The Velay, where the volcanic action began in Lower Miocene times, and was continued into the Pliocene epoch. The volcanoes of the Eifel are also of the same general age, together with the ancient Miocene volcanoes of Hungary.

The volcanic rocks of the Azores, Canaries, and Madeira are of Miocene age, while in Tuscany there are extinct volcanoes that began in late Miocene, and lasted into times contemporaneous with the English Coralline Crag. In the north of Spain, also, at Olot in Catalonia, there are perfect craters and cones remaining of volcanoes that began to act in newer Pliocene times and continued in action to a later geological date. To these I must add the great *coulees* of Miocene lava, so well known in the Inner Hebrides, on the mainland near Oban, &c., in Antrim in the north of Ireland, in the Faroe Islands, Greenland, and Franz-Joseph Land. It is needless, and would be tiresome, further to multiply instances, for enough has been said to show that in nearly all geological ages volcanoes have played an important part, now in one region, now in another, from very early Palaeozoic times down to the present day; and, as far as my knowledge extends, at no period of geological history is there any sign of their having played a more important part than they do in the epoch in which we live.

**Mountain Chains.**—The mountain-chains of the world are of different geological ages, some of them of great antiquity, and some of them comparatively modern.

It is well known that in North America the Lower Silurian rocks lie unconformably on the Laurentian strata, and also that the latter had undergone a thorough metamorphism and been thrown into great anticlinal and synclinal folds, accompanied by intense minor convolutions, before the deposition of the oldest Silurian formation, that of the Potsdam Sandstone. Disturbances of the nature alluded to imply beyond a doubt that the Laurentian rocks formed a high mountain-chain of pre-Silurian date, which has since constantly been worn away and degraded by sub-aerial denudation.

In Shropshire, and in parts of North Wales, and in Cumberland and Westmoreland, the Lower Silurian rocks by upheaval formed hilly land before the beginning of the Upper Silurian epoch; and it is probable that the Lower Silurian gneiss of Scotland formed mountains at the same time, probably very much higher than now. However that may be, it is certain that these mountains formed high land before and during the deposition of the Old Red Sandstone, and the upheaval of the great Scandinavian chain (of which the Highlands may be said to be an outlying portion) also preceded the deposition of the Old Red Strata. In both of these mountain regions the rocks have since undergone considerable movements, which in the main seem to have been movements of elevation, accompanied under the influence of that constant atmospheric degradation to which all high lands are especially subject.

The next great European chain in point of age is that of the Ural, which according to Murchison is of pre-Permian age, a fact proved by the Permian conglomerates which were formed from the waste of the older strata. On these they lie quite unconformably and nearly undisturbed on the western flank of the mountains.

In North America the great chain of the Alleghany Mountains underwent several disturbances, the last (a great one) having taken place after the deposition of the Carboniferous rocks, and before that of the New Red Sandstone. The vast mountainous region included under the name of the Rocky Mountains, after several successive disturbances of upheaval, did not attain its present development till after the Miocene or Middle Tertiary epoch.

In South America, notwithstanding many oscillations of level recorded by Darwin, the main great disturbance of the strata that form the chain of the Andes took place apparently in post-cretaceous times.

The Alps, the rudiments of which began in more ancient times, received their greatest disturbance and upheaval in post-Eocene days, and were again raised at least 5,000 feet (I believe much more) at the close of the Miocene epoch. The Apennines, the Pyrenees, the Carpathians, and the great mountain region on the east of the Adriatic and southward into Greece, are of the same general age, and this is also the case in regard to the Atlas in North Africa, and the Caucasus on the borders of Europe and Asia. In the north of India the history of the Great Himalayan range closely coincides with that of the Alps, for while the most powerful known disturbance and elevation of the range took place after the close of the Eocene epoch, a subsequent elevation occurred in post-Miocene times closely resembling and at least equal to that sustained by the Alps at the same period.

It would probably not be difficult by help of extra research to add other cases to this notice of recurrences of the upheaval and origin of special mountain chains, some of which I have spoken of from personal knowledge; but enough has been given to show the bearing of this question on the argument I have in view, namely, that of repetition of the same kind of events throughout all known geological time.

*Salt and Salt Lakes.*—I now come to the discussion of the circumstances that produced numerous recurrences of the development of beds of various salts (chiefly common rock-salt) in many formations, which it will be seen are to a great extent connected with continental or inland conditions. In comparatively rainless countries salt is often deposited on the surface of the ground by the effect of solar evaporation of moisture from the soil. Water dissolves certain salts in combination with the ingredients of the underlying rocks and soils, and brings it to the surface, and when solar evaporation ensues, the salt or salts are deposited on the ground. This is well known to be the case in and near the region of the Great Salt Lake in North America, and in South America in some of the nearly rainless districts of the Cordillera, extensive surface-deposits of salts of various kinds are common. The surface of the ground around the Dead Sea is also in extra dry seasons covered with salt, the result of evaporation, and in the upper provinces of India (mentioned by Medlicott and Blanford) "many tracts of land in the Indo-Gangetic alluvial plain are rendered worthless for cultivation by an efflorescence of salt known in the North-West Provinces as *Reh*," while every geographer knows that in Central Asia, from the western shore of the Caspian Sea to the Kinshan Mountains of Mongolia, with rare exceptions nearly every lake is salt in an area at least 3,500 miles in length. This circumstance is due to the fact that all so-called fresh-water springs, and therefore all rivers, contain small quantities of salts in solution only appreciable to the chemist, and by the constant evaporation of pure water from the lakes, in the course of time, it necessarily happens that these salts get concentrated in the water by the effect of solar heat, and, if not already begun, precipitation of solid salts must ensue.

The earliest deposits of rock-salt that I know about have been described by Mr. A. B. Wynne of the Geological Survey of India, in his memoir "On the Geology of the Salt Range in the Punjab."<sup>1</sup> The beds of salt are of great thickness, and along with gypsum and dolomitic layers occur in marl of a red colour like our Keuper Marl. This colour I have for many years considered to be, in certain cases, apt to indicate deposition of sediments in inland lakes, salt or fresh, as the case may be, and

<sup>1</sup> Many earlier notices and descriptions of the Salt Range might be quoted, but Mr. Wynne's is enough for my purpose.

with respect to these strata in the Punjab Salt Range, authors seem to be in doubt whether they were formed in inland lakes or in lagoons near the seaboard, which at intervals were liable to be flooded by the sea, and in which in the hot seasons salts were deposited by evaporation caused by solar heat. For my argument, it matters but little which of these was the true physical condition of the land of the time, though I incline to think the inland lake theory most probable. The age of the strata associated with this salt is not yet certainly ascertained. In "The Geology of India" Medlicott and Blanford incline to consider them of Lower Silurian age, and Mr. Wynne, in his "Geology of the Salt Range," places the salt and gypsum beds doubtfully on the same geological horizon.

The next salt-bearing formation that I shall notice is the Salina or Onondaga Salt Group of North America, which forms part of the Upper Silurian rocks, and lies immediately above the Niagara Limestone. It is rich in gypsum and in salt-brine, often of a very concentrated character, "which can only be derived from original depositions of salt," and it is also supposed by Dr. T. Sterry Hunt to contain solid rock-salt 115 feet in thickness at the depth of 2,085 feet, near Saginaw Bay in Michigan.

In the Lower Devonian strata of Russia near Lake Ilmen, Sir R. Murchison describes salt springs at Starai Russa. Sinkings, "made in the hope of penetrating to the source of these salt springs," reached a depth of 600 feet without the discovery of rock salt, "and we are left in doubt whether the real source of the salt is in the lowest beds of the Devonian rocks or even in the Silurian system."

In the United States brine springs also occur in Ohio, Pennsylvania, and Virginia, in Devonian rocks.

In Michigan salts are found from the Carboniferous down to the Devonian series; and in other parts of the United States Western Pennsylvania, Virginia, Ohio, Illinois, and Kentucky from the lower Coal-measures salts are derived which must have been deposited in inland areas, since even in the depths of inland seas that communicate with the great ocean, such as the Mediterranean and the Red Sea, no great beds of salt can be deposited. Before such strata of salt can be formed, supersaturation must have taken place.

In the North of England, at and near Middlesborough, two deep bore-holes were made some years ago in the hope of reaching the Coal-measures of the Durham coal-field. One of them at Salthome was sunk to a depth of 1,355 feet. First they passed through 74 feet of superficial clay and gravel, next through about 1,175 feet of red sandstones and marls, with beds of rock-salt and gypsum. The whole of these strata (excepting the clay and gravel) evidently belong to the Keuper marls and sandstones of the upper part of our New Red series. Beneath these they passed through 67 feet of dolomitic limestone, which in this neighbourhood forms the upper part of the Permian series, and beneath the limestone the strata consist of 27 feet of gypsum and rock-salt and marls, one of the beds of rock-salt having a thickness of 14 feet. This bed of Permian salt is of some importance, since I have been convinced for long that the British Permian strata were deposited, not in the sea, but in salt lakes comparable in some respects to the great salt lake of Utah and in its restricted fauna to the far greater salt lake of the Caspian Sea. The gypsum, the dolomite or magnesian limestone, the red marls covered with rain-pittings, the sun-cracks and the impressions of footprints of reptiles made in the soft sandy marls when the water was temporarily lowered by the solar evaporation of successive summers, all point to the fact that our Permian strata were not deposited in the sea, but in salt lake or lakes once for a time connected with the sea. The same may be said of other Permian areas in the central parts of the Continent of Europe, such as Stassfurt and Anhalt, Hall and Altern in Thuringia, and Sprenberg, near Berlin, and also in India.<sup>2</sup>

Neither do I think that the Permian strata of Russia, as described by Sir Roderick Murchison, were necessarily, as it implies, deposited in a wide ocean. According to his view a marine life universally declined to a minimum after the close of the Carboniferous period, that decline beginning with the Permian and ending with the Triassic epoch. Those who believe in the doctrine of evolution will find it hard to accept the idea which this implies, namely, that all the prolific forms of the Jurassic series sprang from the scanty faunas of the Permian.

<sup>2</sup> See "Physical Geology and Geography of Great Britain," pp. 211-212, where the question is treated in more detail.



and Triassic epochs. On the contrary, it seems to me more rational to attribute the poverty of the faunas of these epochs to accidental abnormal conditions in certain areas, that for a time partially disappeared during the deposition of the continental Muschelkalk which is absent in the British Triassic series.

In the whole of the Russian Permian strata only fifty-three species were known at the time of the publication of "Russia and the Ural Mountains," and I have not heard that this scanty list has been subsequently increased. I am therefore inclined to believe that the red marls, grits, sandstones, conglomerates, and great masses of gypsum and rock-salt were all formed in a flat inland area which was occasionally liable to be invaded by the sea during intermittent intervals of minor depression, sometimes in one area, sometimes in another, and the fauna small in size and poor in numbers is one of the results, while the deposition of beds of salt and gypsum is another. If so, then in the area now called Russia, in sheets of inland Permian water, deposits were formed strictly analogous to those of Central Europe and of Britain, but on a larger scale.

Other deposits of salt deep beneath overlying younger strata are stated to occur at Bromberg in Prussia, and many more might be named as lying in the same formation in Northern Germany.

If we now turn to the Triassic series it is known that it consists of only two chief members in Britain, the Bunter Sandstones and the Keuper or New Red Marls, the Muschelkalk of the Continent being absent in our islands. No salt is found in the Bunter Sandstones of England, but it occurs in these strata at Schöningen in Brunswick, and also near Hanover. In the lower part of the Keuper series deposits of rock-salt are common in England and Ireland. At Almersleben, near Calbe, rock-salt is found in the Muschelkalk, and also at Erfurt and Slottenheim in Thuringia and at Wilhelmshück in Württemberg. In other Triassic areas it is known at Hönigsen, Hanover, in middle Keuper beds. In the red shales at Sprenberg and Lieth on the Lower Elbe, salt was found at the depth of 3,000 feet, and at Stassfurth the salt is said to be "several hundred yards thick."

In Central Spain rock-salt is known, and at Tarragona, Taen, and also at Santander in the north of Spain, all in Triassic strata. Other localities may be named in the Upper Trias, such as the Salzkammergut, Aussee, Hallstatt, Ischl, Hallein in Salzburg, Halle in the Tyrol, and Berchtesgaden in Bavaria.

In the Salt Range of mountains in Northern India saliferous strata are referred with some doubt by Medlicott and Blanford to the Triassic strata.

In the Jurassic series (Lias and Oolites) salt and gypsum are not uncommon. One well-known instance occurs at Berg in the valley of the Rhone in Switzerland, where salt is derived from the Lias. Salt and gypsum are also found in Jurassic rocks at Burgos in Spain. At Gap in France there is gypsum, and salt is found in the Austrian Alps in Oolitic limestone.

In the Cretaceous rocks salt occurs, according to Lartet, at Jebel Udohm by the Dead Sea, and other authorities state that it occurs in the Pyrenees and at Biskra in Africa, where "mountains of salt" are mentioned as of Cretaceous age. The two last-named localities are possibly uncertain; but whether or not this is the case, it is not the less certain that salt has been deposited in Cretaceous rocks, and, judging by analogy, probably in inland areas of that epoch.

In the Eocene or Older Tertiary formations, rock-salt is found at Cardona in Spain, and at Kohat in the Punjab it occurs at the base of Nummulitic beds. It is also known at Mandi in India in strata supposed to be of Nummulitic Eocene age.

The record does not end here, for a zone of rock-salt lies in Städtl at the top of the Salina clays in Lower Miocene beds, and in Miocene strata gypsum is found at several places in Spain, while salt also occurs in beds that are doubtfully of Miocene age (but may be later) at Wieliczka in Poland, Kalusz in Galicia, Bukowina, and also in Transylvania.

In Pliocene or Later Tertiary formations, thick beds of gypsum are known in Zante, and strata of salt occur in Roumanian and Galicia, while in Pliocene rocks, according to Esaki, or in Post-Tertiary beds, according to others, a thick bed of pure salt was penetrated to a depth of 38 feet at Petit Anse à Lociflona. This ends my list, though I have no doubt that, by further research, many more localities might be given. Although, however, has been done to show that rock-salt (and other salts) are of frequent recurrence throughout all geological

time, and as in my opinion it is impossible that common salt can be deposited in the open ocean, it follows that this and other salts must have been precipitated from solutions, which, by the effect of solar evaporation, became at length supersaturated, like those of the Dead Sea, the great salt lake of Utah, and in other places which it is superfluous to name.

*Fresh-water. Lakes and Estuaries.*—I now come to the subject of recurrences of fresh-water conditions both in lakes and estuaries. In the introduction to the "Geology of India," by Messrs. Medlicott and Blanford, mention is made of the Blaini and Krol rocks as probably occupying "hollows formed by denudation in the old gneissic rocks," and the inference is drawn that "if this be a correct view, it is probable that the cis-Himalayan Palæozoic rocks are in great part of fresh-water origin, and that the present crystalline axis of the Western Himalayas approximately coincides with the shore of the ancient Palæozoic continent, of which the Indian peninsula formed a portion." The Krol rocks are classed broadly with "Permian and Carboniferous" deposits, but the Blaini beds are doubtfully considered to belong to Upper Silurian strata. If this point be by and by established, this is the earliest known occurrence of fresh-water strata in any of the more ancient Palæozoic formations.

It is a fact worthy of notice that the colour of the strata formed in old lakes (whether fresh or salt) of Palæozoic and Mesozoic age is apt to be red: a circumstance due to the fact that each little grain of sand or mud is usually coated with a very thin pellicle of peroxide of iron. Whether or not the red and purple Cambrian rocks may not be partly of fresh-water origin, is a question that I think no one but myself has raised.\*

There is however, in my opinion, no doubt with regard to the fresh-water origin of the Old Red Sandstone, as distinct from the contemporaneous marine deposits of the Devonian strata. This idea was first started by that distinguished geologist, Dr. Fleming, of Edinburgh, followed by Mr. Godwin-Austen, who, from the absence of marine shells and the nature of the fossil fishes in these strata, inferred that they were deposited, not in the sea, as had always been asserted, but in a great fresh-water lake or in a series of lakes. In this opinion I have for many years agreed, for the nearest analogies of the fish are, according to Huxley, the Polypterus of African rivers, the Ceratodus of Australia, and in less degree the Lepidosteus of North America. The truth of the supposition that the Old Red Sandstone was deposited in fresh water, is further borne out by the occurrence of a fresh-water shell, *Anodonta jukesii*, and of ferns in the Upper Old Red Sandstone in Ireland; and the same shell is found at Dura Den in Scotland, while in Calthness, along with numerous fishes, there occurs the small bivalve crustacean *Estheria purchisonia*.

I think it more than probable that the red series of rocks that form the Catskill Mountains of North America (and with which I am personally acquainted) were formed in the same manner as the Old Red Sandstones of Britain; for, excepting in one or two minor interstratifications, they contain no relics of marine life, while "the fossil fishes of the Catskill beds, according to Dr. Newberry, appear to represent closely those of the British Old Red Sandstone" (Dana).

The Devonian rocks of Russia, according to the late Sir Roderick Murchison, consist of two distinct types, viz., Devonian strata identical in general character with those in Devonshire and in various parts of the continent of Europe. These are exclusively of a marine character, while the remainder corresponds to the Old Red Sandstone of Wales, England, and Scotland.

At Tchudora, about 105 miles south-east of St. Petersburg, the lowest members of the series consist of flag-like, compact limestones accumulated in a tranquil sea, and containing fucoids and encrinites, together with shells of Devonian age, such as Spirifers, Terebratulæ, Orthis, Leptænas, Avicula, Modiola, Natica, Bellerophon, &c., while the upper division graduates into the Carboniferous series as it often does in Britain, and, like the Old Red Sandstone of Scotland, contains only fish-remains, and in both countries they are of the same species. "Proceeding from the Valdai Hills on the north," the geologist "quits a Devonian Zone with a true 'Old Red' type dipping under the

\* By Cambrian, I mean only the red and purple rocks of Wales, Devon, Scotland, and Ireland, older than the Mesozoic beds, or any later division of the Silurian strata that may chance to rest upon them.

\* "On the Red Rocks of England of older date than the Silurian." *Geol. Sec.*, 1871, vol. xxviii.

Carboniferous rocks of Moscow, and having passed through the latter he finds himself suddenly in a yellow-coloured region, entirely dissimilar in structure to what he had seen in any of the northern governments, which, of a different type as regards fossils, is the true stratigraphical equivalent of the Old Red system." This seems to me, as regards the Russian strata, to mean that just as the Devonian strata of Devonshire are the true equivalents of the Old Red Sandstone of Wales and Scotland, they were deposited under very different conditions, the first in the sea and the others in inland fresh-water lakes. At the time Sir Roderick Murchison's work was completed, the almost universal opinion was that the Old Red Sandstone was a marine formation. In the year 1830 the Rev. Dr. Fleming of Edinburgh read a paper before the Wernerian Society in which he boldly stated that the "Old Red Sandstone is a fresh-water formation" of older date than the Carboniferous Limestone. This statement, however, seems to have made no impression on geologists till it was revived by Godwin-Austen in a memoir "On the Extension of the Coal-measures," &c., in the *Journal of the Geological Society*, 1856. Even this made no converts to what was then considered a heretical opinion. I have long held Dr. Fleming's view, and unfortunately published it in the third edition of "The Physical Geology and Geography of Great Britain," without at the time being aware that I had been forestalled by Dr. Fleming and Mr. Godwin-Austen.

To give anything like a detailed account of all the fresh-water formations deposited in estuaries and lakes from the close of the Old Red Sandstone times down to late Tertiary epochs is only fitted for a manual of geology, and would too much expand this address; and I will therefore give little more than a catalogue of these deposits in ascending order.

In the Coal-measure parts of the Carboniferous series a great proportion of the shales and sandstones are of fresh-water origin. This is proved all over the British Islands by the shells they contain, while here and there marine interstratifications occur, generally of no great thickness. There is no doubt among geologists that these Coal-measure strata were chiefly deposited under estuarine conditions, and sometimes in lagoons or in lakes, while numerous beds of coal formed by the life and death of land plants, each underlaid by the soil on which the plants grew, evince the constant recurrence of terrestrial conditions. The same kind of phenomena are characteristic of the Coal-measures all through North America, and in every country on the continent of Europe, from France and Spain on the west to Russia in the east, and the same is the case in China and in other areas.

In Scotland, according to Prof. Judd, fresh-water conditions occur more or less all through the Jurassic series, from the Lias to the Upper Oolites. In England fresh-water strata, with thin beds of coal, are found in the Inferior Oolite of Yorkshire, and in the middle of England and elsewhere in the Great Oolite. The Purbeck and Wealden strata, which in a sense fill the interval between the Jurassic and Cretaceous series, are almost entirely formed of fresh-water strata, with occasional thin marine interstratifications. By some the Wealden beds are considered to have been formed in and near the estuary of a great river, while others, with as good a show of reason, believe them to have been deposited in a large lake subject to the occasional influx of the sea.

In the eastern part of South Russia the Lias consists chiefly of fresh-water strata, as stated by Neumayr.

The Godwana rocks of Central India range from Upper Paleozoic times well into the Jurassic strata, and there all these formations are of fresh-water origin. Fresh-water beds with shells are also interstratified with the Deccan traps of Cretaceous and Tertiary (Eocene) age, while 2,000 feet of fresh-water sands overlie them.

In South-Western Sweden, as stated by Mr. Bauerman, "the three coal-fields of Hoganas, Stabbarp, and Rodingé lie in the uppermost Triassic or Rhætic series." In Africa the Karoo beds, which it is surmised may be of the age of the New Red Sandstone, contain beds of coal. In North America certain fresh-water strata, with beds of lignite, apparently belong to the Cretaceous and Eocene epochs, and in the north of Spain and south of France there are fresh-water lacustrine formations in the highest Cretaceous strata.

In England the Lower and Upper Eocene strata are chiefly of fresh-water origin, and the same is the case in France and other parts of the Continent. Certain fresh-water formations in Central Spain extend from the Eocene to the Upper Miocene strata.

There is only one small patch of Miocene beds in England, at Bovey Tracey, near Dartmoor, formed of fresh-water deposits with interstratified beds of lignite or Miocene coal. On the continent of Europe Miocene strata occupy immense independent areas, extending from France and Spain to the Black Sea. In places too numerous to name they contain beds of "brown coal," as lignite is sometimes called. These coal-beds are often of great thickness and solidity. In one of the pits which I descended near Teplitz, in Bohemia, the coal, which lies in a true basin, is 40 feet thick, and underneath it there is a bed of clay, with rootlets, quite comparable to the underclay which is found beneath almost every bed of coal in the British and other coal-fields of the Carboniferous epoch. The Miocene rocks of Switzerland are familiar to all geologists who have traversed the country between the Jura and the Alps. Sometimes they are soft and incoherent, sometimes formed of sandstones, and sometimes of conglomerates, as on the Righi. They chiefly consist of fresh-water lacustrine strata, with some minor marine interstratifications which mark the influx of the sea during occasional partial submergences of portions of the area. These fresh-water strata, of great extent and thickness, contain beds of lignite, and are remarkable for the relics of numerous trees and other plants which have been described by Prof. Heer of Zurich with his accustomed skill. The Miocene fresh-water strata of the Sewalik Hills in India are well known to most students of geology, and I have already stated that they bear the same relation to the more ancient Himalayan Mountains that the Miocene strata of Switzerland and the North of Italy do to the pre-existing range of the Alps. In fact it may be safely inferred that something far more than the rudiments of our present continents existed long before Miocene times, and this accounts for the large areas on those continents which are frequently occupied by Miocene fresh-water strata. With the marine formations of Miocene age this address is in no way concerned, nor is it essential to my argument to deal with those later Tertiary phenomena, which in their upper stages so easily merge into the existing state of the world.

*Glacial Phenomena.*—I now come to the last special subject for discussion in this address, viz., the Recurrence of Glacial Epochs, a subject still considered by many to be heretical, and which was generally looked upon as an absurd crotchet when, in 1855, I first described to the Geological Society boulder-beds containing ice-scratched stones and erratic blocks in the Permian strata of England. The same idea I afterwards applied to some of the Old Red Sandstone conglomerates, and of late years it has become so familiar, that the effects of glaciers have at length been noted by geologists from older Palæozoic epochs down to the present day.

In the middle of last July I received a letter from Prof. Geikie, in which he informed me that he had discovered mammillated *moutonnée* surfaces of Laurentian rocks, passing underneath the Cambrian sandstones of the north-west of Scotland at intervals, all the way from Cape Wrath to Loch Torridon, for a distance of about 90 miles. The mammillated rocks are, says Prof. Geikie, "as well rounded off as any recent rocks *moutonnée*," and "in one place these bosses are covered by a huge angular breccia of this old gneiss (Laurentian) with blocks sometimes 5 or 6 feet long." This breccia, where it occurs, forms the base of the Cambrian strata of Sutherland, Ross, and Cromarty, and while the higher strata are always well stratified, where they approach the underlying Laurentian gneiss "they become pebbly, passing into coarse unstratified agglomerates or boulder-beds." In the Gairloch district "it is utterly unstratified, the angular fragments standing on end and at all angles," just as they do in many modern moraine mounds wherever large glaciers are found. The general subject of Palæozoic glaciers has long been familiar to me, and this account of more ancient glaciers of Cambrian age is peculiarly acceptable.

The next sign of ice in Britain is found in the Lower Silurian rocks of Wigtonshire and Ayrshire. In the year 1865 Mr. John Carrick Moore took me to see the Lower Silurian gneissitic rocks at Corswall Point in Wigtonshire, in which great blocks of gneiss, granite, &c., are imbedded, and in the same year many similar erratic blocks were pointed out to me by Mr. James Geikie in the Silurian strata of Carrick in Ayrshire. One of the blocks at Corswall, as measured by myself, is nine feet in length, and the rest are of all sizes, from an inch or two up to several feet in diameter. There is no gneiss or granite in this region nearer than those of Kirkcubrightshire and Ayrshire, and these are of later geological date than the strata amid which the

*erratic blocks are imbedded.* It is therefore not improbable that they may have been derived from some high land formed of Laurentian rocks of which the outer Hebrides and parts of the mainland of Scotland form surviving portions. If so, then I can conceive of no agent capable of transporting large boulders and dropping them into the Lower Silurian mud of the seas of the time save that of icebergs or other floating ice, and the same view with regard to the neighbouring boulder-beds of Ayrshire is held by Mr. James Geikie. If however any one will point out any other natural cause still in action by which such results are at present brought about, I should be very glad to hear of it.

I must now turn to India for further evidence of the action of Paleozoic ice. In the Himalayas of Pangi, south-east of Kashmir, according to Medicott and Blanford, "old slates, supposed to be Silurian, contain boulders in great numbers," which they believe to be of glacial origin. Another case is mentioned as occurring in "transition beds of unknown relations," but in another passage they are stated to be "very ancient, but no idea can be formed of their geological position." The *underlying rocks are marked by distinct glacial striations.*

The next case of glacial boulder-beds with which I am acquainted is found in Scotland, and in some places in the north of England, where they contain what seem to be indistinctly ice-scratched stones. I first observed these rocks on the Lammermuir Hills, south of Dunbar, lying unconformably on Lower Silurian strata, and soon inferred them to be of glacial origin, a circumstance that was subsequently confirmed by my colleagues Prof. and Mr. James Geikie, and is now familiar to other officers of the Geological Survey of Scotland.

I know of no boulder formations in the Carboniferous series, but they are well known as occurring on a large scale in the Permian brecciated conglomerates, where they consist "of pebbles and large blocks of stone, generally angular, imbedded in a marly paste . . . the fragments have mostly travelled from a distance, apparently from the borders of Wales, and some of them are three feet in diameter." Some of the stones are as well scratched as those found in modern moraines or in the ordinary boulder-clay of what is commonly called the Glacial epoch. In 1855 the old idea was still not unprevalent that during the Permian epoch, and for long after, the globe had not yet cooled sufficiently to allow of the climates of the external world being universally affected by the constant radiation of heat from its interior. For a long time, however, this idea has almost entirely vanished, and now, in Britain at all events, it is little if at all attended to, and other glacial episodes in the history of the world have continued to be brought forward and are no longer looked upon as mere ill-judged conjectures.

The same kind of brecciated boulder-beds that are found in our Permian strata occur in the Rotheliegende of Germany, which I have visited in several places, and I believe them to have had a like glacial origin.

Mr. G. W. Stow, of the Orange Free State, has of late years given most elaborate accounts of similar Permian boulder-beds in South Africa. There great masses of moraine matter not only contain ice-scratched stones, but on the banks of rivers where the Permian rock has been removed by aqueous denudation the underlying rocks, well rounded and mammillated, are covered by deeply incised glacier grooves pointing in a direction which at length leads the observer to the Pre-Permian mountains from whence the stones were derived that formed these ancient moraines.<sup>1</sup>

Messrs. Blanford and Medicott have also given in "The Geology of India" an account of boulder-beds in what they believe to be Permian strata, and which they compare with those described by me in England many years before. There the Godwana group of the Talchir strata contains numerous boulders, many of them six feet in diameter, and in one instance some of the blocks were found to be polished and striated, and the underlying Hindayan rocks were similarly marked." The authors also correlate these glacial phenomena with those found in similar deposits in South Africa, discovered and described by Mr. Stow.

In the Olive group of the Salt range, described by the same authors, there is a curious resemblance between a certain conglomerate "and that of the Talchir group of the Godwana

<sup>1</sup> Mr. Stow's last memoir on this subject is still in manuscript. It is so interestingly done, and the sections that accompany it are of such unusual value, that the Geological Society could not afford their publication. It was intended that the Government of the Orange Free State might undertake this work, but the late troubles in South Africa have probably hindered this work from being published for a time.

system." This "Olive conglomerate" belongs to the Cretaceous series, and contains ice-transported erratic boulders derived from unknown rocks, one of which of red granite "is polished and striated on three faces in so characteristic a manner that very little doubt can exist of its having been transported by ice." One block of red granite at the Mayo Salt Mines of Khehra "is 7 feet high and 19 feet in circumference." In the "Transition beds" of the same authors, which are supposed to be of Upper Cretaceous age, there also are boulder beds with erratic blocks of great size.

I know of no evidence of glacial phenomena in Eocene strata excepting the occurrence of huge masses of included gneiss in the strata known as Flysch in Switzerland. On this question, however, Swiss geologists are by no means agreed, and I attach little or no importance to it as affording evidence of glacial ice.

Neither do I know of any Miocene glacier-deposits excepting those in the north of Italy, near Turin, described by the late eminent geologist, Gastoldi, and which I saw under his guidance. These contain many large erratic boulders derived from the distant Alps, which, in my opinion, were then at least as lofty or even higher than they are now, especially if we consider the immense amount of denudation which they underwent during Miocene, later Tertiary, and post-Tertiary times.

At a still later date there took place in the north of Europe and America what is usually misnamed "The Glacial Epoch," when a vast glacial mass covered all Scandinavia and distributed its boulders across the north of Germany, as far south as the country around Leipzig, when Ireland also was shrouded in glacier ice, and when a great glacier covered the larger part of Britain and stretched southward, perhaps nearly as far as the Thames on the one side, and certainly covered the whole of Anglesey, and probably the whole, or nearly the whole, of South Wales. This was after the advent of man.

Lastly, there is still a minor Glacial epoch in progress on the large and almost unknown Antarctic continent, from the high land of which in latitudes which partly lie as far north as 60° and 62°, a vast sheet of glacier-ice of great thickness extends far out to sea and sends fleets of icebergs to the north, there to melt in warmer latitudes. If in accordance with the theory of Mr. Croll, founded on astronomical data, a similar climate were transferred to the northern hemisphere, the whole of Scandinavia and the Baltic would apparently be covered with glacier-ice, and the same would probably be the case with the Faroe Islands and great part of Siberia, while even the mountain tracts of Britain might again maintain their minor systems of glaciers.

*Conclusions.*—In opening this address I began with the subject of the oldest metamorphic rocks that I have seen—the Laurentian strata. It is evident to every person who thinks on the subject that their deposition took place far from the beginning of recognised geological time. For there must have been older rocks by the degradation of which they were formed. And if, as some American geologists affirm, there are on that continent metamorphic rocks of more ancient dates than the Laurentian strata, there must have been rocks more ancient still to afford materials for the deposition of these pre-Laurentian strata.

Starting with the Laurentian rocks, I have shown that the phenomena of metamorphism of strata have been continued from that date all through the later formations, or groups of formations, down to and including part of the Eocene strata in some parts of the world.

In like manner I have shown that ordinary volcanic rocks have been ejected in Silurian, Devonian, Carboniferous, Jurassic, Cretaceous, Eocene, Miocene, and Pliocene times, and from all that I have seen or read of these ancient volcanoes I have no reason to believe that volcanic forces played a more important part in any period of geological time than they do in this our modern epoch.

So also mountain chains existed before the deposition of the Silurian rocks, others of later date before the Old Red Sandstone strata were formed, and the chain of the Ural before the deposition of the Permian beds. The last great upheaval of the Alleghany Mountains took place between the close of the formation of the Carboniferous strata of that region and the deposition of the New Red Sandstone.

According to Darwin, after various oscillations of level, the Cordillera underwent its chief upheaval after the Cretaceous epoch, and all geologists know that the Alps, the Pyrenees, the Carpathians, the Himalayas, and other mountain chains (which I have named) underwent what seems to have been their chief great upheaval after the deposition of the Eocene strata, while

some of them were again lifted up several thousands of feet after the close of the Miocene epoch.

The deposition of salts from aqueous solutions in inland lakes and lagoons appears to have taken place throughout all time—through Silurian, Devonian, Carboniferous, Permian, Triassic, Jurassic, Cretaceous, Eocene, Miocene, and Pliocene epochs—and it is going on now.

In like manner fresh-water and estuarine conditions are found now in one region, now in another, throughout all the formations or groups of formations, possibly from Silurian times onward; and glacial phenomena, so far from being confined to what was and is generally still termed *the* Glacial epoch, are now boldly declared, by independent witnesses of known high reputation, to begin with the Cambrian epoch, and to have occurred somewhere, at intervals, in various formations, from almost the earliest Palaeozoic times down to our last post-Pliocene "Glacial epoch."

If the nebular hypothesis of astronomers be true (and I know of no reason why it should be doubted), the earth was at one time in a purely gaseous state, and afterwards in a fluid condition, attended by intense heat. By and by consolidation, due to partial cooling, took place on the surface, and as radiation of heat went on, the outer shell thickened. Radiation still going on, the interior fluid matter decreased in bulk, and, by force of gravitation, the outer shell being drawn towards the interior, gave way, and, in parts, got crinkled up, and this, according to cosmogonists, was the origin of the earliest mountain-chains. I make no objection to the hypothesis, which, to say the least, seems to be the best that can be offered, and looks highly probable. But, assuming that it is true, these hypothetical events took place so long before authentic geological history began, as written in the rocks, that the earliest of the physical events to which I have drawn your attention in this address was, to all human apprehension of time, so enormously removed from these early assumed co-mical phenomena, *that they appear to me to have been of comparatively quite modern occurrence, and to indicate that, from the Laurentian epoch down to the present day, all the physical events in the history of the earth have varied neither in kind nor in intensity from those of which we now have experience.* Perhaps many of our British geologists hold similar opinions, but, if it be so, it may not be altogether useless to have considered the various subjects separately on which I depend to prove the point I had in view.

## SECTION C

### GEOLOGY

OPENING ADDRESS BY H. C. SORBY, LL.D., F.R.S., &c.,  
PRESIDENT OF THE SECTION

In selecting a subject for an address to be given in accordance with the custom of my predecessors, I was anxious that it should be in some way or other connected with the locality in which we have met. If I had been adequately acquainted with the district, I should have thought it incumbent on me to give such an outline of the general geology of the surrounding country as would have been useful to those attending this meeting. I am, however, practically a stranger to South Wales, and must therefore leave that task to others. On reflecting on the various subjects to which I might have called your attention, it appears to me that I could select one which would be eminently appropriate in a town and district where iron and copper are smelted on so large a scale, and, as I think, also equally appropriate from a geological point of view. This subject is the comparative structure of artificial slags and erupted rocks. In making this choice I was also influenced by the fact that in my two anniversary addresses as President of the Geological Society, I have recently treated on the structure and origin of modern and ancient stratified rocks, and I felt that, if in the present address I were to treat on certain peculiarities in the structure of igneous rocks, I should have described the leading conclusions to which I have been led by studying the microscopical structure of nearly all classes of rocks. It would, however, be impossible in the time now at disposal to treat on all the various branches of the subject. Much might be said on both the purely chemical and purely mineralogical aspects of the question; but though these must not be ignored, I propose to draw your attention mainly to another special and remarkable class of facts, which, so far as I

am aware, have attracted little or no attention, and yet, as I think, would be very instructive if we could fully understand their meaning. Here, however, as in so many cases, the observed facts are clear enough, but their full significance is somewhat obscure, owing to the want of adequate experimental data, or of sufficient knowledge of general physical laws.

A considerable amount of attention has already been paid to the mineral constitution of slags, and to such peculiarities of structure as can be learned independently of thin microscopical sections. A very complete and instructive work, specially devoted to the subject, was published by von Leonhard about twenty-two years ago, just at the time when the microscope was first efficiently applied to the study of rocks. Since then, Vogelsang and others have described the microscopical structure of some slags in connection with their study of obsidian and other allied volcanic rocks. At the date of the publication of von Leonhard's work the questions in discussion differed materially from those which should now claim attention. There was still more or less dispute respecting the nature and origin of certain rocks which have now been proved to be truly volcanic by most unequivocal evidence. I am not at all surprised at this, since, as I shall show, there is such a very great difference in their characteristic structure and that of the artificial products of igneous fusion, that but for the small portions of glass enclosed in the constituent crystals, described by me many years ago under the name of "glass-cavities," there would often be no positive proof of their igneous origin. There was also considerable doubt as to the manner in which certain minerals in volcanic rocks had been generated. The observed facts were sufficient to prove conclusively that some had been formed by sublimation, others by igneous fusion, and others deposited from more or less highly-heated water, but it was difficult or impossible to decide whether in particular cases certain minerals had been formed exclusively by one or other process, or sometimes by one and sometimes by the other, or by the combined action of water and a very high temperature. I must confess that, even now that so much may be learned by studying with high magnifying powers the internal structure of crystals, I should hesitate very much in deciding what were the exact conditions under which certain minerals have been formed. This hesitation is probably as much due to inadequate examination, and to the want of a complete study of typical specimens, both in the field and by means of the microscope, as to the unavoidable difficulties of the subject. Such doubt, however, applies more to the origin of minerals occurring in cavities than to those constituting a part of true rock masses, to which latter I shall almost exclusively refer on the present occasion. In the formation of these it appears to me that sublimation has occurred to a very limited extent. In many cases true igneous fusion has played such a leading part that the rocks may be fairly called *igneous*, but, in other cases water in some form or other has, I think, had so much influence, that we should hesitate to call them *igneous*, and the term *erupted* would be open to far less objection, since it would adequately express the manner of their occurrence, and not commit us to anything open to serious doubt.

In studying erupted rocks of different characters we see that at one extreme they are as truly igneous as any furnace-product, and at the other extremity hardly, if at all, distinguishable from certain deposits met with in mineral veins, which furnish abundant evidence of the preponderating, if not exclusive influence of water, and have very little or nothing in common with products certainly known to have been formed by the action of heat, and of heat alone. Between these extremes there is every connecting link, and in certain cases it is almost, if not quite, impossible to say whether the characteristic structure is due more to the action of heat than of water. The great question is whether the presence of a small quantity of water in the liquid or gaseous state is the true cause of very well-marked differences in structure, or whether greater pressure and the necessarily slower rate of cooling were not the more active causes, and the presence of water in one state or another was merely the result of the same cause. This is a question which ought to be solved by experiment, but I fear it would be almost impossible to perform the necessary operations in a satisfactory manner.

What I now propose to do is to describe a particular class of facts which have lately attracted my attention, and to show that the crystalline minerals in products known to have been formed by the action of heat alone have a certain very well-marked and characteristic structure, which is gradually modified as we pass

through modern and more ancient volcanic to plutonic rocks, in such a manner as to show at once that they are intimately related and yet differ in such characteristic particulars that I think other agencies than mere heat must have had great influence in producing the final results.

In dealing with this subject I propose in the first place to describe the characteristic structure of products formed artificially under perfectly well-known conditions, and then to pass gradually to that of rocks whose origin must be inferred, and cannot be said to have been completely proved.

*Crystalline Blowpipe Beads.*—Some years ago I devoted a considerable amount of time to the preparation and study of crystalline blowpipe beads, my aim being to discover simple and satisfactory means for identifying small quantities of different earths and metallic oxides, when mixed with others, and I never supposed that such small objects would throw any light on the structure and origin of vast masses of natural rock. The manner in which I prepared them was as follows.—A small bead of borax was so saturated with the substance under examination at a high temperature that it became opaque either on cooling or when slowly re-heated. It was again fused so as to be quite transparent, and then very slowly cooled over the flame. If properly managed, the excess of material held in solution at a high temperature slowly crystallised out, the form and character of the crystals depending on the nature of the substance and on the presence of other substances added to the bead as test reagents. By this means I proved that in a few exceptional cases small simple solid crystals are formed. More frequently they are compound, or occur as minute needles, but the most characteristic peculiarity is the development of complex skeleton crystals of extreme beauty, built up of minute attached prisms, so as to give rise to what would be a well-developed crystal with definite external planes, if the interspaces were all filled up.

In many cases the fibres of these skeletons are parallel to three different axes perpendicular to one another, and it might be supposed that the entire skeleton was due to the growth of small needle-shaped crystals, all uniformly elongated in the line of one crystalline axis, so that the resulting mass would be optically and crystallographically complex; but in some cases the different systems of fibres or needles are inclined obliquely, and then the optical characters enable us to prove that the separate prisms are not similar to one another, but developed along different crystalline planes, so as to build up one definite crystal, mechanically complex, but optically and crystallographically simple, or merely twinned. In a few special cases there is a well-pronounced departure from this rule, and truly compound groups of prisms are formed. In the centre there is a definite simple prism, but instead of this growing continuously in the same manner, so as to produce a larger prism, its ends, as it were, break up into several smaller prisms slightly inclined to the axis of the first, and these secondary prisms in like manner break up into still smaller, so as ultimately to give rise to a curious complex, brush-like growth, showing in all positions a sort of fan-shaped structure, mechanically, optically, and crystallographically complex.

I have done my best to describe these various kinds of crystals seen in blowpipe beads as clearly as can be done without occupying too much time, but feel that it is impossible to make the subject as simple as it really is without numerous illustrations. However, for the purpose now in view, it will I trust suffice to have established the fact that we may divide the crystals in blowpipe beads into the following groups, which, on the whole, are sufficiently distinct, though they necessarily pass one into the other:—

1. Simple crystals.
2. Minute detached needles.
3. Fan-shaped compound groups.
4. Feathery skeleton crystals.

It must not be supposed that crystals of one or other of these groups occur promiscuously and without some definite relation to the special conditions of the case. Very much depends upon their chemical composition. Some substances yield almost exclusively those of one group, and other substances those of another, whilst in some cases a difference in the rate of cooling and other circumstances give rise to variations within certain limits; and, if it were possible to still further vary some of the conditions, these limits would probably be increased. Thus, for example, the earliest deposition of crystalline matter from the glassy solvent is sometimes in the form of simple solid systems of needles, but later on in the process it is in the form of

compound feathery tufts; and, if it were possible to cool the beads much more slowly whilst they are very hot, I am inclined to believe that some substances might be found that in the early stage of the process would yield larger and more solid crystals than those commonly met with. This supposition at all events agrees with what takes place when such salts as potassium chloride are crystallised from solution in water. Some of my blowpipe beads prove most conclusively that several perfectly distinct crystalline substances may be contemporaneously deposited from a highly-heated vitreous solvent, which is an important fact in connection with the structure of igneous rocks, since some authors have asserted that more than one mineral species cannot be formed by the slow cooling of a truly melted rock. The great advantage of studying artificial blowpipe beads is that we can so easily obtain a variety of results under conditions which are perfectly well known and more or less completely under control.

*Artificial Slags.*—I now proceed to consider the structure of slags, and feel tempted to enter into the consideration of the various minerals found in them, which are more or less perfectly identical with those characteristic of erupted rocks, but some of the most interesting, like the felspars, occur in a well-marked form only in special cases, where iron ores are smelted with fluxes, seldom if ever employed in our own country, so that my acquaintance with them is extremely small. My attention has been mainly directed to the more common products of our blast furnaces. On examining these, after having become perfectly familiar with the structure of blowpipe beads, I could see at once that they are very analogous, if not identical, in their structure. In both we have a glassy solvent, from which crystals have been deposited; only in one case this solvent was red hot melted borax, and in the other glassy, melted stone. Thus, for example, some compounds, like what I believe is Humboldtite, crystallise out in well-marked solid crystals, like those seen occasionally in blowpipe beads, whereas others crystallise out in complex feathery skeletons, just like those so common in, and characteristic of, the bead. In both we also often see small detached needles scattered about in the glassy base. These skeleton crystals and minute needles have been described by various writers under the names *crystallites*, *belonites*, and *trichites*. Though we have not the great variety of different forms met with in the beads, and cannot so readily vary the conditions under which they are produced, yet we can at all events see clearly that their structural character depends both on their chemical constitution and on the physical conditions under which they have crystallised. None of my microscopical preparations of English slags appear to contain any species of felspar, but several contain what I believe is some variety of augite, both in the form of more or less solid prisms, and of feathery skeletons of great beauty and of much interest in connection with the next class of products to which I shall call your attention, viz., rocks artificially melted and slowly cooled.

*Rocks Artificially Melted.*—I have had the opportunity of preparing excellent thin microscopical sections of some of the results of the classic experiments of Sir James Hall. I have also carefully studied the product obtained by fusing and slowly cooling much larger masses of the basalt of Rowley, and have compared its structure with that of the original rocks. Both are entirely crystalline, and, as far as I can ascertain, both are mainly composed of the same minerals. Those to which I would especially call attention are a triclinic felspar and the augite. The general character of the crystals is, however, strikingly different. In the artificial product a considerable part of the augite occurs as flat, feathery plates, like those in furnace-slugs, which are quite absent from the natural rock, and only part occurs as simple solid crystals, analogous to those in the rock, but much smaller and less developed. The felspar is chiefly in the form of elongated, flat, twinned prisms, which, like the prisms in some blowpipe beads, commence in a more simple form and end in complex fan-shaped brushes, whereas in the natural rock they are all larger than in the artificial, and exclusively of simple characters. On the whole then, though the artificially melted and slowly cooled basalt is entirely crystalline, and has a mineral composition closely like that of the natural rock, its mechanical structure is very different, being identical with that of blowpipe beads and slags.

*Volcanic Rocks.*—Passing now to true natural igneous rocks, we find some, like obsidian, which closely correspond with blowpipe beads, slags, and artificially melted rocks, in having a glassy base through which small crystalline needles are scattered,

but the more completely crystalline volcanic rocks have, on the whole, a structure very characteristically unlike that of the artificial products. I have most carefully examined all my sections of modern and ancient volcanic rocks, but cannot find any in which the augite or magnetite is crystallised in feathery skeletons. In the case of only one single natural rock from a dyke near Beaumaris have I found the triclinic felspar arranged in just the same fan-shaped, brush-like groups, as those in similar rocks artificially melted and slowly cooled. The large solid crystals in specimens from other localities sometimes show that towards the end of their growth small flat prisms have developed on their surface, analogous to those first deposited in the case of the artificial products. In slags composed almost exclusively of what I believe is Humboldtite, the crystals are indeed uniformly as simple and solid as those in natural rocks, but the examination of different blowpipe beads shows that no fair comparison can be made between altogether different substances. We must compare together the minerals common to the natural and the artificial products, and we then see that, on the whole, the two classes are only just distinctly connected by certain exceptional crystals and by structural characters which, as it were, overlap enough to show that there is a passage from one type to the other. In the artificial products are a few small solid crystals of both augite and a triclinic felspar, which closely correspond to the exceptionally small crystals in the natural rocks, but the development of the great mass of the crystals is in a different direction in the two cases. In the artificial products it is in the direction of complex skeletons, which are not seen in the natural rock, but in the natural rock it is in the direction of large simple solid crystals, which are not met with in the artificial products. There is a far closer analogy in the case of partially vitreous rocks, which, independent of the true glassy base common to them and the artificial products, often contain analogous crystalline needles. Even then, however, we see that in the artificial products the crystals tend to develop into complex skeletons, but in the natural rocks into simple solid crystals.

It must not be supposed that these facts in any way lead me to think that thoroughly crystalline modern and ancient volcanic rocks were never truly fused. The simple, large, and characteristic crystals of such minerals as augite, felspar, leucite, and olivine often contain so many thoroughly well-marked glass inclosures as to prove most conclusively that when the crystals were formed they were surrounded by, and deposited from, a melted glassy base, which was caught up by them whilst it was still melted. This included glass has often remained unchanged, even when the main mass became completely crystalline, or has been greatly altered by the subsequent action of water. I contend that these glass inclosures prove that many of our British erupted rocks were of as truly igneous origin as any lava flowing from a modern volcano. The difference between the structure of such natural rocks and that of artificial slags must not in my opinion be attributed to the absence of true igneous fusion, but to some difference in the surrounding conditions, which was sufficient to greatly modify the final result when the fused mass became crystalline on cooling. The observed facts are clear enough, and several plausible explanations might easily be suggested, but I do not feel at all convinced that any single one would be correct. That which first suggests itself is a much slower cooling of the natural rocks than is possible in the case of the artificial products, and I must confess that this explanation seems so plausible that I should not hesitate to adopt it if certain facts could be accounted for in a satisfactory manner. Nothing could be more simple than to suppose that skeleton crystals are formed when deposition takes place in a hurried manner, and they so overgrow the supply that they develop themselves along certain lines of growth before there has been time to solidly build up what has been roughly sketched in outline. I cannot but think that this must be a true, and to some extent active, cause, even if it be inadequate to explain all the facts. What makes me hesitate to adopt it by itself is the structure of some doleritic rocks when in close contact with the strata amongst which they have been erupted. In all my specimens the effects of much more rapid cooling are perfectly well marked. The base of the rock when in close contact is sometimes so extremely fine-grained that it is scarcely crystallised, and is certainly far less crystalline and finer-grained than the artificial products to which I have called attention, and yet there is no passage towards those structures which are most characteristic of slags, or at least no such passage as I should have ex-

pected if these structures depended exclusively on mere rapid cooling. We might well ascribe something to the effect of mass, but one of my specimens of basalt melted and slowly cooled in a small crucible is quite as crystalline as another specimen taken from a far larger mass, though I must confess that what difference there is in this latter is in the direction of the structure characteristic of natural rocks. The presence or absence of water appears to me a very probable explanation of some differences. When there is evidence of its presence in a liquid state during the consolidation of the rock, we can scarcely hesitate to conclude that it must have had some active influence; but in the case of true volcanic rocks the presence of liquid water is scarcely probable. That much water is present in some form or other is clearly proved by the great amount of steam given off from erupted lavas. I can scarcely believe that it exists in a liquid state except at great depths, but it may possibly be present in a combined form or as a dissolved vapour under much less pressure, and the question is, whether this water may not have considerable influence on the growth of crystals formed prior to eruption, before it was given off as steam. I do not know one single fact which can be looked upon as fairly opposed to this supposition, and it is even to some extent supported by experiment. M. Daubr e informs me that the crystals of augite formed by him at a high temperature by the action of water have the solid character of those in volcanic rocks, and not the skeleton structure of those met with in slags. The conditions under which they were formed were however not sufficiently like those probably present during the formation of erupted lavas to justify our looking upon the explanation I have suggested as anything more than sufficiently plausible, in the absence of more complete experimental proofs.

*Granitic Rocks.*—I now proceed to consider rocks of another extreme type, which for distinction we may call the granitic. On the whole they have little or nothing in common with slags or with artificial products similar to slags, being composed exclusively of solid crystals, analogous in character only to slag-crystals of very different mineral nature. As an illustration I would refer to the structure of the products formed by fusing and slowly cooling upwards of a ton of the syenite of Grooby, near Leicester. Different parts of the resulting mass differ very materially, but still there is an intimate relation between them, and a gradual passage from one to the other. The most characteristic feature of those parts which are completely crystalline is the presence of beautiful feathery skeleton crystals of magnetite, and of long flat prisms of a triclinic felspar, ending in complex, fan-shaped brushes. There are no solid crystals of felspar, hornblende, and quartz, of which the natural rock is mainly composed, to the entire exclusion of any resembling those in the melted rock. As looked upon from the point of view taken in this address, the natural and artificial products have no structural character in common, so that I think we must look for other conditions than pure igneous fusion to explain the greatly modified results. We have not to look far for evidence of a well-marked difference in surrounding circumstances. The quartz in the natural rock contains vast numbers of fluid cavities, thus proving that water was present, either in the liquid state or as a vapour so highly compressed that it afterwards condensed into an almost equal bulk of liquid. In some specimens of granite there is indeed clear proof that the water was present as a liquid, supersaturated with alkaline chlorides, like that inclosed in the cavities of some minerals met with in blocks ejected from Vesuvius, which also have to some extent what may be called a granitic structure.

In the case of one very exceptional and interesting granite, there is apparently good proof that the felspar crystallised out at a temperature above the critical point of water—that is to say, at a temperature higher than that at which water can exist as a liquid under any pressure—and it caught up highly compressed steam, comparatively, if not entirely, free from soluble salts; whereas the quartz crystallised when the temperature was so far lowered as to be below the critical point, and the water had passed into a liquid, supersaturated with alkaline chlorides, which have crystallised out as small cubes in the fluid-cavities, just as in the case of minerals in some of the blocks ejected from Vesuvius.

Confining our attention, then, to extreme cases, we thus see that rocks of the granitic type differ in a most characteristic manner from the products of artificial igneous fusion, both in the structure of the crystals and in containing liquid water inclosed at the time of their formation. The question then arises

whether these differences were due to the presence of the liquid water, or whether its presence and the characteristic structure were not both the effects of the great pressure of superincumbent rocks. I do not see how this can be decided in a perfectly satisfactory manner, but must confess that I am inclined to believe that, whilst great pressure was necessarily the reason why the water did not escape as vapour, the presence of liquid water during final consolidation must have had a very considerable influence in modifying the structure of the rock, and had a great share in developing what we may call the granitic type.

It would be very instructive to follow out the gradual passage from one extreme type to another far more completely than is possible on the present occasion. The most interesting examples of rocks intermediate between the granitic and volcanic types that I have been able to examine in adequate detail are the various Cornish elvans and other quartz felsites, which furnish all but a complete passage from pitch-stone to granite. Some specimens prove that quartz may crystallise out from and inclose a perfectly glassy base, without a trace of liquid water, and at the same time other specimens prove equally well that, as we approach the granitic type, the quartz was not deposited from a glassy solvent, but inclosed more or less water. In the few intermediate cases there appears to be evidence of the conjoint presence of uncombined water and melted stony matter. On the whole, if we take into consideration only the external form of the larger crystals, rocks of the granitic type are very much as though the crystals met with in truly volcanic rocks had been strained out from the glassy or fine-grained base, and the intermediate spaces filled with quartz. The internal structure of the crystals is however very different, the cavities in one class containing glass, and in the other water. This most essential and characteristic difference proves that rocks of the true granitic type cannot have been formed simply by the more complete crystallisation of the general base of the rock. If the crystals in granite were analogous to those developed in volcanic rocks, and the only essential difference were that the residue crystallised out more slowly and completely, so as to give rise to a more coarsely crystallised base, the crystals first formed ought not, as I think, to differ so essentially as that in one case they should inclose only glass, and in the other only water. Taking all into consideration, we can therefore scarcely suppose that the crystals in granitic rocks were deposited from a truly-melted dry glassy solvent, like those in volcanic rocks or in slags.

**General Results.**—I have, I trust, now said enough to show that the objects here described may be conveniently separated into three well-marked groups, viz. artificial slags, volcanic rocks, and granitic rocks. My own specimens all show perfectly well-marked and characteristic structures, though they are connected in some cases by intermediate varieties. Possibly such connecting links might be more pronounced in other specimens that have not come under my notice. I must, however, base my conclusions on what I have been able to study in an adequate manner, by examining my own preparations, and leave it for others to correct any error into which I may have been led from lack of more numerous specimens. In any case the facts seem abundantly sufficient to prove that there must be some active cause for such a common, if not general difference in the structural character of these three different types. The supposition is so simple and attractive that I feel very much tempted to suggest that this difference is due to the presence or absence of water as a gas or as a liquid. In the case of slags it is not present in any form. Considering how large an amount of steam is given off from erupted lavas, and that, as a rule, no fluid cavities occur in the constituent minerals, it appears to me very plausible to suppose that these structures which are specially characteristic of volcanic rocks are in great measure, if not entirely, due to the presence of associated or dissolved vapour. The fluid-cavities prove that water was sometimes, if not always, present as a liquid during the consolidation of granitic rocks, and we can scarcely hesitate to conclude that it must have had very considerable influence on the rock during consolidation. Still, though these three extreme types appear to be thus characterised by the absence of water or by its presence in a state of vapour or liquid, I think we are scarcely in a position to say that this difference in the conditions is more than a plausible explanation of the differences in their structure. At the same time I do not know any facts that are opposed to this conclusion, and we should perhaps not greatly insist on correlating the structures, even though the water was not the essential and active cause of the differences.

Confining our attention to the more important crystalline con-

stituents which are common to the different types, we may say that the chief structural characters of the crystals are as follows:—

- a. Skeleton crystals.
- b. Fan-shaped groups.
- c. Glass cavities.
- d. Simple crystals.
- e. Fluid cavities.

These different structural characters are found combined in different ways in the different natural and artificial products, and for simplicity I will refer to them by means of the affixed letters.

The type of the artificial products of fusion may generally be expressed by  $a + b$  or  $b + c$ ; that is to say, it is characterised by skeleton crystals and fan-shaped groups, or by fan-shaped groups and glass-cavities. In like manner, the volcanic type may be expressed occasionally by  $b + c$ , but generally by  $c + d$ , and the granitic by  $d + e$ . These relations will be more apparent if given in the form of a table as follows:—

Slag type	...	...	{	$a + b$
			{	$b + c$
Volcanic type	...	...	{	$b + c$
			{	$c + d$
Granitic type	...	...	...	$d + e$

Hence it will be seen that there is a gradual passage from one type to the other by the disappearance of one character and the appearance of another, certain characters in the meanwhile remaining common, so that there is no sudden break, but an overlapping of structural characteristics. It is, I think, satisfactory to find that, when erupted rocks are examined from such a new and independent point of view, the general conclusions to which I have been led are so completely in accord with those arrived at by other methods of study.

**Conclusion.**—And now I feel that it is time to conclude. I have necessarily been compelled to give only a general account of the subject, and perhaps for want of adequate description many facts may appear more complex than they really are. Some are indeed of anything but simple character, and their full explanation is perhaps beyond our present power. The greater part are, however, much more simple and easy to observe than to describe; and, even if I have failed to make everything as plain as I could wish, I hope that I have succeeded in making the principal points sufficiently clear to show that the structure of slags and analogous artificial products throws much light on the structure and origin of the various groups of erupted rocks. I feel that very much still remains to be learned, and, as I think, could be learned by the further extension of this method of inquiry. What strikes me most is the great necessity for the more complete appreciation of experimental methods of research; but to carry out the experiments necessary to clear up the essential difficulties of the subject would, I fear, be a most difficult undertaking. In the meantime all that we can do is to compare the structure of known artificial products with that of natural rocks, and to draw the best conclusions we can from the facts, as viewed in the light of our present knowledge of chemistry and physics. My own impression is that there is still much to be learned respecting the exact conditions under which some of our commonest rocks were formed.

SECTION D  
BIOLOGY

OPENING ADDRESS BY DR. A. C. L. G. GÜNTHER, M.A.,  
PH.D., F.R.S., PRESIDENT OF THE SECTION

SIXTEEN years ago, at the meeting of the British Association at Bath, the duty which I am endeavouring to discharge to-day was intrusted to my predecessor and old friend, the late Dr. John Edward Gray. In the address which he then delivered before this section he spoke on "Museums, their Use and Improvement;" and he, who had devoted a whole lifetime to the formation and management of one of the greatest zoological collections in the world, was well qualified to give an opinion and advice on this subject. Indeed, when I read now what he then said, as a necessary change in the system of museums, I feel tempted to pay a passing tribute to his memory.

Zoology, geology, botany were to him not distinct and independent studies; the views advanced by Lamarck; by Cuvier,

viz., that our knowledge of these sciences would remain fragmentary and one-sided as long as they were not studied in their mutual relations, found in him one of the earliest advocates in this country. Against all opposition he tried to unite the zoological and palæontological collections in the British Museum, giving up this attempt only after having convinced himself of the impracticability of the scheme; and he readily joined the band of men who demanded that a museum should be not merely a repository for the benefit of the professed student and specialist, but serve in an equal measure for the recreation of the mass of the people and for their instruction in the principles of biology. This was the spirit in which he worked; and in the last years of his life he had the satisfaction of being able to say that there was no other collection in existence more accessible and more extensively used than the one under his charge.

I am encouraged to return to-day to the same subject because I have daily the opportunity of observing that the public more and more comprehend the use of museums, and that they appreciate any real improvement, however slight. Paragraphs, leaders, articles published in the public journals and periodicals, references made in speeches or addresses, questions put in the Houses of Parliament whenever an opportunity offers—all testify that the progress of museums is watched with interest. Not long ago a Royal Commission entered deeply and minutely into the subject, and elicited a mass of evidence and information invaluable in itself, though you may differ from some of the conclusions and views expressed in their final Report. Biological science has made rapid strides: not only do we begin to understand better the relations of the varieties of living forms to each other, but the number of the varieties themselves that have been made known has also been increased beyond all expectation, and the old repositories have everywhere been found too narrow to house the discoveries of the last forty years. Therefore you find that the United States, Austria, Prussia and Saxony, Denmark and Holland, France and Great Britain, have erected, or are building anew, their national museums, not to mention the numerous smaller museums, which are more or less exclusively devoted to some branch of biological science.

The purposes for which museums are formed are threefold:—(1) To diffuse instruction among, and offer rational amusement to, the mass of the people; (2) to aid in the elementary study of biology; and (3) to supply the professed student of biology or the specialist with as complete materials for his scientific researches as can be obtained, and to preserve for future generations the materials on which those researches have been based.

Although every museum has, as it were, a physiognomy of its own, differing from the others in the degree in which it fulfils one, or two, or all three of those objects, we may divide museums into three classes, viz.:—

(1) National, (2) Provincial, and (3) strictly Educational museums—a mode of division which may give to those of this assembly who are not biologists an idea of what we mean by the term "species." The three kinds pass into each other, and there may be hybrids between them.

The museum of the third class, the strictly *Educational institution*, we find established chiefly in connection with universities, colleges, medical and science schools. Its principal object is to supply the materials for teaching and studying the elements and general outlines of biology; it supplements, and is the most necessary help for, oral and practical instruction, which always ought to be combined with this kind of museum. The conservation of objects is subservient to their immediate utility and unrestricted accessibility to the student. The collection is best limited to a selection of representatives of the various groups or "types," arranged in strictly systematic order, and associated with preparations of such parts of their organisation as are most characteristic of the group. Collections of this kind I have seen arranged with the greatest ingenuity, furnishing the student with a series of demonstrations which correspond to the plan followed in some elementary text-book. This, however, is not sufficient for practical instruction; besides the exhibited permanent series, a stock of well-preserved specimens should be kept for the express purpose of allowing the student to practise dissection and the method of independent examination. And in this latter I am inclined to include the method of determining to what order, family, genus, or species any given object should be referred. By such practice alone can the student learn to understand the relative value of taxonomic characters and acquire the elementary knowledge indispensable for him in the future.

Finally, in the educational museum should be formed a series

of all the animals and plants, which are of economic value or otherwise of importance to man.

The proposal to unite living and extinct forms in one series, which has been urged by eminent men with such excellent reasons, might be tried in the educational museum with great advantage to the student, as the principal objections that are brought forward against this plan being carried out in larger collections, do not apply here.

A museum which offers to the teacher and student the materials mentioned, fulfils its object; its formation does not require either a long time or heavy expense; but the majority of these institutions outgrow in time their original limits in one or the other direction; and if such additions do not interfere with the general arrangement of the museum, they neither destroy its character, nor do they add to its value as a strictly educational institution.

The principal aim of a *Provincial Museum* ought, in my opinion, to be popular instruction. I do not mean that it should be merely a place for mild amusement and recreation, but that it should rank equal with all similar institutions destined to spread knowledge and cultivate taste among the people. To attain this aim it should contain an arranged series of well-preserved specimens representing as many of the remarkable types of living forms as are obtainable; a series of useful as well as noxious plants and animals; of economic products derived from the animal and vegetable kingdoms; and last (but not least), a complete and accurately-named series of the flora and fauna of the neighbourhood. The majority of provincial museums with which I am acquainted are far from coming up to this ideal. One of the first principles by which the curator of such a museum should be guided is to admit into his collection no specimen unless it be well mounted and a fair representation of its species. He has not the excuse of his colleague in charge of a large museum, who has to retain those monsters which are literally his *bêtes-noires*, viz., specimens to which a history is attached, and the removal of which would sooner or later be resented by some of his fellow labourers. The only too frequent presence of such badly-mounted specimens in provincial museums is not always the fault of the curator. The slender means with which he is provided are generally insufficient to encourage taxidermists to bestow the necessary amount of skill and time on their work. Besides, taxidermy is an art which depends as much on natural gift as drawing or modelling, and as long as we are obliged to be satisfied with receiving into our collections mediocre specimens, mediocre stuffers will take up taxidermy as a trade without there being one who is naturally qualified for it.

The direct benefit of a complete collection of the flora and fauna of the district in which the provincial museum is situated, is obvious and cannot be exaggerated. The pursuit of collecting and studying natural history objects gives to the persons who are inclined to devote their leisure hours to it, a beneficial training for whatever their real calling in life may be: they acquire a sense of order and method; they develop their gift of observation; they are stimulated to healthy exercise. Nothing encourages them in this pursuit more than a well-named and easily accessible collection in their own native town, upon which they can fall back as a pattern and an aid for their own. This local collection ought to be always arranged and named according to the plan and nomenclature adopted in one of those numerous monographs of the British fauna and flora in which this country excels; and I consider its formation in every provincial museum to be of higher importance than a collection of foreign objects.

The majority of provincial museums contain not only biological collections, but, very properly, also collections of art and literature; it is no part of my task to speak of the latter, but before I proceed to the next part of my address, I must say that nothing could more strikingly prove the growing desire of the people for instruction than the erection of the numerous free libraries and museums now spread over the country. The more, the healthier their rivalry, the safer their growth will be, especially if they avoid depending on aid from the State or placing themselves in the hands of a responsible minister—if they remain what they are—municipal institutions—the children and pride of their own province.

However great, however large a country or a nation may be, it can have in reality only one *National Museum*, truly deserving of the name. Yours is the British Museum; those of Scotland and Ireland can never reach the same degree of completeness, though there is no one who wishes more heartily than I do that they may approach it as closely as conditions permit. The



most prominent events in the recent history of the British Museum (to which I must confine the remainder of my remarks) are well known to the majority of those present;—that the question either of enlarging the present building at Bloomsbury, or of erecting another at South Kensington for the collections of natural history, was fully discussed for years in its various aspects; that, finally, a Select Committee of the House of Commons reported in favour of the expediency of the former plan; that the Standing Committee of the Trustees, than whom there is no one better qualified to give an opinion, took the same view; and that, nevertheless, the Government of the time decided upon severing the collections and locating the natural history in a separate building as the more economical plan.

The building was finished this year at a cost of 400,000*l.*, exclusive of the amount paid for the ground on which it is erected. It is built in the Romanesque or round-arched Gothic style, terra-cotta being almost exclusively employed in its construction. It consists of a basement, ground-floor, and two storeys, and is divided into a central portion, and a right and left wing. Its principal (southern) façade is 675 feet long. As you enter the portal, you come into a cathedral-like hall called the "Index Museum," 120 feet long, 97 feet wide, and 68 feet high; behind this there is a large side-lighted room for the British fauna. On each side of the hall there is a side-lighted gallery each 278 feet long by 50 feet in width; seven other galleries of various widths, and therefore adapted for various exhibitions, join at right angles the long gallery of the ground floor. The first and second storeys are occupied by galleries similar to the main galleries of the ground-floor.

The collections are distributed in this building thus:—The western wing is occupied by Zoology, the eastern by the three other departments, viz., the ground-floor by Geology, the first-floor gallery by Mineralogy, and the second-floor gallery by Botany. The central portion is, as mentioned above, divided into the room for British Zoology and into the "Index Museum," that is "an apartment devoted to specimens selected to show the type-characters of the principal groups of organised beings." The basement consists of a number of spacious, well-lit rooms, well adapted for carrying on the different kinds of work in connection with such large collections.

There is no doubt that the building fulfils the principal condition for which it was erected, viz., space for the collections. The zoological collections gain more than twice as much space as they had in the old building, the geological and mineralogical about thrice, and the botanical more four times. This increase of space will enable the keeper of the last-named department to bring the collections correlated with each other into close proximity, and to prepare a much greater number of objects for exhibition than was possible hitherto. The mineralogical department, already so admirably arranged in the old building, has now been supplied with the space requisite for a collection of rocks, with a laboratory and goniometrical room. Geology is now in a position to exhibit a great part of the invertebrata, which hitherto had to be deposited in private studies, besides devoting one or two of the new galleries to a stratigraphical series. On the zoological side we have been great gainers (not with regard to the proportion of space), but inasmuch as we were more impeded by the crowded state of our collections than any of the other departments. We are enabled to avoid the exhibition of heterogeneous objects in the same room or gallery; mammals, birds, reptile, fishes, mollusks, insects, echinoderms, corals, and sponges have each a smaller or larger gallery to themselves. With the exception of the specimens preserved in spirits, the study-series can be located in contiguity with, or at least close vicinity to, the exhibition-series. There is ample and convenient accommodation for the students, who may work in a spacious room centrally situated, and arranged for their exclusive use at four other different localities immediately adjoining the several branches of the collection.

I believe that some of the members of the British Association will feel somewhat disappointed that the zoological and botanical collections on the one hand, and the palæontological on the other, continue to be kept distinct. Who will, who can doubt that the two branches of biological science would be immensely benefited by being studied in their natural mutual relations? and that palæontology more especially would have made surer progress if its study had been conducted with more direct application to the study of living forms? But to study the series of extinct and living forms in their natural connection, is one thing, and to incorporate in a museum the collection of fossils with that of

recent forms, is another. The latter proposal, so excellent in theory, would offer in its practical execution so many and insuperable difficulties, that we may well hesitate before we recommend the experiment to be tried in so large a collection as the British Museum. I have mentioned above that in a small collection such an arrangement may be feasible to a certain degree; but in a large collection you cannot place skins, bones, spirit preparations, and stones in the same room, or perhaps in the same case, exposing them to the same conditions of light and temperature, without injuring either the one or the other. Each kind of those objects requires for its preservation special considerations and special manipulations; and by representing them in each of the several departments you would have to double your staff of skilled manipulators with their apparatus, which means multiplying your expense. Departmental administration generally, and especially the system of acquisition by purchase or exchange, would become extremely complicated, and could not be carried on without a considerably greater expenditure in time and money. Thus, even if the old departmental division were abandoned for one corresponding to the principal classes of the animal kingdom, each of the new departments would still continue to keep, for considerations of conservation, those different kinds of objects, at least locally, separate. The necessity of this has been so much felt in the British Museum, that the Trustees resolved to store the spirit specimens at South Kensington, in a building specially adapted for the purpose, and separated from the main building, as the accumulation of many thousand gallons of spirits is a source of danger which not many years ago threatened the destruction of a portion of the present building in Bloomsbury.

I could never see that by the juxtaposition of extinct and living animals the student would obtain particular facilities for study, or that the general public would derive greater benefit than they may obtain, if so inclined, from one of the numerous popular books. They would not be much the wiser if the *Archæopteryx* were placed in a passage leading from the reptile- to the bird-gallery. And it certainly cannot be said that the separation of living and extinct organisms, so universally adopted in the old museums, has been a hindrance to the progress of our knowledge of the development of the organic world; this knowledge originated and advanced in spite of museums' arrangements. What lies at the bottom of the desire for such a change amounts, in reality, to this, that museums should be the practical exponents of the principle that zoologists and botanists should not be satisfied with the study of the recent fauna and flora, and that palæontologists should not begin their studies or carry on their researches without due and full reference to living forms. To this principle every biologist will most heartily subscribe; but the local separation of the various collections in the British Museum will not offer any obstacles whatever to its being carried out. The student can take the specimens, if not too bulky, from one department to the other; he may examine them in the gallery without interference on the part of the public; or he may have all brought to a private study, and, in fact, be in the same position with regard to the use of the collections as those who have charge of them. A plan which has been already initiated in the old building will probably be further developed in the new, viz., to distribute in the palæontological series such examples of important living types as will aid the visitor in comprehending the nature and affinities of the creatures, of which he sees only the fragmentary remains.

With regard to the further arrangement of the collections in the new building, it has been long understood that the exhibition of all the species, or even the majority of them, is a mistake, and that, therefore, two series of specimens should be formed, viz.:—one for the purposes of advanced scientific study—the study-series; and the other comprising specimens illustrative of the leading points both of popular and scientific interest; this latter—the exhibition series—being intended to supply the requirements of the beginner in the study of natural history and of the public. As the zoological collections are better adapted for exhibition than the others, the following remarks refer principally to them. The bulk of our present exhibition-series is the growth of many years; not to convert it into one which fulfils its proper purpose is a gradual and slow process, nor can it be expected to reveal its character until it has been removed into the new locality. The exhibition series will be probably found more liberal than may be deemed necessary by some of my fellow-labourers; but if a visitor, on leaving the galleries, "take nothing with him but some sense, a head

headache, and a general idea that the animal kingdom is a mighty mass without plan," I should be inclined to believe that this state of bodily and mental prostration is the visitor's, and not the curator's fault. The very fact that the exhibition series is intended for a great variety of people, renders it necessary to make a liberal selection of specimens; and I simply follow the principle of placing in it all those objects which, in my opinion, the public can understand and appreciate, and which, therefore, must contribute towards instruction. The public would receive but an inadequate return for keeping up a national museum if they were shown, for instance, a dozen so-called "types" of the family of parrots or humming-birds; they require a good many more to see what nature can produce in splendour and variation of colour, in grotesqueness of form; or to learn that whilst one of these groups of birds is spread over all the countries of the tropical zone, the other is limited to a portion of a single continent. To render such an exhibition thoroughly useful, two additional helps are required, viz., a complete system of explanatory labels, and a popularly-written and well-illustrated handbook, which should not only serve as a guide to the more important and interesting specimens, but give a systematic outline of the all-wise plan which we endeavour to trace in God's creation.

There is one part of the museum which I intend to treat in a different manner from the rest; and that is the collection of British animals. For the same reasons for which I have in a former part of this address insisted on district faunas being fully represented in provincial museums, I consider a complete exhibition of the British fauna to be one of the most important objects of the National Museum. Its formation is, strange as it may appear to many of you, still a desideratum, and a task which will occupy many years. It will not be easy (especially when you are in danger of infringing an Act of Parliament) to form a complete series of British birds, showing their change of plumage, their young, their eggs, their mode of nidification; it is a long work to collect the larvæ and chrysalides of insects, and to mount the caterpillars with their food-plants; and we shall require the co-operation of many a member of the British Association when we extend the collection to the marine animals and their metamorphoses. But all the trouble, time, and labour spent will be amply repaid by the direct benefits which all classes will derive from such a complete British collection.

My time is becoming short, and yet I find that I am far from having completed the task I had set to myself. Therefore let me briefly refer only to a few points which, of late, have much agitated those who feel a direct or indirect interest in the progress of the National Museum. In the first place, we must feel deeply concerned in everything relating to the conservation of the collections. If the objects could speak to you, as they do to those familiar with their history, many of them would tell you of the long hours of patient inquiry spent upon them; many might point with pride at the long pages written about them—alas! not always with the even temper which renders the study of natural science a delight and a blessing; others would remind you of having been objects of your wonder when you saw them depicted in scientific books, or in some household work; whilst not a few could tell you pitiful tales of the enthusiastic collector who, braving the dangers of a foreign climate, sacrificed health or life to his favourite pursuit. Collections thus obtained, thus cherished, representing the labours of thousands of men, and intended to instruct hundreds of thousands, are worth preserving, displaying, and cultivating. No cost has been spared in housing them: let no cost be spared in providing proper fittings to receive them, a sufficient staff to look after them, and the necessary books to study them.

What we chiefly require in a well-constructed exhibition-case is that it should be as perfectly dust-proof as possible, that it should lock well and easily, and yet that it should be of a light structure. Every one who has gone through a gallery of our old-fashioned museums must have noticed how much those broad longitudinal and transverse bars of the wooden frame of the front of a case interfere with the inspection of the objects behind them, hiding a head here, a tail there, or cutting an animal into two more or less unequal portions. Ill-constructed cases have brought zoological collections as much into bad repute as bad stuffers; and if it be thought that a pound could be saved in the construction of a case, that pound will probably entail a permanent expense of a pound a year. Now all the requisites of a good exhibition-case can be obtained by using metal wherever it can be substituted for wood; and although its use is more expensive

than that of wood, you will join with me in the hope that no mistaken desire of economy will prevail now, as the time has arrived to furnish our priceless collections with adequate fittings.

Probably all of those present are aware that the formation of a national history library has been urged almost from the very first day on which the removal of the Natural History Collections to South Kensington was proposed. But the cost and extent of such a library have been very variously estimated. And I am sorry to say that it is, I believe, owing to expressions of opinion on the part of those who ought to know better, that the cost of this library was considerably underrated when the removal to South Kensington was determined upon. We cannot blame the Government that they hesitated for years before they acceded to the pressing representations of the Trustees of the British Museum to begin with its formation, when they were told by naturalists that the cost of such a library would be something between 10,000*l.* and 20,000*l.* I could hardly believe my eyes when I read, only a few weeks ago, in the leader of a weekly periodical specially devoted to science, "that had the Trustees put aside 1,000*l.* a year for this purpose, when it was first determined to remove the Natural History Collections ten years ago, there would have been by this time in existence a library fully adequate to the purpose." The writer must have either a very poor idea of the objects and work of a national museum, or an imperfect knowledge of the extent of the literature of natural history. 10,000*l.* might suffice to purchase a good ornithological library, and 1,000*l.* would purchase the annual additions to all the various branches of natural history; but the former sum would be much too small if the purchase of those works only were intended which are required for the technical work of naming animals, plants, fossils, and minerals. A better calculation was made by the Select Committee of the House of Commons on the British Museum in 1860, who stated that the formation of a natural history library would "cost about 30,000*l.* at the present time" (1860). Considering that twenty years have elapsed since, and that this part of the literature has shown year by year a steady increase, we must put our estimate considerably higher than the writer of that article.

With the aid of some of my friends who know, from their daily occupation, the market value of natural history works, I made a calculation some years ago, and we came to the conclusion that a complete natural history library will cost 70,000*l.*, and, unpalatable as this statement may be to those who have advocated the removal of the natural history collections, and therefore must be held responsible for this concomitant expense, it will be found to be true. It will be satisfactory to you to learn that the Government have at last sanctioned the expenditure of half that amount.

Now, in my opinion, such a library formed in connection with the National Museum should not be reserved for the use of the officials, but I would recommend that it should be accessible to the general class of students in the same manner as any other part of the collections. It is for this reason that I wish to see it rendered as perfect as possible with respect to the older publications (many of which are getting scarcer year by year) as well as to the most recent. Whether or not a similarly perfect collection of natural history books exists in some other place in London, is another question with which I am not concerned. It is evident that a general national library ought to contain a perfect set of books on natural history, irrespective of other claims; but to have natural history collections in one place, and the books relating to them in another miles away, will produce as much inconvenience as is experienced by the person who puts the powder into the one barrel of his gun and the shot into the other.

If the British Museum (for the collections will remain united under this old time-honoured name, though locally separated) continues to receive that support from the Government to which it is justly entitled, I have no doubt that it will not only fulfil all the aims of a national collection, but that it will be also able to give to the kindred provincial institutions the aid which has recently been claimed on their behalf. Under an Act of Parliament which was passed in the previous session, and which empowers the Trustees to part with duplicate specimens, several of these museums have already received collections of zoological objects. But I consider it my duty to caution those who are in charge of those museums to be careful as to the manner in which they avail themselves of this opportunity. Well-preserved duplicates of the rarer and more valuable vertebrate animals are very scarce in the British Museum, the funds for purchase being much too small to permit of the acquisition of duplicates. What

we possess of this kind of duplicates are generally deteriorated specimens, and therefore ought not to be received by provincial museums. On the other hand, our invertebrate series, especially of mollusks and insects, will always offer a certain number of well-preserved duplicate specimens, and a sufficient inducement for provincial museums to select their desiderata.

It has been suggested that as the British Museum has correspondents and collectors in almost every part of the globe, and has therefore greater facilities for obtaining specimens than any other institution, it should systematically acquire duplicates, and form a central repository, from which provincial museums could draw their supplies. If the necessary funds to carry out this scheme were granted, I cannot see any objection to it on the part of the British Museum which, on the contrary, would probably derive some benefit. But there is one, and in my opinion a very serious, objection, viz., that this scheme would open the door to the employment of curators of inferior qualifications; it would relieve the curator of a provincial museum of an important part of his duty, viz., to study for himself the requirements of his museum, the means of meeting them, and to become well acquainted with the objects themselves. A curator who has to be satisfied with the mechanical work of displaying and preserving objects acquired, prepared, and named for him by others takes less interest in the progress of his museum than he whose duty it would be to form a collection; he is not the person in whose charge the museum will flourish.

In speaking of the claims of Provincial Museums on the National Museum, the kindred Colonial institutions should not be forgotten. We owe to them much of our knowledge of the natural history of the Colonies; they are the repositories of the collections of the temporary and permanent surveys which have been instituted in connection with them; and they have concentrated and preserved the results of manifold individual efforts, which otherwise most likely would have been lost to science. The British Museum has derived great benefit from the friendly relations which we have kept up with them; and, therefore, they are deserving of all the aid which we can possibly give them, and which may lessen the peculiar difficulties under which they labour in consequence of their distance from Europe.

I am painfully aware that, in the remarks which I have had the honour of making before you, I have tried the patience of some, and not satisfied the expectations of others. But so much I may claim: that the views which I have expressed before you as my own are the results of many years' experience, and, therefore, should be worthy of your consideration; and that I am guided by no other desire than that of seeing the museums in this country taking their proper place in regard to biology, and as one of the most important aids in the instruction of the people.

### NOTES

IN mediæval ages Rheims was a seat of learning, and in 1547 the Cardinal of Lorraine established there a university, which flourished until it was suppressed at the French Revolution. But although the present Republican Government has instituted in this ancient city a school of medicine, the liberal arts are little cultivated by the inhabitants, who are mostly engaged in commercial and manufacturing occupations. Rheims possesses the greatest wine trade in the world and the richest woollen manufactures in France. So, although the French Association has met with a very handsome reception, the local budget of scientific contributions was very meagre indeed, except in the sections of anthropology and archæology, which were a local success. M. Cotteau gave an address describing the geological character of the Rheims district, and illustrated by the local exhibition which had been arranged in one of the halls of the Lycée by M. Perron. M. Lemoine, Professor in the School of Medicine of Rheims, exhibited a rich collection of objects of palæontological interest which had been formed by him from the surrounding district. This was exceptionally rich in objects of the cretaceous period, mostly of polished stone, and wonderfully preserved in the caves so numerous in the cretaceous formation, and which are now stuffed to protect against variations of temperature an immense quantity of bottled wine destined to be sent to all parts of the world. An excursion, specially interesting for archæologists, was organised to Epernay, where M. Baye, a rich proprietor,

had collected in his château a number of curiosities belonging to the Carolingian periods. Two other special excursions were organised, the first to the ruins of old Coucy Castle and St. Gobain, the largest glass foundry in France, where a large lump was cast in presence of the visitors, and the second to St. Menehould, which was supposed in former times to be the key of French independence. The most attractive excursion was undoubtedly to the caves where champagne is manufactured by the old process, which was scientifically described by M. François, a chemist of Châlons-sur-Marne. A demonstration of the principles of the operation was given in the caves of Pommery, where Madame Pommery kindly permitted the visitors to make a practical test of the quality of her celebrated produce. Synoptical tables had been prepared exhibiting the progress of the manufacture. The superiority of the champagne manufactured in Rheims and vicinity is attributed not only to the long experience of the workmen and the excellence of the receipts used, but to the perfect equality of temperature maintained in the old galleries where it is stored. Some of these are several acres in area, and are quite full of bottles. After the final meeting a general excursion was made to the celebrated grotto of Han in Belgium. The two lectures by M. Perier on "Transformism," and M. Garel on "Radiant Matter," were delivered, at the solicitation of the local committee for their information; the lecturers confined themselves to the clear enunciation of known facts, and to experiments already well known to the scientific world. M. Javal gave a public lecture on the Hygiene of the Eye, and M. Richet on the Symptoms of Somnambulism. About 500 members were present at the meeting this year, exclusive of local members. Among foreign visitors were Professors Sylvester and Hennessy. At the final session M. Janssen was elected president for 1882, when the meeting will be held at La Rochelle, and M. Emile Trelat will be general secretary; they will act as vice-president and vice-secretary respectively for the session of 1881, which will be held at Algiers in the first week after Easter. The president of the Algiers session will be M. Chauveau, Professor at the Veterinary School of Lyons, and the secretary will be M. Maunoir, general secretary of the French Geographical Society. A very large attendance is anticipated, as a diminution of 50 per cent. on the fares is expected, and the visit will take place at an exceptionally advantageous season. A general committee has been formed, having at its head M. Tomel, senator of Orléans, and director of the newly-created School of Sciences. The Governor-General will be honorary president, and M. MacCarthy, president of the Algiers Society of Natural Sciences, has been nominated by the General Committee of Rheims president of the Section of Geography. The Rheims authorities and citizens have done everything within their power to welcome their guests, and the meeting has been on the whole successful.

FROM an additional Circular sent us from the American Association we see that nearly all the railway lines connected with Boston, the place of meeting, offer great facilities for the conveyance of members. Some of the companies indeed give those attending the meeting free tickets, while the others issue tickets at one-half the usual rates. Is it too much to expect similar advantages from English companies? Has the attempt ever been made?

A VERY interesting annual meeting of the Entomological Club of the American Association was to be held at Boston on Tuesday. Among other subjects to be brought forward, Mr. R. Grote was to speak of generic characters in the *Noctuidæ*; Mr. E. P. Austin hoped to exhibit some interesting specimens from his extensive collection of North American Coleoptera; Mr. Wm. Saunders to discuss Insectivorous Birds, their habits and demerits; Rev. H. C. McCook to read a paper on the Honey Ants of the Garden of the Gods, Colorado; Mr. S. M.

Scudder to exhibit interesting fossil insects, and illustrations of New England Butterflies; Dr. J. L. Le Conte to present an essay on Lightning Bugs, and give a list of Coleoptera hatched from a few hickory twigs; and Dr. H. A. Hagen to present papers on the Hessian Fly, on the anatomy of *Productus deceptus*, and on a new worm parasitic on insects.

THE third International Congress of Geography meets at Venice from the 15th to the 22nd of September, 1881, under the patronage of King Humbert. The accompanying exhibition will be opened on September 1, and will not be closed before October 1. The Congress will be divided into seven groups: 1. Mathematical, Geodetic, and Topographical Geography. 2. Hydrography and Maritime Geography. 3. Physical, Meteorological, Geological, Botanical, and Zoological Geography. 4. Historical, Ethnographical, and Philological Geography. 5. Economical, Commercial, and Statistical Geography. 6. Methodology; Geographical Education. 7. Exploration. Further information may be obtained by addressing "Al Comitato ordinatore del 3° Congresso Geografico Internazionale, 26, Via del Collegio Romano, Roma."

THE Sixth Annual Conference of the Cryptogamic Society of Scotland will be held in Glasgow, on September 27-30, and October 1 and 2, when all persons interested in cryptogamic botany are invited to attend. A detailed prospectus of the meetings, excursion, and show may be had on application to the Local Secretaries, on and after September 6. Fellows and others from a distance who purpose attending the Conference are requested to send intimation thereof as soon as possible to the Secretary, to whom also intimation of papers to be read should be sent. Fellows are requested to bring or send specimens of interest in any branch of cryptogamic botany for exhibition at the meeting and show. The Secretary is Dr. F. Buchanan White, Perth, and the Local Secretaries Mr. W. J. Milligan, 180, West Regent Street, and Mr. A. Turner, 122, Hospital Street, Glasgow.

THE annual meeting of the Mineralogical Society of Great Britain will be held at Swansea, in the Unitarian School-room, High Street, on Friday, August 27, at 2.30 p.m. The Council will meet at 2 p.m. All communications intended for this meeting should be addressed to the Secretary, Mr. J. H. Collins, F.G.S., at the Reception Rooms, British Association, Swansea.

WE understand that the long-expected first volume of Prof. Arthur Gamage's "Text-book of Physiological Chemistry" may be expected to appear in the middle of September. This volume, which will be published by Macmillan and Co., deals with the Chemistry of the Tissues, and is to be succeeded in the space of a few months by a second and concluding volume, treating of the Chemical Processes Associated with the Animal Functions. Dr. Gamage's work is, we are informed, a more elaborate treatise than has hitherto appeared on this branch of science. It deals with the subject from the point of view of the physiologist and the physician rather than from that of the pure chemist; it is indeed an advanced treatise, dealing with those departments of physiology and pathology which involve a study of chemical facts, and not, as all text-books of physiological chemistry, save those of Lehmann and Kühne, have been, a work treating of one branch of Applied Chemistry. The work is well illustrated; it contains a very full and complete account of the whole literature of each subject treated of, and besides being a systematic treatise, is intended to serve as a practical guide for the student of physiological chemistry.

IN Mr. Wallace's forthcoming work—"Island Life," no less than five chapters are devoted to geological subjects which he considers to be of fundamental importance for the study of questions of distribution,—such as the permanence of continents

and oceans, glacial epochs and mild arctic climates, and the measurement of geological time. A complete and in many respects a novel solution of the problem of geological climates is attempted; and as the distribution of both animal and vegetable forms is dealt with this volume will probably interest a wide class of readers.

MR. R. BULLEN NEWTON, assistant naturalist under Prof. Huxley in the Museum of Practical Geology, Jermyn Street, has received an appointment in the geological department of the British Museum.

A BALLOON ascent was made at Cherbourg, on the occasion of the fête given by the Municipality to M. Grévy, by MM. Perron and Capt. Gauthier. The general direction of the wind being from the land to the sea, a government steamer was sent out to secure the safety of the aeronauts if necessary. Before starting not less than thirty pilot-balloons were sent up to ascertain the superposition of the aerial currents. It was proved that at 400 metres the wind was blowing from the sea. After having travelled for more than an hour in the direction of Portsmouth, the aeronauts opened their valve and returned safely on shore. More than a hundred thousand spectators witnessed the experiment. The culminating point of the ascent was an altitude of 1,500 metres, where the travellers could see the English coast, the whole of the Isle of Wight, &c. The scenery is stated to have surpassed description. Some very curious observations were made on the colours of the sea. In the places where the water is very deep it looks quite inky, and the curves of level are so clearly manifested that they bear comparison with equidistant lines worked on ordnance maps. When travelling at so great an altitude ships can be detected with some difficulty; but smoke can be seen even when the smoke-producing steamer can hardly be perceived with the naked eye.

AT a recent meeting of the Asiatic Society of Bengal, Mr. L. Schwendler gave an instance of a Langur monkey (*Semnopithecus entellus*) having been taught to do useful work. Mr. Schwendler's "trustworthy informant" was Babu B. Pyne, a member of the Government Telegraph Department. The Babu says:—"Some years ago I had a Langur which, when standing erect, measured fully 2 feet 6 inches. The animal was very powerful, and could easily pull a punkha measuring eight feet in length. It was a male, and even when young showed a disposition to be highly savage. The older it got the more savage it became. Seeing the great power this monkey had, I wanted to utilise it, and therefore intended to employ it for the purpose of pulling punkhas. The teaching I effected in the following manner:—The monkey was tied by the waist close to a strong pole, so that it could not move either backwards or forwards, or right or left. Both hands were tied to a rope attached to a punkha, which was regularly pulled from the other side by a man. Thus the animal had to sit in one place, and could only move its hands up and down with the punkha rope. In this way the monkey in a comparatively short time learnt to pull the punkha by itself, and was so employed by me for several years. It always kept in first-rate health, enjoyed its work immensely, and did it equally well, if not better, than a cooly. During the rains it suffered from fever, and ultimately died. Putting now this trained monkey in the place where the man used to pull the punkha, and a new Langur in the place where the trained monkey formerly sat, I attempted to teach successively four more monkeys, two of which were females. I succeeded perfectly in teaching the males, but was quite unsuccessful with the females." Mr. Schwendler said there is a certain amount of intelligence required to do this work, since the arms, in their up and down movements, have to keep time with the swinging punkha. Mr. Schwendler mentioned some other instances in which the display of intelligence by monkeys had

been noticed. In particular he mentioned a case in which a monkey, which had sustained a fall from trusting to a rotten branch while swinging on a tree, had been observed afterwards to examine the branches of the tree, and to break off those which it found to be rotten. Some discussion ensued as to whether the action of the monkey in this case was the result of intelligence, and some of the members present were of opinion that it might have been the result simply of anger caused by the fall. Mr. Schwendler, however, stated that he had for long made the habits of animals a study, and that he was convinced of the fact that monkeys were possessed of much intelligence; and he vouched for the authenticity of the statements made in the paper read regarding the monkeys which were taught to pull a punka.

THE *Times* Geneva correspondent telegraphs as follows:—  
 "An interesting geological discovery has been made in the neighbourhood of Solothurn. On removing a mass of superincumbent sand and gravel to prepare for some quarrying operations, the rock beneath was found to be quite smooth and intersected with old water channels. The excavation being continued, a number of enormous holes filled with great stones were laid bare. These holes, like those in the famous Gletcher Garten at Lucerne, are due to the action of water, which, flowing through rifts in the glacier that ages past covered the rock, set in movement the stones beneath, whereby the 'Giant's Kettles,' as they are called, were hollowed out; but while the rock at Lucerne is sandstone, the formation at Solothurn is hard limestone and quartz."

AT Judicarien and Riva, in the Tyrol, a rather smart shock of earthquake was felt on the 12th inst.

A CORRESPONDENT writes in reference to our Notes regarding the successes of the ladies in the recent London University Examination (*NATURE*, vol. xxii. pp. 346 and 374), calling attention to the fact that the position of the successful candidates in the respective divisions of the lists referred to (*i.e.*, the Pass Lists of the 1st B.A. and 1st B.Sc. Examinations) is determined by the alphabetical order of their names, and is therefore accidental. This does not refer to the Honours Lists, which have since been published, and in which the candidates are arranged in order of merit.

FROM a report drawn up by Don Mariano Barcena, Director of the Central Meteorological Observatory of Mexico, the *Gardeners' Chronicle* learns that it is proposed to establish a large number of stations throughout Mexico for the uniform record of observations on the temperature, pressure, rainfall, vegetation, &c. Should this project be properly inaugurated and continued, it will be of the greatest service to science. The observers will likewise report on the state of the crops, prices of grain, and other commodities, &c., as affected by the weather.

MR. BRYCE-WRIGHT writes to the *Times* that numbers of false turquoises have during the last two weeks come from Vienna and are still arriving? Their detection is somewhat difficult, the backs of every specimen having been pecked out and the holes filled with a black cement, to imitate the matrix of La Vieille Roche. They are, however, a little lighter than the real turquoise, the specific gravity being 2.4, while that of the genuine stone is 2.6 to 2.8. The easier method of distinguishing them is to use a penknife to the false matrix, which can easily be removed, revealing the artificial perforations.

THE additions to the Zoological Society's Gardens during the past week include two Macaque Monkeys (*Macacus cynomolgus*) from India, presented respectively by Mr. H. G. Wainwright and Mr. Cecil Peele; two Tcheli Monkeys (*Macacus tcheliensis*) Shanghai, China, presented by Dr. Buehll; and a Brown ) from Guiana, presented by Mr. Percy

E. Scrutton; a West Indian Agouti (*Dasyprocta cristata*) from the West Indies, presented by Mr. W. H. Braithwaite; a Spotted Salamander (*Salamandra maculosa*), European, an Axolotl (*Siredon mexicanus*) from Mexico, presented by Dr. Gibbs, F.Z.S.; a Common Cormorant (*Phalacrocorax carbo*), British, deposited; a Straw-necked Ibis (*Corphibis spinicollis*), a Maned Goose (*Bernicla jubata*) from Australia, an Elate Hornbill (*Buceros elatus*) from West Africa, two Brown Mynahs (*Acridotheres fuscus*) from India, purchased.

OUR ASTRONOMICAL COLUMN

THE SATELLITES OF SATURN.—Mr. Marth has published (*Astron. Nach.*, No. 2,328) his ephemeris of the five interior satellites of Saturn, with the usual fulness of detail. For *Mimas* he now assumes accelerated motion, leaving it to be decided by further observation whether this hypothesis is the correct one to account for the discrepancies which have been recently remarked between his predictions and observation in the case of this difficult object. Mr. Marth's times of greatest elongations of *Mimas* now accord within 0.2h. with those deduced from the circular elements which we have adopted on several occasions for predictions in this column, and which were founded upon a very approximate discussion of measures at the Naval Observatory, Washington, in the years 1874-77. Without some such hypothesis as accelerated motion, however, these elements will not represent the observations even as late as Lassell's, and it has been only with the view of facilitating to some extent the identification of the satellite about this epoch that they have been from time to time employed. They give the following times of elongations, which may be compared with Mr. Marth's:—

East Elongations			West Elongations		
	h.	m.		h.	m.
Aug. 30	15	15	Sept. 7	15	30
31	13	52	8	14	7
Sept. 1	12	29	9	12	44
2	11	6	11	11	21
3	9	43	11	9	58

THE BINARY-STAR α CENTAURI.—Mr. Tebbutt communicates to the *Observatory* measures of this object made at Windsor, N.S.W., in the first half of the present year; duly weighted the mean result is:—

1880.311 ... Position, 186°.53; Distance, 5".16.  
 Dr. Doberck's elements give the angle less by 2".9, and the distance also less by 0".21. An able investigation on the parallax of this star, with a new determination of the orbit by Mr. W. L. Elkin of Strassburg has just appeared.

THE GREAT COMET OF 1880.—Dr. B. A. Gould, the director of the National Observatory of the Argentine Republic at Cordoba, has passed through London during the last week. He describes the appearance of the Southern Comet of February, of which he has put upon record the longest series of observations as involving very great difficulty in fixing accurate positions with the telescope, while with the naked eye there was an equal difficulty in saying where the tail originated, there being no nucleus, or head, to use the old term, worthy of the name.

If a systematic search for comets had been organised in the southern hemisphere (shall we say had southern astronomers been so far ahead of their northern *confreres*?) possibly the comet might have been detected before perihelion, and some most interesting results would have accrued. The reader may perhaps like to see the track which the comet must have followed in its approach to the sun, which the subjoined places will sufficiently indicate:—

12h. G.M.T.	Right Ascension	Declination	Distance from Earth.	Intensity of Light.
1879, Dec. 28	51°0	... -73°5	... 0.630	... 3.7
1880, Jan. 2	... 9°1	... 69°8	... 0.611	... 3.7
7	... 346°3	... 59°9	... 0.621	... 4.3
12	... 334°8	... 48°8	... 0.660	... 4.3
17	... 327°4	... 38°2	... 0.727	... 4.3
22	... 321°1	... -28°5	... 0.824	... 4.3

The last column contains the values of  $\frac{1}{r \Delta}$  and may be of questionable application in this instance.

## A FRAGMENT OF PRIMEVAL EUROPE

WHEN the history of the growth of the European area is traced backward through successive geological periods, it brings before us a remarkable persistence of land towards the north. The stratified formations bear a generally concurrent testimony to the existence of a northern source whence much of their sediment was derived, even from very early geological times. In their piles of consolidated gravel, sand, and mud, their unconformabilities and their buried coast-lines, they tell of some boreal land which, continually suffering denudation, but doubtless at intervals restored and augmented by upheaval, has gradually extended over the whole of the present European area. The chronicles of this most interesting history are at best imperfect, and have hitherto been only partially deciphered. They naturally assume an increasingly fragmentary and obscure character in proportion to their antiquity. Nevertheless traces can still be detected of the shores against which the oldest known sedimentary accumulations were piled. The shores have of course been deeply buried under the deposits of subsequent ages. But the whirligig of time has once more brought them up to the light of day by stripping off the thick piles of rock beneath which they have lain preserved during so vast a cycle of geological revolutions. I shall here describe a fragment of this earliest land, and allude to some of the geological problems which it suggests.

In the north-west of Scotland, along the seaboard of the counties of Ross and Sutherland, a peculiar type of scenery presents itself, which reappears nowhere else on the mainland. Whether the traveller approaches the region from the sea or from the land, he can hardly fail to be struck by this peculiarity, even though he may have no specially geological eye for the discrimination of rock-structures. Seen from the westward or Atlantic side, as, for example, when sailing into Loch Torridon, or passing the mouths of the western fjords of Sutherlandshire, the land rises out of the water in a succession of bare rounded domes of rock, crowding one behind and above another, as far as the eye can reach. Not a tree or bush casts a shadow over these folds of barren rock. It might at first be supposed that even heather had been unable to find a foothold on them. Grey, rugged, and verdureless, they look as if they had but recently been thrust up from beneath the waves, and as if the kindly hand of nature had not yet had time to clothe them with her livery of green. Strange however as this scenery appears when viewed from a distance, it becomes even stranger when we enter into it, and more especially when we climb one of its more prominent heights and look down upon many square miles of its extent. The whole landscape is one of smoothed and rounded bosses and ridges of bare rock, which, uniting and then separating, inclose innumerable little tarns (Fig. 1). There are no definite lines of hill and valley; the country consists, in fact, of a seemingly inextricable labyrinth of hills and valleys, which, on the whole, do not rise much above, nor sink much below, a general average level. Over this expanse, with all its bareness and sterility, there is a singular absence of peaks or crags of any kind. The domes and ridges present everywhere a rounded, flowing outline, though here and there their outline has been partially defaced by the action of the weather.

The rocks that have assumed this external contour are the Fundamental, Lewisian, or Laurentian gneiss, which, as Murchison first showed, form the platform whereon the rest of the stratified rocks of Britain lie. They do not, however, cover the whole surface of these north-western tracts. On the contrary, they form a broken fringe from Cape Wrath to the Island of Raasay, coming out boldly to the Atlantic in the northern half of its course, but throughout the southern portion retiring chiefly towards

the heads of the bays and sea-lochs, and even extending inland to the head of Loch Maree. The reason of this want of continuity is to be found in the spread of later formations over the gneiss. At the base of these overlying deposits comes a mass of dark red sandstone and conglomerate (classed as Cambrian by Murchison and his associates), which, in gently inclined or horizontal strata, sweeps across the platform of gneiss, rising here and there into solitary cones or groups of cones fully 3,400 feet above the sea. No contrast in Highland scenery is more abrupt and impressive than that between the ground occupied by the old gneiss and that covered by this overlying sandstone group. So sharp is the line of demarcation between the two tracts that it can be accurately followed by the eye even at a distance of several miles. Where the sandstone supervenes, the tumbled sea of bare grey gneiss is succeeded by smooth heathy slopes, through which the flat or gently-inclined parallel edges of the beds protrude in successive lines of terrace. As the ground rises into conical mountains, the covering of heather grows more and more scant, but the same terraced bars of rock continue to rise even to the summits, so that these vast solitary cones, standing apart on their platform of gneiss, have rather the aspect of rudely symmetrical pyramids than the free, bold sweep of crag and slope so characteristic of other Scottish mountains.

The depth of these sandstones must amount to several thousand feet. Even in single mountains a thickness of more than three thousand four hundred feet can be taken in at a glance of the eye from base to summit. Yet when this massive formation is followed along the belt of country in which it lies it is found to thin out rapidly and even for some distance to disappear. Such a disappearance might arise either because the formation was not continuously deposited or because it was unequally worn down before the next formation was accumulated upon it. Evidently the solution of this question will have an important bearing on any reconstruction of the early geography of the region.

Above the red sandstones and creeping across them transgressively lies the deep pile of white quartzites, limestones, and schists which Peach's discovery of recognisable fossils in them at Durness showed to be of Lower Silurian age. Another well-marked contrast of scenery is presented where these rocks abut upon those just described. The quartzites rise into long lines of bare white hills which, as the rock breaks up under the influence of the weather, are apt to be buried under their own debris even up to the summits. Here and there outlying patches of the white rock may be seen gleaming along the crests of the dark sandstone mountains like fields of snow or nascent glaciers. Quartzites, limestones, and schists dip away to the east and pass under the vast series of younger schists which form most of the rest of the Scottish Highlands. This order of succession, first established by Murchison, can be demonstrated by innumerable lines of natural section. I have myself traced it through the mountainous country from Cape Wrath to Skye, and in many traverses across Sutherland and Ross. I have sought for evidence of the reappearance of the old or fundamental gneiss of the north-west, and have ransacked every Highland county in the search, but have never found the least trace of that rock beyond its limits in Sutherland and Ross. Its distinctive gneisses and other crystalline masses, so wonderfully unlike anything else in the Highlands, never reappear to the east. And this strange mammillated, bossy surface is found in the north-west alone.

To realise what the appearance of the old gneiss at the present surface means we must bear in mind that it was first buried under several thousand feet of red sandstone, that the area was then further advanced until the vast pile of sediment was deposited on a level the

lands have been formed, that these sedimentary accumulations—how many thousand feet thick we cannot yet tell—were subsequently over the Highland area crumpled and metamorphosed into crystalline schists, and that finally towards the west the ancient platform of gneiss

was once more ridged up and gradually bared of its superincumbent load of rock, until now at length some portions of it have been once more laid open to the air.

There is thus a special historical interest in this fragment of the old gneiss country. It is a portion of the



FIG. 1.—View of the ancient platform of gneiss looking eastward from above Scourie, Sutherlandshire. The hill to the left (one bird) is Arlic (6,580 feet), composed of quartzite resting on the fundamental gneiss, and dipping eastward; the conical mountain Stack (6,564 feet, marked here by two birds) consists of the old gneiss—the highest elevation reached by this rock on the mainland. The gneiss-sweeps southward and inland identifies the great conical mountain of Queening (6,953 feet, four birds), while in the distance (three birds) are seen the quartzite heights of Ben More Aghynt (6,235 feet).

European surface of which as yet we know any—a surface in chronological comparison with which we are of quite modern date. For many years past we at intervals wandered over it, finding in its undulations of bare rock a fascination which a fairer landscape

might fail to exert. Each visit suggests some new problem, if it does not cast light on earlier questions. One of the questions which must particularly engage the attention of every observant traveller in Western Sutherland and Ross is the origin of that

presented by the gneiss. A very slight examination shows that every dome and boss of rock is ice-worn. The smoothed polished and striated surface left by the ice of the glacial period is everywhere to be recognised. Each hummock of gneiss is a more or less perfect *roche moutonnée*. Perched blocks are strewn over the ground by thousands. In short, there can hardly be anywhere else in Britain a more thoroughly typical piece of glaciation.

An obvious answer to the question of the origin of the peculiar configuration of this gneiss country is to refer it to the action of the last ice-sheet which covered Britain. That the gneiss was powerfully ground down by that ice

landshire is comparatively small. As shown in Fig. 1 it rises somewhat steeply from the west, its chief area and drainage lying towards the east. I have visited those tracts of the Highlands where the rocks approach nearest to the type of the ancient gneiss, and where the conditions have been most favourable for intense glaciation. No more promising locality for a comparison of this kind could be found than the deep defiles of Glen Shiel and Kintail. The rocks have there been extremely metamorphosed and have been exposed to the action of ice descending from some of the highest uplands in the West of Scotland. Yet we look in vain among them for any semblance of the bare bossy surface of the old gneiss.

A further difficulty arises when we reflect that in the general erosion of the country the gneiss, being covered by later formations, would be the last to be attacked, and in so far as it was so covered, must have been exposed to the erosive action of the ice for a shorter time than the overlying rocks. We might therefore have presumed that instead of being more, it would have been less trenchantly worn down than these. Its great toughness and durability, which have enabled it to retain the ice-impress so faithfully, must have given it considerable powers of resistance to the grinding action of the glacier.

Every fresh excursion into these northern wilds has increased my difficulty in accounting for the peculiar contours of the gneiss ground by reference merely to the work of the Glacial period. A recent visit, however, seems at last to have thrown some light on the matter. I had long been familiar with the fact that the platform of gneiss on which the red sandstones and conglomerates were laid down abounded in inequalities even at the time of the deposit of these strata. Its uneven surface rose here and there into high ridges and cones, of which Stack is a diminished representative, and sank into depressions now occupied by thick masses of sandstone. But I have lately observed that not only do these larger features pass under the sandstone, but that the minor domes and bosses of gneiss do so likewise. On both sides of Loch Torridon, for example, the hummocky outlines of the gneiss can be seen emerging from under the overlying sandstones

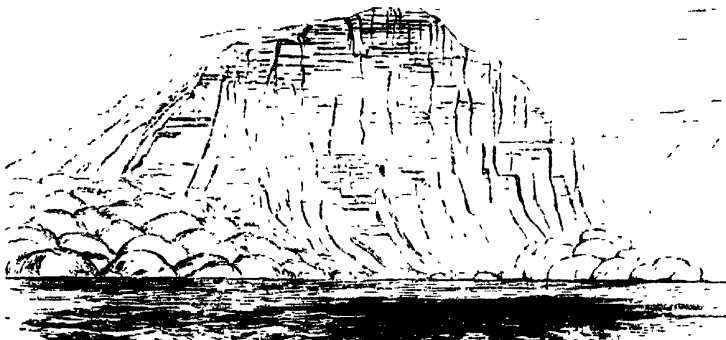

FIG. 2.—Ben Shieldag, Loch Torridon—a hill of flat Cambrian red sandstone resting upon an uneven hummocky surface of the old gneiss.



FIG. 3.—View of outlier of Cambrian breccia and sandstone among gneiss hills near Gairloch.

is sufficiently manifest. But if the peculiar bossy surface is to be thus explained we are confronted by the difficulty that the ice must have acted far more effectively on the gneiss than on any other rock in the region. Yet there is nothing in the configuration of the ground to make the erosion greater on the gneiss than on the red sandstone or quartzites and schists. The same side of a sea-loch may be seen to present slopes both of gneiss and sandstone; the gneiss is always worn into smooth domes, ridges, and hollows; but the sandstone retains its parallel bands of rocky terrace. The difference is evidently not due to any greater glacial abrasion of the gneiss. The area of high ground above the gneiss platform in Suther-

(Fig. 2). On the west side of Loch Assynt similar junctions are visible. But some of the most impressive sections occur in the neighbourhood of Gairloch. Little more than a mile to the north of the church the road to Poolewe descends into a short valley surrounded with gneiss hills. From the top of the descent the eye is at once arrested by a flat-topped hill standing in the middle of the valley at its upper end, and suggesting some kind of fortification; so different from the surrounding hummocky declivities of gneiss is its level grassy top, flanked by wall-like cliffs rising upon a glacial slope of debris and herbage (Fig. 3). Closer examination shows that the little eminence is capped with a coarse reddish breccia made



up of fragments from the surrounding gneiss. The stones in this deposit are for the most part perfectly angular, and are sometimes stuck on end in the mass. They underwent but little re-arrangement after they were thrown down, though occasional lenticular seams of red sandstone running through the rock serve to prove that it is lying as a flat cake on the gneiss. My friend Mr. Norman Lockyer accompanied me in the examination of this hill. We searched long for a striated stone among the component materials of the breccia, but the matrix was too firm to allow us to bare and extract any of the pebbles or boulders. We traced, however, the characteristic rounded bossy surface of the gneiss until it passed under the breccia, and were convinced that, could the outlier of breccia be stripped off, the same kind of surface would be found below it as on the gneiss above and around. The valley in which this little fragment of a once more extensive deposit of breccia lies certainly existed as a hollow in

Cambrian times. From the narrowness of its present outlet, which has been cut by the escaping streamlet, and from the nature of the breccia, we may infer with some plausibility that the hollow was filled with water, and may have been a lake. It was almost certainly a rock-basin, surrounded with hills of gneiss that had been worn into undulating dome-shaped hummocks.

Behind the new hotel at Gairloch the ground rises steeply into a rocky declivity of the old gneiss. Along the base of these slopes the gneiss (which is here a greenish schist) is wrapped round with a breccia of remarkable coarseness and toughness. We noticed some blocks in it fully five feet long. It is entirely made up of angular fragments of the schist underneath, to which it adheres with great tenacity. Here again rounded and smoothed domes of the older rock can be traced passing under the breccia, as at *a* in Fig. 4. On the coast immediately to the south of the new Free Church a series of



—Sections of the junction of the fundamental gneiss and overlying Cambrian breccia. Gairloch.

instructive sections again lays bare the worn undulating platform of gneiss, with its overlying cover of coarse angular breccia (*b* in Fig. 4).

On these far northern shores, then, there still remain fragments of the surface on which our oldest sedimentary accumulations were deposited. These fragments are found to bear in their smoothed hummocky contours a striking resemblance to the surface which geologists now always associate with the action of glacier-ice. There can at least be no doubt that they are denuded surfaces. The edges of the vertical and twisted beds of gneiss and schist have been smoothly bevelled off. These rocks, however, would never have assumed such a contour if exposed merely to ordinary sub-aërial disintegration. They would have taken sharp craggy outlines like those which are here and there gradually replacing the ice-worn curves of the *roches moutonnées*. They have certainly been ground by an agent that has produced results which, if they were found in a recent formation, would,

without hesitation, be ascribed to land-ice. The breccia, too, is quite comparable to moraine-stuff. Without wishing at present to prejudge a question on which I hope yet to obtain further evidence, I think we have in the meantime grounds for concluding that in the north-west of Scotland there is still traceable a fragment of the earliest known land-surface of Europe, that this primeval country had a smooth undulating aspect not unlike that of the west of Sutherland at the present time, that it contained rock-hollows, some of them filled with water, that into these hollows piles of coarse angular detritus were thrust, that around and beneath the tracks where this detritus accumulated the gneiss was worn into dome-shaped forms strongly suggestive of the operation of land-ice, and that though the ice of the last Glacial Period undoubtedly ground down the platform of gneiss, bared as it was of the overlying formations, it found a surface already worn into approximately the same forms as those which it presents to-day. ARCH. GEIKIE

#### EXCRETION OF WATER BY LEAVES<sup>1</sup>

IN the pamphlet referred to below Dr. Moll gives a detailed account of his investigations upon the excretion of drops of water by leaves, of which an outline was given in the *Botanische Zeitung* for January 23 of the present year.

The question with which he more especially deals is as to whether this excretion is a function which is performed by all leaves, or whether it is confined to such leaves only as possess specially modified organs. The method which he employed in his researches is to place the leaves under the most favourable condition for the excretion of drops by diminishing as far as possible their transpiration, and by supplying them with water. Under ordinary circumstances the excretion of drops is due to the action of the root-pressure; but Dr. Moll substitutes for this, in his experiments, the pressure of a column of mercury, in order to have this important factor in the problem completely under control.

The results, which are of considerable interest, may be briefly stated as follows: out of sixty plants experimented on, the leaves of twenty-nine excreted drops without becoming injected, that is, without their intercellular spaces becoming filled with water; thirteen leaves became injected and excreted drops, and eighteen became injected but did not excrete at all. It appears that the age of the leaf has a very evident influence upon the excretion of drops, for whereas the young leaves of a plant, such as *Sambucus nigra* or *Platanus occidentalis*, for instance, readily excrete drops without becoming injected, the older leaves of the

same plant become injected and excrete scarcely at all. Under these circumstances it is quite possible and even probable, as Dr. Moll himself suggests, that of the eighteen plants the leaves of which became only injected, some at least were capable of excretion at an earlier period. It is only definitely stated of *Hedera*, *Syringa*, and *Taxus* that their leaves do not excrete at all.

As to the organs of excretion, it is effected in eight out of the forty two cases by means of water-pores, but in four of these cases it is effected also by ordinary stomata; in eight other cases it was found to be effected by stomata, and in three cases it took place at portions of the surface which possessed neither water-pores nor stomata. These last cases are carefully distinguished by Dr. Moll from those in which an excretion took place over the whole surface of the leaf in consequence of excessive pressure.

From these observations it appears that most leaves, at least so long as they are comparatively young, are capable of excreting water in drops when it is supplied to them in excess, and further, that this excretion is effected by certain organs (*Emissarien* the author calls them) which may be water-pores, or ordinary stomata, or limited areas of the surface which are histologically undifferentiated. The effect of this excretion is to prevent the injection of the leaves when the root-pressure is great, a condition which would obviously interfere with the circulation of sap in the intercellular spaces, and therefore with the function of the leaf. Dr. Moll suggests that possibly some definite correlation exists between the presence of excretory organs and the existence of root-pressure in a plant; for instance, according to Hohenstein ("Flora," 1862), no root-pressure can be detected in *Conifers*,

<sup>1</sup> "Untersuchungen über Tropfenausscheidung und Injection bei Blättern," von Dr. J. W. Moll. (Amsterdam, 1880.)

and the author has failed to find any excretory organs in their leaves. It may be added, in conclusion, that these organs can excrete not only water but solutions of substances such as tannin, and the juice of Phytolacca berries. Further, Dr. Moll's observations tend to confirm the view that the wood is the channel by which water is conveyed to the leaves from the roots.

SOCIETIES AND ACADEMIES LONDON

Royal Society, June 17.—"On the Constants of the Cup Anemometer," by the Rev. T. R. Robinson, D.D., F.R.S., &c.

In a previous paper the author detailed experiments made by attaching anemometers to a whirling machine, and the conclusions to which they led. He was however doubtful of the accuracy of the method, and proposed one depending on the action of natural wind. He has tried this, and he thinks successfully. Two instruments of the Kew type, differing only in friction, were established 22 feet asunder on the roof of the house and 16 feet above it: the number of turns made by each, and the time, were recorded by a chronograph, and from these, v and v', the velocity in miles per hour of the centres of the cups was known.

The friction of one of these (K) was constant; that of the other (E) was varied by applying to a disk on its axle Prony's brake, which was connected with a spring balance whose tension was recorded during the time of experiment by a pencil moved by clockwork. Thus the mean friction was obtained. It ranged from 353 grains to 4,982.

The equation of an anemometer's motion is

V^2 + v^2 - 2Vvx - f/a = 0

where V is the unknown velocity of the wind, a and x two constants which are to be determined. Each observation gives two equations in which there are four unknown quantities, for it is found that the value of V changes from one instrument to another. This is partly owing to eddies caused by the buildings, but also in great measure to irregularity of the wind itself. It is however also found that these wind-differences are as likely to have + as - signs, and therefore it may be expected that their sum will vanish in a large number of observations. The ordinary methods of elimination fail here even to determine with precision a single constant, and he has proceeded by approximation.

Assuming the value of a given by the actual measurements in his paper = 15.315 at 30' and 32' for 9-inch cups, and that there is no resistance as v^2 except that in the equation, and assuming an approximate value for x, we can compute V and V'. The difference between these must be due to an error in x and to w the wind error, and taking the sum of a series we have

S(V' - V) + Sw = Δx x S(e - e'); e being - V / sqrt(x^2 - 1 + f/av^2)

If the observations are sufficiently numerous Sw = 0, with the assumed x + Δx thus found, recompute the V till the sum of V' - V is insensible, and the final x will give V with a high degree of probability. Twenty-one observations gave a value of x considerably larger than what was obtained with the whirling machine, and of course the limiting factor (that when v' is so large that f/av^2 may be neglected). It is for the Kew type 9" cups

24" arms = 2,831. In this series the differences are so evidently casual as to show that neither a or x change with v.

With this x, K gives the true value of V at it; therefore if any other type be substituted for E' it is easy to find its x, for its a is as area of cups, its f' is known, and assuming its x' and computing as before, we get similarly its Δx. He tried five different types and obtained very unexpected results, for he found that the x varied as some inverse function of the diameter of the cups and of the arms. He gives its values.

Table with 5 columns: No., Original instrument, cups, arms, x. Rows 1-6.

No. 6 is similar to No. 2, and it might be expected that their constants would be equal. The cause of these differences is partly the eddies caused by the cups being more powerful when

the arms are short, but still more the presence of high powers of the arm and diameter occurring in the expressions of the mean pressures on the concave and convex surfaces of the hemispheres. In the present state of hydrodynamics we cannot assign these expressions, but we know enough to see that such powers may be present.

As each type of anemometer has its own constants, the author would suggest to meteorologists the propriety of confining themselves to one or two forms. For fixed instruments he considers the Kew one as good as any, and would wish to see it generally adopted. For portable ones he has no experience except with Casella's 3" cups 6" arms, which he found very convenient; he has not however determined its constants. Some selection of the sort seems necessary if it is wished to have an uniform system of wind-measures.

Entomological Society, August 4.—J. W. Dunning, M.A., F.L.S., vice-president, in the chair.—Sir Sidney Saunders forwarded for exhibition four living specimens of Prosope rubicola, all stylolised females recently bred from larvae extracted from briars received from Epirus, and contributed notes thereon.—Miss E. A. Ormerod exhibited a soft gall-like formation found on Rhododendron ferrugineum, but believed to be of fungoid growth.—Mr. Billups exhibited a specimen of Heptaulacus villosus from Box Hill.—Mr. H. J. Elwes communicated a paper on the genus Colias.—Mr. W. L. Distant read a paper entitled "Notes on Exotic Rhynchota," with descriptions of new species.

VIENNA

Imperial Academy of Sciences, July 8.—The theory of the galvanic element, by Prof. Exner.—Contributions to a knowledge of the eruptive rocks of the neighbourhood of Schemnitz, by Dr. Hussak.—Action of ammonia on isatin (third part), by Dr. Sommaragus.—On a new hydrocarbon of the camphor group, by Herr Kaehler and Dr. Spitzer.—On china-acid, by Dr. Skraup.—On the influence of concentration of the liquids on the electromotive force of the Daniell element, by Dr. Hepperger.—On the action of linear current variations on nerves, by Prof. Fleischl.

July 15.—River-fishes of South America, and other ichthyological contributions, by Dr. Steindachner.—Researches on the influence of light on formation of chlorophyll, with intermittent illumination, by Drs. Mikosch and Stöhr.—On the decomposition of simple organic combinations with zinc powder (continued), by Dr. Jahn.—Action of mercury-ethyl on iodides of hydrocarbons, and a new synthesis of acetylene, by Dr. Suida.—On the compounds formed in action of ammonia and water on some chinon-like derivatives of naphthol, by Prof. Ludwig and Dr. Manthner.—Iron oxalate and some of its double salts, by Herr Valenta.—On the decomposition of iron chloride and some organic ferrid salts in light, by Dr. Eder.—On the phenomena in Geissler tubes under external action (second part), by Prof. Reitlinger and Dr. Urbanitzky.—On the isomorphism of rhombohedral carbonate and nitrate of sodium, by Herr Tschermak.—Measurements of crystals of tellurium-silver, by Dr. Becke.—On the behaviour of some resins in distillation over zinc powder, by Herr Bötsch.—On saligenin derivatives, by the same.—On compounds of the pyrrol series, by Dr. Ciamician.

CONTENTS

Table with 2 columns: CONTENTS and PAGE. Includes sections like DR. BASTIAN ON THE BRAIN, LETTERS TO THE EDITOR, THE BRITISH ASSOCIATION AT SWANSEA, etc.

THURSDAY, SEPTEMBER, 2, 1880

## THE CRUISE OF THE "KNIGHT ERRANT"

IT was accepted by us as one of the general conclusions from the temperature observations made on board the *Challenger* that the normal vertical arrangement of temperature in the ocean is somewhat in this wise. The water is warmest at the surface; from the surface it cools rapidly for the first hundred fathoms or so; it then cools more slowly down to five or six hundred fathoms; and then extremely slowly to the bottom, where the minimum temperature is reached.

I need not here enter into detail as to the causes of this normal condition, which have already been fully discussed.<sup>1</sup> I may state however, generally, that the temperature of the upper strata is raised by solar radiation, and its distribution is affected by currents and by many other local causes; and that the water which has been cooled down in the polar seas until it has acquired a high specific gravity, flows along the bottom and into the deepest abysses to which it has access.

This normal vertical distribution of temperature is by no means universal or even general; it exists only in those parts of the ocean which are continuous throughout their entire depth with a polar sea. No ocean is thus continuous with the Arctic Sea; a wide belt apparently under these normal temperature conditions surrounds the South Pole or the south polar land nearly if not entirely, but the gulf-like northward extensions of the water-hemisphere, the Atlantic and the Pacific, show a distribution of temperature to a certain extent abnormal, and in some seas which occupy more restricted areas, the deviation from the normal conditions is excessive. In oceans where the thermometer sinks steadily from the surface to the bottom, that is to say, in those under normal conditions, the bottom temperature at anywhere near 2,500 fathoms is a little below the freezing point. The Atlantic Ocean is divided into three areas; in one of these, an area extending from the Antarctic Sea along the coast of South America to ten degrees or so north of the Equator, the temperature sinks at the usual rate to 31°·5 F. at the bottom (2,900 fathoms). In another, the eastern basin, extending along the coasts of Europe and Africa, the temperature sinks steadily to 35°·5 at a depth of about 2,000 fathoms, and this temperature extends to the bottom (3,150 fathoms); in the third area, the western basin, off the West Indies and the coast of North America, the temperature falls to 35° at 2,000 fathoms, and this temperature is again continuous to the bottom (3,475 fathoms). As extreme instances of this abnormal condition, in the Celebes Sea, which attains a depth of 2,600 fathoms, the minimum temperature—38°·5 F.—is reached between 700 and 800 fathoms; the Banda Sea, with a depth of 2,800 fathoms, reaches its minimum temperature of 37° F. at 900 fathoms; and the Sulu Sea, which is at least 2,550 fathoms deep, has a uniform temperature of 50°·5 F. from a depth of 400 fathoms to the bottom.

<sup>1</sup> "Hydrographic Proceedings of the Voyage of H.M.S. *Challenger*," Report on Temperatures by Staff-Commander Tizard, R.N. (London, 1876); "The Atlantic," by Sir C. Wyville Thomson, F.R.S., vol. ii. p. 300, *et seq.* (London: Macmillan and Co., 1877.)

The combined results of our soundings and serial temperature determinations led us to conclude that those ocean basins in which the water is of a uniform temperature from a certain depth to the bottom are inclosed within a continuous barrier of a height corresponding to the depth at which the fall in temperature ceases; and that consequently no water at a temperature lower than the isotherm of that depth can pass into them. Suppose such a barrier to rise, as it does rise, in the Atlantic between the south-western and the eastern basins to a height of 2,000 fathoms below the surface, a sounding on the west side to the depth of 2,500 fathoms close to the barrier would give a temperature a little below 32° F., while the thermometer at the same depth on the other side of the barrier would register 35°·5 F. In this way we may have very different temperatures at the same depth, close to one another and apparently under absolutely similar circumstances, and from our experience we should be inclined to accept the existence of continuous barriers as the almost universal explanation of such phenomena.

Of course any generalisation such as I have indicated partakes more or less of the character of a speculation. It is impossible to trace out the entire line of the barrier limiting an ocean basin and to prove its continuity.

In discussing this matter during the cruise of the *Challenger*, Staff-Commander Tizard and I had often in our minds the singular instance of contiguous areas of widely different temperature conditions which had been examined by Dr. Carpenter and myself in the *Lightning* and the *Porcupine* in the years 1868 and 1869.

In the channel between the north coast of Scotland and the Shetland Islands, and the banks and islands of the Faroe group, the average maximum depth is from 500 to 600 fathoms. An abrupt line of demarcation divides this channel into two portions, one of which my colleague Dr. Carpenter called the *cold* and the other the *warm* area.<sup>1</sup> The temperature of the water to a depth of 200 fathoms is much the same in the two areas; in the *cold area*, which occupies nearly the whole of the channel, extending in a north-easterly direction from a line joining Cape Wrath and the Faroe fishing banks, the temperature at 250 fathoms is 34° F., and 30°·5 at the bottom (640 fathoms); in the *warm area* which stretches south-westwards from the same line, the thermometer registers 47° F. at 250 fathoms, and 42° F. at the bottom (600 fathoms).

When the phenomenon was first observed, we concluded than an indraught of cold water, passing southwards from the Spitzbergen Sea, welled into the Faroe Channel, and was met at its mouth and banked in by the north-easterly extension of the Gulf Stream, forming along the line of contact and partial mixture a "cold wall," comparable with that described as occurring in the Strait of Florida between the cold water of the Labrador Current and the Gulf Stream near its origin. This view however presented many difficulties, and on reconsidering the matter

<sup>1</sup> "Preliminary Report by Dr. W. B. Carpenter, V.P.R.S., of Dredging Operations in the Seas to the North of the British Islands, carried on in H.M. steam-vessel *Lightning*," by Dr. Carpenter and Dr. Wyville Thomson, Professor of Natural History in Queen's College, Belfast (*Proceedings of the Royal Society of London*, vol. xvii.). "Preliminary Report of the Scientific Exploration of the Deep Sea in H.M. Surveying-vessel *Porcupine* during the Summer of 1869, conducted by Dr. Carpenter, V.P.R.S., Mr. J. Gwyn Jeffreys, F.R.S., and Prof. Wyville Thomson, LL.D., F.R.S." (*Proceedings of the Royal Society of London*, vol. xviii.)

it now seemed certain that if our generalisation with regard to the cause of great differences in bottom temperatures within short distances be correct, a submarine ridge rising to within about 200 fathoms of the surface must extend across the mouth of the channel between the coast of Scotland and the Faroe banks. We recognised this as a test case which we might probably be able to examine thoroughly, as it was within our easy reach and on a sufficiently small scale; and I determined to take the first opportunity of making a careful survey of the channel with Capt. Tizard's co-operation, if possible before the *Challenger* temperature results were finally discussed.

I was prevented by various circumstances from taking any active steps in this direction until last year, when the Hydrographer of the Admiralty kindly consented to arrange another opportunity for sounding the Faroe Channel. I was obliged again to postpone the undertaking on account of a severe illness, and it was not until the early part of the present summer that I felt well enough to renew my application. I then wrote the following letter to the Hydrographer:—

“DEAR CAPTAIN EVANS,—As you are aware, during our cruise in H.M.S. *Lightning*, in the year 1868, Dr. Carpenter and I found to our surprise that the channel between the Faroe Island and the coast of Scotland consisted of two very distinct ‘areas,’ the deep water in the two divisions differing in temperature to a marked degree. Consequently upon the difference of temperature, the fauna of the two areas were also different. The ‘warm’ area was separated from the ‘cold’ by a distinct line of demarcation running apparently from about Cape Wrath past the Island of Rona, and as far as the southern Faroe fishing banks. During the voyage of the *Challenger* we met on many occasions with an abrupt change in the deeper temperatures along a definite line, and we arrived at the general conclusion that the phenomenon depended in all cases upon the interruption of the flow of an under-current by a raised submarine ridge. The instance between Scotland and Faroe still, however, remains the most conspicuous as well as the most accessible, and it is very important for us before concluding the Report of the *Challenger* Expedition, to have an opportunity of checking with our greatly increased knowledge our earlier observations.

“I have carefully considered what would be the minimum amount of work required for this purpose, and I now write to ask if you could, with the sanction of their Lordships, authorise Capt. Tizard, now surveying on the west coast, to run north to Stornoway and sound out the line indicated. This would occupy a month, or perhaps a little more.

“As remarkable differences in the distribution of marine animals accompany these differences in temperature, I should greatly regret if we had not a few casts of the trawl on each side of the line, but any additional expense involved for this purpose I will gladly meet. I regret greatly that my present state of health prevents my committing myself to accompany the vessel during the whole time, but I will be at Stornoway during the survey, and my chief assistant, Mr. Murray, is prepared to go. I should think that about the middle of July would be the best time for the trip, if that time would be convenient. Trusting for your assistance to the kind interest you have always taken in our work, believe me very truly yours,

“C. WYVILLE THOMSON”

I give this letter in full to show that our anticipations

were very definite, although they were founded entirely upon the comparison of serial temperature soundings.

Their Lordships agreed to my proposal, and on July 22, 1880, I joined the *Knight Errant* at Oban, and proceeded to Gairloch, and thence to Stornoway, where we arrived at mid-day on Saturday, the 24th. The weather was delightful, and the Minch as smooth as glass; when we reached Stornoway, however, the barometer had begun to fall, and continued sinking steadily with a rising breeze from the north-east. After coaling on Monday forenoon, the vessel left Stornoway Harbour at 1 p.m. with a rather unfavourable weather forecast. I meant to have gone with her on this trip but I was advised to give up the idea, and the civilians who accompanied Capt. Tizard were Mr. Murray, our indefatigable assistant Mr. Frederick Pearcey, with my son as a supernumerary. Taking the island of North Rona as a point of departure, during Tuesday the 27th, and Wednesday the 28th, the *Knight Errant* ran a sectional line of soundings, the distance between the soundings averaging ten miles, between the shallow water on the Scottish coast and the bank to the south-west of the Faroe Islands. Fourteen soundings on this line gave the following depths and bottom temperatures:—

Depth, fathoms.	Temp.	Depth, fathoms.	Temp.
1 ... 88 ...	49.5	8 ... 405 ...	46.0
2 ... 178 ...	49.6	9 ... 355 ...	43.8
3 ... 400 ...	45.8	10 ... 270 ...	43.5
4 ... 560 ...	45.2	11 ... 335 ...	41.0
5 ... 540 ...	46.0	12 ... 245 ...	41.8
6 ... 300 ...	47.5	13 ... 120 ...	47.5
7 ... 305 ...	46.5	14 ... 130 ...	46.0

The line was therefore entirely in the warm area, and no perceptible amount of water from the cold area could be shown to pass in this direction towards the Atlantic.

Capt. Tizard then proceeded a little way to the north-eastward, and commenced running a second line, parallel to the first and about eight miles from it, back towards the Scottish coast. Soundings were continued on the second line at the same average distances as before on Wednesday and Thursday morning, when, the barometer falling rapidly and the sea running high with a gale from the north-east, it was thought prudent to bear up for Stornoway, which they reached on Friday after a somewhat anxious twenty-four hours.

On Tuesday, August 3, the weather looking somewhat better, the *Knight Errant* left Stornoway and carried a sectional line north-north-west from Rona towards the last sounding; they completed the second line of soundings on the evening of Wednesday, the 4th inst. On this line twelve soundings gave depths and bottom temperatures according to the following table:—

Depth, fathoms.	Temp.	Depth, fathoms.	Temp.
1 ... 370 ...	35.5	7 ... 285 ...	45.8
2 ... 375 ...	31.0	8 ... 255 ...	48.0
3 ... 375 ...	31.0	9 ... 460 ...	46.0
4 ... 285 ...	32.5	10 ... 202 ...	48.2
5 ... 210 ...	47.0	11 ... 145 ...	49.5
6 ... 260 ...	47.5	12 ... 93 ...	50.0

All these soundings therefore, with the exception of Nos. 1, 2, and 3, which were across the ridge in the cold area, and No. 9, which was in the deep water of the warm area, gave a depth of under 300 fathoms, and were consequently on the ridge.

On August 10 the *Knight Errant* went out again and got several fairly successful hauls of the trawl and a serial temperature-sounding in the warm area, returning on Thursday the 12th, and she left Stornoway for the fourth time on Monday, August 16, when the party landed on Rona and gave it a cursory examination. They then steamed towards the deep water of the cold area, and on Tuesday the 17th they trawled successfully, and took a serial temperature-sounding in 540 fathoms. They returned to Stornoway for the last time on the evening of Thursday, and left on the following day for Greenock, where they arrived on Monday, the 23rd.

The observations made by Capt. Tizard in the *Knight Errant* have fully corroborated the results of the *Lightning* and *Porcupine* as to the facts of the abnormal distribution of temperature in the Faroe Channel. They have also established the existence of a submarine ridge rising to within 300 fathoms of the surface, in the position in which such a ridge is required to satisfy the conditions of the doctrine of the interference of continuous barriers with the distribution of deep-sea temperatures. Thus far they may be regarded as entirely successful.

The highest line of the ridge has probably not been found, and the details of temperature have yet to be traced out more accurately along the line and for a short distance on either side. I consider that it would be of the greatest interest to work this case out fully as a striking example, within a few miles of our own shore, of a physical phenomenon of importance from its wide occurrence.

The *Knight Errant* was found quite unsuitable for such work; a small steamer of ordinary strength, with stowage for coals for a fortnight's steaming, and with sails to enable her to lie to in a breeze, could do all that is required within a month or six weeks of the ordinary variable weather of these seas.

Although the solution of this temperature problem was the principal object of this summer's trip, I wished greatly to make some additional observations on the nature of the faunæ on the two sides of the ridge, and I was especially anxious to procure some fresh specimens of sponges as material for the structural part of the memoir in which I am engaged with Prof. Franz Eilhart Schultze on the Hexactinellidæ of the *Challenger* Expedition.

The Admiralty declined to give us any material assistance in this direction, but they allowed me to take the gear on board and to get a cast of the trawl or dredge in the intervals of sounding, or when the sounding work was over. I accordingly provided 1,000 fathoms of 2½ inch dredge-rope and other necessary appliances, and Messrs. Henderson, ship-builders, Glasgow, kindly lent us an excellent steam-winch, which was fitted on deck and was of the greatest service both in sounding and trawling. Owing to the boisterous weather and insufficiency of the vessel, this part of our undertaking was not very successful. I got none of the coveted sponges, but two or three hauls of the trawl were taken in each area, and a number of highly-characteristic abyssal forms were procured, including some deep-sea fishes, several crustaceans, and a number of gigantic pycnogonids, some interesting echinoderms, including *Porocidaris*, *Asthenosoma*, *Phormosoma*, *Pourtalesia*, *Rhisocrinus*, and others; some corals, and many curious rhizopods. As the vessel

has not yet returned, I take these names from Mr. Murray's rough notes.

Enough has been done to give further evidence, if such were needed, that a small district on the northern slope of the coast of Scotland will afford a richer harvest to a properly-organised dredging-excursion than perhaps any other spot on the earth. The whole area is singularly productive, and it is bisected by a narrow line, on the one side of which the warm sea at a depth of 500 to 600 fathoms vies in abundance and variety of abyssal forms with the favoured patches off Inosima and Zebu; while on the other side of the line, within a distance of a few miles, we find an epitome of the fauna of the depths of the Arctic Sea.

C. WYVILLE THOMSON.

### LETTERS TO THE EDITOR

[The Editor does not hold himself responsible for opinions expressed by his correspondents. Neither can he undertake to return, or to correspond with the writers of, rejected manuscripts. No notice is taken of anonymous communications.]

[The Editor urgently requests correspondents to keep their letters as short as possible. The pressure on his space is so great that it is impossible otherwise to ensure the appearance even of communications containing interesting and novel facts.]

#### A Fragment of Primeval Europe

THE paper in NATURE, vol. xxii. p. 400, by Prof. Archibald Geikie, on the glacial phenomena of the north-west coast of Scotland, contains on many points a most true and graphic description of a most peculiar and a most interesting country. But I demur to its accuracy on one of the main features to which he refers. The amount of glaciation on the hills of Laurentian gneiss, as represented in the sketch on p. 401, is inordinately exaggerated. I know that country well, both in its general aspect and in its details, and no part of it presents such a scene of symmetrically rounded hills, like the huts of Caffres in Zululand, as that depicted in the sketch.

It is true that all the lower hills are more or less strongly glaciated. But they are also full of low cliffs, and precipitous rocks upon the sides of the glens, and the whole character of the glaciation is such as to suggest the action of heavy floating ice such as that of the "Paleocretaceous Sea," and which acted only upon surfaces specially exposed.

Ben Stack, which is 2,364 feet high, and is composed of the same rock, is not rounded at all, and on the north-west face is full of great precipices along which no glaciation can be seen.

It is perfectly true that the same glaciation which is common on the exposed surfaces of the gneiss cannot be traced on the Cambrian sandstones which overlie it. But this is probably due to the obliteration of the ice-marks by subsequent atmospheric action, which tells rapidly and powerfully on the sandstones, whilst it is almost inoperative on the intensely hard and tough Laurentian gneiss.

That this is the true explanation of the difference now presented by the two rocks, is evident from the fact that the next rock in the ascending series, namely, the white quartzites, do retain surfaces in abundance which are splendidly glaciated. I know no spot in Scotland where the polished surfaces due to glaciation are seen on a greater scale than on the top of the white quartzites which cap the mountain of Queensaig in Assynt. This is a classical area in geology—a sketch of it forming the frontispiece of Murchison's "Siluria." The road from Inchnadamf to Kylescue and Scourie passes over a plateau formed of this quartzite, and the beds of white rock, highly glaciated, shine for miles through the heather.

The glaciation which left these surfaces must have passed over the sandstones also. But the rock was not of a material calculated to retain the marks.

Nevertheless I am not prepared to deny that possibly the gneiss of Sutherland may have been doubly glaciated—once in the glacial epoch as hitherto known to geology, and also at some former epoch inconceivably remote, when similar conditions had prevailed.

If well glaciated surfaces of the gneiss can be distinctly traced

passing under the Cambrian conglomerates, such evidence would go a great way. I have examined some spots where the Cambrian conglomerate has left cakes sitting on the gneiss, and at these spots I should say decidedly that there was no proof of the glaciation of the subjacent rock.

That there may be such evidence at other points is very possible; and if Mr. Geikie can establish it he will have made a discovery of high interest in geology.

ARGYLL

August 27

#### New Red Star

MR. ORMOND STONE, writing from Mount Lookout, U.S., lately informed me that on August 6 he found a very red star, 6.5 mag. in 19h. 10m.  $\pm$ , and  $-16^{\circ} 7' \pm$ . I observed it last night, when it appeared, according to my estimation, of no more than 7.5-8 magnitude. In colour it ranks among the most remarkable red stars, and as it is also, very probably, a variable, I would recommend it to the close attention of observers. It agrees approximately in R.A. with the well-known variable  $\tau$  Sagittarii, but differs in more than a degree of declination from that star, of which I find the place in my *Red Star Catalogue* to be  $\alpha$ , 19h. 9m. 19s.; and  $\delta$ ,  $-17^{\circ} 10' 7''$  for 1880. In about that position last night I found a small colourless star not more than 10 or 11 magnitude.

JOHN BIRMINGHAM

Millbrook, Tuam, August 29

#### Locusts and Coffee Trees

MR. S. B. O'LEARY of this city has favoured me with extracts from a letter written by a relation of his residing on a plantation near Antigua-Guatemala, and containing information about the locust-plague, by which lately the crops of Indian corn and a great many coffee plantations in that country have been destroyed. The insect is called *Chapulín* (*Cryllus miles*, Drury?), and appeared first in the department of Chiquimula, in the eastern part of Guatemala, close to Honduras. Thence it spread over all the warmer parts of the Republic, avoiding the higher and cooler regions. The loss must be very considerable; one gentleman, Don Gregorio Revuelto, in the department of Suchitepeque, lost in one night 70,000 trees, without there being left one single leaf. In April a swarm, supposed to be four leagues broad and about 300 metres long, approached the estate belonging to the writer of the letter, but fortunately could be partly driven away with noise and smoke.

The facts are interesting, as it has not been observed hitherto that locusts, in such a degree, attack the coffee-tree.

Caracas, August 2

A. ERNST

#### Intellect in Brutes

A VERY interesting instance of animal intelligence has been recently reported in one of our newspapers, and may appear sufficiently remarkable to merit more extended notice. A large and destructive fire lately took place upon the shores of the East River opposite to New York, between which city and Long Island this channel passes. The occasion was the spread of naphtha from a burning oil-ship, which instantly became a trail of fire from which the flames swept into well-filled lumber-yards covered with pine boards, and thence to the loaded barges which lined the docks along the river front, and extended up the banks of a small neighbouring creek.

By the rapid and uncontrolled advance of the conflagration over this wide area the families and occupants of the barges and in the lumber-yards were driven away and forced to seek safety in flight. A Newfoundland dog belonging to the grounds, and at that time roaming amongst the lanes of lumber, found himself imprisoned by a swiftly-contracting arc of flame, with the river on one side as the single avenue of escape. Unlike the beasts in the notable dilemma of Baron Munchausen, these opposed elements refused to leap over the back of their prey, and, extinguishing each other, permit him to escape.

The dog jumped into the water and headed for the opposite (the New York) shore. Although pursued by men in boats and lured by cries and calls from the shores, he steadily kept on his course, and after a long and difficult trip landed on the New York side of the water. From the shore he reached one of the avenues which run lengthwise through New York, and finally found his way to the 34th Street ferry, which lay at a consider-

able distance below the point of his landing. The dog, following the lumber-waggons, had often crossed from one shore to the other by means of this ferry, and now recognised in his present extremity, he easily secured a single passage.

Once returned to the Long Island side, he regained his old quarters, having by this circuitous route baffled the fire and regained his home.

L. P. GRATACAP

Amer. Mus. Nat. Hist., N.Y., August 14

CHATEL, Jersey, must send a more precise address.

#### THUNDERSTORMS<sup>1</sup>

##### III.

THE name *thunderbolt*, which is still in use, even by good writers, seems to have been introduced in consequence of the singular effects produced when lightning strikes a sandhill or sandy soil. It bores a hole often many feet in length, which is found lined throughout with vitrified sand. The old notion was that an intensely hot, solid mass, whose path was the flash of lightning, had buried itself out of sight, melting the sand as it went down. It is quite possible that this notion may have been strengthened by the occasional observation of the fall of aerolites, which are sometimes found, in the holes they have made, still exceedingly hot. And at least many of the cases in which lightning is said to have been seen in a perfectly clear sky are to be explained in the same way. Every one knows Horace's lines—

"Diespiter

Igni corusco nubila dividens

Plerumque, per purum tonans]

Egit equos volucremque currum."

But Virgil's remark is not so commonly known. He is speaking of prodigies of various kinds, and goes on:—

"Non alias coelo ceciderunt plura sereno  
Fulgura; nec diri toties arsere cometae."

It is very singular that he should thus have associated comets and meteorites, which quite recent astronomical discovery has shown to have a common origin.

Another remarkable peculiarity, long ago observed, is the characteristic smell produced when lightning strikes a building or a ship. In old times it was supposed to be sulphurous; nowadays we know it to be mainly due to ozone. In fact, all the ready modes of forming ozone which are as yet at the disposal of the chemist depend upon applications of electricity. But besides ozone, which is formed from the oxygen of the air, there are often produced nitric acid, ammonia, and other compounds derived from the constituents of air and of aqueous vapour. All these results can be produced on a small scale in the laboratory.

Hitherto I have been speaking of lightning discharges similar in kind to the ordinary electric spark, which is commonly called *forked* or *zig-zag* lightning. Our nomenclature is very defective in this matter, and the same may be said of the chief modern European languages. For, as Arago remarks, by far the most common form of lightning flash observed in thunderstorms is what we have to particularise, for want of a better term, as *sheet-lightning*. He asserts that it occurs thousand-fold as often as forked lightning; and that many people have never observed the latter form at all! It is not at all easy to conceive what can be the nature of sheet-lightning, if it be not merely the lighting up of the clouds by a flash of forked lightning not directly visible to the spectator. That this is, at least in many cases, its origin is evident from the fact that its place of maximum brightness often takes the form of the *edge* of a cloud, and that the *same* cloud-edge is occasionally lit up several times in quick succes-

<sup>1</sup> Abstract of a lecture, delivered in the City Hall, Glasgow, by Prof. Tait. Continued from p. 366.

sion. You will remember that we are at present dealing with the appearances observed in a thunderstorm, so that I do not refer to that form of sheet-lightning which commonly goes by the name of *summer-lightning*, and which is not, audibly at least, followed by thunder.

The next remarkable feature of the storm is the thunder, corresponding, of course, on the large scale, to the snap of an electric spark. Here we are on comparatively sure ground, for sound is very much more thoroughly understood than is electricity. We speak habitually and without exaggeration of the *crash* of thunder, the *rolling* of thunder, and of a *peal* of thunder; and various other terms will suggest themselves to you as being aptly employed in different cases. All of these are easily explained by known properties of sound. The origin of the sound is in all cases to be looked for in the instantaneous and violent dilatation of the air along the track of the lightning flash, partly, no doubt, due to the disruptive effects of electricity of which I have already spoken, but mainly due to the excessive rise of temperature which renders the air for a moment so brilliantly incandescent. There is thus an extremely sudden compression of the air all round the track of the spark, and a less sudden, but still rapid, rush of the air into the partial vacuum which it produces. Thus the sound-wave produced must at first be of the nature of a bore or breaker. But as such a state of motion is unstable, after proceeding a moderate distance the sound becomes analogous to other loud but less violent sounds, such as those of the discharge of guns. Were there few clouds, were the air of nearly uniform density, and the flash a short one, this would completely describe the phenomenon, and we should have a thunder *crash* or thunder *clap* according to the greater or less proximity of the seat of discharge. But, as has long been well known, not merely clouds but surfaces of separation of masses of air of different density, such as constantly occur in thunderstorms, *reflect* vibrations in the air; and thus we may have many successive echoes, prolonging the original sound. But there is another cause, often more efficient than these. When the flash is a long one, all its parts being nearly equidistant from the observer, he hears the sound from all these parts simultaneously; but if its parts be at very different distances from him, he hears *successively* the sounds from portions farther and farther distant from him. If the flash be much zig-zagged, long portions of its course may run at one and the same distance from him, and the sounds from these arrive simultaneously at his ear. Thus we have no difficulty in accounting for the *rolling* and *pealing* of thunder. It is, in fact, a mere consequence, sometimes of the reflection of sound, sometimes of the finite velocity with which it is propagated. The usual rough estimate of five seconds to a mile is near enough to the truth for all ordinary calculations of the distance of a flash from the observer.

The extreme distance at which thunder is heard is not great, when we consider the frequent great intensity of the sound. No trustworthy observation gives in general more than about nine or ten miles, though there are cases in which it is possible that it may have been heard fourteen miles off. But the discharge of a single cannon is often heard at fifty miles, and the noise of a siege or naval engagement has certainly been heard at a distance of much more than 100 miles. There are two reasons for this: the first depends upon the extreme suddenness of the production of thunder; the second, and perhaps the more effective, on the excessive variations of density in the atmosphere, which are invariably associated with a thunderstorm. In certain cases thunder has been propagated, for moderate distances from its apparent source, with a velocity far exceeding that of ordinary sounds. This used to be attributed to the extreme suddenness of its production; but it is not easy, if we adopt this hypothesis, to see why it should not occur in all cases. Sir W. Thomson has supplied a very different explanation,

which requires no unusual velocity of sound, because it asserts the production of the sound *simultaneously* at all parts of the air between the ground and the cloud from which the lightning is discharged.

We now come to an exceedingly strange and somewhat rare phenomenon, to which the name of *fire-ball* or *globe-lightning* has been given. As we are as yet unable to produce anything of this kind by means of our electrical machines, some philosophers have tried to cut the Gordian knot of the difficulty by denying that any such thing can exist. But, as Arago says, "*Où en serions nous, si nous nous mettions à nier tout ce qu'on ne sait pas expliquer?*" The amount of trustworthy and independent evidence which we possess as to the occurrence of this phenomenon is such as must convince every reasonable man who chooses to pay due attention to the subject. No doubt there is a great deal of exaggeration, as well as much imperfect and even croneous observation, in almost all of these records. But the existence of the main feature (the *fire-ball*) seems to be proved beyond all doubt.

The most marked peculiarities of this species of lightning-discharge are its comparatively long duration and its comparatively slow motion. While a spark, or lightning-flash, does not last longer than about a millionth part of a second, if so long, globe-lightning lasts from one to ten seconds, sometimes even longer, so that a sufficiently self-possessed spectator has time carefully to watch its behaviour. The general appearance is that of a luminous ball, which must be approximately spherical, because it always appears circular in outline, slowly and steadily descending from a thundercloud to the ground. It bursts with a loud explosion, sometimes before reaching the ground, sometimes as it impinges, and sometimes after actually rebounding. Its size varies from that of a child's head to a sphere of little less than a yard in diameter. On some occasions veritable flashes of lightning were seen to proceed from large fire-balls as they burst. It is difficult to imagine what these balls can be if they be not a species of natural Leyden jar very highly charged. If it be so, no ordinary lightning-rod can possibly prevent danger from it; and we may thus be able to explain the very few cases in which damage has been done by lightning to thoroughly protected buildings. To guard against this form nothing short of a pretty close net-work of stout copper wires would suffice. Meanwhile I give a brief sketch of *two* out of the long series of descriptions of such phenomena which Arago has patiently collected. The first is given on the authority of Babinet, who was deputed by the Academy of Sciences to make inquiries into the case.

Shortly, but not immediately, after a loud peal of thunder, a tailor who was sitting at his dinner saw the paper ornament which covered his fire-place blown down as if by a gentle breeze, and a globe of fire, about the size of a child's head, came gently out and moved slowly about at a slight elevation above the floor. It appeared bright rather than hot, and he felt no sensation of warmth. It approached him like a little kitten which desired to rub itself in play against his legs; but he drew his feet away, and by slow and cautious movements avoided contact with it. It remained several seconds near his feet, while he leaned forward and carefully examined it. At last it rose vertically to about the level of his head, so he threw himself back in his chair and continued to watch it. It then became slightly elongated, and moved obliquely towards a hole pierced to the chimney about a yard above the mantelpiece. This hole had been made for the chimney of a stove which was used in winter. "But," as the tailor said, "the globe could not see the hole, for paper had been pasted over it." The globe went straight for the hole, tore off the paper, and went up the chimney. After the lapse of time which, at the rate at which he had seen it moving, it would have required to get to the

top of the chimney, a terrific explosion was heard, and a great deal of damage was done to the chimney and the roofs around it.

The next is even more striking: In June, 1849, in the evening of one of the days when cholera was raging most fearfully in Paris, the heat was suffocating, the sky appeared calm, but summer lightning was visible on all sides. Madame Espert saw from her window something like a large red globe, exactly resembling the moon when it is seen through mist. It was descending slowly towards a tree. She at first thought it was a balloon, but its colour undeceived her; and while she was trying to make out what it was she saw the lower part of it take fire ("*Je vis le feu prendre au bas de ce globe*"), while it was still some yards above the tree. The flames were like those of paper burning slowly, with sparks and jets of fire. When the opening became twice or thrice the size of one's hand, a sudden and terrific explosion took place. The infernal machine was torn to pieces, and a dozen flashes of zig-zag lightning escaped from it in all directions. The *débris* of the globe burned with a brilliant white light and revolved like a catherine-wheel. The whole affair lasted for at least a minute. A hole was bored in the wall of a house, three men were knocked down in the street, and a governess was wounded in a neighbouring school, besides a good deal of other damage.

I have never seen one myself, but I have received accounts of more than one of them from competent and thoroughly credible eye-witnesses. In particular on a stormy afternoon in November, 1868, when the sky was densely clouded over, and the air in a highly electrical state, there was heard in Edinburgh one solitary short, but very loud, clap of thunder. There can be no doubt whatever that this was due to the explosion of a fire-ball, which was seen by many spectators, in different parts of the town, to descend towards the Calton Hill, and to burst whilst still about a hundred feet or so above the ground. The various accounts tallied in most particulars, and especially in the very close agreement of the positions assigned to the ball by spectators viewing it from different sides, and in the intervals which were observed to elapse between the explosion and the arrival of the sound.

The remaining phenomena of a thunderstorm are chiefly the copious fall of rain and of hail, and the almost invariable lowering of the barometer. These are closely connected with one another, as we shall presently see.

(To be continued.)

#### THE BRITISH ASSOCIATION

WE had but just time before going to press last week to indicate the general arrangements made for the reception at Swansea of the British Association. We have now to chronicle the events of the meeting which, although small, has not been destitute of many points of interest. The actual number of members and associates in attendance has been smaller than is shown by the returns for many previous years. This is probably accounted for by the geographical isolation of Swansea and the smallness of its population; but there are doubtless other collateral causes—such, for example, as the coincidence of the meeting of the Iron and Steel Institute at Düsseldorf—which have contributed to discourage a large attendance.

At the General Committee meeting on August 25 the Report of the Council for the year 1879-80 was presented.

The Council having been requested by the General Committee at Sheffield to take such further action as regards the correspondence with the Treasury about the Natural History Collections as they should think desirable in the interests of science, prepared and sent to the Secretary of the Treasury, in reply to his letter of July 22, 1879, the following letter:—

"British Association for the Advancement of Science,  
"22, Albemarle Street, London, W., June 8, 1880

"SIR,—The letter of the Council of this Association, of March 25, 1879, respecting the administration of the Natural History Collections, and your reply thereto of July 22, have been laid before the British Association, at the meeting held at Sheffield in August last, when the subject was again referred to the Council.

"On the part of the Council I am now requested to inform you that they learn with satisfaction that the action of Her Majesty's Government, in passing the British Museum Act of 1878, does not prejudice the question of the future administration of the Natural History Collections at South Kensington, but that the subject is still under the consideration of the Lords Commissioners of Her Majesty's Treasury.

"Under these circumstances the Council of the Association must again express their hope that, when the period arrives, as it must shortly do, for the settlement of the question, the recommendations of the Royal Commission on Science will have their full weight and importance accorded to them.

"If, however, the Lords Commissioners of Her Majesty's Treasury are prepared, as they would seem to indicate, to constitute a Special Standing Committee, or Sub-Committee, of the Trustees of the British Museum, for the management of the Natural History Collections, the Council of the Association are of opinion that such a form of government, though not the form suggested by the Royal Commission on Science, might possibly be so organised as to be satisfactory both to the public and to men of science.

"Trusting that the Lords Commissioners will do the Council the favour of considering these observations on a subject which keenly interests many members of the British Association,

"I have the honour to be, sir,

"Your obedient servant,

"G. J. ALLMAN,

"President of the British Association  
for the Advancement of Science.

"SIR R. R. W. LINGEN, K.C.B., &c., &c."

The receipt of this letter has been acknowledged.

The Council have elected Prof. Cornu, of Paris, and Prof. Boltzmann, of Vienna, Corresponding Members since the Sheffield meeting.

The president's address was very well received; and suffered nothing from the extempore style adopted by Prof. Ramsay, who held his audience to the end. The presidential addresses of the sections were of an unusually high order, and happily no hitch occurred this year to necessitate the delay of any of them beyond the day and hour fixed for their delivery. We reprinted some of them last week, and others will be found in our columns to-day. Of papers in the different sections there has not been, perhaps, as plentiful a supply as in other years, Section G exhibiting a decided lack. There has been certainly a less amount of illustration by diagrams and experiments in the Section meetings than is usual, though several papers in Section A were accompanied by the exhibition of new forms of apparatus. The Neanderthal skull exhibited by Prof. Schaffhausen of Bonn in Section D drew an inquisitive crowd of admirers. The excursions to the local centres of industry—the Dowlais Works, the Landore Steel Works, and the various copper and tin works thrown open by the courtesy of their proprietors—were deservedly popular. Some of these specially invited the notice of Section G, which on the very first day of meeting adjourned for a visit to Dowlais. The promoters of the new East Dock have not omitted to seek for possible shareholders in the members of the Association.

The Saturday excursions to Milford, Gower, St.



David's, &c., were attended by a fair number of visitors, but the exertions of the Excursion Committees had made more than ample accommodation for the limited number of excursionists. The excursions announced for to-day were numerous, and of an interesting character; but several of them have been withdrawn, in consequence of the smallness of the number of applications.

The first of the two evening *sourees* was a reception by the Mayor of Swansea, and was enlivened by some excellent music by a local chorus and orchestra. There were a number of exhibits of machinery in motion, and of products of local industries.

The second of the *sourees* was held on the evening of Tuesday, the 31st, and was more particularly devoted to scientific apparatus. The temporary pavilion in Burrows Square, in which these entertainments were given, was illuminated by the light of the Jamin candle lately described in NATURE, giving an agreeable and brilliant light, though somewhat unsteady, under the disadvantageous conditions under which it had to be set up and worked.

The evening lectures cannot be said to have been largely patronised, although perhaps the geographical difficulties of the town may have accounted to some extent for this state of things. Prof. Boyd Dawkins's discourse on "Primæval Man," excellently delivered and admirably illustrated, was very attentively listened to and enthusiastically applauded. Mr. F. Galton's lecture on "Mental Imagery" was illustrated by diagrams of some of the singular generic photographs with which he has identified his name; great amusement being evoked by the exhibition of the face of a "generalised" Welsh Dissenting minister, compounded from photographs of sundry Nonconformist divines of Swansea. Mr. F. Seebohm lectured on the North-east Passage to a small but very attentive audience of working men on Saturday evening, dwelling more particularly on the heroic exploits of Nordenskjöld and of Capt. Willing.

At the meeting of the General Committee on Monday arrangements were made for the holding next year at Ark of the jubilee gathering of the Association. The proceedings were unusually interesting and enthusiastic.

Sir John Lubbock was chosen as President, the Vice-Presidents being His Grace the Archbishop of York, and those Past-Presidents of the Association who were living when it was founded in 1831. As Presidents of the Sections the following have been chosen, all of whom are Past-Presidents of the Association:—Mathematics and Physics, Sir William Thomson; Chemistry, Prof. Williamson; Geology, Prof. Ramsay; Biology, Prof. Owen; Geography, Sir J. Hooker; Mechanics, Sir Wm. Armstrong.

After a stout competition between Southampton, Nottingham, and Southport, the first-mentioned of these places was selected for the meeting of 1882.

At the final meeting of the Association on Wednesday, the following grants were made:—

<i>A—Mathematics and Physics</i>		£
Prof. G. C. Foster—Electrical Standards .. .. .	100	
Mr. G. H. Darwin—Lunar Disturbance of Gravity ... ..	30	
Prof. Everett—Underground Temperatures ... ..	20	
Dr. Joule—Mechanical Equivalent of Heat ... ..	40	
Dr. O. J. Lodge—High Insulation Key ... ..	5	
Sir Wm. Thomson—Seismic Experiments ... ..	30	
Sir Wm. Thomson.—Tidal Observation ... ..	10	
Mr. J. M. Thomson.—Inductive Capacity of Crystals and Paraffin ... ..	10	
<i>B—Chemical Science</i>		
Dr. Gladstone.—Specific Refractions... ..	10	
Lord Rayleigh.—Spectrum Analysis ... ..	10	
<i>C—Geology.</i>		
Prof. Duncan—Fossil Polyzoa ... ..	10	
Mr. I. Evans—Geological Record ... ..	100	

Prof. E. Hull—Underground Waters ... ..	£10
Prof. A. C. Ramsay—Earthquake in Japan ... ..	25
Dr. Sorby—Metamorphic Rocks ... ..	10

*D—Biology*

Dr. M. Foster—Scottish Zoological Station ... ..	50
Dr. M. Foster—Naples Zoological Station ... ..	75
Mr. Godwin Austen—Natural History of Socotra ... ..	50
Prof. Gwyn Jeffreys—Exploration of Sea Bed North of Hebrides ... ..	50
General Pitt Rivers—Anthropological Notes ... ..	20
Dr. Pye Smith.—Elimination of Nitrogen during Bodily Exercise ... ..	50
Mr. P. L. Sclater.—Natural History of Timor Laut ... ..	50
Mr. Stainton.—Zoological Record ... ..	100

*F—Statistics and Economic Science*

Mr. F. Galton.—Estimation of Weights and Heights of Human Beings ... ..	30
---	----

*G—Mechanical Science*

Mr. Bramwell.—Patent Laws ... ..	5
Mr. J. Glaisher.—Wind Pressure... ..	5
Prof. O. Reynolds.—Steering Steamships ... ..	5

SECTION A

MATHEMATICS AND PHYSICS

OPENING ADDRESS BY PROF. W. GRYLLS ADAMS, M.A., F.R.S., PRESIDENT OF THE SECTION

It has been said by a former President of this Section of the British Association that the president of a Section ought to occupy your time, not by speaking of himself or his own feelings, but by a review "more or less extensive of those branches of science which form the proper business of his section." He may give a rapid sketch of the progress of mathematical science during the year, or he may select some one special subject, or he may take a middle course, neither so extensive as the first nor so limited as the second.

There are many branches of science which have always been regarded as properly belonging to our section, and the range is already wide; but it is becoming more and more true every day that the sciences which are dealt with in other sections of the Association are becoming branches of Physics, *i.e.*, are yielding results of vast importance when the methods and established principles of Physics are applied to them. I wish to direct your attention to investigations which are being made in that fertile region for discovery, the "border land" between Chemistry and Physics, where we have to deal with the constitution of bodies, and where we are tempted to speculate on the existence of matter and on the nature of the forces by which the different parts of it are bound together, or become so transformed that all resemblance to their former state is lost. It is not long since the theory of exchanges became thoroughly recognised in the domain of Radiant Heat, and yet it is already recognised and accepted in the theory of Chemical Combination. Just as the molecules of a body which remains at a constant temperature, are continuously giving up their heat motion to surrounding molecules, and getting back from them as much motion of the same kind in return, so in a chemical compound which does not appear to be undergoing change, the combining molecules are, continuously giving up their chemical or combining motions to surrounding molecules, and receiving again from them as much combining motion in return. We may say that each molecule is, as far as we can see, constantly dancing in perfect time with a partner, and yet is continuously changing partners. When such an idea of chemical motion is accepted, we can the more easily understand that chemical combination means the alteration of chemical motion which arises from the introduction of a new element into the space already occupied, and the consequent change in the motion of the new compound as revealed to us in the spectroscope. We can also the more readily understand that in changing from the old to the new form or rate of motion there may be a development of energy in the shape of heat-motion, which may escape or become dissipated wherever a means of escape presents itself. We know from the experiments of M. Favre that as much heat is absorbed during the decomposition

of an electrolyte as is given out again by the combination of the substances composing it.

We are making rapid strides towards the exact determination of those relations between the various modes of motion or forms of energy which were so ably shadowed forth, and their existence established long ago, by Sir William Grove in his "Correlation of the Physical Forces," where, in stating the conclusion of his comparison of the mutual interchange of physical forces, he distinctly lays down the principles of energy in this statement: "Each force is definitely and equivalently convertible into any other; and where experiment does not give the full equivalent, it is because the initial force has been dissipated, not lost, by conversion into other unrecognised forces. The equivalent is the limit never practically reached."

The laws of Faraday, that (1) when a compound is electrolysed the mass of the substance decomposed is proportional to the quantity of electricity which has produced the change, and that (2) the same current decomposes equivalent quantities of different substances, *i.e.*, quantities of their elements in the ratio of their combining numbers, have given rise to several determinations of the relation between chemical affinity and electromotive force. In a paper lately communicated to the Physical Society, Dr. Wright has discussed these several determinations, and has given an account of a new determination by himself. The data at present extant show that when one gramme of hydrogen unites with 7.98 grammes of oxygen, there are about 34,100 units of heat given out, making the latent heat of dissociation of one gramme of water equal to 3,797 units. The results obtained are compared with the heat given out by the combustion of hydrogen and oxygen, and the value of the mechanical equivalent of heat is deduced from these determinations.

The value obtained by Dr. Wright, which depends on the value of Clark's standard cell, and therefore depends upon the value of the ohm, agrees fairly well with Joule's determination from the heat produced by an electric current in a wire, but is greater than Joule's value as obtained from his water-friction experiments. This may be accounted for by supposing an error in the value of the ohm or B.A. unit, making it too large by 1.5 or 2 per cent. Kohlrausch has also made comparisons of copies of the B.A. unit with standard coils, and comes to the conclusion that the B.A. unit is 1.96 per cent. too large. On the other hand, Prof. Rowland, in America, has made a new determination, and finds that according to his calculations the B.A. unit is nearly 1 per cent. too small. These differences in the values obtained by different methods clearly point to the necessity for one or more new determinations of the unit, and I would venture to suggest that a determination should be made under the authority of this Association, by a committee appointed to carry out the work. And it is not sufficient that this determination should be made once for all, for there is reason to think that the resistance of standard coils alters with time, even when the material has been carefully selected. It has been found that coils of platinum silver which were correct copies of the standard ohm have become so altered, and have their temperature coefficients so changed, that there are doubts as to the constancy of the standards themselves. Pieces of platinum-silver alloy cut from the same rod have been found to have different temperature coefficients. The value .031 for 1° C. is given by Matthiessen for this alloy, yet two pieces of wire drawn from the same rod have given, one .021 per cent. and the other .04 per cent. for 1° C. Possibly this irregularity in the platinum-silver alloys may be due to something analogous to the segregation which Mr. Roberts has found to take place in copper-silver alloys in their molten state, and which Matthiessen in 1860 regarded as mechanical mixtures of allotropic modifications of the alloy.

A recommendation has been made that apparatus for determining the ohm should be set up in London, and that periodically determinations be made to test the electrical constancy of the metals and alloys used in making coils. A committee should be authorised to test coils and issue certificates of their accuracy, just as is done by the Kew Committee with regard to meteorological instruments. The direct relation between Heat and Chemical work has been established, and the principles of Conservation of Energy been shown to be true in Chemistry by the experiments of Berthelot and of Thomsen, so that we may say that when a system of bodies passes through any succession of chemical changes, the heat evolved or absorbed when no external mechanical effect is produced depends solely upon the initial and final states of the system of bodies, whatever be the nature or the

order of the transformations. The extension of this principle to the interaction of the molecules and atoms of bodies on one another is of vast importance in relation to our knowledge of the constitution of matter, for it enables us to state that each chemical compound has a distinct level or potential which may be called its own, and that when a compound gives up one of its elements to another body, the heat evolved in the reaction is the difference between the heat of formation of the first compound and that of the resulting product.

We have become accustomed to regard matter as made up of molecules, and those molecules to be made up of atoms separated from one another by distances which are great in comparison with the size of the atom, which we may regard as the smallest piece of matter that we can have any conception of. Each atom may be supposed to be surrounded by an envelope of ether which accompanies it in all its movements. The density of the ether increases rapidly as an atom is approached, and it would seem that there must be some force of attraction between the atom and its ether envelope. All the atoms have motions of translations in all possible directions, and according to the theories of Maxwell and Boltzmann, and the experiments of Kundt, Warburg, and others on the specific heat of vapours, in *one atom* molecules in the gaseous state there is no motion of rotation. According to the theory of Pictet, the liquid state, being the first condensation from the gaseous state, must consist of at least two gaseous atoms combined. These two atoms are bound to one another through their ether envelopes. Then the solid state results from the condensation of a liquid, and so a solid molecule must consist of at least two liquid molecules, *i.e.*, at least four gaseous molecules, each surrounded by an atmosphere of ether. M. Pictet imagines these atoms to be centres of attraction; hence in the solid with four such centres the least displacement brings into action couples tending to prevent the molecule from twisting as soon as external forces act upon it. All the molecules constituting a solid will be rigidly set with regard to one another, for the least displacement sets in action a couple of an opposing force in the molecules on one another.

Let us now follow the sketch which M. Pictet has given of changes which we may consider it to undergo when we expend energy upon it. Suppose a solid body is at absolute zero of temperature, which may be regarded as the state in which the molecules of a body are in stable equilibrium and at rest, the application of heat gives a vibratory motion to the molecules of the solid, which increases with the temperature, the mean amplitude of vibration being a measure of the temperature. We may regard the sum of all the molecular forces as the specific heat of the body, and the product of the sum of all the molecular forces by the mean amplitude of the oscillations; *i.e.*, the product of the specific heat and the temperature will be the quantity of heat or the energy of motion of the body. As more and more heat is applied, the amplitude of vibration of the molecules increases until it is too great for the molecular forces, or forces of cohesion, and the melting point of the solid is reached. Besides their vibratory motion, the molecules are now capable of motions of translation from place to place among one another. To reduce the solid to the liquid state, *i.e.*, to make the amplitude of vibration of the molecules sufficient to prevent them from coming within the sphere of the forces of cohesion, requires a quantity of heat which does not appear as temperature or molecular motion, and hence it is termed the latent heat of fusion. The temperature remains constant until the melting is complete, the heat being spent in bursting the bonds of the solid. Then a further application of heat increases the amplitude of vibration, or raises the temperature of the liquid at a rate depending on its specific heat until the succession of blows of the molecules overcomes the external pressure and the boiling-point is reached. An additional quantity of heat is applied which is spent in changing the body to a gas, *i.e.*, to a state of higher potential, in which the motion of translation of the molecules is enormously increased. When this state is attained, the temperature of the gas again begins to increase, as heat is applied, until we arrive at a certain point, when dissociation begins, and the molecules of the separate substances of which the body is composed have so large an amplitude of vibration that the bond which unites them can no longer bring them again into their former positions. The potential of the substances is again raised by a quantity which is proportional to its chemical affinity. Again, we may increase the amplitude of vibration, *i.e.*, the temperature of the molecule, and imagine the possibility of higher and higher degrees of dissociation.

If temperature means the amplitude of vibration of the molecules, then we might expect that only those bodies which have their temperatures increased by the same amount when equal amounts of heat are applied to them can possibly combine with one another; and so the fact that the increase of temperature bears a fixed ratio to the increase of heat may be the cause in virtue of which bodies can combine with one another. Were other bodies to begin to combine together at any definite temperature, they would immediately be torn to pieces again when the temperature is even slightly raised, because the amplitudes of vibration of their molecules no longer remain the same. This idea of temperature is supported by the fact that a combining molecule of each substance requires the same amount of heat to raise its temperature by the same number of degrees, the atomic weights being proportional to the masses of the combining molecules. The celebrated discovery of Faraday, that in a voltameter the work done by an electric current always decomposes equivalent quantities of different substances, combined with the fact that in the whole range of the physical forces work done is equivalent to the application of heat, is quite in accordance with the view that no molecule can combine with another which has not its amplitude of vibration altered by the same amount when equal quantities of heat are applied to both. As soon as we get any divergence from this state of equal motions for equal increments of heat, then we should expect that a further dissociation of molecules would take place, and that only those which are capable of moving together can remain still associated.

Just as in the change of state of a body from the solid to the liquid, or from the liquid to the gas, a great amount of heat is spent in increasing the motion of translation of the molecules without altering the temperature, so a great amount of heat is spent in producing dissociation without increasing the temperature of the dissociated substances, since the principle of conservation of energy has been shown by M. Berthelot to hold for the dissociation of bodies. We may conveniently make use of the term latent heat of dissociation for, the heat required to dissociate a unit of mass of a substance.

We may thus sum up the laws of physical and chemical changes:—

1. All the physical phenomena of change of state consist in the subdivision of the body into molecules or particles identical with one another.
2. The reconstitution of a body into a liquid or a solid being independent of the relative position of the molecules, only depends on the pressure and temperature.
3. Dissociation separates bodies into their elements, which are of different kinds, and the temperature remains constant during dissociation.
4. The reunion of dissociated bodies depends on the relative position of the elements, and so depends on the grouping of the molecules. The atomic weight being the mass of a molecule as compared with hydrogen, the specific volume, *i.e.*, the atomic weight divided by the density, is the volume or *mean free path* of a molecule.

Building up his theory of heat on these principles, M. Pictet arrives at a definite relation between the atomic weight of a body, its density, its melting-point, and its coefficient of expansion, which may be stated thus—

The volume of a solid body will be increased as the temperature rises by an amount which is proportional to the number of molecules in it, and inversely as its specific heat. At a certain temperature peculiar to each body, the amplitude of the heat oscillation is sufficient to melt the solid, and we are led to admit that for all bodies the intermolecular distance corresponding to fusion ought to be the same. The higher the point of fusion of a body, the shorter, on this theory, must be its heat vibrations. The product of the length of swing (the heat oscillations) by the temperature of fusion ought to be a constant number for all solid bodies.

A comparison of the values of the various quantities involved in these statements shows a very satisfactory agreement between theory and experiment, from which it appears that for many different substances the product of the length of swing by the temperature of fusion lies between 3·3 and 3·7 for most substances. Not many values of the latent heat of dissociation have been made. In order to determine it, say, for the separation of oxygen and hydrogen, we should have to determine the amount of work required to produce a spark in a mixture of oxygen and hydrogen, and to measure the exact amount of

water or vapour of water combined by the spark as well as the range of temperature through which it had passed after its formation. Very few such determinations have been made.

Our usual mode of producing heat is by the combination of the molecules of different substances, and we are limited in the production of high temperatures, and in the quantity of available heat necessary to dissociate any considerable quantity of matter. If we heat vapours or gases, we may raise their temperatures up to a point corresponding to the dissociation of their molecules, and we are limited in our chemical actions to the temperatures which can be obtained by combining together the most refractory substances, as we are dependent on this combination for our supply of heat.

The combination of carbon and hydrogen with oxygen will give us high temperatures; so that by the oxyhydrogen blow-pipe most of the salts and oxides are dissociated. The metalloids bromine, iodine, sulphur, potassium, &c., are the results of the combination of two or more bodies bound together by internal forces much stronger than the affinity of hydrogen or carbon for oxygen, for approximately they obey the law of Dulong and Petit.

For higher temperatures, in order to dissociate the most refractory substances, we require the electric current, either a continuous current, as in the electric arc from a battery or a dynamo-machine, or, more intense still, the electrical discharges from an electrical machine or from an induction coil.

This electric current may be regarded as the most intense furnace for dissociating large quantities of the most refractory substances, and the electric spark may be regarded as something very much hotter than the oxyhydrogen blow-pipe, and therefore of service in reducing very small quantities of substances which will yield to no other treatment. The temperature of the electric arc is limited, and cannot reach above the temperature of dissociation of the conductor, and in the case of the constant current, which will not leap across the smallest space of air unless the carbons have first been brought in contact, the current very soon ceases when the point of fusion has been reached. Yet in the centre of the arc we have the gases of those substances which form the conductor; and, as Prof. Dewar has shown, we have the formation of acetylene and cyanogen and other compounds, and therefore must have attained the temperature necessary for their formation, *i.e.* the temperature of their dissociation. The temperature of the induction spark, or, at least, its dissociating power, is higher than that of the arc. We know that the spark will pass across a space of air or a gaseous conductor, and we are limited by the dissociation of the gaseous conductor, and get only very small quantities of the dissociated substances, which immediately recombine, unless they are separated. If the gases formed are of different densities they will diffuse at different rates through a porous diaphragm, and so may be obtained separated from one another. As the molecules of bodies vibrate they produce vibrations of the ether particles, the period of the oscillations depends on the molecules of the body, and these periodic vibrations are taken up by their ether envelopes and by the luminiferous ether, and their wave-length determined by means of the spectroscope. The bright-line spectrum may be regarded as arising from the vibratory motions of the atoms. As the temperature is increased, the amplitudes of oscillation of the molecules and of the ether increase, and from the calculations of Lecoq de Boisbaudran, Stoney, Soret, and others, it would appear that many of the lines in the spectra of bodies may be regarded as harmonics of a fundamental vibration. Thus Lecoq de Boisbaudran finds that in the nitrogen spectrum the blue lines seen at a high temperature correspond to the double octave of certain vibrations, and that, at a lower temperature, red and yellow lines are seen which correspond to a fifth of the same fundamental vibrations.

The bright-line spectrum may be regarded as arising from the vibratory motions of the atoms. A widening of the lines may be produced at a higher temperature by the backward and forward motions of the molecules in the direction of the observer. A widening of the lines may also be produced by increase of pressure, because it diminishes the free path of the molecules, and the disturbances of the ether arising from collisions become more important than vibrations arising from the regular vibrations of the atoms.

Band spectra, or channelled space spectra, more readily occur in the case of bodies which are not very readily subject to chemical actions, or, according to Professors Living and Dewar, in the case of cooler vapours near the point of liquefaction.

The effects of change of temperature on the character of spectra is very well illustrated by an experiment of M. Wiedemann with mixtures of mercury with hydrogen or nitrogen in a Geissler's tube. At the ordinary temperature of the air the spectrum of hydrogen or nitrogen was obtained alone; but on heating the tube in an air-bath the lines of mercury appeared and became brighter as the temperature rose, and at the same time the hydrogen lines disappeared in the wider portion of the tube and at the electrodes. The hydrogen or nitrogen lines disappeared first from the positive electrode and in the luminous tuft, and as the temperature rose disappeared altogether. With nitrogen in a particular experiment, up to  $100^{\circ}\text{C}$ ., the nitrogen lines were seen throughout the tube, but from  $100^{\circ}$  to  $230^{\circ}$  the nitrogen lines appear towards the negative pole, and the mercury lines are less bright at the negative than at the positive pole, while at about  $230^{\circ}\text{C}$ . no nitrogen lines appear. The experiments of Roscoe and Schuster, of Lockyer and other observers, with potassium, sodium, and other metalloids in vacuum tubes, from which hydrogen is pumped by a Sprengel pump, also show great changes in the molecular condition of the mixture contained in the tubes when they are heated to different temperatures. The changes of colour in the tube are accompanied by changes in the spectrum. Thus, Lockyer finds that when potassium is placed in the bottom of the tube, and the spark passes in the upper part of it, as the exhaustion proceeds and the tube is slightly heated, the hydrogen lines disappear, and the red potassium line makes its appearance; then as the temperature is increased, the red line disappears, and three lines in the yellowish-green make their appearance, accompanied by a change in the colour of the tube, and at a higher temperature, and with a Leyden jar joined to a secondary circuit of the induction coil, the gas in the tube becomes of a dull red colour, and with this change a strong line comes out in the spectrum, more refrangible than the usual red potassium line. In this case, on varying the conditions, we get a variation in the character of the spectrum, and the colours and spectra are different in different parts of the tube. In Lockyer's experiments, at the temperature of the arc obtained from a Siemens' dynamo-machine, great differences appear in different parts of the arc: for instance, with carbon poles in the presence of calcium, the band spectrum of carbon, or the carbon flutings; and the lines of calcium, some of them reversed, are seen separated in the same way as mercury and hydrogen, the carbon spectrum appearing near one pole and the calcium near the other, the lines which are strongest near that pole being reversed or absorbed by the quantity of calcium vapour surrounding it. On introducing a metal into the arc, lines appear which are of different intensities at different distances from the poles, others are strong at one pole and entirely absent at or near the other, while some lines appear as broad as half-spindles in the middle of the arc, but are not present near the poles. Thus, the blue line of calcium is visible alone at one pole, the H and K line without the blue lines at the other.

We may probably regard these effects as the result, not of temperature alone, but must take into account that we have powerful electric currents which will act unequally on the molecules of different bodies according as they are more or less electro-positive. It would seem that we have here something analogous to the segregation which is observed in the melting of certain alloys to which I have already referred.

The abundance of material in some parts of the arc surrounding the central portion of it gives rise to reversal of the principal lines in varying thicknesses over the arc and poles, so that bright lines appear without reversal in some regions, and reversals or absorption lines without bright lines in others. The introduction of a substance into the arc gives rise to a flame of great complexity with regard to colour and concentric envelopes, and the spectra of these flames differ in different parts of the arc. Thus in a photograph of the flame given by manganese, the line at wave-length 4234.5 occurs without the triplet near 4030, while in another the triplet is present without the line 4234.5.

The lines which are reversed most readily in the arc are generally those the absorption of which is most developed in the flame; thus the manganese triplet in the violet is reversed in the flame, and the blue calcium line is often seen widened when the H and K lines of calcium are not seen at all. In consequence of the numerous changes in spectra at different temperatures, Mr. Lockyer has advanced the idea that the molecules of elementary matter are continually being more and more broken up as their temperature is increased, and has put forward the hypothesis that the chemical elements with which we are acquainted

are not simple bodies, but are themselves compounds of some other more simple substances. This theory is founded on Mr. Lockyer's comparisons of spectra and the maps of Ångström, Thalén, Young, and others, in which there are coincidences of many of the short lines of the spectra of different substances. These short lines are termed basic lines, since they appear to be common to two or more substances. They appear at the highest temperatures when the longest lines of those substances and those which are considered the test of their presence are entirely absent.

Mr. Lockyer draws a distinction between weak lines, which are basic, *i.e.* which would permanently exist at a higher temperature in a more elementary stage, and other weak or short lines which would be more strongly present at a lower temperature, in a more complex stage of the molecules. Thus, in lithium, the red line is a low temperature line, and the yellow is feeble; at a higher temperature, the red line is weak, the yellow comes out more strongly, and the blue line appears; at a higher temperature still, the red line disappears, and the yellow dies away; whilst at the temperature of the sun the violet lithium line is the only one which comes out strongly. These effects are studied by first producing the spectrum of the substance in the Bunsen flames, and observing the changes which are produced on passing a spark through the flame; thus, in magnesium, a wide triplet or set of three lines ( $5209.8$ ,  $b^1$  and  $b^2$ ) is changed into a narrow triplet ( $b^1$ ,  $b^2$ , and  $b^3$ ) of the same character. We have here what some observers regard as a recurrence of the same harmonic relation of the vibrations of the same body at a higher temperature.

If the so-called elements are compounds, they must have been formed at a very high temperature, and as higher and higher temperatures are reached the dissociation of these compound bodies will be effected, and the new line spectra, the real basic lines of those substances which show coincidences, will make their appearance as short lines in the spectra. In accordance with this view, Mr. Lockyer holds that the different layers of the solar atmosphere may be regarded as a series of furnaces, on the hottest of which, A, we have the most elementary forms of matter capable of existing only in its uncombined state; at a higher and cooler level, B, this form of matter may form a compound body, and may no longer exist in a free state at the lower temperature; as the cooler and cooler levels, C, D, and E, are reached, the substances become more and more complex and form different combinations, and their spectra become altered at every stage. Since the successive layers are not at rest, but in a state of disturbance, we may get them somewhat mixed, and the lines at the cooler levels D and E may be associated with the lines of the hotter levels; these would be basic or coincident lines in the spectra of two different compounds which exist at the cooler levels D and E. We might even get lines which are not present in the hottest furnace A coming into existence as the lines of compounds in B or C, and then extending among the lines belonging to more complex compounds which can only exist at a lower temperature, when they might be present as coincident weak lines in the spectra of several compound bodies. Thus Mr. Lockyer regards the calcium lines H and K of the solar spectrum as evidence of different molecular groupings of more elementary bodies. In the electric arc with a weak current the single line 4226 of calcium, which is easily reversed, is much thicker than the two lines H and K; but the three lines are equally thick with a stronger current and are all reversed. With a spark from a large coil and using a condenser the line 4226 disappears, and H and K are strong lines. In the sun, the absorption bands H and K are very broad, but the band 4226 is weak. Prof. Young, in his observation of the lines of the chromosphere, finds that H and K are strongly reversed in every important spot and in solar storms; but the line 4226, so prominent in the arc, was only observed three times in the chromosphere.

One of the most interesting features among the most recent researches in spectrum analysis is the existence of rhythm in the spectra of bodies, as has been shown by M.M. Mascart, Cornu, and others, such as the occurrence and repetition of sets of lines, doublets, and triplets in the spectra of different substances and in different parts of the spectrum of the same body. Professors Liveing and Dewar, using the reversed lines in some cases for the more accurate determination of wave-lengths, have traced out the rhythmical character in the spectra of sodium, potassium, and lithium. They show that the lines of sodium and potassium form groups of four lines each, which recur in a regular sequence,

while lithium gives single lines, which, including the green line, which they show really to belong to lithium, though it was ascribed to cesium by Thalén, also recur in a similar way. In these three metals the law of recurrence seems to be the same, but the wave-lengths show that the whole series are not simple harmonics of one fundamental, although between some of the terms very simple harmonic relations can be found. Between the lines G and H are two triplets of iron lines, which, according to Mr. Lockyer, do not belong to the same molecular grouping as most of the other lines. In many photographs of the iron spectrum these triplets have appeared almost alone. Also the two triplets are not always in the same relation as to brightness, the more refrangible being barely visible with the spark; combining this with Young's observations, in which some short weak lines near G appear in the chromosphere 30 times, while one of the lines of the less refrangible triplet only appears once, and with the fact that in the solar spectrum the more refrangible triplet is much the more prominent of the two, Mr. Lockyer is led to the conclusion that these two triplets are again due to two distinct molecular groupings.

There is one difficulty which must be taken account of in connection with Mr. Lockyer's theory with regard to the production of successive stages of dissociation by means at our command: (1) by combustion of different substances; (2) by an electric arc, which will probably give different temperatures according as it is produced by different dynamo-electric machines; (3) by the induction spark without; and (4) with a condenser.

At each stage of the process there must be a considerable absorption of heat to produce the change of state, and our supply of heat is limited in the electric arc because of the dissociation of the conductors, and more limited still in quantity in the electric spark or in the discharge through a vacuum tube. Also we should expect a recombination of the dissociated substances immediately after they have been first dissociated. Hence it seems easier to suppose that at temperatures which we can command on the earth, the dissociation of molecules by the arc or the spark is accompanied by the formation of new compounds, in the formation of which heat and light, and especially chemical vibrations, would be again given out, thus giving rise to new spectra, rather than to suppose that we can reach the temperature necessary for successive stages of dissociation.

To the lines C, F, the line near G, and  $\frac{1}{2}$  belonging to hydrogen, which have a certain rhythmical character, Mr. Lockyer adds  $D_3$  and Kirchhoff's line "1474," regarding "1474" as belonging to the coolest or most complex form, rising to F at a higher temperature, which is again subdivided into C and G, using the spark without a condenser, which again gives  $\frac{1}{2}$  with the spark and condenser, which is again split up and gives  $D_3$ , a more simple line than  $\frac{1}{2}$ , in the Chromosphere. Professors Liveing and Dewar, on the other hand, trace a rhythmical character or ratio between three of the brightest lines of the Chromosphere, two of which are lines "1474" and "f" of Lorenzoni similar to the character of C, F, and  $\frac{1}{2}$  of hydrogen, and also trace a similar relation between the chromospheric line  $D_3$  and "1474" to the ratio of the wave-lengths of F and the line near G. They infer the probability that these four lines are due to the same at present unknown substance, as had been suggested by Young with regard to two of them. The harmony of this arrangement is somewhat disturbed by the fact that  $D_3$  lies on the wrong side of "1474" to correspond with the line near G of the hydrogen spectrum.

If we inquire what our sun and the stars have to say to these changes of spectra of the same substance at different temperatures, Dr. Huggins gives us the answer.

In the stars which give a very white light, such as Sirius or  $\alpha$  Lyrae, we have the lines G and  $\frac{1}{2}$  of hydrogen and also H, which has been shown by Dr. Vogel to be coincident with a line of hydrogen; but the K line of calcium is weak in  $\alpha$  Lyrae, and does not appear in Sirius. In passing from the white or hottest stars to the yellow stars like our sun, the typical lines diminish in breadth and are better defined, and K becomes stronger relatively to H, and other lines appear. In Arcturus we have a star which is probably cooler than our sun, and in it the line K is stronger in relation to H than it is in the solar spectrum, both being very strong compared with their state in the solar spectrum.

Professors Liveing and Dewar find that K is more easily reversed than H in the electric arc, which agrees with the idea that this line is produced at a lower temperature than H:

Besides the absence or weakness of K, the white stars have

twelve strong lines winged at the edges, in which there are three of hydrogen, viz. G,  $\frac{1}{2}$ , and H, and the remaining nine form a group which are so related to one another that Dr. Huggins concludes they probably belong to one substance. Three of these lines are said by Dr. Vogel to be lines of hydrogen. Liveing and Dewar have made considerable progress in determining the conditions and the order of reversal of the spectral lines of metallic vapours. They have adopted methods which allow them to observe through greater thicknesses of vapour than previous observers have generally employed. For lower temperatures tubes of iron or other material placed vertically in a furnace were used, and the hot bottom of the tube was the source of light, the absorption being produced by vapours of metals dropped into the hot tube and filling it to a greater or less height. By this means many of the more volatile metals, such as sodium, thallium, iridium, cesium, and rubidium, magnesium, lithium, barium, strontium, and calcium, each gave a reversal of its most characteristic line or pair of lines, i.e. the red line of lithium, the violet lines of rubidium and calcium, the blue line of strontium, the sharp green line of barium (5535), and no other lines which can certainly be ascribed to those metals in the elementary state.

For higher temperatures tubes bored out in blocks of lime or of gas carbon, and heated by the electric arc, were used. By keeping up a supply of metal and in some cases assisting its volatilisation by the admixture of a more volatile metal, such as magnesium, and its reduction by some easily oxidisable metal, such as aluminium, or by a current of coal gas or hydrogen, they succeeded in maintaining a stream of vapour through the tube so as to reverse a great many lines. In this way the greater part of the bright lines of the metals of the alkalies and alkaline earths were reversed, as well as some of the strongest lines of manganese, aluminium, zinc, cadmium, silver, copper, bismuth, and the two characteristic lines of iridium and of gallium. By passing an iron wire into the arc through a perforated carbon electrode they succeeded in obtaining the reversal of many of the lines of iron. In observing bright-line spectra they have found that the arc produced by a De Meritens machine arranged for high tension gives, in an atmosphere of hydrogen, the lines C and F, although the arc of a powerful Siemens machine does not bring them out, and they have observed many metallic lines in the arc which had not been previously noticed. The temperature obtained by the De Meritens machine is thus higher than that obtained in the Siemens machine.

From observations on weighed quantities of sodium, alone and as an amalgam, introduced into a hot bottle of platinum filled with nitrogen, of which the pressure was varied by an air-pump, they conclude that the width of the sodium lines depends rather on the thickness and temperature of the vapour than upon the whole quantity of sodium present. Very minute quantities diffused into the cool part of the tube gave a broad diffuse absorption, while a thin layer of compressed vapour in the hot part of the tube give only narrow absorption lines. Professors Liveing and Dewar have observed the reversal of some of the well-known bands of the oxides and chlorides of the alkaline earth metals. The lines produced by magnesium in hydrogen form a rhythmical series extending all across the well-known B group, having a close resemblance in general character to the series of lines produced by an electric discharge in a vacuum tube of olefiant gas.

The series appears at all temperatures except when a large condenser is employed along with the induction coil, provided hydrogen is present as well as magnesium, while they disappear when hydrogen is excluded, and never appear in dry nitrogen or carbonic oxide.

From their experiments on carbon spectra they conclude with Angström and Thalén that certain of the so-called "carbon bands" are due to some compound of carbon with hydrogen, probably acetylene, and that certain others are due to a compound of carbon with nitrogen, probably cyanogen.

They describe some ultra-violet bands: one of them coincides with the shaded band P of the solar spectrum which accompanies the other violet bands in the flame of cyanogen as well as in the arc and spark between carbon electrodes in the nitrogen. All the bands which they ascribe to a compound of carbon and nitrogen disappear when the discharge is taken in a non-nitrogenous gas, and they reappear on the introduction of a minute quantity of nitrogen.

They appear in the flame of hydrocyanic acid, as of cyanogen, even when cooled down as much as possible as shown by Watts,

or when raised to the highest temperature by burning the cyanogen in nitric oxide; but no flames appear to give these bands unless the burning substance contains nitrogen already united with carbon. As the views of Mr. Lockyer with regard to the multiple spectre of carbon have very recently appeared in the pages of NATURE, I need only say that these spectra are looked upon as supporting his theory that the different flutings are truly due to carbon, and that they represent the vibrations of different molecular groupings. The matter is one of very great interest as regards the spectra of comets, for the bands ascribed to acetylene occur in the spectra of comets without the bands of nitrogen, showing that either hydrocarbons must exist ready formed in the comets, in which case the temperature need not exceed that of an ordinary flame, or else nitrogen must be absent, as the temperature which would produce acetylene from its elements would also produce cyanogen, if nitrogen were present.

Quite recently, Professors Liveing and Dewar have, simultaneously with Dr. Huggins, described an ultra-violet emission spectrum of water, and have given maps of this spectrum. It is not a little remarkable that by independent methods these observers should have deduced the same numbers for the wave-lengths of the two strong lines at the most refrangible end of this spectrum.

Great attention has been paid by M. Mascart and by M. Cornu to the ultra-violet end of the solar spectrum. M. Mascart was able to fix lines in the solar spectrum as far as the line R (3179), but was stopped by the faintness of the photographic impression. Prof. Cornu has extended the spectrum still farther to the limit (2948), beyond which no further effect is produced, owing to complete absorption by the earth's atmosphere. A quartz-reflecting prism was used instead of a heliostat. The curvature of the quartz lens was calculated so as to give minimum aberration for a large field of view. The Iceland spar prism was very carefully cut. A lens of quartz was employed to focus the sun on the slit. Having photographed as far as possible by direct solar light, Prof. Cornu compared the solar spectrum directly by means of a fluorescent eye-piece with the spectrum of iron, and then obtained, by photography, the exact positions of the iron lines which were coincident with observed lines in the solar spectrum. M. Cornu states that the dark absorption lines in the sun and the bright iron lines of the same refrangibility are of the same relative importance or intensity in their spectra, indicating the equality between the emissive and the absorbing powers of metallic vapours; and he thinks that we may get by the comparison of bright spectra with the sun some rough approximation to the quantity of metallic vapours present in the absorption layers of the sun's atmosphere. He draws attention to the abundance of the magnetic metals—iron, nickel, and magnesium—and to the fact that these substances form the composition of most meteorites. M. Cornu has studied the extent of the ultra-violet end of the spectrum, and finds that it is more extended in winter than in summer, and that, at different elevations, the gain in length of the spectrum for increase of elevation is very slow, on account of atmospheric absorption, so that we cannot hope greatly to extend the spectrum by taking elevated observing stations. The limit of the solar spectrum is reached very rapidly, and the spectrum is sharply and completely cut off at about the line U (wave-length 2948). From photographs taken at Viesch in the valley of the Rhone, and at the Riffelberg, 1910 metres above it, M. Cornu finds the limits to be at wave-lengths 2950 and 2930 respectively.

In the actual absorption of bright-line spectra by the earth's atmosphere, M. Cornu observed among others three bright-lines of aluminium, which M. Soret calls 30, 31, and 32 (wave-lengths about 1988, 1930, and 1860), and he found that 32 could not be seen at the distance of 6 metres; but on using a collimator and reducing the distance to  $1\frac{1}{2}$  metres, the line 32 became visible, notwithstanding the absorption of the extra lens; at 1 metre, line 32 was brighter than 31, and at a quarter of a metre 32 was brighter than either 30 or 31. With a tube 4 metres in length between the collimator and prism ray 32 is not seen; but when the tube is exhausted, ray 31 gains in intensity and 32 comes into view, and gradually gets brighter than 31, whilst 30 changes very little during the exhaustion. With the same tube he found no appreciable difference between the absorption by air very carefully dried and by moist air, and concludes that this absorption is not due to the vapour of water, and it follows the law of pressure of the atmo-

sphere which shows it to be due to the whole mass or thickness of the air. Also, M. Soret has shown that water acts very differently on the two ends of the spectrum, distilled water being perfectly transparent for the most refrangible rays, since a column of water of 116 c.m. allowed the ray 2060 in the spectrum of zinc to pass through; on the other hand, water is so opaque to the ultra-red rays that a length of 1 c.m. of it reduces the heat spectra of metals to half their length and one quarter of their intensity.

In concluding my address, I wish to draw attention to some of those magnetic changes which are due to the action of the Sun, and which are brought about by means of the ether which brings to us his radiant heat and light. In his discussion of the magnetic effects observed on the earth's surface, General Sabine has shown the existence of diurnal variations due to the magnetic action of the sun; also the magnetic disturbances, aurora and earth-currents, which are now again beginning to be large and frequent, have been set down to disturbances in the sun.

Although iron, when raised to incandescence, has its power of attracting a magnet very greatly diminished, we have no proof that it has absolutely no magnetic power left, and with a slight magnetic action the quantity of iron in the sun would be sufficient to account for the diurnal variations of the magnetic needle. During the last few weeks I have been engaged in examining the declination curves for the month of March, 1879, which have been kindly lent to the Kew Committee by the directors of the Observatories of St. Petersburg, Vienna, Lisbon, Coimbra, and Stonyhurst. Other curves are on their way from more distant stations, but have not yet been examined. On comparing them with the Kew curves for the same period, I find the most remarkable coincidences between the curves from these widely-distant stations. It was previously known that there was a similarity between disturbances at different stations, and in one or two cases a comparison between Lisbon and Kew had been made many years ago by Señor Capello and Prof. Balfour Stewart, but the actual photographic magnetic records from several stations have never been previously collected, and so the opportunity for such comparisons had not arisen. Allow me to draw attention to a few of the more prominent features of these comparisons which I have made. On placing the declination curves over one another, I find that in many cases there is absolute agreement between them, so that the rate of change of magnetic disturbances at widely-distant stations like Kew, Vienna, and St. Petersburg, is precisely the same; also similar disturbances take place at different stations at the same absolute time. It may be stated generally, for large as well as small disturbances, that the east and west deflections of the declination needle take place at the same time and are of the same character at these widely-distant stations.

There are exceptions to this law. Some disturbances occur at one or two stations and are not perceived at another station. Many instances occur, where, up to a certain point of time, the disturbances at all the stations are precisely alike, but suddenly at one or two stations the disturbance changes its character: for instance, on comparing Kew and St. Petersburg, we get perfect similarity followed by deflections of the needle opposite ways at the same instant, and in some such cases the maxima in opposite directions are reached at the same instant, showing that the opposite deflections are produced by the same cause, and that the immediate cause or medium of disturbance in such a case is not far off; probably it is some change of direction or intensity of the earth's magnetism arising from solar action upon it.

Generally, after an hour or two, these differences in the effects of the disturbance vanish, and the disturbances again become alike and simultaneous. In such cases of difference, if the curve tracing of the horizontal or the vertical force be examined, it is generally found that, at the very same instant of absolute time, with the beginning of these opposite movements there was an increase or a diminution in the horizontal force, and that the horizontal force continues to change as long as there is any difference in the character of the declination curves. It is clear then from these effects that the cause or causes of magnetic disturbances are in general far distant from the earth's surface, even when those disturbances are large; but that not unfrequently these causes act on magnetic matter nearer to the surface of the earth, and therefore at times between two places of observation, and nearer to one than another, thus producing opposite effects on the declination needle at those places; in such cases the differences are probably due to changes in the earth's magnetic force. Now,

if we imagine the masses of iron, nickel, and magnesium in the sun to retain even a slight degree of magnetic power in their gaseous state—and we know from the researches of Faraday that gases are some of them magnetic—we have a sufficient cause for all our terrestrial magnetic changes, for we know that these masses of metal are ever boiling up from the lower and hotter levels of the sun's atmosphere to the cooler upper regions, where they must again form clouds to throw out their light and heat, and to absorb the light and heat coming from the hotter lower regions; then they become condensed and are drawn again back towards the body of the sun, so forming those remarkable dark spaces or sun-spots by their downrush towards the lower levels.

In these vast changes, which we know from the science of energy must be taking place, but of the vastness of which we can have no conception, we have abundant cause for these magnetic changes which we observe at the same instant at distant points on the surface of the earth, and the same cause acting by induction on the magnetic matter within and on the earth may well produce changes in the magnitude or in the direction of its total magnetic force. These magnetic changes on the earth will influence the declination needles at different places, and will cause them to be deflected; the direction of the deflection must depend on the situation of the earth's magnetic axis or the direction of its motion with regard to the stations where the observations are made. Thus both directly and indirectly we may find in the Sun not only the cause of diurnal magnetic variations, but also the cause of these remarkable magnetic changes and disturbances over the surface of the Earth.

## SECTION D

## BIOLOGY

*Department of Anatomy and Physiology*

ADDRESS BY F. M. BALFOUR, M.A., F.R.S., VICE-PRESIDENT OF THE SECTION

IN the spring of the present year Prof. Huxley delivered an address at the Royal Institution, to which he gave the felicitous title of "The Coming of Age of the Origin of Species." It is, as he pointed out, twenty-one years since Mr. Darwin's great work was published, and the present occasion is an appropriate one to review the effect which it has had on the progress of biological knowledge.

There is, I may venture to say, no department of biology the growth of which has not been profoundly influenced by the Darwinian theory. When Messrs. Darwin and Wallace first enunciated their views to the scientific world, the facts they brought forward seemed to many naturalists insufficient to substantiate their far-reaching conclusions. Since that time an overwhelming mass of evidence has, however, been rapidly accumulating in their favour. Facts which at first appeared to be opposed to their theories have one by one been shown to afford striking proofs of their truth. There are at the present time but few naturalists who do not accept in the main the Darwinian theory, and even some of those who reject many of Darwin's explanations still accept the fundamental position that all animals are descended from a common stock.

To attempt in the brief time which I have at my disposal to trace the influence of the Darwinian theory on all the branches of anatomy and physiology would be wholly impossible, and I shall confine myself to an attempt to do so for a small section only. There is perhaps no department of biology which has been so revolutionised, if I may use the term, by the theory of animal evolution as that of Development or Embryology. The reason of this is not far to seek. According to the Darwinian theory the present order of the organic world has been caused by the action of two laws, known as the laws of heredity and of variation. The law of heredity is familiarly exemplified by the well-known fact that offspring resemble their parents. Not only, however, do the offspring belong to the same species as their parents, but they inherit the individual peculiarities of their parents. It is on this that the breeders of cattle depend, and it is a fact of every-day experience amongst ourselves. A further point with reference to heredity to which I must call your attention is the fact that the characters, which display themselves at some special period in the life of the parent, are acquired by the offspring at a corresponding period. Thus, in many birds the males have a special plumage in the adult state. The male off-

spring is not, however, born with the adult plumage, but only acquires it when it becomes adult.

The law of variation is in a certain sense opposed to the law of heredity. It asserts that the resemblance which offspring bear to their parents is never exact. The contradiction between the two laws is only apparent. All variations and modifications in an organism are directly or indirectly due to its environments; that is to say, they are either produced by some direct influence acting upon the organism itself, or by some more subtle and mysterious action on its parents; and the law of heredity really asserts that the offspring and parent would resemble each other if their environments were the same. Since, however, this is never the case, the offspring always differ to some extent from the parents. Now, according to the law of heredity, every acquired variation tends to be inherited, so that, by a summation of small changes, the animals may come to differ from their parent stock to an indefinite extent.

We are now in a position to follow out the consequences of these two laws in their bearing on development. Their application will best be made apparent by taking a concrete example. Let us suppose a spot on the surface of some very simple organism to become, at a certain period of life, pigmented, and therefore to be especially sensitive to light. In the offspring of this form the pigment-spot will reappear at a corresponding period; and there will therefore be a period in the life of the offspring during which there is no pigment-spot, and a second period in which there is one. If a naturalist were to study the life-history, or, in other words, the embryology, of this form, this fact about the pigment-spot would come to his notice, and he would be justified, from the laws of heredity, in concluding that the species was descended from an ancestor without a pigment-spot, because a pigment-spot was absent in the young. Now, we may suppose the transparent layer of skin above the pigment-spot to become thickened, so as gradually to form a kind of lens, which would throw an image of external objects on the pigment-spot. In this way a rudimentary eye might be evolved out of the pigment-spot. A naturalist studying the embryology of the form with this eye would find that the pigment-spot was formed before the lens, and he would be justified in concluding, by the same process of reasoning as before, that the ancestors of the form he was studying first acquired a pigment-spot and then a lens. We may picture to ourselves a series of steps by which the simple eye, the origin of which I have traced, might become more complicated; and it is easy to see how an embryologist studying the actual development of this complicated eye would be able to unravel the process of its evolution.

The general nature of the methods of reasoning employed by embryologists, who accept the Darwinian theory, is exemplified by the instance just given. If this method is a legitimate one, and there is no reason to doubt it, we ought to find that animals, in the course of their development, pass through a series of stages, in each of which they resemble one of their remote ancestors; but it is to be remembered that, in accordance with the law of variation, there is a continual tendency to change, and that the longer this tendency acts the greater will be the total effect. Owing to this tendency we should not expect to find a perfect resemblance between an animal, at different stages of its growth, and its ancestors; and the remoter the ancestors, the less close ought the resemblance to be. In spite, however, of this limitation, it may be laid down as one of the consequences of the law of inheritance that every animal ought, in the course of its individual development, to repeat with more or less fidelity the history of its ancestral evolution.

A direct verification of this proposition is scarcely possible. There is ample ground for concluding that the forms from which existing animals are descended have in most instances perished; and although there is no reason why they should not have been preserved in a fossil state, yet, owing to the imperfection of the geological record, palæontology is not so often of service as might have been hoped.

While, for the reasons just stated, it is not generally possible to prove by direct observation that existing forms in their embryonic state repeat the characters of their ancestors, there is another method by which the truth of this proposition can be approximately verified.

A comparison of recent and fossil forms shows that there are actually living at the present day representatives of a considerable proportion of the groups which have in previous times existed on the globe, and there are therefore forms allied to the ancestors of those living at the present day, though not actually

the same species. If therefore it can be shown that the embryo<sup>s</sup> of existing forms pass through stages in which they have the characters of more primitive groups, a sufficient proof of our proposition will have been given.

That such is often the case is a well-known fact, and was even known before the publication of Darwin's works. Von Baer, the greatest embryologist of the century, who died at an advanced age but a few years ago, discussed the proposition at considerable length in a work published between the years 1830 and 1840. He came to the conclusion that the embryos of higher forms never actually resemble lower forms, but only the embryos of lower forms; and he further maintained that such resemblances did not hold at all, or only to a very small extent, beyond the limits of the larger groups. Thus he believed that, though the embryos of Vertebrates might agree amongst themselves, there was no resemblance between them and the embryos of any invertebrate group. We now know that these limitations of von Baer do not hold good, but it is to be remembered that the meaning *now* attached by embryologists to such resemblances was quite unknown to him.

These preliminary remarks will, I trust, be sufficient to demonstrate how completely modern embryological reasoning is dependent on the two laws of inheritance and variation, which constitute the keystones of the Darwinian theory.

Before the appearance of the "Origin of Species" many very valuable embryological investigations were made, but the facts discovered were to their authors merely so many ultimate facts, which admitted of being classified, but could not be explained. No explanation could be offered of why it is that animals, instead of developing in a simple and straightforward way, undergo in the course of their growth a series of complicated changes, during which they often acquire organs which have no function, and which, after remaining visible for a short time, disappear without leaving a trace.

No explanation, for instance, could be offered of why it is that a frog in the course of its growth has a stage in which it breathes like a fish, and then why it is like a newt with a long tail, which gradually becomes absorbed, and finally disappears. To the Darwinian explanation of such facts is obvious. The stage when the tadpole breathes by gills is a repetition of the stage when the ancestors of the frog had not advanced in the scale of development beyond a fish, while the newt-like stage implies that the ancestors of the frog were at one time organised very much like the newts of to-day. The explanation of such facts has opened out to the embryologist quite a new series of problems. These problems may be divided into two main groups, technically known as those of phylogeny and those of organogeny. The problems of phylogeny deal with the genealogy of the animal kingdom. A complete genealogy would form what is known as a natural classification. To attempt to form such a classification has long been the aim of a large number of naturalists, and it has frequently been attempted without the aid of embryology. The statements made in the earlier part of my address clearly show how great an assistance embryology is capable of giving in phylogeny; and as a matter of fact embryology has been during the last few years very widely employed in all phylogenetic questions, and the results which have been arrived at have in many cases been very striking. To deal with these results in detail would lead me into too technical a department of my subject; but I may point out that amongst the more striking of the results obtained *entirely* by embryological methods is the demonstration that the Vertebrata are not, as was nearly universally believed by older naturalists, separated by a wide gulf from the Invertebrata, but that there is a group of animals, known as the Ascidians, formerly united with the Invertebrata, which are now universally placed with the Vertebrata.

The discoveries recently made in organogeny, or the genesis of organs, have been quite as striking, and in many respects even more interesting, than those in phylogeny, and I propose devoting the remainder of my address to a history of results which have been arrived at with reference to the origin of the nervous system.

To render clear the nature of these results I must say a few words as to the structure of the animal body. The body is always built of certain pieces of protoplasm, which are technically known to biologists as cells. The simplest organisms are composed either of a single piece of this kind, or of several similar pieces loosely aggregated together. Each of these pieces or cells is capable of digesting and assimilating food, and of respiring; it can execute movements, and is sensitive to external

stimuli, and can reproduce itself. All the functions of higher animals can, in fact, be carried on in this single cell. Such lowly-organised forms are known to naturalists as the Protozoa. All other animals are also composed of cells, but these cells are no longer complete organisms in themselves. They exhibit a division of labour: some carrying on the work of digestion; some, which we call nerve-cells, receiving and conducting stimuli; some, which we call muscle-cells, altering their form—in fact, contracting in one direction—under the action of the stimuli brought to them by the nerve-cells. In most cases a number of cells with the same function are united together, and thus constitute a tissue. Thus the cells which carry on the work of digestion form a lining membrane to a tube or sac, and constitute a tissue known as a secretory epithelium. The whole of the animals with bodies composed of definite tissues of this kind are known as the Metazoa.

A considerable number of early developmental processes are common to the whole of the Metazoa.

In the first place every Metazoon commences its existence as a single cell, in the sense above defined; this cell is known as the ovum. The first developmental process which takes place consists in the division or segmentation of the single cell into a number of smaller cells. The cells then arrange themselves into two groups or layers known to embryologists as the *primary germinal layers*. These two layers are usually placed one within the other round a central cavity. The inner of the two is called the hypoblast, the outer the epiblast. The existence of these two layers in the embryos of vertebrate animals was made out early in the present century by Pander, and his observations were greatly extended by von Baer and Remak. But it was supposed that these layers were confined to vertebrate animals. In the year 1849, and at greater length in 1859, Huxley demonstrated that the bodies of all the polype tribe or Coelenterata—that is to say, of the group to which the common polype, jelly-fish, and the sea-anemone belong—were composed of two layers of cells, and stated that in his opinion these two layers were homologous with the epiblast and hypoblast of vertebrate embryos. This very brilliant discovery came before its time. It fell upon barren ground, and for a long time bore no fruit. In the year 1860 a young Russian naturalist named Kowalevsky began to study by special histological methods the development of a number of invertebrate forms of animals, and discovered that at an early stage of development the bodies of all these animals were divided into germinal layers like those in vertebrates. Biologists were not long in recognising the importance of these discoveries, and they formed the basis of two remarkable essays, one by our own countryman, Prof. Lankester, and the other by a distinguished German naturalist, Prof. Haeckel of Jena.

In these essays the attempt was made to show that the stage in development already spoken of, in which the cells are arranged in the form of two layers inclosing a central cavity, has an ancestral meaning, and that it is to be interpreted to signify that all the Metazoa are descended from an ancestor which had a more or less oval form, with a central digestive cavity provided with a single opening, serving both for the introduction of food and for the ejection of indigestible substances. The body of this ancestor was supposed to have been a double-walled sac formed of an inner layer, the hypoblast, lining the digestive cavity, and an outer layer, the epiblast. To this form Haeckel gave the name of *gastrea* or *gastula*.

There is every reason to think that Lankester and Haeckel were quite justified in concluding that a form more or less like that just described was the ancestor of the Metazoa; but the further speculations contained in their essays as to the origin of this form from the Protozoa can only be regarded as suggestive feelers, which, however, have been of great importance in stimulating and directing embryological research. It is, moreover, very doubtful whether there are to be found in the developmental histories of most animals any traces of this *gastrea* ancestor, other than the fact of their passing through a stage in which the cells are divided into two germinal layers.

The key to the nature of the two germinal layers is to be found in Huxley's comparison between them, and the two layers in the fresh-water polype and the sea-anemone. The epiblast is the primitive skin, and the hypoblast is the primitive epithelial wall of the alimentary tract.

In the whole of the polype group, or Coelenterata, the body remains through life composed of the two layers, which Huxley recognised as homologous with the epiblast and hypoblast of the Vertebrata; but in all the higher Metazoa a third germinal



layer, known as the mesoblast, early makes its appearance between the two primary layers. The mesoblast originates as a differentiation of one or of both the primary germinal layers; but although the different views which have been held as to its mode of origin form an important section of the history of recent embryological investigations, I must for the moment confine myself to saying that from this layer there take their origin—the whole of the muscular system, of the vascular system, and of that connective-tissue system which forms the internal skeleton, tendons, and other parts.

We have seen that the epiblast represents the skin or epidermis of the simple sac-like ancestor common to all the Metazoa. In all the higher Metazoa it gives rise, as might be expected, to the epidermis, but it gives rise at the same time to a number of other organs; and, in accordance with the principles laid down in the earlier part of my address, it is to be concluded that the organs so derived have been formed as differentiations of the primitive epidermis. One of the most interesting of recent embryological discoveries is the fact that the nervous system is, in all but a very few doubtful cases, derived from the epiblast. This fact was made out for vertebrate animals by the great embryologist Van Baer; and the Russian naturalist Kowalevsky, to whose researches I have already alluded, showed that this was true for a large number of invertebrate animals. The derivation of the nervous system from the epiblast has since been made out for a sufficient number of forms satisfactorily to establish the generalisation that it is all but universally derived from the epiblast.

In any animal in which there is no distinct nervous system it is obvious that the general surface of the body must be sensitive to the action of its surroundings, or to what are technically called stimuli. We know experimentally that this is so in the case of the Protozoa, and of some very simple Metazoa, such as the fresh-water Polype or Hydra, where there is no distinct nervous system. The skin or epidermis of the ancestor of the Metazoa was no doubt similarly sensitive; and the fact of the nervous system being derived from the epiblast implies that the functions of the central nervous system, which were originally taken by the whole skin, became gradually concentrated in a special part of the skin which was step by step removed from the surface, and finally became a well-defined organ in the interior of the body.

What were the steps by which this remarkable process took place? How has it come about that there are nerves passing from the central nervous system to all parts of the skin, and also to the muscles? How have the arrangements for reflex actions arisen by which stimuli received on the surface of the body are carried to the central part of the nervous system, and are thence transmitted to the appropriate muscles, and cause them to contract? All these questions require to be answered before we can be said to possess a satisfactory knowledge of the origin of the nervous system. As yet, however, the knowledge of these points derived from embryology is imperfect, although there is every hope that further investigation will render it less so? Fortunately, however, a study of comparative anatomy, especially that of the Coelenterata, fills up some of the gaps left from our study of embryology.

From embryology we learn that the ganglion-cells of the central part of the nervous system are originally derived from the simple undifferentiated epithelial cells of the surface of the body. We further learn that the nerves are out-growths of the central nervous system. It was supposed till quite recently that the nerves in Vertebrates were derived from parts of the middle germinal layer or mesoblast, and that they only became secondarily connected with the central nervous system. This is now known not to be the case, but the nerves are formed as processes growing out from the central part of the nervous system.

Another important fact shown by embryology is that the central nervous system, and perceptible portion of the organs of special sense, are often formed from the same part of the primitive epidermis. Thus, in ourselves and in other vertebrate animals the sensitive part of the eye, known as the retina, is formed from two lateral lobes of the front part of the primitive brain. The crystalline lens and cornea of the eye are, however, subsequently formed from the skin.

The same is true for the peculiar compound eyes of crabs or Crustacea. The most important part of the central nervous system of these animals is the supracerebral ganglia, often known as the brain, and these are formed in the embryo from two thickened patches of the skin at the front end of the body.

These thickened patches become gradually detached from the surface, remaining covered over by a layer of skin. They then constitute the supracerebral ganglia; but they form not only the ganglia, but also the rhabdons or retinal elements of the eye—the parts in fact which correspond to the rods and cones in our own retina. The layer of epidermis or skin which lies immediately above the supracerebral ganglia becomes gradually converted into the refractive media of the crustacean eye. A cuticle which lies on its surface forms the peculiar facets on the surface of the eye, which are known as the corneal lenses, while the cells of the epidermis give rise to lens-like bodies known as the crystalline cones.

It would be easy to quote further instances of the same kind, but I trust that the two which I have given will be sufficient to show the kind of relation which often exists between the organs of special sense, especially those of vision, and the central nervous system. It might have been anticipated *a priori* that organs of special sense would only appear in animals provided with a well-developed central nervous system. This, however, is not the case. Special cells with long delicate hairs, which are undoubtedly highly sensitive structures, are present in animals in which as yet nothing has been found which could be called a central nervous system; and there is every reason to think that the organs of special sense originated *pari passu* with the central nervous system. It is probable that in the simplest organisms the whole body is sensitive to light, but that with the appearance of pigment-cells in certain parts of the body, the sensitiveness to light became localised to the areas where the pigment-cells were present. Since, however, it was necessary that stimuli received by such organs should be communicated to other parts of the body, some of the epidermic cells in the neighbourhood of the pigment-spots, which were at first only sensitive, in the same manner as other cells of the epidermis, became gradually differentiated into special nerve-cells. As to the details of this differentiation, embryology does not as yet throw any great light; but from the study of comparative anatomy there are grounds for thinking that it was somewhat as follows:—Cells placed on the surface sent protoplasmic processes of a nervous nature inwards, which came into connection with nervous processes from similar cells placed in other parts of the body. The cells with such processes then became removed from the surface, forming a deep layer of the epidermis below the sensitive cells of the organ of vision. With these cells they remained connected by protoplasmic filaments, and thus they came to form a thickening of the epidermis underneath the organ of vision, the cells of which received their stimuli from those of the organ of vision, and transmitted the stimuli so received to other parts of the body. Such a thickening would obviously be the rudiment of a central nervous system, and it is easy to see by what steps it might become gradually larger and more important, and might gradually travel inwards, remaining connected with the sense-organ at the surface by protoplasmic filaments, which would then constitute nerves. The rudimentary eye would at first merely consist partly of cells sensitive to light, and partly of optical structures constituting the lens, which would throw an image of external objects upon it, and so convert the whole structure into a true organ of vision. It has thus come about that, in the development of the individual, the retina or sensitive part of the eye is first formed in connection with the central nervous system, while the lenses of the eye are independently evolved from the epidermis at a later period.

The general features of the origin of the nervous system which have so far been made out by means of the study of embryology are the following:—

1. That the nervous system of the higher Metazoa has been developed in the course of a long series of generations by a gradual process of differentiation of parts of the epidermis.
2. That part of the central nervous system of many forms arose as a local collection of nerve-cells in the epidermis, in the neighbourhood of rudimentary organs of vision.
3. That ganglion-cells have been evolved from simple epithelial cells of the epidermis.
4. That the primitive nerves were outgrowths of the original ganglion cells; and that the nerves of the higher forms are formed as outgrowths of the central nervous system.

The points on which embryology has not yet thrown a satisfactory light are:—

1. The steps by which the protoplasmic processes from the primitive epidermic cells, became united together so as to form

are the ethnical relations of the typical man of South Wales?

Nine people out of every ten to whom this question might be addressed would unhesitatingly answer that the true Welsh are Celts or Kelts.<sup>1</sup> And they would seek to justify their answer by a confident appeal to the Welsh language. No one has any doubt about the position of this language as a member of the Celtic family. The Welsh and the Breton fall naturally together as living members of a group of languages to which Prof. Rhys applies the term *Brythonic*, a group which also includes such fossil tongues as the old Cornish, the speech of the Strathclyde Britons, and possibly the language of the Picts and of the Gauls. On the other hand, the Gaelic of Scotland, the Irish, and the Manx arrange themselves as naturally in another group, which Prof. Rhys distinguishes as the *Goidelic* branch of the Celtic stock.<sup>2</sup> But does it necessarily follow that all the peoples who are closely linked together by speaking, or by having at some time spoken, these Celtic languages, are as closely linked together by ties of blood? Great as the value of language unquestionably is as an aid to ethnological classification, are we quite safe in concluding that all the Celtic-speaking peoples are one in race?

The answer to such a question must needs depend upon the sense in which the anthropologist uses the word Kelt. History and tradition, philology and ethnology, archæology and craniology, have at different times given widely divergent definitions of the term. Sometimes the word has been used with such elasticity as to cover a multitude of peoples who differ so widely one from another in physical characteristics that if the hereditary persistence of such qualities counts for anything, they cannot possibly be referred to a common stock. Sometimes, on the other hand, the word has been so restricted in its definition that it has actually excluded the most typical of all Kelts—the Gaulish Kelts of Cæsar. According to one authority the Kelt is short, according to another tall; one ethnologist defines him as being dark, another as fair; this craniologist finds that he has a long skull, while that one declares that his skull is short. It was no doubt this ambiguity that led so keen an observer as Dr. Beddoe to remark, nearly fifteen years ago, that "Kelt and Celtic are terms which were useful in their day, but which have ceased to convey a distinct idea to the minds of modern students."<sup>3</sup>

No anthropologist has laboured more persistently in endeavouring to evoke order out of this Celtic chaos than the late Paul Broca. What, let us ask, was the opinion of this distinguished anthropologist on the Celtic question? Prof. Broca always held that the name of Kelt should be strictly limited to the Kelt of positive history—to the people, or rather confederation of peoples, actually seen by Cæsar in Celtic Gaul—and, of course, to their descendants in the same area. Every schoolboy is familiar with the epitome of Gaulish ethnology given by Julius in his opening chapter. Nothing can be clearer than his description of the tripartite division of Gaul, and of the separation between the three peoples who inhabited the country—the Belgæ, the Aquitani, and the Celts. Of these three peoples the most important were those whom the Romans called *Galli*, but who called themselves, as the historian tells us, *Celtae*. The country occupied by the Celtic population stretched from the Alps to the Atlantic in one direction, and from the Seine to the Garonne in another; but it is difficult to find any direct evidence that the Kelts of this area ever crossed into Britain. Broca refused to apply the name of Kelt to the old inhabitants of Belgic Gaul, and as a matter of course

<sup>1</sup> Whether this word should be written Celt or Kelt seems to be a matter of scientific indifference. Probably the balance of opinion among ethnologists is in the direction of the former rendering. Nevertheless it must be borne in mind that the word "celt" is so commonly used nowadays by writers on prehistoric anthropology to designate an axe-head, or some such weapon, whether of metal or of stone, that it is obviously desirable to make the difference between the archaeological word and the ethnological term as clear as possible. If ethnologists persist in writing "Celt," the two words differ only in the magnitude of an initial, and when spoken are absolutely indistinguishable. I shall therefore write, as a matter of expediency, "Kelt." It may be true, as Mr. Knight Watson has pointed out, that there was originally no justification for using the word "celt" as the name of a weapon, but it is too late in the day to attempt to oust so deeply-rooted a word from the vocabulary of the archæologists.

<sup>2</sup> "Lectures on Welsh Philology," by John Rhys, M.A., 2nd edition, 1878, p. 15.

<sup>3</sup> *Mem. Anthropol. Soc. Lon.*, vol. ii. 1866, p. 348.

<sup>4</sup> The following are Broca's principal contributions to this vexed question—"Qu'est-ce que les Celtes?" *Bulletins de la Société Anthropologique de Paris*, t. v. p. 457; "Le Nom des Celtes," *ibid.*, s. sér. t. ix. p. 662; "Sur les Textes relatifs aux Celtes dans la Grande-Bretagne," *ibid.*, s. sér. t. xii. p. 509; "La Race Celtique, ancienne et moderne," *Revue d'Anthropologie*, t. ii. p. 378; and "Recherches sur l'Ethnologie de la France," *Mém. de la Soc. Anthropol.*, t. i. p. 1.

he denied it to any of the inhabitants of the British Isles. Writing as late as 1877, in full view of all the arguments which had been adduced against his opinions, he still said: "Je continue à soutenir, jusqu'à preuve du contraire, ce que j'ai avancé il y a douze ans dans notre première discussion sur les Celtes, savoir, qu'il n'existe aucune preuve, qu'on ait constaté dans les Îles Britanniques l'existence d'un peuple portant le nom de Celtes."<sup>1</sup>

Nevertheless, in discussing the Celtic question with M. Henri Martin, he admitted the convenience, almost the propriety, of referring to all who spoke Celtic languages as *Celtic* peoples, though of course he would not hear of their being called Kelts. "On peut très bien les nommer les peuples celtiques. Mais il est entièrement faux de les appeler les Celtes, comme on le fait si souvent."<sup>2</sup> As to the eminent historian himself, I need hardly say that M. Martin adheres to the popular use of the word Kelt, and even goes so far as to speak of the county in which we are now assembled as "le Glamorgan, le pays aujourd'hui le plus celtique de l'Europe."<sup>3</sup>

Whether we use the word Kelt in its wide linguistic sense or in the narrower sense to which it has been reduced by the French anthropologists, it is important to remember that the Welsh do not designate, and never have designated themselves by this term or by any similar word. Their national name is *Cymry*, the plural of *Cymro*. My former colleague, the Rev. Prof. Silvan Evans, kindly informs me that the most probable derivation of this word is from *cyd* (the *d* being changed to *m* for assimilation with the following *b*, like the *n* of its Latin cognate *con*) and *bro*, "country," the old form of which is *brog*, as found in *Allobroga*, and some other ancient names. The meaning of *Cymry* is therefore "fellow-countrymen," or compatriots. Such a meaning naturally suggests that the name must have been assumed in consequence of some foreign invasion—possibly when the Welsh were banded together against either the Romans or the English. If this assumption be correct it must be a word of comparatively late origin.

At the same time, the similarity between *Cymry* and *Cimbri*—the name of those dread foes of the Romans whom Marius eventually conquered—is so close as to naturally suggest a common origin for the two names, if not for the people who bore the names.<sup>4</sup> The warlike Cimbr have generally been identified with the people who inhabited the Cimbric peninsula, the *Chersonesus Cimbrica*, now called Jutland. Whether they were connected or not with the *Kimmerioi*, who dwelt in the valley of the Danube and in the Tauric Chersonesus or *Crimæa*, is a wider question with which we are not at the moment concerned. As to the ethnical relations of the Cimbr, two views have been current, the one regarding them as of Germanic, the other as of Celtic stock. Canon Rawlinson, in summing up the evidence on both sides, believes that the balance of opinion inclines to the Celtic view.<sup>5</sup> These Cimbr are described, however, as having been tall, blue-eyed, and yellow- or flaxen-haired men. Can we trace anything like these characters in the *Cymry*?

All the evidence which the ethnologist is able to glean from classical writers with respect to the physical characters and ethnical relations of the ancient inhabitants of this country may be put into a nutshell with room to spare. The exceeding meagreness of our data from this source will be admitted by any one who glances over the passages relating to Britain which are collected in the "Monumenta Historica Britannica." As to the people in the south, there is the well-known statement in Cæsar, that the maritime parts of Britain, the southern parts which he personally visited, were peopled by those who had crossed over from the Belgæ, for what purpose we need not inquire. Of the Britons of the interior, whom he never saw, he merely repeats a popular tradition which represented them as aborigines.<sup>6</sup> They may, therefore, have been Celtic tribes, akin to the Celti of Gaul, though there is nothing in Cæsar's words to support such a view.

Tacitus, in writing the life of his father-in-law, Agricola,

<sup>1</sup> *Bulletins de la Société Anthropologique de Paris*, s. sér. t. xii. 1878, p. 511.

<sup>2</sup> *Ibid.*, t. ix. 1874, p. 662.

<sup>3</sup> *Ibid.*, t. xii. p. 486.

<sup>4</sup> Prof. Rhys, however, has pointed out that there is no relation between the names. See "British Barrows," by Canon Greenwell and Prof. Rolleston, 1877, p. 632.

<sup>5</sup> "On the Ethnography of the Cimbr." By Canon Rawlinson. *Yearbook Anthropol. Inst.*, vol. vi. 1877, p. 150. See also Dr. Latham's paper and postscript, "On the Evidence of a Connection between the Cimbr and the Chersonesus Cimbrica," published in his "Germania of Tacitus."

<sup>6</sup> "Britannia pars interior ab his incolitur, quos natos in insula ipsa memoria proditum dicunt: maritima pars ab his, qui prædæ ac belli inferendi causa ex Belgis transierant."—*De Bello Gallico*, lib. v. c. 12.

says that the Britons nearest to Gaul resembled the Gauls.<sup>1</sup> If he refers here to the sea-coast tribes in the south-east of Britain, the comparison must be with the Belgic and not with the Celtic Gauls. But his subsequent reference to the resemblance between the sacred rites of the Britons and those of the Gauls suggests that his remarks may be fairly extended to the inland tribes beyond the limits of the Belgic Britons, in which case the resemblance may be rather with the Gaulish Kelts. Indeed this inference, apart from the testimony of language, is the chief evidence upon which ethnologists have based their conclusions as to the Celtic origin of the Britons.

Our data for restoring the anthropological characteristics of the ancient Britons are but few and small. It is true that a description of *Banducia*, or *Boadicea*, has been left to us by *Xiphiline*, of *Trebizond*; but then it will be objected that he did not write until the twelfth century. Yet it must be remembered that he merely abridged the works of *Dion Cassius*, the historian, who wrote a thousand years earlier, and consequently we have grounds for believing that what *Xiphiline* describes is simply a description taken from the lost books of an early historian who is supposed to have drawn his information from original sources. Now *Boadicea* is described in these terms: "She was of the largest size, most terrible of aspect, most savage of countenance, and harsh of voice, having a profusion of yellow hair which fell down to her hips."<sup>2</sup> Making due allowance for rhetorical exaggeration, making allowance too for the fact that in consequence of her royal descent she is likely to have been above the average stature, and even admitting that she dyed her hair, it is yet clear that this British queen must be regarded as belonging to the xanthous type—tall and fair. The tribe of the *Iceni*, over which this blonde amazon ruled, is generally placed beyond the limits of the Belgic Britons; though some authorities have argued in favour of a Belgic origin. If the latter view be correct, we should expect the queen to be tall, light-haired, and blue-eyed; for, from what we know of the Belgæ, such were their features. *Cæsar* asserts that the majority of the Belgæ were derived from the Germans.<sup>3</sup> But notwithstanding this assertion most ethnologists are inclined to ally them with the *Celti*, without, of course, denying a strong Teutonic admixture. *Strabo* says<sup>4</sup> that the Belgæ and *Celti* had the same Gaulish form, though both differed widely in physical characters from the *Aquitani*. As to language, *Cæsar's* statement that the Belgic and Celtic differed, probably refers only to dialectical differences.<sup>5</sup> If a close ethnical relationship can be established between the *Celti* and the Belgæ, British ethnology clearly gains in simplification. To what extent the Belgic settlers in this country resembled the neighbouring British tribes must remain a moot point. According to *Strabo*<sup>6</sup> the Britons were taller than the *Celti*, with hair less yellow, and they were slighter in build. By the French school of ethnologists the Belgæ are identified with the *Cymry*, and are described as a tall fair people, similar to the *Cimbri* already mentioned; and *Dr. Pritchard*, the founder of English anthropology, was led long ago to describe the Celtic type in similar terms.<sup>7</sup>

Yet as we pass across Britain westwards, and advance towards those parts which are reputed to be predominantly Celtic, the proportion of tall fair folk, speaking in general terms, diminishes, while the short and dark element in the population increases, until it probably attains its maximum somewhere in this district. As popular impressions are apt to lead us astray, let us turn for accuracy to the valuable mass of statistics collected in *Dr. Beddoe's* well-known paper "On the Stature and Bulk of Man in the British Isles,"<sup>8</sup> a paper to which every student refers with unflinching confidence, and which will probably remain our standard authority until the labours of our own Anthropometric Committee are sufficiently matured for publication. *Dr. Beddoe*, summing up his observations on the physical characters of the Welsh as a whole, defines them as of "short stature, with good weight, and a tendency to darkness of eyes, hair, and skin." With regard to this tendency to darkness, it is well to look more searchingly at the district in which we are

assembled. *Dr. Beddoe*, in another paper,<sup>1</sup> indicated the tendency by a numerical expression which he termed the *index of nigrescence*. "In the coast-districts and lowlands of *Monmouthshire* and *Glamorgan*, the ancient seats of *Saxon*, *Norman*, and *Flemish* colonisation, I find," says this observer, "the indices of hair and eyes so low as 33.5 and 63; while in the interior, excluding the children of English and Irish immigrants, the figures rise to 57.3 and 109.5—this last ratio indicating a prevalence of dark eyes surpassing what I have met with in any other part of Britain" (p. 43).

Many years ago *Mr. Matthew Moggridge*, whose scientific work is well known in this district, furnished the authors of the "*Crania Britannica*" with notes of the physical characteristics of the Welsh of *Glamorganshire*. He defined the people as having "eyes (long) bright, of dark or hazel colour, hair generally black, or a very dark brown, lank, generally late in turning grey."<sup>2</sup>

There can be no question then as to the prevalence of melanism in this district. Nor does it seem possible to account for this tendency, as some anthropologists have suggested, by the influence of the surrounding media. Even those who believe most firmly in the potency of the environment will hardly be inclined to accept the opinion seriously entertained some years ago by the *Rev. T. Price*, that the black eyes of *Glamorganshire* are due to the prevalence of coal fires.<sup>3</sup> Long before coal came into use there was the same tendency to nigrescence among the Welsh. This may be seen, as *Dr. Nicholas* has pointed out, in the bardic names preserved in ancient Welsh records, where the cognomen of *du*, or "black," very frequently occurs. Thus, in the "*Myvyrian Archaology of Wales*," between A.D. 1280 and 1330, there are registered four "blacks" to one "red" and one "grey," namely *Gwilym Ddu*, *Llywelyn Ddu*, *Goronwy Ddu*, and *Dafydd Ddu*.<sup>4</sup>

The origin of this dark element in the Welsh is to be explained, as every one will have anticipated, by reference to the famous passage in *Tacitus*, which has been worn threadbare by ethnologists. *Tacitus* tells us that the ancient British tribe of *Silures*—a tribe inhabiting what is now *Glamorganshire*, *Monmouthshire*, *Herefordshire*, and parts at least of *Brecknockshire* and *Radnor*—had a swarthy complexion, mostly with curly hair, and that from their situation opposite to Spain there was reason to believe that the Iberians had passed over the sea and gained possession of the country.<sup>5</sup> It will be observed that although *Tacitus* speaks of their dark complexion, he does not definitely state that the hair was dark; but this omission has, curiously enough, been supplied by *Jornandes*, a Goth who, in the sixth century, wrote a work which professes to be an extract from the lost history of *Cassiodorus*, wherein the very words of *Tacitus* are reproduced with the necessary addition.<sup>6</sup> With these passages before us, can we reasonably doubt that the swart blood in the Welsh of the present day is a direct legacy from their *Silurian* ancestors?

Setting what *Tacitus* here says about the *Silures* against what he says in the next sentence about the Britons nearest to Gaul (p. 5), it is clear that we must recognise a duality of type in the population of Southern Britain in his day. This fact has been clearly pointed out by *Prof. Huxley* as one of the few "fixed points in British ethnology."<sup>7</sup> At the dawn of history in this country, eighteen centuries ago, the population was not homogeneous, but contained representatives both of *Prof. Huxley's Melanochroi* and of his *Xanthochroi*. If we have any regard whatever for the persistence of anthropological type, we should hesitate to refer both of these to one and the same elementary stock. We are led then to ask, Which of these two types, if either, is to be regarded as Celtic?

It is because both of these types, in turn, have been called

<sup>1</sup> "On the Testimony of Local Phenomena in the West of England to the Permanence of Anthropological Types."—*Ibid.* vol. ii. 1866, p. 37.

<sup>2</sup> "*Cran. Brit.*," vol. i. p. 53.

<sup>3</sup> "Essay on the Physiognomy and Physiology of the Present Inhabitants of Britain," 1829.

<sup>4</sup> "The Pedigree of the English People," fifth edition, 1878, p. 467.

<sup>5</sup> "Silurum colorati vultus et torti plerumque crines, et postea contra Hispania, Iberos veteres trajecisse, easque sedes occupasse, sedem faciunt."—*Arcole*, c. xl.

<sup>6</sup> "Sylorum [= Silurum] colorati vultus, torti plerumque crines, et nigri nascuntur."—"*De Rebus Geticis*," c. li; quoted in "*Mon. Hist. Brit.*," *Excerpta*, p. lxxviii. It is conjectured that the classical word *Silures* is derived from the British name *Egyllwyr*, the people of *Egyllwyr*. See *Nicholas's* "*History of Glamorganshire*," 1874, p. v. It is difficult to determine how far and in what respects the *Silures* resembled, or differed from, the other inland tribes. Of the *Caledonians*, and of the *Belgæ*, we know something, but of the other inhabitants we are quite ignorant.

<sup>7</sup> "Critiques and Addresses," p. 266.

<sup>1</sup> "Proximi Gallis et similes sunt."—*Agriicola*, c. xl.

<sup>2</sup> "*Mon. Hist. Brit.*," *Excerpta*, p. lvi.

<sup>3</sup> "Plerisque Belgas esse ortos ab Germanis."—*De Bello Gall.*, lib. ii.

<sup>4</sup> Lib. iv. c. i.

<sup>5</sup> "Quand *Cæsar* dit: *Hi omnes lingua, institutis, legibus, inter se differunt*, il faut traduire ici le mot *lingua* par *dialecte*."—*Les Derniers Bretons*, par *Emile Souvestre*, vol. i. p. 142.

<sup>6</sup> Lib. iv. c. i.

<sup>7</sup> "*Researches into the Physical History of Man*," by *J. C.*

*Pritchard*, M.D., F.R.S., vol. iii. p. 129.

<sup>8</sup> *Mem. Anthropol. Soc. Lond.*, vol. iii., 1879, p. 264.

Keltic that so much confusion has been imported into ethnological nomenclature; hence the common-sense conclusion seems to be that neither type can strictly be termed Keltic, and that such a term had better be used only in linguistic anthropology.<sup>1</sup> The Kelt is merely a person who speaks a Keltic language, quite regardless of his race, though it necessarily follows that all persons who speak these languages, if not actually of one blood, must have been, at some period of their history, in close social contact. In this sense, all the inhabitants of Britain, at the period of the Roman invasion, notwithstanding the distinction between Xanthochroi and Melanochroi, were probably to be styled Kelts. There can be little doubt that the xanthous Britons always spoke a Keltic tongue; but it is not so easy to decide what was the original speech of their melanochroic neighbours.

The existence of two types of population, dark and fair, side by side, is a phenomenon which was repeated in ancient Gaul. As the Silures were to Britain so were the Aquitani to Gaul—they were the dark-Iberian element. Strabo states that while the natives of Keltic and Belgic Gaul resembled each other, the Aquitanians differed in their physical characters from both of these peoples, and resembled the Iberians. But Tacitus has left on record the opinion that the Silures also resembled the Iberians; hence the conclusion that the Silures and the Aquitanians were more or less alike. Now it is generally believed that the relics of the old Aquitanian population are still to be found lingering in the neighbourhood of the Pyrenees, being represented at the present day by the Basques. A popular notion has thus [got] abroad that the ancient Silures must have been remotely affined to the Basque populations of France and Spain. Nevertheless the modern Basques are so mixed a race that, although retaining their ancient language, their physical characters have been so modified that we can hardly expect to find in them the features of the old Silurians. Thus, according to the Rev. Wentworth Webster, the average colour of the Basque hair at the present day is not darker than chestnut.<sup>2</sup>

Neither does language render us any aid towards solving the Basque problem. If the Silures were in this country prior to the advent of the Cymry, and if they were cognate with the Basques, it seems only reasonable to suppose that some spoor of their Iberian speech, however scant, might still be lingering amongst us. Yet philologists have sought in vain for the traces of any Euskarian element in the Cymraeg. Prince Louis Lucien Bonaparte, perhaps the only philologist in this country who has a right to speak with authority on such a subject, has obligingly informed me that he knows of no connection whatever between the two languages. Still it must be remembered that the Iberian affinity of the Silures, suggested by the remark of Tacitus, does not necessarily mean Basque affinity. Some philologists have even denied that the Basques are Iberians.<sup>3</sup> All that we seek at present to establish is this—that the dark Britons, represented by the tribe of Silures, although they came to be a Keltic-speaking people, were distinct in race from the fair Britons, and therefore in all likelihood were originally distinct in speech. Nor should it be forgotten that relics of a pre-Keltic non-Aryan people have been detected in a few place-names in Wales. Thus, Prof. Rhys is inclined to refer to this category such names as Menapia, Mona, and Mynyw<sup>4</sup>—the last-named being a place (Menmouth) within the territory of the old Silures, where we are now assembled. We may also look for light upon this subject from a paper which will be laid before the department by Mr. Hyde Clarke. On the whole it seems to me safer to follow Prof. Rolleston in speaking of the dark pre-Keltic element as *Silurian* rather than as Basque or as Iberian.<sup>5</sup> ("British Barrows," p. 630.)

There is, however, quite another quarter to which the anthropologist who is engaged in this investigation may turn with fair promise of reward. I need scarcely remind any one in this department of the singularly suggestive paper which was written more than fifteen years ago by the late Dr. Thurnam, "On the

Two Principal Forms of Ancient British and Gaulish Skulls."<sup>1</sup> The long-continued researches of this eminent archaeological anatomist led him to the conclusion that the oldest sepulchres of this country—the chambered and other long barrows which he explored in Wilts and Gloucestershire—invariably contained the remains of a dolichocephalic people, who were of short stature, and apparently were unacquainted with the use of metals. The absence of metal would alone raise a suspicion that these elongated tumuli were older than the round, conoidal, or bell-shaped barrows, which contain objects of bronze, if not of iron, with or without weapons of stone, and commonly associated with the remains of a taller brachycephalic people.

Even before Dr. Thurnam forcibly pointed attention to this distinction, it had been independently observed by so experienced a barrow-opener as the late Mr. Bateman,<sup>2</sup> whose researches were conducted in quite another part of the country—the district of the ancient Cornavii. Moreover, Prof. Daniel Wilson's studies in Scotland had led him to conclude that the earliest population of Britain were dolichocephalic, and possessed, in fact, a form of skull which, from its boat-like shape, he termed *kumbecephalic*.<sup>3</sup> Nor should it be forgotten that as far back as 1844 the late Sir W. R. Wilde expressed his belief that in Ireland the most ancient type of skull is a long skull, which he held to belong to a dark-complexioned people, probably aboriginal, who were succeeded by a fair, round-headed race.<sup>4</sup>

But while this succession of races was recognised by several observers, it remained for Dr. Thurnam to formulate the relation between the shape of the skull and that of the barrow in a neat aphorism which has become a standing dictum in anthropology—"Long barrows, long skulls; round barrows, round skulls; dolichotaphic barrows, dolichocephalic crania; brachytaphic barrows, brachycephalic crania." No doubt exceptional cases may occur in which round skulls have been found in long barrows, but these have generally been explained as being due to secondary interments. On the other hand, the occasional presence of long skulls in round barrows presents no difficulty, since no one supposes that the early dolichocephali were exterminated by the brachycephali, and it is therefore probable that during the bronze-using period, when round tumuli were in general use, the two peoples may have dwelt side by side, the older race being, perhaps, in a state of subjugation.

It is not pretended that Thurnam's apophthegm has more than a local application. "This axiom," its author admitted, "is evidently not applicable, unless with considerable limitations, to France." Although it is here called an "axiom," it is by no means a self-evident proposition, the relation between the shape of the skull and the shape of the burial-mound being purely arbitrary. The proposition which connects the two is simply the expression of the results of accumulated observations, and it is of course open to doubt whether the number of observations was sufficiently great to warrant the generalisation. But the only test of the validity of any induction lies in its verification when applied to fresh instances, and it is remarkable that when long barrows and chambered tumuli have since been opened in this country the evidence has tended in the main to confirm Dr. Thurnam's proposition.

It is commonly believed that the brachycephali of the round barrows came in contact with the dolichocephali as an invading, and ultimately as a conquering, race. Not only were they armed with superior weapons—superior in so far as a metal axe is a better weapon than a stone axe—but they were a taller and more powerful people. Thurnam's measurements of femora led to the conclusion that the average height of the brachycephali was 5 feet 8·4 inches, while that of the long-headed men was only 5 feet 5·4 inches.<sup>5</sup> Not only were they taller, but they were probably a fiercer and more warlike race. In the skulls from the round barrows the superciliary ridges are more prominent, the nasals diverge at a more abrupt angle, the cheek-bones are high, and the lower jaw projects, giving the face an aspect of ferocity, which contrasts unfavourably with the mild features of the earlier stone-using people.

On the whole, then, the researches of archaeological anatomists tend to prove that this country was tenanted in ante-historic or pre-Roman times by two peoples who were ethnically distinct from each other. It is difficult to resist the temptation of apply-

<sup>1</sup> An excellent argument against the employment of national names by anthropologists will be found in a paper by Mr. A. L. Lewis "On the Evils arising from the Use of Historical National Names as Scientific Terms."—*Journal Anthropol. Inst.*, vol. viii., 1879, p. 825.

<sup>2</sup> "The Basque and the Kelt," *Journal Anthropol. Inst.*, vol. vi., 1876, p. 5.

<sup>3</sup> "La Langue Iberienne et la Langue Basque." Par M. van Eys. *Revue de Linguistique*, July, 1874.

<sup>4</sup> "Lectures on Welsh Philology," second edition, p. 181.

<sup>5</sup> Von Humboldt in his famous essay, "Prüfung der Untersuchungen über die Urbewohner Hispaniens vermittelst der Vaskischen Sprache," does not admit, on philological evidence, any extension of the Iberians to this country. See p. 44: "Über den Aufenthalt Iberischer Völkerschaften ausserhalb Iberien in den von Cüthen bewohnten Ländern."

<sup>1</sup> *Memoirs of the Anthropol. Soc. Lond.*, vol. i., 1846, p. 228.

<sup>2</sup> "Ten Years' Diggings," 1841, p. 146.

<sup>3</sup> "Prehistoric Annals of Scotland," 1851.

<sup>4</sup> "On the Ethnology of the Ancient Irish."

<sup>5</sup> *Mem. Anthropol. Soc. Lond.*, vol. iii., 1870, p. 73.

ing this to the ethnogeny of Wales. Does it not seem probable that the early short race of long-skulled, mild-featured, stone-using people may have been the ancestors of the swarthy Silurians of Tacitus; while the later tall race of round-skulled, rugged-featured, bronze-using men may have represented the broad-headed, Celtic-speaking folk of history? At any rate, the evidence of craniology does not run counter to this hypothesis. For Dr. Beddoe's observations on head-forms in the west of England have shown that "heads which are ordinarily called brachycephalic belonged for the most part to individuals with light hair," while the short dark haired people whom he examined were markedly dolichocephalic.<sup>1</sup> At the same time it must be admitted that his observations lend "no support to the view that the Celtic skull has been, or would be, narrowed by an admixture of the Iberian type." It should not, however, be forgotten that the same observer, in referring to a collection of crania from the Basque country preserved in Paris, says: "The form of M. Broca's Basque crania was very much that of some modern Silurian heads."<sup>2</sup>

According to the view advocated by Thurnam we have a right to anticipate that the oldest skulls found in this country would be of dolichocephalous type; and such I believe to be actually the case. Dr. Barnard Davis, it is true, has stated in the "Crania Britannica" that the ancient British skull must be referred to the brachycephalic type; and such an induction was perfectly legitimate so long as the craniologist dealt only with skulls from the round barrows or from similar interments. But the long-barrow skulls examined by Prof. Rolleston,<sup>3</sup> and the Cisbury skulls recently studied by the same anatomist,<sup>4</sup> are decidedly dolichocephalic, as also are all the early prehistoric skulls which have been found of late years in France. While referring to craniology in this country, I may perhaps be allowed to remark that the eminent Italian anthropologist, Dr. Paolo Mantegazza, in a suggestive paper which has just appeared in his valuable journal, the *Archivio per l'Antropologia*, has referred to the Englishman's contempt for craniological work—work but little worthy of the practical spirit of the Anglo-Saxon race.<sup>5</sup> No doubt it is desirable to increase the number of our observations, but still the good-humoured remark about despising craniology can hardly be applied to a country which numbers among its living men of science such eminent craniologists as Prof. Busk, Prof. Cleland, Dr. Barnard Davis, and Professors Flower, Huxley, and Rolleston.

It may naturally be asked whether the researches of archaeologists in Wales lend any support to Thurnam's hypothesis. Nothing, I conceive, would be easier than to show that very material support has come from this quarter; but I have abstained, of set purpose, from introducing into this address any remarks on the prehistoric archaeology of Wales. For I have not forgotten that we are to have the privilege of hearing an evening lecture on "Primæval Man" by so distinguished an archaeologist and naturalist as Prof. Boyd Dawkins. No one has done more in this country to forward Thurnam's views, whether by actual exploration or by writing, than Prof. Boyd Dawkins; and if I have not referred to his work, especially to his discoveries in Denbighshire, it has been simply because I was anxious to avoid trespassing on any subject which he is likely to bring forward.<sup>6</sup>

Setting aside, then, any archaeological evidence derived from the bone-caves, barrows, or other sepulchres in Wales, we may finally look at the outcome of our inquiry into Welsh ethnogeny. If we admit, as it seems to me we are bound to admit, the existence of two distinct ethnical elements in the Welsh population, one of which is short, dark, and dolichocephalic—call it Silurian, Atlantean, Iberian, Basque, or what you will; and the other of which is tall, fair, and brachycephalic, such as some term Cymric and others Ligurian; then it follows that by

the crossing of these two races we may obtain not only individuals of intermediate character, but occasionally more complex combinations; for example, an individual may have the short stature and long head of the one race, associated with the lighter hair of the other; or again, the tall stature of one may be found in association with the melanism and dolichocephalism of the other race. It is therefore no objection to the views herein expressed if we can point to a living Welshman who happens to be at once tall and dark, or to another who is short and fair.

At the same time I am by no means disposed to admit that when we have recognised the union of the xanthous and melanic elements in Wales, with a predominance of the latter in the south, we have approached to anything like the exhausting limit of the subject. Still earlier races may have dwelt in the land, and have contributed something to the composition of the Welsh. In fact the anthropologist may say of a Welshman, as a character in "Cymbeline" says of Posthumus when doubtful about his pedigree—

"I cannot delve him to the root."

It is possible that the roots of the Welsh may reach far down into some hidden primitive stock, older mayhap than the Neolithic ancestors of the Silurians; but of such pristine people we have no direct evidence. So far however as positive investigation has gone, we may safely conclude that the Welsh are the representatives, in large proportion, of a very ancient race or races; and that they are a composite people who may perhaps be best defined as *Siluro-Cymric*.

Many other questions relating to Welsh ethnology press for consideration—such as the hypothesis that the Kymro was preceded, in parts at least of Wales, by the Gael; but such questions must be dismissed from present discussion, for I fear that my remarks have already overrun the limits of a departmental address. Let us hope however that much light may be thrown upon a variety of questions bearing upon local anthropology in the course of the discussions which will arise in this department during the present session of the Association.

#### PALÆONTOLOGICAL AND EMBRYOLOGICAL DEVELOPMENT<sup>1</sup>

SINCE the publication of the "Poissons Fossiles" by Agassiz and of the "Embryologie des Salmonidées" by Vogt, the similarity, traced by the former between certain stages in the growth of young fishes and the fossil representatives of extinct members of the group, has also been observed in nearly every class of the animal kingdom, and the fact has become a most convenient axiom in the study of palæontological and embryological development. This parallelism, which has been on the one side a strong argument in favour of design in the plan of creation, is now, with slight emendations,<sup>2</sup> doing duty on the other as a newly-discovered article of faith in the new biology.

But while in a general way we accept the truth of the proposition that there is a remarkable parallelism between the embryonic development of a group and its palæontological history, yet no one has attempted to demonstrate this, or rather to show how far the parallelism extends. We have up to the present time been satisfied with tracing the general coincidence, or with striking individual cases.

The resemblance between the pupa stage of some Insects and of adult Crustacea, the earlier existence of the latter, and the subsequent appearance of the former in palæontological history, furnished one of the first and most natural illustrations of this parallelism; while theoretically the necessary development of the higher tracheate insects from their early branchiate aquatic ancestors seemed to form an additional link in the chain, and point to the Worms, the representatives of the larval condition of Insects, as a still earlier embryonic stage of the Articulatæ.

Indeed there is not a single group of the animal kingdom in which embryology has not played a most important part in demonstrating affinities little suspected before. The development of our frogs, our salamanders, has given us the key to much that was unexplained in the history of Reptiles and Batrachians. The little that has been done in the embryology of Birds has revolutionised our ideas of a class which at the beginning of the century seemed to be the most naturally circumscribed of all. Embryology and palæontology combined have led to the recognition of a natural classification uniting Birds and Reptiles on

<sup>1</sup> Address by Prof. Alexander Agassiz, vice-president, Section B, at the Boston Meeting of the American Association, August, 1880.

<sup>1</sup> Mem. Anthropol. Soc. Lond., vol. ii. 1866, p. 320.    <sup>2</sup> *Ibid.*, p. 356.  
<sup>3</sup> "On the People of the Long Barrow Period," *Journ. Anthropol. Inst.*, vol. vi., 1876, p. 120.  
<sup>4</sup> *Ibid.*, vol. vi. 1877, p. 20; vol. viii., 1879, p. 377.  
<sup>5</sup> The whole passage so amusingly refers to the national idiosyncrasies of craniologists, that it is well worth reproduction. "In Francia, Broca, il pontefice massimo dell' *ipterocranologia* moderna, col suo ardore eternamente giovanile, non studia più i crani, ma i cervelli; in Germania si prendono ancora misure sui teschi, ma con *rationabile obsequio*, quasi si dovessero adempiere ad un dovere noioso; in Inghilterra si continua a spremere la craniologia, come cosa poco degna dello spirito pratico della razza anglosassone; e in Italia, paese più scettico di tutti, perchè più antico e più stanco di tutti, si continua a misurare, pur sorridendo dell' *improba e pur inutile fatica*."  
"La Riforma Craniologica," *Archivio*, vol. xi., 1880, p. 117.  
<sup>6</sup> For Prof. Boyd Dawkins' contributions to the subject see his interesting works on "Cave-humings," 1874, and on "Early Man in Britain," 1880.

the one side, and Batrachians and Fishes on the other. It is to embryology that we owe the explanation of the affinities of the Old Fishes in which Agassiz first recognised the similarity to the embryo of Fishes now living, and by its aid we may hope to understand the relationship of the oldest representatives of the class. It has given us the only explanation of the early appearance of the Cartilaginous Fishes, and of the probable formation of the earliest vertebrate limb from the lateral embryonic fold, still to be traced in the young of the Osseous Fishes of to-day.

Embryology has helped us to understand the changes aquatic animals must gradually undergo in order to become capable of living upon dry land. It has given us pictures of swimming-bladders existing as rudimentary lungs in Fishes with a branchial system; in Batrachians it has shown us the persistence of a branchial system side by side with a veritable lung. We find among the earliest terrestrial vertebrates types having manifest affinities with the Fishes on one side and Batrachians on the other, and we call these types Reptiles; but we should nevertheless do so with a reservation, looking to embryology for the true meaning of these half-fledged Reptiles, which lived at the period of transition between an aquatic and a terrestrial life, and must therefore always retain an unusual importance in the study of the development of animal life.

When we come to the embryology of the marine Invertebrates the history of the development of the barnacles is too familiar to be dwelt upon, and I need only allude to the well-known transformations of the Echinoderms, of the Acalephs, Polyphs, in fact of every single class of Invertebrates, and perhaps in none more than in the Brachiopods, to show how far-reaching has been the influence of embryology in guiding us to a correct reading of the relations between the fossils of successive formations. There is scarcely an embryological monograph now published dealing with any of the later stages of growth which does not speak of their resemblance to some type of the group long ago extinct. It has therefore been most natural to combine with the attempts constantly made to establish the genetic sequence between the genera of successive formations an effort to establish also a correspondence between their palæontological sequence and that of the embryonic stages of development of the same, thus extending the mere similarity first observed between certain stages to a far broader generalisation.

It would carry me too far to sketch out, except in a most general way, even for a single class, the agreement known to exist in certain groups between their embryonic development and their palæontological history. It is hinted at in the succession of animal life of any period we may take up, and perhaps cannot be better expressed than by comparing the fauna of any period as a whole with that of following epochs;—a zoological system of the Jura, for instance, compared with one made up for the Cretaceous; next, one for the Tertiary, compared with the fauna of the present day. In no case could we find any class of the animal kingdom bearing the same definitions or characterised in the same manner. But apply to this comparison the data obtained from the embryological development of our present fauna, and what a flood of light is thrown upon the meaning of the succession of these apparently disconnected animal kingdoms, belonging to different geological periods, especially in connection with the study of the few ancient types which have survived to the present day from the earliest times in the history of our earth!

Although there is hardly a class of the animal kingdom in which some most interesting parallelism could not be drawn, and while the material for an examination of this parallelism is partially available for the Fishes, Molluscs, Crustacea, Corals, and Crinoids, yet for the illustration and critical examination of this parallelism I have been led to choose to-day a very limited group, that of Sea-urchins, both on account of the nature of the material and of my own familiarity with their development and with the living and extinct species of Echini. The number of living species is not very great,—less than three hundred,—and the number of fossil species thus far known is not, according to Zittel, more than about two thousand. It is therefore possible for a specialist to know of his own knowledge the greater part of the species of the group. It has been my good fortune to examine all but a few of the species now known to exist, and the collections to which I have had access contain representatives of the majority of the fossil species. Sea-urchins are found in the oldest fossiliferous rocks; they have continued to exist without interruption in all the strata up to the present time. While it is true that our knowledge of the Sea-urchins occurring

before the Jurassic period is not very satisfactory, it is yet complete enough for the purposes of the present essay, as it will enable me, starting from the Jurassic period, to call your attention to the palæontological history of the group, and to compare the succession of its members with the embryological development of the types now living in our seas. Ample material for making this comparison is fortunately at hand; it is material of a peculiar kind, not easily obtained, and which thus far has not greatly attracted the attention of zoologists.

Interesting and important as are the earliest stages of embryonic development in the different classes of the animal kingdom, as bearing upon the history of the first appearance of any organ and its subsequent modifications, they throw but little light on the subject before us. What we need for our comparisons are the various stages of growth through which the young Sea-urchins of different families pass from the time they have practically become Sea-urchins until they have attained the stage which we now dignify with the name of species. Few embryologists have carried their investigations into the more extended field of the changes the embryo undergoes when it begins to be recognised as belonging to a special class, and when the knowledge of the specialist is absolutely needed to trace the bearing of the changes undergone, and to understand their full meaning. Fortunately the growth of the young Echini has been traced in a sufficient number of families to enable me to draw the parallelism between these various stages of growth and the palæontological stages in a very different manner from what is possible in other groups of the animal kingdom, where we are overwhelmed with the number of species, as in the Insects or Mollusks, or where the palæontological or the embryological terms of comparison are wanting or very imperfect.

Beginning with the palæontological history of the regular sea-urchins at the time of the Trias, when they constituted an unimportant group as compared with the Crinoids, we find the Echini of that time limited to representatives of two families. One of these, the genus *Cidaris*, has continued to exist, with slight modifications, up to the present time, and not less than one-tenth of all the known species of fossil Echini belong to this important genus, which in our tropical seas is still a prominent one. It is interesting here to note that in the *Cidaridæ* the modifications of the test are not striking, and the fossil genera appearing in the successive formations are distinguished by characters which often leave us in doubt as to the genus to which many species should be referred. In the genus *Rhabdocidaris*, which appears in the lower Jura, and which is mainly characterised by the extraordinary development of the radioles, we find the extreme of the variations of the spines in this family. From that time to the present day the most striking differences have existed in the shape of the spines, not only of closely allied genera, but even in specimens of the same species; differences which in some of the species of to-day are as great as in older geological periods. The oldest *Cidaridæ* are remarkable for their narrow poriferous zones. It is only in the Jura that they widen somewhat; subsequently the pores become conjugated, and only later, during the Cretaceous period, do we find the first traces of any ornamentation of the test (*Temnocidaris*) so marked at the present day in the genus *Goniocidaris*. As far, then, as the *Cidaridæ* are concerned, the modifications which take place from their earliest appearance are restricted to slight changes in the poriferous zone and in the ornamentation of the test, accompanied with great variability in the shape of the primary radioles. We must except from this statement the genera *Diplocidaris* and *Tetracidaris*, to which I shall refer again. The representatives of the other Triassic family become extinct in the lower tertiary. The oldest genus, *Hemicidaris*, undoubtedly represents the earliest deviations from the true *Cidaris* type; modifications which affect not only the poriferous zone, but the test, the actinal and the abactinal systems, while from the extent of these minor changes we can trace out the gradual development of some of the characteristics in families of the regular Echini now living. The genus *Hemicidaris* may be considered as a *Cidaris* in which the poriferous zone is narrow and undulating, in which the granules of the ambulacral system have become minute tubercles in the upper portion of the zone and small primary tubercles in its actinal region, in which many of the inter-ambulacral granules become small secondaries, in which the plates of the actinal system have become reduced in number, and the apical system has become a narrow ring, and finally, in which the primary radioles no longer assume the fantastic shapes so common among the *Cidaridæ*.

We can trace in this genus the origin of the modifications of the poriferous zone, leading us, on the one side, through genera with merely undulating lines of pores to more or less distinct confined arcs of pores, formed round the primary ambulacral tubercles, and, on the other, to the formation of open arcs of three or more pairs of pores. The first type culminates at the present day with the Arbaciadae, the other with the Diadematiadae, Triplechinidae, and Echinometradae. This specialisation very early takes place, for already in the lower Jura *Stomechinus* has assumed the principal characteristics of the Triplechinidae of to-day.

Although in *Hemicidaris* the number of the coronal plates has increased as compared with the *Cidaridae*, and while we find that in many genera, even of those of the present day, the number of the coronal plates is still comparatively small, yet, as a general rule, the more recent formations contain genera in which the increase in number of the interambulacral plates is accompanied by a corresponding decrease in the number of plates of the interambulacral area so characteristic thus far of the *Cidaridae* and *Hemicidaridae*, a change also affecting the size of the primary ambulacral tubercles. This increase in the number of the coronal plates is likewise accompanied by the development of irregular secondary and military tubercles, and the disappearance in this group of the granular tuberculation, so important a character in the *Cidaridae*. With the increase in the number of the interambulacral coronal plates, the *Pseudodiadematiadae* still retain prominent primary tubercles, recalling the earlier *Hemicidaridae* and *Cidaridae*, and, as in the *Cidaridae* proper, the test is frequently ornamented by deep pits or by ridges formed by the junction of adjoining tubercles. The genital ring becomes narrower, and the tendency to the specialisation of one of its plates, the madreporite, more and more marked.

With the appearance of *Stomechinus*, the *Echinidae* proper already assume in the Jura the open arcs of pores, the large number of coronal interambulacral plates, the specialisation of the secondary tubercles, and the large number of primary tubercles in each plate. With the appearance of *Sphærechinus* in the early Tertiary come in all the elements for the greater multiplication of the pairs of pores in the arcs of the poriferous zones, while the gigantic primary spines of some of the genera (*Heterocentrotus*), and the small number of primary tubercles are structural features which had completely disappeared in the group preceding the *Echinometradae*, to which they appear most closely allied.

Going back again to the *Hemicidaridae*, it requires but slight changes to pass from them to *Acrosalenia* and to the *Saleniæ* proper; the latter have continued to the present day, and have, like the *Cidaridae*, retained almost unchanged the characters of the genera which preceded them, combined however with a few *Cidaridian* and *Echinid* features which date back to the Triassic period. We can thus trace the modifications which have taken place in the poriferous zone, the apical and actinal systems, the coronal plates, the ambulacral and interambulacral tubercles, as well as in the radioles, and in the most direct manner possible indicate the origin of the peculiar combination of structural features which we find at any geological horizon. On taking in succession the modifications undergone by the different parts of the test, we can trace each one singly, without the endless complication of combinations which any attempt to trace the whole of any special generic combination would imply.

Leaving out of the question for the moment the *Palæchinidae*, we find no difficulty in tracing the history of the characters of the genera of the regular *Echini* which have existed from the time of the Trias and are now living, provided we take up each character independently. Nothing can be more direct than the gradual modification of the simple, barely undulating poriferous zone, made up of numerous ambulacral plates covered by granules, such as we find it among the *Cidaridae* of the Trias, first into the slightly undulating poriferous zone of the *Hemicidaridae*, next into the indistinct arcs of pores of the *Pseudodiadematiadae*, then into the arcs with a limited number of pores of the *Triplechinidae*, and finally to the polyporous arcs of the *Echinometradae*. What can be more direct than the gradual modification to be traced in the development of the primary ambulacral tubercles, such as are characteristic of the *Echinidae* of the present day, from their first appearance at the oral extremity of the ambulacral system of the *Hemicidaridae*, and the increase in the number of primary interambulacral tubercles, accompanied by the growth of secondaries and military, which we can trace in *Hemicidaris*, *Acrosalenia*, and *Stomechinus*—the

increase in number of the primary and secondary tubercles being accompanied by a reduction in the size of the radioles and a greater uniformity in their size and shape?

But while these modifications take place the original structural feature may be retained in an allied group. Thus the *Cidaridae* retain unchanged from the earliest time to the present day the few primary tubercles, the secondary granules, the simple poriferous zone, the imbricating actinal system, and the few coronal plates, with the large apical system and many-shaped radioles; while in the *Saleniæ* the primary interambulacral tubercles, the secondary granules, the radioles, the genital ring, are recognised features of the *Cidaridae*, associated, however, with an *Echinid* actinal and anal system, *Hemicidarid* primary ambulacral tubercles, and an *Echinid* poriferous zone. In the same way in the *Diadematiadae*, the large primary interambulacral tubercles are *Cidaridian* features, while the structure of the ambulacral tubercles is *Hemicidaridian*. The existence of two kinds of spines is another *Cidaridian* feature, while the apical and actinal systems have become modified in the same direction as that of the *Echinidae*. The more recent the genus the greater is the difficulty of tracing in a direct manner the origin of any one structural feature, owing to the difficulty of disassociating structural elements characteristic of genera which may be derived from totally different sources. This is particularly the case with genera having a great geological age. Many of them, especially among the *Spatangoids*, show affinities with genera following them in time, to be explained at present only on the supposition that when a structural feature has once made its appearance it may reappear subsequently apparently as a new creation, while in reality it is only its peculiar combination with structural features with which it had not before been associated (a new genus), which conceals in that instance the fact of its previous existence. A careful analysis, not only of the genera of the order, but sometimes of other orders which have preceded this combination in time, may often reveal the elements from which have been produced apparently unintelligible modifications.

There is, however, not one of the simple structural features in the few types of the Triassic and Liassic *Echini* from which we can so easily trace the origin of the structural features of all the subsequent *Echinid* genera, which do not also itself continued to the present day in some generic type of the present epoch, fully as well characterised as it was in the beginning. In fact, the very existence to-day of these early structural features seems to be as positive a proof of the unbroken systematic affinity between the *Echini* of our seas and those of the Trias as the uninterrupted existence of the genus *Pygaster* or *Cidaris* from the Trias down to the present epoch, or of the connection of many of the genera of the Chalk with those of our epoch (*Salenia*, *Cyphosoma*, *Psammechinus*, &c.).

Passing to the *Clypeastridae*, we find there, as among the *Desmosticha*, that the earliest type, *Pygaster*, has existed from the Trias to the present time; and that, while we can readily reconstruct, on embryological grounds, the modifications the earliest *Desmosticha*-like *Echini* should undergo in order to assume the structural features of *Pygaster*, yet the early periods in which the precursors of the *Echinoconidae* and *Clypeastridae* are found have thus far not produced the genera in which these modifications actually take place. But, starting from *Pygaster*, we naturally pass to *Holectypus*, to *Discoidea*, to *Conoclypus*, on the one side, while on the other, from *Holectypus* to *Echinocyamus*, *Sismondia*, *Fibularia*, and *Mortonia*, we have the natural sequence of the characters of the existing *Echinanthidae*, *Laganidae*, and *Scutellidae*, the greater number of which are characteristic of the present epoch. If we were to take in turn the changes undergone in the arrangement of the plates of the test, as we pass from *Pygaster* to *Holectypus*, to *Echinocyamus*, and the *Echinanthidae*, we should have in the genera which follow each other in the palæontological record an unbroken series showing exactly what these modifications have been. In the same way the modifications of the abactinal and anal systems, and those of the poriferous zone, can equally well be followed to *Echinocyamus*, and thence to the *Clypeastridae*; while a similar sequence in the modifications of these structural features can be followed from *Mortonia* to the *Scutellidae* of the present period.

Passing finally to the *Petalosticha*, we find no difficulty in tracing theoretically the modifications which our early *Echinoconidae* of the Liass should primarily undergo previous to the appearance of *Galeropygus*. The similarity of the early *Cassiduloid* and *Echinoconoid* types points to the same systematic

affinity, and perhaps even to a direct and not very distant relationship with the Palæchinidæ. For if we analyse the Echinourisæ of the present day, we find in genera like *Phormosoma* many structural features, such as the shape of the test, the character of the spines, the structure of the apical system, that of the poriferous zone, indicative of possible modifications in the direction of *Pygaster* or of *Galeropygus*, which have as yet not been taken into account.

Adopting for the *Petalosticha* the same method of tracing the modifications of single structural features in their palæontological succession, we trace the comparatively little modified palæontological history of the Echinoneidæ of the present day from the *Fyrina* of the lower Jura. This, in its turn, has been preceded by *Hyboclypus* and *Galeropygus*, while the Echinolampadæ of the present day date back, with but trifling modifications, to the Echinobrisus of the Lias, itself preceded by *Clypeus*; and they have been subject only to slight generic changes since that time, Echinobrisus being still extant, while such closely-allied genera as *Catopygus* and *Cassidulus* of the earlier Cretaceous are still represented at the present day; the modifications taking place in the actinal system, in the ambulacral zones of the Echinoneidæ and of the Echinolampadæ showing the closest possible systematic affinity in these families. Starting again from *Hyboclypus*, with its elongate apical system, we naturally pass to *Collyrites* and the strange *Dysasteridæ* forms which in their turn are closely allied to the *Holasteridæ*. From *Holaster* on the one side and from *Toxaster* on the other, we find an unbroken sequence of structural characters uniting the successive genera of *Holasteridæ*, such as *Cardiaster*, *Offaster*, *Stenonia*, *Ananchytes*, and *Asterostoma*, with *Paleopneustes*, *Homolampas*, and the *Pourtallesiæ* of the present day, while from the genera of the *Toxasteridæ* we naturally pass to the cretaceous *Hemiaster*; in this genus and the subsequent *Micraster* we find all the elements necessary for the modifications which appear in the *Spatanginæ* from the time of the Chalk to the present day. These modifications result in genera in which we trace the development of the fascioles, of the actinal, anal, and abactinal plastrons, of the beak, the formation of the petaloid ambulacra, first flush with the test, and little by little changed into marsupial pouches, the growth of the anterior groove and the manifold modifications of the ambulacral system in *Spatangus*, *Agassizia*, and *Echinocardium*, often recalling in some of its features structural characters of families which have preceded this in time.

Apparently in striking contrast with the Echini of the secondary period and those which have succeeded them stand the Palæozoic Echini; but when we have examined the embryology of Echini, we shall be better prepared to understand their structure and the affinities of the Palæchinidæ with the Echini of the present day, and their immediate predecessors.

Taking up now the embryological development of the several families which will form the basis of our comparisons, beginning with the *Cidaridæ*, we find that in the earliest stages they very soon assume the characters of the adult, the changes being limited to the development of the abactinal system, the increase in number of the coronal plates, and the modifications of the proportionally gigantic primary radioles.

In the *Diadematiidæ* the changes undergone by the young are limited to the gradual transformation of the embryonic spines to those which characterise the family, to the changes of the vertical row of pores in the ambulacral area into arcs of three or four pairs of pores, and to the specialisation of the actinal and abactinal systems.

In the *Arbaciidæ* the young stages are remarkable for the prominent sculpture of the test, for the flattened spines, for their simple poriferous zone, for their actinal system, and for their genital ring. The anal plates appear before the genital ring.

In the *Echinometradæ* the young thus far observed are characterised by the small number of their primary tubercles, the large size of the spines, the simple vertical row of pores, the closing of the anal ring by a single plate, and the turban-shaped outline of the test. Little by little the test loses with increasing age this *Cidaris*-like character; it reminds us, from the increase in the number of its plates, more of *Hemicidaris*; then, with their still greater increase, of the *Pseudodiadematiidæ*; and, finally, of the *Echinometradæ* proper. The spines, following *pari passu* the changes of the test, lose little by little their fantastic embryonic, or rather *Cidaris*-like appearance, and become more solid and shorter, till they finally assume the delicately fluted structure characteristic of the *Echinometradæ*. The vertical poriferous zone is first changed into a series of

connected vertical arcs, which become disjointed, and form, with increasing age, the independent arcs of pores, of three or more pairs of pores, of the *Echinometradæ*.

In the *Echinidæ* proper we find in the young stages the same unbroken vertical line of pores, which gradually becomes changed to the characteristic generic types. We find, as in the *Echinometradæ*, an anal system closed with a single plate, and an abactinal system separating in somewhat more advanced stages from the coronal plates of the test. This is as yet made up of a comparatively small number of plates, carrying but few large primary tubercles, with fantastically shaped spines entirely out of proportion to the test, but which, little by little, with the increase of the number of coronal plates, the addition of primary tubercles, and their proportional decrease in size, assume more and more the structure of the genus to which the young belongs. The original anal plate is gradually lost sight of from the increase in number of the plates covering the anal system, and it is only among the *Temnopleuridæ* that this anal plate remains more or less prominent in the adult. In the *Salenidæ*, of which we know as yet nothing of the development, this embryonic plate remains permanently a prominent structural feature of the apical system.<sup>1</sup>

Among the *Clypeastroids* the changes of form they undergo during growth are most instructive. We have in the young *Fibularinæ* an ovoid test, a small number of coronal plates surmounted by few and large primary tubercles, supporting proportionally equally large primary radioles, simple rectilinear poriferous zones, no petaloid ambulacra—in fact, scarcely one of the features we are accustomed to associate with the *Clypeastroids* is as yet prominently developed. But rapidly, with increasing size, the number of primary tubercles increases, the spines lose their disproportionate size, the pores of the abactinal region become crowded and elongate, and a rudimentary petal is formed. The test becomes more flattened, the coronal plates increase in number, and it would be impossible to recognise in the young *Echinocyamus*, for instance, the adult of the *Cidaris*-like or *Echinometra*-like stages of the Sea-urchin, had we not traced them step by step. Most interesting, also, is it to follow the migrations of the anal system, which, to a certain extent, may be said to retain the embryonic features of the early stages of all *Echinoderm* embryos, in being placed in more or less close proximity to the actinostome. What has taken place in the growth of the young *Echinocyamus* is practically repeated for all the families of *Clypeastroids*; a young *Echinarachnius*, or *Mellita*, or *Encope*, or a *Clypeaster* proper, resembles at first more an *Echinometra* than a *Clypeastroid*; they all have simple poriferous zones and spines and tubercles out of all proportion to the size of the test.<sup>2</sup>

When we come to the development of the *Spatangoids*, we find their younger stages also differing greatly from the adult. Among the *Nucleolidæ*, for instance, the young stages have as yet no petals, but only simple rectilinear poriferous zones. They are elliptical with a high test, with a single large primary tubercle for each plate, and a simple elliptical actinostome, without any trace of the typical bourrelets and phylloides so characteristic of this family. Very early, however, this condition of things is changed, the test soon becomes more flattened, the petals begin to form as they do in the *Clypeastroids*, and we can soon trace the rudiments of the peculiar bourrelets characteristic of the family, accompanied by a rapid increase in the number of tubercles and in that of the coronal plates.

Among the *Spatangidæ* some are remarkable in their adult condition for their labiate actinostome, for the great development of the petals, for the presence of fascioles surrounding certain definite areas, for the small size of the tubercles, the general uniformity in the spines of the test, and the specialisation of their anterior and posterior regions. On examining the young stages of this group of *Spatangoids*, not one of these structural features is as yet developed. The actinostome is simple, the poriferous zone has the same simple structure from the actinostome to the apex, the primary tubercles are large, few in number, surrounded by spines which would more readily pass as the spines of *Cidaridæ* than of *Spatangoids*. The fascioles are either very indistinctly indicated, or else the special lines have

<sup>1</sup> The young of the following genera have served as a basis for the preceding analysis of the embryonic stages of the *Desmoxidæ*: *Cidaris*, *Dorocidaris*, *Gonocidaris*, *Arbacia*, *Porocidaris*, *Strongylocentrotus*, *Stenometra*, *Echinus*, *Toxopneustes*, *Hippone*, *Temnopleurus*, *Temnopleurus*, and *Trigonocidaris*.

<sup>2</sup> Among the *Clypeastroids* I have examined the young of *Encope*, *Mellita*, *Fibularia*, *Mellita*, *Laganum*, *Echinarachnius*, *Encope*, *Clypeaster*, and *Echinanthus*.



not as yet made their appearance; the ambulacral suckers of the anterior zone are as large and prominent as those of the young stages of any of the regular Echini. It is only little by little, with advancing age, that we begin to see signs of the specialisation of the anterior and posterior parts of the test, that we find the characteristic anal or lateral fascioles making their appearance, only with increasing size that the spines lose their Cidarid-like appearance, that the petals begin to be formed, and that the simple actinostome develops a prominent posterior lobe. In the genus *Hemiaster*, the young stages are specially interesting, as long before the appearance of the petals, while the poriferous zone is still simple, the total separation of the bivium and of the trivium of the ambulacral system, so characteristic of the earliest Spatangoids (the *Dysasterinae*), is very apparent.<sup>1</sup>

From this rapid sketch of the changes of growth in the principal families of the recent Echini we can now indicate the transformations of a more general character through which the groups as a whole pass.

In the first place, while still in the *Pluteus* all the young Echini are remarkable for the small number of coronal plates, for the absence of any separation between the actinal and abactinal systems and the test proper. They all further agree in the large size of the primary spines of the test, whether it be the young of a *Cidaris*, an *Arbacia*, an *Echinus*, a *Clypeaster*, or a Spatangoid. They all in their youngest stages have simple vertical ambulacral zones; beyond this, we find as changes characteristic of some of the *Desmosticha*, the specialisation of the actinal system from the coronal plates, the formation of an anal system, the rapid increase in the number of the coronal plates, with a corresponding increase in the number of the spines and a proportional reduction of their size, the formation of an abactinal ring, and the change of the simple vertical poriferous zone into one composed of independent arcs.

In the Spatangoids and Clypeastroids we find common to both groups the shifting of the anal system to its definite place, the modifications of the abactinal part of the simple ambulacral system in order to become petaloid, and the gradual change of the elliptical ovoid test of the young to the characteristic generic test, accompanied by the rapid increase in the number of the primary tubercles and spines. Finally limited to the Spatangoids are the changes they undergo in the transformation of the simple actinostome to a labiate one, the specialisation of the anterior and posterior parts of the test, and the definite formation of the fascioles.

Comparing this embryonic development with the palæontological one, we find a remarkable similarity in both, and in a general way there seems to be a parallelism in the appearance of the fossil genera and the successive stages of the development of the Echini as we have traced it.

We find that the earlier regular Echini all have more or less a Cidarid-like look—that is, they are Echini with few coronal plates, large primary tubercles, with radioles of a corresponding size; that it is only somewhat later that the *Diademopsidæ* make their appearance, which, in their turn, correspond within certain limits to the modifications we have traced in the growth of the young *Diadematiidæ* and *Arbaciadæ*. The separation of the actinal system from the coronal plates has been effected. The poriferous zone has either become undulating, or forms somewhat indefinite open arcs; we find in all the genera of this group a larger number of coronal plates, more numerous primaries, the granules of the *Cidaridæ* replaced by secondaries and miliaries, and traces of a *Hemicidarid*-like stage in the size of the actinal ambulacral tubercles.

Comparing in the same way the palæontological development of the *Echinidæ* proper, we find that, on the whole, they agree well with the changes of growth we can still follow to-day in their representatives, and that, as we approach nearer the present epoch, the fossil genera more and more assume the structural features which we find developed last among the *Echinidæ* of the present day. Very much in the same manner as a young *Echinus* develops, they lose, little by little, first their *Cidarid* affinities, which become more and more indefinite, next their *Diadematiid* affinities, if I may so call the young stages to which they are most closely allied, and finally, with the increase in the number of the coronal plates, the great numerical development of the primary tubercles and spines, and that of the secondaries and miliaries which we can trace in the fossil Echini

of the Tertiaries, we pass insensibly into the generic types characteristic of the present day.

Although we know nothing of the embryology of the *Salenidæ*, yet, like the *Cidaridæ*, they have in a great measure remained a persistent type, the modifications of the group being all in the same direction as those noticed in the other *Desmosticha*; a greater number of coronal plates, the development of secondaries and miliaries combined with a specialisation of the actinal system not found in the *Cidaridæ*.

An examination of the succession of the *Echinoconidæ* shows but little modification from the earliest types; the changes, however, are similar to those undergone by the *Clypeastroids* and *Petalosticha*, though they do not extend to modifications of the poriferous zone, but are mainly changes in the actinostome and in the tuberculation. In fact, the group of *Echinoconidæ* seems to hold somewhat the same relation to the *Clypeastroids* which the *Salenidæ* hold to the *Cidaridæ*, and the earliest genus of the group *Pygaster* has remained, like *Cidaris*, a persistent type to the present day.

The earliest *Clypeastroids* are all forms which resemble the *Fibularina* and the genera following *Echinocyamus* and *Fibularia*; they are mainly characterised by the same changes which an *Echinarachnius* or a *Mellita*, for instance, undergoes as it passes from its *Echinocyamus* stage to the *Laganum* or *Encope* stage. The comparison is somewhat more complicated when we come to the Spatangoids. The comparison of the succession of genera in the different families, as traced in the *Desmosticha* and *Clypeastroids*, is made difficult from the persistency of the types preceding the *Echinoneidæ* and the *Ananchytidæ*, which have remained without important modifications from the time of the lower Cretaceous; previous to that time the modifications of the *Cassidulidæ* are found to agree with the changes which have been observed in the growth of *Echinolampas*. The early genera, like *Pygurus*, have many of the characteristics of the test of the young *Echinolampas*. The development of prominent bourrelets and of the floscelle and petals goes on side by side with that of genera in which the modification of the actinostome, of the test, and of the petals is far less rapid, one group retaining the *Echinoneus* features, the other culminating in the *Echinolampas* of the present day, and having likewise a persistent type, *Echinobrissus*, which has remained with its main structural features unchanged from the Jura to the present day. That is, we find genera of the *Cassidulidæ* which recall the early *Echinoneus* stage of *Echinolampas*, next the *Caratomus* stage, after which the floscelle, bourrelets, and petals of the group become more prominent features of the succeeding genera. Accompanying the persistent type *Echinobrissus*, genera appear in which either the bourrelets or petals have undergone modifications more extensive than those of the same parts in the genera of the *Echinoneus* or *Caratomus* type.

The earliest Spatangoids belong to the *Dysasteridæ*; apparently an aberrant group, but which, from the history of the young *Hemiaster*, we now know to be a strictly embryonic type, which, while it thus has affinities with the true Spatangoids, still retains features of the *Cassidulidæ* in the mode of development of the actinostome and of the petals, as well as of the anal system. The genera following this group, *Holaster* and *Toxaster*, can be well compared, the one to the young stages of *Spatangus* proper before the appearance of the petals, when the ambulacra are flush with the test, and when its test is more or less ovoid, the other to a somewhat more advanced stage, when the petals have made their appearance as semi-petals. In both cases the actinostome has the simple structure characteristic of all the young Spatangoids. The changes we notice in the genera which follow them lead in the one case through very slight modifications of the abactinal system, of the anterior and posterior extremities of the test, to the *Ananchytid*-like Spatangoids of the present day, the *Pourtalesidæ*, the genus *Holaster* itself persisting till well into the middle of the Tertiary period; while on the other side we readily recognise in the Spatangine which follow *Toxaster* (a persistent type which has continued as *Palæostoma* to the present day) the genera which correspond to the young stages of such Spatangoids as *Spatangus* and *Brissopeis* of the present day, genera which, on the one hand, lead from *Hemiaster* (itself still represented in the present epoch), through stages such as *Cyclaster*, *Peripneustes*, *Brisus*, and *Schizaster*, and, on the other, through *Micraster* and the like, to the Spatangoids, in which the development of the anal plastron and fasciole performs an important part, while in the former group the development of the peripetalous fasciole and of the lateral

<sup>1</sup> For this sketch of the embryology of the *Petalosticha* I have examined the young of *Echinolampas*, *Echinoneus*, *Echinocardium*, *Brissopeis*, *Agassizia*, *Spatangus*, *Brisus*, and *Hemiaster*.

fasciole can be followed. None of the genera of *Petalosticha* belonging to the other groups develop any fasciole in the sense of circumscribing a limited area of the test.

The comparison of the genera of *Echini* which have appeared since the Lias with the young stages of growth of the principal families of *Echini*, shows a most striking coincidence, amounting almost to identity, between the successive fossil genera and the various stages of growth. This identity can, however, not be traced exactly in the way in which it has usually been understood, while there undoubtedly exists in the genera which have appeared one after the other a gradual increase in certain families in the number of forms, and a constant approach in each succeeding formation, in the structure of the genera, to those of the present day. It is only in the accordance between some special points of structure of these genera and the young stages of the *Echini* of the present day that we can trace an agreement which, as we go further back in time, becomes more and more limited. We are either compelled to seek for the origin of many structural features in types of which we have no record, or else we must attempt to find them existing potentially in groups where we had as yet not succeeded in tracing them. The parallelism we have traced does not extend to the structure as a whole. What we find is the appearance among the fossil genera of certain structural features giving to the particular stages we are comparing their characteristic aspect. Thus, in the succession of the fossil genera, when a structural feature has once made its appearance, it may either remain as a persistent structure, or it may become gradually modified in the succeeding genera of the same family, or it may appear in another family, associated with other more marked structural features which completely overshadow it. Take, for instance, among the *Desmosticha* the modifications of the poriferous zone of the actinal and abactinal systems of the coronal plates, of the ambulacral and interambulacral systems, the changes in the relative proportion of the primary tubercles, and the development of the secondaries. These are all structural features which are modified independently one of the other; we may find simultaneous development of these features in parallel lines, but a very different degree of development of any special feature in separate families.

This is as plainly shown in the embryological as in the palæontological development. In the *Cidaridæ* there is the minimum of specialisation in these structural features. In the *Diademopsidæ* there is a greater range in the diversity of the structure of the poriferous zone and of the coronal plates, as well as of the actinal system. There is a still greater range among the *Echinidæ*, while among the *Saleniidæ* the modifications, as compared to those of the *Echinidæ* and *Diademopsidæ*, are somewhat limited again, being restricted as far as relates to the poriferous zone and coronal plates, but specialised as far as the actinal system is concerned, and specially important with reference to the structure of the apical system. The special lines in which these modifications take place produce, of course, all possible combinations, yet they give us the key to the sudden appearance, as it were, of structural features of which the relationship must be sought in very distantly related groups. It is to this speciality in the palæontological development that we must trace, for instance, the *Cidarid* affinities of the *Saleniæ*, their papillæ, the existence of few large primary interambulacral tubercles, the structure of their apical system, and their large genital plates; while it is to their affinities with the *Hemicidaridæ* that we must refer the presence of the few larger primary ambulacral tubercles at the base of the ambulacral area, and by their *Diademopsid* and *Echinid* affinities that we explain the indented imbricated actinal system with the presence of a few genuine miliaries. But all the structural features which characterise the earliest types of the *Desmosticha* can in reality be traced, only in a somewhat rudimentary form, even in the *Cidaridæ*. The slight undulation of the closely packed, nearly vertical poriferous zone is the forerunner of the poriferous zone first separated into vertical arcs and then into independent arcs. The limitation in the number of the rows of granules in the ambulacral zone, and their increase in size, is the first trace of the appearance of the somewhat larger primary ambulacral tubercles of the *Hemicidaridæ* and *Saleniæ*. The existence of the smooth cylindrical spines of the abactinal region of the test naturally leads to similar spines covering the whole test in the other families of the *Desmosticha*. The difference existing in the plates covering the actinal system from those of the coronal plates leads to the great distinction between the structure of the actinal system and of the coronal plates in some of the *Echinidæ*.

Passing to the *Clypeastridæ* and *Petalosticha*, we trace a parallelism of the same kind, and readily follow in the successive genera of fossil *Clypeastroids*, but often in widely separated genera, the precise modifications which the poriferous zone has undergone as it first becomes known to us in *Echinocyamus* and *Fibularia*, and as we find it in the most complicated petaloid stage of the *Clypeastroids* of the present day. We readily trace the changes the test undergoes from its comparatively ovoid and swollen shape to assume first that of the less gibbous forms, next that of the *Laganidæ*, and finally of the flat *Scutellidæ*; while we trace in the *Echinanthidæ* the persistent structural features of some of the earliest *Clypeastroids*, together with an excessive modification of the poriferous zone. Likewise for the *Echinoconidæ* we trace mainly the slight modifications of the poriferous zone and of the coronal plates, and finally, when we come to the *Spatangidæ* we find no difficulty in tracing from the most *Desmostichoid* of the *Spatangoid* genera the modifications of a test in which the ambulacral and interambulacral areas are made up of plates of nearly uniform size, in which the anterior and posterior extremities are barely specialised, to the most typical of the *Ananchytidæ*, in which the anterior and posterior extremities have developed the most opposite and extraordinary structural features. In a similar way we can trace among the fossil genera of different families the gradual development of the actinal plastron from its very earliest appearance as a modification of the posterior interambulacral area of the actinal side, or the growth of the posterior beak into an anal snout, the successive changes of the anal groove, the formation of the actinal labium, or the development of the bourrelets and phylloides from a simple circular actinostome, the gradual deepening of the slight anterior groove of some early *Spatangoid* to form the deeply sunken actinal groove. Equally well we can trace the modifications of the ambulacral system as it passes from the simple poriferous zones of the earlier *Spatangoid* genera in which the petaliferous portion makes its appearance, and finally becomes the specialised structure of our recent *Spatangoid* genera, such as *Schizaster*, *Moiræ*, and the like. Finally, we can trace to a certain extent the development of the fascioles on one side from genera like *Hemiaster*, in which the peripetalous fasciole is prominent, to genera like *Brissopsis*, *Brisus*, and the like, of the present day; on the other, perhaps, or both combined, the formation of a lateral and anal fasciole from genera like *Micraster* in *Spatangus* and *Agassizia*. Thus we must, on the same theory of the independent modifications of special structural features, trace the many and complicated affinities which so constantly strike us in making comparative studies, and which render it impossible for us to express the manifold affinities we notice, without taking up separately each special structure. Any attempt to take up a combination of characters, or a system of combinations, is sure to lead us to indefinite problems far beyond our power to grasp.

In the oldest fossil *Clypeastroids* and *Petalosticha*, as well as in the *Desmosticha*, we also find the potential expression of the greater number of the modifications subsequently carried out in genera of later date. The semipetaloid structure of some of the earlier genera of *Spatangoids*, the slight modifications of some of the plates of the actinal side near the actinostome, are the precursors, the one of the highly complicated petaloid ambulacra of the recent *Spatangoids*, the other of the actinal plastron, leading as it does also to the important differences subsequently developed in the anterior and posterior extremities of the test, as well as to the modifications which lead to the existence of a highly labiate actinostome. The appearance of a few miliaries near the actinostome constitutes the first rudimentary bourrelets.

Going back now to the *Palæchinidæ*, the earliest representatives of the *Echini* in palæozoic times, without any attempt to trace the descent of any special type from them, we may perhaps find some clue to the probable modifications of their principal structural features preparatory to their gradual disappearance. In the structure of the coronal plates, the specialisation of the actinal and abactinal systems, the conditions of the ambulacral system, we must compare them to stages in the embryonic development of our recent *Echini* with which we find no analogues in the fossil *Echini* of the Lias and the subsequent formations. In order to make our parallelism, we must go back to a stage in the embryonic history of the young *Echini* in which the distinction to be made between the ambulacral and interambulacral systems is very indefinite, in which the apical system is, it is true, specialised, but in which the actinal system remains practically a part

of the coronal system. But here the comparison ceases, and, although we can trace in the palaeontological development of such types as Archæocidaridæ or Bothriocidaridæ modifications which would lead us without great difficulty, on the one side to the Cidaridæ, and on the other to the Echinothuridæ and Diadematiidæ of the present day, we cannot fail to see most definite indications in some of the structural features of the Palæchinidæ of characteristics which we have been accustomed to associate with higher groups. The minute tuberculation, for instance, of the Clypeastroids and Spatangoids, already existing in the Melonitidæ, the genital ring, and anal system, are quite as much Echinid as Cidarid. The polyporus genera of the group represent to a certain extent the polyperi of the regular Echini, and the lapping of the actinal plates of the Cidaridæ and of the coronal plates in some of the Diadematiidæ, as well as the existence of such genera as Tetracidaridæ, of four interambulacral plates in *Astropygia*, and of a large number of ambulacral plates in some of the recent Echinometradæ, all these are Palæchinid characters which we can explain on the theory of the independent development of the structural features of which they are modifications. We should, however, remember, that the existence of a large number of coronal plates, especially interambulacral plates, in the Palæchinidæ, is a mere vegetative character, which they hold in common with all the Crinoids,—a character which is reduced to a minimum among the Holothurians, and still persists in full force among the Pentacrinidæ of the present day, as well as the *Astrophytidæ* and Echinidæ.

It would lead me too far to institute the same comparison between the embryonic stages of the different orders of Echinoderms and their earliest fossil representatives. We may, however, in a very general way, state that we know the earliest embryonic stages of the order of Echinoderms of to-day, which, with the exception of the Blastoidæ and Cystideans, are identical with the fossil orders, and that as far as we know they all begin at a stage where it would be impossible to distinguish a Sea-urchin from a Star-fish, or an Ophiuran, or a Crinoid, or an Holothurian,—a stage in which the test, calyx, abactinal and ambulacral systems are reduced to a minimum. From this identical origin there is developed at the present day, in a comparatively short period of time, either a Star-fish, a Sea-urchin, or a Crinoid; and if we have been able successfully to compare, in the development of typical structures, the embryonic stages of the young Echini with their development in the fossil genera, we may fairly assume that the same process is applicable when instituting the comparison within the different limits of the orders, but with the same restrictions. That is, if we wish to form some idea of the probable course of transformations which the earliest Echinoderms have undergone to lead us to those of the present day, we are justified in seeking for our earliest representatives of the orders such Echinoderms as resemble the early stages of our embryos, and in following, for them as for the Echini, the modifications of typical structures. These we shall have every reason to expect to find repeated in the fossils of later periods, and, going back a step further we may perhaps get an indefinite glimpse of that first Echinodermal stage which should combine the structural features common to all the earliest stages of our Echinoderm embryos.

And yet, among the fossil Echinoderms of the oldest periods, we have not as yet discovered this earliest type from which we could derive either the Star-fishes, Ophiurans, Sea-urchins, or Holothurians. With the exception of the latter, which we can leave out of the question at present, we find all the orders of Echinoderms appearing at the same time. But while this is the case, one of the groups attained in these earliest days a prominence which it gradually loses with the corresponding development of the Star-fishes, Ophiurans, and Sea-urchins, it has steadily declined in importance; it is a type of Crinoids, the Cystideans which culminated during Palæozoic times, and completely disappeared long before the present day. If we compare the early types of Cystideans to the typical embryonic Echinodermal type of the present day, we find they have a general resemblance, and that the Cystideans and Blastoids represent among the fossil Echinoderms the nearest approach we have yet discovered to this imaginary prototype of Echinoderms.

This may not seem a very satisfactory result to have attained. It certainly has been shown to be an impossibility to trace in the palæontological succession of the Echini anything like a sequence of genera. No direct filiation can be shown to exist, and yet the very existence of persistent types, not only among Echinoderms, but in every group of marine animals, genera which have

continued to exist without interruption from the earliest epochs at which they occur to the present day, would prove conclusively that at any rate some groups among the marine animals of the present day are the direct descendants of those of the earliest geological periods. When we come to types which have not continued as long, but yet which have extended through two or three great periods, we must likewise accord to their latest representatives a direct descent from the older. The very fact that the ocean basins date back to the earliest geological periods, and have afforded to the marine animals the conditions, most favourable to an unbroken continuity under slightly varying circumstances, probably accounts for the great range in time during which many genera of Echini have existed. If we examine the interlacing in the succession of the genera characteristic of later geological epochs, we find it an impossibility to deny their continuity from the time of the Lias to the present day. The Cidaridæ of the Lias and the Rhabdocidaridæ of the Jura are the ancestors of the Cidaridæ of to-day. The Salenidæ of the lower Chalk are those of the Salenidæ of to-day. *Acrosalenia* extends from the Lias to the lower Cretaceous, with a number of recent genera, which begin at the Eocene. The *Pygaster* of to-day dates back to the Lias; *Echinocyamus* and *Fibularia* commence with the Chalk. *Pyrina* extends from the lower Jura through the Eocene. The *Echinobrius* of to-day dates back to the Jura. *Holaster* lived from the lower Chalk to the Miocene, and the *Hemiaster* of to-day cannot be distinguished from the *Hemiaster* of the lower Cretaceous.

Such descent we can trace, and trace as confidently as we trace a part of the population of North America of to-day as the descendants of some portion of the population of the beginning of this century. [But we can go no further with confidence, and bold indeed would he be who would attempt even in a single State to trace the genealogy of the inhabitants from those of ten years before. We had better acknowledge our inability to go beyond a certain point; anything beyond the general parallelism I have attempted to trace, which in no way invalidates the other proposition, we must recognise as hopeless.]

But in spite of the limits which have been assigned to this general parallelism, it still remains an all-essential factor in elucidating the history of palæontological development, and its importance has but recently been fully appreciated. For, while the fossil remains may give us a strong presumptive evidence of the gradual passage of one type to another, we can only imagine this modification to take place by a process similar to that which brings about the modifications due to different stages of growth,—the former taking place in what may practically be considered as infinite time when compared to the short life history which has given us as it were a *résumé* of the palæontological development. We may well pause to reflect that in the two modes of development we find the same periods of rapid modifications occurring at certain stages of growth or of historic development, repeating in a different direction the same phases. Does it then pass the limits of analogy to assume that the changes we see taking place under our own eyes in a comparatively short space of time,—changes which extend from stages representing perhaps the original type of the group to their most complicated structures,—may, perhaps, in the larger field of palæontological development, not have required the infinite time we are in the habit of asking for them?

Palæontologists have not been slow in following out this suggestive track, and those who have been anatomists and embryologists besides have not only entered into most interesting speculations regarding the origin of certain groups, but they have carried on the process still further, and have given us genealogical trees where we may, in the twigs and branches and main limbs and trunk, trace the complete filiation of a group as we know it to-day, and as it must theoretically have existed at various times to its very beginning. While we cannot but admire the boldness and ingenuity of these speculations upon genetic connection so recklessly launched during the last fifteen years, we find that with but few exceptions there is little to recommend in reconstructions which shoot so wide of the facts as far as they are known, and seem so readily to ignore them. The moment we leave out of sight the actual succession of the fossils and the ascertainable facts of postembryonic development, to reconstruct our genealogy, we are building in the air. Ordinarily, the twigs of any genealogical tree have only a semblance of truth; they lead us to branchlets having but a slight trace of probability, to branches where the imagination plays an important part, to main

like where it is finally allowed full play, in order to solve with the trunk, to the satisfaction of the writer at least, the riddle of the origin of the group. It seems hardly credible that a school which boasts for its very creed a belief in nothing which is not warranted by common sense should descend to such trifling.

The time for genealogical trees is passed; its futility can, perhaps, best be shown by a simple calculation, which will point out at a glance what these scientific arboriculturists are attempting. Let us take, for instance, the ten most characteristic features of Echini. The number of possible combinations which can be produced from them is so great that it would take no less than twenty years, at the rate of one new combination a minute for ten hours a day, to pass them in review. Remembering now that each one of these points of structure is itself undergoing constant modifications, we may get some idea of the nature of the problem we are attempting to solve, when seeking to trace the genealogy as understood by the makers of genealogical trees. On the other hand, in spite of the millions of possible combinations which these ten characters may assume when affecting not simply a single combination, but all the combinations which might arise from their extending over several hundred species, we yet find that the combinations which actually exist—those which leave their traces as fossils—fall immensely short of the possible number. We have, as I have stated, not more than twenty-three hundred species actually representing for the Echini the results of these endless combinations. Is it astonishing, therefore, that we should fail to discover the sequence of the genera, even if the genera, as is so often the case, represent, as it were, fixed embryonic stages of some Sea-urchin of the present day? In fact, does not the very history of the fossils themselves show that we cannot expect this? Each fossil species, during its development, must have passed through stages analogous to those gone through by the Echini of the present day. Each one of these stages at every moment represents one of the possible combinations, and those which are actually preserved correspond only to the particular period and the special combination which any Sea-urchin has reached. These stages are the true missing links, which we can no more expect to find preserved than we can expect to find a record of the actual embryonic development of the species of the present day without direct observation at the time. The actual number of species in any one group must always fall far short of the possible number, and for this reason it is out of the question for us to attempt the solution of the problem of derivation, or to hope for any solution beyond one within the most indefinite limits of correctness. If, when we take one of the most limited of the groups of the animal kingdom, we find ourselves engaged in a hopeless task, what must be the prospect should we attack the problem of other classes or groups of the animal kingdom, where the species run into the thousands, while they number only tens in the case we have attempted to follow out? Shall we say "ignorabimus" or "impavidi progrediamus" valiantly to chase a phantom we can never hope to seize?

#### NOTES

THE Second International Geological Congress will be held at Bologna in September, 1881. It is proposed to award a prize of 5,000 francs for the best international scale of colours and conventional signs for the graphic representation of formations on geological maps and sections. Each scale should be accompanied by an explanatory memoir and a sufficient number of maps and sections relative to regions of different geological characters; for the memoirs the French language is recommended. The names of the competitors should be inclosed in sealed envelopes, on which should be a motto. The scales and memoirs should be addressed, before the end of May, 1881, to the President of the Committee, Signor J. Capellini, 65, Via Zamboni, Bologna.

"THE Official Guide and Handbook to Swansea and its District," prepared at the request of the Local Committee by Mr. S. C. Gamwell, is a really useful little work, which must prove of permanent value as a guide to Swansea. It contains much carefully compiled information on the History and Antiquities of Swansea, its literary and scientific, educational

and other institutions, industries, places of interest, in and around the town, geology of the district, paleontology, and natural history. A considerable amount of space is appropriately devoted to the scientific aspects of the district, the information given is very full, and we believe trustworthy. An excellent map is prefixed, and the work as a whole is creditable to the Local Committee and to the author.

ON Sunday a statue of Denis Papin was unveiled at Blois, where he was born in 1647.

THE late Mungo Ponton, W.S., Fellow of the Royal Society of Edinburgh, whose death was recently announced, was known as the discoverer of the peculiar effect of light on gelatine when treated with the bichromates, which was afterwards practically applied in the autotype process. He obtained the silver medal from the Royal Society of Edinburgh in 1838 for "model and description of improved electric telegraph." He was the first who employed the photographic method for registering automatically the fluctuations in thermometers and other instruments, and for this service he received also the silver medal of the same society in 1845. Several papers of his appeared in the new *Philosophical Journal* and in the *Quarterly Journal of Science*.

THE Fifth Annual General Meeting of the Mineralogical Society of Great Britain and Ireland was held at Swansea on August 27, Mr. Jas. S. Merry, F.C.S., in the chair. A favourable report was presented by the Council and adopted by the meeting. The election of the following new members was announced:—Dr. Jas. Hector, F.R.S., of New Zealand, Mr. Thos. Stewart of Glasgow, Rev. R. Graham, LL.D., of Errol, Perthshire; Mr. Jos. Gill of Leadhills, and Rev. Geo. Gordon, LL.D., of Elgin. The following papers were read and discussed:—"On the Chemical Formula of Epidote," by M. l'Abbé Renard; "On Certain Crystallised Furnace-products," by Wm. Terrill, F.C.S.; "On the Serpentine and Hornblende, and Schistose Rocks of Porthalla in Cornwall," by H. Collins.

ON the evening of July 20, about half-past eight o'clock, a remarkable meteor, said to have resembled a comet, apparently about twenty yards in length, was observed at Vizimgaum and other places in India, traversing the sky from south to north, and remaining visible for about three-quarters of a minute, during which time the whole sky and country were brilliantly illuminated. The meteor then burst, and some time afterwards a loud sound like distant thunder, which lasted two minutes, was heard.

THE rainfall in Southern China appears to have been abnormally large in the early part of this summer, for we learn from the *Daily Press* of Hongkong that the rainfall in that colony during the month of June was no less than 28'06 inches, compared with 11'32 inches in June, 1879, 15'36 inches in June, 1878, and 9'37 inches in June, 1877. It is stated that so large a rainfall as we have mentioned has never before been registered in Hongkong.

THE Government printer at Brisbane has published three valuable Reports, by Mr. Robert L. Jack, the Geological Surveyor of Northern Queensland, who during the last few years has done excellent service in the cause of both geography and geology in Cape York Peninsula. The first of these Reports deals with the geology and mineral resources of the district between Charters Towers gold-fields and the coast, and is illustrated with a map and several woodcuts taken from photographs, while the second is a preliminary Report on the geological features of part of the coast range between the Dalrymple and Charters Towers roads. The third Report treats of the important Bowen River coal-fields. This is accompanied by a map and some large and interesting woodcuts.

AT Caracas in Venezuela on August 1 there was a heavy shock of earthquake at 7 p.m.

THE United States Government proposes to hold an International Sanitary Congress at Washington in January, 1881.

THE Rev. A. E. Eaton has begun a series of Notes on the Entomology of Portugal in the *Entomologist's Monthly Magazine*.

IN No. 9, vol. xxxviii. of *Globus* an account of Dr. Potagos's travels in the regions of the Nile and Welle is given.

AMONG the articles in No. 2 of the *American Journal of Philology* (Macmillan and Co.) is one of considerable scientific interest—"Recent Investigations of Grimm's Law," by Mr. H. C. G. Brandt of Johns Hopkins University.

WE are requested by Lieut. Temple to publish the following letter addressed to him by Lieut. Col. Fr. Sejersted, Director of the Royal Norwegian Geographical Survey Office:—"Christiania, August 7, 1880.—Sir,—You may possibly have noticed that I have replied in some English newspapers to remarks stated in those papers to have been made by you at a meeting on the 19th of May last of the Society of Arts, with respect to our Norwegian coast charts, and that I have especially alleged that your remarks must have been caused by ignorance of the present stage of our coast charts. I now learn from a copy of the *Journal* of the Society of Arts, containing your paper complete, that the said newspaper statements were misleading extracts, and that your censure was not pointed against our coast charts, but against an English belabouring of those charts in no way connected with the geographical survey of Norway. As a matter of course my reply would not have been published if the said newspaper statements had been correct concerning the main point to us, and I hereby declare with great pleasure that the copy of the *Journal* of the Society of Arts, containing your paper, proves plainly that you are intimately acquainted with our coast charts and coast descriptions, which are mentioned by you in a very satisfactory manner to us. I express my wish that these lines may help to make good the injustice you have suffered from the misconceptions caused by the ambiguous newspaper statements, and I beg to leave it to you to use this letter at pleasure."

THE additions to the Zoological Society's Gardens during the past week include a Macaque Monkey (*Macacus cynomolgus*) from India, presented by Mr. Geo. G. Turner; two American Moorhens (*Gallinula galeata*) from America, presented by Mr. G. H. Hawtayne, C.M.Z.S.; a Turnstone (*Streptopus interpres*), captured at sea, off the Azores, presented by Capt. A. McRitchie, s.s. *Utopia*; two Koodoos (*Strepsiceros kudu*) from Africa, a Harnessed Antelope (*Tragelaphus scriptus*) from Gambia, a Syrian Fennec Fox (*Canis famelicus*) from North Africa, a King Vulture (*Cypagus papa*) from Tropical America, deposited; a Nylghaie (*Boselaphus pictus*) from India, a Michie's Tufted Deer (*Elaphodus michianus*) from China, a Cuvier's Toucan (*Ramphastos cuvieri*) from the Upper Amazons, purchased.

SOCIETIES AND ACADEMIES

PARIS

Academy of Sciences, August 16.—M. Wurtz in the chair.—The following papers were read:—Summary report of the cruise of *Le Travailleur* (continued), by M. Alph. Milne-Edwards. He describes the various animal species obtained.—On the establishment of hospital stations in Equatorial Africa, by M. de Lesseps. This reports the progress of Capt. Bloyet in the East (who reached Usagara on July 2) and M. de Brazza in the West (who is seeking a suitable position on one of the affluents of the Ogowé).—On the embryos accompanying cysticerci in pork, by M. Poincaré. Pork may contain microscopic germs of *Tenia* which may quite escape ordinary inspection. Raw meat of any kind should be avoided.—On some formulae relative to hypergeometric functions of two variables, by M.

Appell.—On various attempts at demonstration of the theorem of Fermat, by M. Pépin.—Observation on a group of lines in the solar spectrum, by M. Thollon. With the centre of the solar image, on his apparatus (on a mountain near Nice) he notes four lines, *a, b, c, d*, of which *a* and *b* are close to each other, and similarly *c* and *d*; *b* and *c* are of iron, *a* and *d* are telluric. On directing the apparatus to the two ends of the equatorial diameter, the iron lines are displaced relatively to the others, conformably to theory.—On the cause of variations of fixed points in thermometers, by M. Crafts. He describes experiments which reduce to *nil*, or a very small amount, the *role* of pressure in permanent elevation of the zero point. Glass blown at the lamp and long exposed to heat diminishes in volume through interior work.—On rapid alcoholic fermentation, by M. Boussingault. This relates to fermentation in a liquid that is boiling under a pressure so weak that the heat does not alter the organism of the ferment, while yet it is sufficient to expel the alcohol and the carbonic acid: Glycerine appears during this rapid fermentation.—Spectral examination of thulium, by M. Thalén.—On the absorption-spectra of metals forming part of the groups of yttria and of cerite, by M. Soret.—On erbium, by M. Clève. The atomic weight of the metal he finds to be 166 (ytterbium 173).—Measurement of the intensity of some dark lines of the solar spectrum, by M. Gouy. His method shows clearly the telluric nature of the group B (between 6866 and 6880), by reason of their greater intensity.—On polar electricity in hemihedric crystals with inclined faces, by MM. Jacques and Curie. They show that in all the non-conducting substances studied the direction of the electric poles is connected with the position of the hemihedric facettes. M. Thenard recalled experiments bearing on the subject made by his son fifteen years ago.—New results of utilisation of solar heat obtained at Paris, by M. Pifre. He succeeds in utilising 80 per cent. of the solar heat as against 50 (Mouchot). The reflector is made of three truncated cones, so that the generating line is a broken one. The focus is thus concentrated in much less length, and the height of the boiler may be diminished one half (without increasing its diameter). When the sky is clear the boiling of fifty litres is obtained in less than forty minutes, and the pressure rises 1 atm. every seven or eight minutes. The steam-engine is specially adapted for solar receivers.—Production of crystals of sesquichloride of chromium of persistent green colour, by M. Mengeot.—On the inconveniences presented, with regard to physiological reactions, in cases of poisoning with morphine, by the substitution of amylic alcohol for ether in the process of Stas, by MM. Bergeron and L'Hôte.—On the experiment of the great cervical sympathetic, by MM. Dastre and Morat. They demonstrate the existence of vaso-dilator as well as vaso-constrictor nerves in the cervical sympathetic.—Morphological signification of the appendices serving for suspension of chrysalides, by M. Künckel. They are (in Lepidoptera) hooks of membranous anal legs modified and adapted to special biological conditions.—On a new station of the age of stone at Hanawah, near Tyre (Syria), by M. Lortet. Myriads of flints (of very primitive form), along with numerous fragments of bone and teeth, were found in a kind of conglomerate or breccia.—On the falling stars of August 9, 10, and 11, 1880, by M. Chapelas. The mean horary number is only 53.7, making a difference of 69.3 with that last year. This seems to limit the return of the maximum of August between 1848 and 1879, giving a period of thirty-two or thirty-three years, quite like that of the phenomenon of November 12 and 13.

CONTENTS

PAGE

THE CRUISE OF THE "KNIGHT ERRANT." By SIR C. WYVILLE THOMSON, F.R.S. . . . . .	405
LETTERS TO THE EDITOR:—	
A Fragment of Primeval Europe.—THE DUKE OF ARCVLL . . . . .	407
New Red Star.—JOHN BIRMINGHAM . . . . .	408
Locusts and Coffee Trees.—DR. A. ERNST . . . . .	408
Intellect in Brutes.—L. P. GRATACAP . . . . .	408
THUNDERSTORMS. III. By Prof. TAIT . . . . .	408
THE BRITISH ASSOCIATION . . . . .	410
Section A.—Mathematics and Physics.—Opening Address by Prof. W. Grylls Adams, M.A., F.R.S., President of the Section . . . . .	411
Section D.—Biology.—Department of Anatomy and Physiology.—Address by F. M. Balfour, M.A., F.R.S., Vice-President of the Section . . . . .	417
Department of Anthropology.—Address by F. W. Rudler, F.G.S., Vice-President of the Section . . . . .	420
PALÆONTOLOGICAL AND EMBRYOLOGICAL DEVELOPMENT. By Prof. ALEXANDER AGASSIZ . . . . .	424
NOTES . . . . .	431
SOCIETIES AND ACADEMIES . . . . .	432

THURSDAY, SEPTEMBER, 9, 1880

## ENGLISH AND AMERICAN BEE-KEEPING

*The Bee-Keeper's Manual; or, the Honey Bee, its Management and Preservation.* With a Description of the most Approved Hives and other Appliances of the Apiary. By the late Henry Taylor. Seventh Edition, modernised and very greatly enlarged by Alfred Watts. (London: Groombridge and Sons, 1880.)

*British Bee-Farming, its Profits and Pleasures.* By James F. Robinson. (London: Chapman and Hall, 1880.)

*Manual of the Apiary.* By A. J. Cook, Professor of Entomology in the Michigan State Agricultural College. Fifth Edition, revised, enlarged, mostly re-written, and beautifully illustrated. (Chicago, Illinois: Thomas G. Newman and Son, 1880.)

MR. WATTS' edition of Taylor's "Bee-Keeper's Manual" has been so copiously revised and added to that it is really a new work, embodying all the most recent discoveries and improvements in apiarian practice. For the amateur bee-keeper—as distinguished from the scientific student of bees on the one hand, and the mere honey manufacturer on the other—this volume is a most admirable guide. It is simple in arrangement, very clear in its descriptions, and copiously illustrated by really good woodcuts of every portion of the extensive apparatus used by the modern amateur. Commencing with a short account of the different kinds of honey-bee, and the main facts of its life-history, we are soon introduced to the mode of keeping bees, beginning with the old-fashioned straw hive, and successively pointing out the various improvements that have been effected. We then come to the different kinds of box, frame, and observatory hives, and the various systems of bee-management, all of which are explained and illustrated in the clearest and most intelligible manner. The latter half of the volume is devoted to a detailed account of the summer, autumn, winter, and spring management of bees; and this part is so full and so carefully written that it will prove of the greatest service to all young bee-keepers.

Mr. Watts does not seem quite so confident as most apiarians of the superior qualities of the Ligurian over the common bee. He quotes, as "worthy of the most careful consideration from those interested in the subject," a statement that the former rob the latter of their honey, and that they are also far more liable to disease. The writer—a Scotchman who has closely studied the habits of bees—says:—

"All Ligurian fanciers claim for them that they work in wet or dry earlier and later than do the blacks. Now any one can see that as soon as there is honey in the flower, so soon will the black bee go for it, and so long as there is honey so long will the black remain gathering it. Since the Ligurian can no more make honey than the black, and since it finds honey after the blacks have failed, it must obtain it from some other source than the flowers. Ligurian bee-keepers tell me—and I see no reason to doubt the statement—that the Ligurian thrives amazingly for a time where plenty of black bees are kept, and that nearly in the same proportion to the number of black hives within reach, so will be the honey-producing powers

of the Ligurian. I have often seen them coming out of the black hives, and certainly they were not helping the blacks, because in nearly exact proportion as they increased in weight the blacks decreased; and this transfer of the honey is not always accompanied with fighting, the Ligurians having what all successful pilferers generally have—viz. the knack of introducing themselves unchallenged anywhere if what is wanted is to be had."

"British Bee-Farming" is a most excellent and practical work, written in the simplest style, and giving excellent directions to those who wish to keep bees for profit. We have seldom seen a book from which a beginner can obtain such exact information on all the necessary details of bee-management. Mr. Robinson strongly recommends a simple form of bar-hive, which he calls "the bee-farmer's hive," and which is figured so clearly that any village carpenter can make it; and by the use of this, and his equally simple and efficient "bee-farmer's honey extractor," he shows how a constant supply of pure honey can be obtained, week by week, without interfering with the bees' work or destroying any of the comb, the replacement of which in a small hive necessitates the consumption by the bees of twenty pounds of honey. A good deal of miscellaneous information on bees and bee-keeping is given in the second part of the work, but its chief value is that it well justifies its title, by showing in the briefest and clearest manner how bees may become a source of considerable profit as well as a continual pleasure.

Prof. Cook's volume differs considerably from the preceding, and indeed from any other English work on the subject, in its combination of science with utilitarianism, while the amateur pure and simple is hardly recognised at all. More than one-third of the book is devoted to an account of the natural history of the bee, its place in the animal kingdom, its anatomy, physiology, habits, and economy. Then follow the chapters on bee-keeping proper; and the author here addresses himself almost exclusively to those who make bee-keeping a business, and we are led to understand how much this branch of industry is advancing in America, where honey is now being manufactured on almost as large a scale as corn. An article in the *Times* last year informed us that a single bee-farm has 12,000 swarms, and keeps two steam-saws and nine men at work for five weeks in cutting up the timber for the 72,000 boxes in which the honey is packed for exportation. Prof. Cook accordingly has a chapter on "Marketing Honey," and instructs his readers in the art of "invigorating the market," "tempting the consumer," and other mercantile details; and throughout the book we find constant indications that bee-keeping is looked upon as a business rather than a hobby, and that in all its details economy of labour and materials must be studied, and all processes judged by the test of the maximum of production at a minimum of cost. A few extracts will give an idea of the style of the book.

After stating that a queen bee will often lay two or three thousand eggs a day, he remarks that this is nothing to the queen white ant, which lays 80,000 eggs a day, adding:—

"This poor helpless thing, whose abdomen is the size of a man's thumb, and composed almost wholly of eggs, while the rest of her body is not larger than the same in our common ants, has no other amusements; she cannot

walk; she cannot even feed herself or care for her eggs. What wonder then that she should attempt big things in the way of egg-laying? She has nothing else to do, or to feel proud of.

In the account of the formation of the comb the "pressure" theory is very properly rejected, but no reference is made to the complete explanation of the process given by Darwin, Waterhouse, and others. The mathematical accuracy of the cell is however disproved by the observations of Prof. Wyman, who showed by actual measurement that none of them were perfect hexagons, but that they varied in size, sometimes to the amount of one cell's width in ten, and commonly to half this amount. The rhombic bases of the cells also vary, and as this variation occurs gradually in passing from one part of the comb to another, it follows that whenever this happens the cells must diverge from the true hexagonal form. The supposed mathematical instinct of the bee has therefore no foundation to rest upon, and the beautiful explanation given by Mr. Darwin fully meets the actual facts.

An interesting chapter is devoted to "Honey Plants," the principal species from which the bees obtain their honey in America being figured. In the more northern States fruit-trees, willows, and sugar-maples, with bass-wood and white clover, are the most productive plants, while on the western prairies the thousands of acres of asters, solidagos, and eupatoriums afford an inexhaustible supply of honey not yet appropriated.

The illustrations of this book are often rude, and sometimes inaccurate. The honey-extractor (at p. 189) is described as acting by centrifugal force, but it is drawn square, and the comb so placed in it that it could not possibly revolve; while, at p. 128, the bottom-board described as having a bevelled notch for an opening to the hive, is shown with a triangular projection, owing to bad perspective in the drawing. These, however, are small faults; and the English bee-keeper will no doubt obtain many useful hints from this excellent little manual of bee-culture as practised by our ingenious and energetic cousins across the Atlantic.

A. R. W.

#### BOOK SHELF

*Rainfall of the East Indian Archipelago; First Year, 1879.* By Dr. P. A. Bergsma, Director of the Batavia Observatory. (Batavia: At the Government Printing Office, 1880.)

AN extremely valuable system of rainfall observation has been established in the East Indian Archipelago under the superintendence of Dr. Bergsma, the well-known director of the Batavia Observatory, and the results of the first year's observations for 1879 are now before us in this octavo volume of 257 pages.

In the beginning of 1879 sixty rain-gauges were in operation, and by the end of the year the number had increased to 125. To these it is proposed to add other seventy new stations during 1880, thus raising the number of stations for the observation of the rainfall of the East Indian Archipelago to 195. Towards the securing of uniformity the same pattern of rain-gauge is used by all the observers, and the gauges are placed at the same height of 3½ feet above the ground; but greater uniformity in the hour of observing, which is any hour from 6 to 9 a.m., is a desideratum. The stations extend from 95° 20' to 29° 53' E. long., and from 5° 53' N. lat. to 10° 10' S. lat., and as regards elevation they are at heights varying from the level of the sea to a height of 6,404 feet. Their

distribution among the islands is 76 on Java, 25 on Sumatra, 7 on Borneo, 4 on Celebes, and 4 on Billiton, 3 on Madeira, and 1 on each of the islands Riouw, Bangka, Ternate, Amboina, Banda, and Timor.

The daily rainfalls at each of the 125 stations during 1879, so far as observed, are printed *in extenso*, and a table is added showing the amounts and days of rainfall for each month and for the year. The largest rainfall for one day was 11·81 inches at Amboina on July 13; and it may be remarked that at the same place on the four days ending the 15th of the same month, 29·45 inches fell. The least annual rainfall at any station was 53·27 inches at Kotta Radja, and the largest 282·33 inches at Padang Pandjang. Of the 59 stations for which there are returns for the whole year, the amount exceeded 100 inches at 33, and 200 inches at 5 of the stations. The greatest number of days on which rain fell at any station was 274 at Sockawana, and the least 136 at Onrust. It is evident that this system of observation will by and by lay before us the observational data for the determination of the distribution of the important element of the rainfall, horizontally and vertically, over the land surfaces of this portion of the globe which excites so strongly the interest of the biologist, geologist, and geographer.

*Botanische Jahrbücher für Systematik, Pflanzengeschichte und Pflanzengeographie.* Herausgegeben von A. Engler. Erster Band, Heft i. ii. (Leipzig: Verlag von Wilhelm Engelmann, 1880.)

IT is a question whether German serials devoted in part or wholly to botanical bibliography are not becoming too numerous, but, be that as it may, this new venture is so circumscribed in its scope that it recommends itself to a large section of botanists in this country whose labours are to a great extent within its scope. Engler's "Botanische Jahrbücher" are to be exclusively devoted to systematical, historical, and geographical botany, and will contain original articles, in English, French, or German, as well as a review of current literature. Under Dr. Engler's painstaking editorship we think success should attend the undertaking. The parts are not to appear at fixed intervals, nor necessarily to be uniform in size; but the limit of the interval is from three to six months, and of the size three to four sheets. The contributors to the first part are:—Oswald Heer, on the history of the ginkgo-like trees; Alphonse de Candolle, on some points of botanical nomenclature; Eug. Warming, on the results of recent investigations of the flora of Greenland; O. Beccari, on the phytogeography of the Malayan Peninsula; A. Engler, diagnoses of some new *Burseracea* and *Anacardiacea*, and a review of the more important botanical works published in 1879. It should be mentioned that the contributions of A. de Candolle and O. Beccari are abstracts of and extracts from what has appeared elsewhere, though this fact does not diminish their value. On the contrary, they are thus brought to the knowledge of many who would otherwise not have an opportunity of reading them.

W. B. HEMSLEY

#### LETTERS TO THE EDITOR

[The Editor does not hold himself responsible for opinions expressed by his correspondents. Neither can he undertake to return, or to correspond with the writers of, rejected manuscripts. No notice is taken of anonymous communications.]

[The Editor urgently requests correspondents to keep their letters as short as possible. The pressure on his space is so great that it is impossible otherwise to ensure the appearance even of communications containing interesting and novel facts.]

The Conditions Necessary for the Existence of Matter in the Liquid State—Existence of Ice at High Temperatures

NUMEROUS experiments which I have made during the last few weeks on the boiling points of substances under low pres-

tures, the details of which will shortly be published, have led to the following conclusions in reference to the conditions necessary for the existence of any substance in the liquid state. These are two in number, viz. :—

1. In order to convert a gas into a liquid the *temperature* must be *below* a certain point (termed by Andrews the *critical temperature* of the substance), otherwise no amount of pressure is capable of liquefying the gas.

2. In order to convert a solid into a liquid the *pressure* must be *above* a certain point, which I propose to call the *critical pressure* of the substance, otherwise no amount of heat will melt the substance.

If the second of the above conditions be true, it follows that if the necessary temperature be attained, the liquefaction of the substance depends solely on the superincumbent pressure; so that if by any means we can keep the pressure on the substance below its critical pressure, no amount of heat will liquefy it, for in this case the solid substance passes directly into the state of gas, or in other words it sublimates without previous melting.

Having come to this conclusion, it was easily foreseen that if these ideas were correct it would be possible to have *solid ice at temperatures far above the ordinary melting-point*. After several unsuccessful attempts, I was so fortunate as to attain the most perfect success, and have obtained solid ice at temperatures so high that it was impossible to touch it without burning one's self. This result has been obtained many times and with the greatest ease, and not only so, but on one occasion a small quantity of water has frozen in a glass vessel which was so hot that it could not be touched by the hand without burning it. I have had ice a considerable length of time at temperatures far above the ordinary boiling-point, and even then it only sublimed away without any previous melting. These results were obtained by *maintaining* the superincumbent pressure below 4.6 mm. of mercury; *i.e.*, the tension of aqueous vapour at the freezing-point of water. Other substances also exhibit these same phenomena, the most notable of which is mercuric chloride, for which latter the pressure need only be reduced to about 420 mm. On letting in the pressure the substance at once liquefies.

For the success of these experiments in the case of water one or two details of manipulation are necessary, but these will be subsequently described.

THOS. CARNELLEY

Firth College, Sheffield, September 6

#### A Doubtful British Mollusk

I HAVE just observed that I am quoted in Dr. Gwyn Jeffreys' "British Conchology" (vol. v. p. 161) as an authority for the discovery of *Clausilia parvula* (a Continental snail) in Staffordshire. Many years ago, when I was a schoolboy, I found six or seven specimens at Kinver, near Stourbridge. I took them at first for a smooth variety of *C. rugosa*, but noting other differences sent them to Dr. Jeffreys, who identified them as above. I never had another opportunity of visiting the spot, but brother conchologists, who went on my recommendation, failed to find any specimens. The sheep-walk on which I picked them up was close to the grounds of Enville, where there are many foreign shrubs, and I have now little doubt that they were introduced. At the same time the large size of the specimens seemed to indicate that they had been long acclimatised, as northern individuals are larger than southern.

GRANT ALLEN

Broad Street, Lyme Regis, Dorset

#### A Halo

MAY I mention a strange appearance which I saw in the heavens on August 29, and ask for an explanation of it? It was a rainbow without rain, and in the same quarter of the heavens as the sun.

At 5.45 p.m. I observed in a little nearly circular opening in the clouds, at the same height above the horizon as the sun, and about 23° to the north of it, all the colours of the rainbow. They were very vivid, and lasted for several minutes. Two persons who were with me also saw this strange sight, which I cannot account for in any way. Was it seen by any of your readers? And what could be the cause of it?

L. SOAMES

Brighton, September 2

[This was probably a portion of the ordinary halo of 22°. If so, it indicates the presence of ice-crystals (not of drops of water) in the upper atmosphere. Such things are common enough in autumn, especially when there is a sudden lowering of temperature by an anticyclone.—E.D.]

#### Tone of Violins

I SAW a little time back, but omitted to note it at the time, a brief notice of some German experiments showing that the strings of good old instruments of fine tone tended far more than in the case of inferior violins to vibrate in closed curves or simple curves. I have searched NATURE in vain for some weeks, but cannot find it, though I thought it was in these columns. I am particularly anxious to recover it for purposes of my own connected with another branch of physics, and shall be obliged if any reader can refer me to the notice, or to the paper, or any translation of it.

LEWIS WRIGHT

August 30

#### ADOLPH EDOUARD GRUBE

BY the sudden death of Prof. Grube of Breslau on June 23, zoological science has been deprived of one of its enthusiastic and veteran cultivators. Born in Königsberg on May 12, 1812, he entered the university of that city in 1831, and graduated in medicine in 1837. Thereafter he became a private lecturer on zoology in Königsberg. In 1844 he was appointed to the Professorship of Zoology in the University of Dorpat, and lastly was transferred, in 1857, to a similar post in the University of Breslau, where he laboured till his death.

He chose for the subject of his inaugural dissertation (in 1837) the structure of *Pleione carunculata*, Pallas, and it is interesting that at this early age he selected one of the group in which his chief work in after-life was accomplished; for though he published various valuable researches in other departments (*e.g.*, those on the Branchiopod Crustaceans), still the Annelida most benefited by his labours during the subsequent forty-three years. Moreover, he observed so carefully, as well as laboured so industriously, that he was *facile princeps* in the department at his death. The bare enumeration indeed of his zoological works and papers is formidable; and their perusal bears imperishable witness to the well-directed energy and great ability of their author. He himself, with great modesty, used to state that his work fell far short of that of the late M. Claparède, who, with a delicate physique, nevertheless accomplished a marvellous amount of valuable work, both with pen and pencil. But though perhaps less of an artist than the talented Swiss, the greater tenacity of constitution in the stalwart German, combined with his indomitable energy and perseverance throughout a longer life, enabled him to overtake a much greater amount of work, especially in descriptive zoology.

The conscientious manner in which he carried on his scientific labours is well shown in his "Familien der Anneliden" (1851), a work which even now is of great value, and indispensable to workers in the department. The same may be said of his "Entwicklung der Anneliden" (1844) and his "Annulata Cærestiana" (1857). In his original papers in the *Archiv für Naturgeschichte* and in the recent admirable series in the *Sitzung der Schlesischen Gesellschaft*, on the families of the Annelida, he demonstrated the encyclopædian and critical knowledge which he had of the whole group in a remarkable manner, just as his "Bemerkungen über Anneliden der Pariser Museums" showed his great experience in discriminating the species described by others. His last large publication (a work of 300 pp., 4to, and fifteen fine plates by his tried assistant Assman) is devoted to the numerous Philippine annelids collected by Prof. Semper, and is a lasting memorial of his accuracy and patient industry.

Nor was he a zoologist who confined his researches to a single group. He was an accomplished carcinologist, and his faunistic treatises, *e.g.*, his "Actinien, Echinodermen u. Würmer des Adriatischen u. Mittelmeers," his "Ausflug nach Triest u. dem Quarnero," as well as his special papers on the Echinodermata, on *Peripatus* and other Arthropods, testify abundantly to the breadth



of his information and his unwearied efforts to advance zoological science. He was no less a thoughtful student of the labours of others than a discoverer of new forms and an accurate original inquirer.

To one who had worked at the fauna of Siberia, at the collections made during the Novara expedition and those of the German exploring ship *Gazelle*, at the varied stores in the "Museum Godeffroy" of Hamburg, who had made himself familiar with the shores of the Adriatic and the Mediterranean, as well as those of France and Britain, the splendid zoological series made by H.M.S. *Challenger*, under the direction of Sir Wyville Thomson and his colleagues, could not but prove an irresistible attraction; and it was this which tempted him more than anything else to make his last visit to this country in 1876, when he attended the Meeting of the British Association in Glasgow.

Privately Prof. Grube was one of the most amiable and accomplished of men. Of commanding presence (he was a cuirassier in his youth), and frank and manly bearing, his fund of general information, his musical tastes, and great geniality, endeared him to all his friends. Nor was he less beloved as a teacher by his students. Full of life and work, and with an industry that never seemed to flag, he was suddenly cut off in the midst of his labours, and just as he was organising fresh researches.

A full biography of Prof. Grube will appear in the *Leopoldina* in Halle, but, meanwhile, it is well to indicate in this country the sense of the great loss which zoological science has sustained by the death of this eminent investigator and teacher. W. C. M.

### THUNDERSTORMS<sup>1</sup>

#### IV.

**A**LMOST all the facts to which I have now adverted point to water-substance, in some of its many forms, as at least one of the chief agents in thunderstorms. And when we think of other tremendous phenomena which are undoubtedly due to water, we shall have the less difficulty in believing it to be capable of producing thunderstorms also.

First of all let us think of some of the more obvious physical consequences of a fall of a mere tenth of an inch of rain. Suppose it to fall from the lowest mile of the atmosphere. An inch of rain is 5 lb. of water per square foot, and gives out on being condensed from vapour approximately 3,000 units of heat on the centigrade scale. The mass of the mile-high column of air a square foot in section is about 360 lb., and its specific heat about a quarter. Thus its temperature throughout would be raised by about 33° C., or 60° F. For one-tenth inch of rain, therefore, we should have a rise of temperature of the lowest mile of the atmosphere amounting to 3·3° C., quite enough to produce a very powerful ascending current. As the air ascends and expands it cools, and more vapour is precipitated, so that the ascending current is farther accelerated. The heat developed over one square foot of the earth's surface under these conditions is equivalent to work at the rate of a horse-power for twelve minutes. Over a square mile this would be ten million horse-power for half an hour. A fall of one-tenth of an inch of rain over the whole of Britain gives heat equivalent to the work of a million millions of horses for half an hour! Numbers like these are altogether beyond the limits of our understanding. They enable us, however, to see the full explanation of the energy of the most violent hurricanes in the simplest physical concomitants of the mere condensation of aqueous vapour.

I have already told you that the source of atmospheric electricity is as yet very uncertain. Yet it is so common and so prominent a phenomenon in many of its mani-

<sup>1</sup> Abstract of a lecture, delivered in the City Hall, Glasgow, by Prof. Tait. Continued from p. 410.

festations that there can be little doubt that innumerable attempts have been made to account for it. But when we consult the best treatises on meteorology we find it either evaded altogether or passed over with exceedingly scant references to evaporation or to vegetation. Not finding anything satisfactory in books, I have consulted able physicists, and some of the ablest of meteorologists, in all cases but one with the same negative result. I had, in fact, the feeling which every one must experience who attempts to lecture on a somewhat unfamiliar subject, that there *might* be much known about it which I had not been fortunate enough to meet with. Some years ago I was experimentally led to infer that mere *contact* of the particles of aqueous vapour with those of air, as they fly about and impinge according to the modern kinetic theory of gases, produced a separation of the two electricities, just as when zinc and copper are brought into contact the zinc becomes positively electrified and the copper negatively. Thus the electrification was supposed to be the result of chemical affinity. Let us suppose, then, that a particle of vapour, after impact on a particle of air, becomes electrified positively (I shall presently mention experiments in support of this supposition), and see what farther consequences will ensue when the vapour condenses. We do not know the mechanism of the precipitation of vapour as cloud, and we know only partially that of the agglomeration of cloud-particles into rain-drops; but of this we can be sure that, if the vapour-particles were originally electrified to any finite potential, the cloud-particles would be each at a potential enormously higher, and the rain-drops considerably higher still. For, as I have already told you, the potential of a free charged sphere is proportional directly to the quantity of electricity on it and inversely to its radius; so when eight equal and equally charged spheres unite into one sphere of double the radius, its potential is four times that of each of the separate spheres. The potential in a large sphere, so built up, is in fact directly proportional to its surface as compared with that of any one of the smaller equal spheres of which it is built.

Now, the number of particles of vapour which go to the formation of a single average rain-drop is expressed in billions of billions; so that the potential of the drop would be many thousands of billion times as great as that of a particle of vapour. On the very lowest estimate this would be incomparably greater than any potential we can hope to produce by means of electrical machines.

But this attempt at explanation of atmospheric electricity presents two formidable difficulties at the very outset.

1. How should the smaller cloud-particles ever unite if they be charged to such high potentials, which of course must produce intense repulsions between them?

2. Granting that, in spite of this, they do so unite, how are they separated from the mass of negatively electrified air in which they took their origin?

I think it is probable that the second objection is more imaginary than real, since there is no doubt that the diffusion of gases would speedily lead to a great spreading about of the negatively electrified particles of air from among the precipitated cloud-particles into the less highly electrified air surrounding the cloud. And if the surrounding air were equally electrified with that mixed with the cloud, there would be no electric force preventing gravity from doing its usual work. This objection, in fact, holds only for the *final* separation of the whole moisture from the oppositely electrified air; and gravity is an efficient agent in this separation is the opinion of Prof. Stokes. It must be observed that as soon as the charge on each of the drops in a cloud rises sufficiently, the electricity will pass by discharge to those which form the bounding layer of the cloud.

The first objection is at least partially met by the

remark that in a cloud-mass when just formed, if it be at all uniform, the electric attractions and repulsions would approximately balance one another at every point, so that the mutual repulsion of any two water-drops would be almost compensated, except when they came very close to one another.

But there is nothing in this explanation inconsistent with the possibility that the particles of water may be caused to fly about repeatedly from cloud to cloud, or from cloud to an electrified mass of air; and in many of these regions the air, already in great part deprived of its moisture, may have become much cooled by expansion as it ascends, so that the usual explanation of the production of hail is not, at least to any great extent, interfered with.

I may here refer to some phenomena which seem to offer, if closely investigated, the opportunity for the large scale investigations which, as I shall presently show, will probably be required to settle the source or sources of atmospheric electricity.

First, the important fact, well known nearly 2,000 years ago, that the column of smoke and vapour discharged by an active volcano gives out flashes of veritable lightning. In more modern times this has been repeatedly observed in the eruptions of Vesuvius and other volcanos.

Sabine, while at anchor near Skye, remarked that the cloud-cap on one of the higher hills was permanently luminous at night, and occasionally gave out flashes resembling those of the aurora. I have not been able to obtain farther information as to this very important fact; but I have recently received a description of a very similar one from another easily accessible locality.

My correspondent writes from Galway, to the following effect, on the 2nd of the present month:—

“At the commencement of the present unprecedentedly long and severe storm the wind blew from south-west and was very warm. After blowing for about two days it became, *without change of direction*, exceedingly bitter and cold; and the rain was, from time to time, mixed with sleet and hail, and lightning was occasional. This special weather is common for weeks together in March or early April. The air is (like what an east wind brings in Edinburgh) cold, raw, dry, and in every way uncomfortable, especially to people accustomed to the moist Atlantic winds. During these weeks a series of small clouds, whose shadows would only cover a field of a few acres, seem to start at regular intervals from the peaks of hills in Connemara and Mayo. They are all more or less charged with electricity. From high ground, behind the city, I have at one time seen such a cloud break into lightning over the spire of the Jesuits' church. At another, I have seen such a cloud pour down in a thin line of fire, and fall into the bay in the shape of a small incandescent ball. On one occasion I was walking with a friend, when I remarked, ‘Let us turn and make a run for it. We have walked unwittingly right underneath a little thundercloud.’ I had scarcely spoken when a something *flashed on the stony ground at our very feet*, a tremendous crash pealed over our heads, and the smell of sulphur was unmistakable. I fancy that I have been struck with these phenomena more than others, from the circumstance that they have always interfered with my daily habits. My walks often extended to considerable distances and to very lonely districts. Now these small local spurts of thunderstorms would hardly excite attention in the middle of a town, all the less as the intervening weather is bright, though raw—these spurts coming on every three or four quarters of an hour. Neither would they excite much attention in the country, as, while such a little storm was going on in one's immediate neighbourhood, you would see at no great distance every sign of fine weather. In fact they always seem to me like the small change of a big storm.”

My correspondent, though a good observer and eloquent

in description, is not a scientific man. But it is quite clear from what he says that a residence of a few weeks in Galway, at the proper season, would enable a trained physicist to obtain, with little trouble, the means of solving this extremely interesting question. He would require to be furnished with an electrometer, a hygrometer, and a few other simple pieces of apparatus, as well as with a light suit of plate armour, not of steel but of the best conducting copper, to insure his personal safety. Thus armed he might fearlessly invade the very nest or hatching-place of the phenomenon, on the top of one of the Connemara hills. It is to be hoped that some of the rising generation of physicists may speedily make the attempt, in the *spirit* of the ancient chivalry, but with the offensive and defensive weapons of *modern science*.

Another possible source of the electricity of thunderstorms has been pointed out by Sir W. Thomson. It is based on the experimental fact that the lower air is usually charged with negative electricity. If ascending currents carry up this lower air the electricity formerly spread in a thin stratum over a large surface may, by convection, be brought into a very much less diffused state, and thus be raised to a potential sufficient to enable it to give a spark.

However the electrification of the precipitated vapour may ultimately be accounted for, there can be no doubt of the fact that at least as soon as *cloud* is formed the particles are electrified; and what I have said as to the immense rise of potential as the drops gradually increase in size remains unaffected. I have tried various forms of experiment, with the view of discovering the electric state of vapour mixed with air. For instance, I have tested the vapour which is suddenly condensed when a receiver is partially exhausted; the electrification of cooled bodies exposed to moist air from a gas-holder; and the deposition of hoar-frost from a current of moist air upon two polished metal plates placed parallel to one another, artificially cooled, and connected with the outer and inner coatings of a charged jar. All have given results, but as yet too minute and uncertain to settle such a question. These experiments are still in progress. It appears probable, so far, that the problem will not be finally solved until experiments are made on a scale much larger than is usual in laboratories.

A great thunderstorm in summer is in the majority of cases preceded by very calm sultry weather. The atmosphere is in a state of unstable equilibrium, the lower strata are at an abnormally high temperature, and highly charged with aqueous vapour. It is not easy, in a popular lecture like this, to give a full account of what constitutes a state of stable equilibrium, or of unstable, especially when the effects of precipitation of vapour are to be largely taken into account. It is sufficient for my present purpose to say that in all cases of thoroughly stable equilibrium, a slight displacement *tends to right itself*; while, in general, in unstable equilibrium, a slight displacement tends to increase. Now, if two cubic feet of air at different levels could be suddenly made to change places, without at first any other alteration, and if, on being left to themselves, each would, under the change of pressure which it would suddenly experience, and the consequent heating or cooling, with its associated evaporation or precipitation of moisture, tend to regain its former level, the equilibrium would be stable. This is not the case when the lower strata are very hot, and fully charged with vapour. Any portion accidentally raised to a higher level tends to rise higher, thus allowing others to descend. These, in consequence of their descent, tend still farther to descend, and thus to force new portions up. Thus, when the trigger is once pulled, as it were, we soon have powerful ascending currents of hot moist air, precipitating their moisture as cloud as they ascend, cooling by expansion, but warmed by the latent heat of the vapour condensed. This phenomenon of ascending

currents is strongly marked in almost every great thunderstorm, and is precisely analogous to that observed in the centre of a West Indian tornado and of a Chinese typhoon.

When any portion of the atmosphere is ascending it must be because a denser portion is descending, and whenever such motions occur *with acceleration* the pressure must necessarily be diminished, since the lower strata are not then supporting the whole weight of the superincumbent strata. If their whole weight were supported they would not descend. Thus even a smart shower of rain must directly tend to lower the barometer. [A long glass tube, filled with water, was suspended in a vertical position by a light spiral spring, reaching to the roof of the hall. A number of bullets hung at the top of the water column, attached to the tube by a thread. When the thread was burned, by applying a lamp, the bullets descended in the water, and *during their descent* the spring contracted so as to raise the whole tube several inches.]

In what I have said to-night I have confined myself mainly to *great* thunderstorms, and to what is seen and heard by those who are within their sphere of operation. I have said nothing of what is commonly called *summer-lightning*, which is probably, at least in a great many cases, merely the faint effect of a distant thunderstorm, but which has also been observed when the sky appeared tolerably clear, and when it was certain that no thunderstorm of the ordinary kind had occurred within a hundred miles. In such cases it is probable that we see the lightning of a storm which is taking place in the upper strata of the atmosphere, at such a height that the thunder is inaudible, partly on account of the distance, partly on account of the fact that it takes its origin in air of small density.

Nor have I spoken of the aurora, which is obviously connected with atmospheric electricity, but in what precise way remains to be discovered. Various theories have been suggested, but decisive data are wanting. Dr. Balfour Stewart inclines to the belief that great auroras, visible over nearly a whole terrestrial hemisphere, are due to inductive effects of changes in the earth's magnetism. This is not necessarily inconsistent with the opinion that, as ordinary auroras generally occur at times when a considerable change of temperature takes place, they are phenomena due to the condensation of aqueous vapour in far less quantity, but through far greater spaces, than the quantities and spaces involved in ordinary thunderstorms.

In taking leave of you and of my subject I have two remarks to make. First, to call your attention to the fact that the most obscure branches of physics often present matter of interesting reflection for all, and, in consequence, ought not to be left wholly in the hands of professedly scientific men. Secondly, that if the precautions which science points out as, at least in general, sufficient, were recognised by the public as *necessary*, the element of danger, which in old days encouraged the most debasing of superstitions, would be all but removed from a thunderstorm. Thus the most timid would be able to join their more robust fellow-creatures in watching fearlessly, but still of course with wonder and admiration, one of the most exquisite of the magnificent spectacles which Nature from time to time so lavishly provides.

#### PHYSICS WITHOUT APPARATUS

##### IV.

THE science of heat constitutes one of those departments of physics in which both the uninitiated beginner and the advanced student can find food for thought. To follow out the theoretical teachings of the science of heat requires a knowledge of abstruse mathematical formulæ; but, on the other hand, a very large

<sup>2</sup> Continued from p. 368.

proportion of the fundamental facts of experiment upon which the science depends can be illustrated with the simplest means.

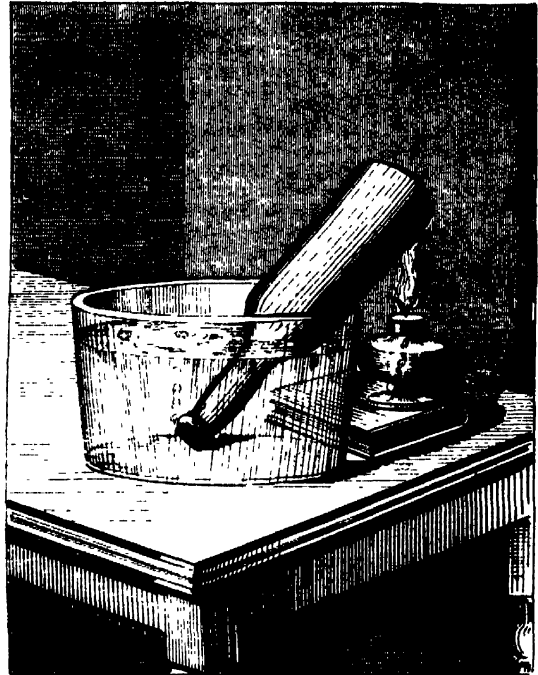

The property possessed by almost all material bodies of *expanding* when they are warmed affords us the means



FIG. 1

of ascertaining the *degree* to which they are warmed. Thus the expansion of the quicksilver in the bulbs of our

...ometers shows us the degree of temperature of the surrounding air. Again, the heat imparted to the air within a paper fire-balloon makes it expand and become specifically lighter than the surrounding atmosphere through which it rises. In general it may be asserted that matter, in whichever state it may be—solid, liquid, or gaseous—expands when heat is imparted to it, and contracts when heat is taken from it. Fig. 11 illus-

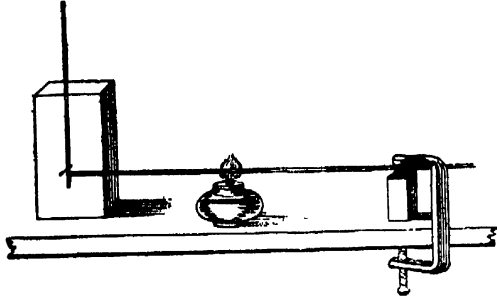

FIG. 13.

trates a very simple manner of showing the expansion of air when heated. An empty wine-bottle is placed with its mouth downwards in a deep dish or jar containing water, the bottom of the bottle projecting over the side of the jar. Heat is then applied by means of a spirit-lamp; or, if this is not available, by burning under it a piece of cotton wool soaked in spirits and held on the end of a fork. The glass of the bottle becomes hot—if



FIG. 14.

too hot it may crack—and the air inside shares its warmth and begins to expand. There being only a limited space inside the bottle, some of the air will be forced out, and will rise in bubbles through the water. If now the flame be removed, the reverse operation of contraction by cooling may be witnessed, for as the air inside the bottle cools it will occupy a smaller and smaller amount of space, and the water will gradually rise up in the bottle-

neck. Of course this is seen better with a bottle of clear glass than with one of a dark or opaque tint.

The contraction of a liquid on cooling can be even more simply shown. Take a common medicine bottle. Warm it gently (by rinsing it out with a little hot water) so that it shall not crack by the sudden heating, and then fill it *brimful* of boiling water. Leave it to cool; and in less than half an hour you will find that the water which you poured in to overflowing has shrunk down into the neck of the bottle, having contracted as it cools.

It was mentioned above that the hot air in a fire-balloon raises it, being lighter than the cold air. In the same way hot water will rise through cold, and float on the top of it, being specifically lighter. You may prove this in several ways. Fill a deep jar with water, and then, taking a red-hot poker, plunge about an inch of the tip of it into the surface of the water. Presently the whole of the water at the top will be boiling furiously; but the water at the bottom will be just as cool as before, for the hotter water will not have gone down, but will have



floated at the top, being lighter in consequence of expansion. The same thing can be shown very prettily by the following simple experiment. Fill a wide and deep glass jar—the glass of a parlour-aquarium will do excellently—to about half its depth with cold water. Provide yourself also with a kettle full of boiling water, a funnel, a bit of wood about three inches square, and with some ink—red ink if possible. Pour into the kettle enough of the ink to colour it with a perceptible tint; this is simply that you may be able to distinguish between the colourless cold water and the coloured hot water which you are going to cause to float at the top. The only difficulty of the experiment is how to pour out the hot water without letting it *mix* with the cold water. Fig. 12 shows how you may do this with the help of the things you have got together. The bit of wood (or cardboard) is laid on the water as a float, and you must pour the hot water on to this to break the force of its fall. The funnel will also help to break the fall of the hot water, and will aid you to guide the stream on to the middle of the float. With

these precautions you need not fear failure, and you will enjoy the spectacle so seldom seen, though so often actually occurring, of *hot water floating on the top of cold water*.

It is almost as easy to demonstrate the fact that solid bodies, such as wood, iron, and glass, expand when heated. A steel knitting-needle, for example, is both longer and thicker when hot than it is when cold. To prove so minute a quantity as the increase in thickness would require very delicate apparatus indeed, but the increase of *length* may be rendered visible by the following simple arrangement given by Miss C. Martineau in her capital "Easy Lessons in Heat." The knitting-needle must be fixed firmly to the table by a table-clamp (Fig. 13). Against the other extremity rests the end of a straw to serve as an index or pointer. This straw, which should be at least eight or nine inches long, is transfixed by a pin at about a quarter of an inch above the point where it touches the knitting-needle, the pin being stuck into a block of wood or other substantial support. The slightest movement of the end of the steel needle will be rendered apparent by the movement of the straw index.

Another pretty experiment which is easily performed is that of boiling water in a sheet of paper. Take a piece of paper and fold it up, as schoolboys do, into a square box without a lid, as shown in Fig. 14. Hang this up to a walking-stick by four threads, and support the stick upon books or other convenient props. Then a lamp or taper must be placed under this dainty cauldron. In a few minutes the water will boil. The only fear is lest the threads should catch fire and let the water spill into the lamp and over the table. The flame must therefore not be too large. A small taper will give a flame quite large enough. The paper does not burn, because it is wet; and even if it resisted the wet it still would not burn through, because the heat imparted to it on one side by the flame would be very rapidly conducted away by the water on the other. Another experiment of a similar nature, but perhaps even more striking, is as follows:—Twist up the edges of a common playing-card or other bit of cardboard, so as to fashion it into a light tray. On this tray place a layer of small shot or bits of lead, and heat it over the flame of a lamp. The lead will melt, but the card will not burn (Fig. 15). It may be charred a little round the edges, but immediately below the lead it will not be burned, for here again the lead conducts off the heat on one side as fast as it is supplied on the other. Lastly, we give an experiment which, like the two preceding, proves that a good conducting substance may protect a delicate fabric from burning by conducting away the heat rapidly from it. Lay a piece of muslin quite flat upon a piece of metal. A live coal placed on the muslin will not burn it, for the metal takes away the heat too fast. If the muslin is however laid on a bad conductor, such as a piece of wood, it will not be protected, and the live coal will kindle the muslin.

(To be continued.)

### NOTES

THE International Congress of Anthropology and Prehistoric Archaeology, which opens at Lisbon on the 19th inst., promises to be an interesting one. On the mornings of the 21st, 23rd, 25th, and 27th, questions relative to Portugal will be discussed—Cut Flints of the Tertiary, Characteristics of the Palæolithic or Quaternary Age, the Neolithic Period, Kitchen-middens, Sepulchral Caves, Age of Metals, &c. Among the papers to be read on the afternoons of these days are the following:—M. Arcelin, Antiquity of Man in the Valley of the Saone; M. E. Catailhac, Recent Prehistoric Discoveries in the South of France; M. Ernest Chantre, an Exploring Journey in the Caucasus; M. Hildebrand, the State of Prehistoric Studies in Sweden; M.

Schaffhausen, Prehistoric Man, &c. Several interesting excursions have been arranged for. Perhaps the most important question to be brought before the Congress will be that of the worked stones said to have been found by M. C. Ribeiro in the Tertiary. The Local Committee have opened numerous cuttings between Carregado and Cercal, and in that distance of twenty kilometres it is stated that worked stones will be met with at every step in the Miocene deposits. The railway companies of Spain and Portugal will issue tickets at a reduction of one-half to members of the Congress.

AT the approaching Congress at Edinburgh on October 6 to 13, the discussion on the first special question in the Educational Department, "What may be the dangers of educational over-work for both sexes, with special reference to the higher class of girls' schools, and the effects of competitive examinations?" will be opened with papers by Dr. Keiller, M.D., of Edinburgh, and Miss Edith Peachey, M.D., of Leeds. Papers on the second special question, "How far, and under what conditions, ought the teaching of higher subjects in elementary schools to form part of a system of national education?" will be contributed by Sir George Campbell, K.C.S.I., and Dr. Robertson, LL.D. Prof. Laurie will read a paper on the third special question, "Is it desirable that public secondary schools should be placed under local authorities and be subject to the supervision of the Committee of Council on Education?"

WE are glad to learn that Mr. Mundella intends, during his sojourn on the Continent, to visit some of the principal foreign technical schools. We have no doubt he will thus get some enlightenment as to what real technical education means.

THE Geological Society of France have issued circulars announcing that an extraordinary session will be held at Boulogne, from September 9 to 19, under the presidency of Prof. Gosselet of Lille, with an ample programme of papers and excursions.

AT a meeting of delegates from local scientific societies, held at Swansea on August 31, Mr. J. Hopkinson in the chair, various suggestions, principally with the view of securing a better representation of scientific societies at the meetings of the British Association and a more intimate relationship between provincial societies, were made, and the following resolutions were passed:—1. That this Conference recommends that at future meetings of the British Association it is desirable that the delegates from the various scientific societies should meet, with the view of promoting the best interests of the Association and of the several societies represented. 2. That Mr. Hopkinson and Mr. Fordham be a committee to carry out the views expressed at this conference, and report to the conference of delegates to be held at York in 1881, in accordance with the foregoing resolution.

To judge from the three volumes of its *Bulletin* which have been sent us, the Philosophical Society of Washington seems to produce some good work. The Society was founded ten years ago, and the volumes embrace the period from 1871 to 1880. The late Prof. Joseph Henry was the first president of the Society, the object of which is stated to be the free exchange of views on scientific subjects and the promotion of scientific inquiry among its members. The following are a few of the papers contained in the volumes before us:—"On the Adopted Value of the Sun's Apparent Diameter," by Prof. E. S. Holden; "On the Delta of the Mississippi," by Prof. Forshey; "On the Zodiacal Light," by Prof. S. Alexander; a detailed report on the unusually brilliant meteor of December 24, 1873; a long and elaborate memoir of Prof. Joseph Henry, with detailed notices of his varied scientific work; also the addresses he delivered during his presidency; "On the 'Prodromus Methodi Mammalium' of Storr," by Mr. Theodore Gill; a curious inquiry on the

Number of Words used in Speaking and Writing, by Prof. E. S. Alden; "New Species of Fossil Plants from Alleghany Co., Virginia," by Mr. F. B. Meek; "The Gentile System of the Omahas," by Rev. J. O. Dorsey. Most of the papers, however, appear in very brief abstracts.

ENGINEERS are engaged daily in making surveys for the purpose of determining the site of the projected tunnel under the St. Lawrence between Hochelaga and Longueil.

THE War Office authorities have detailed a whole company of the Royal Engineers for instruction in the art of military ballooning, in lieu of the small detachment hitherto employed in the experiments. The company selected is the 24th (Field Company) at Aldershot, and it will be placed under the command of Capt. Elsdall, R.E.

ON the anniversary of the Russian Emperor's coronation, the foundation-stone of the Siberian University at Tomsk was laid. The building was projected in the reign of the Emperor Alexander I.

THE *Panama Star and Herald* of the 12th ult. says that the reports received concerning the eruption of the Fuego, the largest volcano in the republic of Guatemala, show that it was preceded by earthquakes of considerable violence, the theatre of whose operations was confined to the country surrounding the volcano, within a radius of some twenty or thirty miles. In Antigua, Amatitlan, Palin, Petapa, and several other points the shocks were of such violence as to occasion serious alarm among the inhabitants and cause them to abandon their houses for several hours. With the commencement of the eruption, however, the earthquake period ended, and the people in the streets of the various pueblos were able to witness in tranquillity the splendid appearance of the burning mountain. During the morning of the day succeeding the eruption the pueblos on the Costa Grande, to the northward of the volcano, were shrouded in gloom, and for some time after sunrise people in offices were compelled to employ artificial light in order to carry on their labours. Ashes and dust fell in great quantities at many miles distance, and people who were at too great a distance from the volcano to witness the eruption were for some time in doubt as to their origin. Happily the disturbance has passed with no more serious matter to record than the alarm which it momentarily occasioned.

AT the last meeting of the Balloon Society of Great Britain the recent balloon voyage out to sea at Cherbourg was referred to. Mr. Simmons stated that when he some years ago made a similar trip at Hull he went twenty miles out to sea and then got into an anticipated return current which he found a few feet above the outward current, and which safely landed him at the desired spot on *terra firma*. The president read a letter from a member of the Society who had made one of his ascents in a thunderstorm and found the atmosphere at an altitude of about 200 feet and for a height of 100 feet to be of a dull leaden hue, but as soon as he had risen above this stratum he found the sky quite unclouded, and witnessed perfectly clearly the storm raging below in all its grandeur. On Saturday afternoon a balloon contest took place from various points in the neighbourhood of London, under the auspices of the Balloon Society. Eight balloons were to have started, but only five succeeded in getting away. A silver medal was to be awarded to the balloon that traversed the greatest distance in one hour and a half. The competition seems to have had some connection with Commander Cheyne's proposed Arctic Expedition; but so far as we have ascertained no new scientific results seem to have been obtained. One balloon seems to have attained a height of 14,000 feet.

DURING the Session of the City and Guilds of London Institute, commencing October 4, Prof. Armstrong, F.R.S., and

Prof. Ayrton, Inst. C.E., will continue their tutorial and laboratory courses of instruction in Chemistry and Physics as applied to the Arts and Manufactures, at the Cowper Street Schools, Finsbury, in rooms rented from the Middle Class Schools Corporation, pending the erection of the City and Guilds Technical College, Finsbury. Dr. Armstrong will deliver a course of about thirty lectures on "Organic Chemistry, with special Reference to its Industrial Applications," on Mondays, at 8.30 to 9.30 p.m., commencing October 4. He will also deliver a course of about twenty-four lectures on Tuesday and Friday afternoons at 4 to 5 o'clock, commencing October 5. Although the chief object of these lectures is to afford such preliminary training as is necessary for those who may desire later on to study particular branches of Applied Chemistry, more than usual attention will be given to matters of technical importance. There will also be daily Laboratory Classes. Prof. Ayrton will deliver a course of evening lectures on "Electrical Instrument Making," on Tuesdays at 8.30 to 9.30 o'clock, commencing October 5, the first twelve of the lectures being given before Christmas. On Friday evenings, at 8.30 to 9.30 o'clock, commencing October 8, Prof. Ayrton will also deliver a course of lectures, the first twelve being given before Christmas, on "Weighing Appliances and Motor Machinery," adapted to the wants of makers and users of machinery. He will also deliver a course of about twenty-four lectures on Monday and Wednesday afternoons, at 4 to 5 o'clock, commencing October 4, on the "Electric Light."

By a decree of the French Minister of Public Instruction the Ethnographical Museum at the Trocadéro has been organised. Dr. Hamy and M. Landrin have been appointed conservators.

A LARGE number of rooms have been added to the French Museum of National Antiquities at St. Germain, and are awaiting a formal opening by the President of the Republic. In one of them have been collected a series of relics of Roman age relating to religious ceremonies and inscriptions; in a second room has been disposed a large number of bas-reliefs and statues exhibiting arms and scenes of military life; and in the third room we found many sepulchral monuments showing the arts and trades as practised during the Roman rule in Gaul. Some rooms have been already opened to the public, and in one of them is the celebrated Autun mosaic representing Bellerophon triumphing over Chimæra; execution and preservation are both wonderful.

MR. ROWSELL of King William Street, Strand, has just published a catalogue which includes a large and valuable collection of scientific works, principally biological.

MESSRS. LONGMANS AND CO. announce the forthcoming publication of a new series of "Popular Lectures on Scientific Subjects," by Prof. Helmholtz, translated by Dr. E. Atkinson.

AT a concert given every night in the garden of the Palais Royale, Paris, the orchestra is placed in the vicinity of the fountains, which are illuminated by eight splendid Siemens lamps, which work admirably. Two other Siemens lamps have been placed in the shop of a jeweller in the Galleries, and the experiment may eventually lead to the lighting of the whole palace by the electric light.

THE heat was so intense at Clermont on September 4 last that the ceremony of the inauguration of Pascal's statue, which was to have taken place that day, was postponed to the following morning at 8 o'clock. The principal speech was delivered by M. Bardoux, formerly Minister of Public Instruction, the representative of Clermont in the Lower French House.

THE French Central Society of Agriculture and Entomology has opened in the *Orangerie* of the Tuilleries its beautiful exhibition of insects. The exhibition is an instructive one, embracing

insects useful and noxious, and the various industries which depend on insects.

WE take the following from the *Electrician*.—"When a little girl is found 'playing at telephone,' and reproducing to the life the 'ways' of those who ordinarily profit by the new means of communication, the circumstance may be taken as an indication that telephony is in some localities becoming really popular. The following sketch of a baby telephonist, 'pretending' to communicate with her papa, is from the *Concord Monitor*.—She was a pretty child, happy-hearted, full of fun, and a great mimic. Only two summers had sent sunshine across her curls and waked to sensuous delight the infantile beauty and form. She dwelt in a pleasant home filled with creature comforts, among them the new innovation, the telephone. She had often watched this wonderful mechanism, and while she neither knew nor cared for the secrets of its operation, she had learned by heart the peculiar and one-sided formula of a telephone conversation. Unheeding that some one was watching her, the other day she put a little hand to the wall and imitated the pushing of the button on the telephone. Up went the other hand to the ear, as if holding the ebony cylinder, and the little miss went on in mimicry of her elders, in the following fashion:—"Hello." She then paused for an answer from the central office. "Hello. Please hitch on Mr. — house to Mr. — office." Pause. "Is 'at you, papa?" Pause. "When is you coming home?" Pause. (Turning to her dolls, the little one here spoke impatiently, "Do you keep still; I can't hear a word.") "Yes." (Rising inflection.) Pause. "I don't know." (In doubt.) Pause. "Yes." (Gleefully.) Pause. "Why papa." (In surprise.) Pause. And so the little one went on, maintaining perfectly an imaginary conversation, till at last she dropped her hand with a motion indicative of weariness from holding the telephone, and pronounced the conversational "That's all; good bye," with all the nonchalance of a veteran."

THE Proceedings of the American Antiquarian Society, No. 74, we learn from the *American Naturalist*, contains a paper by Mr. Philipp J. J. Valentini, on the Katunes of Maya history. The Katunes were a series of notable events that transpired from the time of the departure of the Mayas from their original home until their destruction. Don Juan Pio Perez, a learned Yucatecan, had found an old Maya manuscript containing this account, but failed to discover the author's name. From this precious document Mr. Valentini attempts to reconstruct the Maya chronology in the same manner that he deciphered the Mexican calendar-stone. The results at which he arrives are as follows:—1. That the conquerors and settlers of the Yucatecan peninsula, as well as those of the Anahuac lakes, were joint participants in a correction of their national calendar about the year 290 B.C. 2. That about the year 137 A.D., when a total eclipse of the sun took place, the ancestors of both nations set out from their common fatherland, Tula, or Tulapan. 3. That about the year 231 A.D. both nations made their appearance on the coast of Central America, and succeeded in conquering a large portion of the peninsula.

DR. FOREL has issued in a separate form his paper from the *Archives des Sciences* on the Temperature of the Lake of Geneva and other Freshwater Lakes.

THE additions to the Zoological Society's Gardens during the past week include a Bonnet Monkey (*Macacus radiatus*) from India, presented by Mr. C. Kerry Nicholls; a Common Fox (*Canis vulpes*), European, presented by Mr. E. Schweder; a Gold Pheasant (*Thaumalea picta*) from China, presented by Mr. James McGregor; a Weka Rail (*Ocydromus australis*) from New Zealand, presented by Mr. H. Frank Rose; a Brazilian Cariama (*Cariama cristata*) from Bolivia, presented by Mr.

Charles Stanley Barnes; Six Mocking Birds (*Mimus polyglottus*) from North America, presented by Mr. W. Cross; a Gannet (*Sula bassana*), British, presented by Mr. George Edson; a Sloth Bear (*Melursus labiatus*) from India, a Common Squirrel (*Sciurus vulgaris*), European, four Mississippi Alligators (*Alligator mississippiensis*) from the Mississippi, deposited; a White lipped Peccary (*Dicotyles labiatus*), two Boatbills (*Cancroma cochlearia*) from South America, purchased.

#### THE BRITISH ASSOCIATION

IN addition to the grants in the list which we gave last week, the following were voted at the final general meeting:—Mr. James Glaisher, Luminous Meteors, 15*l.*; Prof. Sylvester, Fundamental Invariants, 40*l.*; Prof. W. C. Williamson, Tertiary Flora, 20*l.*; Prof. Rolleston, Prehistoric Remains in Dorsetshire, 25*l.*

The total sum voted was 1,010*l.*, considerably more than the receipts of the Swansea meeting.

It is expected that the public lectures at the York meeting next year will be given by Prof. Huxley, Prof. Tyndall, and Mr. Spottiswoode.

#### REPORTS

*Report on the best means for the Development of Light from Coal-gas of different qualities, by a Committee consisting of Dr. Wm. Wallace (secretary), Prof. Dittmar, and Mr. John Pattinson, F.C.S., F.I.C.* Drawn up by Mr. Pattinson.—If gas be allowed to burn under little or no pressure it gives a smoky flame of little luminosity; when forced out under great pressure it yields a non-luminous blue flame like that of a Bunsen's burner. The aim in constructing a good gas-burner is so to regulate the supply of air and so to control pressure that the maximum amount of light may be obtained. This is best accomplished by an Argand burner.

From series of tables showing the result of experiments, the following conclusions are drawn:—The illuminating power is increased as the gas, issuing with less velocity, is mixed or brought in contact with less air. No increase in illuminating power is produced by heating the gas before its combustion. This confirms the results obtained by the London Gas Referees in 1871. By heating the air admitted to the centre of a standard Argand burner to 520° F., an increase of light amounting to 9 per cent. was produced for a rise of 45° in temperature. The trouble and expense of heating the air would probably prevent the adoption of this means of increasing the luminosity. With ordinary flat-flame burners the greatest amount of light is evolved under a pressure of one inch of water.

After giving measurements of the intensity of light evolved by gas burned in various varieties of burners (Bray's, Silber's, and Sugg's), the author concludes that the luminosity depends, so far as the burner is concerned, on the amount of gas burnt and on the pressure. The only burner presenting undoubted advantages over others, and that owing to more perfect regulation of air-supply, is the Argand burner; but on account of its expense, the trouble of keeping it clean, and the necessity of employing a governor for each burner, it is improbable that it will come into general use. Governors are now constructed for single burners by Sugg, Peebles, Wright, Borradaile, and others. Such governors are of great service, not only in saving gas, but also in regulating supply and giving constancy in luminosity.

*Thirtieth Report of the Committee, consisting of Prof. Everett, Prof. Sir William Thomson, Mr. G. F. Symons, Prof. Ramsay, Prof. Galkie, Mr. J. Glaisher, Mr. Pengelly, Prof. Edward Hull, Dr. Clement Le Neve Foster, Prof. A. S. Herschel, Mr. G. A. Lebour, Mr. A. B. Wynne, Mr. Galloway, Mr. Joseph Dickinson, Mr. G. F. Deacon, and Mr. E. Wethered, appointed for the Purpose of investigating the Rate of Increase of Underground Temperature downwards in various Localities of Dry Land and under Water.* Drawn up by Prof. Everett (secretary).

—Observations have been taken in the Talargoch Lead Mine, Flintshire (between Rhyl and Prestatyn), under the direction of Mr. A. Strahan, of the Geological Survey, and Mr. Walker, Chairman of the Board of Directors of the mine.

The top of the shaft is 190 feet above the level of the sea. The lowest workings are 900 feet below sea-level. The veins run across an angle of Carboniferous Limestone, bounded on both sides by

faults which throw down coal-measure shale; and as the faults have a considerable inclination, the lowest workings run beneath the shale for a considerable distance. The limestone dips at angles varying from 45° to 55°, and is of two kinds, one white and massive, the other thin bedded black with thin shale partings.

There are levels at intervals of about twenty yards vertically, in the vein, most of which have been driven for some years; but all the observations have been taken in newly-opened ground.

They have been taken by boring a hole 24 inches deep at a distance of from 1½ to 5 yards from the fore breast, and either on the same day or on the next day inserting one of the Committee's slow-action thermometers, with a foot of plugging consisting of dry rag and clay behind it. After an interval generally of four days the thermometer was taken out and read, then reinserted, and read again about a week later, the difference between the two readings never amounting to so much as half a degree.

The observations were taken at six different places in the mine, which are designated by the observers Stations I. to VI.; but in one instance, that of Station II., owing to the swelling of newly-exposed shale, the hole became distorted, so that after extracting the dry rag and clay, an hour was expended in working out the thermometer, the reading of which has therefore been rejected. The following is a list of the five remaining stations, arranged in order of depth:—

No. of Station.	Depth from Surface in Feet.	Temperature, Fahr.	Distance and Direction from Main Shaft.
IV. ...	465 ...	53.4 ...	190 yds. S.W.
V. ...	555 ...	52.9 ...	170 yds. S.E.
VI. ...	636 ...	58.8 ...	840 yds. S.W.
III. ...	660 ...	54.0 ...	120 yds. S.
I. ...	1041 ...	60.8 ...	190 yds. N.E.

It will be observed that the order of the temperatures is not the same as the order of the depths; it therefore becomes important to describe the positions with some particularity.

Stations IV., V., and III. are near together in ground plan, IV. and V. being about 250 yards apart, and III. nearly midway between them, and they have all the same rock overhead between them and the surface, namely, black and white limestone.

At Station I. the rock overhead consists almost entirely of sandstones and shales, with thin coal-seams. At Station VI. it consists of white limestone and shale.

It may be mentioned that the temperature at VI. was observed on three several occasions, namely, January 14, January 21, and February 19, and was in each case found to be the same. Mr. Strahan further states that this station is near a large fault, which contains iron pyrites and gives off water charged with sulphuretted hydrogen; the temperature of the water as pumped up Walker's shaft from a depth of 770 feet, being 63° at the top of the lift. It seems probable that the decomposition of this pyrites may be the cause of the exceptionally high temperature at this station.

The comparison of the temperatures will be most clearly brought out by tabulating the rate of increase from the surface down to each station, as calculated from an assumed surface temperature, which may be fairly taken as 48°. As all the depths are considerable, an error of a degree in the surface temperature will not have much influence on the comparison, which stands thus:—

Station.	Depth in feet.	Excess above surface.	Feet per Degree.
IV. ...	465 ...	5.4 ...	86
V. ...	555 ...	4.9 ...	113
VI. ...	636 ...	10.8 ...	59
III. ...	660 ...	6.0 ...	110
I. ...	1,041 ...	12.8 ...	81

Stations V. and III., which give the slowest rate of increase, are both of them in a vein called the "South Joint;" and Stations IV. and I., which agree well with each other, though differing from the rest, are both of them in another vein called the "Talargoch vein;" while Station VI. is in the "Country rock." The horizontal distance between IV. and III. is only 120 yards; but if we attempt to deduce the rate of increase from comparing these two, we have an increase of only 0.6 in 195 feet. It thus appears that, notwithstanding the proximity of the two veins, their conditions as to temperature are very different.

Widely as the results differ among themselves, they agree upon

the whole in showing that the average rate of increase is slow; and this general result is in harmony with what has been found at the nearest localities mentioned in our previous reports, namely, Dukinfield and Liverpool. Here, as at Dukinfield, all the strata are highly inclined.

Some additional observations at Dukinfield have recently been made for the Committee by Mr. Edward Garside, student of engineering in Queen's College, Belfast. The Astley Pit, in which they were taken, has now been carried to a much greater depth than it had extended at the time of Sir Wm. Fairbairn's observations, to which allusion was made in our Report for 1870. The two deepest seams of coal in it are called the "Cannel Mine" and the "Black Mine," the former being the deeper of the two; they both slope downwards at about 15°, the deepest point being the far end of the Cannel Mine. The following is Mr. Garside's summary of the observations; the "surface-depth" being distinguished from the "shaft-depth," because the surface is not level, but slopes slightly in the same general direction as the seams. The shaft-depth gives the difference of levels, but the surface-depth, which is practically the same as the distance of the nearest point of the surface, is what we must use in computing the rate of increase of temperature.

Date in 1880.	Seam Coal.	Surface Depth. Feet.	Shaft Depth. Feet.	Temperature of Surface. Fahr.	Temperature in Air Road. Fahr.	Distance from Main Air Column. Yards.
June 17	Cannel	2,700	2,754	86½	75½	160
" 19	Black	2,407½	2,631	80	78½	630
" 21	Cannel	2,410½	2,482½	81	79	600
July 2	Black	1,987½	2,047½	74	71½	460

The pit is described as being entirely free from water.

Report of the Committee for making Secular Experiments on the Elasticity of Wires, by Mr. J. J. Bottomley.—The wires prepared by the Committee in Glasgow are still under experiment.

Report of the Committee on the Specific Inductive Capacity of a good Sprengel Vacuum, by Mr. W. E. Ayrton.—Boltzmann had estimated the specific inductive capacity at '9994; while Professors Ayrton and Pery had estimated it at '9985. In the experiments of the committee much higher vacua had been obtained, and had found some rather remarkable and not readily intelligible results. With very high vacua the inductive capacity of the compound aluminium condenser employed appeared to be less than at slightly lower degrees of exhaustion. The method adopted consisted in applying the aluminium condenser to a modification of a Hughes' induction balance in connection with a sliding condenser, a telephone, and a small induction coil.

Sir W. Thomson criticised the method as not being purely electrostatic in its nature. The discussion was continued by Mr. Gordon and Mr. Fitzgerald, who alluded to a possible connection between the fluctuations of the phenomena observed and those observed in the phenomena of Crookes' radiometer-force.

All the observations were taken with one of the committee's slow-acting thermometers, in holes drilled in the floors at the far ends of newly-opened horse-road levels; the holes being four feet deep and two inches in diameter. All the holes were free from cracks, and were in the same kind of rock—an argillaceous earth called "warren earth." They were allowed to stand for a short time, to allow the heat caused by drilling to escape. The thermometer was then inserted, and the portion of the hole between it and the mouth plugged with cotton waste and the dust which came out of the hole in drilling. After being left for forty-eight hours it was taken out and read.

The data for calculating the rate of increase are given in the first two columns below.

Depth in Feet.	Temperature Fahr.	Feet per Degree from Surface.
1,987½	74	79.5
2,416½	81	75.5
2,407½	80	77.7
2,700	86½	72

The third column shows the number of feet per degree of difference from the surface, assuming the surface-temperature to be 49°.

Comparing the observations at 1,987½ and 2,416½ feet, we have an increase of 7° in 429 feet, which is at the rate of 1° in 61.3 feet; and comparing the two deepest observations, we have an increase of 6½° in 292½ feet, which is at the rate of 1° in



45 feet. It thus appears that the rate of increase in this pit is more rapid as we go deeper. The greatest depth in Sir Wm. Fairbairn's observations was 685 yards, or 2,055 feet, and the temperature which he found for this depth was  $75\frac{1}{2}^{\circ}$ , which agrees to half a degree with the observations now reported.

The committee have to express their regret at the loss of two of their colleagues—Prof. Clerk Maxwell and Prof. Ansted—by death, during the past year.

*Report on the Ultra-Violet Spectra*, by Prof. A. K. Huntington. —The physical portion of the report was read in Section A. Before the Chemical Section Prof. Huntington drew attention to the following points:—The work of former experimenters on this subject is of great interest. The late Dr. Miller, in his experiments, was obliged to conclude that no connection could be drawn between the chemical composition of a substance and its power of absorbing ultra-violet rays. His method of experimentation, however, was deficient, inasmuch as he used layers of varying thickness, and in every case employed saturated solutions. His substances were not so pure as is necessary in such an investigation.

Dr. Miller also investigated the absorption of the ultra-violet rays by reflection from polished metallic surfaces. The results obtained were that gold shows almost total reflection; next best is burnished lead. Other metals present a greater or less absorption. Prof. Stokes' results confirm Dr. Miller's. His process differed from that of Dr. Miller, inasmuch as he passed the light through a layer of the solution of the substance under experiment on to a fluorescent screen, while Dr. Miller photographed the spectrum. His results were of great value, and from a chemical point of view it is of interest to note that glucosides and alkaloids have great absorptive power, and that on addition of acids absorption begins somewhat later than in presence of an alkali.

In 1874 Mr. Sorby constructed a spectroscope with a fluorescent eyepiece, and was thus able to observe the spectra directly. His results, though valuable, are vitiated by the impurity of the material he used.

Mention must also be made of experiments by Prof. Cordieu, who experimented on the influence of the atmosphere in cutting off rays on the ultra-violet end of the spectrum.

Prof. Hartley, one of the members of the Committee, has recently experimented on this subject, and some of the results of his research have been communicated to the Royal Society. His experiments, made with an improved form of Dr. Miller's apparatus, have led to interesting conclusions. He has found that monatomic alcohols of the methyl series exhibit little or no absorption. The first of the series, methyl alcohol, is, when pure, quite as "diaphanous" as water to invisible rays. Fatty acids, containing the same number of atoms of carbon as the alcohols to which they are related, have a higher absorptive power. Increased complexity of the molecule causes increased absorption. All members of the benzene series, in fact all bodies whose constitution is best expressed by the "ring-formula," give absorption-bands of great intensity; the hydrocarbons themselves, however, occupying the lowest position in this respect. Isomeric bodies of this group differ widely in their spectrum, which thus affords a convenient means of identification. Doubly-linked bodies, such as ethene, propene, anylene, give no absorption-spectrum; and in fact the ring-form appears to be a *sine-qua-non*, for the terpenes and camphor do not absorb ultra-violet rays.

The intensity of the absorption-bands of naphthalene and anthracene is remarkable; a solution of 1 part of the latter body in 50 million times its weight of acetic acid may still be recognised.

*On the Spectra of Metalloids*, by Dr. A. Schuster, F.R.S.—The author stated that he had considerable difficulty in distinguishing the spectrum of an element from that of a compound. For example, the familiar spectrum of a Bunsen's flame is ascribed by some to carbon, and by others to a hydrocarbon, the argument in favour of the latter view being that the temperature of the flame is not sufficiently high to volatilise carbon as such. The reply to this argument is that during its passage from its compound with hydrogen to CO or CO<sub>2</sub> the element carbon is actually liberated, and then exhibits the band-spectrum; and in confirmation of this theory it has been noticed that gas impregnated with a salt of a metal such as copper or iron, gives in the Bunsen's burner the true metallic spectrum and not the spectrum of a compound. The same argument

applies here, for the metal is actually liberated during its passage from (say) the chloride to the oxide. Besides, the band spectrum is seen still more effectively when cyanogen is burned even when dried as perfectly as possible. This band-spectrum is seen in the sun's rays, and it is highly improbable that cyanogen should be able to resist such an enormously high temperature.

The author then considered the question:—Why should an element give different spectra at different temperatures? Band elements characteristic of compounds, and at low temperatures elements show a banded spectrum. At higher temperatures such spectra become simpler, and the evident conclusion is that complex molecules of the elements are dissociated into those of a simpler order. This view is rendered highly probable by the fact that the spectrum of mercury is a constant one, and that no known increase of temperature alters its character; now, assuming the molecule of hydrogen to consist of two atoms, that of mercury consists of a single atom, and it is evident that no simplification is possible.

The change of the spectra of chlorine, bromine, and iodine, as the temperature is increased would seem to corroborate Prof. Victor Meyer's recent conclusions with regard to the molecular complexity of these elements.

It was also suggested that the spectrum of an element might vary according to the compound from which it is liberated. Were it possible to decompose carbon monoxide and dioxide, and to obtain the spectrum of the single carbon atoms which they contain, it would probably differ from the well-known banded spectrum of carbon which there is reason to suppose is that of at least a two-atom molecule.

Mr. W. Chandler Roberts pointed out that Prof. Wiedemann has undertaken measurements to ascertain whether a change of temperature takes place during alteration of the spectrum, and hoped that interesting results would be obtained.

*Report of the Committee on Erratic Blocks*, presented by the Rev. H. W. Crosskey. (Abstract.)—Although the destruction of erratic blocks is proceeding with considerable rapidity, the Committee were able to report the discovery and preservation of some important specimens.

One of the most remarkable blocks of Shap granite yet observed is described by Mr. J. R. Dakyns at Seamer Station, near Scarborough. It measures roughly 5 ft. 8 in.  $\times$  4 ft. 10 in.  $\times$  4 ft. 3 in., and was fairly imbedded in gravel, forming the summit of a well-marked terrace 225 feet above the sea-level. This boulder is specially interesting in that it is the only boulder of Shap granite in the neighbourhood whose position in the beds is known; and this position shows that at the age assigned to the gravels (which is a comparatively recent one) icebergs must have been floating about. It has been preserved in the garden of the Station House.

The report records particulars of boulders discovered in the neighbourhood of Urmston, near Manchester, and also of a large number both of isolated boulders and groups of boulders observed in Leicester-shire by Mr. J. Plant.

Mr. Pengelly furnishes a very interesting part of the report in an account he gives of some transported blocks and accumulations of blocks which he has observed in South Devon, the transposition of which it does not seem altogether possible that the action of water alone could have effected. A block of greenstone occurs in the village of Kingston, South Devon, measuring 4  $\times$  2  $\times$  2 feet, and weighing upwards of a ton. There is a mass of greenstone figured on the map of the Survey, extending to about a mile west-north-west of Kingston, where it makes its nearest approach to the village. Blocks of quartzite have been found in great abundance in the parishes of Diptford and Morleigh. They can be traced to their source on the higher levels of the neighbourhood; a bed of quartzite identical in character with the travelled blocks being interbedded conformably with the ordinary slaty Devonian rocks of the district. There can be no doubt that the blocks have been transported from south to north, and from higher to lower ground. The gradient, however, is very slight, and as almost all the blocks are very angular as well as large, it is difficult to suppose that their transportation was the result of nothing more than running water.

A block of greenstone occurs near Diptford Court, weighing fully 175 ton. A mass of igneous rock apparently of the same kind is found at a distance of five miles due south of the boulder, and another about the same distance north.

The blocks locally termed in South-Western Devon "Whita-

lers", are described in the report. They are composed of white opaque quartz, having in some cases a laminated structure, and traversed occasionally with veins and crystals of the same material. That the blocks have travelled a considerable distance cannot be doubted; and that their transportation was not effected by the action of water only appears proved. The blocks are all more or less rugged and sub-angular, although without any decided traces of glacial polish or scratches. They occur most plentifully on the higher ground.

They have been so largely utilised by the farmers and for artificial rockeries that it is to be feared, unless care is taken to prevent it, those now remaining on the spots they have so long occupied undisturbed may altogether disappear.

The report concluded with an appeal to local observers to report upon the erratic still unrecorded before the work of destruction is completed, and evidence throwing light on difficult problems of glacial geology is destroyed.

*Report on the Exploration of Caves in the South of Ireland, by Prof. A. Leith Adams.* Includes a Report by Mr. R. J. Ussher.—Describes caves at Carnigea Gower, four miles south of Middleton. Stalagmite floor on sandy clay; beneath the stalagmite was much charcoal, the roof had an opening to the surface, down which much kitchen rubbish had been thrown, associated with hammer stones, flint flakes, iron implements, and remains of recent animals. A report was read on the implements, by Mr. R. Day, which are of no great antiquity; one piece of pottery was believed to have a Roman (capital) letter inscription.

*Report on the Carboniferous Polyzoa, by W. G. R. Vine.*—Discusses the character of the genus and species and the views held on them by the earlier workers, and after a comparison of the specific forms he relegates to each of these the precise genera to which they belong.

*Report on the "Geological Record," by Mr. W. Whitaker.*—Four volumes have been published, each of which gives an abstract of all geological work done throughout the world, for one year; they contain an average number of 20,200 entries in each volume.

*Sixteenth Report of the Committee appointed to Explore Kent's Cavern, by Mr. Pengelly.*—The deposits passed through in the cavern were:—

Iron and Bronze.	}	BLACK MOULD. Roman Remains (Ovine).
Paleolithic	Newer Type.	GRANULAR STALAGMITE, 5 feet.
		Extinct Animals.
	Rougher Type.	CAVE EARTH. Extinct Animals. (Hyæna).
		CRYSTALLINE STALAGMITE, 12 feet. (Bears).
		BRECCIA.

Work commenced in March, 1865, by excavating down to 4 feet throughout the whole cavern; finished in November, 1879, the floor had at that time been so excavated, at a cost of 1,850*l.* to the Association. A further grant was then given to lay bare the limestone floor; and subscriptions from private sources amounted to 51*l.* received, which enabled the base of the cave deposit to be excavated for a length of 132 feet. Occasionally stalagmitic fragments occurred on the base of the breccia, resting on the rock. On June 19, 1880, the work was suspended, it having only yielded seventeen finds—amongst them a flint nodule, which had not been touched by the implement maker—which are of greater rarity. Archaeological finds were more numerous than remains of animals; the implements correspond to those of the oldest river gravels in type. Referred to the good work done by Mr. George Smerdon, the foreman of the workmen during sixteen years, who has become crippled with rheumatism, brought on by execution of the work, and suggested the desirability of raising subscriptions to purchase for him an annuity of 10*l.* a year.

*Report of the Committee, consisting of Mr. James Heywood, Mr. Shaan, Mr. Stephen Bourne, Mr. Wilkinson, the Rev. W. Delaney, and Dr. J. H. Gladstone (Secretary), appointed for the purpose of reporting whether it is important that H.M. Inspectors of Elementary Schools should be appointed with reference to their ability for examining the scientific specific subjects of the Code in addition to other matters.*—The Committee nominated at Sheffield for the purpose of considering "whether it is important that H.M. Inspectors of Elementary Schools should be

appointed with reference to their ability for examining the scientific specific subjects of the Code in addition to other matters," have received a considerable amount of evidence upon the subject, and beg to report as follows:—

1. It has come to their knowledge that the teaching of the scientific specific subjects is practically discouraged by the incapacity of many of H.M. Inspectors to examine in them.

2. This incapacity is explained by the fact that the Inspectors are not generally chosen so much for their fitness to judge of such educational work, as on account of their high scholarship, or through political patronage.

3. In the opinion of this Committee there might be an examining body for H.M. Inspectors, composed of three of the most experienced of the present senior Inspectors, associated with a similar number of the Science Examiners of the Science and Art Department. The examination should be thrown open to elementary teachers, and the candidates might be tested in the practical work of examination in one of the Central Elementary Schools in London.

4. The Committee believe that the opening of the Inspectorship to fully qualified elementary teachers would tend to raise the *esprit de corps* of the profession, and improve the character of both inspector and teacher.

5. The Committee are further of opinion that while a university degree may be fitly regarded as a test of scholarship, it is not a test of the particular qualifications for an examiner, and therefore is not sufficient in itself to guarantee the holder thereof as worthy the position of Inspector. There appears to be no reason why academical honours should be made an indispensable condition of appointment.

6. The Committee recommend that a memorial be presented to the Lords of the Committee of Privy Council on Education embodying the above conclusions.

*Report of the Committee, consisting of Dr. Fye-Smith, Prof. M. Foster, and Prof. Burdon Sanderson (Secretary), appointed for the purpose of investigating the Influence of Bodily Exercise on the Elimination of Nitrogen (the Experiments to be conducted by Mr. North).*—During the past year four series of preliminary experiments, each of several weeks' duration, have been made by the Committee on the subject, the expenses of which have been met from other funds. In the course of these experiments unexpected difficulties have been encountered relating to method. The most serious of these difficulties having now been for the most part overcome, we are in a position to proceed with our inquiries next winter, and have therefore to request that the sum of 50*l.*, previously granted to us, may again be placed at our disposal.

SECTION A—MATHEMATICAL AND PHYSICAL

*On some Laws which regulate the Succession of Temperature and Rainfall in the Climate of London, by H. Courtenay Fox, M.R.C.S.*—The following paper is an attempt to answer the question: Is there to be found any definite relation between extremes of rainfall or temperature in any month or season, and the weather of the month or season next following?

The data used by me are the same as those upon which the foregoing paper on "Synchronisms" is based, viz., the monthly temperature and rainfall for the Royal Observatory for sixty-six years—1815 to 1880. In accordance with the principles explained by me at p. 277 of the Report of the British Association for 1879, each month is distributed under the five heads of temperature—according as it was very cold, cold, average, warm, or very warm; and under the five heads of rainfall—according as it was very dry, dry, average, wet, or very wet.

I have presented three tables, which show, for each month or season which is classed under one or other of the extremes of rainfall or temperature, the character, in these respects, of the month or season next following.

A careful study of these tables enables us (whilst omitting all those results which are of an ambiguous character) to state the following definite propositions:—

1. A cold spring is very prone to be followed by a cold summer, a cold summer tends to be followed by a cold autumn, and a cold autumn has a slight tendency to be succeeded by a winter of low temperature.

2. Warm summers are generally followed by warm autumns.  
3. In no fewer than eight out of the twelve months (that is in every one except February, March, May, and October, very low temperature tends to be prolonged into the succeeding month.

4. If June, July, August, or December be *warm*, the next month will probably be a warm one also.

5. Two months, June and July, tend, when very *dry*, to be followed by dry ones. On the other hand, a dry August indicates the probability of a *wet* September.

6. A *wet* December is apt to be succeeded by a wet January.

In addition to the foregoing, there are also a few instances in which the rainfall of certain months appears to be definitely related to antecedent extremes of temperature, and *vice versa*. Thus

7. If August or September be *warm*, the ensuing September or October inclines to be wet. If, on the other hand, September or November be *cold*, the succeeding October or December is likely to be a dry month.

8. If February, June, or July be very *dry*, the next month has a strong tendency to be warm.

9. If January, March, or April be *wet*, we may also expect the next month to be a warm one. But a wet May or July gives a strong probability of cold weather in June or August respectively.

Mr. W. H. Preece read a paper *On the Best Form to give to Lightning Conductors*. The question was whether the lightning conductor should be a solid rod, or tubular, or flat. Snow Harris, Prof. Henry, M. de Melsens, and M. Guillemin advocated straps of great surface. Faraday strongly maintained that there was no advantage in strap or tube forms, as the surface does nothing in conducting the current. Mr. Preece had obtained the use of Dr. De La Rue's magnificent batteries, and had procured conductors of equal material, length, and weight, but differing in form. A condenser charged from 3,400 cells afforded a very powerful source of electricity, more than forty-two microfarads being thus available to produce an enormous spark. Experiments made by heating and deflagrating wires through the different conductors left no doubt that these discharges do obey the law of Ohm, and therefore that the additional surface of flat and tubular conductors is of no advantage in their conductivity.

Prof. Osborne Reynolds rather doubted the conclusions of Mr. Preece, on account of our not knowing the conditions under which the electricity passes from the air into the surface of the conductor. Prof. Ayrton thought the experiments should be tried with much greater difference of potential. The 3,000 cells would not produce a free spark of more than  $\frac{1}{4}$  of an inch long, whereas flashes of lightning might extend over miles.

Mr. Preece, in replying, pointed out that increased surface, though increasing its inductive capacity, did not add to its efficiency, which depended only on its conductivity.

Mr. Preece also communicated an observation on the peculiar behaviour of copper wires. Very powerful discharges of electricity were found to increase the conductivity of newly-drawn copper wires by an appreciable percentage. Lead wires showed no such changes. In the subsequent debate it appeared that the opinion was that the effect of the first current was to anneal the wire.

*On the Necessity for a regular Inspection of Lightning Conductors*, by Richard Anderson, F.C.S., A. Inst. C.E.—The author referred to a paper by M. W. de Fonvielle, "On the Advantage of keeping Records of Physical Phenomena connected with Thunderstorms," read before this Association in 1872. M. de Fonvielle recommended to the attention of the members the steps which had been taken by the French Government for obtaining information regarding thunderstorms, and suggested that the Association should institute some organisation for the collection of such data; arguing that it would be of much value to science, as well as to the public. Nothing, however, has been done by the Association since 1872; and the author not only confirmed the conclusions at which M. de Fonvielle arrived as to the desirability of collecting such data, but was of opinion that the organisation should go further, and arrange for a regular inspection of all public buildings which had lightning-conductors applied.

The necessity for this he demonstrated by adducing a number of striking cases where damage, more or less severe, had occurred to buildings, even though having lightning-conductors attached to them. The cases now cited, he explained, were supplementary to those communicated in his paper on a similar subject to the Association in 1878. A few of the cases were as follows:—

In October, 1878, an elevated building situated at the back of Victoria Station, occupied as a furniture repository, was struck by lightning and sustained damage, although furnished with a

$\frac{1}{2}$ -inch by  $\frac{1}{4}$ -inch copper band lightning-conductor and a tube of  $\frac{1}{2}$ -inch diameter rising above the iron crestings on the tower. The lightning shattered the cresting and bent the point of the lightning-rod, besides doing other damage to the building. On testing, the author found the resistance very great, and on opening out the earth-terminal found it imbedded in concrete.

On June 26 last, lightning struck All Saints Church, Lambeth, doing considerable damage, although there was a  $\frac{1}{2}$ -inch diameter copper-rope conductor on the west gable, with a copper tube rising 18 inches above. A stone cross about 50 feet from the conductor was thrown down, injuring the roof of the north aisle. On testing the conductor, the author found that it had no "earth" whatever, the rope being simply placed in 2 inches of loose rubbish. The copper was of very inferior quality; conductivity being 32·10 per cent., or about double that of iron.

The author quoted also a few cases from his recent work on "Lightning-Conductors, their History," &c:—

In August, 1878, the Powder Magazine at Victoria Colliery, Burntcliffe, Yorkshire, was struck by lightning, though furnished with a conductor, 13 feet above the building, and terminating in 13 feet of clayey soil. The building was blown to pieces. On testing the conductivity of the copper, it was found to be 39·2, instead of 92 to 94 per cent. The conductor was insulated from the building and from a large iron door, which it ought not to have been.

The author concludes from this evidence that it is not sufficient merely that rods of copper should be attached to a building, but it is necessary that after being fixed they should be regularly inspected, to see if they are in good order, so as to be really efficacious.

Sir Wm. Thomson gave a communication *On a Method of Measuring Contact Electricity*. Sir W. Thomson had devised this method at the time when Hankel published his results in 1861. A method identical with it had lately been described by M. Pellat, and consisted in employing a small electromotive force in connection with a dividing resistance slide, to give a counterbalancing electromotive force to that produced by contact.

Sir W. Thomson next described *A Method of Determining without Mechanism the limiting Steam-Liquid Temperature of a Fluid*. This was a simple apparatus, consisting of a closed glass tube containing liquid sulphurous acid filled to a sufficient height to insure that the liquid in the lower half will expand to the top. Prof. W. Ramsay criticised the proposal, and stated that he had found an apparatus in which a screw was employed to produce increase of pressure instead of using the expansion of the liquid itself. With this apparatus he had repeated Andrews' research on a large number of substances.

Mr. G. F. Fitzgerald read a paper *On the Possibility of originating Wave-disturbances in the Ether*. This was a mathematical paper, in which, by comparing the equations of Maxwell's theory of the propagation of electric action through a medium with those of direct action at a distance, he deduced the conclusion that electric currents and systems cannot originate in the ether such disturbances as those of light.

Mr. R. M. Shida gave an account of *A New Determination of the number of Electrostatic Units in the Electromagnetic Unit*. The value  $V$  of this ratio he deduced was  $294\cdot4 \times 10^9$ .

M. Wilfrid de Fonvielle exhibited his magneto-electric gyroscope, which has been already described in our pages.

Mr. Jan-sen sent a communication to the Section, which was read by the Secretary, upon his recent researches *On the obtaining Positive Photographs by Prolonged Exposure*.

Mr. Wiesendanger showed a new electromotor, which will be described hereafter in our pages.

Mr. Philip Braham exhibited an ingenious adaptation of lime-light for microscopic illumination, and also described a simple instrument for detecting polarised light.

*On the Best Form of Magnet for Magneto Machines*, by W. Ladd.—At the British Association meeting at Dundee in 1867, I made some remarks upon different forms of magnets, and exhibited these diagrams, showing, by the "lines of force" naturally arranged, the great superiority of the circular magnet where an armature is to be employed.

Since that time some thousands of that form of magnet have been made for medical, mining, and other purposes.

Some months ago, in conversation with M. Breguet of Paris, I showed him these same diagrams, and he was very much impressed with their importance; he has since then constructed a machine, using the Gramme armature, and with a smaller quantity of steel in the magnets he has made a far more powerful

machine than hitherto constructed with either the Jamin or the ordinary horse-shoe form. It is also more symmetrical in appearance, and occupies less space.

With this machine I can heat to incandescence nineteen inches of platinum wire by four turns of the handle, while to heat fourteen inches of the same size wire by a machine having a Jamin magnet it took ten turns of the handle.

Mr. Bottomley followed up his report with a paper *On the Elasticity of Wires*. This paper related the effect of adding loads gradually to a wire which carried a load, and which was found to increase in the limit of breaking strain when longer times were allowed to elapse between the successive increments of the load. A charcoal iron wire which bore a load of 41 lbs. when suddenly loaded would support 52 lbs. after having borne the load of 41 lbs. for 790 hours. Some remarks were made by Sir W. Thomson and by Dr. Siemens, who referred to some recent experiments made in Germany of the stretching of wires and rods of steel, which tended to show that protracted tensile strain affected the chemical condition in which the carbon of the steel was combined with the iron in it. Mr. J. E. H. Gordon referred to the connection between the mechanical and magnetic properties of steel under different conditions.

*On the Comparison of Declination Magnetographs at various Places*, by Prof. W. G. Adams.—This paper was accompanied by diagrams of simultaneous magnetic disturbances at St. Petersburg, Kew, and Vienna, showing that many of the sudden magnetic disturbances occur simultaneously over very great areas, but that in some cases the variations were in opposite directions, in the debate which followed Sir Wm. Thomson spoke of these observations as beginning to open out a glimpse of the true cause of the magnetic storms. He observed that if similar records of the other magnetic elements, inclination and intensity, could be procured, we should know definitely whether these disturbances were due to any changes of the magnetism of the earth itself, or whether they were due to an external magnetic action. Magnetic observations had been going on for forty years, and it was a reproach that more had not hitherto been done. He also referred to the alleged connection between aurora and magnetic storms. Mr. J. Glaisher and Staff-Commander Creak mentioned cases of sudden magnetic disturbances. Capt. Creak recalled the observations of the Arctic expeditions of 1875-6, when a deflection of 5° was observed within forty minutes, the Kew records showing synchronously a smaller fluctuation. He argued that an observing station in a more northerly latitude was necessary. Mr. W. H. Preece recounted a magnetic and electrical storm which affected Ireland and the west of England on August 12. Magnetic disturbances always were accompanied by earth currents which affect the telegraph-wires. The same storm affected even the Atlantic cables and the Cape cable. He believed they would be found to have affected the whole earth. The electromotive force on this occasion, through the Atlantic cable, was about as great as that of 300 Daniell's cell, or more exactly one volt per 6.6 miles. Capt. Creak also exhibited the new Admiralty charts of the magnetic variation for 1880.

Prof. G. H. Minchin read a communication *On Photoelectricity*. He had obtained feeble currents from two silver plates coated with sensitive films of iodide, chloride, or bromide of silver, dipping into a common fluid, and then one of them exposed to the light. He had also observed that preparations of fluorescent and phosphorescent bodies upon silver plates acted similarly.

Prof. Silvanus P. Thompson gave a paper *On Electric Convection Currents*, pointing out their analogies with true conduction currents, and of currents of electrolytic conductivity in respect of electro-magnetic phenomena. The application to ring-figures produced by disruptive convection and by electrolytic conduction was considered, and their deformation in the magnetic field. It was pointed out that considerations of a similar nature had been advanced by Prof. Ayrton at an earlier date.

*Experiments on Thin Films of Water, with regard to the Absorption of Radiant Heat*, by the Hon. F. A. R. Russell.—The experiments, the general results of which are given below, were made with the object of ascertaining the diathermancy of water in very thin films, and these experiments afforded incidentally an opportunity of observing the behaviour of films subject to varying conditions.

The arrangement of instruments was similar to that illustrated at p. 383 of Prof. Tyndall's "Heat as a Mode of Motion." The instruments used were: a dead-beat mirror galvanometer and scale, a thermopile, and a screen. The soap film was carried by a piece of a cork sole perforated by a hole slightly larger than

the hole in the screen, about 1¼ inch in diameter. The sources of heat were (1) a copper or iron ball heated from behind by a small gas flame; (2) a gas flame from a Bunsen burner and (3) a hydrogen flame in air.

The film was mostly made from a solution of about half a drachm of shavings of Castile soap, dissolved five to fifteen minutes in about five cubic inches of water, at 60° F.

The film, soon after being placed perpendicularly at the orifice in the screen, exhibited coloured bands, which descended in regular succession until the last band appeared, which contained a bright blue line. The descent of the bands continued at a slackened rate till the grey, and finally the black, occupied a portion of the upper half of the film, which half was alone subject to experiment. A condition more or less of equilibrium then prevailed, the tension of the black portion counteracting the force of gravity. A light yellow or bronze was always the last colour to appear, and preceded the white or grey, which again was succeeded by black. When there was any black in the film, the bursting of the film was marked by a slight click or snapping sound. The best films lasted frequently between ten and thirty minutes, and sometimes the black portion alone was under observation fifteen or twenty minutes.

The following table shows the absorption per cent. for each of the three sources of heat, and the thickness of the film, as derived from a table in Watt's "Dictionary of Chemistry," giving Newton's thicknesses of thin films of air, water, and glass. A table in Cooke's "New Chemistry" gives the thicknesses of soap-films as considerably greater than those stated in Newton's table. The "light film" of Cooke corresponds to my "grey," and his "grey" to my "fine grey." Newton's "white" corresponds to my "grey." The refractive index of the solution used by me was 1.34 and 1.35, a little higher than that of pure water.

State of Film.	Metal.	Gas.	Hydrogen.	Thickness of Film in mil. Months of an inch.
Last band alone ... ..	9?	8?	—	8.3
Bronze ... ..	6	5.7	—	5.2
All grey (white) ... ..	4.7	—	4.5	3.9
Fine grey ... ..	—	3.4	—	1.8
Half grey, half black ... ..	—	2.9	—	2.3
Two-thirds black, one-third grey	—	1.6	1.6	1.8
Half fine grey, half black ... ..	0.7	—	—	—
Black and slight fine grey ... ..	—	—	1.2	1.34
Fine grey and black, or all black	0.29	—	—	—
All black ... ..	0.29	1.5	0.6	0.75

SECTION B—CHEMICAL SCIENCE

*On the Influence of Water on the Union of Carbonic Oxide with Oxygen at a High Temperature*, by Harold B. Dixon, M.A.—The author obtained the curious result that a mixture of carbonic oxide and oxygen in such proportions as to form carbon dioxide, when free, or nearly free, from water, does not explode, either by a direct discharge from a Leyden jar or when sparks are passed through it from a Ruhmkorff coil. By allowing a minute portion of aqueous vapour to mix with the gases, explosion immediately takes place on the passage of the spark. In presence of a very small trace of water, combustion takes place, but slowly, not with explosive energy. The author suggests as an explanation the following equations:—

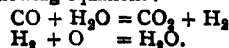

Prof. Williamson suggested that it would be interesting to determine the inferior limit to the power of water vapour in causing an explosion, and that Mr. Dixon would probably extend his research in this direction.

Prof. Harcourt pointed out that various other similar instances are known, among others the impossibility of causing union of calcium oxide and carbonic anhydride, in absence of water, and the refusal of dry chlorine to act on hot sodium.

Mr. Thomas noticed that in mixtures containing large amounts of marsh-gas the presence of water vapour also influenced the rapidity of explosion.

Prof. Silva remarked that the influence of diluents may have a contrary effect from that of water-vapour, and that the question is worth investigation.

*Metallic Compounds containing Organic Radicals, Part I.*, by J. Sakurai.—The author has succeeded in obtaining a compound of methylene iodide,  $\text{CH}_2\text{I}_2$ , with mercurous iodide,  $\text{Hg}_2\text{I}_2$ , of the formula  $\text{CH}_2\text{I}.\text{IHgI}$ . It is a white crystalline substance, insoluble in water, cold alcohol, ether, chloroform, and ethylic iodide. It is soluble in boiling alcohol and in methylene iodide. It melts at  $108^\circ\text{--}109^\circ\text{C}$ .

Besides this substance, another, insoluble in all ordinary solvents, is produced, which possesses the formula  $\text{CH}_2(\text{IHgI})_2$ . Chlorine and bromine act on these substances, forming methylene chlorides or bromides, and halogen salts of mercury. The author proposes to attempt to produce the zinc and sodium analogues of this body.

*On some Relations between the Atomic Volumes of Certain Elements and the Heat of Formation of some of their Compounds*, by Walter Weldon, F.R.S.E.—It has been observed that the heat evolved by the union of chlorine with a metal is greater than that of bromine, and that the heat given off by bromine is greater than that by iodine. In a similar manner oxygen gives off more heat than sulphur. Berthelot has observed that positive elements obey the same rule, but that there are some exceptions caused *par diverses circonstances mal connues*. That the heat of combination is inversely proportional to the atomic weights of the reacting elements is sometimes the case, but is not a general law; but on comparing the heat evolved by combination of positive elements with their volumes, a direct numerical proportion is observable. To this law there are two exceptions, viz. cadmium and manganese. Cadmium is usually classed along with zinc and magnesium, although it closely resembles indium. It compares with magnesium, but not with zinc. The atomic volume of cadmium is greater than that of zinc, yet the heats of formation of its chloride, oxide, &c., are less than those of zinc. The heat of formation of indium compounds, which have not yet been observed, should be greater than those of zinc. In the same way the heats evolved during formation of compounds of manganese are greater than those of iron, yet the atomic volume is less. Either this case is exceptional, or manganese does not belong to the iron group.

In over 100 instances it has been observed that molecular heats of formation of elements of the same group divided by the atomic volumes of the electro-negative elements give numbers either identical with, or bearing some simple relation to, each other.

After some complimentary remarks from Prof. Williamson, Prof. W. Ramsay pointed out that the heats evolved by the combustion of allotropic modifications of carbon and phosphorus bore the same relation to each other as their specific volumes, and hinted that the heat evolved by the combination of elements of the same group with other elements bore some remarkably simple proportion to the relation of the number of atoms in the complex molecules of the solid elements.

*On the Specific Rotatory Power of Cane and Invert Sugar*, by Alfred H. Allen.—The author points out that on inverting sugar its weight is increased by absorption of water, and that allowance is not usually made for this fact. He has therefore calculated the following corrected table for  $S_D$  :—

	$S_D$
Cane-sugar ... ..	+ 73.8
Invert sugar ... ..	- 25.6 at $15^\circ\text{C}$ .
Dextrose ... ..	+ 57.6
Lævulose ... ..	- 108.8 at $15^\circ\text{C}$ .

The deviation for a plate of quartz 1 mm. thick is under similar conditions  $24^\circ$  for its transition tint, and  $21.66^\circ$  for the sodium ray. Hence the corresponding values for  $S_D$  may be calculated by multiplication by  $\frac{21.66}{24} = 0.9025$ .

*On the Identification of the Coal-Tar Colours*, by John Spiller, F.C.S.—The process recommended is the action of sulphuric acid on the dyeing material, taken in conjunction with the shades produced on, and the tendency to dye silk, wool, or cotton. The most remarkable reactions are the following :—Magdala-red with sulphuric acid gives a blue-black; Saffranin, a grass-green, becoming indigo-blue on strongly heating; Chrysoidin, deep orange, turning almost to scarlet on heating; Alizarin, ruby red, or maroon; Eosine, golden-yellow; Primrose (naphthalene-yellow), first yellow, then colour discharged; Chrysaniline, brown fluorescence; Aurine, yellowish brown; Atlas-orange,

rose-colour, changing to scarlet on heating; Atlas-scarlet, no alteration; Biebrich-scarlet, R, blue-black; ditto, B, blue-green; Aniline-scarlet, permanent golden yellow; Indulin, slaty blue to indigo; all violets give a yellow, or brownish yellow; Phenyl and diphenylamine blues, dark-brown solutions; Iodine and malachite greens, bright yellow solutions, the former giving off iodine on heating; lastly, Citronine, a pale cinnamon or neutral tint.

*On the Density of Fluid Bismuth*, by W. Chandler Roberts, F.R.S., and Thomas Wrightson, C.E.—The density of bismuth, just molten, was determined by a modification of the usual process for determining the specific gravity of liquids devised by Mr. R. Mallet, and was found to be  $10.039$ , as a mean of three experiments. By an apparatus termed the oncosimeter, which admits of the weight of a ball of metallic bismuth being taken in molten bismuth by means of a delicate spring balance, its mean specific gravity deduced from six experiments was found to be  $10.055$ ; that of solid bismuth is  $9.82$ .

*On Crystals of  $\text{HgHSO}_4$* , by P. Braham.—Mercury, when left in contact with sulphuric acid for two years, deposits extremely deliquescent crystals of the above formula.

*On the Treatment of Complex Ores containing Zinc*, by E. D. Parnell.—The presence of zinc renders the extraction of lead and copper from their ores so difficult that manufacturers reject them; nor are zinc ores containing less than 25 per cent. of zinc adapted for the extraction of that metal.

*Further Notes on Petroleum Spirit and Analogous Liquids*, by A. H. Allen.—To distinguish petroleum spirit from shale naphtha and from benzene, mix one volume of boiled carbolic acid with three volumes of these liquids. The carbolic acid refuses to mix with the former, but mixes with the two latter. On similar treatment with coal-tar, pitch, petroleum spirit and shale naphtha do not mix, whereas benzene does. With carbolic acid, burning oil from shale can be distinguished from kerosene, the burning oil from petroleum, for the former is not miscible, whereas the latter turns violet, and partially mixes; and if warmed, crystals of carbolic acid separate on cooling. By treatment with nitric acid and with bromine, it was shown that naphtha from petroleum contains 80 per cent. of paraffins and 20 per cent. of olefines; photogene, 55 to 80 per cent. of paraffins, and that wax consists entirely of paraffins; whereas shale naphtha contains 75 to 90 per cent. of olefines; photogene from the same source, 60 to 65 per cent. of olefines, and that the lubricating oil consists entirely of olefines.

*On the so-called Normal Solutions for Volumetric Analysis*, by A. H. Allen.—This communication was a recommendation that the various different meanings of the term "normal" be done away with, and that a normal solution be understood to be one containing in 1,000 cub. cents. such an amount of reacting body as will combine with, replace, or oxidise one gram of hydrogen.

*On the Determination of the Loss of Heat in Steam-boilers, arising from Incrustation*, by William Thomson.—This plan consists of evaporating the various waters in vessels exposing an equal surface of each, care being taken to keep the total amount constant by means of a constant supply. After a given time the remainder is measured and the ratio calculated. Deposit of incrustation greatly impedes evaporation.

*On the Identification of the Ink used in writing Letters and Documents as Evidence in Cases of Libel, Forgery, &c.*, by W. Thomson, F.R.S.E.—The author has observed that different specimens of writing give different coloured reactions with various reagents, such as sulphuric, hydrochloric, nitric, or oxalic acid, or by caustic soda, solutions of bleaching-powder, and chlorides of tin. Such differences may be of use in detecting forgery, for the change of colour affords evidence as to whether all the writing has been performed with the same ink.

*The Effects of Magnesia on Vegetation*, by Major-General Scott, C.B., F.R.S.—The author's conclusion, drawn from numerous experiments, is that there is overwhelming evidence against the notion that soil naturally contains so much magnesia that an extra supply will be of little or no benefit. There are strong grounds for supposing that magnesia, like phosphoric acid, is not only an essential ingredient of plants, and aids in their nutriment, but also that it determines the beneficial action of other ingredients.

*On the Action of Oils on Metals*, by William H. Watson.—Most oils attack copper and iron, but not to the same extent. Some act much more on copper than on iron, and vice versa.

*On Bleaching-Powder Residues*, by J. F. W. Hodges.—To extract active chlorine from 10 grains of bleaching powder, so

that it does not react with starch paper, 5,000 cub. cents. of water are required. Even then it reacts with iodine and starch. The amount of residue varied between 22 and 30 per cent. of the total quantity of bleaching powder. This residue, on treatment with acid, evolved a minute amount of active chlorine; the residue, applied to cotton and treated with acid, has no bleaching or injurious action.

*On the Coal-seams of the Eastern portion of the South Wales Basin, and their Chemical Composition*, by J. W. Thomas.

*On the Refraction Equivalent of Diamond and the Carbon Compounds*, by J. H. Gladstone, Ph.D., F.R.S.—The specific refractive energy (that is, the refractive index - 1 divided by the density) of numerous compounds of carbon was determined by Gladstone and Dale in 1863. From their experiments it was found that carbon uncombined, as in the diamond, and also in combination with hydrogen and oxygen, has a specific refractive energy of 5°. Yet in compounds of the aromatic series, where several atoms of carbon are united by more than one bond, the refraction equivalent is raised about 2°. This does not embrace the facts that the terpenes have a refraction equivalent lying between 2 and 4 over the calculated numbers; that the cinnamyl compounds also show abnormality; and that hydrocarbons containing a greater number of atoms of carbon than of hydrogen increase in refractive energy at a rate more rapid than theory demands. Thus naphthalene shows a surplus of 16.4, anthracene of 31.7, and pyrene of 43.6 over the calculated numbers.

Dr. Bedson, who has been recently investigating the subject in conjunction with Mr. W. Carleton Williams, remarked that sufficient allowance had not been made for dispersion in the last-mentioned instances; that from their experiments they have found the degree of concentration of the solution to exercise a marked influence; and he suggested that in naphthalene, anthracene, and pyrene, the molecules are much more complex than in benzene, for several groupings of carbon atoms are noticeable, among them two groups in which an atom of carbon is united to other atoms of carbon by all four bonds.

*On a New Process for the Production from Aluminous Minerals of Sulphate of Alumina from Iron*, by J. W. Kynaston.—After a preliminary sketch of the various methods of preparing sulphate of alumina in a state of greater or less purity from various minerals containing it, the author describes his own process for preparing it free from iron from bauxite, a silicate and titanate of alumina and iron. This he does by treating it with a mixture of oxalic and hydrochloric acids, allowing it to stand for a week or ten days. The insoluble portion is freed from oxalic acid by repeated washing, and the residue converted into sulphate of alumina by treatment with sulphuric acid. This product is almost free from iron. The oxalic acid is recovered by precipitation with lime, and subsequent decomposition of the salt with sulphuric acid. The expense of this process has prevented its adoption. The author has now devised a process whereby the iron is precipitated as arsenite, and then by means of carbonate of lime neutralising any free acid, and at the same time producing some tetrabasic sulphate of alumina. The remaining ferrous iron is then removed by addition of ferrocyanide of lime. The blue precipitate is induced to settle by addition of a little sulphate of iron or zinc. Excess of arsenic is precipitated with sulphide of lime. This process is at present in operation at St. Helen's.

*On a New Process for separating Silver from Copper Ores and Reguluses*, by William Henderson.—This process is applicable to calcined Spanish pyrites containing a large proportion of arsenic before calcination. The "raw regulus," when fused with 20 per cent. of its weight of sodium bisulphate, yields metallic silver in large amount. The iron and copper are converted into oxides, while the silver remains as sulphate, and may be extracted from the residue with water. The process has as yet been worked only on a small scale.

SECTION C.—GEOLOGY

*Notes on the Submarine Geology of the English Channel off the Coast of South Devon*, by Mr. A. R. Hunt, F.G.S.—Attention was called to the presence of large detached blocks of stone over an area extending from S.S.W. of the Start to S. of the Eddystone. One of these blocks in Torquay was stated to weigh 9½ tons, another not landed measured 3 feet 6 inches. They consisted of granite, conglomeritic grit, serpentine, and sabbrobban.

A paper *On the Site of a Palaeolithic Implement Manufactory at Crayford, Kent*, by Mr. F. C. Sparrell, was read by Prof. Dawkins. This occurred in brick-earths containing a large number of extinct mammalia, and on the same horizon with them. They were probably manufactured on the spot, by the old dwellers, and belong to the same type as the implements of St. Acheul. Many of the specimens when found were completely shattered, and the fragments were united by Mr. Spurrell.

*On the Island of Torghatten, Norway, and on the Influence of Joints on Denudation*, by Prof. W. J. Sollas. Describes a conical or hat-shaped mountain, traversed by a tunnel 600 feet in length, through which the light can be seen. The rock is compact gneiss, *roche moutonnée* occur up to the level of the platform, which terminates slightly below the entrances to the tunnel, which are somewhat lower than the centre. Attributes its origin to mechanical disintegration, aided by joints.

*On the Contortion of a Quartz Vein in Mica Schist from Bodø, Norway*, by Prof. W. J. Sollas. Describes excessively contorted band of quartz between foliation planes.

*On the Geological Age and Relations of the Sewalik and Pikerim Vertebrate and Invertebrate Faunas*, by W. T. Blanford.—The deposits from these two areas have both been referred to the Miocene, and contain an analogous fauna. The Sewalik beds are a portion of a great Tertiary area crossing India from Assam to Sind. The lower beds are nummulitic and marine, the upper series entirely freshwater. Of 48 genera in the Sewalik fauna, with 93 species in the Siwalik area, 12 are peculiar, 4 genera do not occur higher than the European miocene, 25 genera are recent, including cats, dogs, bears, true elephants, antelopes, and sheep. The lower Manchhar mammalian fossils were shown to be older than the Sewalik series, but are newer than the Upper Miocene, and therefore the Sewalik series is referable to the Pliocene. The Sewalik fauna contains six reptiles, of which three are still living. Ruminants are numerous in both the Sewalik and the Pikerim deposits; the latter rest on a bed with Pliocene marine mollusca. Suggests as the climate grew colder in Pliocene times the Miocene mammals migrated southwards.

*On the Relations to be established between Coast-line Direction represented by Great Circles on the Globe and the Localities marked by Earthquakes in Europe*, by Prof. J. P. O'Reilly.—Refers to the rectilinear direction of coast-lines as that between Carnore and Wicklow heads, this if produced and regarded as part of a great circle which passes through the Dykes of Southern Scotland and corresponds to the east coast-line of Scotland north of the Firth of Tay, the Carnore coast-line direction being strictly parallel to the strike of the rocks west of it, and of the termination of the great masses of granite of Kilkenny. Refers to the linear direction of the limit of earthquake-movement in Southern Sweden, and he suggests the similarity of direction in coast-lines and the boundaries of earthquake-movement have the relation to each other of cause and effect, the coast-line being the result of slips along the lines of weakness produced by earthquakes.

*On the Sandstones and Grits of the Lower and Middle Series of the Bristol Coal-fields*, by E. Wethered.—These carboniferous sandstones are composed of angular grains, those of the Millstone Grit being the least so. He describes an intermediate stage between grit and soft clay as "hard duns," of a hardness of 7, being a rock that scratches glass. The Brandon Hill grit yielded on analysis 98.5 per cent. of silica; it is used for mining purposes and for brickmaking. The thickness of the Pennant grit is 970 feet, associated with coal-measures of 2,000 feet thickness. He regards the "Pennant grits" as a local deposit, and as occurring on more than one horizon. The "Duns" contain more alumina, and he considers the silicates (except the silicates of alumina) by the action of carbonic acid gas.

A paper *On the Hiatus said to have been found in the Rocks of West Cork*, by Mr. G. H. Kinahan, was read by Mr. Uscher.—The following classification was given:—

GRIFFITHS	PROF. JUKES	PROF. HULL
Carboniferous slate.	Carboniferous slate.	Carboniferous slate and Coomhoala grit.
Yellow Sandstone.	Upper Old Red.	Kiltoran beds.
Old Red Sandstone.	Lower Old Red.	Glengariff beds (Silurian).
Silurian.	Glengariff grit.	

The author rejects Prof. Hull's view, that an important hiatus and unconformability occurs above the Glengariff beds, and considers that a complete sequence of formations occurs from the Silurians up to the Carboniferous.

*Note on the Range of the Lower Tertiaries of East Suffolk*, by Mr. W. H. Dalton, was read by Mr. Whitaker.—Describes sections obtained in deep wells and borings through the drift. One at Yarmouth proved the chalk to be 500 feet from the surface; between the drift and the chalk there being no less than 300 feet of Lower Tertiaries. These wells also prove the surface of the chalk to be an inclined plane beneath the Tertiaries, and the surface of the Tertiaries beneath the drift also obeys the same law. At Brandfield the chalk was found at 48 feet below the mean sea-level.

*Proof of the Organic Nature of Eozoon Canadense*, by Mr. Charles Moore.—Refers to the opinion of Prof. Moebius, of Kiel, of specimens supplied him by Dr. Carpenter, that the eozoonal structure is referable to the mineral kingdom, which view is also taken by Dr. Otto Hann of Ruthlengen, and describes his own examination of a specimen of Laurentian rock from Canada, supplied him by Dr. Carpenter, and of others by Mr. J. Hind. A specimen weighing twenty grains was decalcified and placed in stoppered bottles in water filtered through asbestos; this when magnified was found to reveal a clear siliceous-looking fibroid growth of organic structure of black gum and olive colours. These curled fibres can only be compared to a bit of polished golden wire. They are formed of three round golden close-set columns. It is not a parasitic shell, for when dry it is rigid; but when moist, curved and curled specimens are flexible. They are not unlike the pedicle to which the capsule of some Rhizopoda are attached; but in such a case they must have been devoured by the eozoon, which is not probable. In addition there is another organic structure, not thicker than a spider's web, like mycelium growth of the present day, and also anomalous bodies, possibly the ova, or gemmules of forams. Refers to a similar mycelium growth, as in Eozoon found on mammalites; also similar structures in the Globigerina of the *Challenger* dredgings from the bottom of the Atlantic.

*On the Post-Tertiary and Glacial Deposits of Kashmir*, by Lieut.-Col. Godwin-Austen.—Refers to the work done by Mr. F. Drew. The author is of opinion that certain deposits containing human remains were deposited by a lake, still existing, but formerly of larger dimensions. Refers the older beds to the age of the upper conglomerates of the Upper Sewaliks. He referred to the deposits at different heights on the banks of the Indus, extending up to eighty feet above the river, forming cliffs or bluffs with angular, probably glacial, deposits. The next terraces occurred at 120 feet, and these again had still higher beds above them, and the author believes the whole of the series reach not less than 1,000 feet in thickness.

*On the Fault-Systems of Central and West Cornwall*, by J. H. Collins.—Fifteen distinct fault-systems, and possibly far more; the older system is newer than the Carboniferous; when the earliest was produced, the country was much the same as it is now. The granite junction-faults are always filled up with schist; these oldest faults are succeeded by the elvan veins; these cut a fissure in the slate rock, which has been bent and distorted, and often faulted; these are nearly all of precisely the same age. The tin-lodes are the next, followed by a second system, crossing the older in an oblique direction. Of still newer date are the east and west copper veins. The eighth system is also copper, known as the Caunta copper lodes. Then followed the ninth system, or cross-courses, running north and south, generally only containing oxide of copper and quartz. The later lodes never contained tin; in the last only quartz. The fifteenth set are the "alluvial faults;" the ancient alluvial tin gravels are traversed by them.

*On the Geology of the Balearic Islands*, by Dr. Phené.—Refers to the cave deposits in the grottos of Antiparos and of the almost mountainous dimensions of the external deposits called Pambuk Kalesi at Hierapolis, in Anatolia. He describes the superb caverns near Artá, la Cueva de la Hermita, in Majorca. The southern portion of the island is Miocene, the more northern begins on the east with a sea-coast of Devonian, followed by Triassic and Jurassic deposits, again succeeded by Devonian. The cave occurs in a fragment of Miocene cliffs. In its vast size and its magnificent columns of uniform thickness it may be compared with the proportions of Westminster Abbey; its dimensions are exceedingly vast, and its lines resemble Gothic and Moorish architecture in their delicate traceries.

*On some Pre-Cambrian Rocks in the Harlech Mountains*, by Dr. Hicks.—Describes the Cambrian area of the Harlech Mountains, where he considers rocks occur equivalent to the felsitic group of Bangor of pre-Cambrian age, and he believes the Harlech

rocks of Prof. Sedgwick rest on these ancient rocks, which form a part of a very ancient anticlinal, the conglomerates at the base of the Harlech group being derived from the felsitic pre-Cambrian rocks beneath.

*On the Action of Carbonic Acid on the Limestone*, by Prof. Boyd Dawkins, F.R.S.—Caves in the limestone are to be looked upon as subterranean watercourses, which are produced partly by the dissolving action of the carbonic acid in the rainwater, and partly by the mechanical action of the streams flowing through them. The insoluble carbonate of lime in the rock is changed into the soluble bi-carbonate and carried away in solution. The additional atom of carbonic acid, however, is in a condition of unstable chemical combination, and if it be removed either by evaporation or by the action of the free current of air, the insoluble carbonate of lime is at once deposited. Hence it is that some caverns have their walls covered with a drapery of stalagmite and the little straw-like pendants from the roof formed round the edges of each drop gradually become developed into columns of various sizes. The stalagmitic pedestals also rise from the floor where a line of drops falls from the roof and ultimately unite with the column let down from above. On the surface, too, of the pools an ice-like sheet of stalagmite gradually shoots across from the sides, and sometimes where the water is still covers the whole surface. Admirable illustrations of all these processes are to be seen in the caves of Pembrokeshire, and especially in the Fairy Cave on Caldy Island.

The rate of the accumulation of carbonate of lime depending primarily upon the access of water and the free access of air, both being variable, varies in different places. Sometimes it is very swift, as for example in the Ingleborough Cave, where a series of observations by Prof. Phillips, Mr. Farrar, and the author extending over the years from 1845 to 1873 give the annual rate at '2946 inch. It is obvious therefore that all speculation as to the antiquity of deposits in cases which are based on the view that the accumulation is very slow is without value.

The mountain limestone ravines and passes are to be viewed in the main as caverns formed in the manner above stated, which have lost their roofs by the various sub-aerial agents which are ever at work attacking the surface of the limestone. If any of these be examined, it will be seen that the tributary caves open on their sides, and in some cases the ravine itself is abruptly terminated by a cavern.

*On a Raised Beach with Diluvial Drift in Rhos Sili Bay, Gower*, by Prof. Prestwich.—This beach is coextensive with a cliff  $1\frac{1}{2}$  mile in length, at the south-west corner of the peninsula of Gower. The cliff is 50 to 80 feet in height, sloping from the top to the parallel range of Old Red Sandstone, consisting of red sandstones and quartz conglomerate. The cliff consist of lenticular, rudely stratified, re-arranged material 40 to 50 feet in thickness; contains neither shells nor bones, and rests on a well-rolled raised beach, with pebble from the Carboniferous limestone, coal-measures, and other measures, its average thickness 8 to 10 feet, but occasionally it is piled up much higher; it contains shell of *Littorinus*, *Purpura lapillus*, *Turritella teribra*.

Prof. Prestwich also read a paper *On the Geological Evidence of the Submergence of the South-West of Europe during the Early Human Period*.—Refers to the residual deposits, consisting of gravel, fragments of rock, exhibiting little or no bedding; of this group is the "Warp" of the Rev. Mr. Trimmer, the "Trail" of Rev. O. Fisher, the result of great cold and weathering; "Head," by Mr. Godwin-Austen, derived from cliffs during severe climate; others have referred it to the denudating action of ice and snow, rain action, and to "waves of translation." All these groups the author correlates; in early days all superficial deposits were referred to the "diluvial theory" of Dr. Buckland. Refers to old river terraces proving the gradual wearing away of the valleys; but the author would revive a portion of the old "diluvial theory" for certain other deposits. He groups the Loess, warp, head, trail, and alluvial deposits occupying the centres of broad valleys, into one group, produced by a flood caused by a great temporary submergence of the land and its subsequent re-elevation, which spread material without rounding the fragments. Coarse *albris* always to be traced from higher to lower levels; shells are rare, *albris* is local, and these beds cover all others, at all levels. Refers to the "warp" of the Thames, as difficult to distinguish from London clay, gradually becoming more gravelly on the lower slopes, and merging into the ordinary valley gravels. The trail lying on the gault of Maidstone was then described, capping the hill, and following down the slope of the hill with an increasing thickness on the lower slopes.

The "trail" of the Severn derived from the northern hills is spread over the central flat regions, and forms the Cotswolds to the east. "Head" is stated to cover all the old beaches of the south of England and of Wales, as at Rottingdean, and Berling Gap, near Worthing, the low cliff behind the South-Eastern station at Dover, both sides of the Bristol Channel, between Calais and Blanc Nez, reaching a thickness of 80 to 100 feet, the height being limited only by the heights of the ground between. The beach often contains erratic boulders, and he refers the raised beach to a period during the glacial episode, but at a time when the present coast-line had obtained. Sangatte Cliff contains delicate land shells and the remains of the mammoth; ground palaeolithic implements. Others occur at Cherbourg and in the Isle of Ré; between there and Gibraltar none are known to occur, though they possibly may be present.

Refers to the clay-gravel or head overlying the raised beach of Portslade, between Brighton and Chichester as containing land shells, palaeolithic implements, and bones of land animals; raised beach and head of Guernsey; these deposits and others on the French chalk, Belgium, and the Rhine country he considers to be due to causes other than the deposition of fluvial material, marine deposits, ice or snow slopes or ice-cap. The *débris* is not a talus, for it slopes as a small angle and increases in thickness in retreating from the hill and slope. The submergence destroyed the palaeolithic man and many of the older animals, and amounted to more than 1,000 feet.

Prof. W. J. Sollas read papers *On a Striated Stone from the Trias of Fortishead; On the Action of a Lichen on Limestone, and On Sponge Spicules from the Chalk of Trimmingham, Norfolk.*

*On the Geological Literature of Wales*, by Mr. W. Whitaker, who gave a list of all the publications that have referred to Welsh geology from the seventeenth century to 1873, containing more than 500 entries.

*Sketch of the Geology of British Columbia*, by Dr. G. M. Dawson, jun., describes littoral deposits of Miocene age, capped by volcanic rocks in the Queen Charlotte Islands. Cretaceous rocks from the Upper Neocomian to the Upper Chalk, equivalent to the Chico group of California, yield the bituminous coals of Manaimo; anthracite occurs at a somewhat lower horizon. The pre-Cretaceous rocks are contorted and disturbed, and those of Vancouver Island are probably of Carboniferous age, and are associated with volcanic deposits; rocks probably Huronian occur in Queen Charlotte Islands. In the Rocky Mountains are Carboniferous and Devonian limestones and Triassic sandstones.

*Notes on the Occurrence of Stone Implements in the Coast Laterite, South of Madras, and in High-level Gravel and other Formations in the South Mahratta Country*, by Mr. R. Bruce Foote.—The author describes high-level (partly laterite) gravels of fluvial and lacustrine origin in the basin of the Gatpratha, and Malprabha tributaries of the Kistna in the South Mahratta country yielded large numbers of several types. He then alluded to the occurrence of well-shaped implements, chiefly of the pointed oval type, and made of hard siliceous limestone, in a great talus of limestone and Deccan trap block cemented by calcareous tufa into a great breccia-conglomerate. This occurs along the foot of the hills north of Kistna and west of Soorapoor, in the Nijam's territory. The implements were found worked out in gullies.

*On the Pre-Glacial Contour and Post-Glacial Denudation of the North-West of England*, by Mr. De Rance, F.G.S., Assoc. Inst. C.E.—The country described is that lying between the Silurian mountains of North Wales and the Lake District, and bounded east by the Carboniferous hills of the Pennine chain. The plains of Lancashire and Cheshire lying at their feet are deeply covered with glacial drift, reaching in one instance, near Ormskirk, a thickness of no less than 230 feet. The deep valleys of the Lake District had attained their present proportions before the Glacial epoch, during which the lakes were excavated, in the case of Windermere, to a depth of 230 feet, or deeper than the English Channel between Boulogne and Folkestone, the bottom of the lake being 100 feet beneath the sea-level. In the valleys of the mountain country the marine glacial deposits are not present, having been re-excavated out by later glaciation, where originally present. In Lancashire, Cheshire, and Flintshire the marine drift occupies an extensive area, and valleys like those of the Ribble and the Irwell, nearly 200 feet in depth, have been excavated in and through them; occasionally the bottom of the valley is beneath the sea-level, pointing to the land being higher in pre-glacial times. A terrace of post-glacial

deposits fringes the glacial area at, and often below, the sea-level, consisting of peat with a forest at the base, resting on a marine post-glacial deposit; the peat-beds are found beneath the sea-level to an extent, in one case, of about 70 feet, and it was pointed out that an elevation of this amount would connect Lancashire, Cheshire, and much of North Wales with the Isle of Man.

#### SECTION D—BIOLOGY

Mr. Gwyn Jeffreys moved and Prof. Rolleston seconded a vote of thanks to Dr. Gunther for his address, which was supported by Dr. Sclater. Prof. Rolleston suggested that in every large town a small rate should be levied in favour of a local museum, which is actually done in Liverpool. He also insisted on the importance of a lecture-room in connection with the national natural history collections.

*On the Classification of Cryptogams*, by Alfred W. Bennett.—In the most recent classification of cryptogams, that by Sachs, in the fourth edition of his "Lehrbuch," he divides Thallophytes (including characeæ) into four classes of equal rank, Protophyta, Zygosporæ, Oosporæ, and Carposporæ. It is proposed in the present paper to retain Sachs' class of Protophyta for the lowest forms of vegetable life; but to restore the primary division of the remainder of thallophytes into Fungi and Algæ, as being more convenient to the student, and at least as much in accordance with probable genetic affinities.

As regards minor points the characeæ are removed altogether from thallophytes, and again constituted into a separate group of the first rank; the myxomycetes are regarded as presenting a low type of structure, scarcely raised above the protophyta, and not exhibiting true sexual conjugation; volvox and its allies are removed from the zygosporæ to the oosporæ; and the phæosporæ are separated off as a distinct order from the fucaceæ.

The thallophytes are therefore first of all divided into three primary classes:—PROTOPHYTA, FUNGI, and ALGÆ. The protophyta are divisible into two sub-classes, *Protomyxocetes* and *Protophyceæ*. The protomyxocetes consist of a single order, the schizomycetes, of which *saccharomyces* is regarded as an aberrant form. The protophyceæ are composed of the protozoocaceæ (including palmellaceæ and scytonemæ), nostocaceæ, oscillatoriæ, and rivulariæ. The *Myxomycetes* are treated as a supplement to the protophyta. The fungi are made up of three sub-classes, employing in the main the same characters as Sachs, but, in their terminology, using the syllable "sperm" instead of "spore." The first division, the *Zygomycetes* (or zygospermæ achlorophyllaceæ), is composed of the mucorini only (including the piptocephalidæ). The second, the *Oomyxocetes* (or oospermæ achlorophyllaceæ), comprises the peronosporæ and saprolegniæ (including the chytridiaceæ). The third, the *Carposporytes* (or carpospermæ achlorophyllaceæ), is made up of the uredinæ, ustilaginæ, basidiomycetes, and ascomycetes, the lichenes being included in the last as a sub-order. The algæ are arranged under three corresponding sub-classes. The *Zygoephyceæ* (or zygospermæ chlorophyllaceæ) is made up of the following orders:—Pandorinæ, hydrodictyæ, confervaceæ (under which the pithophoraceæ may possibly come), ulotrichaceæ, ulvaceæ, botrydiæ, and conjugatæ (the last comprising the desmidiæ, diatomaceæ, zygmenaceæ, and mesocarpeæ). The *Oophyceæ* (or oospermæ chlorophyllaceæ) includes the volvocinæ, siphonæ (with the nearly allied dasycladæ), spheropleaceæ, cœdogoniaceæ, fucaceæ, and phæosporæ. The *Carpophyceæ* (or carpospermæ chlorophyllaceæ) is made up of the coleochæteæ and floridæ.

The CHARACEÆ constitute by themselves a group of primary importance. The MUSCINÆÆ are unchanged, comprising the *Hepaticæ* and *Musci* (including sphagnaceæ). In VASCULAR CRYPTOGAMS it is proposed to revert to the primary distinction into *Isosporia* and *Heterosporia* as most in accordance with probable genetic affinities. The isosporia consist of the filioæ (including ophioglossaceæ), lycopodiaceæ, and equisetaceæ. The heterosporia comprise the rhizocarpeæ and selaginellaceæ. In the terminology of the heterosporia the inconvenience and incorrectness are pointed out of the use of the terms "macrospore" and "macrosporangium;" and it is proposed to call the two kinds of spores and their receptacles respectively *microspore*, *megaspore*, *microsporangium*, and *megasporangium*; or better, in reference to their sexual differentiation, *androspore*, *gynospore*, *androsporangium*, and *gynosporangium*.

*A Reformed System of Terminology of the Reproduction Organs of the Cryptogamia*, by Alfred W. Bennett and George Murray.



—After giving illustrations of the present chaotic state of cryptogamic terminology, the authors proceed to state that the object they have kept in view is to arrive at a system which shall be symmetrical and in accordance with the state of knowledge, and which shall at the same time interfere as little as possible with existing terms. A few new terms are introduced, but the total number is greatly reduced.

In the fourth edition of his "Lehrbuch" Sachs defines a "spore" as "a reproductive cell produced directly or indirectly by an act of fertilisation," reserving the term "gonidium" for those reproductive cells which are produced without any previous act of impregnation. The practical objections to this limitation of terms are pointed out, and it is proposed to restore the term *spore* to what has been in the main hitherto its ordinary signification, viz., any cell produced by ordinary processes of vegetation, and not by a union of sexual elements, which becomes detached for the purpose of direct vegetative reproduction. The spore may be the result of ordinary cell-division or of free cell-formation. In certain cases (*zoospores*) its first stage is that of a naked mass of protoplasm; in rare instances it is multicellular, breaking up into a number of cells (*polyzoospores*, composed of *merisporae*, or breaking up into *sporidia*). Throughout thallophytes the term is used in the form of one of numerous compounds expressive of the special character of the organ in the class in question. Thus, in the protophyta and mucorini we have *chlamydozoospores*; in the myxomycetes, *sporangiozoospores*; in the peronosporae, *conidiozoospores*; in the saprolegniae, oophyceae, and some zygomycetes, *zoospores*; in the uredineae, *teleutozoospores*, *acidiozoospores*, *uredozoospores*, and *sporidia*; in the basidiomycetes, *basidiozoospores*; in the ascomycetes (including lichens), *conidiozoospores*, *stylozoospores*, *ascosporae*, *polysporae*, and *merisporae*; in the hydrodictyaceae, *mezozoospores*; in the desmidiaceae, *auxosporae*; in the volvocineae and mesocarpaeae, *parthosporae*; in the siphonaceae and botrydiaceae, *hyphosporae*; in the cedogoniaceae, *androzoospores*; in the floridaceae, *tetrasporae* and *octosporae*. The cell in which the spores are formed is in all cases a *sporangium*.

In the terminology of the male fecundating organs very little change is necessary. The cell or more complicated structure in which the male element is formed is uniformly termed an *antheridium*, the ciliated fecundating bodies *antherozoids* (in preference to "spermatozoids"). In the floridaceae and lichens, the fecundating bodies are destitute of vibratile cilia; in the former case they are still usually termed "antherozoids," in the latter "spermata," and their receptacles "spermogonia." In order to mark the difference in structure from true antherozoids, it is proposed to designate these motionless bodies in both cases *pollinoids*; the term "spermogonium" is altogether unnecessary, the organ being a true antheridium.

A satisfactory terminology of the female reproductive organs presents greater difficulties. The limits placed to the use of the term *spore* and its compounds require the abandonment of "oospore" for the fertilised oosphere in its encysted stage anterior to its segmentation into the embryo. The authors propose the syllable *sperm* as the basis of the various terms applied to all those bodies which are the immediate result of impregnation. It is believed that it will be found to supply the basis of a symmetrical system of terminology which will go far to redeem the confusion that at present meets the student at the outset of his researches. For the unfertilised female protoplasmic mass, it is proposed to retain the term *oosphere*, and to establish from it a corresponding series of terms ending in *sphere*. The entire female organ before fertilisation, whether unicellular or multicellular, is designated by a set of terms ending in *gonium*.

In the zygomycetes and zygomycetes, the conjugated *zygospores*, or contents of the *zygogonia*, constitute a *zygospERM*; in the oomycetes and oophyceae the fertilised *oosphere*, or contents of the *oogonium*, is an *oospERM*; in the carpophyceae the fertilised *carposphere*, or contents of the *carpogonium*, constitutes a *carposperm*. In this last class the process is complicated, being effected by means of a special female organ which may be called the *trichogonium* (in preference to "trichogyne"). The ultimate result of impregnation is the production of a mass of tissue known as the *cytocarp* (or "sporocarp"), within which are produced the germinating bodies which must be designated *carpospores*, since they are not the direct results of fertilisation. In the carpomycetes no similar process is at present known. Any one of these bodies which remains in a dormant condition for a time before germinating is a *hyphosperm*. In the cormophytes (characeae, muscinaceae, and vascular cryptogams) the fertilised *archesphere*, or contents of the *archegonium*, is an *archesperm*.

In the basidiomycetes, ascomycetes, and some other classes, it

is proposed to substitute the term *fructification* for "receptacle," for the entire non-sexual generation which bears the spores.

In the discussion which followed, Prof. Rolleston and Prof. I. B. Balfour took part, the latter objecting to the proposed alterations in classification and terminology in several points. He believes all the schizomycetes to be degraded ascomycetes, and prefers Sachs' classification of the vascular cryptogams. He also objected to the use of the term "sperm" in the sense proposed.

*Further Remarks on the Mollusca of the Mediterranean*, by J. Gwyn Jeffreys, LL.D., F.R.S.—At the Bradford Meeting of the Association in 1873 I made some remarks on the Mollusca of the Mediterranean, and gave a list of those species which had not yet been noticed as Atlantic, being then 222 in number. Since that time many of the species have been discovered in the Atlantic, or been ascertained to be varieties of other well-known Atlantic species. This list will be found in pages 113 to 115 of the Report. I will now give a list of those Mediterranean species which are also Atlantic, or varieties of other species, on the authority of the Marquis de Monterosato, the Marquis de Folin, Dr. Fischer, the Rev. Mr. Watson, and myself.

BRACHIPODA.—*Argiope cordata*, Risso; *Thecidium mediterraneum*, Risso. CONCHIFERA.—*Pleuronectia laevis*, Jeffreys, a monstrosity of *Pecten similis*; *Mytilus minimus*, Poli; *Nucula convexa*, J. = *L. aegensis*, Forbes, young; *Leda oblonga*, J. = *L. micrometrica*, Seguenza; *L. subrotunda*, J. = *L. minima*, Seg.; *Solenella cuneata*, J. (*Malleola*); *Venus cygnus*, Lamarck = *V. nux*, Gmelin; *Pecciholia insculpta*, J. (*Verticordia*). GASTROPODA.—*Emarginula adriatica*, O. G. Costa; *Trochus scabrosus*, J. = *T. gemmulatus*, Philippi; *Fossarus costatus*, Brocchi; *Rissoa caribera*, D'Orbigny; *R. rudis*, Ph.; *R. maderensis*, J.; *Cecum chierighianum*, Brusina = *C. glabrum*, Montagu, variety; *Vermetes triquetra*, Bivona; *Scalaria cantaneri*, Weinkauff; *Odotomia polita*, Biv.; *O. tricineta*, J.; *O. fasciata*, Forb.; *Eulima microstoma*, Brus.; *E. jeffreysiana*, Brus.; *Natica dillwynii*, Payraudeau; *N. marmorata*, H. Adams; *Solarium pseudoprospectivum*, Br.; *Xenophora mediterranea*, Tiberi; *Trithium costatum*, Da Costa; *C. elegans*, De Blainville; *Triton seguenzae*, Aradas and Benoit = *T. nodifer*, Lam., var.; *Lachesis folinea* (*Delle Chiaje*) Ph.; *Cassidaria echinophora*, Linné; probably *C. tyrrhena*, Chemnitz, is a variety; *Defrancia hystrix*, De Cristofori and Jan.; *Pleurotoma pusilla*, Scacchi = *P. multilimeolata*, Deshayes, var.; *Cypraea physis*, Br.? *Utriculus striatulus*, J.; *Akera fragilis*, J.; *Diphyllidia lineata*, Otto; *D. pustulosa*, Sc. Total 41 species.

This reduces the number of supposed exclusively Mediterranean species from 222 to 181; and it must be borne in mind that the Atlantic Nudibranchs and Cephalopods have never been completely worked out. Philippi's list of Mediterranean Nudibranchs and Verany's list of Mediterranean Cephalopods amount to 58 out of the above residue of 181. When further researches by dredging have been made in the North Atlantic, I believe the difference between the Mollusca in that extensive ocean and in the Mediterranean will be still more diminished, if it do not in time altogether disappear.

### THE MEETING OF THE IRON AND STEEL INSTITUTE AT DÜSSELDORF

THE recent meeting of the Iron and Steel Institute at Düsseldorf was peculiarly interesting, as illustrating the international character of the Society, and also because of the opportunity which it afforded to English members of studying German workshops and methods of manufacture. The papers which were read were mostly by German authors, and dealt with many subjects of importance to those interested in the manufacture of iron and steel. Many of them were of too technical a character to be noticed at length in these pages, but as an exception we may mention the paper on "The Dephosphorisation of Iron in the Converter," by Herr J. Massenez of Hoerde in Westphalia.

This subject has received great attention at the recent meetings of the Institute, but not more so than its importance deserves. We referred at length to the basic process of dephosphorising pig iron, when reviewing the proceedings at the spring meeting, and the paper now before us contains a most satisfactory record of results since attained, together with much valuable information as to the chemical changes which take place during the conversion. The method is best known by the names of the

inventors, Messrs. Thomas and Gilchrist, and its great importance lies in the fact that it enables Bessemer steel and a very pure homogeneous iron to be produced from the poor class of phosphoric iron ore which abounds in the Cleveland district and also in the basin of the Saar, and in Lorraine and Luxembourg, which ores have not hitherto been available for the production of steel, on account of the difficulty of eliminating the phosphorus, the presence of which element is well known to be highly detrimental to the quality of the steel. To the Germans this invention is possibly of greater value than to ourselves, on account of the prevalence with them of the poorer class of ore, and the comparative scarcity of hematite.

At the present moment five German companies are working the Thomas-Gilchrist process, and in the course of a few months many others will be in a position to follow suit.

Herr Massenez gives in his paper a series of chemical analyses, showing the composition of the metal at different stages during the blow. The information contained in these tables is also exhibited graphically by diagrams, in which the quantities of the various elements at the different stages are represented by the ordinates of curves. These "show that so long as the silicon is in combustion the phosphorus not only is not attacked, it actually increases. First of all, as is well known, the silicon is attacked, and is reduced to a mere trace at the expiration of two minutes. A portion of the carbon burns off at the same time with the silicon; however, only after the silicon is reduced does the carbon curve descend rapidly. The manganese curve is from the commencement to the end of the blow regularly decensional, showing that this body oxidises but slowly. The small quantity of copper disappears after the end of the first minute's blow. Surprising is the fact that the sulphur-curve slowly rises till the commencement of the after-blow, and then only decreases partially, or very slowly, at the latter end of the same. The phosphorus is energetically consumed in large quantities after decarbonisation has taken place, and its combustion is the cause of the high temperature at the end of the process. At the commencement of the blow, and during the time the silicon is oxidising, the phosphorus increases in the metal in the proportion as caused by the lessening of the volume of pig iron through the combustion of silicon, manganese, and carbon. After the reduction of the silicon, and during the period the carbon is reduced from 2.72 per cent. to 0.16 per cent., only a fraction of the carbon disappears (from 1.32 per cent. to 1.18 per cent.); afterwards the very rapid combustion of this body takes place, leaving only a trace of the same, a reaction which characterises the whole process."

It is satisfactory to learn from this paper that the chemistry of the process is now thoroughly understood, and that the only difficulties which remain to be overcome are of a purely mechanical nature, and are principally due to the shortness of life of the converter bottoms. The discussion which followed was fully equal in interest to the paper itself, and was taken part in by most of the leading members of the Institute. It bore principally upon the commercial side of the invention, which has hitherto been its weak point. We learn, however, that well-founded hopes are entertained (that this last difficulty in the way of a general introduction of the process is in a fair way of being removed.

In our last review of the proceedings of this Institute we noticed a paper by Prof. Akerman, on "The Hardening of Iron and Steel." This paper, which was taken as read at the spring meeting, was discussed at Düsseldorf. Most of the opinions expressed were necessarily of a rather speculative character, for very little is really known as to the *rationale* of hardening and tempering. Many eminent authorities seemed, however, to be agreed that carbon exists in iron and steel in three separate forms, and not in two only, as has hitherto been supposed, and that the hardening is due only to one of these forms. A point of great practical importance was referred to by Mr. Adamson, viz., the prevalent practice of endeavouring to strengthen steel by tempering in oil. This practice was strongly condemned by Mr. Adamson. He maintains that the dipping in oil, though it may increase the tensile strength of the metal, impairs its elasticity and ductility. We commend this opinion to the attention of the authorities at Woolwich Arsenal. It is well known that the steel barrels of all our guns are tempered by immersion in oil, and if Mr. Adamson's statements be correct, it is not to be wondered at that so many disappointing failures have taken place.

The last paper to which we shall refer dealt with the subject of iron permanent way. It contained an account of the experience obtained on the German state railways of the use of iron instead of timber for sleepers. There are few subjects of greater importance to ironmasters than this substitution of iron for woodwork in the permanent ways of railways, for the amount of metal which would thus be consumed is almost incalculable. The paper, which was read by Privy-Councillor Grütcheff, embodies much valuable information as to the different systems of iron permanent way at present in use. From it we learn that there are at the present moment 1,542 kilometres of line in Germany laid with the new description of sleeper, and that the results obtained are so satisfactory that the system is being continually extended. It is interesting to notice that in Germany the new sleepers are mostly laid on the longitudinal plan, a system which has not given satisfaction in this country. In the discussion which followed, the opinion was strongly stated by English engineers that longitudinal sleepers would be absolutely incapable of withstanding the effects of the very heavy and fast traffic of the main lines in this country.

In conclusion we must congratulate the Iron and Steel Institute on the extended sphere of usefulness and the cosmopolitan character which it has gained by going out of the beaten track, and holding an autumn meeting on the Continent.

#### ANNUAL CONGRESS OF THE GERMAN ANTHROPOLOGICAL SOCIETY

THE Eleventh General Meeting of the German Anthropological Society was held at Berlin during the past month, Prof. Virchow taking the chair and acting as president at each of the six sittings. At the opening sitting, after speeches by Herr von Gossler and the President, in which they reviewed the past and the present condition of the Society, and notably drew attention to its aims and its achievements, Herr Friedel gave a short exposition of his paper "On Prehistoric Discoveries made in Berlin and its Neighbourhood." This was followed by an interesting address from Dr. Schliemann respecting the site of Troy. He re-stated his now well-known convictions, and gave considerable evidence in support of the belief that Homer's Troy was not merely a mythical town, but that it had once actually filled a place in the world's history. "I wish," said the Doctor, "I wish that I were able to prove Homer to have been an eye-witness of the Trojan war. But unfortunately this is impossible. In his day swords were in general use as a weapon, and iron well known as a metal; in Troy, again, swords were unheard of, while of iron the inhabitants knew nothing whatever. So, too, the manners, the customs and the general civilisation which he describes are of an epoch that is centuries later than the one to which the results of my excavations belong. Homer presents to us the legend of Ilium's tragic fate in the form which it had been handed down to him by the bards who had gone before; and, as we have already seen, he invests the traditional account of the war and of the fall of Troy with the colouring of the time in which he lived. Yet he was not without personal knowledge of the actual localities, for his descriptions (both the general one of Troy itself, as also of the plains of Troy in particular) are, if taken as a whole, quite accurate and truthful." At the close of his address, Dr. Schliemann announced his intention of commencing a series of excavations on the site of Orchomenos in Bœotia, the prehistoric capital of the Minyans, on his return to Athens, the Greek Government having accorded him full permission to do this.

At the second sitting, on August 6, after a short address by the President, Prof. Ranke spoke at some length upon the subject of German ethnology and anthropology, pointing out the distinct advance that these sciences had made, and citing, as helps to study, the several important works which had appeared in the country by Lindenschmit, Arnold, Bracht, Poppe, Genthe, v. Sadowald, and other distinguished anthropologists. He specially called attention to the progress that had been made in the science of craniology, it being now nearly always possible to distinguish between a male and a female skull. Prof. Virchow then briefly put forward the proposition that the next (the twelfth) session of the Society should be held at Ratisbon, a town which, for many reasons, he thought was well fitted to serve such purpose. This proposal was carried unanimously, and after an address by Herr Friedel the meeting was adjourned.

Herr Handelmann, at the third sitting, read a valuable paper upon the prehistoric fortresses and earthworks of which traces remain in the Schleswig-Holstein district. This was followed by an address from Dr. Koehl respecting the excavations and prehistoric discoveries that had been made at Meckenheim, near Bonn. Dr. Mehlis, Herr von Jazdzewski, and others also addressed the meeting.

On the following day, August 9, Dr. Kollmann laid before the Society numerous important statistics with reference to the ethnology of Switzerland, and in connection with the division of blond and brunette types, showing where such division may be found to occur. Dr. Tischler's paper upon recent prehistoric discoveries made at Dolkeim, in East Prussia, was also listened to with very great interest.

At the fifth sitting, Herr Fraas, speaking on behalf of the Cartographical Commission, proceeded to show in how far this institution had been of service to the cause of anthropology; he also dwelt upon the need for drawing up accurate maps of the different districts and localities in which prehistoric discoveries had been or would be made.

Pfarrer Dahlem of Ratisbon afterwards addressed the assembly, his subject being, Ratisbon in its relation to archæology past and present. Speaking of the antiquity of the town, he rejected as fabulous the belief of chroniclers that it had been built before the foundation of Rome, or even of Troy, although its early existence is proved by two old Roman finds, the one a military diploma of the time of Marcus Aurelius, dating from A.D. 166, and the other a large block of stone three metres in length and one metre in height, being a fragment of the *porta principalis* of the city. The inscription on this latter clearly sets forth that Marcus Aurelius and his son Commodus had erected the *vallum cum portis et turribus*. As this inscription, from the titles given to the Emperor, was engraved upon the gate either immediately before or closely following the death of Marcus Aurelius, it is indisputable that in the years preceding that time, between about A.D. 170 and 180, the town was built by one of the three legions that the Roman Emperor had recruited from Italy in order to quell an invasion in that part of Germany now termed Bavaria. That this was the probable date may be inferred from the belief that the inscription would surely not have been added until the whole were completed. The lecturer clearly showed that Ratisbon was a town of very great historic interest; the choice of it as a meeting-ground for the next annual conference of the German Anthropological Society is thus in every way a most desirable one.

At the sixth sitting, Prof. Bastian, who was warmly welcomed by his colleagues upon his return from a two years' period of travel, delivered a very eloquent address, in which he pointed out the many difficulties in connection with the study of ethnology and anthropology, and warned his hearers against drawing *à priori* conclusions in dealing with a science that needed such minute and careful research, where the field was so vast, so-limitless a one, and where no clue, however slight, could ever afford to be lightly set aside. "We are occupied to-day," said he, in conclusion, "with a science that as yet is in its cradle, one over which the shadow of many centuries must sweep ere it can reach manhood, but which will then clearly and completely set forth that which has been termed 'the knowledge of man about man,' a science which, though it does not solve the deepest problems of our existence, will yet throw a partial light upon them. And in its construction we are merely builders and masons, content if we may but do our humble part towards this one object, the completion of so great and wonderful a work."

After speeches by Dr. Henning, Dr. Montelius, and others, Prof. Undset of Christiania gave an interesting account of the recently-discovered Viking ship that has been excavated from a large burying-mound at Sandefjord, in the vicinity of Christiania. The mound in question has always been termed "The King's Mound" (*Königshügel*), and until last winter no excavations had ever been attempted there. Under the superintendence of Prof. Nicolaysen, however, operations were then commenced, which resulted in a most interesting and extraordinary discovery. Beneath the hill was found a large ship, seventy-five feet in length, sixteen feet in breadth, and about seven or eight feet in depth. In it a kind of vault had been built, wherein were deposited the remains of some valiant sea-king who, may be, had won his people's love and reverence. The ship had been buried fully rigged, with masts, cordage, sails and rudder all complete, the entire timbers being in a wonderful state of preservation, owing to the fortunate circumstance that the mound had been con-

structed of a moist clay. In all its details the vessel appears to have been most beautifully finished, and there is no lack of ornamentation. In the hold, together with the human remains, were found the bones of several horses and dogs that had evidently been buried with their master. Prof. Undset considered that the burial must have taken place some time during the tenth century. The ship was conveyed to Christiania, where it was at once placed in the University Museum for Prehistoric Antiquities in that city. Several photographs have been taken of it, and the results of further investigation and research respecting it will shortly be published in a longer and more detailed form.

Herr Ranke then delivered an address upon the prehistoric discoveries that had been made in the caves of Upper Franconia; and Prof. Schaffhausen of Bonn also spoke with reference to important researches made in the caves at Gerolstein, at Letmathe, and Eiserfey. The interest of this sitting—the final one—centred in the speech of Herr Brugsch Bey, the distinguished Egyptologist, who, in the course of it, pointed to Egypt as a rich and valuable field for prehistoric research.

### OUR ASTRONOMICAL COLUMN

SOUTHERN VARIABLE STARS.—In the *Uranometria Argentina* amongst the large number of stars indicated as variable, we find twelve to which Dr. Gould has applied the letters of Argelander's nomenclature, their fluctuations having been determined with greater certainty than some others. The following is a list of these objects arranged in order of right ascension:—

No.	Name.	R.A. 1875. h. m. s.	N.P.D. 1875. °	Limits of Variation.
1 ...	R Sculptoris ...	1 21 13 ...	123 11'5 ...	5'8-7'7
2 ...	R Eridani ...	4 49 42 ...	106 37 2 ...	5'4-6'0
3 ...	S Eridani ...	4 54 7 ...	102 43'4 ...	4½-5½
4 ...	R Puppis ...	7 36 2 ...	121 22'3 ...	6½-7½
5 ...	R Carinæ ...	9 29 6 ...	152 14'2 ...	4½-10
6 ...	R Velorum ...	10 1 27 ...	141 34'8 ...	6½-7½
7 ...	R Antliæ ...	10 4 22 ...	127 7'1 ...	6½-8
8 ...	S Carinæ ...	10 5 23 ...	150 56'3 ...	6½-9
9 ...	T Carinæ ...	10 50 18 ...	149 51'2 ...	6½-6½
10 ...	R Muscæ ...	12 34 28 ...	158 43'3 ...	6'6-7'4
11 ...	R Centauri ...	14 7 35 ...	149 19'8 ...	6-10
12 ...	R Triang. Aust. ...	15 8 37 ...	156 2'1 ...	6'6-7'5

1. Gould describes this as "one of the most brilliantly coloured stars in the heavens"—an intense scarlet, which remains unchanged through all the stages of its light. Maxima occurred early in December, 1872, and in January, 1874. Period about 207 days with symmetric light-curve.

2. Variation independently shown by the estimates of three observers, to the extent of more than half a magnitude; red.

3. 64 Eridani—"certainly variable;" Bessel calls it 8m. in his zones, which Gould conjectures may be owing to clouds, or a misprint.

4. Though appearing to the naked eye and even with the opera glass as a single star is in fact a cluster of faint stars = 3094 of Herschel's Cape Catalogue. There is only one star in it brighter than 8½, and Gould assumes that the variations of brilliancy are due to this star alone. The object is Lacaille 2916.

5. Lacaille 3932, noted by him 7m. on March 3, 1752. The intervals between the maxima determined at Cordoba, are respectively 329, 306, and 323 days; the minimum appears to take place considerably more than half a period later than the maximum; red in all stages even while at the tenth magnitude. No epoch of maximum is given.

6. R Velorum. The variable character is beyond question. It is Lacaille 4156.

7. R Antliæ. Estimated near the brighter limit March 19, 1871, and in May, 1872; near the fainter one April 28, 1873, and June 14, 1874.

8. S Carinæ. A reddish star, Lacaille 4189. On May 21, 1874, it was 6'3, and in May, 1877, 8½, but sufficient observations have not yet been made to determine the law of variation.

9. T Carinæ. Period not yet ascertained. Lacaille 4530.

10. R Muscæ. Varies through nearly a magnitude in not far from 21h. 20m., the minima preceding the maxima by nine hours; its period is therefore the shortest yet detected amongst the variables, and it becomes an object of unusual interest. At midnight on September 25, 1872, the star was estimated equal

to Lacaille 5079, corresponding to a maximum, and at the same hour on September 30 it was inferior to  $\delta$  Muscæ, or very near a minimum. It is Lacaille 5236.

11. R Centauri. The light-curve appears to be irregular; a maximum of 6<sup>m</sup>. occurred about June 28, 1878, and one about August 3 in the preceding year; there would appear to be secondary maxima and minima. A period of 525 days with principal maximum April 18, 1871, and two intermediate maxima following the principal one by 197 and 378 days respectively, reconciles most of the observations, but is incompatible with estimates of 6m. made on June 25 and 26, 1874, with the meridian circle.

12. R Trianguli Australis. Varies between 6<sup>6</sup> and about 8<sup>0</sup> in 3d. 9h. 35m., the minima preceding the maxima by about 48 hours. Well-marked maxima occurred 1871, July 14, at 14h., and September 13 about midnight. Minima were observed 1871, July 12, at 14h., and September 1 at 8h. Good determinations were made in 1877, but are not printed in the *Uranometria*; the period 3d. 9h. 35m. is however deduced from a comparison of the observations in 1871 and 1877.

To these stars may be added S Puppis of Lacaille, which designation falls in with Argelander's (R.A. 7h. 43m. 6s., N.P.D. 137° 48' 3"); it appears to fall nearly to the ninth magnitude, and to rise to about 7<sup>4</sup>, but has never been seen at Cordoba sufficiently bright to be admissible in Gould's Catalogue. It is Lacaille 2999.

Also Lacaille 2691 (L<sub>2</sub> Puppis), a red star varying from 3<sup>6</sup> to 6<sup>3</sup>; Gould infers a period of about 135 days, with a variation rapid at the maximum and comparatively slow near the minimum, which apparently occurs about six days nearer to the preceding than the following maximum. Remarkably red near the minimum.

CERASKI'S NEW VARIABLE STAR.—Prof. Julius Schmidt, favoured by the fine sky of Athens, has already determined approximately the period of this star, which appears to be 4d. 23h. 35m.; he does not think it probable that this interval can be a multiple of a period. The star is in the same category as Algol,  $\delta$  Librae, V Coronæ,  $\lambda$  Tauri, and S Cancri, and is without colour. It may be well to note that for some time to come or until the latter part of December the minima will occur during daylight in this country; one of the first observable may be expected on December 24 about 17h. Greenwich time. The position of the star in the *Durchmusterung* is in R.A. oh. 49m. 39s., Decl. + 81° 5' 6".

A NEW COMET.—The discovery of a faint comet by Mr. Lewis Swift is telegraphed from Washington; position August 11, apparently in about R.A. 172°, N.P.D. 22°.

### GEOGRAPHICAL NOTES

DR. MATTEUCCI sends home some interesting details of the observations made by him in Kordofan during the march of the expedition under Prince Borghese. In Kordofan, he says, water is as dear as the wine of Barletta. In the rainy season however things are different; from June to September almost every inch of the country is covered with water, when, if one may not die of thirst, there is a chance of his dying of malaria. Vegetation along the line of march of the expedition was as melancholy and infertile as it could well be; stunted skeleton acacias alternating with a few euphorbias in constant monotony; neither mountains nor hills, and not even plains. In Kordofan the ground presents continuous undulations, no doubt in consequence of the geological formation of the soil, which is a bottom of sand slightly mixed with peroxide of iron. The water of the rainy season is husbanded in wells, but so valuable is it that the expedition had often to force the natives to give them access to these wells. Kordofan is about 600 metres above the level of the sea, and 380 above that of the Nile. Not a river, not a torrent, not a brook waters this immense territory, which is about 500 miles long and a little less broad. The mean temperature is not less than 92°. At the surface the ground is so sandy that animals on the march sink to a depth of 30 centimetres. The rains are irregular and never abundant. Some years ago there were no wells in Kordofan; the want of water was not felt, for the natives, in the rainy season, collected the water in large reservoirs, and a sufficient quantity was found in them at each station and village. But the seasons, even in Africa, tend to change. Eight years ago there was no rainy season in Kordofan, and for several months the people feared

they would all die of thirst. Then they thought of digging wells, which gave very good results. Everywhere water was found at a depth of 20 inches. But things have sadly changed during the past eight years, and now, instead of finding water at a depth of 20 inches, it is often not found at a depth of 160 feet. In all the wells Dr. Matteucci found the following succession of strata:—From 50 to 30 metres of depth, sand with traces of sulphate of lime; above 30 extends the granite, with a great abundance of quartz in proportion to feldspath and mica. The granitic mass rarely exceeds one metre in thickness, and above is again found the sand.

By letters from Senegal published in the French papers we learn that the survey of the country between the Senegal and the Niger is in progress. Three different topographical parties have been formed to determine the position of the intended ports and the route of railway intended to connect the two streams. The work must be quite finished by the month of May, 1881.

RECENT letters from Ladakh, according to the Indian papers, state that some Yarkand traders have arrived there, having accomplished the journey from Yarkand to Leh, a distance of 515 miles, in thirty-two days. These men report that they met Mr. Ney Elias, the well-known traveller, on the ascent of the Sasser Mountain. The Sasser Pass, which lies at an elevation of 17,500 feet, is nine stages distant from Leh, on the summer route to Yarkand, by way of the Karakoram. The traders also report that the road beyond the Sasser Pass was in good condition and free from snow early in May. They state that the Chinese are quietly established in Yarkand and Kashgar.

M. DE LA MOTTE has published as a quarto pamphlet the address which he delivered before the French Geographical Society on July 16, respecting his studies in the basins of the Niles. He has devoted several years to the subject, and has had a special map constructed to illustrate his researches on a scale of 1 : 1,200,000.

MESSRS. CASSELL, PETTER, AND GALPIN will publish at the end of September the first monthly part of Prof. Ebers' "Egypt: Descriptive, Historical, and Picturesque;" translated by Clara Bell, with notes by Dr. Birch, of the British Museum. The work will be profusely illustrated, and will occupy about three years in publication.

### SCIENTIFIC SERIALS

THE *Journal of Anatomy and Physiology, Normal and Pathological*, vol. xiv., part 4, July.—Dr. H. S. Wilson, on the rete mirabile of the narwhal (two plates).—W. J. Walsham, observations on the coronary veins of the stomach (a plate).—Note on the same, by Prof. Turner.—F. W. Bennett, a communication between the air-bladder and the cloaca in the herring.—Prof. M. Watson, the curvatores coccygis muscles of man.—Dr. G. A. Gibson, valvular hæmatoma (plate).—R. Maguire, a contribution to the pathology of macroglossia and hygroma (plate).—Dr. J. Dreschfeld, the changes in the spinal cord after amputation of limbs (plate).—Dr. B. C. Waller, the morbid anatomy of certain forms of post-scarlatina nephritis in relation to their bearing on the histogeny of granular kidney (plate).—Dr. J. G. Naismyth, the antagonism of opium and belladonna illustrated by a case of attempted suicide.—Dr. R. J. Anderson, on an astragalo-scapoid bone in man.—Dr. Foulis, the mode of healing in wounds under antiseptic dressings.—Prof. M'Kendrick, the respiratory movements of fishes (plate).—G. B. Hones, some points in the anatomy of the porpoise (plate).—Prof. Turner on two masks and a skull from islands near New Guinea (plate).—Dr. D. Newman, the effect of certain anæsthetics on the pulmonary circulation.—H. Bendall, a new method of preserving the colour of tissues.—J. Macdonald Brown, variations in myology.—Dr. G. A. Gibson, anatomical and physiological notes.

*Bulletin de l'Académie Royale des Sciences (de Belgique)*, No. 6.—On the application of the second principle of thermodynamics to the variations of potential energy of liquid surfaces, by M. Van der Mensbrugge.—Structure of the ovary, ovulation, fecundation, and the first phases of development in Cheiroptera, by MM. Van Beneden and Julin.—An original Ctenides of Brazil found at Liège, by M. Van Beneden.—Account of a case of oestodic tuberculosis, with some observations on the eggs of *Tamias mediocanellata*, by the same.—Difference of appreciations of the apparent size of microscopic objects by different observers, by M. Montigny.

*Brain, a Journal of Neurology* for July, 1880, contains: Original articles, by Prof. J. C. Dalton, on the form and topographical relations of the *corpus striatum*.—R. P. Oglesby, on nystagmus (gives some very interesting facts relative to symptomatic nystagmus).—Dr. A. Waller, on muscular spasms, known as "tendoo reflex."—Dr. J. Hughlings-Jackson, on right- or left-sided spasm at the onset of epileptic paroxysms, &c.—Dr. W. Ireland, on left-handedness.—With critical digests and notices of books, clinical cases, and several abstracts of British and foreign journals; among these latter a note by Allen Thomson on Prof. Carlo Giacomini's method of preserving the brain by chloride of zinc, alcohol and glycerine, which he thinks most valuable.

*Rivista Scientifico-Industriale*, No. 11, June 15.—Concentrated sulphuric acid is volatile at ordinary temperatures, by Prof. Marangoni.

No. 12, June 30.—On a new apparatus for collecting rain and atmospheric dust, by Prof. Sylvestri.—On the development of the *Forficula auricularia*, Linn., by Prof. Camerano.—Some experiments on the discharge in rarefied gas, by Prof. Righi.

SOCIETIES AND ACADEMIES

PARIS

**Academy of Sciences, August 23.**—M. Wurtz in the chair.—The following papers were read:—Meridian observations of small planets at the Greenwich and Paris observatories during the second quarter of 1880, communicated by M. Mouchez.—Distinctive character of the pulsation of the heart, according as the right or left ventricle is examined, by M. Marey. During a stoppage in respiration the right heart shows a diminution in amplitude of pulsations, owing to pulmonary resistance, while the left heart shows a slight increase. If through any influence lowering the arterial tension (such as muscular exercise, inhalation of nitrite of amyl, &c.), waves be produced in the aorta, these waves cause in the tracing of pressure of the left ventricle a bifurcation or trifurcation of the summit (according as two or three have occurred during systole). The right ventricle does not show these waves, unless in vestige, and by propagation from the neighbouring part.—Remarkable example of vertically-ascending lightning, by M. Trécul. This was during a storm on Aug. 19. The sparks appeared to come from some lightning conductors in the place. Some rose singly and disappeared at a small height, expanding into a magnificent, nearly circular flash, the light of which diminished from centre to circumference. In one case two luminous columns rose simultaneously and parallel, and at a certain height precipitated themselves against each other at a right angle.—The death of M. Godron, correspondent in botany, was announced.—The sun would act inductively on the earth even if its magnetic power were simply equal to that of our globe. Induction of the moon by the earth and diurnal lunar variation of terrestrial needles, by M. Quet. The induction of the earth by the sun could be insensible only if the magnetic power of the latter were much below that of the former, which is not probable. The induction of the moon due to its revolution round the earth produces an electromotive force twenty-one times less than that the effects of which are rendered sensible by an experiment made on the earth, and consequently is itself sensible. As the induction of the satellite by rotation of the earth is about twenty-seven times greater than the foregoing, the resultant will be a sensible force with sensible reaction on particular earth-currents, leading to a daily variation of needles according to lunar hours.—On the variations of the coefficient of dilatation of glass, by M. Crafts.—On tungstoboric acid, by M. Klein.—On the products of distillation of colophony, by M. Renard.—On the project of establishment of a station for hospitable purposes at the sources of the Ogooué, by the French Committee of the African Association, by M. Mizon.

August 30.—M. Wurtz in the chair.—The following papers were read:—On *Vitis berlandieri*, a new species of American vine, by M. Planchon.—M. de Lesseps reported the proceedings at the inauguration of the statue to Denis Papin at Blois, on August 29 (when he represented the Academy).—On the dilatation and compressibility of gases under strong pressures, by M. Amagat. He gives a series of laws to which his researches have led.—Observations of a solar protuberance on August 30, 1880, by M. Thollon. A thin, very brilliant jet was observed (about 11 a.m.) to rise near the equator, and nearly at right angles to the sun's limb; its velocity was estimated at 35 km. per second, and its height 343,000 km. It rapidly

attained prodigious dimensions, while its brightness diminished, especially near the base. About 1 p.m. it was hardly visible. Curiously, while the lower and middle part of the protuberance gave a deflection of the line C towards the violet, the summit presented a nearly equal deflection towards the red.—On the amylamines of inactive amylic alcohol, by Mr. Plimpton.—The star-fishes of the deep regions of the Gulf of Mexico, by M. Perrier. This is a study of star-fishes dredged by Mr. Alexander Agassiz on board the *Blake* in two consecutive years.—Influence of alkaline or acid media on Cephalopoda, by M. Yung. M. Richet's law regarding crayfish (that acid or basic liquids are not toxic in direct ratio of their acidity or basicity); M. Yung verifies for Cephalopoda. The latter are extremely sensitive to mineral acids. With 0.5 cc. sulphuric, nitric, hydrochloric, or oxalic acid in a vessel holding two litres of water, the respirations of four *Eledone moschata* were raised from twenty-four to numbers varying from thirty to fifty-six per minute. Double the quantity of acid was fatal, except in the case of oxalic acid. Of the other three sulphuric acid is least poisonous. Of the much less powerful organic acids, tannic acid acts most rapidly. The alkalies act in the order given by M. Richet. The action of ammonia is extremely rapid.—Influence of coloured lights on the development of animals, by M. Yung. He confirms for marine animals (at the Naples station) the results he formerly obtained with fresh-water animals. The development of eggs of *Loligo vulgaris* and *Sepia officinalis* is stimulated by violet and blue light, retarded by red and green. Yellow light in this respect comes nearest to white. Contrary to former results, the development, though retarded, is well accomplished in red and green vessels.—On the vaso-dilator nerves of the sides of the mouth, by MM. Dastre and Morat.—On a particular mode of asphyxia in poisoning by strychnine, by M. Richet. The asphyxia first relieved by artificial respiration, is due to two causes, viz. contraction of the tetanised respiratory muscles, and exhaustion of the nervous centres of respiration. But there is another asphyxia resulting from the enormous interstitial combustion in the tetanised muscles, shown by the dark hue of the blood. Hence the necessity of practising artificial respiration very energetically so long as there is convulsive tetanus, so as to replace the oxygen that has disappeared. Substances preventing tetanus (such as chloroform, alcohol, or curare) should also be introduced.—On the intensity of some phenomena of atmospheric electricity observed in the north of the Sahara, by M. Amat. Without insulating himself he could, by passing a pocket-comb through his hair or beard, produce sparks 0.05m. to 0.07m. in length. This was best in the evening after a long ride on the arid plains, in hot, dry weather. Horses present even more striking electrical phenomena in their tails, &c. The electricity liberated by the tails is positive. Man in direct communication with the ground does not show much accumulation of the electric fluid, and friction is necessary to develop it. The fluid accumulates much more on the horse, the horn of the hoofs acting as insulators.

CONTENTS

	PAGE
ENGLISH AND AMERICAN BEE-KEEPING . . . . .	433
OUR BOOK SHELF:—	
Bergsma's "Rainfall of the East Indian Archipelago; First Year, 1877."	434
"Botanische Jahrbücher für Systematik, Pflanzengeschichte und Pflanzengeographie."—W. B. HEMSLEY . . . . .	434
LETTERS TO THE EDITOR:—	
The Conditions Necessary for the Existence of Matter in the Liquid State—Existence of Ice at High Temperatures.—TROUS.	
CARNELLEY . . . . .	434
A Doubtful British Mollusk.—GRANT ALLEN . . . . .	435
A Halo.—MISS L. SOAMES . . . . .	435
Tone of Violins.—LEWIS WRIGHT . . . . .	435
ADOLPH EDOUARD GRUBE . . . . .	435
THUNDERSTORMS. IV. By Prof. TAIT . . . . .	436
PHYSICS WITHOUT APPARATUS, IV. (With Illustrations) . . . . .	438
NOTES . . . . .	440
THE BRITISH ASSOCIATION . . . . .	442
Reports . . . . .	442
Section A—Mathematical and Physical . . . . .	443
Section B—Chemical Science . . . . .	447
Section C—Geology . . . . .	447
Section D—Biology . . . . .	447
THE MEETING OF THE IRON AND STEEL INSTITUTE AT DUISBURG	
ANNUAL CONGRESS OF THE GERMAN ANTHROPOLOGICAL SOCIETY . . . . .	447
OUR ASTRONOMICAL COLUMN:—	
Southern Variable Stars . . . . .	447
Ceraski's New Variable Star . . . . .	447
A New Comet . . . . .	447
GEOGRAPHICAL NOTES . . . . .	447
SCIENTIFIC SERIALS . . . . .	447
SOCIETIES AND ACADEMIES . . . . .	447

THURSDAY, SEPTEMBER 16, 1880

## THE TOOTHED BIRDS OF KANSAS

*Odontornithes: a Monograph of the Extinct Toothed Birds of North America.* By Prof. O. C. Marsh, Yale College. Vol. I. of Memoirs of the Peabody Museum of Yale College, New Haven, Conn., and Vol. VII. of the Geological Exploration of the 40th Parallel.

WEST from the valley of the Mississippi the stratified formations which underlie the prairie region spread over thousands of square miles nearly as horizontal as when they were deposited. Here and there they have been ridged up into anticlines, now deeply trenched by denuding agents, or have had wedges of the ancient Archæan rocks thrust through them, along the flanks of which their upturned beds can be examined in detail. Hence in spite of their prevalent flatness opportunities are afforded for tracing their stratigraphical succession from top to bottom. They reach a maximum of thickness of some seven or eight miles. Yet throughout this vast depth of strata the unconformabilities seem to be nearly all of local and unimportant character. The several geological systems follow each other continuously, and generally in such a sequence of insensible gradation as to show that geological history in that part of the globe was marked by comparatively few great and destructive geographical revolutions. The record of this history remains in an almost unbroken series of strata from the Primordial zones up into the older Tertiary formations.

Here surely if anywhere in the world there should be a tolerably ample chronicle of the sequence of living creatures, so far at least as regards marine forms. If the intermediate types, so much desired by the evolutionist, are ever to be found imbedded in the rocks of the earth's crust, surely here we may expect to find them. An area of continuous tranquil deposit, and of slow subsidence, unaffected for almost the whole of geological time by serious upheaval, metamorphism, or unconformability, containing within itself a well-nigh unbroken record of geological changes—a very promised land for the palæontologist! Hardly more than a dozen years have passed since this great region began to be systematically searched for organic remains. Yet during that brief period what treasures have come from its teeming strata! New orders of Vertebrates, some of them of extraordinary types, have thence been added to the long roll of organic forms. Other orders, scantily developed in Europe, and previously but little known, have been ascertained to have teemed in these far western plains. Whether we regard the prodigious number of individual specimens, and the great variety of genera and species, or the marvellously perfect state of preservation in which the remains occur, there is no other known area where facilities for palæontological research of the most minute and thorough kind exist so abundantly.

Thanks to the labours, first of the universally-honoured Joseph Leidy, and then of his younger successors, Marsh and Cope, the firstfruits of that rich palæontological harvest have already been gathered. In the Yale College Museum alone about 1,000 new species of extinct Vertebrates have been received from the West during the past

Vol. XXII.—No. 568

twelve years, at least one-half of which remain to be investigated. Mr. Cope's museum at Philadelphia is likewise crowded with new forms. If such results have been achieved merely by expeditions equipped for at most but a few months of such labour as is possible at present in these wilds, what may not be looked for when some of the habitable portions of the fossiliferous regions come to be searched, when quarries, railway cuttings, and other artificial openings add to the opportunities of exploring the rocks, and when systematic fossil-hunting can be carried on from a near centre of supplies, instead of from a base several thousand miles away in the Eastern States!

Among the organic wonders of which from time to time during the past decade announcements have appeared, none have been received with more interest than the discovery of birds with 'teeth, made by Prof. Marsh near the end of the year 1870, in the middle Cretaceous rocks, which in Kansas and Colorado spread out eastward from the base of the Rocky Mountains. The more striking features of this remarkable transitional ornithic type were described by Mr. Marsh as far back as 1872, and are now tolerably familiar to naturalists from his writings, and to geologists from the descriptions and restorations which have appeared in scientific journals and text-books. But its detailed structure has only now been made known in the splendid monograph on *Odontornithes* which has just appeared. This work is intended to form volume vii. of the Geological Exploration of the 40th Parallel, carried out by Mr. Clarence King for the Engineer Department, and also to stand as the first of a series of memoirs of the Peabody Museum of Yale College. As a fitting termination to the noble Survey series of quartos, and as a splendid forerunner for what we hope will prove a long and illustrious series of memoirs from Yale, the volume is doubly welcome. The splendour of paper, printing, drawing, and engraving (and in the advanced copy with which we have been favoured, the sumptuousness of binding) that have been lavished on the work bespeak preliminary acknowledgment.

So perfect a matrix do the peculiar buff, chalky, or marly beds of the Kansas middle Cretaceous formations furnish for the preservation of organic remains, that almost every bone of the skeletons of some of the birds has been recovered. The materials for the study of their osteology is thus almost as ample as that for any living bird. Full advantage of this abundant store of material has been taken. The cases and cellars in the Peabody Museum at New Haven contain the remains of about fifty different individuals of a single bird. Every bone of its skeleton, with the exception of one or two terminal toe-bones and the extreme point of the tail, has been recovered, and is here carefully drawn of the natural size. Never before has it been possible, we believe, to reconstruct so perfectly so ancient an organism.

The volume is divided into two parts. In the first of these the detailed structure is given of the bird on which the author has bestowed the name of *Hesperornis*. The skeleton of this animal if extended to its full length would measure about six feet from the point of the bill to the end of the tail. It must have been a typical aquatic bird, without any power of flight, but with strongly developed limbs and a long flexible neck, whereby it was doubtless endowed with remarkable powers of diving and swimming,

X

and of seizing the abundant fishes of the shallow seas in which it lived. Compared with our modern birds, the two features of this ancient form which most forcibly arrest attention are the teeth and the legs. The teeth were covered with smooth enamel, terminating upward in conical pointed crowns and downward in stout fangs, closely resembling those of mosasauroid reptiles. Their mode of growth and replacement have been determined to have taken place in a manner very similar to that in some reptiles, the young tooth forming on the inner side of the fang of the tooth in use, and increasing in size, while a pit for its reception was gradually made by absorption. The old tooth, being progressively undermined, was finally expelled by its successor, the number of teeth thus remaining unchanged. The teeth were implanted in a common alveolar groove, as in *Ichthyosaurus*. In the upper jaw they were confined to the maxillary and entirely absent from the pre-maxillary bone; in the lower jaw they extended from near the anterior extremity of the ramus along the entire upper border of the dentary bone. Mr. Marsh believes that they were held in position by cartilage which permitted some fore and aft movement, but on the decay of which after death the teeth readily became displaced and fell out of the jaw. This is an important fact in its bearing upon the nature of the teeth found on the same slab of Solenhofen limestone with the well-known *Archæopteryx*. These teeth, it will be remembered, were referred by Mr. Evans to the bird itself—a reference fully confirmed by Mr. Marsh, who says that he at once identified the teeth as those of birds and not of fishes, and by the subsequent discovery of other remains of the bird. In *Hesperornis regalis* there appear to have been fourteen functional teeth in the maxillary bone and thirty-three teeth in the corresponding ramus of the lower jaw. The wings are rudimentary or aborted, a remnant of the humerus alone existing. They may have gradually diminished from disuse until, as the power of flight ceased, the legs and feet increased in proportion, and assumed the massive dimensions shown in the specimens, or, as Mr. Marsh suggests, the bird may have been a carnivorous aquatic ostrich, never having possessed the power of flight, but descended from a reptilian ancestry which is strongly recalled by different portions of the skeleton. Among recent birds, the peculiar legs and feet of *Hesperornis* find their nearest analogues in the Grebes of the genus *Podiceps*. They were admirably adapted for propulsion in water, but scarcely served for walking on land. Locomotion must have been entirely performed by the posterior limbs—a peculiarity which distinguishes *Hesperornis* from all other birds recent or fossil. The tail appears to have been composed of twelve vertebræ, unique in their peculiar widely extended transverse processes and depressed horizontal ploughshare bone. Broad and flat, somewhat like that of the beaver, it must have been a powerful instrument in steering the bird through the water.

The second part is devoted to a description of the remains which have been found of birds belonging to a second order of Odontornithes, termed *Odontotormæ*. Unlike *Hesperornis*, they seem to have been all of comparatively small size and to have possessed powerful wings, but very small legs and feet. From that contemporaneous form, and from all other known birds recent and fossil,

they are distinguished by certain types of structure which point back to a very lowly ancestry, lower even than the reptile. Their bones, being mostly air-filled, would enable the carcasses to float on water until, by decay or the rapacity of other animals, they were separated and dispersed. Hence skeletons of these flying birds are less entire than those of the massive-boned *Hesperornis*. Nevertheless the remains of no fewer than seventy-seven different individuals have been disinterred. These are included in two well-marked genera, *Ichthyornis* and *Apatornis*, and were all small birds, reminding us by their strong wings and delicate legs and feet of the Terns, like which they were probably also aquatic in habit. Besides the reptilian skull and teeth, the birds of this second order were marked by the character of their vertebræ, which in their biconcave structure recall those of fishes. This is the more remarkable, as in *Hesperornis* the vertebræ are like those of modern birds. Yet these two utterly dissimilar types were contemporaries, and their remains have been preserved in the same strata. Mr. Marsh points out that the transition between the two vertebral types may be traced even in the skeleton of *Ichthyornis* itself, where the third cervical vertebra presents a modification in which the ordinary avian saddle-shaped form appears as it were in the act of development from the biconcave ichthyic form.

In a concluding chapter the author briefly touches upon some of the broader biological questions suggested by the structure of the animals described in the volume. The striking differences between the three orders into which Prof. Marsh divides toothed birds—*Archæopteryx*, *Hesperornis*, and *Ichthyornis*—serve to indicate the high antiquity of the class, and to encourage the search for ornithic remains in the earlier Secondary, if not in the later Palæozoic, rocks. The peculiar character of each of the orders Prof. Marsh believes to have been united in some earlier type, of which no trace has yet been found. This ancestral type may have been almost as much a reptile as a bird. The earliest birds were doubtless closely related to the Dinosaurs and Pterodactyles.

Of the plates, thirty-four in number, which accompany and adorn the monograph it is impossible to speak in terms of too great praise. They are strictly and rigidly scientific diagrams, wherein every bone and part of a bone is made to stand out so clearly that it would not be difficult to mould a good model of the skeleton from the plates alone. And yet with this faithfulness to the chief aim of the illustrations there is combined an artistic finish which has made each plate a kind of finished picture. We heartily congratulate the genial Professor of Palæontology at Yale on the advent of this truly imperial volume. May it be the earnest of many more from the rich store of materials which he has so courageously and enthusiastically gathered among the wilds of the far West!

#### THE THEORY OF DETERMINANTS

*A Treatise on the Theory of Determinants and their Applications in Analysis and Geometry.* By Robert Forsyth Scott, M.A. (Cambridge: At the University Press.)

THE list of English text-books on the subject of Determinants is comparatively meagre, and this notwithstanding the fact that the first separate treatise of all

on the subject was the work of an Englishman, now the distinguished president of the Royal Society. Dr. Spottiswoode's "Elementary Theorems Relating to Determinants" appeared in 1851 (4to, pp. viii. + 63, London, Longmans), and, as a pioneer work, was eminently successful; at the honouring request of the editor of *Crelle* it was republished, with additions, in that well-known journal three or four years later (vol. li. pp. 209-271, 328-381). After considerable intervals came Dodgson's "Elementary Treatise" (London, Macmillan, 1867) and a pamphlet by Wright; and here, until quite recently, the list ended. The chapters on the subject by Todhunter and others belong to a different category, but deserve to be mentioned, as it is doubtless in part owing to their existence that separate treatises have been so rare.

In view of the dearth referred to, he would be a very captious critic indeed who would not gladly welcome the handsome volume whose title is given at the head of this notice. In form and general outward appearance it resembles Part I. of Thomson and Tait's "Elements of Natural Philosophy," and extends to about 250 pages. The matter is arranged under fourteen chapters, the first seven being meant to deal with determinants in themselves, the last seven with the so-called applications; the line of separation, however, is not very well maintained.

In the introductory chapter we have the usual account of permutations, inversions of order, &c., and the usual definition of a determinant; but this is followed by something less familiar, viz., a page or two of exposition regarding Grassmann's "alternate units" or "polar elements," and by the establishment of the theorem that a determinant is expressible as a product of alternate numbers linear in the elements.<sup>1</sup> The constant use afterwards made of this theorem—if theorem we can call that which is but a symbolical expression of the ordinary definition of a determinant—is the distinguishing feature of Mr. Scott's mode of treating the subject. There may be room for doubt whether the study of determinants is thus, as he says, much simplified—the example of § 20, p. 15, is not a happy introductory instance of such simplification—and it may certainly be questioned whether beginners should have the subject at first presented to them in this way; but undeniably a freshness is thereby imparted to the book, which will make it pleasant reading to those who already know something of the matters in hand. Chapters II. to V., on "General Properties of Determinants," "The Minors and the Expansion of a Determinant," "Multiplication of Determinants," and "Determinants of Compound Systems," contain proofs and illustrations of most of the well-known general theorems. One might, however, fairly expect so large a work as the present to be more complete in this respect; the omissions for example, of Sylvester's beautiful theorem expressing the product of two determinants as a sum of like products is not easily excusable. Chapter VI., on "Determinants of Special Forms," is good, and the same may be said of the next, which treats of "Determinants with Multiple Suffixes." Belonging to the first part, although included under "Applications," are Chapters IX. and XII. The

one concerns what are called "Rational Functional Determinants," but which might be more fitly designated as "Alternants"—to use one of Sylvester's happiest coinages; the other concerns "Determinants of Functions of the same Variable," a title again which is anything but sufficiently discriminative. Both chapters are fresh and interesting. To the borderland between the two parts may be assigned Chapter X., on "Jacobians and Hessians;" then there are chapters (VIII., XI., XIII.) dealing with the applications to three departments of Analysis, viz., Theory of Equations, Theory of Quadrics, and Continued Fractions; and, lastly, there is a very readable chapter (XIV.) on "The Applications to Geometry."

No exercises for the student are given under the individual chapters, but a considerable collection is placed towards the end.

Following this is a "List of Memoirs and Works Relating to Determinants," the arrangement being alphabetical according to authors' names. Mr. Scott acknowledges the incompleteness of the list; but, all the same, one cannot help expressing regret that such an excellent opportunity of publishing an exhaustive, or tolerably exhaustive, bibliography of determinants was lost. Had the list been a judicious selection, there would have been less cause for regret, but not rarely the worthless are taken and the good left out. Cauchy, who in a sense laid the foundations of the whole subject, is not once mentioned; Grassmann, who laid the foundation of Mr. Scott's method, is not included; Nägelsbach's name occurs, but his most important paper is omitted; and many more such instances might be cited.

Mr. Scott has given us a very acceptable addition to our mathematical text-books: a little more of the conscientious labour he has shown would have produced a work still more worthy of the press which has issued it.

### LETTERS TO THE EDITOR

[The Editor does not hold himself responsible for opinions expressed by his correspondents. Neither can he undertake to return, or to correspond with the writers of, rejected manuscripts. No notice is taken of anonymous communications.]

[The Editor urgently requests correspondents to keep their letters as short as possible. The pressure on his space is so great that it is impossible otherwise to ensure the appearance even of communications containing interesting and novel facts.]

#### The Stone in the Nest of the Swallow

THE name of swallow's stone was preserved in France even to our days, for Dr. Patrin, a member of the French Institute and of the Academy of Sciences in St. Petersburg, wrote in the "Dictionary of Natural History," Paris, Deterville, 1803 (V° Agate), as follows:—

"On trouve dans les ruisseaux des environs de Sassenage en Dauphiné de très petites Calcedoines ou Agates de forme lenticulaire qu'on a nommées pierres de Chéridoine, parce qu'elles ont quelque ressemblance avec les semences de cette plante, pierres d'hirondelle parcequ'on en a trouvé dans l'estomac de ces oiseaux."

Of course this naturalist did not try to throw light on the legend, or to explain the confusion made by some authors between the respective skill of the eagles in geology, and of the swallows in botany, which Phile, in his "Remedies Against Sortileges," clearly sets out in the following verses:

φορός δὲ τηρεῖ τὰς γοῶν ἀετρίων  
εἰς τὴν καθ' ἑαυτῶν κρήνην λίθον  
ὅς ἢ χελιδὼν τοῦ σελλίου τὴν κόμην  
Ἐξάψασα δὲ τοῦ τραχήλου τὸν λίθον  
κρούσασα γυνὴ κερδαίνει (ὡν τὸ βιβλίον).

"A stone which the eagle conceals in her nest (aery) preserves

<sup>1</sup> 
$$\begin{vmatrix} a & b & c \\ d & e & f \\ g & h & i \end{vmatrix} = (ae_1 + de_2 + ce_3)(de_1 + ee_2 + fe_3)(ge_1 + he_2 + ie_3),$$

where  $e_1, e_2, e_3 = 1$ , and  $e_1, e_2, e_3$  are symbols subject to the laws of ordinary algebra, except that  $e_1 e_2 = -e_2 e_1$ , and therefore  $e_1^2 = 0$ .



her dofs breed from destruction, just as the top of a parsley sprig loos for the swallows. This stone worn by a woman round her neck during pregnancy will procure her a living child."

This use of parsley is mentioned by *Ælianus de Natura Animal.* lib. i. chap. 37, as follows:—

Αἱ σίλφα καὶ τούτων τὰ ἄδ ἀδικούσιν οὐκοῦν αἱ μητέρες σελίνου κέβην προβάλλουσι τῶν βρεφῶν καὶ ἐκείναις τὸ ἐντεῦθεν ἔβατα ἔστιν.

"As the beetles injure their eggs the mothers throw tops of parsley sprigs in front of their young, which become inaccessible to the beetles."

But this parsley must not be confounded with the miraculous herb giving sight to the young swallows. (*Ælianus*, lib. iii. chap. 25).

Βροδείας δὲ ἐκβάλλει καὶ τὰ ταύτης βρέφη ὡς καὶ τὰ τῶν κυνῶν σκυλάκια· πᾶν δὲ κομίζει καὶ προσάγει τὰ δὲ ὑπαναβλέπει εἶτα ἀπρημέσαστα δλιγὸν ἐκπεκῆσιμα ὕδατα πρῆσει· τῆς καλλίας ἐπὶ τὴν νοσήν· ταύτης τῆς πῶας ἀνθρώποι γενέσθαι ἐγκρατεῖς διψῶσι· καὶ οὐδένα ὦν τῆς σπουδῆς κατέτυχον.

"Like whelps, the young swallows are late endowed with sight, but on the application of a certain herb by their mother they begin to see; and after some rest leave the nest to seek their food. Men, though longing for this herb, could never get it."

Dionysius gives in his "Ornithology" some information about this eagle's stone (lib. i. ch. 3).

Ἦν δὲ ἀποτεκεῖν δὴ κομίσαντες τινα λίθον ταῖς κοίλαις ἐντιθέασι καλλιάς ἴνα ἐν καιρῷ τικτωσι, καὶ μὴ τὸ τικτόμενον πρὸ τῆς ὥρας ἀτέλειστον ὕδατο ὑπ' ἰσχύος· οὐ μὴν ἐστὶ τί σαφές περὶ τοῦ λίθου τούτου γινώσκων, ἀλλ' οἱ μὲν αὐτὸν ἀπὸ τῶν Καυκασίων ὄρων οἱ δὲ ἀπὸ τῆς τοῦ ὠκεανοῦ ὄχθης φασι κομίζεσθαι λευκὸν ὑπερφυλὸς ὕδατα καὶ μεστὸν ἠνθοῦν πνεύματος ὡς καὶ ἕχον ἀποτελεῖν εἰ κινῶντο. τικτούσης δ' εἰ τις αὐτὸν γυναικὶ περιάψει, δλιθαίνειν διακωλύσει τὸ βρέφος. κὰν ἐνλέβητι καφλάζοντος ὕδατος ἐπιψάσῃ τὴν τοῦ πυρὸς νικῆσει πάντω ἰσχύν.

"They bring this stone in their nests to avoid a premature and forcible delivery. Nothing positive is known about this stone, which some suppose brought from the Caucasus, and others from the sea-shore. It is exceedingly white, full of air, so as to resound when moved. It prevents miscarriage in those who wear it. And if it does but touch the surface of a caldron of boiling water, it overpowers entirely the might of fire."

The confusion made by some writers between swallows and eagles is evident by the fact of their faulty quotation from Pliny.

For Pliny, chap. iv. lib. x. says—

"Tribus primis et quinto aquilarum generi inædificatur nido lapis ætites quem aliqui dixere gangitem ad multa remedia utilis nihil igne deperdens. Est autem lapis iste prægnans intus, cum quætiat alio velut in utero sonante. Sed vis illa medica non nisi nido direptis."

And in chap. xxxix. vol. 36, he gives further particulars on these very stones, which he divides into males and females, and into four kinds, according to their origin.

Whilst in lib. viii. chap. 41, he says—

"Chelidonium visui saluberrimam hirundines monstravere vexatis pullorum oculis illa medentes," and lib. xxv. ch. 50, "Animalia quoque invenere herbas, in primis que chelidonium. Hac enim hirundines oculis pullorum in nido restitunt visum uti quidam volunt [see Aristotle *de Animal. Gen.* l. iv. ch. 6] etiam eratis oculis"; clearly tracing the distinction followed by Philé between the respective proficiency of eagles in geology and swallows in botany.

Jersey

CHATEL

A Peat Bed in the Drift of Oldham

WE have here lately discovered a bed of peat intercalated with beds of undisturbed "glacial drift." I believe this phenomenon, if not unique, is very rare in England, and may, therefore, be interesting to your readers. In the depth of a section of 14 feet there are two thick beds of drift with washings of fine clay, and, midway in the section, a well defined bed of peat with a maximum thickness of 18 inches. Another bed of peat, somewhat less clearly defined, and not so true as the former, is likewise present, the two beds having beneath them a thin band of exceedingly fine clay of a bluish grey colour, which evidently is the equivalent of the "seatings" or "floor clays," which so invariably accompany our seams of coal. The beds of drift that inclose the peat are alike in some of their main features, but unlike in others. In both boulders are in great abundance.

In the bed beneath the peat there are bands of fine clay, coarse sand, or grit, pebbles, and boulders; the upper, with very little variation, is uniformly made up of arenaceous clay and a great number of boulders. It is almost certain that at the close of the pleistocene period the upper deposit, that is, the one above the peat, could not have had a thickness of less than 75 feet. These deposits are the "upper drift" of the geologist. The beds beneath the peat, judging from their composition—boulders, pebbles, gravel, and fine sand—and the presence in the latter of "current bedding," probably represent the "middle drift." The "lower drift" beds are absent here. May I add that some of the mosses, which seem to make up the bulk of the peat, are in an excellent state of preservation, and are now under examination for identification. A considerable number of fragments of beetles, of undetermined species, are likewise amongst the finds.

JAS. NIELD  
29, Radclyffe Street, Oldham, September 13

On the Asiatic Alliances of the Fauna of the Cœnogenian Deposits of South-Eastern Europe

HERR THEODOR FUCHS of Vienna has pointed out some important mistakes in the abstracts of his memoir in NATURE, vol. xxi. p. 528. In view of remedying these regrettable errors some revised extracts are here given. At p. 528, line 32, the passage should read thus:—"The genus *Neritina* at present shows a predilection for islands. Thus from Tahiti alone Reeve gives 8 species, and 11 from the Sandwich Islands; from the Philippines there are 39, and 45 from New Caledonia alone, according to Gassies. Further, according to Kobelt there are 11 in the Mediterranean; and, according to Reeve, 7 in the West Indies, and 10 in Central America. The great continental area are strangely poor in *Neritina*. In North America the genus seems to be wanting, since the two or three known species are found only in the borderlands to the south. The genus *Melanopsis* has a very peculiar distribution. Twenty species, nearly all strongly ornamented, belong to the Mediterranean. This genus is wanting in Africa, East India, the Malay Islands, Australia, and the whole of America; but it occurs quite locally, with 19 species, in New Caledonia; and 2 species are found in New Zealand."

Again, at line 60, read—"A very peculiar characteristic, hitherto overlooked, in the inland-water faunas of the later tertiary of South Europe, is the absence of the African element (such as the *Achatina*, *Etheria*, *Ampullaria*, *Iridina*, *Galatea* &c.); and this is the more remarkable because the mammalian fauna of the period, on the contrary, has a strongly-pronounced African character. The same may be said of the flora and of the whole tertiary period, since the tertiary flora of Europe had, in succession, an Australian, Indian, Japanese, and Mediterranean character, but never an African character. The tertiary land and freshwater shells of Europe show analogies to New Caledonia, India, China, and Japan, but not to Africa; although the last not only lies so very much nearer to our continent, but in its mammalian fauna, until the Diluvial period, kept so close a connection with Southern Europe."

T. R. J.

Proposistoma punctifrons

MY colleagues, Messrs. Joly and Vayssière, in announcing with justifiable pride (in the *Comptes Rendus* of the French Academy, and elsewhere) the discovery of the perfect insect of *Proposistoma* attribute to me the former possession of an opinion that the insect might be an Ephemerid suited for a continuous aquatic life. I am not sensible of having published such an opinion, nor of having held it. In remarks on *Oniscigaster*, in the *Journal* of the Linnean Society of London, vol. xii. (Zoology) p. 145, foot note (1873), I ask, "Can there be apterous *Ephemerida*?" and "Can the imago of *Proposistoma* be in that condition?" I did not occur to me that these words could be so translated as to bear the interpretation put upon them by Messrs. Joly and Vayssière. In congratulating my colleagues upon their discovery I remark that I make this explanation solely because certain of my correspondents ask where I have published the opinion attributed to me.

R. MCLACHLAN

Lewisham, September 9

Mosquitoes

IN NATURE, vol. xxii. p. 338, an inquiry is made as to the best means of preventing the attacks of mosquitoes. I as

informed that the smell of American pennyroyal (*Hedeoma pulegioides*), when sufficiently strong, drives them away at once. A few drops of the essential oil extracted from this plant added to an ointment and rubbed upon the skin will secure relief from these pests; likewise a sleeping apartment may be freed from them by strewing about a quantity of the leaves of the plant; or by allowing a quantity of the essential oil to evaporate in it. European pennyroyal (*Mentha pulegium*) is said to be very similar, and might possibly have the same effect.

Lyons, New York, August 30

M. A. VEEDER

#### Hardening of Steel

IN NATURE, vol. xxii. p. 220, Mr. H. T. Johnston-Laris supposes the absorption of hydrogen to be necessary for steel to get hard.

The following facts seem to prove that this absorption can be very well dispensed with in hardening:—

1. Small pieces of steel wire can be hardened by moving them swiftly through the air when red hot, or by pressing them against a piece of cold metal.

2. Steel can be hardened very well by cooling in quicksilver.

Both facts seem to state that only rapid cooling is wanted for steel to get hard.

T. W. GILTAY

Dordrecht, September 2

#### THE NEW ZEALAND INSTITUTE

PROBABLY none of our colonies have done so much for the promotion of the higher interests of their people as New Zealand; in this respect, indeed, it will compare favourably with almost any other country in the world. Its university is wonderfully complete and well organised; all the faculties are well represented; science, as well as literature, has its right place in the curriculum; the best men are tempted to go out as professors from the old country; and laboratory research is fairly encouraged. Quite recently a reformed and proposed system of education, which in its completeness and completeness will hold its own with any national system of education in Europe. The New Zealand Institute, again, is probably one of the best organised, and for its purpose, among the most efficient scientific bodies to be found anywhere. It is virtually a Government institution, and was organised by a special Act in 1867. It seems to bear the same relation to its affiliated societies that a university does to its affiliated colleges; it is independent of these societies, which must comply with certain rules imposed upon them by the Institute, and yet without these societies its occupation would seem to be gone. One part of its duty is the publication of summaries of the *Proceedings* of the societies, and of such papers and records in full as the Institute may deem of permanent scientific value. The societies at present incorporated with the Institute are the Wellington Philosophical Society, the Auckland Institute, the Philosophical Institute of Canterbury, the Otago Institute, the Westland Institute, and the Hawke Bay Philosophical Institute. It must be gratifying in the highest degree to those who have the best interests of New Zealand at heart to find a love for culture so widespread as the existence of these societies indicate. And it must be remembered that, as a condition of incorporation with the Institute, each society must come up to a certain standard of membership and contribute a considerable sum yearly to the promotion of science, art, and literature, which is the aim of the Institute.

The genuine good work which the Institute is doing, and its efficiency in promoting not only science, but through that the practical interests of the colony, is evident from the handsome volume of *Transactions* which it publishes yearly, and which are entitled to take their place among the best class of similar publications. Some idea of the work which the Institute is doing, and of the value of its *Transactions*, may be obtained from

the two last volumes, for 1878 and 1879, which we have just received.

Of course the first aim of a society like this, in a fresh country like New Zealand, should be the working out of its natural history (in its widest sense) in a scientific method. This the Institute has done and is doing, and its publications, and the publications of the separate societies, are already a mine of information on all subjects connected with New Zealand. The volumes before us contain a large number of papers on zoology, botany, chemistry, and geology, all of them important contributions to these various departments of science. Prof. Hutton, whose name is well known in this country, contributes a number of valuable papers on the various divisions of the fauna of New Zealand. Prof. von Haast (another name well known to science) has other various contributions of special value, and Mr. T. W. Kirk, of the Colonial Museum, has a long list of papers both on zoology and botany, all of them of novelty and interest, and several of them on such practically important subjects as Grasses and Fodder Plants. Other able workers in these departments are Mr. D. Petrie, Mr. W. Colenso, Mr. Charles Knight, Mr. Buchanan, and Mr. Buller. From Mr. J. C. Craufurd and Mr. W. Collie we have valuable contributions relating to the geology of New Zealand. Several of the papers classed under the head of Miscellaneous are of the greatest importance and interest. Thus we have papers of immense practical value to the colony on the Forest Question in New Zealand, by Mr. A. Lecoy; on the Influence of Forests on Climate and Rainfall, by Mr. F. S. Peppercorne; and on Forest Planting and Conservation, by Mr. G. W. Wilkins. Equally important from a colonial as well as a scientific standpoint is Commander Edwin's paper on the Principle of New Zealand Weather Forecast. We have several excellent papers on the New Zealand natives of much ethnological value: "Notes on Port Nicholson and the Natives in 1839," by Major Heaphy; "On the Ignorance of the Ancient New Zealander of the Use of Projectile Weapons," by Mr. Coleman Phillips; "Contributions towards a Better Knowledge of the Maori Race," by Mr. W. Colenso; "Notes on an Ancient Manufactory of Stone Implements," by Prof. von Haast, F.R.S.; and "Notes on the Colour-Sense of the Maori," by Mr. J. W. Stack. Mr. W. Colenso contributes papers on the Moa, a subject of great scientific interest. Mr. J. H. Pope's "Notes on the Southern Stars and other Celestial Objects" is a valuable contribution to astronomy. Prof. Bickerton has several papers on subjects of wide scientific interest,—on "Partial Impact," the "Genesis of Worlds and Systems," the "Birth of Nebulæ"; while Prof. F. W. Frankland writes interestingly on "The Doctrine of Mind-Stuff." There are several good chemical papers by Mr. W. Skey. In the *Proceedings* of the several societies there are numerous shorter papers of varied interest, as on Moa Feathers, by Dr. Hector; on Musical Tones in the Notes of Australian Birds, by Mr. C. W. Adams; on a new fish, by Prof. Hutton; and many others on subjects of wide and varied interest. We have besides meteorological, earthquake, and other records, and a variety of miscellaneous matter, all of real importance.

An institution capable of producing so much valuable work year after year deserves every encouragement from the government of the country. The New Zealand Government has hitherto granted a subsidy of 500*l.* yearly to the Institute, just sufficient, we believe, to defray the expenses of printing the *Transactions*, which are freely distributed to other societies all over the world. We are therefore astounded to learn that the Government has decided to withdraw this grant, thus suddenly bringing these valuable *Transactions* to a standstill. We can scarcely credit the statement; it is difficult to believe that so enlightened a Government as that of New Zealand

would so seriously cripple one of its most valuable institutions, and so discourage an activity which produces results not only of the greatest value to science, but to the practical interests of the colony. The affiliated societies themselves contribute, we believe, 1,275*l.* annually to support the work of the Institute, the whole of which is spent in keeping up valuable museums and laboratories, and an interest in science in nine centres of population in New Zealand. Without the annual volume, we fear it is impossible to get members to keep up their subscriptions, and thus the organisation of the Institute, which has stood the test of twelve years, given universal satisfaction at home and abroad, and reflected the greatest credit on the colony, is in danger of breaking up and possibly expiring altogether. This would be little less than a calamity to the colony. Not a penny of the 500*l.* is spent in salaries; the editing, drawing of illustrations, and all else is a mere labour of love. The names of von Haast, Hector, Hutton, and others, are known to men of science all over the world. Dr. Hector especially has acquired a high reputation for his activity, zeal, and the results he has obtained. It is greatly owing to him that New Zealand has done for science far more than any colony of its age. The Institute itself is a model of organisation. The grant of the annual 500*l.* was a wise step worthy of general imitation, and its sudden extinction is a cruel blow to science. We can scarcely believe that New Zealand is capable of persisting in carrying out so shabby and short-sighted a policy, a policy of which any country should be ashamed. We trust that later news will show that there has been some misunderstanding, or that the Government has thought better of it, and continued a grant that could not possibly be better spent.

#### ALBERT F. MYER

THE young science of meteorology has sustained another heavy loss in the death of General Myer, of the Signal Service of the United States, at Buffalo, New York, on August 24, in the fifty-second year of his age. In 1854 he entered the United States army as an assistant surgeon, was assigned to special duty in the Signal Service in 1858, and in 1860 was made chief signal officer of the army, a position he held till his death.

The distinguished services rendered by General Myer to meteorology may be considered as having been made chiefly during the last ten years. Americans claim for the late Prof. Henry, of the Smithsonian Institution, the honour of having originated, upwards of thirty years ago, the idea of using the telegraph for conveying information regarding coming changes of weather. But it was reserved to General Myer, as respects the United States, to translate the idea into the action of every-day life, in devising, developing, and extending a system of telegrams and reports for the benefit of commerce and agriculture, which as regards the completeness of its organisation, the thoroughness with which it is worked, and its effective success, stands out as a model system of weather telegraphy. Three large weather maps are prepared and issued daily, along with three daily forecasts of the weather, which the telegraph at once sends through all the towns, villages, and hamlets of the States; and no time is lost, on the expiry of each month, in preparing and widely circulating a Weather Review, accompanied with maps showing the storm-tracks, the geographical distribution of the atmospheric pressure, temperature and rainfall for the month; together with occasional weather-maps of the highest importance in their bearing on the meteorology of America, Europe, and the rest of the northern hemisphere.

The other great service rendered by General Myer to practical science is the system of international meteorology established by him, one of the important outcomes of which is the series of United States weather-maps

now appearing in NATURE, showing the meteorology of the globe for each month. When the scheme was first proposed to the Meteorological Congress at Vienna, in 1873, it was difficult to regard it in any other light than as an impracticable, if not wholly visionary, proposal; but the feeling quickly changed as General Myer unfolded the details of its practical working, and explained that what he required from his brother meteorologists, in addition to their approval of the scheme, was one daily observation at a selected few of their stations, he being authorised by the American Government to say that they would undertake the expense of collecting and discussing the observations.

As our readers are aware, the scheme in General Myer's hands has been a pre-eminent success; and a body of facts is being thereby amassed, destined to furnish the key to the larger problems of meteorology, a science which, from the complex intricacies it presents, requires more than any other science a whole hemisphere at least as its basis of observation. Perhaps the most important of the practical questions which will thus fall to be dealt with are those abnormal distributions of the mass of the earth's atmosphere, short continued or more permanent, from which arise great storms or devastating tornadoes, excessive heat or cold, fine seasons or their opposites, and long-continued rains or droughts, so terrible for the famines which attend them. The explanation of these anomalies will doubtless be the immediate precursor of an intelligent and practically successful forecasting of the character of coming seasons.

This magnificent work General Myer could not have accomplished unless he had been backed by the moral and material assistance so generously and readily accorded him by his Government. With a settled conviction that this national work, if undertaken at all, should be carried out in a spirit and manner worthy of the great Republic, the Government of the United States relegated the work to the Signal Service of the War Department, with an annual vote from the Exchequer, which, while not too large for the work to be done, no Government on this side the Atlantic has yet thought of emulating.

While writing this brief notice of General Myer's work, we have been repeatedly reminded of the name of Leverrier—probably because, though widely different in many ways, both rendered services to meteorology to a great extent identical, both possessed the rare genius of organising and the resolute will that easily sets obstacles aside, both secured the support of their respective Governments, both were animated by large views of the capabilities and requirements of the science, and both were successful in an eminent degree in largely extending the sphere of its operations.

#### PHYSICS WITHOUT APPARATUS<sup>1</sup>

##### V.

THE Science of Electricity may be regarded in several different aspects. Firstly, there is the study of the simple phenomena such as schoolboys delight to see: the attractions and repulsions of rubbed bodies, the sparks, the shocks, the heating of wires, and rotation of diminutive electric engines. Secondly, there is the exact measurement of electrical quantities, and the verifying of the great laws of the science, involving exact manipulation and standard instruments. Thirdly, there is the technical study of the applications of the science, the details of telegraphic apparatus, the necessities of construction and maintenance, the management of electric lights, and other branches of electrical engineering. Lastly, comes the high mathematical theory cultivated only by the few.

Of the practical portions of this vast mine of scientific wealth, the greater part is only to be reached by the aid

<sup>1</sup> Continued from p. 440.

of special instruments of an expensive character. Only the first and simplest of the elementary phenomena of the science can be shown without apparatus. Yet even here the rudest means suffice in the hand of the master to produce the desired ends.

In his lessons on Frictional Electricity, delivered to juvenile audiences at the Royal Institution, Prof. Tyndall has shown in his unrivalled way how with the commonest objects, tumblers, egg-cups, needles, sealing-wax, pewter-pots, eggs, apples, and carrots, may lend themselves to produce the sparks, the shocks, the movements of attraction and repulsion which are more commonly obtained by the use of large and expensive electrical machines. No doubt these lessons—masterly examples of elementary science teaching—are familiar to many of the readers of "Physics without Apparatus." To the science teacher they are an indispensable primer of instructions how to impress common objects into the service of science. The only matter for regret is that they stop so far short of the

obtained from a warm glass tumbler by exciting it with a warm and dry silk handkerchief. And, if both these sources are at hand the further experiment may be made



entire subject, and do not touch the kindred branches of voltaic electricity or magnetism.

The experiments we lay to-day before our readers are mere repetitions of ordinary lecture experiments, but require no apparatus of a technical kind for their performance. To show the attractions and repulsions due to electrification requires only the appliances depicted in Fig. 16. A stick of sealing-wax rubbed briskly through a dry warm piece of cloth or flannel suffices as a source of electricity. A small light ball cut out of pith or cork is attached by a drop of sealing-wax to a silk thread and thus suspended to any suitable support. It is first attracted toward the electrified stick of wax; and then repelled when by contact it has received a portion of the charge. The repulsion is not very easy to show if the ball is not exceedingly light. For this purpose a small feather, or bit of down out of a pillow, answers far better. A support from which to hang it may be improvised out of a penholder and a couple of books. The electricity excited on the wax by friction with a woollen fabric is of the *negative* kind. *Positive* electricity is no less easily

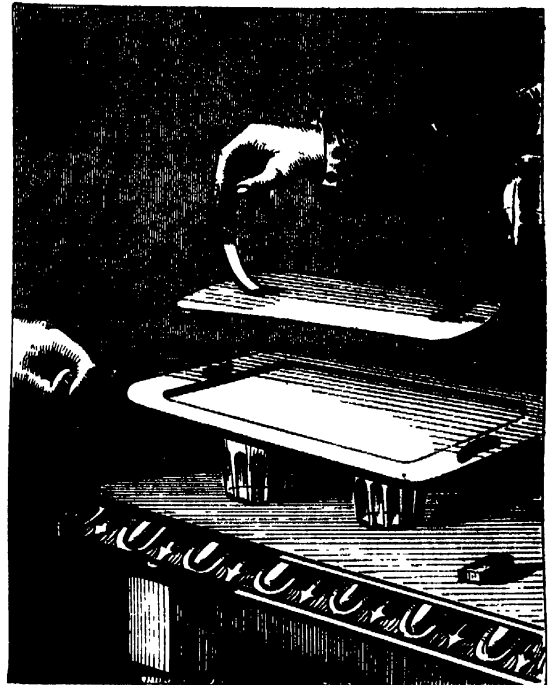

FIG. 17.

of charging the feather with either kind of electricity and then showing that though it is then repelled by electricity



FIG. 18.

of the same kind, the opposite kind of electricity attracts it. The mutual repulsion of two similarly electrified bodies is beautifully shown by means of two silk ribbons,

as follows:—The two ribbons, about a foot long, are both side by side on the table, held at one end between the finger and thumb, and then electrified by drawing along them several times a piece of indiarubber. They are then lifted up from the table, when, if care has been taken that all is warm and dry, they are found no longer to hang straight down side by side, but to stand out and repel each other.

To obtain an electric *spark* requires preparations on a larger scale. M. Tissandier recommends the following method:—A piece of stout drawing-paper (warm and dry, of course) is laid upon a table—or upon a warm dry board. It is then rubbed with the dry hand, or with a silk handkerchief, or with a clothes-brush, or, best of all, with a piece of indiarubber. It will stick slightly to the table in consequence of its electrification. Now throw down on to it a bunch of keys, and grasping two corners lift up the sheet from the table. If at the very moment of lifting any one holds out his knuckle to the keys he will receive a small pale spark perhaps three-quarters of an inch long.

A more certain way we have found with what we may call a *Tea-tray Electrophorus* (Fig. 17). A common tea-tray of metal is supported on two dry glass tumblers. A piece of common brown paper cut so as to be a little smaller than the tray, and with rounded corners, is warmed, laid on the table and rubbed briskly with a piece of indiarubber, or with a clothes-brush. It is then laid down for an instant on the tray and the tray is touched with the hand. The brown paper is then lifted a few inches above the tray. If at this juncture some person

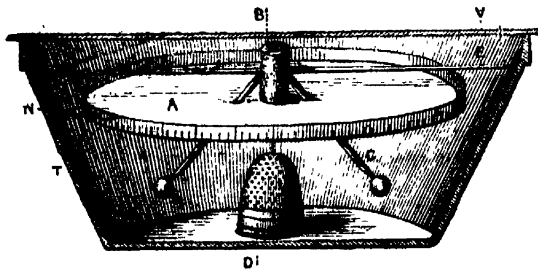

FIG. 19.

presents his knuckle to the tray he will receive a bright spark, which under favourable circumstances may be a couple of inches long. By simply putting the paper down, touching the tray, and again lifting up the paper the tray is again charged: and a large number of sparks may be thus drawn one after the other in rapid succession. The paper may be lifted by the hands, but it will be found better if a couple of ribbons or strips of paper be fixed on with wax to serve as handles, as shown in our figure.

The sparks obtained by the tea-tray electrophorus may produce a slight pricking sensation, but to give a regular electric *shock* will oblige us to store up a charge in a Leyden jar. This important piece of apparatus we have found possible to improvise in the following fashion. A round-bottomed glass tumbler is procured—if of thin glass it is preferable—and is filled to about three-quarters of its height with leaden shot. If shot is not at hand *dry* coal-dust will answer, but not so well, and great care must be taken to wipe clean the upper part of the tumbler. Everything must be warm and scrupulously dry. Into the shot a silver spoon is stuck to serve the place of a rod and knob. This is held as shown in Fig. 18, by grasping it well in the hollow of the hand, so that the hand may cover the whole of the rounded bottom of the glass. Having thus prepared and grasped our Leyden jar we must charge it with sparks from the tea-tray electrophorus. It should be held with the spoon handle near to, but not quite touching the edge of the tea-tray, while

another person performs the operations of lifting the brown paper up and putting it down, then touching the tray, then lifting up again—and so on until a dozen sparks have been sent into the jar. On touching the knob a smart little shock is experienced in the wrists and elbows, and a short bright snapping spark announces the discharge of the jar.

The subject of currents of voltaic electricity is somewhat beyond the province of "Physics without Apparatus," and so is the greater part of the subject of magnetism. We may however conclude this article by presenting our readers with a simple mariners' compass described some time ago in a French magazine (Fig. 19). A short knitting- or darning-needle, E, which has been magnetised by rubbing it on a magnet, is pushed into a small cork, B, and balanced in the following way:—A sewing-needle is fixed, point downwards, in the lower end of the cork, and this is poised on a sewing-thimble. To balance it about the point of the needle a couple of matches pointed at the ends are thrust into the sides of the cork obliquely, and weighted at their lower ends with little balls of sealing-wax. A circle of paper or thin card marked with the "points" of the compass may be attached to the cork; and to prevent draughts of air from blowing the needle round it should be placed in a deep saucer or dish of glass or porcelain.

(To be continued.)

#### NOTES

We are glad to be able to state that Mrs. Clifford is to receive a pension from the Civil List in recognition of the eminent services to mathematics of her husband, the late Prof. W. K. Clifford, F.R.S.

IN the absence of precise information as to the cause of the lamentable explosion at Seaham Colliery, we cannot say anything useful on the occurrence. When such terrible "accidents" occur, Science is invariably asked if she cannot do anything to prevent them, anything to render the miner's occupation less dangerous than it is. Those who ask such questions seem to be ignorant of the fact that, while much remains to be done, science has already done not a little to point out the causes of such explosions and provide the miners with remedies. But it is well known that a large proportion of such explosions are due to the wilful neglect on the part of the miners of the means which science has put into their hands to prevent such calamities. We are in a fair way of finding out the real nature of the connection between meteorological conditions and explosions in mines; it is in this direction that investigations should be carried out with thoroughness and zeal.

THE Sir Josiah Mason's Science College, Birmingham, is to be opened on October 1 next, with an introductory lecture by Prof. Huxley. The classes for students will commence on Tuesday, the 5th. The course of instruction, as at present arranged, includes mathematics, chemistry, physics, and biology. Further details may be learned from our advertising columns.

Two eminent foreign botanists will, the *Gardener's Chronicle* states, shortly visit this country—Dr. Asa Gray and M. Alphonse de Candolle.

We are glad to learn that the Gilchrist Trustees have given two engineering scholarships to University College, London, to be awarded by competition. There is an entrance scholarship (this year two are offered) of the value of 35*l.*, tenable for two years, to be competed for by those who have not previously been students of the College, and who are not more than eighteen years of age. The examination takes place this year on September 28, and candidates must send in their names to the secretary on or before the 23rd. The subjects of the entrance examinations will be as follows:—Mathematics, mechanics,

mechanical drawing, essay on one of three given subjects connected with mechanics or engineering, French or German, the use of tools, either carpenters' tools, or the lathe (wood or metal), or the file. There is also a senior scholarship of the value of 80*l.* to be awarded at the close of each session from 1881-82 inclusive. Candidates for this scholarship must, to the satisfaction of the Faculty of Science, have attended during the whole of the session immediately preceding the award College classes in the following subjects:—Applied mathematics, practical physics, junior engineering, engineering drawing, geology. The scholarship will be awarded on the results of the ordinary class examinations in these subjects.

REFERRING to a short announcement in NATURE, vol. xxi. p. 306, of prizes offered by the Venetian Institute, we have been desired to point out that the limit of time for the first (that relating to the mechanical equivalent of heat) is March 31, 1881 (not 1880). In further explanation we may say that the task proposed is "to discuss minutely the determinations of the equivalent hitherto made, to investigate the causes of the considerable differences that have appeared in the results, to indicate what is the most probable value that may be deduced from these, and to determine the equivalent by new experiments, adopting the method which the competitor shall have proved to be most exact." Many writers of great authority assume 424 or 425 kilogrammetres as the mean value; but Joule's more recent experiments, based on observation of electric phenomena, give 430, and Violle has obtained a value approximating 435. The importance to physical science of a settlement of the question is obvious.

THE Vienna Academy (Section of Mathematics and Natural Science) has proposed as subject for the Baumgärtner prize of 1,000 florins the microscopic investigation of wood of living and fossil plants. By such investigation and the comparison of all known recent and fossil woods, it is desired to ascertain characters whereby it will be possible to determine the genus and species with certainty from microscopic sections. Papers must be sent in before December 31, 1882, and the prize will be awarded at the anniversary meeting in 1883. For further conditions see the *Anzeiger*.

THE *Philadelphia Record* deserves all the credit that has been accorded it for its public-spirited and successful efforts to break up the sale of bogus medical diplomas in that city. These diplomas were chiefly sold abroad, and it is appalling to learn, on the authority of the *Times* correspondent, that 11,000 of them have been issued during the past few years. "It was well known," the correspondent writes, "that Dr. John Buchanan, the Dean of 'The American University of Philadelphia,' and several other similar institutions, was engaged in this traffic; but as they were all properly chartered medical schools, and, though disreputable, existing under the sanction of law, the difficulty was to get evidence of the sale of the diplomas. Diplomatic complaints about the traffic came from various Governments of Europe, and our people began to be restive under the stigma." By the clever tact of the city editor of the *Record*, however, Buchanan has been brought within reach of the law, and the detectives are on his track. He attempted to put them off the scent by getting a man looking like himself to pretend to drown himself; this bogus case of drowning, however, has deceived nobody.

MR. A. L. SILER, the *American Naturalist* informs us, has discovered at Malley's Nipple Ranch, near Pahreah, Kane county, Utah, remains of cliff-structures, which he describes as follows:—The remains seem to have been the foundations of small huts built on ledges of red sandstone under overhanging cliffs. The walls were about six inches thick, made of thin flat sandstone brought up from the valley below, and laid in adobe. The

structures are divided into rooms about four feet square, leaving all the space between the building and the back of the cliff, usually about ten feet, entirely free. Upon digging into one of the rooms, Mr. Siler found parched corn and rope in a good state of preservation.

THE August number of the *American Entomologist* contains an interesting article by the editor (Prof. C. V. Riley) on the effects of *Pyrahrum* (either as powder or fumes) on injurious insects, and the author believes this otherwise harmless substance is destined to entirely supersede the use of Paris green and other arsenical compounds. Experiments were made upon various insects, and on some the effect was remarkably rapid, the powder killing them in a very short time. "Squash bugs" appeared to resist the longest. Amongst other articles and notes is one on a luminous elaterid larva from Maryland, accompanied by figures; and an important one by Prof. W. S. Barnard on the larva of a *Simulium*, which forms black masses on the rocks in rapids near Ithaca, N.Y., the pupa being furnished with external breathing apparatus. This magazine still suffers from the inconvenient absence of any indication of the contents of each number, a want the editors will do well to supply.

THE members of the Geological Society of France arrived at Boulogne on Thursday last. At their reception in the Collège Communal, adjoining the museum, a *vin d'honneur* was offered them by the municipality. Among those present were Professors Prestwich and Seeley. The first meeting took place in the Salle Daunou, at the museum, where an opening address was delivered by M. de Lapparent, president of the Society.

ON August 18 and 24 storms of almost unprecedented violence swept over Kingston, Jamaica, and its neighbourhood. The destruction has been widespread and terrible, reminding one of the dire effects sometimes experienced from storms at Mauritius.

PROF. SILVESTRI, in a recent ascent of Etna, found that, as a result of recent volcanic activity, the summit has been lowered to the extent of 12 metres, so that its present height above sea-level is 3,300 metres, and that the interior edge of the crater, which was formerly 1,500 metres in circumference, is now 1,800. The platform which was formerly seen on the east side, at 60 metres below the edge of the crater, has completely fallen into the heart of the volcano, and the eruptive axis, which before the eruption of 1879 was situated on the west side of the crater, is now right in the centre. Thus the interior walls of the crater of Etna now present the virtually characteristic form of a great funnel.

ON September 5 the adherents of the Positive Philosophy went in procession to the Père Lachaise to the tomb of Auguste Comte, the founder of this system. Their number was about 200. Three speeches were pronounced on the spot, and in the evening a banquet took place in the very rooms that Auguste Comte occupied during his lifetime and which have been preserved in their former state.

TRACES of the last exceptionally cold winter are now visible in Paris, a large number of trees in the squares and streets having lost their foliage at an early period. Many of them are showing leaves belonging to a second formation, and which are probably doomed to a speedy death. We daresay many of our readers will have noticed a similar result in London.

ACCORDING to the *Révue Scientifique* a change has taken place in the Observatory of Algiers, but of a very unusual character. M. Balard, who has been during so many years director of this establishment, has been reduced to the grade of astronomical attaché, and M. Trepied, adjoint member of the Bureau des Longitudes, and one of the staff of the *Révue Scientifique*, has been appointed director.

MONSIGNOR ELIGIO COSI, Bishop in *partibus infidelium* at Chang-Tong in China, is said to have invented a new alphabet, composed of thirty-three letters, with which all sounds of the Chinese tongue can be clearly expressed; until now 30,000 were requisite. The Emperor of Austria, to whom Monsignor Cosi communicated his invention, presented him with a complete typographical apparatus for a printing establishment.

THE boring of the Arlberg Tunnel is in active progress on the Austrian side of the mountain, and ground will shortly be broken on the Swiss side. The St. Gothard line in its entire length is expected to be in running order in April next.

A RATHER smart earthquake shock was felt at Zermatt on the 3rd inst., and other two on Friday last.

ON Wednesday, September 8, lightning fell on the Sorbonne at about half-past two o'clock. A globe of fire was observed by persons present on the spot. Some of them say it was seen coming from the point of the north-western conductor, which was struck, as well as the south-western, with a great noise. The Sorbonne had, until recently, no lightning conductor, and never, as far as is known, has any thunderbolt struck the venerable abode of the French University. But within the last few months six stems have been erected and connected by an iron bar, making a circuit which goes all over the roof of the immense building. Unfortunately the pit where the earth conductor has been placed is situated at a great distance from the main building, in a courtyard adjoining the laboratory of M. Jamin, and the conductor which connects the roof with this is a square iron box of less than 15 mm. on each side, so that there is not sufficient conductivity in it to establish an efficient connection with the earth. This accident proves the sagacity of M. Karsten, the Schleswig-Holstein physicist, who published a table giving a formula for regulating the dimensions of the connecting-rods with their lengths, as is taught by Ohm's laws. It shows also how little the knowledge of lightning-conductors is spread in France, in spite of the several official commissions which have been established by the Government.

DURING the severe thunderstorm which passed over North London on Monday, a peculiar phenomenon was witnessed in the grounds of the Welsh Harp, Hendon, by some gentlemen boating on the lake. A vivid flash of lightning was succeeded by a tremendous peal of thunder, a great ball of fire at the same time descending from the heavens into the water. When the storm had abated over 100 fish of various kinds, including two fine carp, weighing together 23 lb., were found floating dead on the lake.

THE elevation of temperature which has been so remarkable in Paris during the end of August and the beginning of September has been accompanied by the production of a putrid odour spread all over the city, and which has been obnoxious to the public health. A report has just been published by the Prefect of Police, explaining that it must be attributed to the want of water for flushing the sewers, and also to the existence of a number of establishments where sulphate of ammonia is produced, and matters extracted by night-men are dried to be turned into manure. The Prefect of Police says that measures will be taken for producing an enlarged supply of water, and that gradually all the sewage will be conducted to Clichy by the sewers. The completion of this scheme involves the purchase by the city of a large tract of land for utilising these matters, which could not be thrown into the Seine without poisoning the stream.

THE *Daily News* Naples correspondent writes that since the 4th instant Vesuvius has again become more active, and has launched his projectiles in greater number and to a greater height. The seismograph at the observatory is also more animated, and new lava has issued from the side of the cone, flowing, fortunately for the railway, to the north-east.

THE new number of the *Canadian Naturalist* (which, we believe, is kept up with difficulty) contains a paper by Mr. G. M. Dawson on the Distribution of the more Important Trees of British Columbia, which has also been printed separately, and another by Principal Dawson, on the Geological Relations and Fossil Remains of the Silurian Ores of Pictou, Nova Scotia. Mr. G. F. Matthew has a paper on Tidal Erosion in the Bay of Fundy. Are such specimens of etymological jugglery as the Rev. J. Campbell's paper on the "Hittites in America" supposed in Canada to have any connection with science? Unfortunately some of our own scientific societies are guilty of encouraging similar elaborate trifling.

FURTHER excavations, the *Times* Geneva correspondent states, made in the ancient glacier bed near Solothurn have produced some very interesting results, and the spot is being daily visited by geologists and sightseers. The debris removed consisted of 4½ metres of drift mixed up with boulders and crystalline erratic blocks. The rock bared measures 20 metres long by 7 wide. It is highly polished by the action of the ice, and traversed by channels, through which the glacier-water found its way into the so-called "giants' pots," or "kettles." These, so far as has yet been ascertained, are three in number. The largest measures 8 metres from west to east, 3'7 from north to south, and is 3¼ metres deep. The second is 5½ metres across, and still contains the great boulder or mill-stone by which it was hollowed out. The third is smaller and oval-shaped, and there is reason to suppose that, if the excavations were continued, several more would be brought to light. This interesting relic of the great ice-age, or rather of the last glacial epoch, is at present private property, but a project is on foot for its acquisition by the canton, and preservation as a glacier garden in the manner of that of Lucerne.

WE have on our table the following publications:—"Familiar Wild Flowers," by F. E. Hulme (Cassell); "On the Educational Treatment of Incurably Deaf Children," by W. B. Dalby (Churchill); "Brain and Nerve Exhaustion," by Mr. Stretch Dowse (Baillière); "Lectures on the Science and Art of Education," by Joseph Payne (Longmans); "The Morals of Evolution," by M. J. Savage (Triebner); "Animal Magnetism," by R. Heidenhain (Kegan Paul); "Stonehenge Plans, Descriptions, and Theories," by W. M. F. Petrie (E. Stanford); "Ambulance Lectures," by Lionel A. Weatherly, M.P. (Griffith and Farran); "Astronomy, Text-Books of Science," by R. S. Ball (Longmans); "The Land and Freshwater Shells of the British Isles," by R. Rimmer (Bogue); "British Wild Flowers by Natural Analysis," by J. Messer (Bogue); "Glimpses of England," by J. R. Blakiston (Griffith and Farran); "Radical Mechanics of Animal Locomotion," by Mr. Wainwright (Van Nostrand).

THE additions to the Zoological Society's Gardens during the past week include a Common Cuckoo (*Cuculus canorus*), European, presented by Mr. G. Chandle; a Stock Dove (*Columba oenas*), European, presented by Mr. A. Basil Brooke; a Common Raven (*Corvus corax*), European, presented by Mr. W. A. Mitchison; a Rufescent Snake (*Leptodira rufescens*) from South Africa, presented by the Rev. G. H. R. Fiske, C.M.Z.S.; a Horned Lizard (*Phrynosoma cornutum*) from Texas, presented by Mrs. Budgett; a Vervet Monkey (*Cercopithecus lalandii*) from South Africa, two Bull Frogs (*Rana mugiensis*) from Nova Scotia, deposited.

#### OUR ASTRONOMICAL COLUMN

FAYE'S COMET.—The following places of this comet are adapted, like those previously given in this column, to Berlin midnight or to about 11h. Greenwich time:—

	h.	R.A.		N.P.D.	Log. distance	
		m.	s.		Earth.	Sun.
Sept. 23	23	53	48	83 24'3	0'0422	0'3174
25	—	52	45	83 46'9	0'0406	—
27	—	51	46	84 10'0	0'0393	0'3134
29	—	50	51	84 33'3	0'0384	—
Oct. 1	—	50	2	84 56'8	0'0379	—
3	—	49	18	85 20'5	0'0377	—
5	—	48	40	85 44'1	0'0378	0'3054
7	—	48	9	86 7'7	0'0383	—
9	23	47	46	86 31'0	0'0390	0'3015

It will be seen that the nearest approach of the comet to the earth (1'09) occurs within this period, and the circumstances are as favourable for observation as they can be at this appearance. An observation by M. Pechüle at Copenhagen on September 1 shows that the ephemeris of Prof. Axel-Möller requires only the small correction of -1'6s. in R.A., and +15" in N.P.D. In no case has the motion of a comet of short period been followed with more striking success than that of Faye's comet has been during the thirty-seven years which have elapsed since its discovery, through the masterly investigations of the Swedish astronomer. Nor has he confined himself to following the comet during this interval: he has confirmed in a great degree the inferences drawn by Leverrier with respect to the conditions attending the near approach of the comet to Jupiter, about the time of nodal passage in the year 1816, having previously calculated with precision the effect of an approximation of the two bodies within 0'64 in March, 1841, and assigned accurate elements for December 25, 1838. (See the *Proceedings* of the Academy of Sciences at Stockholm, January, 1873.)

SCHABERLE'S COMET (1880, APRIL 6).—The theoretical brightness of this comet, discovered seven months since, is on the increase, and we subjoin an extract from the ephemeris calculated by M. Bigourdan, from elements founded upon normal places for April 10, 28, and May 16. It is for Paris midnight, and the intensity of light at discovery is taken = 1.

	h.	R.A.		N.P.D.	Log. distance from Earth.	Intensity of light.
		m.	s.			
Sept. 28	6	39	45	76 35'5	0'2882	1'03
30	6	37	16	77 32'0	0'2817	—
Oct. 2	6	34	35	78 30'3	0'2751	1'06
	6	31	42	79 30'4	0'2685	—
	6	28	38	80 32'3	0'2620	1'10
	6	25	20	81 35'9	0'2556	—
10	6	21	50	82 41'4	0'2494	1'14
12	6	18	6	83 48'6	0'2434	—
	6	14	9	84 57'6	0'2376	1'17

The maximum brightness is attained about November 4, near which date the following are the comet's approximate positions:—

G.M.T.	h.	R.A.		N.P.D.	Log. distance from Earth.	
		m.	s.		Sun.	Sun.
Nov. 2	5	25	23	96 51	0'2029	0'3762
6	5	12	52	99 21	0'2024	0'3819
10	4	59	53	101 46	0'2047	0'3875
14	4	46	35	104 1	0'2108	0'3931

SWIFT'S NEW COMET.—Mr. Lewis Swift, writing from Rochester, New York, on August 18, gives some particulars of his observation of a cometary object on August 11, and explains the cause of his delay of a week in notifying his discovery. On the 11th he observed a nebulous object elongated in the direction of the sun in the field with and about 1° distant from the small bright nebula H. I. 262, the position of which for 1880 is in R.A. 11h. 20m. 32s., N.P.D. 22° 45'2, and having been familiar with the neighbourhood for many years, he supposed it to be a comet, but could detect no motion before the sky clouded. On the morning of the 17th, the sky being clear after the moon had set, he examined the spot, but the nebulous object was missing, and a search until daylight failed to recover it. He then cabled his discovery and made it known to astronomers in the United States. The position, he says, would not differ much from R.A. 11h. 28m., N.P.D. 22°. The comet was first detected with his comet eyepiece, power 25, and examined with powers 36 and 72; it was faint, but not very faint. We have not heard that it has yet been seen elsewhere. The place given is not upon the track of Pons' comet of 1812, the return of which is shortly expected, and for which it is much to be desired that a strict search should be maintained. Sweeping-ephemerides prepared under Prof.

Winnecke's direction will be found in the *Vierteljahrsschrift der Astronomischen Gesellschaft*, 12. Jahrgang, 2. Heft.

THE BINARY STAR 85 PEGASI.—By five nights' recent measures of the close stars in this system, Mr. Burnham has satisfactorily established their binary character, which had been rendered probable by his earlier measures; the mean result is—

1880'59 ... Position, 298°3 ... Distance, 0'65.

For the distant companion Mr. Burnham finds from six nights' observations—

1880'57 ... Position, 25°0 ... Distance, 15"41.

GEOGRAPHICAL NOTES

THE sixth issue of Behm and Wagner's "Population of the Earth" has just been issued. Since the last issue several censuses have been taken, and the results of these, combined with the natural increase of the population, have added something like seventeen millions to the inhabitants of the globe. The population of the earth is now stated to be 1,455,923,550, as compared with 1439 millions two years ago. Europe has 315,929,000 inhabitants, or 32'5 per square kilometre; Asia, 834,707,000, or 18'7 per sq. kil.; Africa, 205,679,000, or 6'9 per sq. kil.; Australia and Polynesia, 4,031,300, or 0'4 per sq. kil.; and the Polar Regions 82,000, mostly divided between Iceland and Greenland. The *Bevölkerung* is just too soon to be able to utilise the results of the censuses of the United States and of Austria, which are taken this year, and that of our own country will not of course be available for at least two years. The editors have, however, made a very careful calculation of the present population of the States, on the basis of registration and emigration statistics, and find the probable population of the present year to be 48,000,000. The section of the work relating to Roumania and the Balkan Peninsula is specially valuable, and must have cost the editors a vast amount of trouble, considering the untrustworthy and imperfect nature of the data at their command. The areas of these countries, as well as of several other regions on the globe, including Africa, are mainly given from careful planimetric measurements made under the direction of the editors. The area of Roumania is given as 129,947 square kilometres, and the population as 5,376,000; Servia, 48,657 sq. kil., 1,589,650 population; Montenegro (after the Berlin Treaty), 9,475 sq. kil., population 286,000; European Turkey, including the dependencies of East Rumelia, Bulgaria, Bosnia, and Herzegovina, 339,211 sq. kil., population 8,866,500; of Asiatic Turkey the area is given as 1,899,206, and the population 16,320,000. For Afghanistan, the *Bevölkerung* gives the details of the various tribes and populations contributed to NATURE by Mr. Keane in January last. It also gives Mr. Keane's table of the Turkoman tribes (NATURE, vol. xxi. p. 111), which is wrongly attributed to Prof. Vámbéry. The statistics of the Indian Archipelago have cost the editors great trouble, mainly owing to the confused and unsystematic way in which the Batavian Government compile their statistics. There is a very detailed and careful *résumé* of the areas and populations of the various Polynesian island groups. The result reached by the new estimation of the area of Africa in the *Bevölkerung* is 29,283,390 square kilometres, of which about 6½ millions are forest and cultivable land, the same are in prairies and light woods, 1¼ million bush, 4¼ millions steppe, 10½ millions desert, and 170,000 lakes. A new planimetric measurement of South America made by Dr. Wisotzki gives the area as 17,732,128 square kilometres. The total area of the North Polar lands is given as 1,301,100 square kilometres, and of the South as 666,000.

THE French scientific expedition headed by Prof. d'Ujfalvy, the celebrated French explorer of Central Asia, has arrived at Nijni Novgorod, on its way to Turkestan, to explore Bokhara and the whole of Afghanistan north of the Hindoo Koosh. The expedition will proceed to Tashkend, where it will pass the winter, via Siberia, taking the steamer from Nijni Novgorod to Perm, the train thence to Ekaterinburg, the post-road to Turan, the steamer again to Semipalatensk, and completing the distance to Tashkend by post-road. As soon as possible in the spring the expedition will set out for Samarcand, and, after exploring the antiquities in the Zerafshan district, will cross the border into Bokhara, proceeding thence, at the completion of the exploration of the Khanate, to the Pamir Wakh, Badakshan, and other little known Afghan possessions in the Hindoo Koosh.



It will depend on the state of affairs in that region whether the expedition afterwards crosses the Hindoo Koosh to Cabul and Candahar, and proceeds to India and China, or whether it takes the road to Peking through Kashgaria and Tibet. Persia and Asia Minor will be touched on the way home, and Prof. d'Ujfalvy hopes to reach Paris by the beginning of 1882. D'Ujfalvy has received a subsidy of 80,000 francs from the French Government, and is accompanied by two salaried officials connected with the Ministry of Public Instruction, Gabriel Bonvallo, a naturalist, and Guillaume Kapius, a doctor of natural science.

The current number of the Geographical Society's *Proceedings* opens with Sir R. Temple's lecture on the highway from the Indus to Candahar (illustrated by woodcuts from his own sketches), which is most appropriately followed by Capt. Beavan's "Notes on the Country between Candahar and Girishk." The map, which will embody new material, is promised with next number. The other paper is an account by Mr. Coppinger, R.N., of a visit to Skyring Water, Straits of Magellan. In the geographical notes much prominence is naturally given to Mr. Thomson's letters describing the concluding part of his very successful journey in East Africa, the only disaster of which has been the sad death of Mr. Keith Johnston at the very outset. In the letters now before us Mr. Thomson tells us how he vainly—owing to the opposition of his own men—endeavoured to trace the course of the Lukuga Creek from Lake Tanganyika to the Congo, failing in which he returned to his camp at the south of the lake, and then, having examined the previously unseen Lake Hikwa (or Likwa), made the best of his way back to Zanzibar through Unyanembe. Among the other notes we find one on the French expedition from the Senegal to the Niger, under Capt. Galliéni, followed by others on routes between Kurram and Ghazni, Russian Manchuria, Saghalin I-land, the Indo-Chinese peninsula, and the affluents of the Rio Purús. Sir J. H. Lefroy's address to the Geographical Section of the British Association is also given, together with a few notes on new books and maps, the whole forming an exceedingly good number for the time of the year.

AFTER spending two years in South Africa, Lieut. Een, a Swedish traveller, has lately returned to Europe, bringing with him valuable collections which he has formed in Damara-land, in the departments of natural history and ethnography.

CAPT. CASATI, an Italian traveller, is going to the Bahr-el-Ghazal, whence he will endeavour to reach Lake Chad through the Niam-Niam country, with the view of thoroughly investigating the interesting problem of the relations between the Rivers Welle and Shari.

M. LOMBARDO has gone to Abyssinia on a mission from the French Government, to study the topography of the country, as well as its civil and military organisation.

THE last issue of *Le Globe* contains a paper on "La Topographie comme Base de l'Enseignement géographique," and another by M. Th. Vernet, on South Africa.

THE current number of *Les Missions Catholiques* contains three papers of interest, viz., the conclusion of the narrative of a journey in West Africa, part of the particulars respecting the march of the Algerian Missionary Society's last expeditions to Lake Tanganyika and the Victoria Nyanza, and the first instalment of a paper communicated by the Very Rev. Father Dominique of Aden, on Somali-land, a region which is gradually attracting a good deal of attention at the hands of travellers as well as of missionaries.

THE most noteworthy contributions to the new number of *Les Annales de l'Extrême Orient* are a notice of M. Aymonnier's Khmer-French Dictionary, and a vocabulary collected by the well-known Thibetan traveller, Abbé De-godins, of words in use among several tribes on the Lan-tsang-kiang, or Upper Me-kong, the Lou-té-kiang, or Upper Salween, and the Upper Irrawaddy.

A TELEGRAM from San Francisco, dated the 1st inst., states that a despatch has been received at that port from Victoria, a district at the northern extremity of America, to the effect that the barque *Malay* has arrived there from Onnalaska, bringing no tidings of the *Jeanette*, the vessel despatched some months ago by the United States Government upon a voyage of Polar discovery. The *Malay* reported that at Onnalaska the *Jeanette* was given up for lost, on account of the severity of last winter. A despatch from Washington, in reference to the above rumour, ridicules the idea that the *Jeanette* has met with a mishap,

inasmuch as she was made as strong as human ingenuity could contrive, and specially equipped and provided for the service on which she was sent. Officers, says the *Herald*, who have had experience of the Arctic seas, say they know of no reason why Lieut. De Long should not be as successful as Nordenkjöld was in his Northern voyage.

THE series of letters from the enterprising correspondent of the *Daily News* in Central Asia are well worthy of attention; they contain many valuable observations both on the country and the people. The Burmese correspondent of the same paper, in a long letter in last Friday's issue, describes a journey into the interior, giving much fresh information on a little known region.

### THE FRENCH DEEP-SEA EXPLORATION IN THE BAY OF BISCAY<sup>1</sup>

I FEEL that I am indebted for the opportunity of giving an account of the French Expedition which forms the subject of this paper to my esteemed friend and colleague the Marquis de Folin of Bayonne. He was until lately the Commandant of that port, and is a most zealous and excellent naturalist. I may indeed say that the Expedition originated with him. For more than ten years he had at his own expense assiduously and carefully explored the sea-bed lying off Cap Breton, in the Department of the Landes, as well as could be done in a fishing-boat; and the result of his researches among the marine Invertebrata has been described, with illustrations by his pencil, in a useful work called "Les Fonds de la Mer," published at Bayonne under his direction. M. de Folin has from time to time sent me the mollusca procured in his dredgings for my opinion; and our correspondence, with a visit which I paid him in December, 1878, led to his making an application to the French Government for the grant of a vessel to explore the depths which were known to exist at a comparatively short distance from the northern coasts of Spain in the Bay of Biscay. This evidently could not be done in a fishing-boat; and naturalists have much less money than science. It was in fact a project for a nation, and not for an individual. The application was, I believe, referred to the Dean of the Academy of Sciences, M. Milne-Edwards, whose reputation as an eminent zoologist has been universally recognised for more than half a century. His report was favourable; and a Government vessel was ordered to be placed at the disposal of a Commission, of which M. Milne-Edwards was appointed president. The other members of the Commission were the Marquis de Folin, Prof. Alphonse Milne-Edwards, Prof. Vaillant, Prof. Marion of Marseilles, Dr. Paul Fischer, and M. Perier of Bordeaux. The selection of these savants augured well for the success of the Expedition, and it has been fully justified. At the suggestion of M. de Folin, the Minister of Public Instruction graciously invited me and the Rev. A. M. Norman (a well-known zoologist) to take part in the expedition. Mr. Norman had been my valued companion for many years past in similar but less important excursions to Shetland and Norway. It was to me a great pleasure to be again associated with him. I regarded the invitation as far more than a compliment: it was a great honour.

I may here mention that immediately before the commencement of the Expedition M. de Folin, Mr. Norman, and I had some preparatory boat-dredging in the Fosse de Cap Breton. This was done at the expense of the French Government. When has our own Government shown such generosity in the cause of science to French naturalists?

The vessel assigned for the purposes of the Expedition was the *Travailleur*, a paddle-wheel steamer of over 900 tons, of 150 horse-power, and carrying four guns. She is an "aviso," or despatch-boat, and is stationed at Rochefort for occasional service. She was supplied with a capital donkey-engine and immense stores of cordage, sounding-wire, and other apparatus. She had a very happy name, being an indefatigable worker. Capt. E. M. F. Richard was the commander, or "Lieutenant de Vaisseau;" and the other officers were Lieutenants Mahieux, Jecquet, Villegente, and Bourget, Aide-Commissaire Gousselin, and Doctor Duploux. Let me now express my sincere thanks to the officers for their great kindness and urbanity. They took a great interest in the work, and materially promoted the welfare of the Expedition. The crew consisted of 128 men; the usual number was between eighty and ninety, but

<sup>1</sup> Paper read at the British Association by J. Gwyn Jeffreys, LL.D., F.R.S.

extra hands were taken in consequence of the heavy work entailed by sounding during the night. All these men seemed to be well conducted, as well as good sailors; and although they had only two meals a day, their physique was quite equal to that of our best British seamen. Mr. Norman and I took with us as dredger a steady and intelligent man, John Wilson; and Prof. Marion had his dredger, named Armand. These men were of great use in sifting the material brought up by the dredges. For the Captain, I can only echo the opinion expressed by Prof. A. Milne-Edwards in his Preliminary Report, that his arrangements were first rate, and his skill admirable, especially considering that the kind of work was new to him, and that he had not previously made or even seen any deep-sea dredging.

The members of the Commission assembled at Bayonne, and the *Travailleur* arrived there on July 16th. The next morning she went to sea, with all the party on board except the President, who was obliged to return to Paris, and might also have justly claimed exemption from active service, being in his eightieth year. Until August 1st (with the exception of Sundays, the 18th and 25th, which we spent at San Sebastian and Santander) we were hard at work sounding, dredging, and trawling. The weather was very fine; and the dreaded Bay of Biscay lost its stormy character on this occasion.

The principal object of the Expedition was to ascertain the nature of the fauna which inhabits at considerable depths this part of the Bay of Biscay; and this object was thoroughly and successfully accomplished. Twenty-three dredgings were made for that purpose at depths ranging from 337 to 2600 metres, each metre being about thirty-nine inches, or rather more than half a fathom. The dredgings between 600 and 1,000 fathoms were the most important. Every department of the Invertebrata was well represented; and novelties were discovered in Mollusca, Crustacea, Echinoderms, Annelids, Actinozoa, and Sponges.

As regards myself, this Expedition had a peculiar charm. Having had the scientific charge of similar expeditions for the Royal Society in H.M.S. *Porcupine* in 1869 and 1870, and in H.M.S. *Valorous* in 1875, and having examined the collections made during the voyages in H.M.S.S. *Shearwater* and *Challenger*, as well as those made in nearly all the Swedish, Norwegian, Dutch, and American deep-sea and exploring expeditions in the North Atlantic, I was naturally glad to participate in the French Expedition, and particularly as it embraced that part of the sea which was at no great distance from the scene of my former labours in the cruise of the *Porcupine* along the western coasts of Spain and Portugal, and which cruise was so unusually productive. Impelled by this recollection, I made last year a verbal and informal application to the late First Lord of our Admiralty for the use of one of Her Majesty's ships to explore the Bay of Biscay this summer. The answer I received was very favourable; but the pecuniary resources of our Government were then at a very low ebb, and I was encouraged to renew the application when commerce revived and times became more prosperous. I hope our new Government will avail itself of the now improved finances, and not neglect this genuine and beneficial method of instructing the nation and maintaining its credit for maritime discovery.

The fauna observed during the *Travailleur's* cruise closely resembled that which I ascertained during the *Porcupine* cruise in 1870 to exist at corresponding depths. This will be shown, so far as the Mollusca are concerned, in the list of species appended to the present paper; and I have no doubt that the other branches, when they have been worked out by the experienced naturalists to whom they have been assigned, will confirm my opinion.

In a physical and geological point of view this French Expedition has borne good fruit. No less than 103 soundings were made. They have proved the existence, within a few miles of the coast, of a submarine valley opening from the Fosse de Cap Breton and extending to a point opposite Cap Pénas. The large diagram and chart which I now exhibit will give a better explanation than I can do by any words. The diagram was prepared for me when I presented to the Royal Society my Reports of the *Porcupine* Expeditions of 1869 and 1870; and the chart has been filled up and given to me by my kind friend the Hydrographer.

The striking inequalities of depth within a narrow area which thus appear were noticed in a Bayonne newspaper of August 4th, as "des grands fonds sous-marins, qui continuent sous les eaux de l'Atlantique les vallées pyrénéennes." As a general rule, it may be said that where mountains or high land approach

the sea the depth of water is greater off that coast than where the land lies low. But this must depend in a great measure on the geological nature of the land adjacent to the sea. If the formation be granitic or gneissic, the wear and tear or denudation must be slower than if the formation be sandstone, Cretaceous, or Tertiary; and the action of rivers and streams on the surface of the land must be proportionally increased or decreased, and must cause the sea-bed to be more or less filled up in the course of time. Everywhere during the dredgings of the *Travailleur* in deep water the sea-bed was found to be covered by a thick layer of mud, of a different colour from that of the Atlantic ooze; and this mud has probably accumulated from untold ages by the incessant efflux of the Gironde, the Adour, and numerous other rivers and streams into the Bay of Biscay. As may be supposed, the fauna which inhabits such mud is very scanty; and it required a considerable amount of patience and perseverance to extract a few organisms from the unpromising material. No wonder that Dr. Carpenter was discouraged, as a zoologist, by what he termed "the singular barrenness of this deposit in regard to animal life," when he described the Mediterranean cruise of the *Porcupine* in 1870.

Within a few days after the return of the Expedition Prof. A. Milne-Edwards presented to the Academy of Sciences at Paris a Preliminary Report of the zoological results of the Expedition, which was published in the *Journal Officiel de la République Française*. As most of the departments of the marine Invertebrata have been so fully and carefully treated by him in this Report, I will content myself with a few supplementary remarks as to the Mollusca, which especially engaged my attention during the cruise. At the request of Dr. Fischer, who will undertake this department, and with the sanction of the President, I was entrusted with all the more critical specimens of Mollusca; and these specimens I have now cleaned, assorted, and compared with my own collection from the *Porcupine* Expedition of 1870, on the western coasts of Spain and Portugal. I subjoin a complete list of the *Travailleur* Mollusca, distinguishing in separate columns those species which are *Porcupine*, those which were previously known to me from Norway or the Mediterranean only, and those which I consider new to science. The total number of the species in this list is 152, out of which 138 are *Porcupine*, three only appear to be peculiarly northern, one peculiarly southern or Mediterranean, and eleven new to science.

The results, especially in the last-mentioned category, are most noteworthy. They serve to show how little we know of the deep-water Mollusca, when we reflect that the area of the sea-bed lately explored in a short period of time, and in a necessarily cursory manner, is but a very small corner of the Atlantic, and that it would take many years to complete the exploration so auspiciously commenced. The area traversed by the dredge during this cruise represents probably much less than a ten-thousandth part of the sea-bed lying between Cape Breton and Cape Pénas; and our means of exploration by the dredge are by no means satisfactory, particularly on muddy ground, of which the deep-water zone is mainly composed. Instead of our being able to scrape a few inches of the surface of the sea-bed at considerable depths, so as to collect in the dredge all the animals which inhabit the superficial layer, we find too often, to our disappointment, that the dredge, when it reaches the bottom, sinks into the mud from its own weight and from the momentum given to it by the motion of the ship, and that it then acts as a subsoil plough, and not as a scraper. I must ask one of my engineering friends to devise some instrument more efficient than the modern dredge.

Although it cannot be positively stated that the abyssal zone, or even the benthic zone, is inhabited only by certain species of Mollusca, some species observed by me during the preparatory excursion to Cap Breton and the *Travailleur* cruise bear out the statement to some extent. For instance, *Nucula nitida*, *Dischides bifissus*, *Rissoa abyssicola* (a now inappropriate specific name), and *Defrancia decussata* occurred only in the shallow water excursion; while *Nucula corbuloides*, *Siphodontulum obtus*, *Rissoa deliciosa*, and *Defrancia hispidula*, occurred only in the deep-water cruise.

Several deep-water species of Mollusca occurred in this Expedition, which had been until lately supposed to be extinct; they are fossils of the Upper Tertiaries of Europe. For the Geological definition of this term see "British Conchology," vol. i. pp. 315, 316.

A curious provision of nature—if we may in these philosophical days use such a phrase—was observable in the

a deep-water mussel of considerable size, which I propose to name *Mytilus luteus*. It inhabits the layer of mud which I have above described, and moors or fixes itself by means of a large and densely-matted byssus which is spun by the foot. This byssus is capable of being spread over a considerable extent of surface; and it not only prevents the mollusk sinking into the soft mud and being smothered or buried alive, but enables it to feed comfortably on the innumerable animalcula which swarm on the surface of the sea-bed. It is of the same use to the mollusk as the snow-shoe is to the Arctic traveller. This species of *Mytilus* I at first took to be the *Modiola incurvata* of Philippi—*M. martorelli* of Hidalgo, which lives on the south coast of Spain in rather shallow water; but on comparison I am satisfied that they differ essentially in shape, sculpture, colour, and epidermis.

I cannot conclude this account without acknowledging my most grateful thanks to the French Government for their extremely generous conduct in my case and for the excellent hospitality which I enjoyed on board the *Travailleur*, as well as to the President and Members of the Scientific Commission for their obliging and friendly companionship.

The zoological results of this French Expedition are fully equal to those made by Capt. Baudon in 1801, M. d'Urville in 1829, the *Recherche* in 1835, the *Astrolabe* in 1841, and other French expeditions; and I sincerely hope that a further expedition of the present kind may take place next year in the Mediterranean, where our good and gallant neighbours have such an important stake.

The list of Mollusca referred to in this paper includes the following new species named or recognised by the author:—*Pecten obliquatus*, *Lima Jeffreyi* (Fischer), *Mytilus luteus*, *Modiolaria cuneata*, *Axinus tortuosus*, *Mytilimeria* (?) Fischer, *Thracia tenera*, *Cadulus semistriatus*, *Rimula asturiana*, *Odotostoma lineata*, and *Bullina elongata*. The species which he considers peculiarly northern are *Chiton alveolus*, G. O. Sars, *Fusus turgidulus*, Jeffreys, and *Pleurotoma nivalis*, Lovén; and the species which he considers peculiarly southern or Mediterranean is *Odotostoma fasciatus*, Forbes.

**THE SHOWER OF AUGUST PERSEIDS, 1880**

THE August meteors were observed under peculiarly favourable circumstances this year. Not only was the moon entirely absent during the display, but the weather, which so frequently interrupts such observations, remained fine night after night, thus allowing an unbroken series of watches to be maintained from the 6th to the 13th, and enabling the rise and fall of the display to be distinctly traced from a comparison of the results obtained each night. On the 10th, however, when the maximum was expected, the state of the sky scarcely admitted of successful observation, and the number of shooting-stars recorded that night was below the experiences of past years, but it must be remembered that, this being leap year, the chief intensity of the shower was due earlier than usual, so that it may have occurred before the evening of the 10th, when observers generally were watching for its reappearance.

At Bristol the following summary was derived from observations by the writer:—

Date, 1880.	Length of watch.	Time of watch.	No. of meteors seen.	No. of Perseids.	Hourly Nos. for one observer.		Chief radiant point.
					All meteors.	Perseids.	
August 6	1 1/2	10-11 1/2	10	5	13	3	38 + 56
7-8	4 1/2	11-14	112	54	25	12	41 + 55
9	2 1/2	10-13 1/2	111	71	44	28	44 + 55
10	1 1/2	10-11 1/2	64	41	34	28	43 + 57
11	2 1/2	10-13	50	19	26	17	48 + 57
12	2 1/2	10-13	45	43	18	8	49 1/2 + 57 1/2
13	1 1/2	10-12	18	7	12	5	
Aug. 6-13	16 1/2	10-14	419	240	246	144	44 + 56

The observed maximum occurred on the 9th, when, during a watch of 2 1/2 hours, meteors were falling at the rate of 44 per hour (for one observer), and the proportion of Perseids was nearly two-thirds of the aggregate number visible. On the 10th the hourly number of 34 was determined under less favourable conditions. A fog partially overspread the sky, rendering the

stars dim, so that many small meteors passed unrecorded, and at 11 1/2 h. it was found impracticable to continue observations. The hourly number of Perseids found on the 10th coincides with that of the preceding night, and it is obvious that, allowing for the clearer atmosphere of the 9th, the maximum of the display really occurred as usual on the 10th. It is fair to assume from the numbers actually counted in the fog-shrouded sky of the 10th that later in the night, as the radiant attained greater elevation, the meteors from Perseus were as numerous as during the few preceding apparitions of the shower. The brightest meteor observed at Bristol appeared at 13h. 37m., on August 8. The sky had become overcast except near the western horizon, where a few stars could still be distinguished. A vivid flash startled the observer, who, on looking towards the direction indicated, at once saw a brilliant meteor streak attached to the star  $\gamma$  Ophiuchi, and its position was such as to leave no doubt that it had been left by a magnificent Perseid. Other large meteors were registered as follows:—

	Time.	Mag.	Path		Length.
			From	To	
August 6	h. m				
7	10 52 1/2		51 + 66	60 + 70	6
7	10 49		265 - 10	261 1/2 - 19	10
7	12 0		329 + 10	322 1/2 0	12
7	12 25		55 + 53	64 + 50	6
7	12 34		58 + 58 1/2	55 + 45	4
8	10 5		61 + 72	109 + 76	13
8	11 14		314 1/2 - 2	306 - 18	17
8	11 32		16 + 46	2 + 36 1/2	14
8	12 8		324 + 43	310 + 30	17
8	12 49		28 + 44	24 + 39 1/2	5
8	13 35		36 + 33	35 + 27	6
9	12 5		36 + 34	33 1/2 + 28	7
9	12 23		332 + 7	320 - 10	20
9	12 40		122 + 73	158 + 66 1/2	14
10	10 29		326 + 81	259 + 67	19
10	11 11		327 + 55	302 + 37	24
11	9 20		291 + 12	292 - 3	15
11	10 40		331 + 47	312 + 28	23 1/2
11	11 10		322 + 15	304 - 10	30
11	11 52		343 + 20	332 + 3	19
12	11 15		322 + 49	328 + 30	19 1/2

These meteors all belonged to the shower of Perseids. Motions very swift. They all left bright streaks.

The radiant point showed a displacement on nearly every successive night of observation. It was noted at 38° + 56° on the 6th, yet on the 13th a few meteors indicated it very exactly at 49 1/2° + 57 1/2°. This corroborates observations made by the writer in 1877, and reported in NATURE, vol. xvi. p. 362. A large number of Perseids were seen that year, and from an exact record of their flights the radiant point was seen to advance in R.A. as follows:—

$$\begin{aligned}
 1877, \text{ August } 3-7 &= \begin{matrix} a & d \\ 40^\circ & + 56^\circ \\ 43 & + 58 \\ 50 & + 56 \\ 60 & + 59 \end{matrix}
 \end{aligned}$$

This is further borne out by Mr. Henry Corder's extensive observations at Writtle, near Chelmsford, during the recent display, which may be tabulated as under:—

1880.	Watch.	Time.	Meteors seen.	Perseids.	Radiant point.
August 2	h.	h.			
2	2 1/2	9-12	25	9	35 + 56
2	1 1/2	10-12 1/2	21	7	35 + 56
4	2	10-12 1/2	35	13	46 + 57
6	2	10-10 1/2	13	6	43 + 56
8	2 1/2	10-13 1/2	59	26	45 + 59
9	4 1/2	9-13 1/2	120	84	45 + 58
10	1	9-12 1/2	46	39	—
11	3	9-13	76	50	46 + 58
Aug. 1-11	17 1/2	9-14 1/2	395	234	

Mr. Corder places the average position of the radiant of the true Perseids at 45° + 58°. On the first few nights of August he found it well defined at 35° + 56°, though on the 11th it had apparently shifted to 45° + 58°. And it is to be remarked that

on July 29-30 Mr. Corder had seen a shower of twenty meteors from the point  $29^{\circ} + 56'$ , which no doubt represented the first on-coming of the Perseids.

The night of August 10 at Mr. Corder's station was very hazy and generally overcast, so that though he was watching during the three hours preceding midnight, he estimated that his observation was not more than an equivalent to one hour of clear sky. He reckoned that under favourable conditions of the atmosphere the Perseids were falling at the rate of 40 per hour. Only one meteor he saw on the 10th was a fine one about  $= \gamma$ . It appeared at 11h. 23m. rather low in Ursa. It was rich orange in colour, with a long narrow streak broken in the middle. On August 11 Mr. Corder found meteors scarce; the shower had evidently fallen off considerably. The horary numbers found at Bristol were 26 of all meteors and 17 of Perseids, which very closely corresponds with Mr. Corder's figures, for, observing for three hours, he saw 76 meteors, amongst which were 50 Perseids. He mentions several instances in which the Perseid streaks were broken, and the same feature was frequently observed at Bristol. In such cases the nucleus had several maxima, and the streak-producing power seemed intensified at the point of each outburst.

Mr. Corder mentions a bright aurora as visible on the 11th and 12th instant. They were seen at Bristol also, but the phenomenon of the 12th was by far the most conspicuous. At about 10h. 20m. there was a vivid arch of crimson light spanning the horizon below the stars  $\beta - \gamma$  of Ursa Major, and the whole northern quadrant was aglow with streamers. But it soon lost its striking character, though there were indications of streamers at a much later period, and an auroral glow was apparent above the north-west horizon as late as 14h. It was also seen by the Rev. S. J. Johnson at Mitcheldeal, Glos., who writes:—"On the 12th there was a somewhat striking display of aurora. It began at 10h. 29m., and was bounded on the east by Capella, and on the west by Arcturus. The columns were often very vivid, but the brilliant character of the phenomenon only lasted 12 minutes."

Major Tupman observing at Cookham, near Maidenhead, Berks, reports the weather very cloudy on August 8, after 11h. 34m. In one hour (10h. 34m.—11h. 34m.) 13 meteors were seen, of which all but 2 were Perseids. August 9 very clear, and the sky watched from 9h. 56m. to 12h. 5m., when 31 meteors were seen, including 28 Perseids and 3 Cygnids. August 10—watch sustained from 9h. 5m. to 10h. 43m., when 15 or 16 Perseids were noted, and a few other small meteors. Sky clouded up at 10h. 43m. August 11 cloudy. Partly clear at 10h. 55m., and 3 Perseids observed, but at 11h. 9m. it again became overcast, and prevented further observation. The radiant point derived from a number of very accurately observed paths on August 9 was at  $44^{\circ} + 56'$ , with indications of a sub-radiant  $4^{\circ}$  higher in declination.

The Rev. G. T. Ryves, of Stoke-on-Trent, writes as follows:—

"August 8—10h. to 11h.—19 meteors seen, of which not more than 10 or 11 were Perseids. Soon after 11h. clouds formed, and interrupted further watching.

August 9, 9h. 45m. to 11h., 65 meteors seen.

„ 11h. to 12h. 45m., 30 meteors seen.

"From 80 to 85 were Perseids. The falling off in numbers after 11h. is only apparent, as up to that time I had been assisted by two pairs of eyes, and owing to my defective sight many of the smaller meteors would have escaped me afterwards.

"August 10, 9h. 30m. to 11h. 30m., 126 meteors seen. Nearly all of these were Perseids. During the whole of this period I was assisted by the two young observers above alluded to. Several brilliant meteors were recorded. On August 9, 12h. 25m., one was imperfectly seen in the Milky Way near horizon, in S.W., moving about S.W." This is obviously the same as one described at Bristol at 12h. 23m. the same night.

Another was seen by Mr. Ryves at 12h. 35m., August 9, moving very slightly west of, and parallel to, the stars  $\delta$  and  $\gamma$  of Cygnus, and at 11h. 2m., August 10, a fine meteor shot towards Aquila, the end point being noted slightly below and west of Altair. These meteors were evidently Perseids, though Mr. Ryves saw only a small proportion of brilliant meteors. He remarks: "The most noticeable feature in this year's display has been the great falling off in the average brightness of the meteors as compared with former years. Of the 240 meteors seen here not more than a dozen were such as would have attracted the

attention of any one but trained observers, the great majority requiring rather exceptionally keen eyes to detect them at all."

Mr. Cornish, at Debenham, Suffolk, gives the following summary of watches between August 1 and 12:—

August 1, 10h. 15m. to 11h. 40m.	Meteors.	Observers.
9, 10h. to 11h. ... ..	23 ...	V. Cornish
9, 10h. 40m. to 11h. ... ..	23 ...	H. Heather
11, 9h. 48m. to 11h. 38m. ... ..	56 ...	V. Cornish
12, 9h. 3m. to 9h. 33m. ... ..	6 ...	H. Heather

On the 11th no less than 24 were noted during the first half-hour's observation. The sky was partly cloudy after 11h. A 1st mag. stationary meteor was seen at  $348\frac{1}{2} - 23$  on August 4, at 13h. 48m. On August 9, 10h. 23m., a meteor = Sirius shot from  $0^{\circ} + 37'$  to  $349^{\circ} + 28'$ , and it appears to be identical with a fine meteor registered by Mr. Ryves at Stoke-on-Trent, August 9, 10h. 25m., path from a Andromedæ to a Pegasus. Mr. Cornish remarks that "the recent display of Perseids was not equal to that of last year, even supposing the circumstances to have been as favourable." It must be remembered, however, that on the all-important night of August 10 few observations could be obtained, owing to the generally unfavourable state of the sky, and that under these conditions a comparison cannot fairly be instituted. Mr. Corder estimated the horary rate of Perseids as 40 per hour on the 10th; and at Bristol, where the stars could only be seen in dim outline through the fog-laden atmosphere, the number actually counted at an early period of the night was 28 per hour. This compares favourably with the last successful observation of this shower obtained by the writer in 1877, when, with a perfectly clear sky, 57 Perseids were noted between 9h. to 11h., = 38 per hour. Making allowance for the difference of weather, the recent display, though it cannot be regarded as in any way exceptional, may yet be classed as a fairly active return of the shower; and it is fortunate that on the several nights immediately preceding and following the 10th, the state of the sky allowed its progress to be traced with unusual distinctness.

The Rev. S. J. Johnson, at Abbenhall Rectory, Mitcheldeal, Glos., saw 20 meteors during an hour's watch (10h. 57m. to 11h. 57m.) on August 9. The following night there was much cloud about at times, especially in the eastern sky, so that only 16 meteors were seen between 10h. 3m. and 11h. 30m. On the 11th the night was very clear, and 12 meteors seen between 10h. and 11h. Mr. Johnson gives a list of the brighter meteors, which includes several nearly equal to Jupiter, and many 1st magnitude.

The night of the 9th appears to have been very favourable at all stations, and more shooting-stars were seen on that date than on the 10th, when the sky was in part overcast. On the 11th there was a very evident falling-off in the number of meteors observed at Chelmsford and Bristol, the horary rate of apparition of the Perseids being noted as 17 at both places. The following night it had fallen to 8, and on the 13th to 5, as derived from observations at Bristol, and the absolute cessation of the shower was evidently near at hand.

W. F. DENNING

#### INTERNATIONAL METEOROLOGY

THE International Meteorological Committee appointed by the Congress of Rome held its first meeting at the Observatory, Berne, from the 9th to the 12th ultimo. All the members of the Committee, nine in number, were present. Their names are as follows:—

Prof. H. Wild (president), Mr. R. H. Scott (secretary), Professors Buys Ballot and Cantoni, Capt. de Brito Capello, Professors Hann, Mascart, and Mohr, and Dr. Neumayer. The following is a brief notice of the most interesting results of the meeting:—

*The International Comparison of Standard Instruments.*—The original scheme for this undertaking was based on the supposition that thirty-six European observatories would take part in it, each paying a contribution of about 15*l*. The number of acceptances of the proposal up to the date of the meeting was, however, insufficient to justify the Committee in commencing the comparison, and it was therefore determined to recommend each country to carry out a careful comparison of its own standard instruments with those of neighbouring countries.

*The International Simultaneous Observations.*—The proposal recently made by the Chief Signal Office, Washington, to change

the time of this observation from oh. 43m. to oh. 8m. p.m. was discussed, and it was resolved to accede to the proposal, notwithstanding the inconvenience which the change might entail in individual systems of observation.

*The Proposal for Concerted Arctic Observations.*—The International Polar Commission appointed at Hamburg, in October, 1879, presented a report of a meeting it had recently held at Berne, and announced that Count Wilczek and Lieut. Weyprecht had consented to postpone their expedition to Nova Zembla until 1882 in order to allow of more time for the organisation of the other expeditions destined to co-operate with them. The International Committee resolved to aid the scheme by all the means in their power.

*The Publication of Data referring to Rain, &c.*—A proposal made by Dr. Köppen for an improved method of publication of information relating to rain, snow, &c., was ordered to be circulated among the different observatories, in order to obtain opinions as to its suitability.

*Telegraphic Communication with the Atlantic Islands.*—Capt. Hoffmeyer submitted a resolution as to the desirability of laying cables to the Faroes, Iceland, Greenland, and to the Azores. The Committee expressed their hope that it might be found possible to lay these cables, which would be of very great importance for the weather service of Europe.

*The Publication of Average Values for Meteorological Data.*—The Committee, at Capt. Hoffmeyer's suggestion, recommended that all meteorological organisations should publish regularly the mean values for the most important elements for the telegraphic and international stations.

*The Catalogue of Meteorological Literature.*—A proposal made by Dr. Hellmann of Berlin for the preparation of such a catalogue was considered. Dr. Hellmann stated that he had calculated the cost of preparation of the catalogue of printed books and memoirs at about 550*l.*, and that of printing and publication (1,000 copies) at about 750*l.*

Several of the members of the Committee promised to aid in carrying out the scheme, if it were seriously undertaken, by the preparation of catalogues of the literature which exists in their own individual languages. The subject was finally referred to Mr. Scott and Dr. Hellmann, with power to act if they found sufficient encouragement.

As to the catalogue of unpublished records of observations, no definite resolution was adopted.

*International Tables for the Reduction of Observations.*—It was stated that a publishing firm in Leipzig was prepared to print and publish such tables at its own risk if the "copy" were delivered to them. The subject was referred to Prof. Mascart and Prof. Wild for the preparation of a definite plan for the calculation of the tables.

The Committee will include in its Report, which will shortly appear, a notice of the progress made in each country in carrying out the resolutions of the Congress of Rome.

It only remains to say that the members of the Committee were most hospitably entertained by the Federal Council and by the Municipality of Berne.

### AGRICULTURAL CHEMISTRY<sup>1</sup>

SOME of my predecessors in this chair, whose duties as teachers of chemistry lead them to traverse a wide range of the subject every year, have appropriately and usefully presented to the Section a *résumé* of the then recent progress in the manifold branches of the science which have now such far-reaching ramifications. Some, on the other hand, have confined attention to some department with which their own inquiries have more specially connected them.

But it seems to me that there is a special reason why I should bring the subject of Agricultural Chemistry before you on the present occasion. Not only is the application of chemistry to agriculture included in the title of this Section, but in 1837 the Committee of the Section requested the late Baron Liebig to prepare a report upon the then condition of Organic Chemistry, and it is now exactly forty years since Liebig presented to the British Association the first part of his report, which was entitled "Organic Chemistry in its Applications to Agriculture and Physiology"; and the second part was presented two years later, in 1842, under the title of "Animal Chemistry, or Organic Chemistry

<sup>1</sup> Opening Address in Section B (Chemical Science), at the Swansea meeting of the British Association, by J. M. Gilbert, Ph.D., F.R.S., V.B.C.S., F.L.S., President of the Section.

in its Application to Physiology and Pathology." Yet, so far as I am aware, no President of the Section has, from that time to the present, taken as the subject of his address the Application of Chemistry to Agriculture.

Appropriate as, for these reasons, it would seem that I, who have devoted a very large portion of the interval since the publication of Liebig's works, above referred to, to agricultural inquiries, should occupy the short time that can be devoted to such a purpose in attempting to note progress on that important subject, it will be readily understood that it would be quite impossible to condense into the limits of an hour's discourse anything approaching to an adequate account, either of the progress made during the last forty years, or of the existing condition of agricultural chemistry.

For what is agricultural chemistry? It is the chemistry of the atmosphere, the chemistry of the soil, the chemistry of vegetation, and the chemistry of animal life and growth. And but a very imperfect indication of the amount of labour which has been devoted of recent years to the investigation of these various branches of what might at first sight seem a limited subject will suffice to convince you how hopeless a task it would be to seek to do more than direct attention to a few points of special interest.

From what we now know of the composition and of the sources of the constituents of plants, it is obvious that a knowledge of the composition of the atmosphere and of water was essential to any true conception of the main features of the vegetative process; and it is of interest to observe that it was almost simultaneously with the establishment, towards the end of the last century, of definite knowledge as to the composition of the air and of water, that their mutual relations with vegetation were first pointed out. To the collective labours of Black, Scheele, Priestly, Lavoisier, Cavendish, and Watt, we owe the knowledge that common air consists chiefly of nitrogen and oxygen, with a little carbonic acid; that carbonic acid is composed of carbon and oxygen; and that water is composed of hydrogen and oxygen; whilst Priestly and Ingenhousz, Sennebler and Woodhouse, investigated the mutual relations of these bodies and vegetable growth. Priestly observed that plants possessed the faculty of purifying air vitiated by combustion or by the respiration of animals; and, he having discovered oxygen, it was found that the gaseous bubbles which Bonnet had shown to be emitted from the surface of leaves plunged in water consisted principally of that gas. Ingenhousz demonstrated that the action of light was essential to the development of these phenomena; and Sennebler proved that the oxygen emitted resulted from the decomposition of the carbonic acid taken up.

De Saussure concluded that air and water contributed a much larger proportion of the dry substance of plants than did the soils in which they grew. In his view a fertile soil was one which yielded liberally to the plant nitrogenous compounds, and the incombustible or mineral constituents; whilst the carbon, hydrogen, and oxygen, of which the greater proportion of the dry substance of the plant was made up, were at least mainly derived from the air and water.

Perhaps I ought not to omit to mention here that, each year for ten successive years, from 1802 to 1812, Sir Humphry Davy delivered a course of lectures on the "Elements of Agricultural Chemistry," which were first published in 1813, were finally revised by the author for the fourth edition in 1827, but have gone through several editions since. In those lectures Sir Humphry Davy passed in review and correlated the then existing knowledge, both practical and scientific, bearing upon agriculture. He treated of the influences of heat and light; of the organisation of plants; of the difference, and the change, in the chemical composition of their different parts; of the sources, composition, and treatment of soils; of the composition of the atmosphere, and its influence on vegetation; of the composition and the action of manures; of fermentation and putrefaction; and finally of the principles involved in various recognised agricultural practices.

With the exception of these discourses of Sir Humphry Davy, the subject seems to have received comparatively little attention, nor was any important addition made to our knowledge in regard to it during the period of about thirty years from the date of the appearance of De Saussure's work in 1804 to that of the commencement of Boussingault's investigations.

In 1837 Boussingault published papers on the amount of gluten in different kinds of wheat, on the influence of the clearing of forests on the diminution of the flow of rivers, and on the

meteorological influences affecting the culture of the vine. In 1838 he published the results of an elaborate research on the principles underlying the value of a rotation of crops. He determined by analysis the composition, both organic and inorganic, of the manures applied to the land, and of the crops harvested. In his treatment of the subject he evinced a clear perception of the most important problems involved in such an inquiry; some of which, with the united labours of himself and many other workers, have scarcely yet received an undisputed solution.

Thus, in the same year (1838), he published the results of an investigation on the question whether plants assimilate the free or uncombined nitrogen of the atmosphere; and although the analytical methods of the day were inadequate to the decisive settlement of the point, his conclusions were in the main those which much subsequent work of his own, and much of others also, has served to confirm.

The foregoing brief historical sketch is sufficient to indicate, though but in broad outline, the range of existing knowledge on the subject of agricultural chemistry prior to the appearance of Liebig's memorable work in 1840. It will be seen that some very important and indeed fundamental facts had already been established in regard to vegetation, and that Boussingault had not only extended inquiry on that subject, but he had brought his own and previous results to bear upon the elucidation of long recognised agricultural practices. There can be no doubt that the data supplied by his researches contributed important elements to the basis of established facts upon which Liebig founded his brilliant generalisations. Accordingly, in 1841, Dumas and Boussingault published jointly an essay which afterwards appeared in English under the title of "The Chemical and Physiological Balance of Organic Nature;" and in 1843 Boussingault published a larger work, which embodied the results of many of his own previous original investigations.

The appearance of Liebig's two works, which were contributions made in answer to a request submitted to him by the committee of this Section of the British Association, constitute a very marked epoch in the history of the progress of agricultural chemistry. In the treatment of his subject he not only called to his aid the previously existing knowledge directly bearing upon it, but he also turned to good account the more recent triumphs of organic chemistry, many of which had been won in his own laboratory. Further, a marked feature of his expositions was the adoption of what may be called the *statistical method*—I use the word *statistical* rather than *quantitative*, as the latter expression has its own technical meaning among chemists, which is not precisely what I wish to convey.

The discussion of the processes of fermentation, decay, and putrefaction, and that of poisons, contagions, and miasms, constituted a remarkable and important part of Liebig's first report. It was the portion relating to poisons, contagions, and miasms, that he presented to this Section as an instalment, at the meeting of the Association held at Glasgow in 1840. It was in the chapters relating to the several subjects here enumerated that he developed so prominently his views on the influence of contact in inducing chemical changes. He cited many known transformations, other than those coming under either of the heads in question, in illustration of his subject; and he discussed with great clearness the different conditions occurring, and the different results obtained, in various processes—such as the different modes of fermenting beer, the fermentation of wine from different kinds of grapes, the production of acetic acid, &c. As is well known, he claimed a purely chemical explanation for the phenomena involved in fermentation. He further maintained that the action of contagions was precisely similar. In his latest writings on the subject (in 1870) he admits some change of view; but it is by no means easy to decide exactly how much or how little of modification he would wish to imply.

Liebig's second report, presented at the meeting of this Association in 1842, and published under the title of "Animal Chemistry, or Organic Chemistry in its Applications to Physiology and Pathology," perhaps excited even more attention than his first; and, probably from the manner as much as from the matter, aroused a great deal of controversy, especially among physiologists and physicians. Liebig was severe upon what he considered to be a too exclusive attention to morphological characters in physiological research, and at any rate too little attention to chemical phenomena, and, so far as these were concerned, an inadequate treatment of the subject according to strictly quantitative methods.

Omitting the fat which the carnivora might receive in the animals they consumed, he stated the characteristic difference between the food of carnivora and herbivora to be, that the former obtained the main proportion of their respiratory material from the waste of tissue; whilst the latter obtained a large amount from starch, sugar, &c. These different conditions of life accounted for the comparative leanness of carnivora and fatness of herbivora.

He maintained that the vegetable food consumed by herbivora did not contain anything like the amount of fat which they stored up in their bodies; and he showed how nearly the composition of fat was obtained by the simple elimination of so much oxygen, or of oxygen and a little carbonic acid, from the various carbohydrates. Much less oxygen would be required to be eliminated from a quantity of fibrine, &c., containing a given amount of carbon, than from a quantity of carbohydrates containing an equal amount of carbon. The formation of fatty matter in plants was of the same kind; it was the result of a secondary action, starch being first formed from carbonic acid and water.

He concluded from the facts adduced that the food of man might be divided into the *nitrogenised* and the *non-nitrogenised* elements. The former were capable of conversion into blood, the latter incapable of such transformation. The former might be called the *plastic elements of nutrition*, the latter *elements of respiration*. From the plastic elements, the membranes and cellular tissue, the nerves and brain, cartilage, and the organic part of bones, could be formed; but the plastic substance must be received ready-made. Whilst gelatine or chondrine was derived from fibrine or albumen, fibrine or albumen could not be reproduced from gelatine or chondrine. The gelatinous tissues suffer progressive alteration under the influence of oxygen, and the materials for their re-formation must be restored from the blood. It might however be a question whether gelatine taken in food might not again be converted into cellular tissue, membrane, and cartilage, in the body.

Apparently influenced by the physiological considerations which have been adduced, and notwithstanding in some passages he seemed to recognise a connection between the total quantity of oxygen inspired and consumed and the quantity of mechanical force developed, Liebig nevertheless very prominently insisted that the amount of muscular tissue transformed—the amount of nitrogenous substance oxidated—was the measure of the force generated. He accordingly distinctly draws the conclusion that the requirement for the azotised constituents of food will be increased in proportion to the increase in the amount of force expended.

It will be obvious that the question whether in the feeding of animals for the exercise of mechanical force, that is, for their labour, the demands of the system will be proportionally the greater for an increased supply of the nitrogenous or of the non-nitrogenous constituents of food, is one of considerable interest and practical importance. To this point I shall have to refer further on.

So far, I have endeavoured to convey some idea of the state of knowledge on the subject of the chemistry of agriculture prior to the appearance of Liebig's first two works bearing upon it, and also briefly to summarise the views he then enunciated in regard to some points of chief importance. Let us next try to ascertain something of the influence of his teaching.

Confining attention to agricultural research, it may be observed that about the year 1843, that is very soon after the appearance of the works in question, there was established the Chemico-Agricultural Society of Scotland, which was, I believe, broken up, after it had existed about five years, because its able chemist, the late Prof. Johnston, was unable to find a remedy for the potato disease. Shortly after this, the Highland and Agricultural Society of Scotland appointed a consulting chemist; somewhat later the Royal Agricultural Society of England did the same; and later still followed the Chemico-Agricultural Society of Ulster. Lastly, the very numerous "Agricultural Experimental Stations" which have been established, not only in Germany, but in most Continental States, owe their origin directly to the writings, the teachings, and the influence of Liebig. The movement seems to have originated in Saxony, where Stöckhardt had already stimulated interest in the subject by his lectures and his writings. After some correspondence, in 1850-51, between the late Dr. Crueus and others on the one side, and the Government on the other, the first so-called "Agricultural Experimental Sta-

tion" was established at Möchern, near Leipzig, in 1851-52. In 1877 the twenty-fifth anniversary of the foundation of that institution was celebrated at Leipzig, when an account (which has since been published) was given of the number of stations then existing, of the number of chemists engaged, and of the subjects which had been investigated. From that statistical statement we learn that in 1877 the number of stations was 122.

Besides these stations on the Continent of Europe, the United States are credited with one, and Scotland also with one.

Each of these stations is under the direction of a chemist, frequently with one or more assistants. One special duty of most of them is what is called manure- or seed- or feeding-stuff-control; that is, to examine or analyse, and report upon such substances in the market, and it seems to have been found to the interest of dealers in these commodities to submit their proceedings to a certain degree of supervision by the chemist of the station of their district.

But agricultural research has always been a characteristic feature of these institutions. It is stated that the investigation of soils has been the prominent object at 16 of them, experiments with manures at 24, vegetable physiology at 28, animal physiology and feeding experiments at 20, vine culture and wine making at 13, forest culture at 9, and milk production at 11. Others, according to their locality, have devoted special attention to fruit culture, olive culture, the cultivation of moor, bog, and peat land, the production of silk, the manufacture of spirit, and other products.

Nor does this enumerations of the institutions established as the direct result of Liebig's influence, and of the subjects investigated under their auspices, complete the list either of the workers engaged, or of the work accomplished in agricultural research. To say nothing of the labours of Boussingault, which commenced some years prior to the appearance of Liebig's first work, and which are fortunately still at the service of agriculture, important contributions have been made by the late Professors Johnston and Anderson in Scotland, and in this country both by Mr. Way and Dr. Voelcker, each alike in his private capacity, and in fulfilment of his duties as Chemist to the Royal Agricultural Society of England. Nor would it be fair to Mr. Lawes (who commenced experimenting first with plants in pots, and afterwards in the field, soon after entering into possession of his property in 1834, and with whom I have myself been associated since 1843), were I to omit in this place any mention of the investigations which have been so many years in progress at Rothamsted.

So much for the machinery; but what of the results achieved by all this activity in the application of chemistry to agriculture?

The more I have looked at the subject with the hope of treating it comprehensively, the more I have been impelled to substitute a very limited plan for the much more extended scheme which I had at first hoped to be able to fill up. I propose then to confine attention to a few special points, which have either some connection with one another, or to which recent results or discussions lend some special interest.

First as to the sources and the assimilation of the carbon, the hydrogen, and the oxygen of vegetation. From the point of view of the agricultural chemist, the hydrogen and the oxygen may be left out of view. For, if the cultivator provide to the plant the conditions for the accumulation of sufficient nitrogen and carbon, he may leave it to take care of itself in the matter of hydrogen and oxygen. That the hydrogen of the carbohydrates is exclusively obtained from water, is, to say the least, probable; and whether part of their oxygen is derived from carbonic acid, and part from water, or the whole from either of these, will not affect his agricultural practice.

With regard to the carbon, the whole tendency of subsequent observations is to confirm the opinion put forward by Dr. Saussure about the commencement of the century, and so forcibly insisted upon by Liebig forty years later—that the greater part, if not the whole of it, is derived from the carbonic acid of the atmosphere. Indeed, direct experiments are not wanting—those of Moll, for example—from which it has been concluded that plants do not even utilise the carbonic acid which they may take up from the soil by their roots. However this may be, we may safely conclude that practically the whole of the carbon which it is the object of the cultivator to force the plants he grows to take up is derived from the atmosphere, in which it exists in such extremely small proportion, but nevertheless large actual, and constantly renewed amount.

Judging from the more recent researches on the point, it would

seem probable that the estimate of one part of carbon, as carbonic acid, in 10,000 of air, is more probably too high than too low as an estimate of the average quantity in the atmosphere of our globe. And, although this corresponds to several times more in the column of air resting over an acre of land than the vegetation of that area can annually take up, it represents an extremely small amount at any one time in contact with the growing plants, and could only suffice on the supposition of a very rapid renewal accomplished as the result, on the one hand, of a constant return of carbonic acid to the atmosphere by combustion and the respiration of animals, and, on the other, of a constant interchange and equalisation among the constituents of the atmosphere.

It will convey a more definite idea of what is accomplished by vegetation in the assimilation of carbon from the atmosphere if I give, in round numbers, the results of some direct experiments made at Rothamsted, instead of making general statements merely.

In a field which has now grown wheat for thirty-seven years in succession there are some plots to which not an ounce of carbon has been returned during the whole of that period. Yet, with purely mineral manure, an average of about 1,000 pounds of carbon is annually removed from the land; and where a given amount of nitrogenous manure is employed with the mineral manure, an average of about 1,500 pounds per acre per annum more is obtained; in all an average of about 2,500 pounds of carbon annually assimilated over an acre of land without any return of carbonaceous manure to it.

In a field in which barley has been grown for twenty-nine years in succession, quite accordant results have been obtained. There smaller amounts of nitrogenous manure have been employed with the mineral manure than in the experiments with wheat above cited; but the increase in the assimilation of carbon for a given amount of nitrogen supplied in the manure is greater in the case of the barley than of the wheat.

With sugar-beet again, larger amounts of carbon have been annually accumulated without the supply of any to the soil, but under the influence of a liberal provision of both nitrogenous and mineral manure, than by either wheat or barley.

Lastly, with grass, still larger amounts of carbon have been annually accumulated, without any supply of it by manure.

Many experiments have been made in Germany and elsewhere, to determine the amount of the different constituents taken up at different periods in the growth of various plants. But we may refer to some made at Rothamsted long ago to illustrate the rapidity with which the carbon of our crops may be withdrawn from the atmosphere.

In 1847 we carefully took samples from a growing wheat crop at different stages of its progress, commencing on June 21, and in these samples the dry matter, the mineral matter, the nitrogen, &c., were determined. On each occasion the produce of two separate eighths or sixteenths of an acre was cut and weighed, so that the data were provided to calculate the amounts of the several constituents which had been accumulated per acre at each period. The result was that, whilst during little more than five weeks from June 21 there was comparatively little increase in the amount of nitrogen accumulated over a given area, more than half the total carbon of the crop was accumulated during that period.

I should say that determinations of carbon, made in samples of soil taken from the wheat-field at different periods during recent years, indicate some decline in the percentage of carbon in the soils, but not such as to lead to the supposition that the soils have contributed to the carbon of the crops. Besides the amount of carbon annually removed, there will of course be a further accumulation in the stubble and roots of the crops; and the reduction in the total carbon of the soil, if such have really taken place, would show that the annual oxidation within the soil is greater than the annual gain by the residue of the crops.

Large as is the annual accumulation of carbon from the atmosphere over a given area in the cases cited, it is obvious that the quantity must vary exceedingly with variation of climatal conditions. It is, in fact, several times as great in the case of tropical vegetation—that of the sugar-cane, for example. And not only is the greater part of the assimilation accomplished within a comparatively small portion of the year (varying of course according to the region), but the action is limited to the hours of daylight, whilst during darkness there is rather loss than gain.

But it is remarkable that whilst the accumulation of carbon, the chief gain of solid material, takes place under the influence

of light, cell-division, cell-multiplication, increase in the structure of the plant, in other words, what, as distinguished from assimilation, vegetable physiologists designate as *growth*, takes place, at any rate chiefly, during the night; and is accompanied, not with the taking up of carbonic acid and the yielding up of oxygen, but with the taking up of oxygen and the giving up of carbonic acid. This evolution of carbonic acid during darkness must obviously be extremely small, compared with the converse action during daylight, coincidentally with which practically the whole of the accumulation of solid substance is accomplished. But as the product of the night action is the same as in the respiration of animals, this is distinguished by vegetable physiologists as the respiration of plants.

I suppose I shall be considered a heretic if I venture to suggest that it seems in a sense inappropriate to apply the term *growth* to that which is associated with actual loss of material, and that the term *respiration* should be applied to so secondary an action as that as the result of which carbonic acid is given off from the plant. It may, I think, be a question whether there is any advantage in thus attempting to establish a parallelism between animal and vegetable processes; rather would it seem advantageous to keep prominently in view their contrasted, or at any rate complementary characteristics, especially in the matter of the taking up of carbonic acid and the giving up of oxygen on the one hand, and the taking in of oxygen and the giving up of carbonic acid on the other.

But it is obvious that in latitudes where there is comparatively continuous daylight during the periods of vegetation, the two actions—designated respectively assimilation and growth—must go on much more simultaneously than where there is a more marked alternation of daylight and darkness. In parts of Norway and Sweden, for example, where during the summer there is almost continuous daylight, crops of barley are grown with only from six to eight weeks intervening from seed-time to harvest. And Prof. Schübeler, of Christiania, after making observations on the subject for nearly thirty years, has recently described the characteristics of the vegetation developed under the influence of short summers with almost continuous light. He states that, after acclimatisation, many garden flowers increase in size and depth of colour; that there is a prevailing tinge of red in the plants in the fields; that the aroma of fruits is increased, and their colour well developed, but that they are deficient in sweetness; and that the development of essential oils in certain plants is greater than in the same plants grown in other latitudes. Indeed he considers it to be an established fact that light bears the same relation to aroma as heat does to sweetness.

In connection with this question of the characters of growth under the influence of continuous light, compared with those developed with alternate light and darkness, the recent experiments of Dr. Siemens on the influence of electric light on vegetation are of considerable interest.

In one series of experiments he kept one set of plants entirely in the dark, a second he exposed to electric light only, a third to daylight only, and a fourth to daylight and afterwards to electric light from 5 to 11 p.m. Those kept in the dark acquired a pale yellow colour, and died; those exposed to electric light only maintained a light green colour, and survived; those exposed to daylight were of a darker green colour, and were more vigorous; and, lastly, those submitted to alternate daylight and electric light, and but a few hours of darkness, showed decidedly greater vigour, and, as he says, the green of the leaf was of a dark rich hue. He concluded that daylight was twice as effective as electric light; but that, nevertheless, "electric light was clearly sufficiently powerful to form chlorophyll and its derivatives in the plants."

In a second series of experiments one group of plants was exposed to daylight alone; a second to electric light during eleven hours of the night, and was kept in the dark during the day; and a third to eleven hours day, and eleven hours electric light. The plants in daylight showed the usual healthy appearance; those in alternate electric light and darkness were for the most part of a lighter colour; and those in alternate daylight and electric light far surpassed the others in darkness of green and vigorous appearance generally.

I have carefully considered these general descriptions with a view to their bearing on the question whether the characters developed under the influence of electric light, and especially those under the influence of almost continuous light, are more prominently those of assimilation or of growth; but I have not

been able to come to a decisive opinion on the point. From some conversation I had with Dr. Siemens on the subject, I gather that the characteristics were more those of dark colour and vigour than of tendency to great extension in size. The dark green colour we may suppose to indicate a liberal production of chlorophyll; but if the depth of colour was more than normal it might be concluded that the chlorophyll had not performed its due amount of assimilation work. In regard to this point attention may be called to the fact that Dr. Siemens refers to the abundance of the blue or actinic rays in the electric arc, conditions which would not be supposed specially to favour assimilation. On the other hand, the vigour, rather than characteristic extension in size, would seem to indicate a limitation of what is technically called growth, under the influence of the almost continuous light.

Among the numerous field experiments made at Rothamsted, we have many examples of great variation in depth of green colour of the vegetation growing on plots side by side under known differences as to manuring; and we have abundant evidence of difference of composition, and of rate of carbon-assimilation, coincidentally with these different shades of colour. One or two instances will strikingly illustrate the point under consideration.

The point of special interest is, however, that all but identically the same amount of nitrogen has been taken up by the herbage growing with the deficiency of potass as by that with the continued supply of it. The colour of the vegetation with the deficiency of potass has been very much darker green than that with the full supply of it.

An equal amount of nitrogen was taken up in both cases, chlorophyll was abundantly produced, but the full amount of carbon was not assimilated. In other words, the nitrogen was there, the chlorophyll was there, there was the same sunlight for both plots; but the assimilation-work was not done where there was not a due supply of potass.

It may be stated generally that, in comparable cases, depth of green colour, if not beyond a certain limit, may be taken to indicate corresponding activity of carbon assimilation; but the two instances cited are sufficient to show that we may, so far as the nitrogen, the chlorophyll, and the light are concerned, have the necessary conditions for full assimilation, but not corresponding actual assimilation.

It cannot, I think, fail to be recognised that in these considerations we have opened up to view a very wide field of research, and some of the points involved we may hope will receive elucidation from the further prosecution of Dr. Siemens' experiments. He will himself, I am sure, be the first to admit that what he has already accomplished has done more in raising than in settling important questions. I understand that he proposes to submit plants to the action of the separated rays of his artificial light, and the results obtained cannot fail to be of much interest. But it is obvious that the investigation should now pass from its present initiative character to that of a strictly quantitative inquiry. We ought to know not only that, under given conditions as to light, plants acquire a deeper green colour, and attain maturity much earlier than under others, but how much matter is assimilated in each case, and something also of the comparative chemical characters of the products. As between the action of one description of light and another, and as between the greater or less continuity of exposure, we ought to be able to form a judgment whether the proper balance between assimilation on the one hand, and growth and proper maturation on the other, has been attained; whether the plants have taken up nitrogen and mineral matter and produced chlorophyll in a greater degree than the quantity and the quality of the light have been able to turn to account; or whether the conditions as to light have been such that the processes of transformation and growth from the reserve material provided by assimilation have not been normal or have not kept pace with the production of that material.

But one word more in reference to Dr. Siemens' results and proposed extension of his inquiries. Even supposing that by submitting growing crops to continuous light by the aid of the electric light during the night, they could be brought to maturity within a period shorter than at present approximately in proportion to the increased number of hours of exposure, the estimates of the cost of illuminating the vegetation of an acre of land certainly do not seem to hold out any hope that agriculture is likely to derive benefit from such an application of science to its needs. If, however, the characters of growth and of maturation should



prove to be suitable for the requirements of horticultural products of luxury and high value, it may possibly be otherwise with such productions.

The above considerations obviously suggest the question: What is the office of chlorophyll in the processes of vegetation? Is it, as has generally been assumed, confined to effecting, in some way not yet clearly understood, carbon assimilation, and, this done, its function ended; or is it, as Pringsheim has recently suggested, chiefly of avail in protecting the subjacent cells and their contents from those rays of light which would be adverse to the secondary processes which have been distinguished as growth?

Appropriate as it would seem that I should attempt to lay before you a *résumé* of results bearing upon the points herein involved, so numerous and so varied have been the investigations which have been undertaken on the several branches of the question in recent years, that adequately to discuss them would occupy the whole time and space at my disposal. I must therefore be content thus to direct attention to the subject, and pass on to other points.

(To be continued.)

### THE BRITISH ASSOCIATION REPORTS

*Report on the Tertiary Flora of the Basalts of the North of Ireland*, by Mr. W. H. Baily.—Described the plants of Miocene deposits, consisting of variegated marls, resting on a leaf-bed near Glenarm. Amongst the plants were *Sequoia coultsia*, *S. lyelli*, *Fagus decalium*, *Nyssa ornithobroma*, *Aralis brownia*, *Fraxinus guillelma*. These and others have been drawn and described.

*Report on the Viviparous Nature of the Ichthyosauri*, by Prof. H. C. Seeley.—Dr. Channen Pierce had formerly described a specimen of Ichthyosaurus in the Museum at Bristol which he considered contains a foetus in the act of coming into the world, which view is supported by Prof. Seeley, who showed, reasoning by the analogy of the stomach of a crocodile, it was impossible that this animal could have swallowed a smaller ichthyosaurus, and its remains been retained in the stomach in a perfect form, and alludes to the spiral structure of the coprolite, pointing to a small intestine, and thought it impossible that the animal could have passed through them in the process of digestion; and alluded to the fact that all German specimens show the head of the smaller projecting towards the tail of the larger, though the reverse is the case in a specimen at Madrid. But in Tübingen the most perfect specimens occur, in which the smaller animals are found lying completely preserved between the ribs of the parent animal; though, he suggests, in all cases viviparous characters may not have obtained in all forms of ichthyosauri.

*The Sixth Report of the Underground Water Committee* was read by Mr. De Rance, who pointed out that the watershed separating the basins of the Thames and Eastern Counties from those of the Humber and the Severn also divides the area of heaviest rainfall on the Palaeozoic rocks, which are nearly all impermeable, from those of Secondary age, receiving a rainfall of about 30 inches. West of this line, with the exception of the Trias, no Secondary rocks occur. In Lancashire, Cheshire, and the Midlands the Triassic Sandstones absorb about one-third of the rainfall, giving a daily average of 400,000 gallons to each square mile of country: wells in these rocks are capable of drawing on several square miles, and in suitable situations of yielding from 2 to 3 million gallons per day. The discovery of the Manchester coalfield beds at Winwick, near Warrington, under the New Red Sandstone, at a depth of only 240 feet, was described. He referred to the position of the New Red boring at Bootle, for the Liverpool Corporation water supply, as very badly chosen, being close to one of the existing wells. He then showed the gradual attenuation in thickness of the Bunter Sandstones, in a southerly direction, against the old Palaeozoic axis, ranging from the Belgian coalfield to the Mendips.

*Report on the Present State of our Knowledge of the Crustacea*, by C. Spence Bate, F.R.S.—This is Part v. of the Report, and deals with the subjects of fecundation, respiration, and the green gland.

### SECTION A.—MATHEMATICAL AND PHYSICAL

*Improved Apparatus for the Objective Estimation of Astigmatism*, by Tempest Anderson, M.D., B.Sc.—Astigmatism has been defined as that condition of the eye in which refraction is unequal in the different meridians. In order to obtain suitable spectacles for correcting this defect, it is necessary to know accurately the focal adjustment of the meridians of maximum and minimum curvature, whence the focal lengths of glasses, generally either cylindrical or cylindrical on one side and spherical on the other, are readily calculated. Many plans have been adopted for determining this; some subjective, depending on observations made by the eye itself, and generally using a point of light or a series of radiating lines as an object. From their appearances when viewed at different distances, and with lenses of different powers, the focal adjustment of the different meridians is at last obtained.

The advantage of this group of methods is their theoretical delicacy, as they work by judging of the perfection of certain images refracted on the retina in a manner not very dissimilar to that in which they are usually formed; the practical disadvantage, that accurate observations are required from one who has never been accustomed to make them. Hence objective methods have been introduced. Their advantages are, substituting trained for untrained observation. Their disadvantages—

1. The vessels of the retina and the optic nerves, which are mostly employed as objects, are seldom in exactly the position desirable for estimating the refraction in different meridians, and are often at a different distance from the optical system of the eye from that at which the sensitive layer of the retina lies.

2. They mostly require the optical defects, if any, and the accommodation of the observing eye to be taken into account and allowed for, thus introducing risk of error.

In the author's two instruments, an image of a suitable object thrown on the retina of the observed eye, is used as an object by the observer, with the following advantages:—

1. The patient's sensations may be entirely disregarded, or only used as confirmatory.

2. The image used is necessarily at the retina, and not before or behind it.

3. The accommodation or any defects in the refraction of the observer's eye does not enter into the result, as the only function of this eye is to observe the formation of the image on the retina.

In the first plan a lamp *l* is provided with a condensing lens *c*, and a series of radiating wires *w* (supposed to be seen edgewise in the figure), thus giving a bright field with black lines on it.

The whole slides on a graduated bar *C*, at the other end of which is a convex lens *y* (4 and 10 dioptics are the most convenient powers, i.e. 10 and 4 inch focus). Close to the lens, and at an angle of 45° to its axis, is a plane mirror (*m*), which reflects the rays at right angles to their former path. The instrument is to be held so that this pencil of rays enters (the observed eye, and when the wire screen is at the proper distance, an image of it is formed on the retina. The mirror has the centre left unsilvered, as in an ordinary ophthalmoscope, and has a disk of correcting lenses behind it, to render the retina, and the image on it, visible by the direct method. The observed eye should have its accommodation relaxed by atropine.

The bar is so graduated that when an image of the whole or part of the screen is sharp on the retina, the figure opposite the screen expresses the refractive error of the meridian by which the image is produced. Hence if the image of the whole screen is seen to be equally sharp, the eye is known to be not astigmatic, and the graduation given the number of dioptics by which it is myopic or hypermetropic. If the lines be not all sharp at once, then the most distant point at which a distinct image of any of the wires is formed on the retina gives the refractive error of the meridian of minimum refraction (expressed in dioptics), and the point at which the line at right angles to this is best defined gives that of the meridian of maximum refraction. The least of these gives the spherical element of the correcting lens required for distant objects, and the difference between the two gives that of the cylindrical part. The meridian of maximum refraction is that in which the line is visible when the wires are at the greatest distance.

In the second plan the lamp, *l*, condensing lens, *c*, and wire screen, *w*, are similar, and only differ in size, the front lens, *y*, and mirror, *m*, are also similar, but the lamp and wires are permanently fixed by a tube, so that the wires are accurately in

the principal focus of the front lens,  $y$ . By this means the rays from the wires (or rather from the interval between them), after refraction through the lens and reflection by the mirror, are parallel. If received by an eye which is emmetropic, and with its accommodation relaxed, an image of the wires is formed on the retina. The light radiating from the image passes out through the optical system of the eye; is rendered parallel and able to form an accurate image on the retina of an emmetropic eye observing through the hole in the mirror.

If the observed eye be not emmetropic, it is only necessary to introduce lenses of different powers close in front of it, so as to correct the rays both entering and leaving the eye. If the refraction be the same in all meridians, the image of all the

wires is sharp with the same lens, and this lens is the one required to correct the ametropia. If any astigmatism exists, different lenses are required for rendering the images of the different wires sharp.

The strongest and weakest of these are the measures of the errors of refraction of the two principal meridians, and the difference of their numbers of dioptics gives the cylindrical element of the correcting glass required.

In this form of apparatus a disc of correcting lenses behind the mirror is not required, as the single correcting lens near the observed eye corrects the rays both entering and leaving the eye.

For rapidly finding the proper lens a disk of lenses is used,

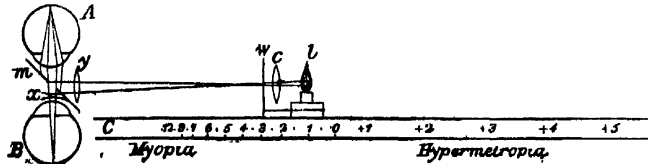

each a centimetre in diameter, and with intervals of one dioptic; a smaller disc is attached containing the quarter dioptics, so that by their combination intervals of one quarter of a dioptic can be read—a degree of accuracy greater than the estimation is generally susceptible of.

The proper lens being calculated, its spherical and cylindrical elements are combined and put together before the eye. It is the correct one, all the lines are seen sharp at the same time; if not, further examination is made.

The principal advantage of the first plan is that the adjustment, being made by the motion of the wire screen, is continuous, and correcting lenses are not required for measuring the refraction, but only for rendering the retinal image visible; its disadvantage that, as the rays are not parallel as they pass from the front lens, past the mirror to the eye, it is necessary for the apparatus to be very near, and at a determinate distance from the observed eye, otherwise the readings of the scale are vitiated. This, however, is not a serious objection.

In the second plan the rays in the corresponding position are parallel, and the instrument can be held at any convenient distance, say one or two feet from the observed eye, and the observer can get a view of the cornea at the same time as he views the image, so that he can estimate the refraction at different points of the cornea.

It is hoped that this may eventually lead to the determination of the refraction at different parts of conical cornea and other eyes with irregular astigmatism, and the application of suitable lenses to them.

Since writing the above, I find mention of an instrument by Coccus Stimmel, with an optical arrangement on the same plan as my second, but I have not heard of its being in use in this country.

The makers are T. Cook and Sons, York.

SECTION D.—BIOLOGY

After Dr. Sclater had read report of Socotra Committee, Dr. J. B. Balfour gave a very interesting account of his visit to the island. The zoological and botanical collections have not yet been examined by specialists, but are expected to yield results of great interest. As not nearly sufficient time had been allowed for a complete exploration of the island, which is almost entirely unknown to Europeans, Dr. Balfour hoped that another similar expedition would be organised; but in that case it should be earlier in the season than the last, which was in the island during February and the early part of March. During the latter part of the time the heat was too great for it to be possible to do anything in the middle of the day. Dr. Sclater mentioned that the ornithological collection indicated distinct African affinities.

*Further Remarks on the Mollusca of the Mediterranean*, by J. Gwyn Jeffreys, LL.D., F.R.S.—This is a supplement to a paper by the author, which was published in the Report of the Association for 1878. Since that time many of the species which were supposed to be exclusively Mediterranean have been discovered in the North Atlantic. The number of such Mediterranean species, which were given in the former paper, was 222.

In the present paper 41 of those species are enumerated; as also Atlantic, thus reducing the number of exclusively Mediterranean species to 181, and it was remarked that the Atlantic nudibranchs and Cephalopods had not been completely worked out, these amounting to 58, and being included in the above residue of 181.

*On the Migration of Birds, and Messrs. Brown and Cordeaux's Method of obtaining Systematic Observations of the same at Lighthouses and Lightships*, by Prof. Newton, M.A., F.R.S. (Abstract).—Citing a passage from an article by the Duke of Argyll (*Contemp. Rev.*, July, 1880, p. 1), the author met with a direct denial the Duke's assertion that of "the army of the birds" it might be said that "it cometh not with observation," pointing out that all we know of [the migration of birds arises from observation, and all we do not know from the want of it, remarking also that if it were not for observation we should not know that birds migrate at all, and inquiring whether it is not by renewed observation alone that we can hope to know more of their migratory movements. The author then proceeded to describe briefly the nocturnal passage of migratory birds as noticed by himself at Cambridge for the past seventeen years, and urged the importance of similar, but more systematic observations being made at other stations. Remarking upon the especial advantages of lighthouses and lightships for this purpose, he recounted the successful attempt made in the autumn of 1879, with the sanction of the Trinity House authorities and the Commissioners of Northern Lights, by Mr. Harvie Brown and Mr. Cordeaux, to obtain a series of observations from the lighthouses and lightships on the coast of Scotland and the east coast of England, the results of which were embodied in a Report (noticed in NATURE, vol. xxii. p. 25), and showed that returns were obtained from nearly two-thirds of the English stations, and as regards the Scottish stations, from about two-thirds on the west and one-half on the east coast, thus proving the intelligent interest taken by the men employed in the inquiry. This single Report naturally did not throw any new light on the subject, but it would be contrary to all experience if a series of such reports would not, and he therefore strongly urged the Association to countenance the renewed attempts which Messrs. Brown and Cordeaux were making, and to encourage with its approval them and their fellow-workers, the men of the lighthouses and lightships, who could best answer the question whether knowledge of "the army of the birds" and its movements "cometh not with observation."

*On Anthropological Colour-Phenomena in Belgium and elsewhere*, by J. Beddoe, M.D., F.R.S.—In Germany, Switzerland, and Belgium, through Governmental assistance, the colours of the eyes and hair of all the children in the primary schools have been observed and tabulated. The writer is very desirous that our own officials should lend similar assistance to the Anthropometric Committee of this Association. The results hitherto obtained have been of considerable importance, and those for Belgium are well shown in the monograph and maps of Prof. Vanderkindere. These bring out a remarkable contrast between the Flemish and the Walloon provinces of Belgium, and tend strongly to prove the persistently hereditary character of even such physical characters as the colour of the hair and the iris.

*Pocket Registrar for Anthropological Purposes*, by Francis Galton, M.A., F.R.S.—The author exhibited a small instrument a quarter of an inch thick, four inches long and one and three quarters wide, furnished with five stops, each communicating by a ratchet with a separate index arm that moves round its own dial-plate. The registrar may be grasped and held unseen in either hand with a separate finger over each stop. When any finger is pressed on the stop below it, the corresponding index arm moves forward one step. Guides are placed between the stops to insure the fingers occupying their proper positions when the instrument is seized and used in the pocket, or when it is slipped inside a loose glove or other cover. It is possible by its means to take anthropological statistics of any kind among crowds of people without exciting observation, which it is otherwise exceedingly difficult to do. The statistics may be grouped under any number of headings not exceeding five. If it should ever be thought worth while to use a registrar in each hand, ten headings could be employed. The instrument that was exhibited worked well, but it was the first of its kind, and might be improved. It was made by Mr. Hawkesley, surgical instrument maker, 300, Oxford Street, London. The author also drew attention to the ease with which registers may be kept by pricking holes in paper in different compartments with a fine needle. A great many holes may be pricked at haphazard close together, without their running into one another or otherwise making it difficult to count them afterwards. The mark is indelible, and any scrap of paper suffices. The needle ought to project a very short way out of its wooden holder, just enough to perforate the paper, but not more. It can then be freely used without pricking the fingers. This method, however, requires two hands, and its use excites nearly as much observation as that of a pencil.

Dr. Phené, F.S.A., F.R.G.S., read a paper *On the Retention of Ancient and Prehistoric Customs in the Pyrenees*. He said he could now repeat more confidently the peculiar features which indicate beyond question that the customs of the Gallic population of the South of France agreed, so far as they might judge from their lithic monuments, with those who came farther north and settled in Britain. On the crests and sides of the mountains on both sides of the Pyrenees, *i.e.* in Spain and France, are found sepulchral arrangements of stones somewhat different to any distinctly recorded amongst our antiquities. These consist of a number of circles adjoining each other; in the centre of each is a cist with an urn, having burnt bones, and the form of the circle is that of a wavy or serpentine cross. The quaint old customs of early Celtic life are kept up all along the Pyrenees, but not in the towns, in the plains, or champagne country. One of these, which he described last year as still existing in Brittany, that of a wooden tally, in lieu of a bill or account, on which the baker marked by notches the number of loaves he supplied, and which attracted the attention of the President of the section last year, was also existent in the Pyrenees. He purchased a baker's bill at Perpignan a few months ago, and though not so rustic as that of Brittany, it approached more to our old Exchequer tally, and to the Welsh stick of writing described in "Bardas," as well as to some elaborate and really wonderful calendars, still to be seen in the Cheetham Museum at Manchester, than to the rustic tally of Brittany. On crossing into Spain and prosecuting inquiries, he found the serpent or dragon emblem everywhere prominent, and even learned that the Tarasque, the ceremony of which is performed at Tarascon, in Provence, was a well-known dragon with the Spanish people. He was told that, though used as a popular diversion at *fêtes*, it had always a religious meaning. At Luchon living serpents are consumed in the flames. The youths of the village had miniature cloven pines which they burn. These they brandish while flaming, in serpentine curves, and cry loudly, "hilla-hilla"—pronounced "alla." But the Basque I often stands for *v*, and if we used it here, we had the old classic cry of the Bacchanals, who with serpents in their hands rushed about wildly crying "Eva, eva." The place where these cries are mostly practised has most remarkable sculptures of serpents. After the burning of the pine a rush is made by the more powerful, and the burning embers carried off in their hands regardless of pain. Pieces are then distributed to every household, and kept religiously during the year, as was the custom with the ancient Britons.

Mr. Thomas Plunkett contributed a paper *On an Ancient Settlement found about Twenty-one Feet beneath the Surface of the Past in the Coal Bog near Bohos, County Fermanagh*.—

This interesting discovery consisted of the remains of two log huts found in a primitive crannage. Flint implements, hand-made pottery, and other objects, but no metal of any kind, were found in connection with the huts, which, the author was of opinion, were formed before the age of bog pine, as no pine occurred below the level of the site on which the huts stood. The fact that twenty-one feet of dark, compact peat had grown since the structures were formed was substantial evidence of their great antiquity.

Prof. Dawkins remarked that this discovery did not stand alone, but in connection with others showed that in various parts of Ireland we might look for log houses in this way, pointing back to a series of ancient wooden houses which belonged to the Neolithic people.

Prof. Rolleston read papers *On the Structure of Round and Long Barrows*, his remarks being illustrated by a number of diagrams. Premising that one of his objects was to preserve barrows from being spoilt, and thus to prevent the destruction of certain links in the history of our species, he described the construction of barrows which he had explored, and urged the absolute necessity of very great care being exercised in such exploration. Speaking of urn burials in round barrows, the Professor briefly referred to the question of the cremation of bodies, and the idea of it. Why did the people burn their dead? He believed the idea was this—that all savage races, when they had to deal with an enemy, were exceedingly prone to wreak certain ignominies on dead bodies. Burning the bodies put it right out of the power of the enemy to do this, and the urn enabled people to carry away their friends who were so burnt. In time of pestilence it became actually necessary for sanitary considerations to burn the dead, and it was only in time of plague or war that we found that cremation or burning became the order of the day, and that was readily explicable by the fact that men always did what they could on the principle of least action, because burning was a troublesome process. Any universality of burning was explained by the fact that ancient history was simply one great catalogue of plague and pestilence and war and the like. Of course he was an enemy to cremation, because it did a great deal of harm, preventing us from knowing what sort of people our predecessors were. Prof. Rolleston chronicled the finding in a barrow of the Bronze period of a man laid out at full length, the general rule being that of burial in a contracted position. As regarded the date to be assigned to these things, he might give it as his opinion that no Roman ever used a bronze sword, nor crossed swords with an enemy using a sword of that material. As regarded the long barrows, that mode of burial stretched all the way from Wales to the Orkneys, and in them was found not a scrap of metal. His opinion was that the idea of the construction of these barrows was taken from limestone mountain headlands projecting into the sea, such as might be seen by a little trip in their immediate locality. The men lived in caves, and the idea for the place of burial was taken from the place of living, it being often found that a man made the house in which he lived his burial-place.

A short discussion having taken place on Prof. Rolleston's paper, Dr. Schaafhausen, of Bonn, exhibited the Neanderthal skull which was found in 1857, and which, he submitted, was not the skull of an idiot, but of a man of the lowest development. Prof. Rolleston agreed that the man whose skull it was was not an idiot, and said that the abnormal development in connection with it consisted in the frontal ridges.

A paper by Miss A. W. Buckland *On Surgery and Superstition in Neolithic Times* was read. Miss Buckland said it had been proved by the late Dr. Broca that the system of trepanning prevailed in Neolithic times, and the paper was to show the extent of the practice, the superstitions associated with it, and its connection with the use of cranial amulets. The surgical operation known as trepanning consisted in making an opening in the skull (chiefly of infants) in order to cure them of certain internal maladies, and the individuals who survived were considered to be endowed with properties of a mystic character. Dr. Broca stated that the custom died out with the introduction of bronze. Miss Buckland said the custom still existed among the South Sea Islanders, the Kabyles of Algeria, and the mountaineers of Montenegro. The other papers read in this department were: *On Bushmen Crania*, by Prof. Rolleston; *The Salting Mounds of Essex*, by Mr. H. Stopes; *The Hittites*, by Mr. W. St. C. Boswell; *Further Researches on the Prehistoric Relations of the Babylonians, Chinese, and Egyptian Characters, and Languages, and Culture*, by Mr. Hyde Clarke;

*The Mountain Lapps*, by Lieut. G. T. Temple; *Note on a Chilean Tumulus*, by Mr. J. H. Madge; and *India the Home of Gunpowder on Philological Evidence*, by Dr. Gustav Oppert.

## SECTION E.—GEOGRAPHY.

The President read some letters of a very interesting character from Mr. Joseph Thomson, received by the Royal Geographical Society's East African Expedition. The following are passages from this correspondence:—

"Karema, or Musamwira, Lake Tanganyika,  
"March 27, 1880.

"I have failed in my attempt to reach Jendwe by way of the Lukuga and Kabuire. I left Kasenga (or Mtowa) on January 19, with all the confidence of a young lion which had not yet known a reverse, and six weeks after I returned to the same place as meek as a lamb. From the very first I had great difficulties with the men, as they believed I was taking them to Nanguema, where they would be eaten up. They tried every means in their power to throw obstacles in my way and retard my movements, two of them deserting near Meketo, and the others threatening to do the same. For six days I continued my course along the Lukuga, in spite of their opposition, but I was then obliged to give in. It flows in a general west-north-west direction to that place, and then about west into the great westerly bend of the Congo, all the way through a most charming valley, with hills rising from 600 to 2,000 feet in height. Above the lake the current is extremely rapid, and quite unnavigable for boats or canoes of any description, owing to the rapids and rocks. From Makalumbi I crossed the Lukuga into Urna, and struck south-west for the town of Kiyombo, who is the chief of all the Warna on the eastern side of the Congo." "We reached Mtowa on March 10, destitute of almost everything. To my delight, however, I heard that Mr. Hore was expected every day on his way by canoe to the south end of the lake. On the 23rd we started, crossed the lake to Kungwe, and reached Karewa on the night of the 26th. As we neared the shore, we were hailed by the jolly voice of Capt. Carter, whom we found gun in hand and bursting with stories of his wonderful adventures in sport and war, keeping us fixed on our seats all night in his tent as he launched them forth. We went over to visit the Belgian international party at their temporary quarters to-day. Capt. Carter had his elephant ready to take us across the marsh. Karema is one of the most extraordinary places for a station that could be found on the lake—a wide expanse of marsh, a small village, no shelter for boats, only shallow water dotted with stumps of rock, no room to be got, and natives hostile; far from any line of trade. The party have commenced building forts and walls, digging ditches in regular military fashion. At table there sat down an Englishman, an Irishman, a Scotchman, a Frenchman, a Belgian, and a German, representing five expeditions, and you will doubtless be pleased to learn that of all these (thanks to yourself) the Scotchman, though the smallest, and having to travel through entirely new country, had been the most successful of all. After leaving Karema we had a moderately good voyage across the lake to Jendwe, at which we arrived on April 7." "Passing round the south end of Tanganyika along the shore as far as the mouth of the Kilambo, then striking about N.N.E. through Ulungu and Fipa, we reached by easy ascents the town of Kapufi, situated in lat. 8° S. and long. 32° 25' E. Best of all, however, while at this place, I had the honour to settle the problem of Lake Hikwa, or rather Likwa, and give it some shape and place in our maps. It has run itself in the hearsay accounts of successive travellers into various protoplasmic shapes, and, will-o'-the-wisp like, danced about on the map to the tunes of various geographers. I, of course, saw only a part of it, but from all I could gather it must be from sixty to seventy miles in length and fifteen to twenty in breadth. It lies two days east of Makapuli, in a deep depression of the Lambalamfipa Mountains. A large river called the Mkafa, which rises in Kawendi, and which by its tributaries drains the greater part of Khonongo and Fipa and all Mpimbwe, falls into it. I can almost say with certainty that it has no outlet, certainly not any towards the west. The Kilambo rises near Kapufi. I was surprised and pleased to find that my bearings and estimated distances, as laid down on my sketch map every two days, had actually brought me within one or two miles of Tabara as laid down by Speke and Cameron. I can hardly, however, call it anything but a curious coincidence."

The colleagues of Major Serpa Pinto in the Portuguese expedition to West Central Africa (Capt. H. Capello and Lieut. R. Ivens) were warmly received in the Geographical Section. They had thoroughly explored the elevated watersheds of Bihe. Major Serpa Pinto went on his famous journey towards Mozambique, and Messrs. Capello and Ivens struck towards the north-east, nearly reaching Congo. They descended the great tributary of the Congo till they reached more than 64° S. lat., where there is a great forest-belt inhabited by tribes of hostile and ferocious negroes. Not far from the shores of this river there dwells one of the most powerful potentates of this part of Africa, but the country is very unhealthy, and the people inferior in every respect to the Highlanders of Bihe. The President and Sir Henry Barkly and other members of the Section congratulated the Portuguese on their renewed geographical enterprise, and acknowledged in particular the indebtedness of geography to the explorers, from one of whom (Lieut. Ivens) the Section had heard an account of their travels.

Mr. Lawrence Oliphant described the results of his recent travels east of the Jordan, and particularly of his visits to labyrinthine subterranean cities. The object of his visit was described as that of selecting country for colonisation, and he reported that there was much pasture, wooded, and arable land capable of the highest degree of development.

Mr. Butler proposed a scheme for supplying pictorial aid to geographical teaching. The travels of a Jersey gentleman, Mr. W. Mesny (who was so useful to Capt. Gill in his journey across China), up the Canton River, and Mr. Carl Bock's account of his exploring expedition in Borneo for the Dutch-Indian Government, were other subjects before this Section.

Col. Tanner read some interesting *Notes on the Dara Nur, Northern Afghanistan, and its Inhabitants*. He described the inhabitants of the Dara Nur valley as differing little in appearance from the Afghans. "Their features are softer, and they are more trustworthy and less given to fanatical outbreaks than the Pathans, and though they continually fight among themselves, they have never given us trouble in Afghanistan. The forts of the Dara Nur were similar to those of the Jellalabad plain, and the interior arrangement the same. The people still retain the custom of sitting on stools, and, as a rule, are not at home when squatting on the ground. Among the Kohistanis and Kafirs stools are in general use." Then followed a description of a people residing in the upper part of this valley called the Chuganis. "They live in the highest habitable parts of the Kund range. East and west they are hedged in by the powerful race of Safis, their hereditary enemies, and peace is seldom known between them. The appearance of a Chugani is quite different from that of an Afghan or a Dar Nuri. He is shorter in stature, and has more pleasing features. The Chuganis are the only Mohammedans I know who allow to the women perfect and unconstrained freedom. Young and old, married and single, they go about as they do in Europe, without any of the false modesty of the ordinary Indian and Afghan females. The wife of my host and her daughters used to ask me every morning how I fared, and became at last quite friendly. In one other place only have I been allowed to converse without restraint with the women, and that was in a remote and wild part of the Brahti country, where mollahs are unknown and the tenets of the Prophet but imperfectly understood. The Chugani young lady takes a pride in her appearance. . . . The town of Aret is one of the most remarkable collections of houses I have ever seen. It is built on the face of a very steep slope, and the houses, of which there must be 600, are ranged in terraces one above another. From the roof of one of the lower ones I gazed with astonishment at a vast amphitheatre of carved wood, there being in sight thousands of carved verandah posts, and tens of thousands of carved panels, with which the upper storeys of the houses are constructed. These panels, which are arranged similarly to the shutters of Indian shops, are ornamented with every conceivable variety of carved patterns. The carving completely covered the woodwork of the upper storey of every house. . . . From one of the numerous native visitors I heard much about the Sanu Kafirs, with whom the Kordar Chuganis carry on much traffic. The little-known people whom the Afghans are pleased to call Kafirs are now confined to a tract bounded on the north and north-west by the Hindu-Kush, on the east by the Hinda range, and on the south and south-west by the Kund range, and by the Laghman. The tribes are very numerous, and speak many different languages. The great bulk of

the Katawas live in a country sufficiently open and level to admit of their becoming good horsemen. The Samus number some five or six hundred families, and live at the upper end of the Pech Dara. They are described as a merry people, given much to dancing, singing, music, and wine-bibbing. At their meals they sit in a circle and eat sedately, and with dignity, the silver wine goblet placed in a stand conveniently near being passed round the company from time to time. They shake hands in the English fashion. The women tie up the hair with a silver band. Long massive silver chains presented by the tribe are worn over the shoulders of warriors who have deserved well of their clan. Their religion is simple; the men invoke the aid of their gods in battle, vowing offerings if they are successful in the fight, and these offerings are stored up in the temples. The Kafirs are being continually encroached upon by the surrounding Afghans. Raids on a large scale are constantly made into their mountain valleys, partly to secure the women as slaves, and partly by fanatical Mohammedans on religious grounds."

*A Visit to the Galapagos Islands in H.M.S. "Triumph," 1880*, by Capt. Markham.—Capt. Markham gives an account of a visit he paid to the Galapagos Islands on board H.M.S. *Triumph*, in the beginning of the present year. The Admiralty chart, compiled from a rough survey made nearly half a century ago, is not very accurate, so that it was not safe for a large ironclad like the *Triumph* to extend the cruise in the numerous channels between the islands. Her visit was therefore confined to Post Office Bay in Charles Island, and the paper records the observations that were made during several inland excursions.

The Galapagos Islands, being 600 miles from any other land, have a peculiar fauna, and Capt. Markham devoted all the time at his command to the collection of birds, skins, insects, and shells. These specimens have been placed in the hands of Mr. Salvin, and it is anticipated that they will form an addition to our knowledge of the natural history of this isolated archipelago.

In our report of Mr. Weldon's paper, read before the Chemical Section of the British Association, it is stated:—"Molecular heats of formation of elements of the same group divided by the atomic volumes of the electro-negative elements give numbers either identical with, or bearing some simple relation to, each other." This should read:—"Molecular heats of formation of compounds of positive elements of the same group with the same electro-negative element, divided by the atomic volumes of the positive elements, give quotients either identical with, or bearing some simple relation to, each other. Thus:—

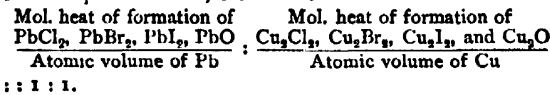

SCIENTIFIC SERIALS

*Rivista Scientifico-Industriale*, No. 13, July 15.—Water in alcoholic fermentation, by Prof. Pasqualis.—On animals which exhale an odour of musk.—New observations and note on Crookes' apparatus, by Prof. Serpieri.—On automatic geodetic instruments, by Prof. Vecchi.

*American Journal of Science*, July.—Contributions to meteorology, by E. Loomis.—Geological relations of the limestone belts of Westchester county, New York, by J. D. Dana.—Observations on Mount Etna, by S. P. Langley.—Antiquity of certain subordinate types of freshwater and land mollusca, by C. A. White.—Description of a new position micrometer, by L. Waldo.—Boltzman's method for determining the velocity of an electric current, by E. H. Hall.—Mineralogical notices, by C. U. Shepard.—Improvement in the Sprengel pump, by O. N. Rood.

SOCIETIES AND ACADEMIES

PARIS

Academy of Sciences, September 6.—M. Wurtz in the chair.—The following papers were read:—Researches on basic salts and on atakamite, by M. Berthelot.—Contributions to the history of ethers, by the same.—On the etiology of anthracoid affections, by M. Pasteur. He cites some facts in support of his theory. On a spot in a meadow where an anthracoid cow had

been buried in 1878, a small enclosure was formed, and four sheep put in it; in another enclosure, a short way off (3m. or 4m.), four other sheep. In seven days one of the former set died of the disease; none of the latter set were affected. (Germs of *charbon* had been found on the ground over the buried cow, but not a few metres off.) M. Pasteur differs from M. Toussaint's opinion that acute septicæmia is identical with chicken cholera.—M. Bouley gave some account of recent experiments of M. Toussaint, apparently showing the efficacy of preventive inoculation of sheep and rabbits against *charbon* by his method. He hopes that once preventive inoculation has become practical, it will be possible to make, not races, but generations, refractory to the disease, by inoculating the mothers during the last period of gestation.—Planet (217), discovered by M. Coggia at the Observatory of Marseilles, on August 30, 1880, by M. Stephan.—On the part taken by Claude Jouffroy in the history of the applications of steam, by M. de Lesseps. This refers to a regret expressed by the granddaughter of the inventor that M. de Lesseps had not, at the inauguration of Papin's statue, recalled the services of Jouffroy, who, in 1783, invented the pyroscaph, which steamed on the Saone sixteen months, making two leagues per hour. M. de Lesseps had thought it his rôle only to recall the inventions anterior to Papin, and those of Papin himself.—The enemies of the gallicolar phylloxera, by M. Coste.—Observations of solar protuberances, faculæ, and spots, during the first half of 1880, by P. Tacchini. The increase of solar activity is evident. The observations as to distribution agree well with those of previous quarters. The maximum of frequency of groups of faculæ is nearer the equator than that of protuberances. There are more groups of faculæ in the north than in the south hemisphere (nearly double the number); the protuberances are equally distributed in the two hemispheres. The maximum of frequency of spots and faculæ is produced in the same zones in the two hemispheres.—On the law of magneto-electric machines, by M. Joubert.—On the variations of fixed points in mercury thermometers, and on the means of taking account of them in estimation of temperatures, by M. Pernet. He confirms M. Crafts' views, and gives a formula for calculating the minima of zero, &c. He states that he can restrict to  $\frac{1}{100}$  of a degree for several hours the variations of zero in a thermometer whose zero has undergone a depression of 0°·8 C. after determination of the 100° point.—On borodecitungstic acid and its salts of sodium, by M. Klein.—Inoculation of the rabbit with glanders; destruction of the virulent activity of the matter of glanders by desiccation; transmission of glanders by inoculation with the saliva, by M. Galtier. This points to the possibility of healthy cavalry horses being contaminated by drinking from the same trough with horses in which the disease is present in a latent state. M. Larrey called attention to a disease that was once very common in the army, where soldiers ate out of a common porringer; it is an inflammatory and ulcerous affection of the mouth. The disease disappeared after the practice was given up in 1852.

CONTENTS

PAGE

THE TOOTHED BIRDS OF KANSAS . . . . .	457
THE THEORY OF DETERMINANTS . . . . .	458
LETTERS TO THE EDITOR:—	
The Stone in the Nest of the Swallow.—CHATEL . . . . .	459
A Peat Bed in the Drift of Oldham.—JAS. NIELD . . . . .	460
On the Asiatic Alliances of the Fauna of the Congenian Deposits of South-Eastern Europe.—T. R. J. . . . .	460
Protoplasma punctifrons.—M. McLACHLAN . . . . .	460
Mosquitoes.—M. A. VERDER . . . . .	461
Hardening of Steel.—T. W. GILTAY . . . . .	461
THE NEW ZEALAND INSTITUTE . . . . .	462
ALBERT J. MYER . . . . .	462
PHYSICS WITHOUT APPARATUS, V. (With Illustrations) . . . . .	462
NOTES . . . . .	464
OUR ASTRONOMICAL COLUMN:—	
Faye's Comet . . . . .	466
Schaberle's Comet (1880, April 6) . . . . .	467
Swift's New Comet . . . . .	467
The Binary Star 85 Pegasi . . . . .	467
GEOGRAPHICAL NOTES . . . . .	467
THE FRENCH DEEP-SEA EXPLORATION IN THE BAY OF BISCAY. By J. GWYN JEFFREYS, LL.D., F.R.S. . . . .	468
THE SHOWER OF AUGUST PERSEIDS, 1880. By W. F. DENNING . . . . .	470
INTERNATIONAL METEOROLOGY . . . . .	471
AGRICULTURAL CHEMISTRY. By J. H. GILBERT, Ph.D., F.R.S. . . . .	472
THE BRITISH ASSOCIATION:—	
Reports . . . . .	476
Section A—Mathematical and Physical . . . . .	476
Section D—Biology . . . . .	477
Section E—Geography . . . . .	477
SCIENTIFIC SERIALS . . . . .	480
SOCIETIES AND ACADEMIES . . . . .	480

THURSDAY, SEPTEMBER 23, 1880

## THE PHOTOPHONE

EARLY in the summer of the current year it was announced in the columns of NATURE that Prof. Graham Bell had made a discovery which, for scientific interest, would rival the telephone and phonograph, and that he had deposited in a sealed packet, in the custody of the Smithsonian Institute, the first results of his new researches; that announcement has now received its due fulfilment in the lecture by Prof. Bell to the American Association for the Advancement of Science, on Selenium and the Photophone, which will be found on another page. In spite of those who ingenuously attempted at the time of our announcement to forestall Prof. Bell and to discredit the idea that he had done anything new, the discovery, which he has now published, is a startling novelty. The problem which he has attacked is that of the transmission of speech, not by wires, electricity, or any mechanical medium, but by the agency of light. The instrument which embodies the solution of this principle he has named the Photophone. It bears the same relation to the telephone as the heliograph bears to the telegraph. You speak to a transmitting instrument, which flashes the vibrations along a beam of light to a distant station, where a receiving instrument reconverts the light into audible speech. As in the case of that exquisite instrument, the telephone, so in the case of the photophone, the means to accomplish this end are of the most ridiculous simplicity. The transmitter consists of a plane silvered mirror of thin glass or mica. Against the back of this flexible mirror the speaker's voice is directed; a powerful beam of light is caught by a lens from the sun and directed upon the mirror, so as to be reflected straight to the distant station. This beam of light is thrown by the speaker's voice into corresponding vibrations. At the distant station the beam is received by another mirror, and concentrated upon a simple disk of hard rubber fixed as a diaphragm across the end of a hearing-tube. The intermittent rays throw the disk into vibration in a way not yet explained, yet with sufficient power to produce an audible result, thus reproducing the very tones of the speaker. Other receivers may be used, in which the variation in electrical resistance of selenium under varying illumination is the essential principle. The experimental details have been worked out by Prof. Bell in conjunction with Mr. Sumner Tainter. They have discovered that other substances beside hard rubber, gold, selenium, silver, iron, paper, and notably antimony, are similarly sensitive to light. This singular production of mechanical vibrations by rays of light is even more mysterious than the production of vibrations in iron and steel by changes of magnetisation. It was indeed this latter fact which led the discoverers to suspect the analogous phenomenon of photophonic sensibility in selenium and in other substances. Hitherto, in consequence of the mere optical difficulties of managing the beam of light, the distance to which sounds have been actually transmitted by the Photophone is less than a quarter of a mile, but there is

no reason to doubt that the method can be applied to much greater distances, and that sounds can be transmitted from one station to another wherever a beam of light can be flashed; hence we may expect the slow spelling out of words in the flashing signals of the heliograph to be superseded by the more expeditious whispers of the Photophone.

We congratulate Prof. Bell most sincerely on this addition to his well-won laurels, and venture to predict for his photophone a great, if not a widely-extended, future of usefulness. SILVANUS P. THOMPSON

## THE GEOLOGY OF LONDON

*Guide to the Geology of London and the Neighbourhood. (An Explanation of the Geological Survey Map of "London and its Environs," and of the Geological Model of London, in the Museum of Practical Geology.)* By William Whitaker, B.A., F.G.S. Third Edition. (London: Longmans and Co. and Edward Stanford, 1880.)

SINCE the appearance of the second edition of this most useful little work, some valuable additions have been made to our knowledge of the rocks which underlie the London Basin. The deep borings at Turnford, near Cheshunt, and at Ware, which were executed by the New River Company in 1879, have furnished new data to geologists for determining the position and characters of that great underground ridge of palæozoic rocks, the probable existence of which was so long ago indicated by Mr. Godwin-Austen. This underground ridge of palæozoic rocks has now been reached in no less than six borings, those of Kentish Town, Harwich, Crossness, Meux's Brewery, Turnford, and Ware. In four of these cases the age of the rocks which have been found unconformably underlying the Cretaceous strata is placed beyond question, by the discovery of the well-preserved and characteristic fossils, lists of which have recently been published by Mr. Etheridge. At Harwich the cores of dark-coloured indurated shale yielded *Posidonia*, which proved that the rock belongs to the lowest part of the Carboniferous system; at Meux's Brewery and at Turnford the purple shales yielded the characteristic fossils of the Upper Devonian; while at Ware cores were brought up crowded with the well-known fossils of the Wenlock shale.

But in the case of the Kentish-Town and Crossness borings no fossils have been detected in the cores of rock brought up from the infra-cretaceous rocks, and in these cases geologists have had to fall back upon the far less satisfactory evidence afforded by their mineral characters. Under these circumstances there has arisen considerable diversity of opinion as to the age of red, mottled, and variegated strata which have been reached in these two borings. While Prof. Prestwich is inclined to refer the rocks in both cases to the Old Red Sandstone, the officers of the Geological Survey are in favour of regarding them as belonging to some part of the New Red Sandstone or Poikilitic. Mr. Whitaker has so well stated the objections to the view that the rocks at Kentish Town and Crossness are of Old-Red-Sandstone age, that we cannot do better than quote what he says upon the subject:—

"I may here remark that there is a strong reason.

against the classification of the bottom beds at Kentish Town and Crossness with the Old Red Sandstone, which seems to have escaped notice. Having the series unmistakably present in the Devonian type at Cheshunt and at Meux's, it would be strange indeed were it to occur in its wholly distinct Old Red Type at Kentish Town, between those two places, and at Crossness, not very many miles from the latter of them! I believe that no such thing is known to occur anywhere; the two types of what is generally taken to be one great geological system being limited to separate districts, and not occurring together.<sup>17</sup>

There is one other point upon which Mr. Whitaker's views as expressed in the work before us are well worthy of the attentive consideration of geologists. On p. 20 he remarks:—

"It has been said that although, from the cores brought up from some of the deep borings, we can estimate the angle of dip of the rocks, yet for calculations as to the probable extent of any of these rocks, and as to where other rocks may be expected either to come on above or to rise up from beneath them, it is needful to be able also to approximate to the *direction* of dip. I am led to think, however, that this is really of less importance than at first sight seems to be the case; for judging by what we generally see of the older rocks in districts where they are at the surface, they are much subject to disturbances and are thrown into great rolls or folds, so that whilst at one spot dipping north, near by they may turn over and dip south. We find, too, in the coal-fields of Belgium and of the north of France frequent evidence of sharp folding, and indeed of inversion of these older rocks underneath the even and almost undisturbed Cretaceous and Tertiary beds. I think therefore that were we able to find the direction of the dip of the rocks in any of our deep wells it would be unsafe to argue from that alone as to the probable succession of the beds in any direction for a considerable distance."

Mr. Whitaker's suggestions as to the direction in which it might possibly be of use to search for the Coal measures in the south-east of England are offered with a cautious reservation which is highly to be commended; it is evident, however, that he agrees with Mr. Godwin-Austen and Prof. Prestwich in the opinion that the southern suburbs of London and the line of the North Downs afford the most promising fields for future research. It is greatly to be regretted that no attempt has been made to obtain the necessary means, either from public funds or by private subscription, for carrying out this most interesting experiment.

It is not only in connection with his account of the great underground ridge of palæozoic rocks that Mr. Whitaker has been able to make valuable additions to this work. His account of the chalk and the boulder clay have been supplemented by some remarks giving the reader an idea of the latest views which have been published concerning the mode of origin of those formations. To students of Tertiary geology Mr. Whitaker's remarks on the pebble-gravel round London will prove interesting, while archaeologists will find a valuable record of the discovery of a canoe (now placed in the British Museum) in the peat cut through in the works of the Victoria-Docks Extension.

This admirable guide to the geology of London is published at the low price of one shilling, and the demand which has already produced the exhaustion of two editions ought surely to convince the authorities of the Geological Survey that it would be wise of them so to curtail the

expenses of publication in the memoirs which they issue, as to permit of their being sold at equally reasonable rates.

#### PROF. A. GRAY'S BOTANICAL TEXT-BOOK

*The Botanical Text-Book* (Sixth Edition). Part I.—*Structural Botany, or Organography on the Basis of Morphology, to which is added the Principles of Taxonomy and Phytography, and a Glossary of Botanical Terms.* By Asa Gray, LL.D., &c., Fisher Professor of Natural History (Botany) in Harvard University. (New York and Chicago: Ivison, Blakeman, Taylor, and Co., 1879. London: Macmillan and Co.)

THE near prospect of a visit from one who has for upwards of a quarter of a century held the undisputed position of the first botanist in the New World, both as a teacher and a writer, reminds us that his last and in some respects the most important of his many valuable publications, the "Botanical Text-Book," has not yet been noticed in this journal.

Prof. Asa Gray is the author of various elementary works upon the science he has so long cultivated and taught, some adapted for the old and some for the young, unequal in every respect except that of merit and admirable adaptation to their several purposes. Such are his "First Lessons in Botany," which contain just so much as is necessary to obtain such a knowledge of the botany of flowering plants as will enable a student to ascertain their names and affinities by the use of the ordinary descriptive manuals; his "How Plants Grow: a Simple Introduction to Structural Botany," which is the most lucidly written work of the kind known to us; his "Lessons in Botany and Vegetable Physiology;" his "Manual of the Botany of the Northern United States;" and, above all, his "How Plants Behave: an Introduction to a Study of the Habits and Movements of Plants, adapted for the Young," which is a marvel of good arrangement and clear expression, whilst the subject is rendered in the highest degree attractive to both old and young.

These and other elementary works on botany are, though sold by thousands in the United States, comparatively little known on this side of the Atlantic. The same cannot be said of a more comprehensive work by the same author, written for more advanced students, and as a book of reference for the working botanist, namely that which heads this article. The "Botanical Text-Book" appeared so long ago (as a first edition) as 1842, and immediately took rank as a first-class educational work in all English-speaking countries, and from that time to the present, during which the five editions which have appeared, being always brought up to date in point of matter, have been successively recognised by professors in British universities as the best introduction to botany extant in the language, and recommended by many to their pupils as the one they should use.

In all the five editions all the branches of botany have been treated of under the heads of Structure, Physiology, and System; but the twenty-three years that have elapsed since the appearance of the last edition have so greatly enlarged our knowledge of the physiology of vegetables, and of the vast assemblage of plants known as crypto-

gamic, that these subjects can no longer be treated of *pari passu* with the structural, if this latter is to be brought up to the present state of knowledge in a work of the scope and design of the author's "Text-Book." This has determined Dr. Gray to enlarge the scope of his work, to retain the authorship of one volume, which is devoted to Morphology, Taxonomy, and Phytography, re-writing these throughout, to assign another upon Vegetable Histology and Physiology to his colleague, Prof. Goodall; a third, which will be an Introduction to Cryptogamous Plants, to another colleague, Prof. Farlow; and to complete the series by a fourth, from his own pen, on the Morphology and Classification of Flowering Plants, their Distribution, Products, &c.

Thus, when complete, we shall have from the most eminent botanical professors in the New World as comprehensive an introduction to the study of the Vegetable Kingdom as the nineteenth century is likely to produce.

#### OUR BOOK SHELF

*Light and Heat; the Manifestations to our Senses of the Two Opposite Forces of Attraction and Repulsion in Nature.* By Capt. W. Sedgwick, R.E. (London: Hodgson and Son, 1880.)

THE reviewer who says what he thinks is sometimes thought unkind. The author's paradoxes require no commentary but themselves to be duly appraised by scientific readers.

"The explanation of the fact that a spot of light is seen alike when pressure is applied to the outside of the eye, and when a single ray of light passes into the eye, is that the ray of light really makes itself manifest to our sense of vision by exerting a pull upon the retina of the eye . . . it follows, of course, that light is a pulling or an attractive force, and is therefore opposed to heat, which, as is well known, is a pushing or repulsive force." (Pp. 14 and 15.)

"Light consists of a large amount of the attractive force, mixed with a small amount of the repulsive force. Heat, on the other hand, consists of a large amount of the repulsive, with a small amount of the attractive force." (P. 28.)

"We have in the growth of plants and trees a beautiful exemplification of the action of heat and light as expansive and attractive forces. The young shoots are extended by the expansive power of heat, and then the attractive power of light comes into play" . . . (P. 38.)

"It may be objected that gravity cannot be the same force as light, because, if it were, it would be greater by day than by night." (P. 42.)

"There is ample evidence all about us to testify to the fact that light is an attractive force. Indeed *we ourselves bear witness to the fact by our fondness for fireworks and illuminations*" . . . (P. 38.)

"Light being the manifestation, in the free state, to our senses of the attractive or cohesive force . . . the fact that the production of light is made the first act in the creation of the world, in the account given us in the Book of Genesis, becomes intelligible." (P. 42.)

"I ask for no other favour, and for no mercy." (P. 3.)

We believe we have sufficiently complied with the gallant captain's request. S. P. T.

*The Land and Freshwater Shells of the British Isles.* By Richard Rimmer, F.L.S. (London: David Bogue, 1880.)

THIS unpretending and well-written volume is dedicated to the artisans, with many of whom, especially in the North of England, the subject is very popular. The dedication is qualified, viz.: "To those of my country-

men among the working classes who wisely employ their leisure hours in the pursuit of useful and elevating knowledge, with the hope that others among their ranks may be induced to forsake the paths of profitless and degrading dissipation." William Edward, the Banff shoemaker, is (thanks to Mr. Smiles) a celebrated example of the more intelligent workman; and we know of others who, however, "carent vate sacro." The book is very readable; it gives an excellent account of the habits of our land and freshwater mollusks, as well as of their various habitats, and it is not burdened with any synonymy or useless aliases. It is founded on Dr. Gwyn Jeffreys' "British Conchology." But the present work has a drawback. Eight out of the eleven plates give photographs of the shells, which are produced by the "Albertype" process; and the figures, especially of the smaller species, are so blurred or smudgy as to be almost undistinguishable. Plate X. is very good, representing magnified views of the British species of *Vertigo*. There is a useful glossary.

#### LETTERS TO THE EDITOR

[The Editor does not hold himself responsible for opinions expressed by his correspondents. Neither can he undertake to return, or to correspond with the writers of, rejected manuscripts. No notice is taken of anonymous communications.]

[The Editor urgently requests correspondents to keep their letters as short as possible. The pressure on his space is so great that it is impossible otherwise to ensure the appearance even of communications containing interesting and novel facts.]

#### Novel Celestial Object

THE search for planetary nebulae, described in NATURE, vol. xxii. p. 327, was continued for several evenings without revealing any new object, although it is estimated that the spectra of about 100,000 stars were examined. On the evening of August 28 an object entered the field which presented a faint continuous spectrum with a bright band near each end. Clouds interfered and barely permitted an identification with Oeltzen 17681, or a position in 1880 of R.A. 18h. 1m. 17s., Dec. - 21° 16'.

This object might be mistaken for a temporary star like that in Corona in 1863, and the bands assumed to correspond to the hydrogen lines C and F. This view is contraverted by the permanency of the object which was observed by Argelander in 1849, and at the Washington Observatory in 1848 and 1849. In all these cases its magnitude was estimated as 8, or very nearly its present brightness. No variation of light was detected between August 28 and September 1. The star Oeltzen 17648 precedes it very nearly a minute, and is only four minutes north, so that their light can be easily compared. As they are nearly equal, a slight change would be quickly recognised.

A further examination of the spectrum showed that the less refrangible band is near D, and the other between F and G. The images of both, but particularly of the second, are much elongated by the prism, showing that they are bands, and not lines. The limits of wave-length of the first band are approximately 5,800 and 5,850; those of the second, 4,670 and 4,730. A band at 5,400 and some other fainter bands were also suspected, but their existence is not certain.

The discovery of this object greatly increases the difficulty of distinguishing between a star and a planetary nebula. If the disk is used as a test, the first object described in the paper referred to above might easily be taken for a star. If we define a nebula by its spectrum of bright lines on a faint continuous spectrum, the object now under consideration becomes a nebula. Whether it is a mass of incandescent gas resembling a nebula in character, but not in constitution, or whether it is a star with a vast atmosphere of incandescent gas of a material not as yet known to us, are questions which cannot yet be decided.

Cambridge, U.S., September 2 EDWARD C. PICKERING

#### Experiments on the States of Matter

THE exploration of the new region which I have lately opened up has led to so many results with both scientific and technical bearings that I have been unable to leave this city for some time to attend any scientific meetings, and I would beg leave, with your kind permission, to make, through the medium of your valuable columns, a few remarks on some recent scientific work.



The quite independent confirmation of my discovery of the limit of the liquid state given in a letter in NATURE, vol. xxii. p. 435, by my old colleague, Dr. Carnelley, helps to dispel the idea of an intermediate state above the critical point, and confirms me in the use of the term "gas" for all fluids above their critical temperatures in speaking of the "solubility of solids in gases." The term vapour should only be applied to an aëriiform fluid which by pressure alone can be reduced to the solid or liquid state, and above the critical temperature this cannot be done. As yet I have no evidence that vapours so defined are capable of dissolving solids, and this negative property may help to form a definition of that division of matter. As Dr. Carnelley does not mention the coincidence of our researches, perhaps you will permit me to quote from our respective papers. Dr. Carnelley says:—1. "In order to convert a gas into a liquid, the temperature must be below a certain point (termed by Andrews the critical temperature of the substance), otherwise no amount of pressure is capable of liquefying the gas."

As far back as May 24 I wrote ("On the State of Fluids at their Critical Temperatures," *Proc. Roy. Soc. No. 205, 1880*):—"The same results were obtained as before. When the temperature was below the critical point, the contents of the tube were liquid, and when over that temperature the reaction was always gaseous, notwithstanding the variations of pressure.

"I think we have in these experiments evidence that the liquid state ceases at the critical temperature, and that pressure will not materially alter the temperature at which the cohesion limit occurs." Dr. Carnelley will find the whole of my paper devoted to an experimental demonstration of what he has now deduced from his experiments. The paper was written with the title, "On the Cohesion Limit," but by the advice of Sir William Thomson, to whose great kindness in helping me with advice and information I am much indebted, I altered the title until I had the whole field explored. This I have since done, and have completely established the "cohesion limit" for all liquids—that for homogeneous liquids being an isotherm starting from the critical point. My paper being a very full one has taken much time and work, and the corrections for over a thousand experiments will take me some time yet. Prof. Stokes (whose kindly interest and encouragement have greatly lightened my labours) has been kept informed of my progress, and is cognisant of the work I have done in this direction. Dr. Carnelley's second conclusion is also very interesting, especially when applied to water; but surely we are not to understand that the solid ice was hot throughout, or that, if a thermometer had been imbedded in the ice, it would have risen. Although the vessel be red hot, the ice need never be allowed to melt, but made to pass directly into vapour, and yet its temperature remain 0° till it has been entirely volatilised.

I notice from your report of the British Association that Sir William Thomson calls attention to Cagniard de Latour's method of showing the critical state of a liquid by sealing the requisite proportion of liquid in a stout tube and heating it in a bath. It should not be forgotten that, although to Dr. Andrews undoubtedly belongs the credit of establishing the definite finish of the boiling-line and the apparent continuity of the liquid and gaseous states, to Baron Cagniard de Latour belongs the discovery of "l'état particulier" where the liquid state ends. Latour's method, although often used by Mr. Hogarth and myself, is not convenient for purposes of research. The method, your report goes on to say, was criticised by Prof. W. Ramsay, in what spirit we are not informed, but Dr. Ramsay added that he had found an apparatus in which a screw was employed to produce increase of pressure instead of using the expansion of the liquid itself. Dr. Ramsay, however, did not say whether the apparatus he had found was that invented by Mr. Hogarth and myself, and described by us in *Proc. Roy. Soc.*, No. 201, 1880, in which india-rubber in a hollow cap is made by compression to yield a perfectly tight joint and to answer also for a screw when protected by a facing of leather. Dr. Ramsay visited my laboratory, and had the apparatus taken down and fitted up before his eyes, and with my permission had an apparatus made. The use of the compressed india-rubber for obtaining the requisite close fitting constitutes the important feature of my apparatus; the employment of iron for constructing the vessel enabling experimenters to dispense with the use of two liquids as in Andrews' apparatus—mercury being used alone.

I have made some little progress with the construction of vessels to withstand pressure at high temperatures, and I expect in a few weeks (when I have prospect of leisure) to carry my

crystallisation experiments to a scientific if not commercial success.

Private Laboratory, Sword Street, Glasgow

J. B. HANNAY

### Fascination

I EXPECTED some of your readers to refute the explanation of Mr. Stebbing on "Fascination." I see in NATURE, vol. xxii. p. 383 another paragraph which is not more to the purpose. Want of presence of mind and stupefaction are not fascination. In 1859 (twenty-one years ago) I followed in the rocks of Avon, close by the park of Fontainebleau, the fairy paths of Denecourt, when the approach of a storm induced me to leave the blue arrows, indicating the right path, for a short cut. I soon lost my way, and found myself in a maze of brambles and rocks, when I was startled by seeing on my left hand, at a distance of about ten yards, a snake, whose body lifted up from the ground at a height of about a yard, was swaying to and fro. I remained motionless, hesitating whether to advance or to retreat, but soon perceived that the snake did not mind me, but kept on maintaining its swaying motion, and some plaintive shrieks attracted my attention to a greenfinch perched on a branch of a young pine overhanging the snake, with his feathers ruffled, following by a nod of his head on each side of the branch the motions of the snake. He tottered, spread his wings, alighted on a lower branch, and so on until the last branch was reached. I then flung my stick at the snake, but the point of a rock broke it and the snake disappeared with the rapidity of an arrow. On approaching the spot, a real abode of vipers, which I did with the greatest precaution, knowing by observation that death may be the result of the bite of a viper, I saw the greenfinch on the ground agitated by convulsive and spasmodic motion, opening and shutting his eyes. I put him in my bosom to try the effect of heat, and hastened to reach the park of Fontainebleau. The little claws of the bird opening and shutting, perhaps as an effect of heat, made me think that he might perhaps be able to stand on my finger, and he did clutch it, and held on with spasmodic squeezes. In the park I got some water, and made him drink it. In short, he revived and finally flew off in the lime-trees of the park.

Now whilst following the motions of the snake and bird I experienced a singular sensation. I felt giddy; a squeezing like an iron hoop pressed in my temples, and the ground seemed to me to be heaving up and down. In fact the sensation was quite analogous to that experienced on a beginning of sea-sickness.

From these facts would it not seem probable that fascination is nothing more nor less than an extreme fatigue of the optic nerve, produced by a rapid gyratory motion of a shining object and resulting in a nervous attack and a coma? Curiosity rivets at first the attention of the bird, unconscious of any danger, and when giddiness warns him of his peril it is too late. The snake is as well aware of this as the *Lophius piscatorius* is of the effect of his membrane.

In this system the fact of the bird coming down from a higher to a lower branch would be explained by the supposition that, giddiness overtaking him, he opened instinctively his wings and clung to the next support that he found, the motion having partially removed the giddiness so as to enable him to hold fast.

Observe, that nothing hindered the bird from flying away, and that the snake being at most five feet long, could never have reached even the lowest branch.

Besides he could have no nest to protect, for in the rocks of Avon there is no water save rain-water in the hollows of the rocks, and this is not potable on account of microscopic leeches which people it, the instinct of birds teaching them to avoid it.

Jersey, August 29

CHATEL

P.S.—I inquired of Mr. Denecourt, "the sylvan of the forest," if he were aware of the existence of such large snakes in the forest, and he told me that he had only seen, in the "rocher Cuvier Chatillon," a snake about four and a half feet long, which he killed, but that even larger snakes had been seen in this very "rocher d'Avon" and in the "rocher St. Germain," but he thought that they were only "couleuvres" of a large size and quite inoffensive.

### Meteor

ON the 19th inst., at 11.34 p.m. (within a minute of G.M.T.), I observed a large meteor in the east, towards which I happened to be looking, the sky being quite free from clouds, and clear.

When first seen it was half way between Capella and  $\alpha$  Persei; it passed in a slightly curved direction, which was concave towards Auriga, downwards to a line joining  $\beta$  and  $\alpha$  Tauri, disappearing at a point one-third of the distance from  $\beta$  towards  $\alpha$ . It was very much brighter than Jupiter, and quite half the diameter of the moon; I made these comparisons immediately after it had passed.

Its passage occupied about eleven and a half seconds, and it left a bright continuous yellow streak in its wake, which did not fade until about two or three seconds after the meteor had disappeared; this enabled me the more readily to fix its position. The whole of its path was not seen, as it emerged from behind a tree with thick foliage, though its light attracted my attention before the meteor appeared.

It was pear-shaped, and its brightness appeared to slightly increase; its colour was a very bright reddish yellow changing to deep purple at its disappearance; it was not followed by any noise. The latitude of place of observation is N.  $51^{\circ} 28' 20''$ , the longitude W.  $0^{\circ} 20' 17''$ .

C. THWAITES

Isleworth, September 21

### EVOLUTION AND FEMALE EDUCATION

ONE of the most remarkable features of the advance of science is perhaps the increasing facility afforded for bringing under the grasp of *physical* treatment questions formerly thought to be within the range of abstract reasoning alone. These two methods, if correct, will of course run parallel to each other, and at the same time tend reciprocally to confirm their truth:—the *physical* method being often the more easily followed, and therefore perhaps considered on that account the more certain of the two. Many instances may no doubt readily present themselves of conclusions formerly reasoned out on abstract grounds (more especially by the ancient philosophers), and subsequently confirmed by physical reasoning. As a modern example of this *double* treatment of the same subject we might mention the very important question of the higher mental training of women, dealt with by the late John Stuart Mill on substantially abstract grounds, and touched on by the theory of evolution on physical grounds. As we propose solely to notice the *physical* side of the question here, perhaps this brief essay may not be thought unsuited to the columns of NATURE. We do not expect to bring forward anything especially new, but we may perhaps exhibit the case in some novel aspects; at the same time we may avoid elements of uncertainty by carefully separating the facts supported by scientific evidence from the question of the desirability or undesirability of the measures to be taken upon these facts as a basis, and thus the paper may hope to attain that degree of reliability or solidity which is usually looked for in a journal of natural science.

Perhaps the most valuable characteristic of the doctrine of evolution (or the history of the past rise of man) is the lesson it gives for future progress. It will be apparent that an inquiry into the conditions affecting the progress of mankind would want one of its primary elements if the conditions bearing on the advancement of woman (as one half the race) were excluded therefrom; and the fact of this point being popularly underrated may be considered as rather in favour of its value and significance than not, inasmuch as all great reforms consist in the conquest of popular prejudice. That the value attached to this reform by Mill, which occupied a great part of his life, was not overestimated by him will, we think, become all the more evident when the subject is brought under the test of the theory of evolution.

Mr. Darwin in his work, "The Descent of Man" (second edition), remarks:—"It is indeed fortunate that the law of the equal transmission of characters to both sexes prevails with mammals, otherwise it is probable that man would have become as superior in mental endowment to woman as the peacock is in ornamental plumage to the peahen" (p. 565).

This therefore puts the question of the education of woman in a somewhat new light: though in a light probably suspected by some (including, it may be said, the writer) beforehand, on abstract grounds. For this would show, on a reliable physical basis, that one of the chief arguments for the intellectual training of woman must be for the direct benefit of *man*. For the above deduction, grounded on the evidence of natural science, would indicate clearly that man, by opposing the intellectual advance of woman for countless generations, has enormously injured his own advance—by inheritance. In other words, while man has been arbitrarily placing restrictions in the way of the mental progress of woman, nature has stepped in, and by the laws of inheritance has (to a large extent) corrected, at his expense, the injury which would otherwise have been inflicted, and which, without this interposition of natural law, would have made itself transparently obvious, centuries ago. Man, by hindering woman from performing her natural share in the work of brain development, has been compelled by nature to do the work for her, and valuable brain tissue (accumulated by mental discipline), which would have been man's own property as the fair reward of intellectual labour, has gone over by the rigorous laws of inheritance<sup>1</sup> to the female side, to fill up the gap artificially created by man through his persistent hindrance of woman from doing her part in the progressive development of the brain. The probable extent of the gap by accumulation (from all causes, including the very important factor of man's obstruction) is apparently roughly indicated by the comparison employed in the above quotation. It would seem, therefore, that it could scarcely be said to be altogether fortunate (in *one* sense at least) that "the law of equal transmission of characters to both sexes prevails with mammals;" for this fact has served to conceal an evil which in reality exists in all its magnitude, and which otherwise it would not have required the intellect of a Mill to detect, but which must have become glaringly apparent long ago. Physical science would therefore appear to show a remarkable confirmation of Mill's magnificent theoretic analysis, and of the reality of those evils, the clear exposure of which by him looked to some like exaggeration. In fact it would result from the scientific evidence that however monstrously women might have been treated, however much idleness might have been enforced, or healthy brain exercise prevented, nature would have infallibly corrected the irregularity *at the expense of man*, entailing of course the partial extinction of the progress of the race (as a whole). Possibly the not uncommon popular ridicule which (at first, at least) accompanied Mill's protests, the conceited independence of some men in ignoring the fact that they are descended from women, and their failure even now to realise so obvious a truth as the desirability of clearing away all obstacles to the intellectual advance of woman (by facilitating education, by removing the bars to healthy exercise of the brain in suitable professions, &c., in place of idleness) may itself be in part a consequence of the deficiency of brain tissue caused by the drain through inheritance which goes to counteract their efforts of obstruction. Some of the reasons urged against the higher mental training of woman are of so superficial a character as themselves to show the extensive magnitude of the evil. One notoriously not uncommon ground adduced

<sup>1</sup> Possibly (and we believe this may have been suggested by others) the less stability, or sometimes almost hysterical character of the female intellect may be naturally due to the brain qualities being gained mainly by inheritance instead of by hard practice, as in the case of man's brain attributes. While the faculties of man have acquired the steadiness produced by centuries of healthy intellectual discipline and exercise, the field for this has been closed to woman to a large extent. In fact the scientific evidence would appear to show that the common brain (*i.e.* the brain common to the race) has been built up mainly by man's efforts, while woman has to a great extent inherited her share at his expense, though no doubt if left entirely unfettered she would have largely contributed to the common good; and it may be inferred with tolerable safety that the race would then have been elevated far above its present status.

is that women already are, as a rule, somewhat inferior in mental power to men, forgetting that they were precisely made inferior by the obstacles thrown for centuries in the way of their advance (some of these specially fixed by legal enactment), and which are sometimes of such a kind as almost to amount to a tax on liberty. It may well be conceivable that the law of inheritance, though it has achieved a vast amount, may not have been able to combat these artificial conditions for producing inferiority with entire success. The above plea of existing inferiority in mental power, therefore, so far from being an argument against female education, ought, when justly viewed, to be regarded as the strongest reason the other way. For if obstruction has produced—in spite of the powerful countervailing influence of the law of inheritance—a certain degree of inferiority: so (conversely) by equally reliable casual sequence encouragement would produce an effect in the opposite direction. Moreover, precisely on account of the fact that woman is already somewhat handicapped by nature in the race of progress, would there be all the more reason why every encouragement should be given; *a fortiori*, all artificial hindrances in the way of advancement removed. It would be a great mistake if the idea were for one moment entertained that progress can be accomplished by letting matters generally drift under the influence of prevailing custom. If there is one thing more certain than another it is that man can never hope to progress with satisfactory rapidity without having a sharp eye to the conditions necessary for this object, and examining (by the light of reason and knowledge gradually acquired) all his customs, to see if they are desirable or not. To facilitate this end the history of past progress, unfolded in the theory of evolution, may afford some valuable instruction. The increasing appreciation of the value of co-operating with the weak, instead of domineering over them, may be perhaps regarded as one of the most pleasing accompaniments to the advance of science.

S. TOLVER PRESTON

THE YANG-TSE, THE YELLOW RIVER, AND THE PEI-HO<sup>1</sup>

THESE three rivers form conjointly the great river-system of China. Although at the present day each of them runs its separate course to the sea, there is good reason to believe that several centuries since they were united by a number of connecting branches in a manner somewhat resembling the junction of the Ganges and the Brahmapootra in our own time. Such is the inference to be drawn from an ancient Chinese map copied by Alvarez Sernedo, a Portuguese Jesuit, and which must be assigned to a time preceding that of the construction of the Grand Canal by Ghenghis Khan in the beginning of the thirteenth century.<sup>2</sup> Linked together as these rivers were in the past, a brief consideration of their present condition will prove that they are labouring towards the same end in our own day. But before proceeding to examine them in their conjoint character, it will be necessary to consider briefly their leading hydrological features.

1. *The Yang-tse*—the largest and most important of these three rivers—has a course of about 3,000 miles, and drains an area which is variously estimated between 750,000 and 550,000 square miles: for my own calculations I will adopt the mean of these two estimates, namely,

<sup>1</sup> The author, Surgeon H. B. Guppy, of H.M.S. *Hornet*, writing from Yokohama, February 11, says:—"I forward to you by this mail a paper containing the results of observations I have made during the last two years on the subject of the Yang-tse and the Pei-ho, together with similar information as regards the Yellow River. Looking on these three rivers as in reality one river-system, I have embodied in one paper all the 'data' concerning them; and have treated them both separately and in their conjoint character. I can answer for the accuracy of the various estimations, and have employed the usual methods in obtaining them."

<sup>2</sup> I cite a paper by Mr. S. Mossman on the "Double Delta of the Yellow River," published in the *Geographical Magazine* for April, 1878.

650,000 square miles. Its waters, commencing to rise in February and March, reach their highest level in the month of June or July; and here they remain with occasional fluctuations till the end of August or the beginning of September, finally reaching their lowest level towards the close of January.

With regard to the *discharge of water* of this river, Capt. Blakiston<sup>1</sup> has estimated the average amount carried past T-chang, which is situated at about 960 miles from the sea, at 500,000 cubic feet per second; he founded this estimate on observations made during the months of April and June. When stationed at Hankow in the winter 1877-78, a place distant about 600 miles from the sea, I set to work to make a similar estimate of the water carried past that city for the twelve months included between May 1877 and May 1878. Having taken a line of soundings across the river and having ascertained the river's breadth (1,450 yards, by sextant measurement) at a point below the union of the Han with the main stream, I commenced a series of observations on the rise and fall of the river water and on the force of the current, which, combined with information received from the Custom-house and from other sources, supplied me with the necessary data for my calculation. The results are contained in the following table:—

1877.		Surface current.	Average depth.	Water-discharge.
		Knots per hour.	Fect.	Cubic feet per second.
May	31	2½	64	846,336
June	30	2½	61	896,293
July	31	3	58	1,022,656
August	31	3½	62	1,275,381
September	30	2½	63	1,018,248
October	31	2	53	622,997
November	30	1½	42	308,560
December	31	1	36	211,584
1878.				
January	31	½	30	141,085
February	28	1½	39	412,626
March	31	1½	45	396,720
April	30	2	57	670,016
				12)7,822,502
				651,875

We may therefore place the average water-discharge for the year at Hankow at 650,000 cubic feet per second. Now, estimating the area of drainage above Hankow to be about ½ of the whole area, and assuming that the portion of the Yang-tse valley below Hankow drains off its waters at the same rate as the remainder of the river-basin, it follows that the average water-discharge for the whole river may be placed at 770,000 cubic feet per second.

With reference to the amount of *sediment* carried by the Yang-tse past the same city, I found as much as seven grains in the pint (nearly one drachm in the gallon) in the month of July, when the river was at its height; while in March, when the river was low, I found as little as three-fifths of a grain per pint. The average proportion of sediment during the twelve months in question I estimate at *four grains in the pint* (a little over half a drachm per gallon). This represents a proportion of 2/156 by "weight," or (taking the specific gravity of the dried mud at 1.9) of 1/157 by "bulk" of the average discharge of water. It is thus easy to obtain the total amount of sediment carried during the twelve months past Hankow, namely, 4,945,280,250 cubic feet: but to allow for the amount of mud a river pushes along its bed, one-tenth must be added according to the principle laid down by Messrs. Humphreys and Abbot in the case of the Mississippi. This will bring the *total annual discharge of sediment* at Hankow up to 5,439,808,275 cubic feet, or at the rate of 172 cubic feet per second. Now, assuming that the drainage area below Hankow sup-

<sup>1</sup> "Five Months on the Yang-tse."

plies the same relative amount of sediment as the remainder of the catchment basin, I estimate the total amount carried down to the sea annually at 6,428,358,255 cubic feet.

The removal of this amount of sediment from an area of drainage of 650,000 square miles represents a lowering of the surface at the rate of *one foot* (of rock) in 3,707 years. This is therefore the rate of "subaerial denudation" of the valley of the Yang-tse as far as concerns the quantity of sediment removed. Of the proportion of solids in solution, I have had no opportunity of judging, but that the soluble matter is in considerable quantity is rendered probable from the extensive limestone districts traversed by this river.

2. *The Yellow River or the Hoang-ho* has derived the appellation of "China's Sorrow" from its frequent destructive inundations. It runs a course of about 2,500 miles; but, unlike the Yang-tse, its lower course has frequently shifted in the course of ages, and although it opens at the present day into the Gulf of Pe-chili, only a quarter of a century has passed since it emptied its waters into the Yellow Sea.<sup>1</sup> The mountainous district of the province of Shantung has in truth been the chief means in deflecting the waters of this great river on more than one occasion during the historical era from the Gulf of Pe-chili to the Yellow Sea, and *vice versa*.

With reference to the quantity of water discharged by the Hoang-ho I have had no opportunity of personal observation. We have, however, an estimate not only of the water-discharge, but also of the sediment, which Sir George Staunton supplies us in his account of Lord Macartney's embassy to China in 1792. It was calculated that at the place where the British embassy crossed the Yellow River—its junction with the Grand Canal—the water was carried past at the rate of 418,176,000 cubic feet per hour, or 116,000 cubic feet per second. The method employed in ascertaining the quantity of sediment was the measurement of the amount of mud deposited from a gallon and three-quarters of water when allowed to stand. From this experiment it was concluded that the sediment was in the proportion of  $\frac{1}{300}$  of the original bulk of the water, and the annual discharge of sediment was assessed at 17,520,000,000 cubic feet.

However carefully these observations may have been made, and however near they may approach the actual discharge of water and of sediment at the time in question, it seems to me that one is hardly justified in accepting the result of a single observation as typical of the average state of things throughout the year; and yet Sir George Staunton's estimate has never, as far as I am aware of, been questioned. A single glance at the foregoing table will convince one of the little dependence that can be placed on a solitary estimation; it will be there seen that the Yang-tse discharged nine times as much water when at its highest level in August as it did during the month of January, when its waters occupied their lowest level.<sup>2</sup> Or if the question of sediment is considered, to which the same objection would apply, I have the greatest diffidence in accepting Sir George Staunton's estimate as being of any value except as a trustworthy result of a single experiment; and yet, even considered as the maximum of the whole year, the result is a rather startling one. While the greatest amount of sediment I found in the water of the Yang-tse was seven grains in the pint, and in the case of the Pei-ho—as will subsequently be noticed—fifteen grains in the pint, Sir George Staunton estimates the sediment of the Yellow River at over eighty grains in the same measure of water. Even the muddy waters of the Ganges do not contain more than twenty grains of sediment in the pint of water.

It is therefore not with any surprise that I find the "subaerial denudation" of the Hoang-ho is estimated<sup>3</sup> at

<sup>1</sup> Vide Mr. Morsman's paper, already referred to.

<sup>2</sup> In the case of the Ganges at Ghazpoor the proportion is as 1 to 14.

<sup>3</sup> Vide NATURE, vol. xviii. p. 268.

less than half that of the Yang-tse, namely, *one foot in 1,464 years*. This estimate only refers to the amount of sediment removed, and yet I cannot but consider it as very liable to correction by some future observer. As this is the only calculation that has ever been made, as far as I am aware, with reference to the quantities of sediment and of water discharged by the Yellow River, I am perforce obliged to accept it *pro tanto*.

3. *The Pei-ho* drains the great plain which constitutes the province of Pe-chili. Its length is said to be about 300 miles, but the lower part of its course below the city of Tientsin is so tortuous that a distance of thirty miles overland is converted into fifty by the river. It is at Tientsin that the Pei-ho proper and the Yu-ho unite together to form the main stream: the latter is generally known by Europeans as the Grand Canal, but as a matter of fact the canal joins the Yu-ho about 150 miles to the southward. During the three winter months—December, January, and February—the Pei-ho is usually frozen over, the ice having a thickness of about eighteen inches; in the same season there is generally a large quantity of ice in the Gulf of Pe-chili, which may completely fill up the head of the gulf.

With reference to the water-discharge of this river, I was enabled while wintering at Tientsin during the season 1878-79, to collect some "data" for its estimation during the four months from December to March. Although my estimate strictly applies to but a third of the year, still from the limited rise and fall of the water during the different seasons (it never exceeds six feet) I feel pretty confident that it fairly represents the average rate of discharge during the whole year. The breadth of the river at the place of observation below the city of Tientsin was 280 feet. The following table contains the results of my calculations:—

1878.	Surface current.	Average depth.	Water-discharge.
	Knots per hour.	Feet.	Cubic feet per second.
December ... ..	1½ ... ..	14 ... ..	6,355
1879.			
January ... ..	½ ... ..	14½ ... ..	4,389
February ... ..	1½ ... ..	16 ... ..	9,684
March ... ..	2 ... ..	14 ... ..	10,592
			4)31,020
			7,755

We may thus place the average discharge of water for the whole year at about 7,700 cubic feet per second.

Now with regard to the amount of sediment carried past the city of Tientsin: I found the average quantity during the four months in question to be about *five grains per pint*. (It varied much at different times, for I found as much as fifteen grains in the middle of March, while in the months of January and February it did not equal a grain in the pint.) This represents a proportion of  $\frac{1}{17,700}$  by "weight," or  $\frac{1}{333,333}$  by "bulk" of the average discharge of water: and following the same method of calculation as was employed in the case of the Yang-tse, I estimate the annual discharge of sediment for this river at 80,000,000 cubic feet.

Now the removal of this bulk of material from an area of drainage, which I estimate at 55,000 square miles, represents a lowering of the surface of *one foot in 25,218 years*. This is the rate of "subaerial denudation" of the Pei-ho basin, omitting of course the question of the solids in solution.

To show the rank that these three rivers hold in the fluvial system of the globe, I have subjoined a list of fourteen other rivers, which gives the quantities of water and sediment discharged by each, as well as the rate of subaerial denudation, as far as I have been able to ascertain.

	Water discharged per second.	Sediment per annum.	Subaërial denudation.
	Cubic feet. <sup>1</sup>		
Amazon ... ..	2,458,026		
Congo ... ..	1,800,000 (By Behm and Capt. Tuckey)		
Yang-tse ..	770,377 (By myself)	6,428,800,000 (By myself)	1 foot in 3,707 years. (By myself)
Plate	700,000 (By Mr. Higgin and Mr. Bateman)	3,500,000 (r. Higgin)	1 foot in 29,400 years. (Calculated from Mr. Higgin's estimate)
Mississippi	618,000 (By Messrs. Humphreys and Abbot)	7,474,000,000 (By Messrs. Hu...	1 foot in 6,000 years. (By Mr. Croll)
Danube ...		1,255,500,000 (By Mr. Ch. Hartley)	1 foot in 6,846 years.
Shat-el-Arab		6,363,000,000 (By the Rev. Mr. Everest)	1 foot in 2,358 years.
Indus ...	Everest)		
Atrato ...	199,476		
Nile ...			
Yellow River	110,000 (By Sir George Staunton)	11,200,000,000 (By Sir George Staunton)	1 foot in 1,464 years. 594c
Rhin-	69,741		
Po	61,263	405,420,000 (By M. Lombardin.)	foot in 729 years.
	7,755 (By myself)	30,000,000 (By myself)	1 foot in 25,218 years.
Thames, King-ston	2,100 (By Prof. Prestwich)	1,868,910 (Huxley's "Physiography.")	1 foot in 9,600 'Physiography.')

We have now the necessary "data" for considering these three rivers in their conjoint character. Together they drain an area of 1,105,000 square miles; they discharge a body of water equal to 894,000 cubic feet every second; and they carry down every year to the sea 27,028,500,000 cubic feet of sediment, which represents a rate of subaërial denudation equal to the removal of one foot of solid rock in 1,687 years.

If we look upon the Yang-tse, the Yellow River, and the Pei-ho as labouring, with the assistance of the gradual elevation of the sea-border which is at present going on, to extend the territory of China seaward towards her ancient coast-line—represented by a line running from Kamtschatka through the Kurile Islands, Japan, the Loo-choo group, Formosa down to the Malay Archipelago;<sup>4</sup> and carry ourselves forward into the future when such task is completed and the waves of the Pacific beat once more against this old sea-border, we shall not have much difficulty in picturing to ourselves what will then be the state of matters. In the place of the gulf of Pe-chili and the Yellow Sea there will be vast alluvial plains traversed by the waters of the Yang-tse, the Yellow River, and the Pei-ho; but before the ancient coast-line is reached they will have joined to form one great river and one united delta. If the Yellow River confines itself mostly in future ages to its course into the gulf of Pe-chili, that gulf will be filled up in process of time; and the Hoang-ho winding along through the bed of this obliterated sea will, after being joined by the Pei-ho, turn its course southward, deflected by the Corcan peninsula, until it meets at length its sister stream. On the other hand, should the Yellow River be mostly occupied in future in advancing its southern delta it will join the Yang-tse at a period much less remote from the present; and their

united waters will pursue an easterly direction subsequently to be joined by the Pei-ho, which will have been gradually finding its way through the gulf of Pe-chili and the Yellow Sea during the preceding ages. In either event the union of these three rivers would follow.

Such being the case, it may be interesting to speculate on the time required by these rivers to fill up the seas into which they discharge their sediment. Sir George Staunton estimated that at the rate the Hoang-ho was discharging sediment it would fill up the Yellow Sea and the gulfs of Pe-chili and Lian Tung in 24,000 years; but M. Elisée Reclus is of opinion that this estimate ought to be doubled, as the Yellow Sea is much deeper than Sir George Staunton stated it to be (20 fathoms). On carefully examining the latest charts of these seas I am inclined to consider that this estimate cannot be assailed on this point, as my own determination of the average depth is 22 fathoms.

We will now attempt to gauge the time that the three rivers in question would require to fill up by the sediment they deposit the portion of sea which is included by the gulfs of Pe-chili and Lian Tung, the Yellow Sea, and the Eastern Sea north of the 29th parallel and west of the 126th meridian. I have placed the total surface area at 200,000 English square miles, and the average depth at 26 fathoms; and following Sir George Staunton's mode of estimation I find that it would take sixty-six days to form an island a mile square reaching up to the surface of the sea. At this rate it would require 36,000 years to form all the sea in question into dry land, supposing of course that there was no elevation or depression of the sea-bottom during that period. But, the recent formation of several islands and shoals in the Yang-tse estuary, the occurrence of raised beaches and marine remains at Hiang-chau, Wusung, and Chefoo, with other similar evidences, demonstrate that there is an elevation of the coast going on at present; and, in that case, it will require considerably less than 36,000 years to form the sea into terra firma. Perhaps Sir George Staunton's original estimate for the Yellow River may not be far wrong when applied to the whole sea in question.

PHYSICS WITHOUT APPARATUS<sup>1</sup>  
VI.

ACOUSTICAL experiments require, for the most part, the aid of some good instrument or valuable piece of apparatus. Nevertheless a few instructive illustrations of the principles of the science can be improvised without difficulty. Firstly, there is the familiar experiment brought into fashion, we believe, by Prof. Tyndall, of setting a row of ivory billiard balls or glass solitaire marbles along a groove between two wooden boards, and showing how their elasticity enables them to transmit from one to another a wave of moving energy imparted to the first of the row, thus affording a type of the transmission of sound-waves from particle to particle through elastic media. Then we may show how sounds travel through solid bodies by resting against a music-box or other musical instrument, a broomstick, or any convenient rod of wood, at the other end of which we place our ear. A kindred experiment, illustrative of the transmission of sounds through threads, is depicted in Fig. 20. A large spoon is tied to the middle of a thin silken or hempen thread, the ends of which are thrust into the ears upon the ends of the thumbs. If the spoon be dangled against the edge of the table it will resound, and the tones reach the ear like a loud church bell. The thread telephone or "lover's telegraph," is upon the same principle, the thread transmitting the whispered words to a distance, without that loss by spreading in all directions which takes place in the open air.

<sup>1</sup> Where not otherwise mentioned I have obtained my information of the discharge of water and sediment from the "Earth," by Elisée Reclus.  
<sup>2</sup> This estimate also includes the solids held in solution.  
<sup>3</sup> In Page's "Advanced Text-book of Geology" Staunton's estimate of the sediment discharged by the Yellow River has been erroneously applied to all "the great Chinese rivers."  
<sup>4</sup> Vide a paper on this subject, by Mr. A. S. Bickmore, read before the North China branch of the Asiatic Society in November, 1867.

The discovery that a musical tone is the result of regularly recurring vibrations, the number of which determines the pitch of the tone, was made by Galileo without any more formal apparatus than a mill-edged coin, along the rim of which he drew his thumb-nail, and found it to produce a sound. We can show this better by taking a common toy gyroscope-top with a heavy leaden wheel, such as are sold at every toy-shop. With a strong penknife or a file, cut a series of fine notches or grooves across the rim, so that it shall have a milled edge like a coin. Now spin it, and while it spins, gently hold against the revolving wheel the edge of a sheet of stiff writing-paper or of a very thin visiting card. A loud clear note will be heard if the nicks have been evenly cut, which, beginning with a shrill pitch, will gradually fall with a dolorous cadence into the bass end of the scale, and finally die out in separately audible ticks.

Much notice was attracted some years ago by the discovery of singing and sensitive flames. A sensitive



flame is not easily made, unless where gas can be burned at a much higher pressure than is to be found in the case of the gas supplied by the companies for house-lighting. To make a singing-flame requires the proper glass tubes and an apparatus for generating hydrogen gas. The roaring-tube, which we are now about to describe, is a good substitute, however, and is also due to the generation of very rapid vibrations, although in this case the way in which the heat sets up the vibrations cannot be very simply explained. Let a common paraffin-lamp chimney be chosen, and let us thrust up loosely into its wider or bulbous portion a piece of iron-wire gauze such as is often employed for window-blinds. If this be not at hand a few scraps of wire twisted together, or even a few hair-pins will suffice. The lamp-chimney must then be held over the flame of a spirit-lamp, or other hot flame, until the wire-gauze glows with a red heat (see Fig. 21). Now remove the lamp or lift the chimney off it, so that the gauze may cool. It will emit a loud note like a powerful (though rather harsh) organ-pipe, lasting for

about a quarter of a minute, or until the gauze has cooled. Tubes of different sizes produce different notes.

It is now well known that the quality of different sounds depends upon the form or character of the invisible sound-waves, and that different instruments make sounds that have characters of their own, because their peculiar shapes throw the air into waves of particular kinds. The different vowel-sounds are caused by putting the mouth into particular shapes in order to produce waves of a particular quality. Take a jew's-harp and put it to the mouth as if you were going to play it. Shape the mouth as if you were going to say the vowel O, and on striking the harp you hear that sound. Alter the shape of the mouth to say A, and the harp sounds the vowel accordingly. The special forms of vibration corresponding to the different vowel-sounds can be rendered evident to the eye in a very beautiful way by the simplest conceivable means. A saucerful of soapy water (prepared

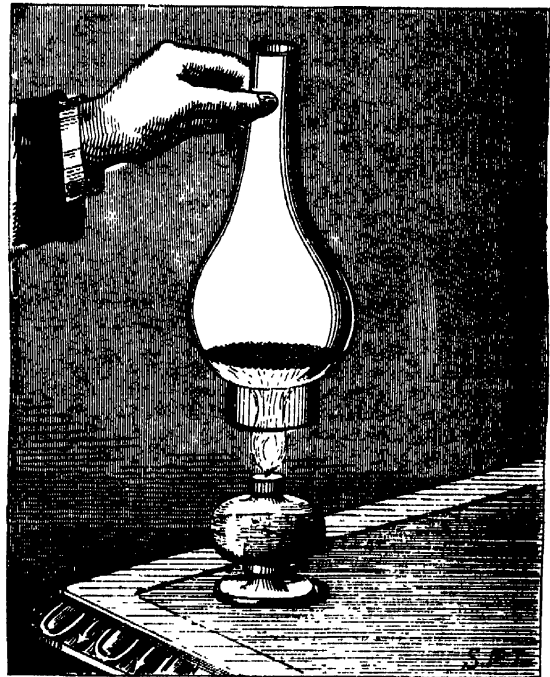

FIG. 21.

from yellow kitchen soap and soft water, or with cold water that has previously been boiled) and a brass curtain-ring, is all that is needed. A film of soapy water shows, as all children know when they blow bubbles, the loveliest rainbow-tints when thin enough. A flat film can be made by dipping a brass curtain-ring into the soapy water, and then lifting it out. When the colours have begun to show on the edge of the film, sing any of the vowels, or the whole of them one after the other, near the film. It will be thrown into beautiful rainbow patterns of colour which differ with the different sounds. Instead of a curtain-ring the ring made by closing together the tips of finger and thumb will answer the purpose of providing a frame on which to produce the phoneidoscopic film.

(To be continued.)

**GENERAL PITT RIVERS' (LANE FOX)  
ANTHROPOLOGICAL COLLECTION**

THE collection which General Pitt Rivers, F.R.S., commenced to form in the year 1851 became well known to all immediately interested in the science of

anthropology during the series of years in which it was exhibited at the Bethnal Green branch of the South Kensington Museum as Col. Lane Fox's collection, and no one visited it without picking up a great deal of interesting and curious information. To those who studied it with care it opened up a new field of exploration, and invested all objects of art and manufacture, from the simplest ornaments, weapons, or implements of savages, to works the product of the highest modern culture, with a certain peculiar interest over and above the gratification derived from the objects themselves without reference to the history of their origin. It is needless to say that the moving power of this peculiar interest was the evolution theory, for the object which General Pitt Rivers set before him was, as he explained, "so to arrange his collection of ethnological and prehistoric specimens as to demonstrate, either actually or hypothetically, the development and continuity of the material arts from the simpler to the more complex forms. To explain the conservatism of savage and barbarous races and the pertinacity with which they retain their ancient types of art. To show the variations by means of which progress has been effected and the application of varieties to distinct uses. To exhibit survivals or the vestiges of ancient forms which have been retained through natural selection in the more advanced stages of the arts, and reversion to ancient types. To illustrate the arts of prehistoric times as far as practicable by those of existing savages in corresponding stages of civilisation. To assist the question of the monogenesis or polygenesis of certain arts; whether they are exotic or indigenous in the countries in which they are found. To this end objects of the same class from different countries have been brought together in the collection, but in each class the varieties from the same localities have been placed side by side, and the geographical distribution of each class has been shown in distribution maps." The gradual growth of the arts has of course been the theme of many writers. But General Pitt Rivers was the first, and up till now has, we believe, remained the only, collector who has investigated the development of arts and manufactures, and brought home their history to students by means of series of the objects themselves arranged in groups so as to illustrate their actual pedigrees.

It is in the arrangement that the collection differs from all others. Very many of the objects of which it is composed are to be found in most ordinary ethnological collections, such as that in the British Museum, and the Christy collection; but in these the specimens are arranged geographically, and though thus serving a purpose of the utmost importance as showing in what matters of culture the various races of man are most clearly distinct and separate, or more or less allied, they do not afford that kind of information which it is the one aim of General Pitt Rivers' collection to convey and develop. In fact in the case of all series of objects of arts or manufactures two collections are absolutely required: the one to illustrate pedigree in accordance with the Darwinian theory, the other to illustrate geographical distribution. A collection arranged on General Pitt Rivers' plan is much needed in natural history galleries. What is specially required for the purposes of general instruction is a series which shall trace the pedigree of man and all the other highest types in the several groups as directly as possible from the lowest forms of life. Such a collection might be arranged in a series of galleries radiating from a central chamber in which should be placed the lowest forms, each gallery leading gradually up to the highest of the group to which it was allotted. Good models should represent in the series those links which are embryonic, or which require reconstruction from fossil remains.

Since the year 1851, when General Pitt Rivers' collection was first commenced, it has been continuously added to, and it has now reached very considerable dimensions.

The space allotted to it at present in the South Kensington Museum will not be sufficient to display it sufficiently. General Pitt Rivers has most generously offered to present it to the nation on certain conditions, which will insure its being properly maintained in its present arrangement, and prevent the possibility of its being broken up and distributed amongst other collections by any future authorities who might not thoroughly comprehend its importance in its present condition. It is stipulated that General Pitt Rivers shall have the management of the collection during his lifetime, and that sufficient space shall be allotted to him to allow of his making additions and further developing it in accordance with the plans which he has formed.

A committee consisting of Sir P. Cunliffe Owen, Col. Donnelly, Mr. Augustus Franks, Prof. Huxley, Sir John Lubbock, Mr. Poynter, and Prof. Rolleston, was appointed to consider the advisability of the acceptance of the collection by the nation, and it has, we believe, although the conclusions arrived at have of course not been officially announced, reported unanimously in favour of its being accepted. There can be no doubt that it has acted with the best judgment in so doing; indeed the eminent men of science and art of which it was composed could have arrived at no other conclusion. It would be a very serious matter if the country were to miss so excellent an opportunity, and there could be no better place for the collection than in the South Kensington Museum. It is, as it were, the key to the whole of the vast collections there gathered together. On the one hand, in the Pitt Rivers collection is traced the earliest history of inventions, showing plainly how every primitive implement and machine grew slowly from the simplest contrivances, thus leading up to and acting as a preliminary training for the study of the contents of the Patent Museum; whilst on the other is to be learnt the developmental history of all the arts, the gradual development of sculpture and painting, the history of the development of pattern ornaments, the growth of musical instruments, of the art of pottery, of clothes, and the history of the gradual development of ships. All these series and very many others lead directly up to the various large collections of paintings, sculpture, pottery, models of shipping, &c., which it is the main object of the Museum to exhibit, and cannot but greatly enhance their value and interest to the student. They serve to impress upon the observer the curious fact that all arts and inventions, even those apparently of extreme simplicity, have never been arrived at by jumps, but have grown slowly by degrees by means of a series of slight modifications, just as in the case of biological development. The collection, it should be remarked, does not in any way clash with the Christy and British Museum collections, which are arranged on a perfectly different plan, and which do not in any way bring together savage and civilised objects. There is full room for both collections, and indeed a necessity for them.

We will now draw attention briefly to some few of the series of objects exhibited in the collection taken more or less at random as samples of the whole. The collection may be considered as consisting of three parts. Firstly, a collection of photographs of the various races of mankind which is not as yet far advanced, though it contains large and instructive series of portraits of Danes, Scandinavians, the people of Brittany, and Japanese; whilst together with the photographs is a small series of those skulls which show the best marked racial characteristics, and another which is to exhibit the various modifications in the forms of their skulls which are made by different races. Secondly, the very large collection showing the growth of weapons of all kinds. Thirdly, the various series illustrating the development of musical instruments, ornaments, sculpture, painting, and artistic design of all kinds; and fourthly, those which relate to the develop-

ment of implements, utensils, houses, ships, machines, and strictly useful appliances of all kinds. Of course the two latter series run into one another, and it is impossible to draw a distinct line between them in the case of the lower terms of the series. General Pitt Rivers has especially drawn attention to the manner in which primitive implements subserve many uses: how, for example, a spear-head may do duty as a knife, as is the case with the obsidian-headed spears of the Admiralty Islanders. The earliest Palæolithic stone implements made for grasping in the hand were no doubt weapons of offence, diggers, hammers, nut-crackers, choppers, all in one.

We propose to give a slight sketch of some of the series in the collection, taken at random from its several departments, culling freely from the owner's published catalogue, and his papers read before the Anthropological Institute and elsewhere. We may state at the outset that there exists as yet a catalogue of the weapons only. General Pitt Rivers has not been able to complete a catalogue of the remainder of his collection, since it has been continuously in process of augmentation. The catalogue of the weapons contains so much valuable and curious information that the appearance of the remainder may be looked forward to with great interest.

One of the marked features of the collection is that specimens are usually introduced to show what natural objects may have first suggested primitive contrivances to savage man. Thus amongst the series of savage stone hatchets and adzes we find specimens of natural stone axes as it were (Fig. 1, 1), roots of trees which have grown round and attached themselves firmly to stones which have somewhat of an axe-blade shape, so as to appear like natural hatchets. It is quite conceivable that the first idea of the axe, the fixing the stone blade at the end of a lever, may have arisen from the observation by primitive man, and his possible use of such a natural hatchet.

Amongst the series of specimens illustrating the origin of weaving are placed specimens of bark cloth composed of naturally-interlaced fibres, and we may suggest that it would be well if there were added a specimen of a weaver-bird's nest, which may have given the first hint as to basket-work, and thus led to weaving. In this series is

1

B

C

A

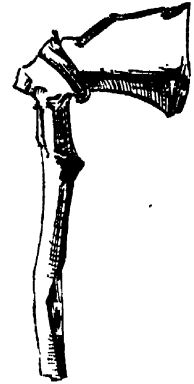

A tree round a blade-shaped without notch or feather; C, from the Island of Cyprus; Ireland.

is most remarkable how closely alike are these implements, though from such widely separated localities. The collection of primitive looms is very interesting, though as yet one of the least complete in the collection. In its primitive condition, as at the Caroline Islands and Vancouver's Island, the loom is entirely portable, consisting of a few sticks only, and only narrow bands, to form belts or armlets, are woven with it. Some years ago we saw such a portable loom in use in Brittany, worked by a boy with his hands and feet, to make girth-like bands with. The boy was working by the road-side and playing about every now and then, with the whole apparatus in his hand. In the bark cloth, made of bark strips welded together by means of beating and the action of water, the "tappa" of Polynesia, we probably see the origin of paper, which in Japan is made from the bark of the same tree as tappa.

The collection of weapons commences with weapons of offence, and begins with a series illustrating the development of the shield out of the parrying-stick, such as now used by Australian blacks, the idea of the wide shield covering the whole body having apparently

arisen as an improvement on the simple stick held in the centre, which gradually expanded and grew into a shield. The origin of the bow is a very interesting question. General Pitt Rivers, as explained in a learned disquisition on the subject in his catalogue, and also in his published lecture on "Primitive Warfare," believes that the first idea of the bow may have arisen from the use of an elastic throwing-stick, with the spring-trap of the Malay regions possibly as a stepping-stone. In several places in the world, as, for example, in the Admiralty Islands, the bow is a contrivance still unknown; and Mr. Brooke Low, whose fine collection of Bornean manufactures and implements is now on exhibition at the South Kensington Museum, informs us that it is not in use throughout Borneo, though the coast people necessarily know the weapon. The primitive arrow is merely a spear thrown with the bow. It is such in New Guinea, where the arrows are far too long for the bow, and though they fly for a dozen yards or so with great force, soon wobble and turn over. The arrows have no notch and no feather;

the bow-string is wide and flat, made of split rattan cane (Fig. 1, B). The notch and feather are further improvements not yet attained, at all events, in the greater part of New Guinea. At the Aru Islands both notch and feather are in use, but the string is still of rattan narrowed to fit the notch. In some of the New Hebrides the arrows, which are beautifully finished, have the notch, but still no feather. The development of the composite bow made up of several pieces of horn, bamboo, wood, ivory, &c., and usually strengthened by the sinews of animals at the back, is illustrated by a special series (Fig. 1, C). It is concluded to have spread from a common centre in Central or Northern Asia to Turkey, Persia, Greenland, California, and elsewhere.

To speak of more civilised weapons, the origin of the bayonet is peculiarly interesting. Its history is set forth in a special small series, and thus explained in the catalogue:—"In the early part of the seventeenth century it was found necessary to retain the use of pikemen in the infantry, on account of the defenceless position of the firelock-men when the enemy approached to close



quarters. To remedy this defect they were accustomed, about the middle of the century, to stick the handles of their daggers into the muzzles of their guns in order to use them as pikes." Implements modified on this principle were called "plug-bayonets" (Fig. 2, 1, 2). One of these in the collection has the date 1647 upon it. The objection to this was that the handles stopped up the muzzle, and the gun could never be fired with the bayonet fixed. Many of the dagger-handles had rings on the guard (Fig. 2, 3), and this suggested the idea of fastening the ring on to the muzzle, and the dagger or plug-bayonet was thus secured on to the outside of a spring, so that the firelock could be loaded and fired with fixed bayonets. The first introduction to this weapon was in one of the campaigns in Flanders, in the time of William III., and greatly were our men astonished at being fired at with fixed bayonets. The series contains all stages leading from the simple dagger with a wooden plug-like handle, through the same with a ring added, to the modern bayonet and its tube and catch.

Another series close by is of classical interest as illustrating the history of the Greek "*kopis*," the peculiar sword which is to be seen in the hands of combatants represented on Greek vases. It is a curved variety of the

straight leaf-shaped bronze sword. It appears to have been brought to Spain by the Romans. It is identical in form with the *koohrie* of the Goorkas of Nepal, and the Turkish, Albanian, and Persian *yataghans* are direct descendants of this ancient weapon.

Leaving the series of weapons, we may refer to the collection illustrating the origin and development of boats and ships. Concerning this question General Pitt Rivers has published a valuable memoir, entitled "Early Modes of Navigation," in the *Journal* of the Anthropological Institute. He there divides the subject into five heads, treating of (1) Solid trunks or dug-out canoes; developing into (2) Vessels on which planks are laced or sewn together, and these developing into such as are pinned with plugs of wood, and ultimately nailed with iron or copper; (3) Bark canoes; (4) Vessels of skins and wicker-work; (5) Rafts, developing into outrigger canoes, and ultimately into vessels of broader beam, to which may be added rudders, sails, and contrivances which gave rise to parts of a more advanced description of vessel, such as the oculus, *aplustre*, fore-castle, and poop.

The dug-out canoes probably originated from trunks of trees accidentally burnt hollow in consequence of the common practice of lighting fires at the bases of trees.

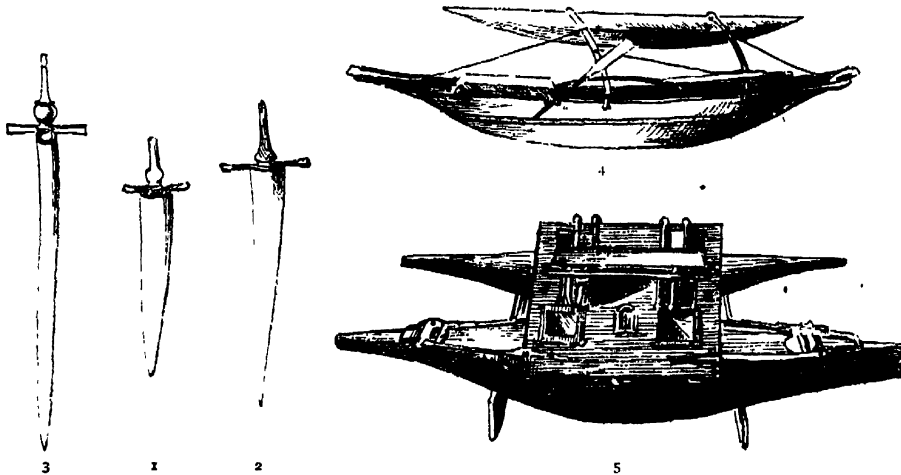

FIG. 2.—1, Dagger with guard, used also as a plug bayonet; 2, the same, but longer and more bayonet-like; 3, bayonet with simple ring for attachment still retaining its cross hand-guard; 4, Singhalese outrigger canoe, consisting of a dug-out base with planks sewn on above; 5, Fijian double canoe.

Some Australian blacks used to paddle about on logs shaped like canoes, but not hollowed out at all, sitting merely astride with their feet resting on a rail of small sticks driven in. As an improvement to the dug-out, wash-boards, or gunwale-pieces, narrow plank strips are added all round at the edge, to keep the wash of the water out. These wash-boards are gradually increased in height till, when the canoe is loaded, the dug-out trunk is entirely below water, and acts merely as a float to support the vessel of planks resting on it. In such a condition are the Singhalese canoes which come alongside all the steamers at Point de Galle and take passengers on shore (Fig. 2, 4). There is a model of one of these in the series, and also another of a wide flat-bottomed boat, also from Ceylon, in which two dug-out trunks are fastened to the margins of the bottom, one on each side, so as to form lateral floats and give the boat very great stability, this primitive device being absolutely the same in principle as that adopted in the structure of the Czar's new yacht *Livadia*, lately described in *NATURE*. In progress of development, the dug-out portion of the canoe becomes proportionately less important, its functions being usurped by the superstructure of planks, and eventually the dug-out disappears, or rather survives as the keel only, and the ordinary boat built of planks is the result. The upper

planks long remain laced together, and lashed to the dug-out by means of rattans or scnet, the boats having no ribs, but simply thaws as supports for the planks. In Fiji the ribs seen in the interior of the canoes are not used to bring the planks into shape, but are the last things inserted, and are used for uniting the deck more firmly to the body of the canoe. Wallace has described the boats and boat-builders of the Ké Islands. Here, though the ledges of the planks are pegged together by means of wooden pegs, the planks are still fastened to the ribs by means of rattans. The ribs themselves are an addition, after the boat is otherwise complete, and after the first year the rattan-tied ribs are generally taken out and replaced by new ones, fitted to the planks and nailed.

General Pitt Rivers develops the outrigger canoe from the raft. In all Africa and all America there has never existed an outrigger vessel of any kind. All the canoes are simple; but on the coast of South America rafts are used with sails elsewhere unknown in America. Those termed *balzas*, used on the Guayaquil, in Ecuador, are described by Ulloa. Some are seventy feet in length, and twelve in breadth. They are made of light wooden logs lashed together, and when they are sailing, planks are pushed down into the water between the logs, and, acting as centre-boards, enable the rafts to luff up or bear

away, according as they are inserted in the fore or hinder part. On the raft theory the outrigger canoe is supposed to have been developed from an improved modification of the sailing raft, in which two logs were made use of instead of many, as opposing less resistance to the water, and were connected by a platform. Such two-log structures, of course without sails, have been described as in use by the Tasmanians. The use of the sailing rafts on the Pacific coast of America seems to lend probability to the theory, since the outrigger canoe is universal in Polynesia. On this theory the double canoe (Fig. 2, b) is a highly-specialised development of the two-log rafts; and General Pitt Rivers points for additional proof to the fact that in all double canoes one vessel is always smaller than the other. This may however be merely a contrivance for aiding steering.

On the other hand it seems to us very probable that the outrigger canoe is really derived from the double canoes and that the outrigger float represents, not a log in process of development towards a canoe itself, but a degenerate second canoe. On some parts of the coast of New Guinea the Papuans are accustomed to lash side by side firmly several of their large canoes, when about to set out on a trading expedition of 200 or 300 miles and sail along the coast. Such a group of canoes is called a "lakatoi." It is very probable that the fastening of two dug-outs side by side may have early suggested itself, and that the two may have gradually been separated and fastened by longer and longer cross-pieces, as stability was found to be increased thereby. We merely suggest this other view of the matter as worthy of consideration. It is by means of collections such as that now under consideration that such points can be determined. Luckily, for some reason or other, possibly a religious one, savages all over the world make most carefully-constructed models of their canoes. These are not children's toys, but exact models, correct in all details. Even the wretched Fuegians do this, and the models are not made for purposes of barter originally, since they are made by such races as the Admiralty Islanders, who have no opportunity of disposing of them. We seem even ourselves to make more models than necessary, as the quantities of them in museums testify. General Pitt Rivers has collected a most valuable series of native models of boats and ships of all kinds.

(To be continued.)

#### NOTES

JUDGING from the papers and reports that have reached us, through the kindness of the permanent secretary, Mr. F. W. Putnam, the Boston meeting of the American Association has been a great success. The many attractions of Boston drew together a large concourse, including nearly all the great lights of American science. The people of Boston and Cambridge seem to have exerted themselves to the utmost to make the numerous visitors enjoy themselves, and, from the accounts of the many excursions and receptions, these exertions were completely successful. There were something like a thousand names registered on the books of the Association, and at the Cambridge dinner, on August 24, 870 persons were present. The number of papers entered was 280, all of them evidently duly considered before being admitted, and many of them of great scientific importance.

THE address of welcome of Prof. Rogers, of the Massachusetts Institute of Technology, briefly reviewed the origin of the various National Associations, predicting that the American would in time rival that which at the moment was meeting at Swansea. "Let us," Prof. Rogers said, "make it our special work to exclude from our annual reports all detailed publications which are not of a character actually to add to the

stock of human knowledge, whether that knowledge be simply the gathering together of facts by careful processes of discernment, or the development of laws by careful mathematical investigation." Mr. Lewis H. Morgan, the president of the Association, in his brief reply to the addresses of welcome, made some remarks which are quite as deserving of attention here as on the other side of the water. "When the meetings of this Association become indifferent to the communities among which they are held, its usefulness will be near its end. There is a direct connection between the work upon which its members are engaged and the material prosperity of the country, in which all alike have an interest. Scientific investigations ascertain and establish principles which inventive genius then utilises for the common benefit. We cannot have a great nation without a great development of the industrial arts, and this, in its turn, depends upon the results of scientific discovery as necessary antecedents. Material development, therefore, is intimately related to progress in science." The address of Prof. A. Agassiz in Section A we gave in a recent number, and that of Prof. Asaph Hall we hope to be able to give next week. Prof. Bell's remarkable lecture will be found on another page.

THE German Association began its sittings at Danzig last Saturday, and continues them during the present week. Judging from the reports that have been sent us, the German *savants* have received a warm welcome in the great Prussian commercial city. The programme of papers, as we have already intimated, is long, and contains several of great importance. Prof. Cohn of Breslau brought forward at one of the public lectures important data, spreading over many years, as to the prevalence of colour-blindness, especially in Germany, Switzerland, and America.

A CORRESPONDENT informs us that at the meeting of the Geological Society of France at Boulogne, to which we have already referred, the French geologists did England the honour of electing Prof. Prestwich president. Besides Professors Prestwich and Seeley, two other English geologists were present at the meeting, the Rev. J. F. Blake and the Rev. T. Wiltshire. There were also present a large number of Belgian geologists. With the French geologists the meeting numbered about fifty members. Daily excursions were made to all the many places of geological interest in the Boulonnais, and in the evenings papers were read by Prof. Gosselet, Dr. E. Sauvage, M. Pellat, and Prof. Prestwich, on the geological features of the places visited. The geologists were most hospitably entertained by the municipality and other public bodies.

AT the Swansea meeting of the British Association Sir William Thomson, as an incidental illustration of a paper by him, gave the following method of "turning the world upside down." Suppose there to be no sea or other water on the earth, and no hills or hollows; and let the earth be a perfectly elastic or perfectly rigid solid, with no moon nor sun, nor other body to disturb it. Commencing anywhere in the northern hemisphere, walk a few miles northwards or southwards. This, by displacing the earth's axis makes a slope. Then walk up hill as long as you can; then walk a few miles southwards; then lie down and rest, and in time the thing is done; that is to say, what was the South Pole is found under Polaris.

THE autumn Congress of the Sanitary Institute was opened at Exeter on Tuesday, under the presidency of Lord Fortescue.

THE death, on August 2, is announced of Karl Ritter von Hauer, the director of the chemical laboratory of the Geological Institute of Vienna.

A CONGRESS on hygiene was held at Hamburg on September 13, 14, 15. The number of members was about 200. At the first sitting the hygiene of hospitals and public buildings was discussed; at the second the hygiene of shipping, after the

delivery of an address by Dr. Reincke; and on the third day the ventilation of private dwellings, and other similar subjects. A resolution, proposed by Dr. Rietschel of Dresden, was passed to induce public authorities to study practically the ventilation of buildings, and another, by Dr. Prath of Dresden, that sanitary inspection should always take place by duly qualified officers. This session is the eighth of the Association.

THE Russian newspapers announce that the jubilee of the zoological museum of the Academy of Sciences, established in 1831 by the Emperor Nicholas, will take place in 1881. Russian and foreign zoologists will meet at St. Petersburg on this occasion.

THE Association Scientifique de France has not continued the observations of meteors which was begun by Leverrier, its founder. No steps have been taken by the Observatory to fill up this important gap in the scientific work of the nation. The interest of observations taken during the last two years in the display of August meteors and the forthcoming inauguration of Leverrier's statue have attracted public attention to this circumstance, and it is hoped these observations will shortly be resumed.

UNIVERSITY COLLEGE, Bristol, has the credit of being the first in England in which the higher education of women has been conducted on a large scale in conjunction with that of men. Its Calendar, which is before us, shows that in the last session, its fourth, the College was attended by more than five hundred students, of whom nearly half were women. A wide range in science and literature is covered by the lectures, of which there are more than forty distinct courses in the day, and more than twenty in the evening. Its engineering department has derived great advantage from the plan under which the students spend the six winter months in the College, and the six summer months as pupils in engineering works in the neighbourhood. The want of space, which has hitherto pressed severely, will be relieved by the opening in October of a part of the new buildings.

THE crayfish is disappearing so rapidly in several French departments that energetic measures have been considered necessary for its protection. The fishing of it has been entirely prohibited in the departments of Meuse and Doubs by prefectorial decrees.

THE freedom of the City of London is to be conferred on Sir Henry Bessemer, F.R.S., on October 6.

M. LORTET gives a brief account in the *Comptes rendus* for September 13, of the results of his dredging in the Lake of Tiberias. The lake is 212 metres above the surface of the Mediterranean, and the greatest depth is 250 metres. M. Lortet finds proofs that the lake was formerly on the same level as the Mediterranean. It is probable, he thinks, that formerly the lake was very salt; and thus a study of the fauna of the lake is full of interest. At least a dozen species of fish were obtained, several of them new forms, which M. Lortet is now investigating. He gives the following list of species which have been determined:—*Clarias macranthus*, *Capoeta damascena*, *Barbus Bed-domii*, *Chromis Andrae*, *C. paterfamilias*, *C. Simonis*, *C. nilotica*, *C. nov. sp.*, *C. nov. sp.*, *C. nov. sp.*, (*un genre nouveau indistinct*), *Labrobarbus canis*. Several new species of molluscs have also been obtained; M. Lortet gives the following list:—*Neritina Jordani*, Butt.; *Melania tuberculata*, Müller; *Melanopsis premorsa*, L.; *M. costata*, Olivier; *Cyrena fluminalis*, Müller; *Unio terminalis*, Bourg.; *U. tigridis*, Bourg.; *U. Lorteti*, Locard; *U. Pietri*, Locard.; *U. Maris Galilaei*, Locard. *Melanopsis* and *Melania* are of a marine appearance, and seem to M. Lortet to show the transition between salt and fresh water.

IN Vol. xii. of the *Transactions* of the New Zealand Institute Mr. J. W. Stack has some interesting notes on the colour-sense of the Maori. Mr. Stack asks what stage had the colour-sense of the Maori reached before intercourse with Europeans began? This can readily be ascertained by reference to the terms existing in the language at that date for giving expression to the sense of colour. We find, upon examination, that the language possessed very few words that conveyed to the mind an idea of colour, apart from the object with which the particular colour was associated. There are only three colours for which terms exist, namely, white, black, and red. White, *ma* (sometimes *tea*—very limited application). Black, *pouri*, *pango*, *mangu*. Red, *whero*, *kura*, *ngangana*. If we analyse these words they seem all to relate to the presence or absence of sunlight. *Ma* is doubtless a contraction for *Marama*, light, which is derived from *Ra*, the sun. *Pouri*, black, is derived from *Po*, night. The derivation of *pango* and *mangu* is not so apparent, but I venture to think that both *whero* and *kura* may be traced to *Ra*. *Ma* is not only the term for whiteness and clearness, but also for all the lighter tints of yellow, grey, and green. Grey hair is called *hina*, but the term was never used to designate anything else but hair; every other grey object was either *ma* or *pango*, as it inclined to a lighter or darker shade. All the words for expressing redness, except *ngangana*, *may*, Mr. Stack thinks, be traced to *Ra*, and connect the Maori idea of that colour with the brilliant rays of the sun. *Ngangana* is not the word generally used to express the quality of redness, but only certain appearances of it, as in flowers or blood-shot eyes. Yellow and green were recognised, not as abstract conceptions of colour, but only as they are associated with objects. Blue was not formerly recognised, as no word exists to represent it. Anything blue was classed with black, and went under the heading of *pouri*, or *pango*, or *mangu*. The blue depths of ocean and sky were *pouri*, or dark. No words are found in the Maori language to express violet, brown, orange, and pink colours; but there are not less than three words to express pied or speckled objects. *Kopurepure* = reddish speckle; *Kotingotingo* = dark speckle; *tongilongi* = spotted. The limited number of colour-expressions that exist in the Maori language cannot be attributed to the absence of objects presenting those colours for which the terms are wanting. The ornamental scroll-work, and the elaborate patterns employed in tattooing and carving, showed that the Maoris were capable of appreciating the beautiful, both in form and in colouring, and we can only account, Mr. Stack thinks, for their indifference to the more delicate tints of flowers which call forth our admiration by supposing that their colour-sense was not so well educated as our own.

MR. JOHN SCOTT has been appointed Professor of Agriculture and Estate Management to the Royal Agricultural College at Cirencester. Mr. Scott studied agriculture at the University of Edinburgh, and has had many years practical experience in farming, estate management, and land valuing, both at home and in the Colonies. He is the author of two well-known books on farm and estate valuations, and was formerly editor of the *Farm Journal*.

A NEW and revised edition of Bishop Stanley's well-known and deservedly popular "Familiar History of British Birds" has just been published by Messrs. Longmans and Co. It has been revised by "a practical ornithologist of much experience," and has been furnished with numerous additional illustrations.

ANOTHER Lake village, assigned by experts to the age of Bronze, has been discovered at Auvernier, near Neuchâtel. Several millstones quite new, others half made, have been brought to light, from which it is inferred that the place may have been the seat of a manufactory of these articles. Another

conclusion drawn from this find is that Swiss pile buildings served as actual dwellings for the primeval inhabitants of the land, and were not, as has been supposed, used merely as storehouses.

MR. DAVID BOGUE will publish in November a new book by Mr. S. Butler, author of "Erewhon," "Life and Habit," &c., entitled "Unconscious Memory." The work will contain translations from the German of Prosper Ewald Hering of Prague, and of von Hartmann, with a comparison between the views of instinctive and unconscious actions taken by these two writers respectively.

THE British Museum is about to be enriched by a collection of natural history specimens made by the officers of Her Majesty's surveying ship *Alert*, which has been for some months engaged in making a complete survey of the Straits of Magellan.

WITH the view of promoting agricultural improvement in Bengal and encouraging the study of scientific agriculture, the Bengal Government has created two annual special scholarships of 200*l.* each, to be held by science graduates of the Calcutta University at Cirencester College.

A TERRIFIC hurricane passed over the Bermudas on August 29 and 30, stated to have exceeded in violence the historical hurricane of 1839.

TWO years ago (*NATURE*, vol. xviii, pp. 104, 344) we directed attention to the discoveries made in Russia in regard to Fermat's asserted prime-form  $2^{2^m} + 1$ . We have now to chronicle the fact that to the number of composite integers of this form another addition has just been made. M. Landry has found that  $2^{64} + 1$  is divisible by 274177. As at present ascertained therefore the composite members of the form are—

$m = 5$ ;	divisor,	$5 \cdot 2^7 + 1$	(Euler),
$m = 6$ ;	"	$1071 \cdot 2^9 + 1$	(Landry),
$m = 12$ ;	"	$7 \cdot 2^{14} + 1$	(Pervouchine),
$m = 23$ ;	"	$5 \cdot 2^{28} + 1$	(Pervouchine).

MM. MARTINET AND LESSON have brought out vol. i. of their work on the origin and migrations of the Polynesians. The next volume is nearly ready, and the remainder will be published in 1881. The aim of this exhaustive work is to demonstrate that the Polynesians are neither Asiatics nor Americans, but Maoris, from the Middle Island.

M. C. DE UFALVY is engaged in editing the narrative of the voyage of M. Panagiotis Potagos in Central Asia; while to M. Henri Duveyrier has been confided, by the Paris Geographical Society, the task of preparing for publication in French that traveller's expedition in Equatorial Africa.

THREE French expeditions are being organised. One, by M. Revoil, to Aden, in the country of the Somalis; another, by M. Moindron, to the northern coasts of New Guinea, which, if practicable, is to advance beyond the points reached by Raffray, Meyer, and Albertis; and the third, by M. Flahant, to the Polar Seas, in conjunction, probably, with Nordenskjöld.

A FRENCH explorer, M. Lecart, who is at present on the banks of the Niger, writes home from "Koundian (Ganganan), July 25," that he has discovered a new vine, which promises to be of great economical value. He says the fruit of the vine is excellent and abundant, its cultivation very easy, its roots tuberoso and perennial, while its branches are annual. It can be cultivated as easily as the dahlia. He himself had been eating the large grapes of the vine for eight days, and found them excellent, and he suggests that its culture ought to be attempted in all vine-growing countries as a possible remedy against the phylloxera. He is sending home seeds for experiment, both in France and Algeria, and will bring home specimens of the plant at all stages.

MR. F. J. CAMPBELL of the College for the Blind, Upper Norwood, he himself being blind, gives an interesting account of his successful ascent of Mont Blanc, the first time such a feat was accomplished by a blind man.

THE Report of the Cardiff Naturalists' Society for 1879 has to complain of a considerable falling off in the membership, attributable mainly to bad times. Otherwise the work of the Society has been fairly satisfactory.

AT a recent meeting of the Balloon Society of Great Britain, it was announced that a challenge had been received from M. de Fonvielle, president of the French Académie d'Aérostation, to a balloon contest during the present autumn on English soil. After a discussion it was decided to accept the challenge, the contest to take place between one member of each nationality, and the ascent to be made from the Crystal Palace.

ACCORDING to a table published by the *Statistische Monatschrift* of Vienna, the number of volumes in the National Library of Paris is 2,078,000, and in the British Museum only 1,000,000. But it should be noted that the number of volumes does not give an exact idea of the real importance of a library. The Vatican, which is stated to have only 30,000 volumes and 25,000 manuscripts, must be considered as ranking far above its numerical position. According to the provisions of the French law, the deposit is required of each re-impression, even where there is no alteration, and the National Library has not the right of disposing by sale of useless volumes, so that there is an accumulation of popular works of no value at all. There is a room full of Noel and Chapsal's Elements of Grammar, and endless numbers of *Petits Parisiens*. Popular novels are in the same case, and there are more than eighty copies of "Nana."

AN interesting prehistoric sketch of the Spreewald and the Schlossberg of Burg, with special map and illustrations, by Professors Virchow and Schulenburg, has been published by Wiegandt of Berlin.

THE additions to the Zoological Society's Gardens during the past week include a Brown-necked Parrot (*Paeocephalus fuscicollis*) from West Africa, presented by Mr. H. Wood; a Jacaraca (*Craspedocephalus brasiliensis*), a Tree Snake (*Dryiophis acuminata*), a — Amphisbœna (*Amphisbœna alba*) from Brazil, presented by Dr. A. Stradling, C.M.Z.S.; a — Amphisbœna (*Bronia brasiliensis*) from Pernambuco, presented by Mr. W. A. Forbes, F.Z.S.; a Weeper Capuchin (*Cebus capucinus*) from Brazil, a Ring-tailed Coati (*Nasua rufa*), a Spotted Cavy (*Calogenys paca*) from South America, a Crab-eating Raccoon (*Procyon cancrivorus*) from West Indies, a Saturnine Mocking-Bird (*Mimus saturninus*), two Silky Hang-nests (*Amblyrhampus holosericeus*), a Sulphur Tyrant Bird (*Pitangus sulphuratus*) from Monte Video, a Maximilian's Araçari (*Pteroglossus wiedi*) from Pernambuco, deposited; five Ruffs (*Machetes pugnax*), British, purchased; a Reeves's Muntjac (*Cervulus reevesi*), born in the Gardens.

#### OUR ASTRONOMICAL COLUMN

COLOURS OF SOUTHERN STARS.—In the *Uranometria Argentina*, Dr. Gould has drawn attention to a number of stars presenting marked colour, and to several in which there appears to be change of colour: the following are amongst the more noticeable cases:—

$\beta$  Hydri is remarkable for its clear yellow light (2.7m.); the Cordoba observations do not support Sir John Herschel's suspicion of variability of brightness.  $\alpha$  Indi is also of a bright clear yellow; mag. 3.1. The blue colour of  $\gamma$  Tucanæ is very marked; Gould's magnitude is 4.0.  $\phi$  Eridani (3.5) is remarkable for its blue colour, and  $\nu$  Puppis (3.5) is decidedly blue;  $\epsilon$  Pavonis, the estimates of magnitude of which star vary from 3.6 to 4.2, is of a remarkably blue colour. Gould's No. 9 in Dorado, Lacaille

1567, which varies from  $5\frac{1}{2}$  to  $6\frac{1}{2}$ , is excessively red;  $\pi^1$  Grulis is of a deep crimson, while its neighbour  $\pi^2$  is conspicuously white; magnitudes respectively  $6\cdot7$  and  $5\cdot9$ . The star No. 10163 of Oeltzen's Argelander is remarkable for its superb crimson colour; its place for 1875 is in R.A. 9h. 45m. 18s., N.P.D.  $112^\circ 25'$ .  $\mu$  Muscæ ( $5\cdot3m.$ ) is intense orange-red.

$\gamma$  Centauri, varying between  $4\cdot5$  and  $5\cdot1$ , appears also to vary in colour, having been repeatedly noted as reddish, while at other times it was found without any marked tinge. N Velorum, which has a peculiar yellow colour, contrasting markedly with that of the numerous red stars in its vicinity, is suspected to vary in colour as well as in brightness, the period of the variations appearing to be not far from  $4\frac{1}{2}$  days, though the number of observations is not sufficient to give the law of the fluctuations. The positions of these stars for 1875<sup>0</sup> are:  $\gamma$  Centauri, R.A. 13h. 42m. 13s., N.P.D.  $123^\circ 49'5''$ ; N Velorum, R.A. 9h. 27m. 25s., N.P.D.  $146^\circ 29'0''$ .

Dr. G the light called  $\alpha$  tinge—pale emerald.

TELEGRAPHIC DETERMINATIONS OF LONGITUDE.—The Hydrographic Office at Washington has published a number of geographical positions determined in 1878 and 1879 by parties under the direction of Lieut.-Commanders F. M. Green and C. H. Davis of the United States Navy. The longitudes were fixed by telegraphic exchanges of time-signals, the initial point of measurement being the meridian of the Royal Observatory at Greenwich. The latitudes (with the exception of Lisbon, determined by the Director of the Royal Observatory, Capt. F. A. Oom) result from numerous zenith-telescope observations of pairs of stars. The details of the observations are in the press, and will shortly appear; meanwhile we extract from No. 59 of the *Notices* of the Hydrographic Office the positions of the more important points—

- Lisbon—Centre of dome of the Royal Observatory. Lat.  $38^\circ 42' 31''\cdot3$  N. ... Long. 0h. 36m.  $44'68s.$  W.
- Funchal (Madeira)—Flagstaff of Fort St. Jago. Lat.  $32^\circ 38' 4''\cdot1$  N. ... Long. 1h. 7m.  $35'56s.$  W.
- Pernambuco—Lighthouse near Fort Ricão Lat.  $8^\circ 3' 22''\cdot2$  S. ... Long. 2h. 19m.  $27'77s.$  W.
- Bahia—San Antonio Lighthouse. Lat.  $13^\circ 0' 37''\cdot4$  S. ... Long. 2h. 34m.  $8'37s.$  W.
- Rio de Janeiro—Centre of dome of Imperial Observatory. Lat.  $22^\circ 54' 23''\cdot8$  S. ... Long. 2h. 52m.  $41'41s.$  W.
- Montevideo—Centre of south-east tower of Cathedral. Lat.  $34^\circ 54' 33''\cdot0$  S. ... Long. 3h. 44m.  $49'02s.$  W.
- Buenos Ayres—Centre of Capola of Custom-house. Lat.  $34^\circ 36' 29''\cdot8$  S. ... Long. 3h. 53m.  $28'95s.$  W.

FOUR-FIGURE LOGARITHMS AND ANTI-LOGARITHMS.—Messrs. Layton, Fleet Street, have lately published tables of logarithms of numbers to four places from 1000 to 9999, and anti-logarithms '0000 to '9999, arranged by General Hannyngton, similarly to the modern six and seven-figure tables. All the figures are printed, and the value sought is consequently found by mere inspection. The logarithms of numbers 0 to 999 would

of four-figure logarithms of numbers and trigonometrical functions is much to be desired, and would suffice for eclipses, occultations, star-corrections, and many subordinate astronomical calculations; it is to be regretted that the logarithms of trigonometrical functions are not given in the present publication.

**ACTION OF PHOSPHORESCENT LIGHT ON SELENIUM<sup>1</sup>**

A FEW weeks ago, when listening to Mr. Heaton's lecture on Balmain's luminous paint at the Society of Arts, it occurred to me to try whether the faint light of phosphorescence would exercise any sensible effect upon the electric conductivity of selenium. I lately made some experiments in this direction, for which I adopted the following arrangement:—One of Dr. Werner Siemens' selenium preparations, of the kind described by me in vol. vi. of the *Society of Telegraph Engineers' Journal*, was placed in the circuit of two Daniell cells, together with a delicate Thomson's reflecting galvanometer. The sele-

nium was put into one end of a [blackened brass tube, which was placed inside] a dark box provided with a sliding door in front of the open end of the tube. The source of phosphorescence was a sheet of glass 20 X 30 centimetres, painted at the back with some phosphorescent material.<sup>1</sup> This luminous sheet was placed before the opening of the box, usually at a distance of about 60 centimetres from the selenium plate.

In the first series of experiments the phosphorescence of the sheet was excited by exposing it to light from different sources. The results were as follows:—

No. of experi-	Description of light used for exciting the phosphorescence of the sheet.	Increase of conductivity of the selenium by the action of phosphorescent light.
	The sheet was exposed to:—	Per cent.
	Light reflected from ceiling of semi-dark room for several minutes.	0·7
	Light reflected from ceiling of moderately light room for fifteen minutes.	2·4
	Light of the sky at 5 p.m. for several minutes.	4·6
	Light from a few inches of burning magnesium ribbon.	
	Sunlight for two minutes exactly.	7·8
	Sunlight for five minutes exactly.	

After a lapse of some minutes the sheet was again exposed, lessened; for instance, the third experiment gave only about  $\frac{1}{4}$ th of the original value five minutes after the exposure. The sheet, exposed to strong light two hours previously, showed no perceptible action on the selenium. The curious fact that the effect is less when the sheet is exposed to sunlight for five minutes than when it is exposed for only two minutes, is probably due to the circumstance that the sheet becomes sensibly warm during the longer period of exposure.

In the second series of experiments different lengths of magnesium ribbon were burnt in front of the sheet and at a distance of about 15 centimetres from it. The intensity of the phosphorescence increased with the time of exposure to light, as the following little table shows:—

Length of magn ribbon.	Time the magnesium was burning.	Increase of conductivity of selenium.
Centimetre		Per cent.
1		0·8
3	3	1·8
	5	2·4
20	12	2·8
30		3·4

In the third series of experiments a length of 20 centimetres of magnesium ribbon was burnt in front of the sheet at 20 centimetres distance from it. The sheet was then, immediately after its exposure to light, placed at distances of 200, 150, 100, and 50 centimetres respectively from the selenium. It was found that the effect upon the selenium varied approximately as the inverse distance of the sheet from the selenium plate, or in other words, as the square root of the light intensity. The same relation has been found by Dr. Werner Siemens and others for considerably stronger light intensities.

In the fourth series of experiments the phosphorescent light was made to pass through differently-coloured sheets of glass before acting on the selenium. It was found that colourless glass transmitted all the active rays. Blue glass transmitted  $\frac{1}{4}$ th of the total amount; green glass transmitted  $\frac{1}{4}$ th; red (almost monochromatic); and yellow glass transmitted no perceptible action.

In the fifth series of experiments the action of the sheet upon the selenium was compared with that of a spermaceti candle, the phosphorescence of the sheet being excited by diffused daylight. Two separate sets of measurements with the standard

<sup>1</sup> This article was sent to us by Dr. Obach in April last.—Ed.

<sup>2</sup> A so-called *Aladdin's lamp* from Messrs. Ibbot and Horne, London.]

candle at different distances ( $2\frac{1}{2}$  and  $3\frac{1}{2}$  metres) from the selenium gave tolerably concordant results when calculated on the supposition that the effect upon the selenium varies as the square root of the light intensity. The influence of about 350 square centimetres of the *luminous sheet* on the selenium was found equal to that of 0.0014 standard candle, or 0.04 standard candle per square metre.

In conclusion I wish to remark that the above must be considered only as preliminary experiments, and the figures given as only approximate. I am now engaged in making further experiments on this subject with the endeavour to obtain more accurate results and to extend these researches, as it seems probable that the sensitive selenium plate may render similar services to the study of phosphorescent light as the thermopile has rendered to the study of radiant heat. EUGEN OBACH

## AGRICULTURAL CHEMISTRY<sup>1</sup>

### II.

IT has been shown that the plant may receive abundance of nitrogen, may produce abundance of chlorophyll, and may be subject to the influence of sufficient light, and yet not assimilate a due amount of carbon. On the other hand, it has been seen that the mineral constituents may be liberally provided, and yet, in the absence of a sufficient supply of nitrogen in an available condition, the deficiency in the assimilation of carbon will be still greater. In fact, assuming all the other necessary conditions to be provided, it was seen that the amount of carbon assimilated depended on the available supply of nitrogen.

In a certain general sense it may be said that the success of the cultivator may be measured by the amount of carbon he succeeds in accumulating in his crops. And as, other conditions being provided, the amount of carbon assimilated depends on the supply of nitrogen in an available form within the reach of the plants, it is obvious that the question of the sources of the nitrogen of vegetation is one of first importance. Are they the same for all descriptions of plants? Are they to be sought entirely in the soil, or entirely in the atmosphere, or partly in the one and partly in the other?

These are questions which Mr. Lawes and myself have discussed so frequently that it might seem some apology was due for recurring to the subject here, especially as I considered it in some of its aspects before this Section at the Sheffield meeting last year. But the subject still remains one of first importance to agriculture, and it could not be omitted from consideration in such a review as I have undertaken to give. Moreover, there are some points connected with it still unsettled, and some still disputed.

It will be remembered that De Saussure's conclusion was that plants did not assimilate the free or uncombined nitrogen of the atmosphere, and that they derived their nitrogen from the compounds of it existing in the atmosphere, and especially in the soil. Liebig, too, concluded that plants do not assimilate nitrogen from the store of it existing in the free or uncombined state, but that ammonia was their main source, and he assumed the amount of it annually coming down in rain to be much more than we now know to be the case.

Referring to our previous papers for full details respecting most of the points in question, I will state, as briefly as I can, the main facts known—first in regard to the amount of the measurable, or as yet measured, annual deposition of combined nitrogen from the atmosphere; and secondly as to the amount of nitrogen annually assimilated over a given area by different crops—so that some judgment may be formed as to whether the measured atmospheric sources are sufficient for the requirements of agricultural production, or whether, or where we must look for other supplies?

First, as to the amount of combined nitrogen coming down as ammonia and nitric acid in the measured aqueous deposits from the atmosphere.

Judging from the results of determinations made many years ago, partly by Mr. Way, and partly by ourselves, in the rain, &c., collected at Rothamsted; from the results of numerous determinations made much more recently by Prof. Frankland in the deposits collected at Rothamsted, and also in rain collected elsewhere; from the results obtained by Boussingault in Alsace; from those of Marié-Davy at the Meteorological Observatory at

Montsouris, Paris; and from those of many others made in France and Germany—we concluded, some years ago, that the amount of combined nitrogen annually so coming down from the atmosphere would not exceed 8 or 10 lbs. per acre per annum in the open country in Western Europe. Subsequent records would lead to the conclusion that this estimate is more probably too high than too low. And here it may be mentioned in passing, that numerous determinations of the nitric acid in the drainage water collected from land at Rothamsted, which had been many years unmanured, indicate that there may be a considerable annual loss by the soil in that way; indeed, probably sometimes much more than the amount estimated to be annually available from the measured aqueous deposits from the atmosphere.

It should be observed, however, that the amount of combined nitrogen, especially of ammonia, is very much greater in a given volume of the minor aqueous deposits than it is in rain; and there can be no doubt that there would be more deposited within the pores of a given area of soil than on an equal area of the non-porous even surface of a rain-gauge. How much, however, might thus be available beyond that determined in the collected and measured aqueous deposits, the existing evidence does not afford the means of estimating with any certainty.

The next point to consider is—What is the amount of nitrogen annually obtained over a given area, in different crops, when they are grown without any supply of it in manure? The field experiments at Rothamsted supply important data relating to this subject.

Thus, over a period of 32 years (up to 1875 inclusive), wheat yielded an average of 20.7 lbs. of nitrogen per acre per annum, without any manure; but the annual yield has declined from an average of more than 25 lbs. over the first 8, to less than 16 lbs. over the last 12, of those 32 years; and the yield (it is true with several bad seasons) has been still less since.

Over a period of 24 years barley yielded 18.3 lbs. of nitrogen per acre per annum, without any manure; with a decline from 22 lbs. over the first twelve, to only 14.6 lbs. over the next 12 years.

With neither wheat nor barley did a complex mineral manure at all materially increase the yield of nitrogen in the crops.

A succession of so-called "root-crops"—common turnips, Swedish turnips, and sugar-beet (with 3 years of barley intervening after the first 8 years)—yielded, with a complex mineral manure, an average of 26.8 lbs. of nitrogen per acre per annum over a period of 31 years. The yield declined from an average of 42 lbs. over the first eight years, to only 13.1 lbs. (in sugar-beet) over the last 5 of the 31 years; but it has risen somewhat during the subsequent 4 years, with a change of crop to mangolds.

With the leguminous crop, beans, there was obtained, over a period of 24 years, 31.3 lbs. of nitrogen per acre per annum without any manure, and 45.5 lbs. with a complex mineral manure, including potash (but without nitrogen). Without manure the yield declined from 48.1 lbs. over the first 12 years to only 14.6 lbs. over the last 12; and with the complex mineral manure it declined from 61.5 lbs. over the first 12, to 29.5 lbs. over the last 12, years of the 24.

Again, an ordinary rotation of crops of turnips, barley, clover, or beans, and wheat, gave, over a period of 28 years, an average of 36.8 lbs. of nitrogen per acre per annum without any manure, and of 45.2 lbs. with superphosphate of lime alone, applied once every four years, that is for the root crop. Both without manure, and with superphosphate of lime alone, there was a considerable decline in the later courses.

A very remarkable instance of nitrogen yield is the following—in which the results obtained when barley succeeds barley that is when one graminaceous crop succeeds another, are contrasted with those when a leguminous crop, clover, intervenes between the two cereal crops. Thus, after the growth of six grain crops in succession by artificial manures alone, the field so treated was divided, and, in 1873, on one half barley, and on the other half clover, was grown. The barley yielded 37.3 lbs. of nitrogen per acre, but the three cuttings of clover yielded 151.3 lbs. In the next year, 1874, barley succeeded on both the barley and the clover portions of the field. Where barley had previously been grown, and had yielded 37.3 lbs. of nitrogen per acre, it now yielded 39.1 lbs.; but where the clover had previously been grown, and had yielded 151.3 lbs. of nitrogen, the barley succeeding it gave 69.4 lbs., or 30.3 lbs. more after the removal of 151.3 lbs. in clover, than after the removal of only 37.3 lbs. in barley.

<sup>1</sup> Opening Address in Section B (Chemical Science), at the Swansea meeting of the British Association, by J. M. Gilbert, Ph.D., F.R.S., V.B.C.S., F.L.S., President of the Section. Continued from p. 476.

Nor was this curious result in any way accidental. It is quite consistent with agricultural experience that the growth and removal of a highly nitrogenous leguminous crop should leave the land in high condition for the growth of a gramineous corn crop, which characteristically requires nitrogenous manuring; and the determinations of nitrogen in numerous samples of the soil taken from the two separate portions of the field, after the removal of the barley and the clover respectively, concurred in showing considerably more nitrogen, especially in the first nine inches of depth, in the samples from the portion where the clover had been grown, than in those from the portion whence the barley had been taken. Here then the surface soil at any rate had been considerably enriched in nitrogen by the growth and removal of a very highly nitrogenous crop.

Lastly, clover has now been grown for twenty-seven years in succession, on a small plot of garden ground which had been under ordinary garden cultivation for probably two or three centuries. In the fourth year after the commencement of the experiment, the soil was found to contain, in its upper layers, about four times as much nitrogen as the farm-arable-land surrounding it; and it would doubtless be correspondingly rich in other constituents. It is estimated that an amount of nitrogen has been removed in the clover crops grown, corresponding to an average of not far short of 200*l.* per acre per annum; or about ten times as much as in the cereal crops, and several times as much as in any of the other crops, growing on ordinary arable land; and, although the yield continues to be very large, there has been a marked decline over the second half of the period compared with the first. Of course, calculations of the produce of a few square yards into quantities per acre can only be approximately correct. But there can at any rate be no doubt whatever that the amount of nitrogen annually removed has been very great; and very far beyond what it would be possible to attain on ordinary arable land; where, indeed, we have not succeeded in getting even a moderate growth of clover for more than a very few years in succession.

One other illustration should be given of the amounts of nitrogen removed from a given area of land by different descriptions of crop, namely, of the results obtained when plants of the gramineous, the leguminous, and other families, are growing together, as in the mixed herbage of grass-land.

It is necessary here to remind you that gramineous crops grown separately on arable land, such as wheat, barley, or oats, contain a comparatively small percentage of nitrogen, and assimilate a comparatively small amount of it over a given area. Yet nitrogenous manures have generally a very striking effect in increasing the growth of such crops. The highly nitrogenous leguminous crops (such as beans and clover), on the other hand, yield, as has been seen, very much more nitrogen over a given area, and yet they are by no means characteristically benefited by direct nitrogenous manuring; whilst, as has been shown, their growth is considerably increased, and they yield considerably more nitrogen over a given area under the influence of purely mineral manures, and especially of potass manures. Bearing these facts in mind, the following results, obtained on the mixed herbage of grass land, will be seen to be quite consistent.

A plot of such mixed herbage, left entirely unmanured, gave over twenty years an average of 33 lbs. of nitrogen per acre per annum. Over the same period another plot, which received annually a complex mineral manure, including potass, during the first six years, but excluding it during the last fourteen years, yielded 46·3 lbs. of nitrogen; whilst another, which received the mixed mineral manure, including potass, every year of the twenty, yielded 55·6 lbs. of nitrogen per acre per annum. Without manure there was some decline of yield in the later years; with the partial mineral manuring there was a greater decline; but with the complete mineral manuring throughout the whole period, there was even some increase in the yield of nitrogen in the later years.

Now, the herbage growing without manure comprised about fifty species, representing about twenty natural families; that growing with the limited supply of potass comprised fewer species, but a larger amount of the produce, especially in the earlier years, consisted of leguminous species, and the yield of nitrogen was greater. Lastly, the plot receiving potass every year yielded still more leguminous herbage, and, accordingly, still more nitrogen.

The most striking points brought out by the foregoing illustrations are the following:—

1. Without nitrogenous manure, the gramineous crops annu-

ally yielded, for many years in succession, much more nitrogen over a given area than is accounted for by the amount of combined nitrogen annually coming down in the measured aqueous deposits from the atmosphere.

2. The root crops yielded more nitrogen than the cereal crops, and the leguminous crops very much more still.

3. In all cases—whether of cereal crops, root crops, leguminous crops, or a rotation of crops—the decline in the annual yield of nitrogen, when none was supplied, was very great.

How are these results to be explained? Whence comes the nitrogen? and especially whence comes the much larger amount taken up by plants of the leguminous and some other families, than by the gramineæ? And lastly, what is the significance of the great decline in the yield of nitrogen in all the crops when none is supplied in the manure?

Many explanations have been offered. It has been assumed that the combined nitrogen annually coming down from the atmosphere is very much larger than we have estimated it, and that it is sufficient for all the requirements of annual growth. It has been supposed that "broad-leaved plants" have the power of taking up nitrogen in some form from the atmosphere, in a degree, or in a manner not possessed by the narrow-leaved gramineæ. It has been argued that, in the last stages of the decomposition of organic matter in the soil, hydrogen is evolved, and that this nascent hydrogen combines with the free nitrogen of the atmosphere, and so forms ammonia. It has been suggested that ozone may be evolved in the oxidation of organic matter in the soil, and that, uniting with free nitrogen, nitric acid would be produced. Lastly, it has by some been concluded that plants assimilate the free nitrogen of the atmosphere, and that some descriptions are able to do this in a greater degree than others.

We have discussed these various points on more than one occasion; and we have given our reasons for concluding that none of the explanations enumerated can be taken as accounting for the facts of growth.

Confining attention here to the question of the assimilation of free nitrogen by plants, it is obvious that, if this were established, most of our difficulties would vanish. This question has been the subject of a great deal of experimental inquiry, from the time that Bous-singault entered upon it, about the year 1837, nearly up to the present time. About twenty years ago it was elaborately investigated at Rothamsted. In publishing the results of that inquiry those of others relating to it were fully discussed; and although the recorded evidence is admittedly very conflicting, we then came to the conclusion, and still adhere to it, that the balance of the direct experimental evidence on the point is decidedly against the supposition of the assimilation of free nitrogen by plants. Indeed, the strongest argument we know of in its favour is, that some such explanation is wanted.

Not only is the balance of direct experimental evidence against the assumption that plants assimilate free or uncombined nitrogen, but it seems to us that the balance of existing indirect evidence is also in favour of another explanation of our difficulties.

I have asked what is the significance of the gradual decline of produce of all the different crops when continuously grown without nitrogenous manure? It cannot be that, in growing the same crop year after year on the same land, there is any residue left in the soil that is injurious to the subsequent growth of the same description of crop; for (excepting the beans) more of each description of crop has been grown year after year on the same land than the average yield of the country at large under ordinary rotation, and ordinary treatment—provided only that suitable soil conditions were supplied. Nor can the diminishing produce, and the diminishing yield of nitrogen, be accounted for on the supposition that there was a deficient supply of available mineral constituents in the soil. For, it has been shown that the cereals yielded little more, and declined nearly as much as without manure, when a complex mineral manure was used, such as was proved to be adequate when available nitrogen was also supplied. So far as the root crops are concerned the yield of nitrogen, though it declined very much, was greater at first, and on the average, than in the case of the cereals. As to the leguminosæ, which require so much nitrogen from somewhere, it is to be observed that on ordinary arable land the yield has not been maintained under any conditions of manuring; and the decline was nearly as marked with mineral manures as without any manure. Compared with the growth of the leguminosæ on arable land, the remarkable result with the garden clover would seem clearly to indicate that the question was one of soil, and

not of atmospheric supply. And the fact that all the other crops will yield full agricultural results even on ordinary arable land, when proper manures are applied, is surely very strong evidence that it is with them, too, a question of soil, and not of atmospheric supply.

But we have other evidence leading to the same conclusion. Unfortunately we have not reliable samples of the soil of the different experimental fields taken at the commencement of each series of experiments, and subsequently at stated intervals. We have nevertheless, in some cases, evidence sufficient to show whether or not the nitrogen of the soil has suffered diminution by the continuous growth of the crop without nitrogenous manure.

Thus we have determined the nitrogen in the soil of the continuously unmanured wheat plot at several successive periods, and the results prove that a gradual reduction in the nitrogen of the soil is going on; and, so far as we are able to form a judgment on the point, the diminution is approximately equal to the nitrogen taken out in crops; and the amount estimated to be received in the annual rainfall is approximately balanced by the amount lost by the land as nitrates in the drainage water.

In the case of the continuous root-crop soil, on which the decline in the yield of nitrogen in the crop was so marked, the percentage of nitrogen, after the experiment had been continued for twenty-seven years, was found to be lower where no nitrogen had been applied than in any other arable land on the farm which has been examined.

In the case of the experiments on the mixed herbage of grass land, the soil of the plot which, under the influence of a mixed mineral manure, including potash, had yielded such a large amount of leguminous herbage and such a large amount of nitrogen, showed, after twenty years, a considerably lower percentage of nitrogen than that of any other plot in the series.

Lastly, determinations of nitrogen in the garden soil which has yielded so much nitrogen in clover, made in samples collected in the fourth and the twenty-sixth years of the twenty-seven of the experiments, show a very large diminution in the percentage of nitrogen. The diminution, to the depth of 9 inches, only represents approximately three-fourths as much as the amount estimated to be taken out in the clover during the intervening period; and the indication is that there has been a considerable reduction in the lower depths also. It is to be supposed however that there would be loss in other ways than by the crop alone.

I would ask, Have we not in these facts—that full amounts of the different crops can be grown, provided proper soil conditions are supplied; that without nitrogenous manure the yield of nitrogen in the crop rapidly declines; and that, coincidentally with this, there is a decline in the percentage of nitrogen in the soil—have we not in these facts cumulative evidence pointing to the soil, rather than to the atmosphere, as the source of the nitrogen of our crops?

In reference to this point I may mention that the ordinary arable soil at Rothamsted may be estimated to contain about 3,000 lbs. of nitrogen per acre in the first nine inches of depth, about 1,700 lbs. in the second nine inches, and about 1,500 lbs. in the third nine inches—or a total of about 6,200 lbs. per acre to the depth of twenty-seven inches.

In this connection it is of interest to state that a sample of Oxford clay obtained in the sub-Wealden exploration boring, at a depth of between 500 and 600 feet (and which was kindly given to me by the President of the Association, Prof. Ramsay, some years ago), showed, on analysis at Rothamsted, approximately the same percentage of nitrogen as the subsoil at Rothamsted taken to the depth of about 4 feet only.

Lastly, in a letter received from Boussingault some years ago, referring to the sources whence the nitrogen of vegetation is derived, he says:—

“From the atmosphere, because it furnishes ammonia in the form of carbonate, nitrates, or nitrites, and various kinds of dust. Theodore de Saussure was the first to demonstrate the presence of ammonia in the air, and consequently in meteoric waters. Liebig exaggerated the influence of this ammonia on vegetation, since he went so far as to deny the utility of the nitrogen which forms a part of farmyard manure. This influence is nevertheless real, and comprised within limits which have quite recently been indicated in the remarkable investigations of M. Schlösing.

“From the soil, which, besides furnishing the crops with mineral alkaline substances, provides them with nitrogen, by ammonia, and by nitrates, which are formed in the soil at the

expense of the nitrogenous matters contained in diluvium, which is the basis of vegetable earth; compounds in which nitrogen exists in stable combination, only becoming fertilising by the effect of time. If we take into account their immensity, the deposits of the last geological periods must be considered as an inexhaustible reserve of fertilising agents. Forests, prairies, and some vineyards, have really no other manures than what are furnished by the atmosphere and by the soil. Since the basis of all cultivated land contains materials capable of giving rise to nitrogenous combinations, and to mineral substances, assimilable by plants, it is not necessary to suppose that in a system of cultivation the excess of nitrogen found in the crops is derived from the free nitrogen of the atmosphere. As for the absorption of the gaseous nitrogen of the air by vegetable earth, I am not acquainted with a single irreproachable observation that establishes it; not only does the earth not absorb gaseous nitrogen, but it gives it off, as you have observed in conjunction with Mr. Lawes, as Reiset has shown in the case of dung, as M. Schlösing and I have proved in our researches on nitrification.

“If there is one fact perfectly demonstrated in physiology it is this of the non-assimilation of free nitrogen by plants; and I may add by plants of an inferior order, such as mycodermis and mushrooms (translation).”

If, then, our soils are subject to a continual loss of nitrogen by drainage, probably in many cases more than they receive of combined nitrogen from the atmosphere—if the nitrogen of our crops is derived mainly from the soil, and not from the atmosphere—and if, when due return is not made from without, we are drawing upon what may be termed the store of nitrogen of the soil itself—is there not, in the case of many soils at any rate, as much danger of the exhaustion of their available nitrogen as there has been supposed to be of the exhaustion of their available mineral constituents?

I had hoped to say something more about soils to advance our knowledge respecting which an immense amount of investigation has been devoted of late years, but in regard to which we have yet very much more to learn. I must however now turn to other matters.

(To be continued.)

#### IMPROVED HELIOGRAPH OR SUN SIGNAL<sup>1</sup>

THE author claims to have contrived a heliograph, or sun telegraph, by which the rays of the sun can be directed on any given point with greater ease and certainty than by those at present in use.

When the sun's rays are reflected at a small plane surface considered as a point, the reflected rays form a cone, whose vertex is at the reflector and whose vertical angle is equal to that subtended by the sun. Adding to the size of the mirror adds other cones of light, whose bounding rays are parallel with those proceeding from other points of the mirror, and only distant from them the same distance as the points on the mirror from which they are reflected. Hence increasing the size of the mirror only adds to the field to which the sun's rays are reflected a diameter equal to the diameter of the mirror, and this at any distance at which the sun signal would be used is quite inappreciable. Adding to the size of the mirror adds to the number of rays sent to each point, and hence to the brightness of the visible flash, but not to the area over which it is visible.

By the author's plan an ordinary field-glass is used to find the position of the object to be signalled to, and to it is attached, in the position of the ordinary sun-shade, a small and light apparatus, so arranged that when the mirror is turned to direct the cone of rays to any object within the field view of the glass, an image of the sun appears in the field, at the same time as the image of the distant object, and magnified to the same degree, and the part of the field covered by this image is exactly that part to which the rays are reflected, and at which some part of the sun's disk is visible in the mirror.

A perfectly plane silvered mirror, *A*, takes up the rays of the sun, and when in proper position reflects them parallel with the axis of *D*, which is one barrel of an ordinary field-glass. The greater part of the light passes away to the distant object, but some is taken up by the small silvered mirror, *E*, which is placed at an angle of 45° to the axis of *D*, and reflected at a right angle through the unsilvered plane mirror, *F*, and the convex lens, *K*, by which it is brought to a focus on the white

<sup>1</sup> Paper read at the British Association by Tempest Anderson, M.D., B.Sc.



screen, *H*, which is placed in the principal focus of *K*. The rays from this image diverge in all directions, and some are taken up by the lens *K* and restored to parallelism; some of these are reflected by the unsilvered mirror, *F*, down to the field-glass, *D*, and if this is focussed for parallel rays, as is the case in looking at distant objects, an image of the sun is seen projected on the same field of view as that of the distant object. As the mirrors *E* and *F* are adjusted strictly parallel, the rays proceeding from *F* into the field-glass are parallel and in the opposite direction to those going from the mirror *A* to *E*, which form part of the same pencil as those going to the distant object. Hence the image of the sun seen in the field exactly covers the object to which the sun-flash is visible, and in whatever direction the mirror *A* is moved so as to alter the direction in which rays are reflected to the distant object, and the angle at which part impinge on *E* and are reflected through the lens *K*, the image visible in the glass moves in the same direction. Several attempts to produce this result were made by the use of mirrors and prisms, before the lens *K* was introduced, but they all failed. It was easy to make the image of the sun cover the object when the two occupied the centre of the field of view, but directly the mirror was inclined so as to direct the rays not strictly parallel to the axis of the field-glass, the apparent image diverged generally in the same direction along one co-ordinate, and in the opposite along one at right angles to it, so that nowhere, but in one line across the field, did the image lie in the desired position. The mirrors *E* and *F* are adjusted parallel once for all, by noticing the position on a screen of the small

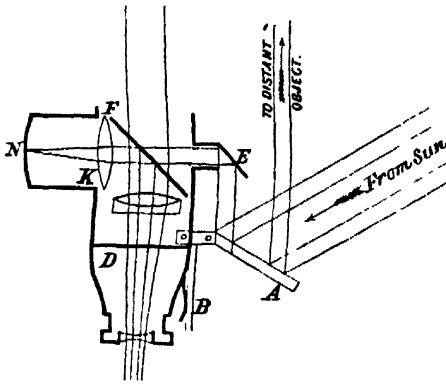

spot of light reflected from the front of *F* as the light passes from *E* to *K*. The mirrors are moved by the adjusting screws till this spot has, to the bright reflection from the mirror *A*, the same relative position that the centre of mirror *F* has to the mirror *A*.

In actual use the field-glass is first fixed in position pointing to the object, either by holding steadily in the hand, or better by a clamp attached, by which it can be screwed into a tree or post, or fixed in the muzzle of a rifle. The instrument is turned on the barrel of the glass till the sun is in the plane passing through the two axes of the instrument, and the mirror *A* is turned till the bright image of the sun is seen on the screen *H*, through a hole left for the purpose in the side of the tube. On looking through the glass the sun's image is seen, and by then slightly rotating the instrument or moving the mirror, is made to cover the object. The mirror *A* is connected not directly to the body of the instrument, but to a lever *B*, on which it works stiffly, so as to retain any position in which it is placed. Lever *B* works easily and has a limited range of motion, to one end of which it is pressed by a spring; slight pressure with the finger moves it and its attached mirror, so as to throw the light on and off the object in a succession of long and short flashes by which letters and words may be indicated. Flashes may also be given by moving the instrument if held in the hand.

The above instrument answers well for all positions of the sun except when very low behind the observer's back. For this case another mirror is provided by which the light is reflected on to the mirror *A*.

The instrument, which is made by Cook and Sons, York, was exhibited. It was favourably criticised by the president, Prof. W. G. Adams, F. Galton, and others.

## SELENIUM AND THE PHOTOPHONE

IN bringing before you some discoveries made by Mr. Sumner Tainter and myself, which have resulted in the construction of apparatus for the production and reproduction of sound by means of light, it is necessary to explain the state of knowledge which formed the starting point of our experiments. I shall first describe the remarkable substance selenium, and the manipulations devised by various experiments; but the final result of our researches has evidenced the class of substances sensitive to light vibrations, until we can propound the fact of sensitiveness being a general property of all matter. We have found this property in gold, silver, platinum, iron, steel, brass, copper, zinc, lead, antimony, German silver, Jenkin's metal, Babbitt's metal, ivory, celluloid, gutta-percha, hard rubber, soft vulcanised rubber, paper, parchment, wood, mica, and silvered glass; and the only substances from which we have not obtained results are carbon and thin microscopic glass. We find that when a vibratory beam of light falls upon these substances they emit sounds—the pitch of which depends upon the frequency of the vibratory change in the light. We find further that, when we control the form or character of the light-vibration on selenium, and probably on the other substances, we control the quality of the sound and obtain all varieties of articulate speech. We can thus, without a conducting wire as in electric telephony, speak from station to station, wherever we can project a beam of light. We have not had opportunity of testing the limit to which this photophonic influence can be extended, but we have spoken to and from points 213 metres apart; and there seems no reason to doubt that the results will be obtained at whatever distance a beam of light can be flashed from one observatory to another. The necessary privacy of our experiments hitherto has alone prevented any attempts at determining the extreme distance at which this new method of vocal communication will be available. I shall now speak of selenium.

In the year 1817 Berzelius and Gottlieb Gahn made an examination of the method of preparing sulphuric acid in use at Gripsholm. During the course of this examination, they observed in the acid a sediment of a partly reddish, partly clear brown colour, which, under the action of the blowpipe, gave out a peculiar odour, like that attributed by Klaproth to tellurium. As tellurium was a substance of extreme rarity, Berzelius attempted its production from this deposit; but he was unable, after many experiments, to obtain further indications of its presence. He found plentiful signs of sulphur mixed with mercury, copper, zinc, iron, arsenic, and lead, but no trace of tellurium. It was not in the nature of Berzelius to be disheartened by this result. In science every failure advances the boundary of knowledge as well as every success, and Berzelius felt that, if the characteristic odour that had been observed did not proceed from tellurium, it might possibly indicate the presence of some substance then unknown to the chemist. Urged on by this hope he returned with renewed ardour to his work. He collected a great quantity of the material, and submitted the whole mass to various chemical processes. He succeeded in separating successively the sulphur, the mercury, the copper, the tin, and the other known substances whose presence had been indicated by his tests; and, after all these had been eliminated, there still remained a residue which proved upon examination to be what he had been in search of—a new elementary substance. The chemical properties of this new element were found to resemble those of tellurium in so remarkable a degree, that Berzelius gave to the substance the name of "Selenium," from the Greek word *selene*, the moon ("tellurium," as is well known, being derived from *tellus*, the earth).

Although tellurium and selenium are alike in many respects, they differ in their electrical properties, tellurium being a good conductor of electricity, and selenium, as Berzelius showed, a non-conductor. Knox discovered, in 1837, that selenium became a conductor when fused; and Hittorf, in 1852, showed that it conducted, at ordinary temperatures, when in one of its allotropic forms. When selenium is rapidly cooled from a fused condition it is a non-conductor. In this its vitreous form it is of a dark brown colour, almost black by reflected light, having an exceedingly brilliant surface. In thin films it is transparent, and appears of a beautiful ruby red by transmitted light. When selenium is cooled from a fused condition with extreme slowness it presents an entirely different appearance, being of a dull lead

\* Lecture delivered at the Boston meeting of the American Association by Prof. A. Graham Bell.

colour, and having throughout a granulated or crystalline structure, and looking like a metal. In this form it is perfectly opaque to light, even in very thin films. This variety of selenium has long been known as "granular" or "crystalline" selenium, or, as Regnault called it, "metallic" selenium. It was selenium of this kind that Hittorff found to be a conductor of electricity at ordinary temperatures. He also found that its resistance to the passage of an electrical current diminished continuously by heating up to the point of fusion, and that the resistance suddenly increased in passing from the solid to the liquid condition. It was early discovered that exposure to sunlight hastens the change of selenium from one allotropic form to another; and this observation is significant in the light of recent discoveries.

Although selenium has been known for the last sixty years, it has not yet been utilised to any extent in the arts, and it is still considered simply as a chemical curiosity. It is usually supplied in the form of cylindrical bars. These bars are sometimes found to be in the metallic condition; but more usually they are in the vitreous or non-conducting form. It occurred to Willoughby Smith that, on account of the high resistance of crystalline selenium, it might be usefully employed at the shore end of a submarine cable, in his system of testing and signalling during the process of submersion. Upon experiment, the selenium was found to have all the resistance required—some of the bars employed measuring as much as 1,400 megohms—a resistance equivalent to that which would be offered by a telegraph wire long enough to reach from the earth to the sun! But the resistance was found to be extremely variable. Experiments were made to ascertain the cause of this variability. Mr. May, Mr. Willoughby Smith's assistant, discovered that the resistance was less when the selenium was exposed to light than when it was in the dark.

In order to be certain that temperature had nothing to do with the effect, the selenium was placed in a vessel of water, so that the light had to pass through from 1 in. to 2 in. of water in order to reach the selenium. The approach of a lighted candle was found to be sufficient to cause a marked deflection of the needle of the galvanometer connected with the selenium, and the lighting of a piece of magnesium wire caused the selenium to measure less than half the resistance it did the moment before.

These results were naturally at first received by scientific men with some incredulity, but they were verified by Sale, Draper, Moss, and others. When selenium is exposed to the action of the solar spectrum, the maximum effect is produced, according to Sale, just outside the red end of the spectrum, in a point nearly coincident with the maximum of the heat rays; but, according to Adams, the maximum effect is produced in the greenish-yellow or most luminous part of the spectrum. Lord Rosse exposed selenium to the action of non-luminous radiations from hot bodies, but could produce no effect; whereas a thermopile under similar circumstances gave abundant indications of a current. He also cut off the heat rays from luminous bodies by the interposition of liquid solutions, such as alum, between the selenium and the source of light, without affecting the power of the light to reduce the resistance of the selenium; whereas the interposition of these same substances almost completely neutralized the effect upon the thermopile. Adams found that selenium was sensitive to the cold light of the moon, and Werner Siemens discovered that, in certain extremely sensitive varieties of selenium, heat and light produced opposite effects. In Siemens' experiments, special arrangements were made for the purpose of reducing the resistance of the selenium employed. Two fine platinum wires were coiled together in the shape of a double flat spiral in the zig-zag shape, and were laid upon a plate of mica so that the discs did not touch one another. A drop of melted selenium was then placed upon the platinum wire arrangement, and a second sheet of mica was pressed upon the selenium, so as to cause it to spread out and fill the spaces between the wires. Each cell was about the size of a silver dime. The selenium cells were then placed in a paraffine bath, and exposed for some hours to a temperature of 210 deg. C., after which they were allowed to cool with extreme slowness. The results obtained with these cells were very extraordinary; in some cases the resistance of the cells, when exposed to light, was only one-fifteenth of their resistance in the dark.

Without dwelling farther upon the researches of others, I may say that the chief information concerning the effect of light upon the conductivity of selenium will be found under the

names of Willoughby Smith, Lieutenant Sale, Draper and Moss, Professor W. G. Adams, Lord Rosse, Day, Sabini, Dr. Werner Siemens, and Dr. C. W. Siemens. All observations by these various authors had been made by means of galvanometers; but it occurred to me that the telephone, from its extreme sensitiveness to electrical influences, might be substituted with advantage. Upon consideration of the subject, however, I saw that the experiments could not be conducted in the ordinary way for the following reason:—The law of audibility of the telephone is precisely analogous to the law of electric induction. No effect is produced during the passage of a continuous and steady current. It is only at the moment of change from a stronger to a weaker state, or *vice versa*, that any audible effect is proposed, and the amount of effect is exactly proportional to the amount of variation in the current. It was, therefore, evident that the telephone could only respond to the effect produced in selenium at the moment of change from light to darkness, or *vice versa*, and that it would be advisable to intermit the light with great rapidity, so as to produce a succession of changes in the conductivity of the selenium, corresponding in frequency to musical vibrations within the limits of the sense of hearing. For I had often noticed that currents of electricity, so feeble as to produce scarcely any audible effects from a telephone when the circuit was simply opened or closed, caused very perceptible musical sounds when the circuit was rapidly interrupted, and that the higher the pitch of sound the more audible was the effect. I was much struck by the idea of producing sound by the action of light in this way. Upon farther consideration it appeared to me that all the audible effects obtained from varieties of electricity could also be produced by variations of light acting upon selenium. I saw that the effect could be produced at the extreme distance at which selenium would respond to the action of a luminous body, but that this distance could be indefinitely increased by the use of a parallel beam of light, so that we could telephone from one place to another without the necessity of a conducting wire between the transmitter and receiver. It was evidently necessary, in order to reduce this idea to practice, to devise an apparatus to be operated by the voice of a speaker, by which variations could be produced in a parallel beam of light, corresponding to the variations in the air produced by the voice.

I proposed to pass light through a large number of small orifices, which might be of any convenient shape, but were preferably in the form of slits. Two similarly perforated plates were to be employed. One was to be fixed and the other attached to the centre of a diaphragm actuated by the voice, so that the vibration of the diaphragm would cause the movable plate to slide to and fro over the surface of the fixed plate, thus alternately enlarging and contracting the free orifices for the passage of light. In this way the voice of a speaker could control the amount of light passed through the perforated plates without completely obstructing its passage. This apparatus was to be placed in the path of a parallel beam of light, and the undulatory beam emerging from the apparatus could be received at some distant place upon a lens, or other apparatus, by means of which it could be condensed upon a sensitive piece of selenium placed in a local circuit with a telephone and galvanic battery. The variations in the light produced by the voice of the speaker should cause corresponding variations in the electrical resistance of the selenium employed; and the telephone in circuit with it should reproduce audibly the tones and articulations of the speaker's voice. I obtained some selenium for the purpose of producing the apparatus shown, but found that its resistance was almost infinitely greater than that of any telephone that had been constructed, and I was unable to obtain any audible effects by the action of light. I believed, however, that the obstacle could be overcome by devising mechanical arrangements for reducing the resistance of the selenium, and by constructing special telephones for the purpose. I felt so much confidence in this that, in a lecture delivered before the Royal Institute of Great Britain, upon May 17, 1878, I announced the possibility of hearing a shadow by interrupting the action of light upon selenium. A few days afterwards my ideas upon this subject received a fresh impetus by the announcement made by Mr. Willoughby Smith before the Society of Telegraph Engineers that he had heard the action of a ray of light falling upon a bar of crystalline selenium, by listening to a telephone in circuit with it.

It is not unlikely that the publicity given to the speaking telephone during the last few years may have suggested to many

minds in different parts of the world somewhat similar ideas to my own.

Although the idea of producing and reproducing sound by the action of light, as described above, was an entirely original and independent conception of my own, I recognise the fact that the knowledge necessary for its conception has been disseminated throughout the civilised world, and that the idea may therefore have occurred to many other minds. *The fundamental idea, on which rests the possibility of producing speech by the action of light, is the conception of what may be termed an undulatory beam of light in contradistinction to a merely intermittent one.* By an undulatory beam of light, I mean a beam that shines continuously upon the selenium receiver, but the intensity of which upon that receiver is subject to rapid changes, corresponding to the changes in the vibratory movement of a particle of air during the transmission of a sound of definite quality through the atmosphere. The curve that would graphically represent the changes of light would be similar in shape to that representing the movement of the air. I do not know whether this conception had been clearly realised by "J. F. W.," of Kew, or by Mr. Sargeant, of Philadelphia; but to Mr. David Brown, of London, is undoubtedly due the honour of having distinctly and independently formulated the conception, and of having devised apparatus—though of a crude nature—for carrying it into execution. It is greatly due to the genius and perseverance of my friend, Mr. Sumner Tainter, of Watertown, Mass., that the problem of producing and reproducing sound by the agency of light has at last been successfully solved. The first point to which we devoted our attention was the reduction of the resistance of crystalline selenium within manageable limits. The resistance of selenium cells employed by former experimenters was measured in millions of ohms, and we do not know of any record of a selenium cell measuring less than 250,000 ohms in the dark. *We have succeeded in producing sensitive selenium cells measuring only 300 ohms in the dark, and 155 ohms in the light.* All former experimenters seem to have used platinum for the conducting part of their selenium cells, excepting Werner Siemens, who found that iron and copper might be employed. We have also discovered that brass, although chemically acted upon by selenium, forms an excellent and convenient material; indeed, we are inclined to believe that the chemical action between the brass and selenium has contributed to the low resistance of our cells by forming an intimate bond of union between the selenium and brass. We have observed that melted selenium behaves to the other substances as water to a greasy surface, and we are inclined to think that when selenium is used in connection with metals not chemically acted upon by it, the points of contact between selenium and the metal offer a considerable amount of resistance to the passage of a galvanic current. By using brass we have been enabled to construct a large number of selenium cells of different forms. The mode of applying the selenium is as follows:—The cell is heated, and, when hot enough, a stick of selenium is rubbed over the surface. In order to acquire conductivity and sensitiveness, the selenium must next undergo a process of annealing.

We simply heat the selenium over a gas stove and observe its appearance. When the selenium attains a certain temperature, the beautiful reflecting surface becomes dimmed. A cloudiness gradually extends over it, somewhat like the film of moisture produced by breathing upon a mirror. This appearance gradually increases, and the whole surface is soon seen to be in the metallic, granular, or crystalline condition. The cell may then be taken off the stove, and cooled in any suitable way. When the heating process is carried too far, the crytalline selenium is seen to melt. Our best results have been obtained by heating the selenium until it crystallises, and continuing the heating until signs of melting appear, when the gas is immediately put out. The portions that had melted instantly recrystallise, and the selenium is found upon cooling to be a conductor, and to be sensitive to light. The whole operation occupies only a few minutes. This method has not only the advantage of being expeditious, but it proves that many of the accepted theories on this subject are fallacious. Our new method shows that fusion is unnecessary, that conductivity and sensitiveness can be produced without long heating and slow cooling; and that crystallisation takes place during the heating process. We have found that on removing the source of heat immediately on the appearance of the cloudiness, distinct and separate crystals can be observed under the microscope, which appear like leaden snow-flakes on a ground of ruby red. Upon removing the heat,

when crystallisation is further advanced, we perceive under the microscope masses of these crystals arranged like basaltic columns standing detached from one another, and at a still higher point of heating the distinct columns are no longer traceable, but the whole mass resembles metallic pudding-stone, with here and there a separate snow-flake, like a fossil, on the surface. Selenium crystals formed during slow cooling after fusion present an entirely different appearance, showing distinct facets.

We have devised about fifty forms of apparatus for varying a beam of light in the manner required, but only a few typical varieties need be shown. The source of light may be controlled, or a steady beam may be modified at any point in its path. The beam may be controlled in many ways. For instance, it may be polarised, and then affected by electrical or magnetic influences in the manner discovered by Faraday and Dr. Kerr. The beam of polarised light, instead of being passed through a liquid, may be reflected from the polished pole of an electro-magnet. Another method of affecting a beam of light is to pass it through a lens of variable focus. I observe that a lens of this kind has been invented in France by Dr. Cusco, and is fully described in a recent paper in *La Nature*; but Mr. Tainter and I have used such a lens in our experiments for months past. The best and simplest form of apparatus for producing the effect remains to be described. This consists of a plane mirror of flexible material—such as silvered mica or microscope glass. Against the back of this mirror the speaker's voice is directed. The light reflected from this mirror is thus thrown into vibrations corresponding to those of the diaphragm itself.

In arranging the apparatus for the purpose of reproducing sound at a distance any powerful source of light may be used, but we have experimented chiefly with sunlight. For this purpose a large beam is concentrated by means of a lens upon the diaphragm mirror, and, after reflection, is again rendered parallel by means of another lens. The beam is received at a distant station upon a parabolic reflector, in the focus of which is placed a sensitive selenium cell, connected in a local circuit with a battery and telephone. A large number of trials of this apparatus have been made with the transmitting and receiving instruments so far apart that sounds could not be heard directly through the air. In illustration I shall describe one of the most recent of these experiments. Mr. Tainter operated the transmitting instrument, which was placed on the top of the Franklin schoolhouse in Washington, and the sensitive receiver was arranged in one of the windows of my laboratory, 1325 L street, at a distance of 213 metres. Upon placing the telephone to my ear I heard distinctly from the illuminated receiver the words: "Mr. Bell, if you hear what I say come to the window and wave your hat." In laboratory experiment the transmitting and receiving instruments are necessarily within earshot of one another, and we have, therefore, been accustomed to pooling the electric circuit connected with the selenium receiver, so as to place the telephones in another room. By such experiments we have found that articulate speech can be reproduced by the oxyhydrogen light, and even by the light of a kerosene lamp. The loudest effects obtained from light are produced by rapidly interrupting the beam by the perforated disk. The great advantage of this form of apparatus for experimental work is the noiselessness of its rotation, admitting the close approach of the receiver without interfering with the audibility of the effect heard from the latter; for it will be understood that musical tones are emitted from the receiver when no sound is made at the transmitter. A silent motion thus produces a sound. In this way musical tones have been heard even from the light of a candle. When distant effects are sought another apparatus is used. By placing an opaque screen near the rotating disk the beam can be entirely cut off by a slight motion of the hand, and musical signals, like the dots and dashes of the Morse telegraph code, can thus be produced at the distant receiving station.

We have made experiments, with the object of ascertaining the nature of the rays that affect selenium. For this purpose we have placed in the path of an intermittent beam various absorbing substances. Prof. Cross has been kind enough to give me his assistance in conducting these experiments. When a solution of alum or bisulphide of carbon, is employed, the loudness of the sound produced by the intermittent beam is very slightly diminished; but a solution of iodine in bisulphide of carbon cuts off most, but not all, of the audible effect. Even an apparently opaque sheet of hard rubber does not entirely do this. When the sheet of hard rubber was held near the disk interrupter the

rotation of the disk interrupted what was then an invisible beam, which passed over a space of about twelve feet before it reached the lens which finally concentrated it upon the selenium cell. A faint but perfectly perceptible musical tone was heard from the telephone connected with the selenium. This could be interrupted at will by placing the hand in the path of the invisible beam. It would be premature, without further experiments, to speculate too much concerning the nature of these invisible rays; but it is difficult to believe that they can be bent rays, as the effect is produced through two sheets of hard rubber containing between them a saturated solution of alum. Although effects are produced as above shown by forms of radiant energy which are invisible, we have named the apparatus for the production and reproduction of sound in this way "the photophone," because an ordinary beam of light contains the rays which are operative.

It is a well-known fact that the molecular disturbance produced in a mass of iron by the magnetising influence of intermittent electrical current can be observed as sound by placing the ear in close contact with the iron. It occurred to us that the molecular disturbance produced in crystalline selenium by the action of an intermittent beam of light should be audible in a similar manner without the aid of a telephone or battery. Many experiments were made to verify this theory without definite results. The anomalous behaviour of the hard rubber screen suggested the thought of listening to it also. This experiment was tried with extraordinary success. I held the sheet in close contact with my ear, while a beam of intermittent light was focussed upon it by a lens. A distinct musical note was immediately heard. We found the effect intensified by arranging the sheet of hard rubber as a diaphragm, and listening through a hearing-tube. We then tried the crystalline selenium in the form of a thin disk, and obtained a similar, but less intense effect. The other substances which I enumerated at the beginning of my address were now successively tried in the form of thin disks, and sounds were obtained from all but carbon and thin glass. We found hard rubber to produce a louder sound than any other substance we tried, excepting antimony, and paper and mica to produce the weakest sounds. On the whole we feel warranted in announcing as our conclusion that sounds can be produced by the action of a variable light from substances of all kinds, when in the form of thin diaphragms. We have heard from interrupted sunlight very perceptible musical tones through tubes of ordinary vulcanised rubber, of brass, and of wood. These were all the materials at hand in tubular form, and we have had no opportunity since of extending these observations to other substances.

I am extremely glad that I have the opportunity of making the first publication of these researches before a scientific society, for it is from scientific men that my work of the last six years has received its earliest and kindest recognition. I gratefully remember the encouragement which I received from the late Prof. Henry at a time when the speaking telephone existed only in the theory. Indeed, it is greatly due to the stimulus of his appreciation that the telephone became an accomplished fact. I cannot state too highly also the advantage I received in preliminary experiments on sound vibrations in this building from Prof. Cross, and near here from my valued friend Dr. Clarence J. Blake. When the public were incredulous of the possibility of electrical speech, the American Academy of Arts and Sciences, the Philosophical Society of Washington, and the Essex Institute of Salem, recognised the reality of the results and honoured me by their congratulations. The public interest, I think, was first awakened by the judgment of the very eminent scientific men before whom the telephone was exhibited in Philadelphia, and by the address of Sir William Thomson before the British Association for the Advancement of Science.

At a later period, when even practical telegraphists considered the telephone as a mere scientific toy, Prof. John Peirce, Prof. Eli W. Blake, Dr. Channing, Mr. Clarke, and Mr. Jones, of Providence, Rhode Island, devoted themselves to a series of experiments for the purpose of assisting me in making the telephone of practical utility; and they communicated to me from time to time the result of their experiments with a kindness and generosity I can never forget. It is not only pleasant to remember these things, and to speak of them, but it is a duty to repeat them, as they give a practical refutation to the often repeated stories of the blindness of scientific men to unaccustomed novelties, and of their jealousy of unknown inventors who dare to enter the charmed circle of science. I trust that the scientific favour which was so readily accorded to the telephone may be extended by you to this new claimant—the photophone.

## SCIENTIFIC SERIALS

THE *Quarterly Journal of Microscopical Science*, July, contains—F. M. Balfour, on the structure and homologues of the germinal layers of the embryo (with woodcuts).—On Hübner's researches on the nervous system of nemertines (with a plate) abstract of.—A. G. Bourne, on the structure of the nephridia of the medicinal leech (with two plates).—Prof. Ray Lankester, on intra-epithelial capillaries in the integument of the medicinal leech (with a plate); and on the connective and vasifactive tissues of the same (with two plates).—Dr. H. Gibbes, on the use of the Wenham binocular with high powers.—On the structure of the spermatozoon.—P. H. Carpenter, on some disputed points in Echinoderm morphology.—Prof. Pouchet, on the origin of the red-blood corpuscles (translated from the *Revue Scientifique*).—Prof. Ray Lankester, on *Limnocoedium sowerbii*, a new trachomedusa inhabiting fresh water (with woodcuts and two plates) [for an abstract *vide* NATURE, vol. xxii, p. 147].—Notes and memoranda.—*Proceedings of the Dublin Microscopical Club for November and December, 1879.*

† *Revue d'Anthropologie*, tome iii, fascic. 3 (July).—Prof. J. Delbos, of Nancy, gives a brief report of the discovery, made in 1869, of a number of human skeletons in the loam beds of Bollwiller (Haut-Rhin). His paper, which describes the general geognostic character of the soil in which these remains were found, is followed by a detailed description, by Dr. René Collignon, of each of the seven distinct skeletons that have been recovered. Of these, five were adult males, two females, and one a child of about seven. In general characteristics they resemble the Cannstatt remains.—Dr. Brénger-Féraud, whose position in Senegal as Médecin-en-chef de la Marine gave him favourable opportunities of studying the habits of the natives, has drawn up an interesting report of all that is known on the spot in regard to the mysterious sect of the Simos, which exercises an important influence on the tribes of the west coasts of Africa, from Cape Vert as far as the Gabon settlements on the equator. The Simo of these regions is the dreaded Mombombo of other races.—Dr. Gustave Lagneau's paper, "De quelques Dates reculées," is a scholarly dissertation on the community of race traceable in the Belgæ, Galli, and Germani, and on the evidence supplied in reference to the period of their immigration into Celtic lands by the introduction of a dolichocephalic character, in addition to the purely brachycephalic type observable in the skulls of Celtic and Kimmerian races. In discussing the question of the occupation of Western Europe by Iberians, M. Lagneau enters at length into the historical and anthropological grounds for accepting the testimony of Plato and others as to the defeat of those tribes by a powerful race, the Atlantes, and the existence of a great western continent, or archipelago, the submerged Atlantis, from which the latter peoples made their inroads on West Africa and West Europe.—M. Martinet's enumeration of the prehistoric monuments of Berry deserves special notice for the interesting information it supplies in reference to the so-called "Mardelles," a kind of conically shaped excavations, the purport of which has not been determined, and which, although found elsewhere, as in Normandy, Provence, &c., is of exceptional frequency in Berry, where between 300 and 400 have been explored. In diameter they vary from 20 to 100 metres, in depth from 50 centimetres to 8 metres. Traces of ashes, calcined animal bones, and coarse potsherds, with a few broken flints, have been found at the bottom of these depressions, of which several are generally ranged in a line near natural or artificially constructed caverns.

*Journal de Physique*, August.—Experimental researches on rotatory polarisation in gases, by M. H. Becquerel.—Magnetic rotatory power of liquids and of their vapours, by M. Bichat.—Experiments on flames, by M. Neyreneuf.

*Journal of the Franklin Institute*, August.—The limitations of the steam-engine, by W. D. Marks.—Economic cut-off in steam-engines, by S. W. Robinson.—The involute of the circumference of a circle, by J. J. Skinner.—Holman's new compressorium and moist chamber, by J. A. Ryder.

*Rivista Scientifico-Industriale*, No. 15, August 15.—Periodic spontaneous movement of the stamens of *Ruta bracteosa*, D.C., and of *Smyrnum rotundifolium*, by Dr. Macchiati.—Synthesis of meteorological observations in Modica and Syracuse on the fall of meteoric powders, from the end of 1876 to April 16, 1880, by Prof. Lancetta.

No. 16, August 31.—On types of rocks, by Prof. de Stefani.

—New apparatus for the electric light.—Parallelogram of forces, by Prof. Lancetta.—Further contributions to the Aphides of Sardinia; description of three new species, by Prof. Macchiati.

*Atti della R. Accademia dei Lincei*, June.—On an apparatus for determining the mechanical equivalent of heat, by Dr. Bartoli.—On the laws of galvanic polarisation, by the same.—On a human skeleton of the age of stone in the Roman province, by Dr. Incoronato.—Liassic limestone of Gozzano, and its fossils, by Dr. Parona.—Works on the Tiber, and varied conditions of the Roman land, by S. Ponzi.—Reply to S. Ferrari's observations (relating to anomalous induction of a magnetic declinometer), by Prof. Keller.—On the mechanism of movements of the iris, by S. Morizzia.—On some derivatives of natural and synthetic thymol, by Professors Paterno and Canzonesi.—Analysis of an augite of Lazio, by Dr. Piccini.—Chemical researches on the lava of Montecompatri, &c., by Dr. Mauro.—On the hæmopoetic function, by SS. Tizzoni and Fileti.—On the diffusion of the metals of cerite, by S. Cossa.—On tungstate of didymium, by the same.—On a proposition of Jacobi, by S. Siacci.—On a class of differential equations integrable by elliptic functions, by S. Brioschi.—Verification and use of a new formula for calculation of planetary perturbations, by S. De Gasparis.

*Rendiconto delle Sessioni dell'Accademia delle Scienze dell'Istituto di Bologna*, 1879–80.—We note here the following:—On the placenta of cartilaginous fishes and mammals, and its applications in zoological taxonomy and anthropology, by Prof. Ercolani.—Variations of human temperature resulting from bodily movements, by Prof. Villari.—Dimensions of the electric spark of condensers, by the same.—On variation of length due to magnetism, by Prof. Righi.—On some products of decomposition of albumen at the temperature of the human body, and at slightly lower temperatures, by Prof. Selmi.—On the singular verticillate configuration of laminae of crystalline snow, &c., by Prof. Bombicci.—On a case of permanent polarity in a magnet opposite to that of the inducing helix, by Prof. Righi.—Laws relative to the dimensions of electric sparks of condensers, by Prof. Villari.—Investigation of phosphorus in the urine in cases of poisoning, and products which may occur, by Prof. Selmi.—A mercury pneumatic machine with double action, by S. Liuzzi.—Verification of ptomaines in most cases of chemical investigation, and formation of some of them, of poisonous nature, in animal substances kept three years in spirits, by Prof. Gianetti.—On the principal changes in the course of the Po, and means of obviating disaster threatened by it, by Dr. Predieri.—On the intimate structure of the eyes of Diptera, and on the eyes of blind Talpa, by Prof. Ciaccio. (This *Rendiconto* contains a considerable number of papers relating to anatomy and local geology.)

*Reale Istituto Lombardo di Scienze e Lettere. Rendiconti*. Vol. xiii., fasc. xv., July 15.—Outlines of a Government sanitary organisation, by Dr. Zucchi.—On the theory of hallucinations, by Prof. Tamburini.—Triassic fossils of the African Alps, by S. De Stefani.—The learned friends of Alexander Volta, by S. Z. Volta.

SOCIETIES AND ACADEMIES

LONDON

Entomological Society, September 1.—H. T. Stainton, F.R.S., vice-president, in the chair.—Miss Emily A. Smith, Assistant State Entomologist of Illinois, was elected a Foreign Member.—Mr. J. Jenner Weir exhibited specimens of *Odonestis polatoria* and *Smerinthus populi*, which possessed the peculiarities of both sexes.—Sir Sidney Saunders exhibited six winged examples of the Stylopoideous genus *Hylethrus*, and also various other Hymenoptera, and contributed remarks thereon.—Miss E. A. Ormerod exhibited some galls found on *Tanacetum vulgare*, which she described at length.—Mr. T. R. Billups exhibited a female specimen of *Polyblastus whalbergi*, an ichneumon not previously recorded in Britain.—Mr. E. Boscher exhibited living specimens of the two varieties of the larvae of *Smerinthus ocellatus*, and contributed a note thereon.—Mr. Meldola exhibited some specimens of *Campogramma bilineata*, a large number of which had been found by Mr. English near Epping, attached firmly to the leaves of the "tea tree" (*Lyrium barbarum*) by the abdomen, in which position they had died, possibly from the effects of a fungoid disease.—Mr. A. H. Swinton communicated a note on *Luciola italica*, an Italian fire-fly.

PARIS

Academy of Sciences, September 13.—M. Edm. Becquerel in the chair.—The following papers were read:—Observations of Faye's comet and of comet *b* 1880 (Schäberle) at Paris Observatory with the equatorial of the western tower, by M. Bigourdan.—On the probable orbital motion of some binary systems of the southern heavens, by M. Cruls. This is from the Imperial Observatory at Rio; and the author's data are compared with those of Sir J. Herschel at the Cape, and Capt. Jacob at Poonah.—Spectroscopic researches on some stars not hitherto studied, by M. Cruls. This relates to stars in the Bee, the Cross, and the Centaur.—On some solar phenomena observed at Nice, by M. Thollon. He gives several sketches of the spectral phenomena of protuberances, &c. He does not hesitate to say that every movement of the solar surface having, along the line of observation, a component which is not *nil*, causes a displacement of the spectral lines. It is also extremely probable, but not certain, that every displacement of a line corresponds to a movement.—On the law of electromagnetic machines (continued), by M. Joubert. With a given intensity of field, whatever the other conditions in which the machine works, from the moment when it gives maximum work, the retardation is equal to  $\frac{1}{2}$  of the entire period; the intensity is constant and equal to the quotient by  $\sqrt{2}$  of the absolute maximum of intensity; the electromagnetic work is proportional to the velocity; and the velocity is in a constant ratio to the resistance.—On boroduodecitungstic acid and its salts of potassium, by M. Klein.—On the subcutaneous lymphatics of the python of Séba, by M. Jourdain. The arrangement presents an evident similarity to that in Teleosteans (a ventral trunk and two lateral ones, &c.). When the direction of circulation of lymph has been ascertained, it will probably be found the same in both.—Deep dredging in the Lake of Tiberias (Syria), in May, 1880, by M. Lortet. The surface of the lake is 212 m. under that of the Mediterranean, but probably was at one time level with it; the greatest depth met with was about 250 m. at the northern extremity. It was thought that the waters, formerly saline, had probably contained special animal forms, traces of which might still be found at great depths. Some twelve species of fishes were met with, and some new forms. *Chromis* preponderated; indeed, they swarm in the lake. Twelve forms of mollusca were met with, some new species. The *Melanopsis* and *Melania* were of marine character. At the borders of the lake were some shrimps, crabs, and tortoises. Diatoms, foraminifera, &c., were obtained in the fine slime of the bottom, but no algae or coniferæ were met with (the water indeed was brackish, and had a temperature of + 24°; that at the bottom was not more brackish than that at the surface).—On the existence in Soudan of wild vines with herbaceous stem, vigorous roots, and eatable fruit, by M. Lécard.—On a thunder-storm observed at Laigle (Orne) on August 6, 1880, by M. Royer. During an hour and a half he counted 4,700 flashes, or about 53 a minute. Sometimes there were 100 a minute. The storm lasted two hours in all. The lightning struck twice, viz., a house and a poplar-tree.

CONTENTS

	PAGE
THE PHOTOPHONE. By Prof. SILVANUS P. THOMPSON . . . . .	481
THE GEOLOGY OF LONDON . . . . .	481
PROF. A. GRAY'S BOTANICAL TEXT-BOOK . . . . .	482
OUR BOOK SHELF:—	
Sedgwick's "Light and Heat" . . . . .	483
Rimmer's "Land and Freshwater Shells of the British Isles" . . . . .	483
LETTERS TO THE EDITOR:—	
Novel Celestial Object.—Prof. EDWARD C. PICKERING . . . . .	483
Experiments on the States of Matter.—J. B. HANNAY . . . . .	483
Fascination.—CHATEL . . . . .	484
Meteor.—J. THWAITES . . . . .	484
EVOLUTION AND FEMALE EDUCATION. By S. TOLVER PRESTON . . . . .	485
THE YANG-TSE, THE YELLOW RIVER, AND THE PEI-HO. By Surgeon H. B. GUPPY . . . . .	486
PHYSICS WITHOUT APPARATUS, VI. (With Illustrations) . . . . .	488
GENERAL PITT RIVERS' (LANE FOX) ANTHROPOLOGICAL COLLECTION (With Illustrations) . . . . .	489
NOTES . . . . .	493
OUR ASTRONOMICAL COLUMN:—	
Colours of Southern Stars . . . . .	495
Telegraphic Determinations of Longitude . . . . .	496
Four-Figure Logarithms and Anti-Logarithms . . . . .	496
ACTION OF PHOSPHORESCENT LIGHT ON SELENIUM. By Dr. EUGEN OBACH . . . . .	496
AGRICULTURAL CHEMISTRY, II. By J. H. GILBERT, Ph.D., F.R.S. . . . .	497
IMPROVED HELIOGRAPH OR SUN SIGNAL. By TEMPEST ANDERSON, M.D., B.Sc. (With Illustrations) . . . . .	499
SELENIUM AND THE PHOTOPHONE. By Prof. A. GRAHAM BELL . . . . .	500
SCIENTIFIC SERIALS . . . . .	503
SOCIETIES AND ACADEMIES . . . . .	504

THURSDAY, SEPTEMBER 30, 1880

## LANDSLIPS

FEW disasters impress the mind so vividly with human helplessness as those that arise from disturbance of the solid ground beneath our feet. The most devastating hurricane can in some measure be foreseen and provided against. Skill and foresight continually do battle with the fury of the waves, and prove on the whole victorious. We are so familiar with the restlessness of air and ocean that the havoc wrought by these elemental powers does not carry with it the sense of aught unusual or against which we may not hope successfully to contend. But to find that the earth beneath us, to which we have, consciously or not, trusted as the only stable feature in our landscape, gives way in a moment of unsuspecting calm, that the everlasting hills are themselves perishable like everything else, that ruin and death may in an instant overwhelm alike scenes of sylvan quiet and of active human industry, brings to the mind that practically experiences the sensation a horror to which there is hardly any parallel in the long list of calamities that thin the ranks of mankind.

Terrestrial commotions of this nature are obviously divisible into two classes. There are first tremors, of which the far-reaching and destructive earthquake is the most signal example. Much has been said and written about the cause of earthquakes, but we are still far from a satisfactory solution of the problem. Probably more causes than one conspire at different times to produce the impulse which sets the earth-wave in motion. But whatever may be their nurture and origin, these operations belong to that large class in which the internal temperature of the planet, with the results of its reactions and its diminution is the chief factor. In the second place come the disturbances arising from the working of the different agents which are set in motion by the direct influence of the sun. Among these the operations of running water are by far the most important.

There can be no doubt that it is in this second class of phenomena that the melancholy catastrophe at Naini Tal must be placed. In various ways the action of running water disturbs the equilibrium of large masses of rock at the surface. The frequent undermining of its banks by a rivulet or river, with the consequent fall of slices of earth or rock into the stream, is a familiar illustration. The dislocation and dislodgment of portions of cliffs by the wedging influence of frozen water is another common example. But the most extensive changes of this kind arise from the influence of water underneath the surface, where the geological structure of the ground happens to be favourable. Trickling through the pores, joints, and fissures of rocks, rain or melted snow makes underground channels for itself. In the course of its progress it sometimes dissolves away large quantities of stone, or loosens and carries away in mechanical suspension the minuter particles of rocks. When this abstraction of materials takes place along a subterranean slope, the lower end of which comes out on the side or bottom of a valley, the effect is to enfeeble the support of the mass of rock resting upon the slope.

VOL. XXII.—No. 570

Eventually this overlying mass may by gravitation break off from its floor and slide down into the valley below. Or should an open porous layer form the platform on which the side of the valley or cliff rests, copious rain may so saturate it as to loosen the cohesion of the superincumbent mass, which, when its weight overcomes that cohesion, is launched forward into the low ground below it. The saturated stratum may be compared to the grease put upon the beams on which a ship is launched from the building-yard. The moisture lubricates the bottom of the overlying rock and allows it to slide down. Such "landslips," as they are termed, are of common occurrence in countries with a copious rainfall, where the ground is uneven and rests on rocks containing easily permeable strata intercalated among others of a more impervious kind. The dislodged mass rushes down with irresistible impetus, breaking up into tumultuous piles of ruin, under which woods, meadows, gardens, fields, houses, and their inhabitants are almost instantly overwhelmed.

Every summer tourist whose wanderings have led him round the coasts of these islands is doubtless familiar with tracts of landslip, some comparatively recent, others so ancient as to go back far beyond the times of tradition or of local history. He will remember how in localities where the scenery would otherwise be of the tamest kind, the ground has been thrown into picturesque knolls and crags, with little glens and valleys winding through them, how the gathered drainage tumbles over miniature falls or collects into diminutive tarns which, in all save size, remind him of mountain lakes, and how over the whole scene the kindly hand of nature has spread her verdure, healing the scars of the original catastrophe by hanging festoons of ferns and mosses over the shattered rock, smoothing and carpeting with velvet turf the once naked floors of loose detritus, and scattering over dingle and den a pleasant shade of copsewood. The under cliffs of the Isle of Wight and other parts of the south coast, the clay cliffs of Sheppey and Yorkshire, the northern sea-front of the Antrim coast, the shores of Skye and adjacent islands of the Inner Hebrides furnish admirable illustrations of every stage in this history, from the raw wound of last year to the fairy-like scenery which conceals the landslips of remote centuries.

Fortunately in Britain we have no harrowing chronicle of human death connected with the story of our landslips. Yet these have not been without occasional loss of life, and sometimes considerable destruction of property. It has been estimated that the coast of Yorkshire between Spurn Point and Flamborough Head loses about 2½ yards annually, slice after slice of the clay cliff slipping down to the beach, where it is readily attacked and removed by the waves. The clay cliffs of the Isle of Sheppey suffer similar rapid removal, while the chalk cliffs of the Isle of Thanet have had a yearly loss of three feet. From fields that were ploughed and sown with corn in spring segments slip down, so that in these detached portions the crop may be seen ripening half way down the cliff. In the well-known landslip of December, 1839, near Lyme Regis, a strip of chalk cliff three-quarters of a mile long, 240 feet broad, and from 100 to 150 feet high was undermined by the descent of continuous heavy rain and the saturation of a thick deposit of loose sand underneath. It consequently slid

bodily forward on the beach, breaking up into segments in its progress, and carrying fields, trees, and houses along with it. Unquestionably the most appalling disaster of the kind which has happened in recent times was the celebrated Fall of the Rossberg in 1806, a mountain lying behind the Rigi, and composed like it of sandstone and conglomerate. In this case also there had been much previous heavy rain, which, filtering along a porous sandy bed inclined at a steep angle towards the valley, undermined the support of the overlying thick sheet of massive conglomerate. The whole hill-side gave way and several villages and hamlets, with somewhere between 800 and 900 people, were buried under the ruins. To this day the scar on the slope of the mountain is unhealed, and the piles of huge angular blocks, even to the further side of the valley, remain as memorials of the homesteads and villagers that lie buried below.

The recent catastrophe at Naini Tal is another illustration of the same geological process. The locality is situated on the soft Tertiary deposits which flank the sub-metamorphic and more ancient crystalline rocks of the Himalaya range that towers behind. It possesses one of the few known sheets of water on the Himalayan slopes, nestling among irregularly shaped hills. There is every reason to believe that these hills have derived their present contour not only from extensive denudation by the heavy rainfall, but also from the operation of former landslips, and that the lake itself, to which the place has owed so much of its attractiveness, lies in a hollow formed by the same cause. It has been suggested that the late accident arose from the cutting of a roadway along the base of the hill. But this seems an altogether improbable and unnecessary supposition. The structure of the ground is itself sufficient to account for landslips, apart altogether from the mere superficial interference of any road-making. According to the telegraphic reports there had been a particularly heavy rain, no less than twenty-five inches having fallen in forty hours. The annual rainfall at Naini Tal is stated to be ninety inches, so that more than a quarter of the whole yearly rain fell in less than two days. But this year, at least, the rainfall must have been greater, for Mr. Commissioner Taylor, who was charged with the care of the roads in the district and met his death in the recent catastrophe, wrote on August 17 last that eighty inches of rain had fallen in the previous two months. By such a violent downpour the loose soil is swept off the surface, deep gashes are cut down the slopes, and every streamlet and river is converted into a torrent of liquid mud. But the furrowed soils and rocks likewise absorb much moisture. The water launched in such a deluge over the ground soaks at once into the more permeable gravelly layers and saturates them. When these are inclined towards lower ground and covered with heavy masses of earth or rock, the conditions for the production of landslips are supplied to the full. And such seems to have been the case in this melancholy Indian disaster.

The question arises, Can any steps be taken to guard against a repetition of the calamity? We may take it for granted that Naini Tal, in spite of its recent visitation, will continue to be a favourite resort from the arid plains below. The chance of an occasional destructive landslide will not deter men from coming year after year to gain

renewed health and rest in the pure air of these uplands. It is obviously impossible to prevent landslips, except such minor falls as could not do any extensive damage. The only resource is to fix the sites of stations and houses on such spots as will either be free from risk of accident or on which the risk will be reduced to a minimum. This is mainly a geological question, but it is evidently one of the utmost social importance. Among the able staff of the Geological Survey of India there is no doubt an officer whose services could be made available to examine and report upon the structure of the ground at Naini Tal with special reference to this question. There ought to be first a careful inquiry into the details of the causes that led to the recent sad event, and with the experience thus gained a further inquiry into the safety of the other parts of the settlement and of other hill-stations similarly placed. Even in a district liable to destructive landslips sites for houses can probably be so chosen and defended as to be practically exempt from liability to such calamitous visitations as that which we now so heartily deplore. The prodigious amount of rain which in a few days or hours deluges the ground in these regions presents an engineering problem which demands actual Indian experience on the part of those who would successfully grapple with it. Neither geologists nor engineers accustomed only to the comparatively mild rain-storms of Europe can probably realise the magnitude of the difficulty which such disasters as that of Naini Tal presents for their consideration.

#### ARCTIC NEWS

THE past week has been an unusually interesting one so far as Arctic matters are concerned. First of all we have tidings of the return of the Franklin Search Expedition, sent out from the United States about two years ago, to follow up and unearth if possible some important relics of the Franklin expedition, said to exist among the Eskimo. It may be remembered that upwards of two years ago news reached this country that Mr. Barry, the mate of an American whaler, was told by some Nechelli Eskimo whom he met at Whale Point, Hudson's Bay, that some spoons with Franklin's crest upon them, possessed by the Eskimo, were received from a party of white men who passed a winter near their settlement, where they all died; and that these men left a number of books with writing in them, which were buried. The tale seemed very doubtful, and those best acquainted with the history of Franklin search expeditions considered that it was scarcely necessary to act on the gossip of the Eskimo. However, the people of the United States, who have all along manifested a generous enthusiasm in behalf of the Franklin expedition, thought otherwise, and by private enterprise an expedition was sent out in the summer of 1878, under Lieut. Schwatka, to follow up the traces indicated by the Eskimo. This expedition, after an absence of two years, has just returned, and although the success, so far as its immediate object is concerned, has not been great, it has evidently been able to make important additions to a knowledge of the condition of the inhospitable Arctic region traversed, a region rendered classical, if not sacred, by the early and terrible work of Franklin him-

self. The following telegram in the *New York Herald* of September 23, from New Bedford, Massachusetts, was the first announcement of the return of the expedition:—

"The Franklin Search Expedition, under the command of Lieut. Schwatka, have returned here. They have discovered and brought southward relics of the two British ships *Terror* and *Erebus*, which sailed from London, under Sir John Franklin, in May, 1845. The expedition successfully withstood the greatest amount of cold ever encountered by white men. During sixteen days of a sledge journey, extending over a period of eleven months, the average temperature was 100° below freezing point. In the summer and autumn of 1879 the expedition made a complete search of King William's Land and the adjoining mainland, travelling by the route pursued by the crews of the *Erebus* and *Terror* in retreating towards Back's River. They burnt [buried] the bones of all remaining above ground, and erected monuments in memory of the dead. Their researches have established the fact that the records of the Franklin Expedition are beyond recovery. They have also learnt that one of Sir John Franklin's ships drifted down the Victoria Straits, and was unwittingly scuttled by the Eskimo, who found it off Grant Point in 1849. The expedition have brought away the remains of Irving, the third officer of the *Terror*. From each spot where graves were found a few tokens were selected which may serve to identify those who perished there. They also secured a board which may be of use in identifying the ship which completed the North-West Passage."

A few further details have appeared in the subsequent numbers of the *Herald*, but we must await the arrival of the paper and the publication of Lieut. Schwatka's narrative for full details. Particulars, we are told, are given of the sufferings and hardships endured by Lieut. Schwatka's party, who, however, succeeded in discovering relics of the expedition, and learnt from the natives details of the sufferings it underwent from cold and starvation. The natives related that they saw a small party of officers, believed to be the last survivors of the expedition, black about the mouths and with no flesh on their bones, dragging a boat across the ice. They then disappeared from view, and their skeletons were subsequently found under the boat and in a tent, a prey to wild beasts, and affording evidence that some of them had been eaten by their comrades. Lieut. Schwatka's own party, we are told, made a sledge journey of over 2,819 geographical miles, mostly across unexplored country, and this constitutes the longest sledge journey on record, both as to time and distance; the men it seems lived like the natives.

The sad story of the terrible suffering endured by 105 men who quitted the *Erebus* and *Terror* on April 22, 1848, ten months after the death of Franklin, is too well known from the narrative of the search party in the *Fox* under M'Clintock. Ample evidence was found scattered along the shores of King William's Land and Boothia, by which they endeavoured to reach the Fish River Settlements, of the fate of most of the party, many of whom, the Eskimo told M'Clintock, fell down as they walked, and had to remain unburied. Lieut. Schwatka's party have done what they could to show respect to what remains of the brave and unfortunate band. Unfortunately no written records of the expedition have been found; there was little room to expect that there would. As to the statement about the vessel which completed the North-West Passage, we suppose this must mean that

one of the ships had drifted south-westwards so far as to meet with the furthest eastward point reached by Franklin in his earlier expeditions. The records of temperature will be eagerly looked for by meteorologists; the degree of cold seems to have far exceeded any Arctic temperature on record.

An unfortunate set-off to Lieut. Schwatka's successful return is the news that Capt. Howgate has been again compelled to put back in the *Gulnare* to St. John's, Newfoundland, the vessel being so unsuited for her work that the proposed expedition to Lady Franklin Bay has had to be abandoned for this year. Capt. Howgate is certainly very unfortunate in his Arctic scheme, though we trust he will not be daunted, but will next year be able to accomplish the foundation of his Polar colony.

Further sad news comes from San Francisco of the Gordon-Bennett expedition in the *Jeannette*, which set out full of hope not long ago. No tidings can be obtained by the whalers of the expedition, and the relief steamer *Corwin* had to return owing to the severity of the weather. There is however no more reason for giving up hope than there was in the case of the Payer-Weyprecht expedition, which disappeared suddenly off the Novaya Zemlya coast in 1872, and returned about two years later with the tidings of the discovery of a new Arctic land. This land, Franz Josef Land, a telegram from Hammerfest informs us, was visited in August by that most daring of yachtsmen, Mr. Leigh Smith. He explored to the west as far as 45° E. and 80° 20' N., and sighted land from that point about forty miles north-west. No doubt Mr. Leigh Smith's experience this year and Capt. Markham's in the same direction last year, seem to point out that exploration northwards on the basis of Franz Josef Land is hopeful. So long as such exploration is carried on by private enterprise there can be no objection to it, but if Government has any funds to spare for Arctic work during the next few years, they would be expended to the best advantage in enabling this country to join the European and American concert for the establishment of Polar observing stations, from which England is conspicuously absent.

#### RODD'S BIRDS OF CORNWALL

*The Birds of Cornwall and the Scilly Islands.* By the late Edward Hearle Rodd. Edited, with an Introduction, Appendix, and brief Memoir of the Author, by James Edmund Harting. With Portrait and Map. (London: Trübner and Co., 1880.)

THE addition of another volume to the already long series of works upon the local avifaunas of Great Britain is not perhaps an event of any very great importance as regards ornithology in general. Yet the name of the late Mr. Edward Hearle Rodd of Penzance is so well known to British naturalists, and the county in which his observations were made is a land of such special interest, that there can be no doubt of the present volume being acceptable to a wide circle of readers.

At the time of his death it was generally understood that Mr. Rodd had in preparation a general work upon the birds of his native county. This work, however, as we are now informed by Mr. Harting, had only so far advanced as to "consist of a transcript of various notes on the ornithology of Cornwall, communicated by the author to the pages of the *Zoologist* arranged in chrono-



logical sequence." "It was obvious," Mr. Harting remarks, "that in order to render these notes of practical utility it was necessary to re-cast and re-write the whole." This has been ably executed by the editor, and we have now Mr. Rodd's interesting and original observations, which were continued over a period of nearly forty years, reduced into method and order. These observations, thus re-arranged, occupy the first portion of the present volume, and constitute the most important part of it. Appended to it are more or less contracted reprints of the "yearly reports" which Mr. Rodd was for many years accustomed to contribute to the *Journal* of the Royal Institution of Cornwall, containing an account of the principal ornithological rarities which had come under his notice in each year, and of the additions thus made to the list of the Cornish avifauna. The editor has also considerably increased the value of the volume, especially to Cornish naturalists, by his Introduction. In this is given an account of the previously existing literature on Cornish ornithology, beginning in 1478 with the *Itinerary* of William of Worcester and continued down to the present period, and constituting a most useful summary of information on the subject. Mr. Harting has likewise appended a list of Cornish and provincial names, which will further increase the interest of his work.

The extreme southern and western situation of Cornwall renders it one of the first resting-places in spring and one of the last in autumn of those birds which visit us during the summer migration, whilst several well-known Continental species, which are scarcely ever found in the more eastern parts of Great Britain, occur more or less regularly in this remote county. The black redstart, for example, so little known to the majority of English observers, except in its native haunts in Rhineland and Switzerland, is "not uncommon" in Cornwall in the winter months, though usually met with in immature dress. An adult male, however, in very beautiful plumage was captured in December, 1856, in the immediate neighbourhood of Penzance. Another much less-known European passerine bird, which has been met with in no other part of the United Kingdom, straggles occasionally into Cornwall—curiously enough, as it is essentially an eastern species, and might be rather expected to occur on the coasts of Norfolk and Suffolk. This is the little red-breasted flycatcher (*Muscicapa parva* of Bechstein), of which a single example in immature plumage was obtained near Falmouth in 1863. Two other specimens of the same species were subsequently captured in the Scilly Islands. Eastern Europe, as we have already observed, is the true home of this little bird, which will be well known to such of our readers as have visited Constantinople, where it is very common in autumn among the old walls and ruins.

Another very interesting visitant to the coasts of Devon and Cornwall is the Greater Shearwater (*Puffinus major* of Faber). This species is also well known on the Scilly Islands, where it goes by the singular name of "Hack-bolt." Its congener, the Manx Shearwater (*Puffinus inglorum*), is still more common on the Cornish coast, and breeds in some of the Scilly Islands. But for details on these and other peculiarly western birds we must refer our readers to Mr. Rodd's volume, which no student of the British Ornithology should fail to add to his library.

#### DEEP-SEA SOUNDING AND DREDGING.

*United States Coast and Geodetic Survey, Carlile P. Patterson, Superintendent. A Description and Discussion of the Methods and Appliances used on Board the U.S. Coast and Geodetic Survey Steamer "Blake."* By Charles D. Sigsbee, Lieut.-Commander, U.S.N. Pp. 192, xli. Plates. (Washington: Government Printing Office, 1880.)

THE publication of the "Depths of the Sea" and of the "Voyage of the *Challenger*" by Sir Wyville Thomson has made the public familiar with the work of the English in the exploration of the depths of the ocean. But little is known, even in America, of the important part which the United States Coast Survey has taken in the solution of the problems of the physical geography of the sea. The Coast Survey during the superintendence of Prof. Bache instituted a series of investigations on the physical problems of the deep sea, connected with the Gulf Stream, which have little by little been expanded by his successors, Prof. B. Peirce and the Hon. Carlile P. Patterson, into the most important hydrographic exploration yet undertaken by any government. With a wise liberality secondary hydrographic scientific problems, mainly of interest to the biologist and geologist, have been made a part of the work of the Coast Survey. Thus since 1866 the use of the dredge, the trawl, the tangles, and of all the apparatus necessary for a thorough exploration of the fauna of the depths of the sea has become as familiar to some of the navy officers attached to the Coast Survey as the use of the sextant or of the lead.

The Coast Survey steamers, *Bibb*, *Hassler*, and the *Blake*, have acquired a special reputation as deep-sea dredgers. The work of the *Bibb* and *Hassler* is known to naturalists mainly from the memoirs of Pourtales. Of the results of the *Blake* only a part has as yet been published under the direction of Mr. Alexander Agassiz.

Not only all naturalists but also hydrographers must be interested in the volume just published respecting the equipment of the *Blake*, a small steamer of only 350 tons burthen, which, under the skilful commands of Lieut.-Commander C. D. Sigsbee and Commander J. R. Bartlett, has not only done more rapid but also far more accurate work than has been accomplished with the old methods and appliances of the large men-of-war usually detailed for similar work by European governments.

Lieut.-Commander Sigsbee gives in this Report full descriptions of the thermometers, the water-cups, the salinometers, and of the methods of observing the currents in use on the *Blake*. The most important part of the Report is that devoted to deep-sea sounding. The sounding-machine, called a modification of Sir William Thomson's machine for sounding with wire, is known on the *Blake* as the "Sigsbee machine," and Sir William Thomson would find it difficult to recognise in the sounding machine of the *Blake* the apparatus he first suggested for sounding with piano wire. Throughout the Report the results of Lieut.-Commander Sigsbee's inventive genius are evident, from the water-cup to the shot detacher, the dredges, the trawls, the reels, the accumulator, there is nothing which he has not rendered more useful. His enthusiasm was shared by his officers, and their names

appear as his co-inventors on the Plates illustrating these different appliances.

The accuracy attained with Sigsbee's sounding-machine is very great, the probable error of sounding with piano wire at great depths not exceeding one quarter of one per cent. What the error may be if soundings taken by the old methods will only be known when all the former rope soundings have been repeated with wire soundings.

The last chapters are taken up with descriptions of the double trawls, the dredges, and other apparatus for collecting the animals found at great depths. An account is also given of making a haul at great depth and of the management of the steel wire rope, first introduced by Mr. Agassiz for deep-sea dredging on the *Blake*, and which has done so much to facilitate this class of work on vessels of the small tonnage of the *Blake*.

The Report is fully illustrated with heliotype plates as well as with tables showing the manner of recording the observations made.

It is pleasant to notice that the harmony between the civilians and the officers was not for an instant disturbed, during the three dredging cruises made by the *Blake*, extending from the Windward Isles to the Eastern extremity of George's Shoal.

The naturalists on board the *Blake* were indeed fortunate to have as their associates officers whose industry, energy, and interest in the work never flagged, and who have now attained a proficiency in deep-sea work hardly deemed possible three years ago.

#### OUR BOOK SHELF

- i. *Elements of the Differential Calculus, with Examples and Applications: a Text-book.* By W. E. Byerly, Ph.D. (Boston: Ginn and Heath, 1879.)
- ii. *An Elementary Treatise on the Differential Calculus, founded on the Method of Rates or Fluxions.* By John Minot Rice and W. Woolsey Johnson. Revised Edition. (New York: J. Wiley and Sons, 1879.)

NEARLY five years have passed since we noticed a small pamphlet by the authors of (ii.), together with treatises on the calculus of Messrs. Buckingham (Chicago) and Clark (Cincinnati), and we then remarked upon the growing interest taken in mathematics by American students. A further outcome of the same interest is the two works now before us. As it is not to be expected that such works will take the place in our colleges of the text-books already in use amongst English mathematicians, seeing that, like our own books, these are greatly indebted to the classic works by Duhamel and Bertrand, we shall not dwell at any length upon their merits or demerits. Each work under notice is well done to the extent to which it goes, and will furnish the young student with a good introduction to the admittedly difficult subject of which it treats.

(i.) takes as its foundation the "rigorous use of the doctrine of limits," introducing easy integration at a very early stage, and has frequent recourse to geometrical and mechanical illustration with a view to making the subject of interest.

(ii.) is the elaboration, in an excellent work, of the paper (subsequently a pamphlet) referred to above, which was introduced to the notice of English readers by a *résumé* of its contents in the *Messenger of Mathematics* (August, 1874) by Mr. Glaisher.

Both books are effectively got up, and (ii.) is exceedingly well printed.

*Spirit-Gravities with Tables.* By Thomas Stevenson, M.D., &c. (London: John Van Voorst, 1880.)

DR. STEVENSON has published a series of Tables in which the specific gravity of alcohol from 100 to 0.05 per cent. is given for each difference of 0.05 per cent. The percentages of alcohol by weight and volume, and of proof spirit are contained in the Tables. The specific gravities are given to four places of decimals. The Tables are founded on those of Gilpin and Drinkwater, and for spirits of less specific gravity than 0.8250—*i.e.* containing more than 89.05 per cent. by weight of alcohol—on that of Fownes.

In an introduction the various Tables hitherto in use are discussed; and various useful data are noted. The Tables are clearly printed, and will be of much service to those who are required to analyse alcoholic liquids.

#### LETTERS TO THE EDITOR

[The Editor does not hold himself responsible for opinions expressed by his correspondents. Neither can he undertake to return, or to correspond with the writers of, rejected manuscripts. No notice is taken of anonymous communications.]

[The Editor urgently requests correspondents to keep their letters as short as possible. The pressure on his space is so great that it is impossible otherwise to ensure the appearance even of communications containing interesting and novel facts.]

#### Supposed New Island in the Azores

A REPORT was current in the English and American newspapers some weeks ago that a new island had made its appearance among the Azores, similar in character to that which came up near the extreme western end of St. Michael's in the early part of the century. As I had determined to spend my long vacation among these islands, I was curious to witness a phenomenon so interesting and so rare as the birth of a new volcanic island. I learn that the report has its foundation in the occurrence of a landslide on the north-east end of St. George. A large portion (about 82 alqueiros in extent) of the land at Lapa, near the village marked Topo on Vidal's Chart, launched itself bodily into the sea—that is, in an almost unbroken mass, to a distance of about 300 metres from the mainland. There were a number of cattle grazing on the land at the time; these apparently were so little affected by the occurrence that when found they were feeding unconcernedly on "the new island," as if it had been associated with their whole existence. A little survey of the spot has been made, and the Director of the Public Works at Velas, the chief town of St. George, was kind enough to give me a map of this, the most recent addition to—or perhaps one ought to say subtraction from—the Azores. T. E. THORPE

#### Parthenogenesis in the Coleoptera

IN the "concluding remarks" in his treatise on "Wahre Parthenogenesis" (1856), von Siebold says, "Es ist daher jetzt Aufgabe der Entomologen, nach weiteren Beispielen von Parthenogenesis in der Insektenwelt zu forschen"; and on the last page (237) of his "Beiträge zur Parthenogenesis," published fifteen years later, he expresses the conviction that many facts relating to this phenomenon are still to be discovered. The instances of true parthenogenesis discussed or referred to in these two works relate to insects of the orders Hymenoptera and Lepidoptera, and to some crustaceans. Including viviparous agamogenesis, however, as parthenogenetic, the orders Hemiptera and Diptera also furnish examples of this mode of reproduction; and for its occurrence in at least one genus of the Trichoptera I have the authority of Mr. R. McLachlan, F.R.S. The possibility of parthenogenetic reproduction in the Coleoptera rests only, so far as I am aware—see "Comparative Embryology," by F. M. Balfour, vol. i. p. 64—on the single instance communicated by me to this journal last year (*Nature*, vol. xx. p. 430), and this being so, it seemed desirable to make sure of this point by further research during the season now almost past. Accordingly I have this year kept a considerable number of females of *Gastrophysa raphani*, laying unimpregnated eggs, and with results which have not only confirmed the previous experience, but much extended it, as I am at present in possession of a living

beetle reared from a parthenogenetic ovum. With your permission I shall now endeavour as briefly as possible to give those circumstantial details without which a bald statement of results would not carry with it a rational conviction of the accuracy of my observations.

From beetles gathered in the beginning of last April I had a batch of eggs on the 7th, which hatched out on the 21st of the same month, and on May 13-15 yielded about thirty pupæ, which were immediately put into separate vessels. On the 20th-22nd appeared the imagines, of which ten subsequently turned out to be females, and were placed together in pots, but not before the greatly enlarged abdomen had given unmistakable evidence of their sex. The first eggs, three batches, were laid on June 2 (so completing the cycle, from egg to egg, in fifty-six days). On the 12th of the month I found in one of these batches, consisting of forty-two eggs, thirteen developed, of which two hatched out, the larvæ dying shortly afterwards. Others seemed to have partly hatched, but most eventually perished in the shell. At this time fertilised eggs were hatching in nine days. It appeared to me that several of the thirteen were imperfectly or monstrously developed; one, for example, having only one misshapen (?) mandible; another, excess in number and irregularity in grouping of the eye-spots; &c., &c. Again, on June 17 I found in a parcel of (twenty-five) eggs, laid June 6-7, six which had developed up to the hatching. In the usual course, at the time of hatching, the young larva comes out of the shell clear like barley-sugar, but blackens afterwards; in the case of these parthenogenetic larvæ which do not hatch out, this blackening takes place within the shell. In a third batch, of over twenty eggs, laid June 8, I found three eggs similarly developed. In the meantime, and afterwards, many dozen batches had been laid, in which, however, I did not detect any development.

A second experiment miscarried; but I was more successful with a third and fourth. From a batch of eggs laid June 5-6 I derived pupæ which on July 8 following I placed separately in pots, and obtained from them thirteen beetles, of which seven turned out to be females. About the same time I brought in from the fields some well-grown larvæ, the beetles from which were isolated immediately after their exclusion, and subsequently yielded eight females. These (seven and eight) were all kept in separate pots during the course of the experiment. Of the seven no less than five laid eggs which afterwards developed parthenogenetically. They laid as many as ten parthenogenetic batches among them, but while some of them laid three such batches, others laid only one. These were invariably the first batches laid, and none of the batches laid subsequently contained any viable eggs while the experiment lasted, which was in some cases up to the tenth batch. Of the eight beetles of the fourth group, only one laid one parthenogenetic egg in its first batch. The number of parthenogenetic eggs in a batch varied from one to seven. In four batches there was only one such egg; in three batches five, and in the other four batches two, three, six, and seven respectively. The total eggs in a batch averaged 41.7, and as there were thirty-six parthenogenetic, the proportion over all was 1 in 12½. However, as may be supposed, the proportion in the individual batches varied very much, one small parcel of only eleven eggs having as many as five developed.

In most of the cases also the larvæ perished in the shell. A few hatched out more or less completely, and died. Two, however (of the seven in one batch), were more fortunate. These came out on July 29, and for some hours seemed very feeble and barely alive. Next morning I found that one, which subsequently took the lead of its fellow in all respects, had crawled away under cover, and the other was soon able to follow its example. I could not find that they had eaten anything till the evening of the 31st. After that, however, they thrive apace. The larger one passed its first and second moults on the 3rd and 7th of August, the smaller following it on the 4th and 8th. The former pupated on the 14th, and the imago was excluded on the 19th. The latter, having pupated, August 15-16, appeared to go on well till the time for the exclusion of the beetle, when its further development became arrested, and it died. The survivor was weakly at first, and rather imperfect always as regards the elytra, which are somewhat small, and do not close in the middle line. It has, however, thriven well, and developed that enlargement of the abdomen peculiar to the female. But up to the present (September 22) it has laid no eggs, nor shown any inclination towards males placed in the pot with it.

When it became obvious that no more parthenogenetic eggs were to be obtained from these beetles, I placed the survivors of them in succession in a pot with a (the same) male beetle, with

the result that most afterwards laid fruitful eggs in the ordinary way. I mention this because it seems to be in contradiction, as far as these insects are concerned, with the statement of von Siebold ("Beiträge," p. 89): "Es ist nun eine bekannte Sache, dass, wenn Insecten-Weibchen vor der Begattung erst einmal Eier zu legen angefangen haben, ihre Männchen alsdann mit ihren verspateten Liebesbezeigungen bei ihnen nichts mehr auszurichten im Stande sind."

If now I may be permitted to make a few general observations on some of the points indicated for further inquiry, rather than established, by the foregoing experiments, I would say: (1) that parthenogenesis seems to occur chiefly in the first-laid batches; (2) that it is peculiar to some females, while others appear to be exempt from it; (3) that confinement and domestication, as it were, acting hereditarily, which we already know so profoundly to affect the generative system in the higher animals, appear to favour this mode of reproduction in *Gastrophysa raphani*; (4) that there are degrees of viability in parthenogenetic embryos, so that the development seems to be arrested chiefly at certain points, as at the hatching of the egg and the exclusion of the imago. In this respect the *Gastrophysa* egg behaves very much as the ovum of *Bombyx mori* is reported to do (*v.* "Beiträge," pp. 230-232). (5) Another point in which *G. raphani* agrees with other parthenogenetically reproductive arthropods is its many-broodedness in a season. There may be three or four generations in direct succession in the year, and there is a constant succession of eggs all the time. In this it appears to differ from any of its allies with which I am acquainted. (6) Finally, the case of *G. raphani* would seem to be one of true parthenogenesis in its most restricted sense—the same beetle which in the unimpregnated state lays sterile eggs, with here and there one capable of development, after receiving the male element, laying eggs, which are fertile and develop in the ordinary way. That is to say, the ova are true ova, and not pseud-ova or buds, the parent a perfect female and not an "Amme" like the summer Aphis. J. A. OSBORNÉ

Milford, Letterkenny, Ireland, September 22

#### Observations of Auroræ on August 12 and 13

THE finest display was between 10 and 11 o'clock on the evening of the 12th, when a magnificent corona was formed almost exactly on  $\gamma$  Cygni. At this time the bases of the columns on the eastern horizon were distinctly red. Unfortunately the spectroscope could not be brought to bear until the aurora had faded to a small fraction of its greatest brightness. With a very small dispersion (Vogel spectroscope) the spectrum was continuous from W.L. 557 mm. to W.L. 473, with strong traces of a finely banded spectrum, terminating abruptly at the great line 557. Towards the violet an isolated line was seen and measured.

On the 13th the great line was seen and also traces of the others. The measures may be summarised as follows:—

Wave-length.	Spectroscop.	No. of measures.
557.16 ± 0.20	Grubb	8
527.5	"	1
469.6	"	1
473.2	Vogel	1
430	Grubb	In middle of field
434	Vogel	1

The Grubb spectroscope has a dispersion of  $5^{\circ} 40'$  from C to A. The first line was measured with an illuminated micrometer wire, the others with the edge of an opaque screen. The Vogel spectroscope has a scale of bright lines with sixty divisions to the whole visible spectrum. RALPH COPELAND

Lord Lindsay's Observatory, Dunceath

#### Ice at High Temperatures

FROM Mr. Hannay's letter (*NATURE*, vol. xxii. p. 483) and from private communications I have received it appears there has been a little misconception as to the manner in which I judged of the temperature of the ice in the experiment referred to in *NATURE*, *ibid.*, 435. Mr. Hannay's theory, that the ice was protected from the hot glass by an intervening layer of vapour, at first occurred to myself and to others as the true explanation of the phenomenon, but that this explanation will not serve in the present case is, I think, proved by the fact that a thermometer was imbedded in the ice and rose to temperatures varying in different experiments between  $120^{\circ}$  and  $180^{\circ}$  C., at

which points the ice had either all volatilised or had become detached from the bulb. This appears improbable from our present ideas concerning latent heat, but it is nevertheless a fact. If I can make the necessary arrangements it is my intention to show the experiment at an early meeting of the Chemical Society, when it will be open to criticism.

In regard to the remarks contained in the former part of Mr. Hannay's letter, I of course did not bring forward the first proposition in my letter as anything new, but merely to show that my experiments confirmed the previous conclusions of others on the critical temperature.

THOS. CARNELLEY  
Firth College, Sheffield, September 27

#### A Peat Bed in the Drift of Oldham

IN NATURE, vol. xxii. p. 460, there is a description of a bed, or rather beds, of peat in the drift at Oldham. A few days ago I had an opportunity of examining the section described by Mr. Jas. Nield, and under his guidance, but I differ from him in opinion as to the age of the peat. The section occurs on the steep sloping side of a valley, and just above it there is an exposure of sand covered by boulder clay. In my opinion some of the latter has simply slipped down, off the sand, on to the surface of the peat at a lower level; or it may have been excavated and thrown down for the purpose of obtaining the underlying sand. Besides, the principal bed of peat rests on blue silt, which again rests on boulder clay. The upper bed of peat occurs at one end of the section, and both ends present the appearance of a talus of *albris* from a higher level. Still the section is somewhat obscure, though a few hours' digging at a right-angle to its present exposure would probably prove the blue silt and peat to be more recent than the boulder clay, although the latter is certainly the highest bed in the section as at present exposed. However, geologists are indebted to Mr. Nield for calling attention to the section, and no doubt he and others will take means to prove the true position of the peat, which is sure to attract considerable attention.

G. II. MORTON  
122, London Road, Liverpool, September 18

#### Hardening of Steel

I SHOULD have, had circumstances permitted, thanked Mr. Walter R. Brown for his kind response to my letter, "Iron and Hydrogen" (NATURE, vol. xxii. p. 220), and for the reference to Mr. Anderson's report, with which I was unacquainted.

The points mentioned by Mr. T. W. Giltay certainly seem somewhat to controvert the theory of alloyed hydrogen; but thinking over the facts some time ago it struck me that the aqueous vapour in the air would be a source for the gas as in chilling beneath water. It would be interesting to know whether mercury, as commonly used, is not also faintly alloyed with hydrogen.

For my own part, I am inclined to the carbon theory, but the facts were brought forward with the idea of seeing them discussed, and a somewhat obscure but important subject brought to light.

H. J. JOHNSTON-LAVIS

#### Mosquitos

SEEING in NATURE, vol. xxii. p. 11, the use of infusion of quassia recommended, and being a great martyr to mosquitos, I immediately set to work to brew two or three gallons with all the energy with which I had already tried many remedies and nostrums.

The basements of nearly all the good houses here in Naples are used as stables, and consequently form a great attraction for these insect pests.

This large quantity of very concentrated infusion was disposed of as follows:—The whole of the bed-room walls, ceiling, carpet, and furniture were gone over with a Lister's vapour carboliciser containing the solution; sheets and night-dresses wrung out and dried before use, body sponged all over, and bed clothes re-sprayed with the solution each night.

This certainly was a fair trial, but the results after all this expense, trouble, bitter lips and mouth was a complete failure.

It really seems that the only true protection against mosquitos is the curtain with all its inconveniences.

September 21

H. J. JOHNSTON-LAVIS

#### GENERAL PITT RIVERS' (LANE FOX) ANTHROPOLOGICAL COLLECTION<sup>1</sup>

##### II.

OUTRIGGERS are very varied in their structure. In some canoes there are two opposite one another, one of which does not touch the water; it is merely a balance platform; in some both outriggers only occasionally touch the water. It is not improbable that the side-galleries of some junks are developed out of balance platforms, and that the ledges known as the "chains" of modern European vessels are of similar origin. The rudder is merely a development of the steering paddle. It is still merely a fixed paddle, being worked by an operator with his face in the direction in which the boat is moving, whilst oars have taken the place of all the other paddles of the boat.

Another series illustrates the origin of clothing. Clothing was derived, no doubt, partly from the development of ornaments, being originally entirely ornamental, as a large proportion of it still is, even amongst ourselves, and partly from gradual modifications of belts and such accoutrements, which served a useful purpose when put round the body as convenient appliances for hanging things to for carriage. A pocket is a luxury which a savage does not possess. He has to sling his little necessities to his belt, or secure them in the lobe of his ear, or carry them, to his embarrassment, in his hand. Even in Japan the men are obliged to sling their tobacco-pouches and pipes from their belts by means of silken cords and the beautifully-carved ivory buttons or netsukes so well known in European collections. They have pockets only in their sleeves, and these are insufficient. The simple cincture is the sole clothing of the Andaman Islander. A bunch of pandanus slips is added in front in a further stage, and eventually a complete encircling fringe is reached. When paper cloth (*tappa*) has been invented, or woven material, this is substituted for the fringe, and a kilt is the result. In some parts of Great Britain dress has not advanced beyond this stage, or rather the primitive form of dress has been adopted as a curiosity. The sporan probably represents the original dress, the bunch of grass of the Andaman Islander, now worn over the kilt instead of as originally next the skin. At a further stage, the kilt being found uncomfortable, it was fastened together at one spot between the legs, and hence arose the idea of trousers, which, through the baggy Turkish inexpressibles, gradually developed into their present form.

The simple cloak of skin or *tappa* developed gradually into coats and various more convenient tight-fitting garments, but in all robes of ceremony the savage cloak form is still retained by the most highly civilised races. One of the latest additions made to his collection by General Pitt Rivers is a series of Brittany caps, showing the gradual development of all the strange forms in vogue in different districts, by means of the abnormal growth of the strings, crown, or front, of one simple type.

Another series shows the development of drinking-vessels of all kinds, starting from the natural vessels found ready to hand, such as human skulls, cocoanut-shells, gourds, and horns. From the cocoanut with a handle comes the ladle, and hence the spoon, and so on.

Another series is devoted to the development of musical instruments. Wind instruments are modifications derived from the horns of animals, spiral shells, reeds, bamboos, and bones. From these by gradual steps are attained the trumpet and spiral brass instruments, the curl of which probably came from the spiral shell; also pan-pipes, and hence organs, and flutes. As bearing on the origin of the bagpipes is exhibited a bag and whistle carried by Indians of the north-west coast of America to imitate the call of ducks and decoy them.

<sup>1</sup> Continued from p. 493.

Drums were derived from bamboos, being at first simple pieces of bamboo open at both ends and beat on the ground as now at Fiji. Wooden logs are then hollowed out to imitate them, and hence the large erect wooden drums of New Guinea and Melanesia generally, and the horizontal canoe-like drums, "lali," of Fiji. But these hollow wooden drums without a tense membrane are more justly classed with bells, and metal

A tense membrane having been added to one end of a bamboo, the real drum was reached, and from this is derived the Papuan drum, which is long and pipe-like in form, and has a membrane of lizard skin (*Hydrosaurus*) at one end. It is often shaped like a crocodile's head at the open end, is somewhat dice-box-shaped, and is used in dancing.

Another series is devoted to the growth of the art of pottery. Amongst savages the Fijians are pre-eminent for the excellence of their pottery and for the variety and grace of the forms of the vessels which they manufacture. The common simpler flask-shaped form made by them is said to have been suggested by that of the nest of a wasp (*Polistes*, sp.) common in the islands. They glaze their pottery, and make vessels in the shapes of animals such as turtles, in all kinds of forms, even in double and triple clusters, recalling to mind the pottery of ancient Peru.

Yet another series exhibits the extent to which various races of mankind have succeeded in representing the human figure in wood, stone, or ivory carving, or models, or in pottery. It is interesting to trace here the steps by which the art of sculpture has grown. Sculpture grew by the most gradual steps to its civilised excellence. When savages produce the excessively rude representations of men which commonly do duty as gods, the faults in the work are not due to an absence of power to execute better carvings, but simply to an absence of accumulated experience as to how the human figure should be represented. It is remarkable how extremely well some savages copy European carvings when once they get the chance of a little teaching. As an example of this sort of work General Pitt Rivers displays a carving of the Virgin and Child executed by the Qua Qua Indians of the North-west American coast. The piece might pass muster as an example of modern Swiss work. Besides this specimen are three sitting figures in the old unassisted native style, carved by the Vancouver Islanders. They are very different indeed in execution, and rude, but they still show a certain amount of artistic feeling. Indeed, the whole of the Indians of the Upper North-West Pacific coast, and especially the Haidahs, are conspicuous for very advanced artistic powers as savages. Savages vary immensely in their artistic development. Many, such as the Hottentots and South African races generally, appear never to have made any representations of the human figure. Those who do make such figures always adopt a conventional form for them, which is so well marked that an experienced eye can detect at once by what race any particular figure has been made. Perhaps the most curious figures are those of Easter Island, with shrunken abdomens and prominent ribs. The figures seem copied from half dried-up corpses, and were perhaps copied from the dead originally. Some Peruvian human faces are extremely

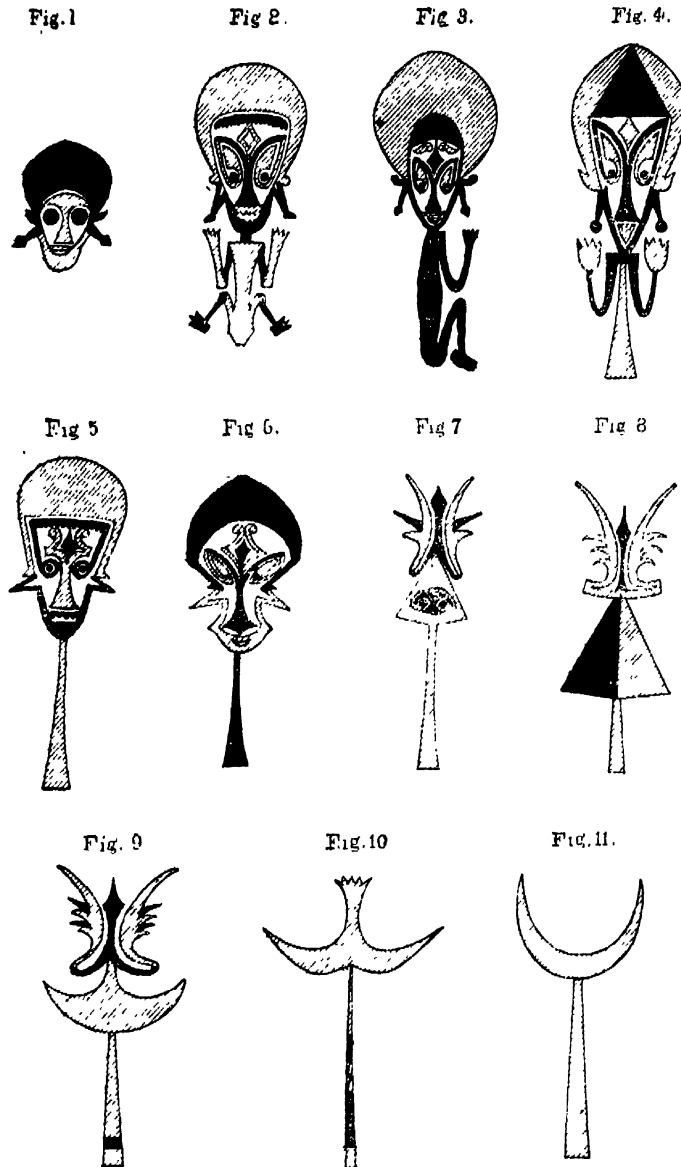

PLATE 3.—Ornamentations copied from a series of canoe paddles from New Ireland, showing the gradual degeneration of the representation of the human form into a crescent-shaped ornament.

bells were probably derived from them through the wooden bells such as those used in Japan. The clapper is a late addition to the bell, which does not exist in Japan or China. It is worthy of note that the large wooden drums of Fiji and Papua are used for the same purpose as bells, to summon large meetings and communicate general warnings or similar intelligence. Dr. Michlucho Maclay has given a full account of their use in New Guinea.

good; but the Japanese and Chinese seem never to have idealised the human countenance, except perhaps in their representations of Buddhist gods, the faces of which are however more or less Indian in type, so that the idea was probably derived, with the religion, from extraneous sources.

A considerable series is devoted to the development of religious properties of various kinds from different parts of

the world. Side by side are placed the coarse wax models of breasts, hands, feet, eyes, and other parts of the human body offered up at the present time in Roman Catholic shrines in France and elsewhere by persons who have been cured of diseases in those parts, and the exactly similar earthenware models of the same parts which were used for the same purpose in ancient Cyprus, and have been found there in excavations. It is most curious how exactly the two series correspond. A small collection comprehends the representations of the Mother and Child of various races. Side by side may be seen and compared the Peruvian, Cyprian, Egyptian, Indian, Chinese, and Christian embodiments of this idea.

Several series are devoted to the curious question of the development of pattern ornament. The development of patterns appears to have arisen in two ways: either drawings of various natural objects have been made upon weapons, implements, and utensils, and these drawings, having become more and more conventionalised by succes-

sive copyings, have degenerated into patterns which have in many instances been subsequently elaborated as such; or various patterns have been from the first suggested by various articles often used in connection with the objects ornamented, by coils of string, or by wire, or by nets, or accidental markings on the objects themselves. Patterns thus once commenced have been gradually modified, and have run through a series of changes which can be traced step by step. A particular elaborate pattern is a thing which has probably arisen only once in the progress of evolution, and in tracing its history we trace at the same time the history of the race which makes use of it. It may yield as important evidence as even language itself.

The earliest known ornamentations are those of primitive man found in the caves of Europe. They are all representations of animals, figures of the mammoth, cave-bear, or reindeer scratched on ivory or bone. Some of the most interesting of General Pitt Rivers' series are those which show how such rude figures gradually de-

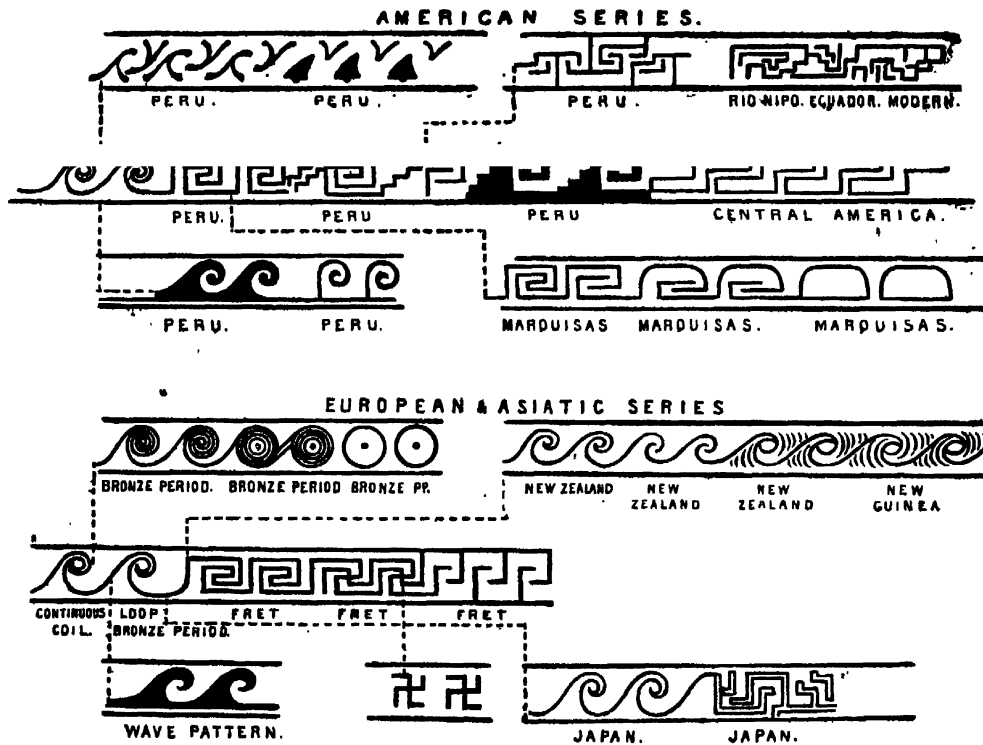

PLATE 4.—Series of diagrams to illustrate the various modifications of the double loop coil ornament in the Old and New Worlds.

generate into mere conventional pattern ornaments. One of the most striking examples is one described by him in his address to the Department of Anthropology at the meeting of the British Association at Brighton in 1872. It is the series of transformations which are undergone by a figure of a human head represented on their paddles by the natives of New Ireland. The series is shown in the annexed woodcut (Plate 3), taken from the specimens exhibited in the collection. The human figure gradually loses its limbs and body, then the sides of the face, leaving only the nose and ears, and ultimately the nose only, which finally expands at the base, and is converted into the representation of a half moon. In this sequence we have an exact parallel to the transformations observed upon ancient British coins by Mr. John Evans, by which the representation of the chariot and horses of Victory on a coin of Philip of Macedon becomes converted into a single horse, and ultimately into fragments of a horse.

Amongst the natives of the North-West coast of America

a curious intricate conventional ornament represented on all their paddles and many other objects, is derived from an albatross head, as shown in a series in the collection. A series of curved wooden sharp-edged clubs or glaives show how the form of a fish, to represent which the curved head of the club is carved, degenerates into a single W ornament, the remains of the fish's mouth. Mr. Brooke Low has in his Bornean collection already referred to a series of native fabrics ornamented with elaborate patterns, each of which pattern has a name, usually the name of an animal. One pattern is evidently a representation of a crocodile, it is so named, and others are derived from it. He finds it impossible to determine in many instances by examination from what form the other patterns have been derived, but believes that the history of their origin survives in their names. One name given to them was, for example, "cat," referring to the animal, from a drawing of which the pattern was originally developed. No doubt all the curious patterns in vogue

in Polynesia, New Guinea, and elsewhere, have a definite history and meaning yet to be traced. Modern European patterns have also interesting histories to disclose. One of the series in the collection explains the origin of the lozenge- and leaf-pattern common on oak carvings from the intersections of the Gothic arch and ogee arch.

Of the development of ornament from chance marks upon objects, the most interesting example exhibited is probably an Australian boomerang, which happens to have three small round black knots on one side of it placed at equal intervals. The savage owner, struck by the appearance of the knots, burnt a series of similar black marks at equal distances all along the one face of the boomerang, to complete the natural pattern, and then, pleased with his work, put a series of lozenge-shaped marks to correspond on the other side of the weapon. At the Sandwich Islands a most beautiful ornament of the gourds used for water is derived from the net-bag in which the gourds were slung. No doubt the pattern at first became accidentally printed on the gourds, and were afterwards elaborated.

The last series to which we shall draw attention relates to the transformations of the curious ornament which General Pitt Rivers calls the double-loop coil, and which is characteristic of all New Zealand weapons and implements, canoes and houses. The ornament was probably originally copied from coils of string or wire. The distribution of the ornament is very interesting. It is found abundantly in New Guinea, so exactly corresponding to the New Zealand form that it seems certainly to point to some connection between the islanders or partial migration from New Guinea to New Zealand at some time or other, unless some floating object may have conveyed the pattern. A similar ornament occurs in the far-off Marquesas Islands, the natives of which in several other matters of culture show affinity with the Melancians. It is also very common on Mexican and Peruvian works of art, and especially on gold figures, where it is represented in its former live form by spiral coils of fine wire. From the double-loop coil, as General Pitt Rivers has shown, many other patterns are derived. The fret or key pattern is merely a continuous loop-coil squared. Other patterns, such as the wave pattern, are derived from the coil by slight degeneration. Some of the most marked patterns derived from it are shown in the accompanying figure (Plate 4), which explains itself. It is most curious how nearly parallel the series of modifications attained in the Old and the New World run to one another.

In conclusion we can only express a hope that the Pitt Rivers collection will be accepted by the nation on its generous donor's conditions, and we strongly recommend any of our readers who have not studied it to pay it a long visit at once, and profit by the varied fund of instruction and entertainment which it cannot fail to impart.

#### THE MASON COLLEGE, BIRMINGHAM

THE Josiah Mason Science College, which is to be opened by an interesting address from Prof. Huxley to-morrow, was begun about five years ago by the venerable and generous donor, Sir Josiah Mason. It is intended to cover ground not occupied by any other of the numerous educational institutions of Birmingham, to which it promises to be an addition of the highest value. The building itself is described as a lofty and spacious Gothic pile, covering about an acre in extent in the very heart of Birmingham.

By its foundation deed the College is established to provide instruction, as far as possible, in mathematics, abstract and applied; physics, both mathematical and experimental; chemistry, theoretical, practical, and applied; the natural sciences, especially geology and mineralogy, with their application to mines and metal-

lurgy; botany and zoology, with special application to manufactures; physiology, with special reference to the laws of health; the English, French, and German languages; and the scheme may, in the discretion of the trustees, include all such other branches of instruction as will conduce to a sound practical knowledge of scientific subjects, excluding mere literary education. The trustees have also power to make provision for instruction in art as well as in science; and, by a supplemental deed, they are authorised to include in the course of study certain subjects requisite for the training of medical students. There is no restriction of the advantages of the college as to sex, creed, or birthplace; but, other things being equal, preference is to be given to candidates who have been educated in Sir Josiah Mason's Orphanage at Erdington, and after these to persons born in Birmingham or Kidderminster, the latter being the founder's birthplace. One wise provision of the deed empowers the trustees, with certain reservations, to alter the course of teaching and the arrangements of the instruction when a change is considered desirable, and at stated intervals the trustees are required to take the arrangements into consideration with a view to revision. At present the branches for which provision is made are confined to mathematics, physics, chemistry, and biology. The mathematical professor is Mr. J. M. Hill, M.A., London, B.A., Cantab, Fellow of University College, London. Physics are taught by Prof. J. H. Poynting, M.A., B.Sc., London, Fellow of Trinity College, Cambridge. The chemistry professor is Mr. W. A. Tilden, D.Sc., London, F.R.S.; and biology is represented by Prof. T. W. Bridge, M.A., F.Z.S. According to present arrangements instruction is provided in the elementary as well as the higher branches of the sciences taught, with a special view to their application to the industries of the Midland district. The course is also designed to prepare students for the degrees of B.Sc. and D.Sc. in the University of London.

The internal arrangements seem to be altogether admirable. The main corridor abuts on two noble apartments, each 48 feet by 30 feet—one intended for the library and reading-room, the other for the physical laboratory—both rooms being provided with ante-rooms. On the first floor, the chief and central room, situated in the front of the building, is the chemical lecture theatre, 50 feet by 33 feet, fitted with seats, tier above tier, for the accommodation of 155 students. The male students will occupy the lower half and the female students the seats above and behind them, a separate entrance being provided for each sex. The mechanical arrangements and apparatus for the use of the lecturer and the carrying away of noxious fumes are of the most complete and ingenious character, and the assistants' ante-room, for the preparation of chemical experiments, is on an equally satisfactory scale. Class-rooms for electricity, magnetism, biology, physics, and models, and a couple of spacious lecture theatres, each 47 feet by 30 feet, one for biology and mathematics, the other for physics, occupy the remaining space on the first floor. The second floor is devoted principally to the chemical departments, for which the arrangements are of the most complete and elaborate character. A large room, 52 feet by 33 feet, in the front of the building, over the chemical lecture theatre, will be used as a general assembly or examination room, and will be available for the meetings of scientific societies. The two laboratories situated at the back of the building, and lit both by windows and skylights, measure together about 104 feet long by 32 feet wide. In the larger laboratory, intended for qualitative analysis, there are four double operating-tables fitted with sinks, gas and water for forty students, in addition to a large unnumbered table in the middle of the apartment for long trains of chemical apparatus. The laboratory for quantitative analysis contains similar fittings and appliances

for thirty-two students. On the third floor a large and lofty central room, with open timber roof, partially lit from the roof, is intended for a museum. The basement story, extending under the whole of the ground floor, is lofty and well lighted, and contains store-rooms, rooms for special operations in physics and chemistry, a large room for mineralogy, rooms for living animals, boilers, &c. Altogether the building contains at present about 100 rooms. The heating and ventilating arrangements are upon a somewhat novel plan. Near the centre of the area rises a huge chimney-stack to the height of 160 feet, containing three flues divided by thin partitions. The smoke from the boiler passes off by the central flue and heats the air in the adjoining flues, which are used for ventilating the lecture theatres. The warming is effected by a coil of pipes containing 4,475 superficial feet, and fed with water from the large boiler in a vault in the sub-basement. The arrangements in fact are throughout of the most modern and approved types, having been adopted by the architect after mature consideration of all the best features of the principal scientific colleges in this country and on the Continent, which he visited at the request of the trustees.

The generous founder, who has taken a most active interest in the progress of the work, has built the college and furnished its various departments entirely at his own cost, so that the large endowments previously conveyed to the trustees remain untouched. Sir Josiah Mason has stated that his ambition was to afford all classes in the Midland district, where he had been born and bred, the means of carrying on those scientific studies of which he had felt the want as completely and thoroughly as they can be prosecuted in any of the great science schools of Europe.

We earnestly trust that the noble and benevolent intention of the founder will continue to be carried out, and that in time the institution will become as important and comprehensive a centre of higher education as Owens College is now.

#### THE PROPOSED LICK OBSERVATORY

MR. S. W. BURNHAM has printed his Report to the Trustees of the "James Lick Trust" of observations made on Mount Hamilton, California, with reference to the location of the observatory, for the erection and endowment of which funds are thereby provided. His object being to test the adaptation of the site for astronomical purposes by observations of double-stars mainly, Mr. Burnham took with him his 6-inch refractor, by Alvan Clark and Sons, which he has used in nearly all his astronomical work, and the excellence of which has been sufficiently proved by the number of difficult double-stars discovered with it during the last six or eight years. He remained on Mount Hamilton from August 17 to October 16, and in this interval was in the observatory on every clear night, with three exceptions. During the first thirty-seven nights he states vision was first-class on all occasions with these exceptions; on two nights the ocean fogs from the valley below reached the summit of the mountain and remained all night, and on two other nights there was only medium steadiness. The kind of weather for astronomical observations during the whole period of sixty days that Mr. Burnham remained at the summit, was forty-two first-class nights, seven medium nights, and eleven cloudy and foggy ones. In the whole interval there was not a single poor night when it was clear. By first-class seeing Mr. Burnham explains that he means "such a night as will allow of the use of the highest powers to advantage, giving sharp, well-defined images, and where the closest and most difficult double-stars within the grasp of the instrument can be satisfactorily measured." The conditions were generally very permanent for the whole night, which is not often the case in ordinary

localities. On many nights Mr. Burnham remained at the telescope until daylight, and so had abundant opportunities of noting this important fact.

Having provided himself with a series of cardboard disks, with apertures increasing from one inch up to the full aperture of the object-glass, Mr. Burnham observed a large number of familiar objects, contracting the light until the smaller star was just distinctly visible; many of these objects had been used elsewhere for a similar purpose. He considers some of the observations are remarkable, allowing for the difficulty of the objects with much larger apertures in other localities:  $\mu^2$  Hercules (the close pair) was very fairly seen with the full aperture, and the companion of  $\alpha^2$  Capricorni was plain with the aperture contracted to 4 inches, and was seen double with the whole six; these objects Mr. Burnham says he is confident have "never been seen before with so small an object-glass." The fifth and sixth stars of  $\theta^2$  Orionis were very plain at an hour-angle of  $4\frac{1}{2}$  hours;  $\zeta$  Hercules was well seen with  $3\frac{1}{2}$  in.; and  $\eta$  Cassiopeæ was easy when the aperture was reduced to  $1\frac{1}{2}$  inch. Forty-two new double stars were detected, and micrometrical measures of ninety of these objects previously named were put upon record. A great many were examined by daylight, but the air, during the greater part of the day at least, was not found to be steadier than is ordinarily the case elsewhere. It is mentioned, however, that the fifth and sixth stars of the trapezium of Orion were beautifully seen in broad daylight just before sunrise. At the epoch 1879'684 the first measure was made fifteen minutes before sunrise, and "both stars were readily seen for some time after this." Venus was very readily seen with the naked eye at any hour of the day, and easily found without any instrumental indication of its place. Mr. Burnham urges that the new double stars brought to light evidence better than anything else can, what may be done at Mount Hamilton, and remarking that these discoveries were effected with an instrument which in these days of great refractors would be regarded as a comparatively inferior telescope, he considers that it is impossible to overestimate the great discoveries which might be made at this station with a first-class object-glass, such for instance as the Naval Observatory, Washington, already possesses, or the proposed Pulkowa glass of twenty-five times the light-power of the one employed; and according to the terms of the Trust the telescope for Mount Hamilton is required to be "superior to and more powerful than any telescope ever yet made;" a condition, however, which perhaps may not be so easily fulfilled as laid down. Mr. Burnham concludes from his experiences on Mount Hamilton that it "offers advantages superior to those found at any point where a permanent observatory has been established." The station is about fifty miles south of San Francisco and twenty-six miles nearly east of San José, the nearest point of railway connection. The ocean fogs, which might have been feared, were not found to reach the elevation, except rarely. Nearly every night this fog, commencing soon after sunset, comes in from the Pacific between the Golden Gate on the north and the Bay of Monterey on the south, and covers the whole valley, but is ordinarily perhaps 2,000 feet below the summit of the mountain, which has an elevation of 4,250 feet above the level of the sea, and has no sensible effect at such altitude.

It will be seen that Mr. Burnham's knowledge of the locality is confined to the space of two months, but a letter from Prof. Davidson of the U.S. Coast Survey, who has had long experience at other seasons, is appended to the report, which is of a very favourable nature, and Mr. Burnham appears to have no hesitation in advising the adoption of Mount Hamilton as the site of the Lick Observatory, which we may hope will be successful in procuring an instrument worthy of the other great astronomical



advantages which it is likely to possess. The geographical position of the observatory peak is in longitude  $121^{\circ} 36' 40''$  W., latitude  $37^{\circ} 21' 3''$  N.

*THE UNITED STATES WEATHER MAPS FOR OCTOBER AND NOVEMBER 1878*

THE WEATHER MAP for OCTOBER 1878, which appeared in our issue of August 19, showed an area of barometric depression overspreading the whole of the United States except a narrow patch extending from Great Salt Lake northwards. The depression was deepest in the region of Minnesota, where it was  $0.150$  inch under the average, stretching thence in a west-south-west direction toward San Diego, where it was  $0.077$  inch below the mean. On the Atlantic sea-board of the States, pressure was  $0.014$  inch in the south and  $0.033$  inch in the north below the average, and continued relatively low right across the Atlantic, the depression deepening to another minimum over the region including the north-west of Ireland and Scotland, where the greatest defect from the average reached  $0.220$  inch. This widespread depression stretched still further to eastward over the whole of Europe, except the extreme north of Scandinavia, the southern half of Italy, and all Russia, except its north-western provinces; and to southward at least as far as the equator. Another extensive region of low pressure covered the whole of Asia to the south of a line drawn from Shanghai round by Lake Balkash to the Persian Gulf, and extended south-eastward over the whole of the East India Islands and Australasia as far as the east coast of New Zealand, where atmospheric pressure rose to the average of the month. Pressure was also much under the average in Cape Colony and Mauritius.

On the other hand pressure was above the average over the head waters of the Platte and Missouri rivers, and from Vancouver Island northward over the north-west of America, rising to an excess of  $0.180$  inch in Alaska. But the most important area of high pressure covered Greenland, where it rose in the south to  $0.244$  inch above the mean, and spread to the south-westward over Labrador, Newfoundland, and the Dominion of Canada as far as Montreal, and to the eastward over Iceland and the north of Scandinavia. A third area of extensive high pressure embraced the southern half of Italy, Greece, Egypt, Syria, nearly the whole of European Russia, and all Asia to the north of the area of low pressure already pointed out.

The distribution of the temperature anomalies of the month were of the simplest character in their relations to this anomalous distribution of the pressure. In the States to westward of the line of greatest barometric depression a reference to the map will show an extraordinary prevalence of strong north-west winds, where, consequently, temperatures were low, the defect from the average being  $4^{\circ}.8$  at Winnipeg,  $4^{\circ}.0$  on the Platte,  $3^{\circ}.6$  on the Lower Columbia, and  $2^{\circ}.6$  at San Diego. On the other hand, temperatures were everywhere above the average to the east of the Mississippi, the excess being nearly  $5^{\circ}.0$  in the New England States, but only about the third of a degree in Florida in the south, and in Newfoundland in the north.

Turning now to the great depression north-west of the British Islands, winds were northerly in Iceland and South Greenland, and there the temperature was respectively  $2^{\circ}.3$  and  $1^{\circ}.1$  below the average. Pressure rose higher from west to east over Europe as far as the Ural River, and into Asia as far as the Tobol, where it was fully  $0.100$  inch above the mean pressure of October. Westerly and southerly winds accordingly ruled, and temperatures were everywhere above the average over this large tract of the earth's surface, the greatest excess being in the basin of the Dnieper, the maximum  $7^{\circ}.6$

being recorded at Kiev. Pressure was  $0.012$  inch in excess of the average in Syria and Egypt, but the northerly winds in Syria indicate a lower pressure southward, and in accordance therewith temperature was  $2^{\circ}.0$  at Beyrout and  $0^{\circ}.7$  at Alexandria below the mean. From the rivers Ural and Tobol eastward through Siberia to the Sea of Okhotsk, temperatures were at all places below the average, the defect being from  $2^{\circ}.0$  to  $3^{\circ}.0$  in the basins of the Obi, Yenisei, Amoor, and Peiho.

It has been stated that pressure was  $0.244$  inch above the average in South Greenland. At the two more northern stations however the excess was only  $0.205$  inch and  $0.112$  inch; and in accordance with this diminution of the pressure northwards over Greenland it is to be noted that whilst in the extreme south of Greenland the temperature was below the average, it rose above it at the stations further north successively to  $0^{\circ}.5$ ,  $3^{\circ}.1$ , and  $4^{\circ}.0$ .

NOVEMBER, 1878, the U.S. Weather Map for which accompanies this notice, is memorable as the commencement of a period of unprecedentedly cold weather in the British Isles, which was protracted with scarcely even a temporary interruption to the middle of December, 1879.

In the United States pressure was above the mean to westward of the Mississippi and Missouri, the greatest excess,  $0.090$  inch, being near the sources of the latter river. Over the rest of the States and Canada pressure was under the average, there being at least three distinct centres of greater depression formed in this extensive region, one over Minnesota and Lake Winnipeg; a second along the St. Lawrence valley, and thence northward probably away towards the head of Baffin Bay, the greatest observed defect from the average being  $0.131$  inch near Anticosti; and a third along the north of the Gulf of Mexico. In Alaska pressure was fully half an inch below the mean of November.

But the most marked feature of the month was the development of a region of high pressure in mid-Atlantic and thence northward over Iceland and Greenland; the greatest excess,  $0.362$  inch above the average, occurring in the north-west of Iceland. Immediately to eastward an area of low pressure overspread the whole of Europe, rising however to the average on the southern, eastern, and northern, as well as on the western, limits of the continent. Within this extensive depression, just as in the American depression, were developed several centres of still greater depression, viz., in the Baltic, North Sea, north-west of France, and Corsica. Another area of low pressure extended over India, the Philippine Islands, the East Indian Archipelago, Eastern Australia, Tasmania, and New Zealand. Over the whole of the rest of Asia, the north and east of Africa, and the south and west of Australia atmospheric pressure was above the average.

The temperature anomalies in the United States were quite extraordinary. Within and immediately to eastward of the western barometric depression temperatures were from  $12^{\circ}.4$  to  $13^{\circ}.7$  above the normal for the month, and over this region southerly winds prevailed; whereas immediately to westward, winds were westerly and northerly, and temperature fell to  $3^{\circ}.4$  above the normal, and on the Pacific coast to the normal. On the South Atlantic and Gulf States winds were northerly and the temperature only about half a degree above the normal. In connection with the St. Lawrence valley depression, the temperature anomalies were  $6^{\circ}.0$  in the Upper Lake region,  $4^{\circ}.0$  in Ohio valley,  $3^{\circ}.6$  in the Lower Lake region, and  $1^{\circ}.0$  in the St. Lawrence valley above the normal.

In the west of Greenland, the pressure anomalies of the three stations proceeding northward were  $0.130$  inch,  $0.048$  inch above, and  $0.016$  inch below the mean, and from the strong southerly winds resulting therefrom the temperature anomalies were respectively  $6^{\circ}.8$ ,  $9^{\circ}.0$ , and  $9^{\circ}.5$ , almost rivalling the relative excesses of temperature which made the weather of this month so memorable over large portions of the States. As higher pressures





ruled to westward from the North Cape to the Straits of Gibraltar, strong northerly winds swept over the whole of Western Europe, and the temperature everywhere fell below the average of the season, the defect being  $4^{\circ}\cdot3$  in the north of Norway,  $4^{\circ}$  in Farö,  $4^{\circ}\cdot4$  in Islay,  $2^{\circ}\cdot8$  in Jersey, and  $5^{\circ}\cdot6$  in Portugal. This area of low temperature stretched eastward into Europe as far as Vienna, Trieste, and Mentone.

To the east of the line of lowest pressure within the great barometric depression which covered all Europe except its extreme outskirts, temperatures were above the average, and greatly so as far east as the head waters of Yenisei, and thence round by Taschkend, Syria, and the north of Africa. Over the greater portion of this broad region the excess was not less than  $5^{\circ}$ , and in the north of the Black Sea it reached as high as  $9^{\circ}\cdot4$  above the normal. In Eastern Siberia, Mantchooria, and Northern China very low temperatures prevailed, a deficiency of  $8^{\circ}\cdot1$  being recorded on the Upper Amoor.

The chief features of the meteorology of the northern hemisphere for November, 1878, and they are very striking, were these:—(1) The almost unprecedentedly high temperature, amounting to from  $6^{\circ}$  to  $13^{\circ}\cdot7$  above the average over a large part of the United States, from  $6^{\circ}\cdot8$  to  $9^{\circ}\cdot5$  above the average over West Greenland; an excess of from  $5^{\circ}$  to  $9^{\circ}\cdot5$  over nearly the whole of European Russia and Western Siberia; (2) large and extensive barometric depressions formed in conjunction with these most anomalous temperatures; and (3) the formation of an area of high pressure—inclosed within remarkably steep gradients of mean monthly pressure—over mid-Atlantic, extending thence in a north-easterly direction over Iceland toward Spitzbergen. To this it may be added that, whilst the high temperature anomaly of the surrounding low pressure regions rose to  $13^{\circ}\cdot7$  in the United States,  $9^{\circ}\cdot5$  in Greenland, and  $9^{\circ}\cdot4$  in Europe, the low temperature anomaly of the included region of high pressure fell only to  $5^{\circ}\cdot6$  below the normal at Coimbra, but over no great extent did it fall lower than  $4^{\circ}$  below the normal.

The U.S. Weather Maps for December, 1878, and subsequent months, when low temperature anomalies were their out-standing features, will be looked forward to with the greatest interest as likely to throw light on the development of the meteorological conditions which impressed so arctic a character on our British weather during 1878-79. In connection with this large problem it is impossible to overestimate the vital importance of a serious and searching inquiry into the causes which brought about the high temperature anomalies of the United States, Greenland, and Russia. It is to these anomalies in all likelihood we must look for an explanation of the origin of the high pressure in the included region of the North Atlantic, which was undoubtedly the immediate cause of the strong northerly winds and low temperatures which then prevailed over Western Europe.

#### NOTES

PROF. W. CHANDLER ROBERTS, F.R.S., will deliver the introductory lecture to his course of Metallurgy, on Monday next, October 4, at three o'clock, at the Science Schools, South Kensington Museum.

MR. A. C. HADDON, Demonstrator of Comparative Anatomy in the University of Cambridge, with the sanction of the authorities, instead of conducting his class as usual during the Long Vacation at Cambridge, made the novel experiment last summer of taking it to the shores of Torbay, where he established a temporary zoological station on the principle of that at Naples, whither he himself had formerly been sent by the University to

study. The attempt was very successful, and will doubtless be repeated another year. It was found that in addition to the ordinary class-fee of one guinea, a fee of four guineas covered the expenses of the extemporised laboratory, which was sufficiently provided with the instruments and appliances requisite in the present state of zoological study, as well as those of boat-hire for the dredging and surface-skimming excursions that formed the chief outdoor-work of the class, throughout the seven weeks of its stay; while embryological and histological dissections, together with the preparation and preservation of marine specimens for the University Museum, afforded constant occupation at home. The books, mostly monographs, needed for the determination and proper examination of the animals captured, were supplied by the superintendent of the museum, Mr. J. W. Clark, and the class received much valuable assistance from Mr. A. R. Hunt, whose intimate knowledge of the fauna of Torbay was freely placed at its disposal.

MR. MCGIBBON, the Superintendent of the Botanic Gardens, Cape Town, South Africa, a position which he has filled for thirty years, retires on a pension of 150*l.* a year. A movement is on foot to remove the Gardens from their present contracted site in Cape Town itself, and to create in the neighbourhood of the city a botanical establishment more worthy of the seat of South African Government. As a first step the appointment of Director has been offered to the well-known Cape botanist Prof. MacOwan, of Gill College, Somerset East. It is, however, doubtful whether the state of his health will allow of his undertaking it.

ON the 21st inst. there died at his residence in Camberwell, at the advanced age of 89, Charles Johnson, who for more than forty-four years held the post of Professor of Botany at Guy's Hospital. He was editor of Sowerby's "English Botany," author of "Grasses of Great Britain," "British Poisonous Plants," "Ferns of Great Britain," and other valuable contributions to natural history. In early life he took up the study of natural science, being one of the first members of the City Philosophical Society, of which Dr. Faraday and other eminent men were fellow-members. He was a high authority on agriculture and all subjects connected with economic botany.

THE death is announced of Prof. Samuel Stehman Haldeman, Professor of Comparative Philology in the Pennsylvania University, at the age of sixty-eight years. In 1836 he was employed in the geological survey of New Jersey, and in the following year in that of his native State, Pennsylvania. Dr. Haldeman filled the chair of Natural History in the University of Philadelphia and in a Delaware college, and was Professor of Geology and Chemistry to the State Agricultural Society of Pennsylvania prior to accepting the post which he held at his death. Other deaths announced are, on August 27, Dr. Hanstein, Professor of Botany and director of the Botanic Garden at Bonn; and on August 21, Prof. E. B. Andrews, of the Geological Survey of Ohio, the author of several important contributions to the geology of that State.

MR. DARWIN has forwarded to us an article contributed to an American medical journal by Dr. B. G. Wilder, Professor of Physiology in Cornell University, on "The Two Kinds of Vivisection—Sensisection and Callisection;" as he thinks the suggestion therein contained deserves consideration in this country. "All well informed persons," Dr. Wilder writes, "are aware that the vast majority of vivisections, in this country at least, are performed under the influence of anaesthetics; but the enthusiastic zoölaters, who desire to abolish the objective method of teaching physiology, practically ignore this fact, and dwell chiefly upon the comparatively infrequent operations which are attended with pain. Having read the

arguments upon both sides and had some correspondence with leaders of the anti-vivisection movement, I have been led to think that the discussion may be simplified, and a right conclusion sooner reached, if we adopt new terms corresponding to the two kinds of experimentation. Having waited long in the hope that some candid discussion of the whole subject might contain the needed terms, I venture to suggest that painful vivisection be known as *sentisection*, and painless vivisection as *callisection*. The etymology of the former word is obvious; the distinctive element of the latter is the Latin *callus*, which, in a derived sense, may denote a nervous condition unrecognised, strictly speaking, by the ancients. Some idea of the relative numbers of callisectionists and sentisectionists may be gained from the fact that I have been teaching physiology in a university for twelve years, and for half that time in a medical school; yet I have never performed a sentisection, unless under that head should be included the drowning of cats, and the application of water at the temperature of 60° C. (140° F.), with the view to ascertain whether such treatment would be likely to succeed with human beings. I think that even elementary physiological instruction is incomplete without callisection, but that sentisection should be the unwelcome prerogative of the very few whose natural and acquired powers of body and mind qualify them above others to determine what experiments should be done to perform them properly, and to wisely interpret the results. Such men, deserving alike of the highest honour and the deepest pity, should exercise their solemn office not only unrestrained by law, but upheld by the general sentiment of the profession and the public."

AMERICAN papers speak of remarkable clouds of flies that have visited various districts. At East Pictou, Nova Scotia (about 44° 50' N., 63° W.), such a cloud was seen on August 21. "They passed Lismore about six o'clock in the evening close to the shore. They went with the wind, which was blowing lightly from the west, occupying about twenty minutes passing a given point. They made a loud buzzing noise, which was heard by many who missed seeing them. They flew so low that some of them appeared to fall into the water. About two miles below Lismore they slightly changed their flight, heading more to the north. After their passage numbers of strange flies were observed in some of the houses near the shore. They were about half an inch in length, with wings proportionately longer than those of the common house-fly, but whether they belonged to the swarm is uncertain." At Halifax, Nova Scotia, immense swarms passed over Guysboro' (lat. 44° 40' N., long. 61° 30' W.), on September 5. They came from the east and resembled a dark cloud. A communication from Poughkeepsie, New York (lat. 41° 50' N., long. 74° W.) states that a storm of flies was encountered on the Hudson River on the afternoon of September 4. The steamer *Martin*, bound south, encountered the fly storm between New Hamburg and Newburgh. It seemed like a great drift of black snow, and it reached southward from shore to shore as far as the eye could reach. There were millions upon millions of the flies, and they hurried northward as thick as snow-flakes driven by a strong wind. They were long and black and had light wings, and the cloud must have been miles in length. Our readers may remember that some weeks ago we recorded a somewhat similar phenomenon as having been seen in various parts of France.

A VERY successful attempt has been made to measure a base-line, near Aarberg, for the triangulation of Switzerland. The first measurement gave 2400'087 metres; the second, made independently of the first, gave 2400'085 metres as the result, the difference between the two being thus only two millimetres. The measurement was made under the direction of the Spanish General Ibanez, who invented the instrument by which the work

was done. The place selected for the line is on the Siselen road, which presents here an almost straight and level line of three kilometres.

A CONGRESS is to be held from October 1 to 10 at Saragossa, to discuss matters relating to the phylloxera.

THE "Elephant Sugar Cane" of Cochin China, which is said, though this requires confirmation, to reach a height of eleven feet and a diameter of seven inches in six months, has been successfully introduced by the Royal Gardens, Kew, from Saigon, into Jamaica. The rather sensational reputation of this variety has excited a good deal of interest in it amongst the West Indian planters.

MR. ROLAND TRIMEN, the Curator of the South African Museum, has arrived in this country.

THE Annual Report of the Smithsonian Institute for 1878 shows that it continues to be as active as ever in the advancement of scientific knowledge. In all its departments a vast amount of work has been done during the year, much of this work being really of an international character. Many valuable additions were made to the National Museum during the year, and several monographs of the first importance published. One of the principal papers in the volume is a memoir of the late Prof. Joseph Henry, by Prof. Asa Gray. About 100 pages are devoted to a paper by Mr. W. B. Taylor on "Henry and the Telegraph," and another long paper describes Henry's researches on sound, with special reference to fog-signalling. Other papers are a translation of Arago's biography of Condorcet; Ernest Favre's biographical notice of Louis Agassiz; "The Effect of Irritation of a Polarised Nerve;" "Pflüger's Electrotonus," by Dr. B. F. Lautenbach; "Researches on Fever," by Dr. H. C. Wood; "Constants of Nature," by Prof. John LeConte; list of apparatus relating to heat, light, electricity, magnetism, and sound, available for scientific researches involving accurate measurements, in various institutions in the United States; "Ornithological Exploration of the Caribbee Islands," by Mr. F. A. Ober; "Report of Explorations in Greenland," by L. Kumlein.

VOL. XVI. of the *Transactions and Proceedings* of the Royal Society of Victoria contains the results of a very satisfactory year's work. The following are among the papers in this volume:—"On the Relation between Forest Lands and Climate in Victoria," by R. L. J. Ellery, F.R.S.; "Experiments on the Tensile Strength of a few of the Colonial Timbers," by Fred. A. Campbell, C.E.; "The Diorites and Granites of Swift's Creek and their Contact Zones, with Notes on the Auriferous Deposits," by A. W. Howitt, F.G.S.; "On the Genus *Amathia* of Lamaroux, with a Description of a New Species," by the Rev. J. E. Tenison-Woods, F.G.S., &c.; "Notes on the Customs of Mota, Banks Islands," by the Rev. R. H. Codrington, M.A., Oxford, with Remarks by the Rev. Lorimer Fison, Fiji; "Some New Localities for Minerals in Victoria," by J. Cosmo Newberry; "The Tidal Datum of Hobson's Bay," by R. L. J. Ellery, F.R.S.; "Notes on the Geology of the West Tamar District, Tasmania," by Norman Taylor; "Observations of the Outer Satellite of Mars in 1879," by E. J. White, F.R.A.S. Williams and Norgate are the London agents of this Society.

THE Government of India has offered the prize of 100l. for the best "Manual of Hygiene," to serve as a text-book for the use of the British soldiers in that country. Works submitted in competition for this prize must be sent in by their authors to the Secretary to the Government of India in the Military Department at Calcutta, so as to reach his hands not later than the last day of next March. The work is "to be written in clear and simple English, and thoroughly practical, showing the ordinary causes

affecting health, and the special dangers to which British soldiers are exposed in India, more particularly during their first year in the country, and the best means by which those dangers may be averted." The work, if accepted, will be printed at the public expense, and become the property of the State; and it is not to exceed in bulk "more than fifty or sixty pages of print, of small pica, octavo size."

AN ingenious method for obviating the frequent stoppage of trains at stations, and yet accommodating the passengers from these stations, has been devised by M. Hanrez. A "waiting carriage," comprising a steam-engine with special gear, and space for passengers and luggage, is placed on a siding at the station, and picked up by the train as it goes past. The latter, by means of a hook on its last carriage, catches a ring supported on a post, and connected with a cable wound on a drum in the waiting carriage. Thereupon the drum begins to unwind, and in doing so compresses a system of springs, while the carriage is moved at a rate gradually increasing to that of the train. The engine of the carriage then winds in the cable, the train and carriages are connected, passengers are transferred (the carriages being of the American type) from the joined carriage to the train, and *vice versa*, then the two are disconnected, and the engine of the carriage, working on the wheels, brings it back to the station whence it was taken.

MR. R. TUCKER writes:—A verification of M. Jandry's statement (NATURE, vol. xxii. p. 495) may be acceptable:—

$$2^8 + 1 = 2^{64} + 1 = 18446744073709551617 \\ = 274177 \times 67280421310721.$$

THOSE of our readers who have girls to educate we recommend to consult the Queen's College Calendar for 1880-81, published by Macmillan and Co.

THE Sanitary Institute seems to have had a very successful meeting last week, all the usual topics embraced in its programme coming on for discussion. Dr. B. W. Richardson gave a very interesting and instructive lecture on "Woman as a Sanitary Reformer," one of the first conditions being her education in physiology and such other sciences and arts as bear on every-day household life. Dr. Richardson made it clear that if women were educated as they ought to be they would be an immense power in keeping houses and households in a healthy condition.

WE have received the new calendar of the Newcastle College of Science. The classes in this institution now include mathematics, experimental physics with laboratory, chemistry with laboratory, geology, including geological surveying, natural history, land surveying, mining, modern history, French, German, mechanical drawing.

ABOUT 88,000*l.* has now been subscribed towards the cost of the projected new University College at Liverpool, and little more will be needed to make up the amount required. It was originally intended to raise 80,000*l.* for the endowment of seven professorships and two lectureships; but part of the money subscribed (about 7,000*l.*) has been contributed towards the foundation of a Roscoe chair of art—a professorship not originally contemplated; Lord Derby gives 10,000*l.* to found a chair of natural history; Messrs. William, S. G., and P. H. Rathbone give a like sum to found a King Alfred chair of modern history and literature; Mr. A. H. Brown, M.P., and Messrs. Cressfield and Barrow also give 10,000*l.* to found a chair of ancient history; Mrs. Grant subscribes a similar amount to found a chair in some branch of science; and 10,000*l.* is given by the trustees of the late Mr. Roger Lyon Jones to the Royal Infirmary School of Medicine, to found a chair of experimental physics, with which mathematics will be for the time associated. Between 7,000*l.* and 8,000*l.* has been subscribed towards founding a chair

of philosophy, logic, and political economy. Though the endowment funds are nearly complete, there remains the cost of a building to be provided.

WE have received from Madras Dr. Oppert's work "On the Weapons, Army Organisation, and Political Maxims of the Ancient Hindus, with special reference to Gunpowder and Firearms."

THE Aristotelian Society, which was founded last spring for the systematic study of philosophy, has just completed its work for this session, having studied philosophy from Thales to Proclus. The session for 1880-81 will open on October 11 at 20, John Street, Adelphi, at 8 p.m., when an introductory address will be delivered by the President, Mr. Shadworth H. Hodgson, LL.D., on "Philosophy in Relation to its History." During the session the Society intends to study mediæval philosophy, and the whole of modern philosophy, from Bacon to Comte and Spencer.

A SOCIETY for the Promotion of Agricultural Science has been formed in the United States, which will meet annually for the reading of papers, and which will in other ways endeavour to encourage scientific research in connection with agriculture. Such papers as are likely to be of permanent value will be published. Prof. W. J. Beal of Lansing, Michigan, is president of the society.

AT the last meeting of the Balloon Society a letter was read from M. de Fonvielle offering to bring over a balloon with a gas capacity of 42,000 feet, and compete with Mr. Wright in his balloon, both balloons to start simultaneously from the Crystal Palace in a contest for the longest aerial distance travelled in some particular direction. The proposal was referred to a committee.

WE have received a handsome quarto publication, "Contributions to the Archæology of Missouri, by the Archæological Section of the St. Louis Academy of Science." This first part is devoted to Pottery; it will be followed by others, the object being to furnish to those interested in the archæology of the country, a reliable statement of facts connected with the occurrence of prehistoric remains in this important region. The present volume contains a general description of the south-eastern Missouri district and of the pottery which has been found in such abundance in the burial mounds of that region. Several charts and plans and figures of characteristic specimens of the pottery, beautifully drawn and lithographed, have been selected for illustration. The authors of the two papers in the volume are Mr. W. B. Potter and Dr. E. Evans. Should the present venture meet with encouragement other volumes may soon be expected treating of "Implements," "The Construction and Grouping of Earthworks," and "Osteological Remains." We trust the enterprise will meet with the encouragement it well deserves. The volume is published by George A. Bates, Naturalists' Bureau, Salem, Mass.

AN unusually severe shock of earthquake was felt at Fribourg on Sunday, the 19th inst., about 11 a.m. A smart earthquake shock was felt at Morat at 8 o'clock, a.m., on the 21st, and another twelve hours later at Fribourg, which, though of shorter duration than that of Sunday, caused considerable alarm. An earthquake took place at Wellington, New Zealand, on July 28.

A SILESIAN Botanical Exchange Club has been established, evidently intended for the exchange of specimens among botanists of all countries. A copy of the rules may be obtained by applying to Herr Adolph Toepffer, Bandenburg an der Havel, Prussia.

DR. HECTOR, of the New Zealand Geological Survey, expresses his opinion that in Westland and Otago vast auriferous tracts remain as yet untouched.

"THE Monthly Index to Current Periodical Literature, Proceedings of Learned Societies, and Government Publications," published at the office of the *American Bookseller*, New York, seems to us a very useful publication.

THE passage of the meteor referred to in Mr. Thwaites' letter last week, occupied one and a half, not eleven and a half seconds.

THE additions to the Zoological Society's Gardens during the past week include a Macaque Monkey (*Macacus cynomolgus*) from India, presented by Major Gape; an Egyptian Jerboa (*Dipus aegyptius*) from Egypt, presented by Dr. Hastings; a Cape Bucephalus (*Bucephalus capensis*) from South Africa, presented by Mr. C. B. Pillans; two Black-faced Spider Monkeys (*Ateles ater*) from East Peru, a Southern River Hog (*Potamochoerus africanus*) from South Africa, a Razor-billed Curassow (*Mitua tuberosa*) from Guiana, a Yarrell's Curassow (*Crax carunculata*) from South-East Brazil, a Blue and Yellow Macaw (*Ara ararauna*), two Orinoco Geese (*Chenalopex jubata*) from South America, two Rufous Tinamous (*Rhynchotus rufescens*) from Brazil, deposited; a Common Rhea (*Rhea americana*) from South America, a Spotted-billed Toucanet (*Selenidera maculirostris*) from Brazil, an Electric Silurus (*Malapterurus beninensis*) from West Africa, purchased.

#### BIOLOGICAL NOTES

TRANSVERSE COMMISSURE IN ARTHROPODS.—From a recent memoir laid before the Belgian Academy by M. Lienard (*Archives de Biologie*, tom. i. fasc. 2), it would appear that an arrangement of the cephalic nerve-centres, hitherto thought to have been peculiar to Crustacea, is really to be found in nearly the whole of the Arthropoda. It has been long known that in Crustaceans, e.g., Decapoda, besides the super and sub-oesophagean ganglionic masses and their lateral connections, there is a well-marked transverse commissure, situated in front of the sub-oesophagean mass, and immediately behind the oesophagus. This commissure in other Arthropoda seems, from quite technical causes, to have escaped notice. M. Lienard finds it nearly everywhere among the Myriapoda, Coleoptera, Odonata, Lepidoptera, Hemiptera, Diptera (nymphs and larvæ). He has dissected the complete ring in nearly 100 forms, belonging to 70 genera. He is trying to ascertain the origin of the fibres which form the transverse commissure.

THE HÆMATOPETIC FUNCTION.—In a recent paper to *R. Accademia dei Lincei*, Sig. Fileti describes the effects of splenotomy as observed by him in dogs. Some of these are as follows:—Immediately after the operation (the previous régime of life being maintained) the quantity of hæmoglobin increases for a short time, and more in old than in young animals. Next it diminishes much and progressively in old animals, but without reaching half the normal quantity. In a third phase there is a slow progressive increase, which by degrees brings the quantity up to and above the normal. In young animals the diminution is much less, and the quantity of hæmoglobin sooner reaches and surpasses the normal. In all cases the weight of the animal does not diminish, but may even considerably increase (under good hygienic and alimentary conditions). Sig. Fileti adds some chemical observations as to colorations obtained with hydrochloric acid and yellow prussiate of potash. It clearly appears (he concludes) that, the spleen being removed, the marrow of the bones does not compensate for its function. As the quantity of hæmoglobin first increases—and we cannot admit a real increase in production as resulting from splenotomy—we must suppose that in this brief period the failure of the spleen makes itself felt more in destruction than in production. The former of these functions comes to be compensated more quickly, and there is then a gradual diminution in production of hæmoglobin as a direct consequence of the spleen being absent, and this diminution is greater the less able the marrow is to act, i.e. the older the animal. When, finally, the hæmatopœtic function of the spleen has been completely compensated by the marrow of the bones, the quantity of hæmoglobin returns to the normal figure, and may even surpass it. Sig. Fileti is studying the influence of light on the production of hæmoglobin.

DEVELOPMENT OF LEPIDOSTEUS.—In an interesting memoir read at the last meeting of the British Association (Swansea) Prof. F. M. Balfour and Mr. W. N. Parker gave the results of their investigations of some larval forms of Lepidosteus which had been most liberally supplied to them by Prof. Alexander Agassiz. Some of the more important of these were:—1. That the segmentation was, as in the sturgeon, complete, but the larger segments of the lower pole very early fused together to form a yolk sac. 2. That the epiblast was divided into nervous and epidermic layers, and that the nervous system was formed by a solid thickening of the epiblast, as in Teleostei, and not by the closure of a groove, as in the sturgeon. 3. That the lens of the eye and auditory vesicle were developed from the nervous layer of the epidermis. 4. That the general relation of the embryo to the yolk, and the general characters of the germinal layers are precisely like those in Teleostei. 5. That there is present a suctorial disk in front of the mouth, with numerous papillæ, as was first noticed by Agassiz; this disappears in the adult, and is probably a persisting rudiment of a primitive vertebrate organ, remains of which are also found in the adhesive papillæ of larval ascidians, the adhesive disks of larval amphibians, &c.

VISCERAL ANATOMY OF HERRING.—Mr. F. W. Bennett calls attention to the following, it would seem new, fact in the visceral anatomy of this common fish (*Journ. Anat. and Physiol.*, July, 1880). It possesses an extremely long air-bladder, which stretches towards the head, terminating near the labyrinth of the auditory organs. About the middle of its length it is connected by a duct with the stomach. The latter is capacious and elongated; while the commencement of the mid-gut is near the gullet the posterior portion of the stomach continues on into the ductus pneumaticus. This communication will be found most usually closed with mucus; but Mr. Bennett points out that there is another and a more important communication between the air-bladder and the cloaca. Till within one half-inch of this latter the air-bladder retains its well-known and beautiful silvery appearance; this then suddenly ceases, and the remainder of the bladder is muscular. This will account perhaps for its having been overlooked so long; what the exact uses of this passage may be are not yet known, but it is certain that it affords freer passage for gas than the duct leading into the stomach. Bristles may be readily passed through it, and gas may be made to bubble out if slight pressure be carefully applied under water. The usual arrangement of the apertures of the cloaca is as follows:—In front lies the anus, then the generative aperture, and hindmost of all, the urinary duct opens; the opening of the duct now described by Mr. Bennett lies between the anus and the urinary aperture, and usually to the left of the genital aperture.

MONSTROUS BEETLES.—Mr. Horace F. Jayne has recently published, in the *Trans. American Entom. Soc.*, vol. viii. pp. 155–62, Pl. IV., descriptions of some monstrosities observed in North American Coleoptera, all of which belong to that class to which the terms "Monstra per excessum" and "Monstres polyméliens" have been applied. They belong to the genera *Calosoma*, *Cychrus*, *Melanus*, *Pasimachus*, *Scarites*, *Dyschirius*, *Chlanis*, *Lichnanthe*, *Polyphylla*, *Strategus*, *Telephorus*, *Prionus*, *Elcodes*, and *Helops*, and form an interesting addition to the already numerous recorded instances of this kind of monstrosity in beetles. All show a tendency to reduplication in some of the cephalic or thoracic appendages. In some it is the antennæ, in others the palpi, in others the legs, that are thus affected, and in some cases the tendency is exhibited in more than one of these appendages in the same individual. Beetles appear to be particularly liable to the production of such monstrosities, but it is probable that, no parallel instance like that here recorded and illustrated by Mr. Jayne in an example of a longicorn beetle (*Prionus californicus*) has been noticed. In it each maxillary palpus has two terminal joints, and each femur has two perfectly-formed tibiæ and tarsi, with the claws, &c., the whole monstrous development being remarkably symmetrical; the labial palpi and the antennæ are normal, as is all the rest of the insect. Mr. Jayne contents himself by describing and figuring these interesting monsters, and does not venture upon any suggestions as to causes, in which he is perhaps wise, considering the uncertainty that exists as to the origin of parallel monstrosities in animals far higher in the scale. Reduplication of cephalic, thoracic, and probably abdominal appendages in the Arthropoda is by no means rare, but it is possible that a distinct combination of two individuals more or less united in one, such as is sometimes found in vertebrates, does not exist.

**DIGESTION IN PLANTS.**—Dr. Lawson Tait has recently investigated afresh the Digestive Principle of Plants. While he has obtained complete proof of a digestive process in *Cephalotus*, *Nepenthes*, *Dionaea*, and the *Droseraceae*, he entirely failed with *Sarracenia* and *Darlingtonia*. The fluid separated from *Drosera binata* he found to contain two substances, to which he gives the names "droserin" and "azerin." Dr. Tait confirms Sir J. D. Hooker's statement that the fluid removed from the living pitcher of *Nepenthes* into a glass vessel does not digest. A series of experiments led him to the conclusion that the acid must resemble lactic acid, at least in its properties. The glands in the pitchers of *Nepenthes* he states to be quite analogous to the peptic follicles of the human stomach; and when the process of digestion is conducted with albumen, the products are exactly the same as when pepsine is engaged. The results give the same reactions with reagents, especially the characteristic violet with oxide of copper and potash, and there can be no doubt that they are peptones.

**STIPULES IN ONAGRACEÆ.**—Prof. Baillon says (*Bull. mensuel. Soc. Lin. de Paris*, No. 33) that in the majority of works on descriptive botany, this family is mentioned as characterised by the constant absence of stipules, and in justification of this quotes the classical works of Decaisne, Duchartre, Endlicher, and Hooker; nevertheless he states that the existence of these organs in this family admits of easy proof, not indeed that they ever occur of large dimensions, for then they could not have escaped detection, but still they are present, more commonly as little subulate tongue-like bodies, acute, often red-coloured at the base of the petioles in both opposite and alternate-leaved plants. In *Haya* they soon turn black and wither off early. In the fuchsia of our gardens little stipules are often present. In *Circea* they can also be detected. In the *Lopezia* of our gardens all the leaves have two very distinct stipules, which indeed have been often referred to in botanical works, and it is the same with *Haloragia*, though Bentham and Hooker describe them as here absent.

**A NEW GREEN CILIATED PLANT.**—Under the title of "A New Ciliated Organism furnished with Chlorophyll," Prof. van Tieghem has published (*Bull. Soc. Bot. France*, 1880, p. 130) a memoir of a strange new form. The organism in question was found by Prof. Perrier twice: once at Roscoff, in sea-water containing algae and some of the lower animals; and again at the Museum (Paris), in a little aquarium in the laboratory. It presents the appearance of a gelatinous tremulous mass of a pure green colour; in outline well defined, spherical or oval in shape, attaining more than a centimetre in diameter, and attached by a portion of its periphery to a large marine alga. At first sight it would be called a Nostoc. Exposed to sunlight it gave out oxygen, so one concludes its colouring-matter to be chlorophyll. On a closer inspection it is seen that the mass is composed of a colourless jelly, scattered throughout which are isolated green points, visible to the unassisted eye, and sufficiently numerous as to give to the whole mass the green coloration distinguishing it, so one would not now refer it to Nostoc. Each little green body is spherical, and measures from three to four-tenths of a millimetre. It is formed of a very finely granular and somewhat dark protoplasm, very uniformly permeated with an amorphous chlorophyll; neither nuclei nor vacuoles, nor red spot were detected, and the surrounding membrane was very thin. At one place (called the pole) the cell bore a tuft of vibratile cilia which were attached side by side, so as to cover a space more or less large according to age and to allow of independent movements. On the equator at two diametrically opposite points a small hollow in the green mass is seen, and by these passes a band of homogeneous protoplasm which traverses the membrane, turning towards the pole, and in the superior hemisphere dividing on its outer border into fine fringes with vibratile cilia. These cilia are confluent at their base, and are not independent in their movements. In process of development the polar cilia become detached (absolutely fall off), next the lateral moustaches disappear (these seem to be retracted), a continuous membrane covers over all, but the general aspect and dimensions remain unchanged. Later on the cell divides into two (equatorially), next it divides again (perpendicularly), and the segmentation continues until there is a family of sixteen rounded-off cells, and the organism has passed through a phase of encystment. Lastly each daughter cell increases in size, separates more and more from its neighbour, gets closed in a fine membrane, and then appears all covered over with cilia. It now escapes into the water and secretes in

abundance a gelatinous material. The clothing of cilia drops off as the form approaches its adult size: soon appear the polar cilia, next the lateral moustaches; and so far its life-history is complete. At no phase in its development was either cellulose detected in its cell-membrane, nor starch in its protoplasm. Prof. van Tieghem concludes:—"Is this organism an animal or a plant? I am not well able to say, and I must add besides that this question, to which formerly so much importance attached, in the actual condition of science, appears to me to be destitute of interest." It is called *Dimyctax perrieri*. With every respect to the dictum of so distinguished a botanist as Prof. Tieghem, we venture to call our readers' attention to this strange form, which M. Roze seems disposed to regard as an animal, in the hopes that some of them may assist in determining its proper position in nature.

### PHYSICAL NOTES

A FRESH measurement has been made by Mr. T. C. Mendenhall of the acceleration of gravity at Tokio, an account of which appears in the *American Journal of Science*. The experiments were made after the accepted methods with Kater's and Borda's pendulums, the only novelty introduced being that of employing a chronograph in connection with a reliable chronometer to determine the time of vibration of the pendulum. At every sixtieth or hundredth vibration of the pendulum a light break-circuit apparatus placed beneath it was raised to just such a height as to be "thrown" by the pendulum at its lowest point of swing, thus enabling its rate to be calculated to the ten-thousandth of a second. Mr. Mendenhall considers his determinations to be more reliable than those of Professors Ayrton and Perry, which were made with a long wire pendulum; he revises their calculations, altering their value of "g" from 9'7974 to 9'7979, and asserts that their calculation of the theoretical value by Clairaut's formula is wrong, and should be 9'7980, not 9'797 (metres). His own determinations give a mean result of 9'7984.

A SECONDARY battery, the electrodes of which consist of porous fragments of gas-carbon, has been devised by M. Henri Sauvage. Though inferior in power and durability to a perfectly "formed" Plante cell with lead electrodes, this cell would be cheaper, more readily and rapidly constructed, and would yield a current of longer duration. The action is probably due to the occlusion of the hydrogen and oxygen gases respectively in the pores of the carbon. The inventor recommends that the two plates used as electrodes be kept apart with a simple thin wooden frame.

PROF. O. N. ROOD calls attention to the fact that when the colour of ultramarine blue is mixed with white by the method of rotating disks the tint appears to verge towards violet. Brücke advanced the explanation that what we call white is really a reddish colour. Aubert, on the contrary, regarded it as showing that violet is only a pale shade of ultramarine blue. A series of experiments made with other colours showed that when mixed thus with white green-yellow becomes greenish, and green green-blue, that full yellow and orange incline to red, and red becomes purplish. These observations accord with neither theory, and Prof. Rood advances none himself. He thinks that the fact as it stands explains why it is impossible in the polariscope to produce a red free from purplish tint, there always being white light mingled with the red rays.

PROF. J. TROWBRIDGE, in investigating with telephones connected to earth plates the flow of return-currents through "earth," found that at a mile from the Harvard College Observatory the time-signals of the observatory clock could be heard by merely tapping the earth at points fifty feet apart.

FROM his recent researches on dilatation and compressibility of gases under strong pressures, M. Amagat derives (*Comptes rendus*, August 30) the following laws:—1. The coefficient of dilatation of gases (for temperatures not too much above the critical) increases with the pressure to a maximum, then decreasing indefinitely. 2. This maximum occurs under the pressure with which the product  $p\nu$  is minimum, where the gas accidentally follows Mariotte's law. 3. It diminishes for higher and higher temperatures, and at length disappears. 4. At a sufficiently high temperature the compressibility of fluids is represented by the formula  $p(\nu - \alpha) = \text{const.}$ ;  $\alpha$  being the smallest volume the mass of fluid can occupy; this is the limiting law. For each gas  $\alpha$  has a special value. 5. For pressures



below the critical the deviation (from Mariotte's law), first positive for a temperature sufficiently low, becomes *nil*, then negative, with increasing temperature; but beyond a certain negative value it diminishes indefinitely without changing sign. 6. For pressures between the critical pressures and a superior limit, special for each gas, the period during which the deviation is positive is preceded at a lower temperature by a period in which it is negative; so that the deviation twice changes sign. 7. Beyond the upper limit of pressure indicated in the preceding law the deviation is always negative, whatever the temperature; it diminishes, in general, when the temperature increases, except for pressures near the limit, where its variation is more complicated.

It is known that rain and other meteoric waters contain a quantity of gas and saline matters which they find in the atmosphere and carry with them. The amount varies with the seasons, but may be estimated, on an average, at about 8 cc. of oxygen, and 0.50 to 0.60 cc. carbonic anhydride per litre, along with small quantities of ammonia, nitrite, nitrate, and carbonate of ammonium, organic matters, and chloride of sodium. In a recent paper to the Belgian Academy M. de Koninck holds that in the alteration and metamorphism of rocks by infiltration of those waters may be found the solutions of many questions in geology hitherto unsolved. The facts he cites relate to tertiary and quaternary deposits which in many parts of Belgium are so transformed by the waters in question that it is impossible to recognise them if account be taken only of petrographic characters.

FROM observing how different persons gave different estimates of the apparent size of blood-corpuscles seen in the microscope, M. Montigny was led to make a series of further experiments on the subject (which are described in the *Bulletin* of the Belgian Academy, No. 6). He comes to the conclusion that even for good observers an estimation of the kind referred to is principally affected by the length of distinct vision, but that often this appreciation is subject to the influence of occult causes which affect the relation between sensation and judgment. The examination of microscopic objects may be influenced, like astronomical observations, by a kind of *personal error*, by reason of which individuals have a tendency to see microscopic images, some larger, others smaller, than they should appear, abstraction being made of the influence of the length of distinct vision on our appreciations. These conclusions, it is pointed out, do not at all affect the exactness of measurements determined by *savants* with the microscope, but they tend to show that each observer should measure for himself the different magnifying powers of the instrument he uses, obtained by changes of eye-pieces and objectives.

WITH the view of demonstrating the mechanical action of electrolysis, all action of heat being excluded, Signor Basso has lately experimented thus (*Il Nuovo Cim.*, ser. 3, tom. vii.). A thin square glass plate is covered with collodion, and on this when dry is put a thin layer of good gelatine, mixed with about  $\frac{1}{20}$  of its weight of a saturated solution of bichromate of potash. The bare side of the plate is exposed to light, to attach the gelatine layer. Then the plate is put in an aqueous solution of chloride of gold till the upper layer is impregnated with the gold salt, and it is exposed to diffused daylight. Next the covered side is strewed with fine graphite, and the glass connected by means of four fine wires running along its sides to the negative pole of a battery. The plate is then placed in an ordinary bath of sulphate of copper. The copper is deposited regularly on the whole of it. In a few days wrinkles and bubbles appear; and if the copper have been deposited as far as the borders, the plate may at length even break, thus proving the mechanical force, which is a direct consequence of electrostriction.

#### ON THE PRESENT STATE OF SPECTRUM ANALYSIS<sup>1</sup>

AT the Sheffield meeting of the British Association a committee was appointed to report on the present state of spectrum analysis. The committee has this year presented its first report. The report is divided into four parts:—

1. On the spectra of metalloids, drawn up by Dr. A. Schuster.
2. On the influence of temperature and pressure on the spectra of gases, drawn up by Dr. A. Schuster.

<sup>1</sup> Abstract of Report read at the Swansea meeting of the British Association.

3. On the emission spectra of the rays of high refrangibility, drawn up by Prof. W. N. Hartley.

4. On the absorption spectra of the rays of high refrangibility, drawn up by Prof. A. K. Huntington.

In the report on the spectra of metalloids, we have for each element a full account of the literature on the subject with all necessary references. The various spectra of each metalloid and its compounds are enumerated, and special stress is laid on the discussion which nearly always has taken place on the chemical origin of these spectra. It will be found that often more work is needed to clear up doubtful points, but there is no special controversy at issue at the present moment except in the case of the carbon spectra. A discussion of very long standing is still occupying the minds of many spectroscopists as to whether the spectrum which is seen at the base of every candle flame is due to carbon or to a hydrocarbon. The arguments and experiments on either side are given in detail and are finally summed up as follows:—"Those who believe the spectrum to be due to the element carbon rely chiefly on the brilliancy with which these bands are developed when cyanogen is burnt in oxygen, also when the spark is taken in cyanogen, carbon tetrachloride, and carbonic oxide at high pressure; all the gases being dried with the greatest care. Those who oppose this view and who hold that the spectrum is due to a hydrocarbon refer to the impossibility of excluding all traces of moisture, and to the fact that this spectrum is well developed under circumstances where we know hydrocarbons to be present."

When cyanogen is burnt a series of bands appears in the blue violet and ultra-violet, and another controversy has taken place whether these bands are due to carbon or to a compound of carbon and nitrogen. Two papers have lately appeared on the subject. One by Mr. Lockyer, in which he describes an experiment in which the bands were seen in a spark taken in carbon tetrachloride, although the nitrogen lines were not visible in the jar discharge; and another by Professors Living and Dewar, in which these bands were traced to impurities of nitrogen in all cases in which they were seen. A spark in carbonic oxide showed the bands when the gas was prepared from ferrocyanide of potassium, but not when it was made by heating a mixture of quicklime with pure and dry potassium oxalate. When all the air had been properly expelled a tube containing carbon tetrachloride did not show the bands.

The following quotation will give an idea of the points which are discussed in the second report:—

"We shall endeavour for clearness' sake to arrange our material under five different heads. We shall first discuss what changes we have a right to expect in the appearance of a spectrum, if the quantity of luminous matter is increased or if the temperature is raised, the absorbing properties of the gas remaining unaltered. We shall next speak of the widening of lines, which, as we shall see, often accompanies an increase of pressure. Then we shall treat of the different spectra given by one and the same body at different temperatures; and we shall see how far satisfactory explanations have been offered for their existence.

"So far our road will be clear; but we shall see that these spectra of different orders, as they have been called, are only extreme cases of continuous changes which are nearly always going on. Very often we can refer these continuous changes to a gradual displacement of one spectrum by another; but often we shall not be able to prove the existence of a second spectrum. There is *à priori* nothing impossible or even improbable in the view that the relative intensity of different lines may be different at different temperatures, and often when we observe a variation we may equally well explain it by assuming the gradual appearance of a new spectrum or an alteration only in the relative intensities of the lines. It becomes then a matter of extreme difficulty to decide which of the two suppositions is correct. In doubtful cases we may often be able to obtain important information by means of a method which is little understood even by spectroscopists. It is the method which has first been extensively used and investigated by Mr. Lockyer of projecting an image of the luminous source, spark, arc, or flame on the slit of the spectroscope and thus localising the spectra, which are thrown and confused together if the luminous source is examined directly without the interposition of a lens. We shall see how by means of this method we shall often at a single glance be able to tell how the body will behave at different temperatures and under different pressures. Many facts which have been quoted as remarkable might have been foretold by means of this method. Our fourth chapter will be devoted to it. In our last chapter we

shall have to give an account of some changes which have not found a place under the previous heads."

Space will only permit us to quote a few of the questions raised. It is now generally admitted that pressure is the principal cause which determines the widening of lines, but it is not generally known that a different appearance of the lines may be presented according as the pressure is due to the impact of similar or dissimilar molecules; thus a molecule of sodium will widen its lines more easily in an atmosphere of sodium than in another atmosphere. Mr. Lockyer has observed that the lines of oxygen or nitrogen may be obtained sharp at atmospheric pressure by mixing a small quantity of one gas with the other. The gas which is present in small quantities has its lines sharp.

The curious fact is mentioned that when a line widens unsymmetrically it widens in nearly all cases more towards the red, and then towards the violet end.

In that part of the report which relates to multiple spectra an account is given of the gradual spreading of the opinion that these spectra are due to different molecular groupings. The question of long and short lines is next discussed, and great stress is laid on the fact that the longest lines are by no means always the strongest. An abstract of Mr. Lockyer's work on the subject is given, and of the confirmation which his results have found in later work. Thus Mr. Lockyer found that the longest lines were always the first to be reversed. Professors Liveing and Dewar have since examined the absorption-spectra of many metallic vapours. The lines which they have seen reversed were nearly in all cases those which are longest in the spark, though not always those which are strongest. Results obtained by M. Lecoq de Boisbaudran with sparks, the temperature of which was lower than in the ordinary jar-discharge, also confirm Mr. Lockyer's results. Discussing the attempts which have been made to explain these and other facts, it is again mentioned that we must assume the impacts of a similar molecule to produce a greater effect than the impacts of a dissimilar one. The last part of the report treats of some other changes in the relative intensities of lines. We only mention the experiments in which Mr. Lockyer found sometimes the green sodium line to be present without the well-known yellow double line. The report concludes as follows:—

"We have here again two hypotheses, that of molecular shocks and that of molecular combinations. Both explain the facts satisfactorily, and I do not think that one of them necessarily excludes the other. I believe, on the contrary, that a line can be drawn, and that while the regular changes observed chiefly in band-spectra may be due to one cause, the often irregular changes in metallic spectra, where one set of lines disappears and another appears often on the violet side, but sometimes towards the red, may be due to another cause.

"It is often said that we must not ascribe the same phenomenon to two different causes, when one of them is sufficient to explain it; but the point at issue is whether the phenomena are the same in all cases. An advance of science has constantly led to the separation of phenomena which were formerly considered to be connected together, and we believe that the further development of the different points we have attempted to discuss, in which different observers have strongly taken up opposite opinions, will lead to the blending together of different views rather than the entire elimination of one of them."

Prof. Hartley, in his part of the report, gives us an account of our knowledge on emission spectra in the ultra-violet region. He treats especially of the researches on the solar spectrum by Mascart, Draper, and Cornu.

Prof. A. K. Huntington reports on the absorption spectra in the ultra-violet region. The results obtained by Prof. Stokes and Dr. Miller are given in detail. Amongst the results obtained by Dr. Miller, it seems especially interesting to notice the connection which apparently exists between the absorbing properties of a liquid and that of its vapour. When one of them is transparent to the ultra-violet rays the other is also, and *vice versa*.

Prof. Sorlet, it is well known, constructed a few years ago a spectroscope with a fluorescent eyepiece, and has by means of it carried researches in the ultra-violet parts of the spectrum. We notice especially the examination of absorption-spectra of the bases of gadolinite, and the conclusions drawn from it on the existence of new elementary bodies. Prof. Cornu has given much attention to the absorption power of our atmosphere, and we find a full account of his experiments in Prof. Huntington's report. In conclusion we have a short abstract of the work

done by Professors Hartley and Huntington on absorption-spectra in the ultra-violet region. They obtained the following results:—

1. The normal alcohols of the series  $C_4H_{2n-1}OH$  are remarkable for transparency to the ultra-violet rays of the spectrum, pure methylic alcohol being nearly as much so as water.
2. The normal fatty acids exhibit a greater absorption of the more refrangible rays of the ultra-violet spectrum than the normal alcohols containing the same number of carbon atoms.
3. There is an increased absorption of the more refrangible rays corresponding to each increment of  $CH_2$  in the molecule of the alcohols and acids.
4. Like the alcohols and acids, the ethereal salts derived from them are highly transparent to the ultra-violet rays, and do not exhibit absorption-bands.

Interesting results were also obtained by the examination of substances containing the benzene nucleus, and in a separate paper the absorption-spectra of essential oils were examined and discussed. Prof. Hartley has still further extended the researches jointly begun with Prof. Huntington, and has arrived at the conclusion that no molecular arrangement of carbon atoms causes selective absorption, unless three pairs are doubly linked together in a closed chain.

It will be seen that a few only of the branches of spectrum analysis have been discussed in the present report, and next year no doubt will bring us a further instalment of a work which we hope will prove useful to those who are interested in spectroscopic investigations.

## AGRICULTURAL CHEMISTRY<sup>1</sup>

### III.

I HAVE thus far directed attention to some points of importance in connection with the sources of the constituents of our crops, and I must now briefly refer to some in connection with the composition, and to some relating to the uses, of the crops themselves.

As to composition, I must confine myself to indicating something of what is known of the condition of the nitrogen in our various crops; though I had intended to say something respecting the carbohydrates, and especially respecting the various members of the cellulose group.

As to the nitrogen—in our first experiments on the feeding of animals, made in 1847, 1848, and 1849, the results of which were published in the last-mentioned year—we found that, in the case of succulent roots used as food, not only were they not of value as food in proportion to their richness in nitrogen, but when the percentage of it was higher than a certain normal amount, indicating relative succulence and immaturity, they were positively injurious to the animals. So marked was the variation of result according to the condition of maturity or otherwise of the foods employed, that, when reviewing the results of the experiments which had up to that time been conducted, in a paper read before this Section of the British Association at the Belfast meeting in 1852 (and which was published in full in the annual volume<sup>2</sup>), we stated that the mode of estimating the amount of proteine compounds by multiplying the percentage of nitrogen by 6.3 was far from accurate, especially when applied to succulent vegetable foods, and that the individual compounds ought to be determined. The Rothamsted laboratory staff was however much smaller then than it is now, and with the pressure of many other subjects upon us, it was at that time quite impossible to follow up the inquiry in that direction.

It is indeed only within the last ten years or so that the question has been taken up at all systematically; but we are already indebted to E. Schulze, A. Urick, Church, Sachsse, Maercker, Kellner, Vine, Emmerling, and others, for important results relating to it.

Our knowledge in regard to the subject is however still very imperfect. But it is in progress of investigation from two distinctly different points of view—from that of the vegetable physiologist and that of the agricultural chemist. The vegetable physiologist seeks to trace the changes that occur in the germination of the seed, and during the subsequent life-history of the plant, to the production of seed again. The agricultural

<sup>1</sup> Opening Address in Section B (Chemical Science), at the Swansea meeting of the British Association, by J. M. Gilbert, Ph.D., F.R.S., V.B.C.S., F.L.S., President of the Section. Continued from p. 499.

<sup>2</sup> "On the Composition of Foods in relation to Respiration and the Feeding of Animals."

chemist takes the various vegetable products in the condition in which they are used on the farm, or sold from it. And as a very large proportion of what is grown, such as grass, hay, roots, tubers, and various green crops, are not matured productions, it comes to be a matter of great importance to consider whether or not any large proportion of the nitrogenous contents of such products is in such condition as not to be of avail to the animals which consume them in their food?

We cannot say that the whole of the nitrogen in the seeds with which we have to deal exists as albuminoids. But we may safely assume that the nearer they approach to perfect ripeness the less of non-albuminoid nitrogenous matters will they contain; and in the case of the cereal grains at any rate, it is probable that if really perfectly ripe they will contain very nearly the whole of their nitrogen as albuminoids. With regard to some leguminous and other seeds, which contain peculiar nitrogenous bodies, the range may however be wider.

But whatever the condition of the nitrogenous bodies in the seeds we grow or sow, with germination begins a material change. Albuminoids are transformed into peptones, or peptone-like bodies, or degraded into various amido- or other compounds. Such change into more soluble and more diffusible bodies is, it is to be supposed, essential to their free migration, and to their subserviency to the purposes of growth. In the case of the germination, especially of some leguminous seeds, asparagine has been found to be a very prominent product of such degradation of the albuminoids; but it would seem that this disappears as the green parts are developed. But now the plant begins to receive supplies of nitrogen from the soil, as nitrates or ammonia, and it would seem that amides constitute a considerable proportion of the produced nitrogenous bodies, apparently as an intermediate stage in the formation of albuminoids. At any rate, such bodies are found to exist largely in the immature plant; whilst the amount of them diminishes as the plant, or its various parts, approach to maturity.

But not only have we thus, in unripened vegetable productions, a greater or less, and sometimes a very large, proportion of the nitrogenous bodies formed within the plant, existing as amido-compounds, but we may have a large amount existing in the juices as nitric acid, and some as ammonia, &c. Thus, E. Schulze determined the nitric acid in various "roots;" and he found that, in some mangels, more than one-third of the total nitrogen existed in that form, and about one-tenth as much as ammonia. In a considerable series at Rothamsted, we have found an extremely variable proportion existing as nitric acid, according to the size, succulence, or degree of maturity, of the roots; the amount being, as a rule, the least with the ripest and less highly nitrogenous roots, and the most with the most succulent, unripe, and highly nitrogenous ones. In some cases it reached as much as from 20 to nearly 30 per cent. of the total nitrogen. In many other immature vegetable products nitric acid and ammonia have been found; but, so far as I remember, in none in anything like so large a proportion as in the so-called "root-crops," especially mangels. In many, however, the quantity appears to be immaterial; and it is remarkable that whilst there is so much in the "roots," little or none is found in potatoes.

No wonder that, in the experiments already referred to, we found the feeding result to be the worse the more succulent and immature the roots, and the higher their percentage of nitrogen, accordingly.

But it is to the difference in amount of the albuminoid bodies themselves, in different descriptions of vegetable produce, that I wish specially to direct attention, making, however, some reference to what is known of the proportion of the nitrogen existing as amido-compounds.

In some mangels E. Schulze found only from about 20 to 22 per cent. of their total nitrogen to exist as insoluble and soluble albumin. But he found in one case 32.5, and in the other 40.8 per cent. of the total nitrogen as amides. In a large series of determinations at Rothamsted, by Church's method, we found a variation of from under 20 to over 40 per cent. of the total nitrogen of mangels to exist as albuminoids; or, in other words, from nearly 60 to over 80 per cent. of it in the non-albuminoid condition.

In potatoes Schulze found from under 50 to 65 per cent. of the total nitrogen as soluble and insoluble albumin, and from 27.7 to 49.1 per cent. as neutral and acid amides. In a series of potatoes grown at Rothamsted, under very various conditions as to manuring, and in two different seasons, we found the nitrogen as albuminoids to range from little over 50 to more than 71

per cent. of the total nitrogen, leaving, of course, from less than 30 to nearly 50 per cent. to be accounted for in other ways.

Kellner determined the amount of nitrogen as albuminoids, and as amido-compounds, in a considerable series of green foods, both leguminous and gramineous, cut at different stages of their growth. The proportion of the total nitrogen not as albuminoids was, upon the whole, greater in the leguminosæ than in the gramineæ. In both, however, the proportion as albuminoids increased as the plants approached to maturity. The proportion as albuminoids was in all these products very much larger than in roots, and generally larger than in potatoes. In the case of first-crop meadow-hay we found in the separated gramineous herbage 76.4, in the leguminous herbage 82, and in the miscellaneous herbage 80.3 per cent. of the nitrogen as albuminoids; and in the second crop 86.2 per cent. in the gramineous, 88.3 per cent. in the leguminous, and 88.1 per cent. in the miscellaneous herbage. How far the higher proportion of the nitrogen as albuminoids in the second crops is to be taken as any indication of the characteristics of the autumn growth, or how far it is to be attributed to the accidental condition of the weather, may be a question.

These illustrations are sufficient to give some idea of the range and proportion of the nitrogen in different feeding crops which does not exist as albuminoids; and they are sufficient to show that a very large proportion of the non-albuminoid matter exists as various amido-compounds. The question arises, therefore, whether these bodies contribute in any way to the nutrition of the animals which feed upon them? We have but little experimental evidence on this point. As green herbage is the natural food of many descriptions of animal, we might suppose that characteristic constituents of it would not be without some value as food; but the cultivated root crops are much more artificial productions, and it is in them that we find such a very large proportion of non-albuminoid nitrogen. With respect to some of the amido-compounds, at any rate, direct experiments seem to show that they are digested in the animal body, and increase the elimination of urea. Weiske and Schrodt found that rabbits receiving, as their only nitrogenous food, either asparagine or gelatin, wasted and died; but a rabbit receiving both asparagine and gelatin increased in weight and survived to the end of the experiment, which lasted seventy-two days. From the results of other experiments made with sheep, they concluded that both asparagine and gelatin protect the albuminoids of the body from oxidation.

The considerations lead me, in conclusion, to refer briefly, and I promise it shall be as briefly as is consistent with clearness, to the two very much disputed questions of the origin of muscular power, and the sources of the fat of the animal body. These subjects Mr. Lawes and myself have frequently discussed elsewhere; but as the controversy has assumed a new phase quite recently it seems desirable and appropriate that I should recur to it on the present occasion.

With regard to the question of the sources in the food of the fat of the animal body, Liebig originally maintained that although fat might be formed from the nitrogenous compounds within the body, the main source of it in the herbivora was the carbohydrates. In his later writings he sharply criticised the experiment and arguments of those who have maintained the formation of fat chiefly from the proteine compounds, but he at the same time seems to attach more importance to that source than he formerly did. He gives it as his opinion that the question cannot be settled by experiments with herbivora. He adds that what we know with certainty is that, with these animals, albuminates and carbohydrates work together to produce fat; but whether the non-nitrogenous product, fat, has its origin in the albumin or in the carbohydrate he considers it not easy to determine.

At the time when we commenced our experiments on the feeding of animals in 1847 the question whether the fat of the animals fed for human food was mainly derived from albuminoids or from carbohydrates had been scarcely raised, or at least it was not prominent. The question then was rather—whether the herbivora received their fat ready formed in their food, or whether it was produced within the body—the latter view being that which Liebig had so forcibly urged, at the same time maintaining that at any rate its chief source was the carbohydrates. Accordingly our experiments were not specially arranged to determine whether or not the whole of the fat produced could or could not be derived from the albuminoids.

For each description of animal, oxen, sheep, and pigs, such

As confirmatory of Darwin's theory of descent, they possess a value neither greater nor less than that of all other animal classes. The lecturer's forthcoming work on the Foraminifera of Mauritius will contain much detailed evidence in support of his views.

In the discussion which followed, Herr Wacker suggested that the point of difference between Carpenter and Moebius lay in the fact that Carpenter had regard to the sarcode rather than to the skeleton, to which latter Moebius attached the greater importance.

The second paper was given by Dr. Gabriel, whose subject was "The Classification of the Gregarinæ." He objected to Stein's classification, hitherto the sole and undisputed one, on the grounds that it no longer fully represented the existing state of our knowledge. This view he was able to support, which he did at some length, and submitted to his hearers a new classification of his own.

In the Section for Anatomy and Physiology Prof. Tauber of Jena lectured upon "Two New Anæsthetics," with which he had experimented upon frogs, rabbits, and dogs. Both anæsthetics produced a scarcely appreciable change in the pulse and respiration, on which account they might be of great value for surgery. And in demonstration of their action Dr. Tauber proceeded to experiment upon a pigeon and a rabbit.

On Tuesday, September 21, at the second general sitting, Prof. Moebius of Kiel read a paper "On the Food of Marine Animals." In the sea therefore is generated by far the greater number of animal types, and these again in quantity and in bulk are throughout regulated by the existing supply of nourishment. This in its turn depends upon the organic matter of plants, which in the sea also supply nourishment to its inhabitants. In our own seas, the North Sea and the English Channel are discoverable near the coast, while twenty to fifty metres lower are other kinds of plants; deeper still, if we search, we shall find few or none. Loose strips of plants that have been torn away from their root, have been brought up from a depth of some hundred metres; in the Baltic and the North Sea these form a dark, soft, spongy mass. Nothing living is visible in this if placed in a tub; but if strained through a sieve, tiny mussels, snails, and crustacea become visible. In the depths of the sea-mud lining the bottom are countless worms, mussels, and little animals which feed upon the spongy mass. Flounders and other fish penetrate into these mud-depths and devour the animals that are there. Where the sea-bottom however is formed of soft clay, nothing beyond a few worms here and there will be found. Thus in the deeper portions of the Mediterranean, otherwise so rich in animal life, nothing at all is discoverable. The Professor in the course of his remarks went on to show that the supply of nourishment to the inhabitants of the sea was now and would be hereafter undiminished; and thus that the propagation of animal life in the sea would continue unchecked, so long as the mighty ocean itself should last.

### SCIENTIFIC SERIALS

*Bulletin de l'Académie Royale des Sciences (de Belgique)*, No. 7.—A Hyperoodon captured on the strand at Hillion (Côte-du-Nord, France) in December, 1879, by M. van Beneden.—On Mysticetes with short fins, from the sands in the neighbourhood of Antwerp, by the same.—On determination of albuminoid substances of the blood serum by circumpolarisation (modified method of Hoppe Seyler), by M. Fredericq.—Contribution to a study of the rôle of insects in the pollinisation of heterostylous flowers (*Primula elatior*), by Mr. MacLeod.

### SOCIETIES AND ACADEMIES

PARIS

Academy of Sciences, September 20.—M. Wurtz in the chair.—The following papers were read:—On the odours of Paris, by M. Sainte-Claire Deville. He analysed some of the most black earth exposed in a trench in the Rue St. Jacques. The amount of salts in the impregnating liquid indicates considerable concentration (which can be easily explained). The dust from horse's shoes and from wheels of vehicles is thought to be the origin of sulphides and protoxide of iron, and of the dark coloration. The escape of gas, estimated at about a tenth of the gas circulating in the pipes, furnishes part of the sulphur, the carbonated hydrogen and the coal-tar which abounds. Through this escape the sub-soil is rendered wholesome (in the author's opinion), and cannot exhale any dangerous odour. There is a slight smell of sulphuretted hydrogen (not worse than

that from sulphurous mineral waters), and a smell of healthy empyreumatic products.—M. de Tchihatchef presented a work of his on Spain, Algeria, and Tunis, but treating chiefly of Algeria. Such questions as the material and moral results of the annexation to France, the mode of action of the new administrative and social institutions, the assimilation of the Arab and the Christian elements, &c., are treated; the author has also studied the geology and botany of the country.—Observations of the new planet Coggia (287) at the Paris Observatory (equatorial of the western tower), by M. Bigourdan.—On a new experiment for showing the direction of the rotation communicated by bodies to polarised light, by M. Govi. A pure spectrum is produced with rectilinearly polarised light, and a plate of rock crystal is interposed, giving a dark band; also an analyser. The spectrum and analyser have a joint movement of rotation (one end of the spectrum being at the centre of the circle of which the spectrum represents the radius). The dark band moves along the spectrum (during rotation) one way or the other according to the nature of the quartz plate (dextrogyrous or levogyrous). If the motion be sufficiently rapid for the impression on the eye to be continuous, one may trace out in space, or on a screen, opposite spirals. Curious variations are obtained by interposing plates of mica, gypsum, &c.—Study of telluric lines of the solar spectrum (Nice Observatory), by M. Thollon. With his powerful spectroscopic, he has resolved the telluric groups B, D, and  $\alpha$  of Angstrom into their simple elements, separating these elements from each other, and from the other metallic lines.—On the liquefaction of ozone and on its colour in the gaseous state, by MM. Hautefeuille and Chappuis. They passed some highly ozonised oxygen (prepared by their new process) into a Caillctet apparatus. From the first strokes of the piston the gaseous mixture appeared azure blue. With several atmospheres' pressure the gas became of an indigo blue, the mercury meniscus looking steel blue through it. Sudden liberation from 75 atm. produced a mist, indicating liquefaction (300 atm. were necessary in the case of oxygen). Ozone is a little less easy to liquefy than carbonic acid. If the ozonised oxygen be not compressed slowly and in cold, the ozone is decomposed, giving a strong detonation and a yellowish flash. Thus the mixture contains an explosive gas.—On Brunton's tunnelling machine, by M. Diver. This gives an account of results with the machine as used in the lignite pits in the Faveau Valley. It appears, *inter alia*, that of 51 horse-power of the motor only 12 $\frac{1}{4}$  was transmitted to the machine, 38 $\frac{1}{6}$  being lost.—Telescope with double action for pointing long-range guns, by M. de Broca.—On losses in manufacture of vinegar, by M. Garcin.

### CONTENTS

PAGE

LANDSLIP . . . . .	505
ARCTIC NEW . . . . .	506
ROD'S BIRDS OF CORNWALL . . . . .	507
DEEP-SEA SOUNDING AND DREDGING . . . . .	508
OUR BOOK SHELF.—	
Byrly's "Elements of the Differential Calculus, with Examples and Applications" . . . . .	509
Rice and Johnson's "Elementary Treatise on the Differential Calculus, founded on the Method of Rates or Fluxions" . . . . .	509
Stevenson's "Spirit-Gravities with Tables" . . . . .	509
LETTERS TO THE EDITOR:—	
Supposed New Island in the Azores.—Prof. T. E. THORPE, F.R.S. . . . .	509
Parthenogenesis in the Coleoptera.—Rev. J. A. OSBORNE . . . . .	509
Observations of Aurora on August 12 and 13.—RALPH COPELAND . . . . .	510
Ice at High Temperatures.—HOS. CARNELLIV . . . . .	511
A Peat Bed in the Drift of Oldham.—G. H. MORTON . . . . .	511
Hardening of Steel.—H. J. JOHNSON-LAVIS . . . . .	511
Mosquitoes.—H. J. JOHNSON-LAVIS . . . . .	511
GENERAL PEEF RIVERS' (LANE FOX) ANTHROPOLOGICAL COLLECTION, II. ( <i>With Illustrations</i> ) . . . . .	511
THE MASON COLLEGE, BIRMINGHAM . . . . .	514
THE PROPOSED LICK OBSERVATORY . . . . .	515
THE UNITED STATES WEATHER MAPS FOR OCTOBER AND NOVEMBER, 1878 . . . . .	516
NOTES . . . . .	517
THEOLOGICAL NOTES:—	
Transverse Commisure in Arthropods . . . . .	520
The Hematopoietic Function . . . . .	
Development of Lepidosteus . . . . .	
Visceral Anatomy of Herring . . . . .	
Monstrous Beetles . . . . .	
Digestion in Pl . . . . .	
Stipules in Onagraceæ . . . . .	
A New Green Ciliated Plant . . . . .	
PHYSICAL NOTE:—	
ON THE PRESENT STATE OF SPECTRUM ANALYSIS . . . . .	522
AGRICULTURAL CHEMISTRY, III. By J. H. GILBERT, Ph.D., F.R.S. . . . .	523
THE GERMAN ASSOCIATION . . . . .	527
SCIENTIFIC SERIALS . . . . .	528
SOCIETIES AND ACADEMIES . . . . .	528

THURSDAY, OCTOBER 7,

## THE PLACE OF SCIENCE IN EDUCATION

THERE has been a great deal said and written on the subject of education during the past week. First of all we have the important address of Prof. Huxley at the opening of the Mason College, Birmingham, which we give in full on another page; then there is the brief but significant address of Sir Stafford Northcote at Tiverton; and lastly, the summary of Sir Charles Reed of the ten years' work of the London School Board. All this has furnished ample food for comment in the daily papers, and their misconceptions as to the real drift of Prof. Huxley's address must be amusing to those who know what science really means, and what are the opinions held by reputable men of science as to what constitutes sound and complete education. With regard to the institution which has been so generously founded and handsomely endowed by Sir Josiah Mason at Birmingham, it should be remembered that there was no intention to start it as a university. Its founder has had to push his way through life, and notwithstanding the unusual success of his career, he confesses that he has but little faith in the rule-of-thumb method, which was often his only guide. At every step, he admits, he was hampered and hindered by the want of scientific knowledge, by his ignorance of those exact methods, those laws and facts, which can only be satisfactorily acquired and utilised by a preliminary scientific training. Even at his advanced age the consciousness of this want is so strongly impressed upon him that, with true benevolence and rare generosity, he has founded the magnificent institution at Birmingham which was opened last Friday, in order that succeeding generations of boys may have a chance of equipping themselves at the outset with those weapons of precision, the want of which he who has fought successfully the battle of life had to deplore at every step. The Mason College at Birmingham is not a mere technical institute, as may be seen from our article in NATURE, vol. xxii. p. 514, in which the course of instruction provided is described. All departments of science are provided for, as well as certain special applications of some of them; the great principles and facts of these sciences first, and their special application afterwards. Wisely also the founder has provided for instruction in the English, French, and German languages; and even, as Prof. Max Müller stated in his brief but admirable address at the luncheon, for Greek and Latin. The deed of foundation makes ample provision for the widening of the programme, the extension of the subjects taught, and the adaptation of the institution to the times. Special reference is made to art, which will no doubt be added. At the same time the founder excludes from his programme "mere literary education." It is, we suppose, this exception—which looking at the programme of the College, seems to us somewhat vague—that has led the daily press to misconceive Prof. Huxley's address as a defence of science as a means of education, to the entire exclusion of literature. What Prof. Huxley maintains, as we read his address, and as we read his other utterances on the same point, is, that if a man is to

have an education in only one aspect of things, then by all means let it be the scientific aspect; on the other side he can educate himself at his leisure, whereas, as Sir Josiah Mason forcibly testifies, when a man gets into the thick of the fight, it is all but impossible for him to make up for the want of scientific training in his youth. As a mental discipline and a means of culture science by itself is as good an implement as literature by itself, and probably a great deal better, as the former takes us into the very heart of nature in its widest sense, while the latter only deals with the outside of things. At the same time Prof. Huxley expressly states that exclusive training in either the one direction or the other is essentially lopsided, and not to be encouraged; that it is essential to the completeness of a man's culture that it should have an æsthetic and literary, as well as a scientific side; and what other opinion could be held by one who himself seems familiar with "the best that has been said and thought" in all the languages of culture. We are much mistaken if Prof. Huxley would not endorse every word spoken by Prof. Max Müller, on the necessity for the study of the science of man, the science of thinking and of speaking, to a completely liberal education. The truth is that there is a widespread misconception as to what science really means; we have been so long accustomed to apply the term to certain groups of concrete facts, that we forget that it may be applied, and indeed is now frequently applied, to any branch of knowledge investigated on the method which has been so fruitful in the study of physical phenomena. Science indeed is merely the counterpart of sentiment; each of them has its proper place, and each of them is indispensable to the complete development of the human mind. To neglect training on either the one side or the other must produce an imperfect, a lopsided result; but there is no reason why either should be neglected. Let the programme of elementary education only be developed in the direction so long advocated by Sir John Lubbock and those who think with him, and let the whole of the education of the country up to our colleges and universities be carried out on the same lines, and every side of the human constitution and every aspect of human learning will have fair play. Prof. Huxley did well to defend science as a method of mental discipline certainly equal to the old and merely literary methods which so long prevailed at our universities, and which have been so abused; but his address will be strangely misread if any idea of suppressing the old learning is attributed to him. It is interesting to notice that Sir Stafford Northcote, in his short address at Tiverton, followed the plan of that of Prof. Huxley, beginning by strenuously advocating the spread of scientific education in the country as the only means by which we can be able to cope with our neighbours, and concluding by maintaining that it would be a serious mistake to suppress literary training entirely. This is what we have all along maintained in these pages, and we are sure that Prof. Huxley is on our side. Science has had a hard fight to obtain a place in the education of the country, and she has not yet obtained the place she is entitled to; she will only have done so when in all our educational institutions she holds a position of perfect equality alongside of the subjects which until recently monopolised our

schools and colleges, and we trust that when another decade's work of the London or any other School Board has to be summarised, the so-called extra subjects will have become an integral part of the elementary education of the country. Such institutions as that opened at Birmingham will greatly help on the cause of scientific education. The standard of teaching we are glad to see is high, the best science schools of the Continent being taken as models; and we trust the Mason College will never degenerate into a mere technical training-school. Under the liberal principles for its conduct laid down by the founder, it is capable of the widest development in every direction; whether it may form the nucleus of a Birmingham University remains to be seen. Its working will be watched with the greatest interest by all who have at heart the raising of the standard of education in the country.

### CHEMISTRY OF THE CARBON COMPOUNDS

*Elements of Chemistry.* By William Allen Miller, M.D., Sc. Revised and in great part re-written by Henry E. Armstrong, Ph.D., F.R.S., and Charles E. Groves, F.C.S. Part III.—Chemistry of Carbon Compounds, or Organic Chemistry. Section I.—Hydrocarbons, Alcohols, Ethers, Aldehydes, and Paraffinoid Acids. Fifth edition. (London: Longmans, Green and Co., 1880.)

THE study of the laws governing the combinations of molecules containing carbon is of the very first importance to chemical science, inasmuch as this study so well illustrates and extends the general laws of molecular combinations, that is to say, the general laws of the science of chemistry.

An almost innumerable array of facts concerning carbon compounds is to be found in the ordinary text-books; papers in the chemical journals sometimes contain generalisations drawn from certain classes of those facts; the later supplements to Watts's "Dictionary" contain the more important of the comparatively recent generalisations; but there has undoubtedly existed for some time among students of chemistry a wish for a text-book in which the leading facts concerning the compounds of carbon should be clearly stated, the general properties of, and general relation between groups of these bodies should be indicated, and summaries of the evidence in favour of or against the generally adopted structural formulæ of the more important compounds should be presented to the student, in order that he might thus have in one text-book such a fair compendium of the present state of this branch of the science as should furnish him with suggestions for work, by showing him what is clearly known, where exact knowledge ceases, and where even analogy lends but little help.

The first part of such a text-book English chemistry now possesses; let us hope that the second part of this admirable book will soon follow, and be worthy of that now published.

In their preface the editors—had we not better say at once the authors?—write: "Notwithstanding the extraordinary increase in the number of the carbon compounds, their study is gradually becoming simplified as the possibility is extended of arranging them in series and of

giving a general description of their chief properties applicable to all the members of the group."

There can be no hesitation in saying that the authors' work—more than any other text-book in the English language—will aid the advance of this, the only true method, of studying Organic Chemistry.

There are text-books of Organic Chemistry which tell the student that the structure of this or that compound "is represented by the following formula"; this book follows another and a better plan: the authors give a succinct and clear sketch of the evidence for and against all important structural formulæ, thus indicating the true value of these formulæ as condensed statements of chemical facts, and at the same time setting before the student examples of the application of the chemical method of inquiry.

The general principles underlying the formation of so-called structural formulæ are adverted to in more than one place by the authors.

These formulæ are based on the laws of "atom-linking," which again are deductions from the theory of quantivalence or valency, itself an outcome of the application of chemical methods of inquiry to the molecular theory of matter.

Although the volume before us is Part III. of a large work, the first part of which deals with chemical physics, it would nevertheless, we think, have been advisable to have given a brief sketch of the molecular theory of matter, and to have shortly stated—but more fully than is done on p. 42—the evidence on which is based the (chemically) all-essential difference between atom and molecule.

A little space might have been spared for an exposition of the laws of atom-linking, such as, but very much more condensed than, that in Lothar Meyer's "Modernen Theorieen."

In speaking of quantivalence, on p. 42, the authors do not explicitly state that it is the *atoms* of the elements which "are equivalent in combining or replacing power to one, two, three, four, five, or six monad atoms of hydrogen." Of course this is implied throughout the discussion which follows, but students sometimes fail clearly to grasp the difference between the old chemistry, which attempted, but failed, to determine equivalent weights of elements, and the new, which is so largely based on the equivalency of groups of atoms of the elements.

Frankland's "bond" explanation of valency is sketched, but so long as we have no definite physical conception of what a "bond" is, this explanation really explains nothing; such an expression as "two of the bonds neutralise each other" has no meaning, further than that the valency varies from a given number to two less than this number.

The authors give some examples of compounds, which seem to show that the valency of certain elementary atoms may vary from an odd to an even number; but they do not give examples which prove such a variation, e.g.,  $\text{MoCl}_6$  and  $\text{MoCl}_4$ ;  $\text{WCl}_6$  and  $\text{WCl}_4$ ;  $\text{NO}$ ,  $\text{NO}_2$  and  $\text{NH}_3$ .

The authors, probably wisely, do not very definitely express their opinion as to the exact meaning of a structural formula; they sometimes appear to regard these formulæ as real representations of the relative

mode of arrangement of atoms in a molecule, sometimes only as condensed statements of facts of formation and decomposition. If the former view be adopted it becomes a question whether the "structure" represented by the formula is that of the molecule when unacted upon by the molecules of foreign bodies, or only when a certain disposition of its parts has been induced by the action of the molecules of another substance.

Facts are certainly known which are best explained by supposing that a change of some kind precedes that process of complete molecular decomposition usually called a chemical reaction; indeed almost the only feasible hypothesis of chemical action supposes that chemical change—that is, change among the parts of the molecule—may be proceeding without a permanent molecular decomposition taking place. In the section on "Aldehydrols" the authors apparently admit some such hypothesis as this; they do not regard the non-isolation of a compound as proof of the non-existence of that compound; they explain processes of chemical change by supposing the existence of unstable molecular configurations intermediate between more stable and isolable configurations.

Recent work in chemical physics appears to lend some countenance to the idea that structural formulae may roughly represent the configuration of molecules just previous to their passage into phases of "absolute instability" rather than their configuration when in phases which are themselves "absolutely stable."

Quite recently a distinct advance has been made in molecular theories by the recognition of what might be called *atomic induction*, that is, the influence exerted by one part of a molecule in modifying the chemical function of another part, or other parts, of the same molecule. Illustrations of this "orientation" are to be found in the production of the substituted derivatives of benzene and of the phenols; the generalisations made in these cases are clearly stated by the authors.

A very valuable section on the Van't Hof Le-Bel hypothesis of isomerism is to be found from pp. 983 to 993. (There is evidently an omission of part of a sentence at the top of p. 993.) The authors suggest a slightly modified form of this hypothesis. The fundamental assumption is made in these hypotheses that chemical energy is entirely potential, and that it is wholly due to the arrangement of the parts of the molecules. It seems possible however that chemical energy may be partly potential and partly kinetic, and that if any means could be found for measuring the change of entropy as well as the change of total intrinsic energy of chemical systems in their passage from one standard state to another, some light might be thrown on the question of isomerism.

In their general classification of carbon compounds the authors have adopted a scheme founded on the chemical function of these compounds; they group together hydrocarbons, alcohols, aldehydes, &c. They do not fail to indicate how function is associated with "structure." But in each of these great groups of compounds a classification founded more upon genetic relations is adopted; they consider a group of hydrocarbons, then the haloid derivatives of these hydrocarbons, and so on.

Most admirable tables are appended to all the more important groups; the usefulness of these tables may be

illustrated by reference to that on pp. 458-459, wherein the ethylic alcohols are arranged in *really* homologous series.

The acids are classified into various sub-groups, and the dependence of the function of the "acid hydrogen" on the "structure" of the other part of the molecule is indicated.

In speaking of the higher aromatic or "benzenoid" hydrocarbons, the happy expression is used of a closed chain containing "*loops*," and it is pointed out that "the formation of each new loop in the chain of carbon atoms tends to reduce the combining power by two units."

The proof (p. 399) that the carbon atoms in the olefines are not arranged in a closed chain is noteworthy, and may be taken as typical of the authors' method of dealing with such questions; basing a generalisation on carefully collected facts, and then applying their generalisation boldly, but without dogmatism.

The nomenclature of the work before us is much more self-consistent than that adopted in any other treatise on organic chemistry. Certain new names are introduced: thus, the bodies supposed to exist in aqueous solutions of many aldehydes—substances characterised by the groups  $\text{CH}(\text{OH})_2$ —are called *aldehydrols*. A systematic nomenclature for the carbohydrates is proposed: those of the composition  $\text{C}_6\text{H}_{12}\text{O}_6$  have names ending in *ose*, glucose being the best known example of this class; those of the composition  $\text{C}_{12}\text{H}_{22}\text{O}_{11}$ , which like cane-sugar produce two molecules of glucose on inversion, have names ending in *on*, e.g., saccharon; and those which on hydration give rise to the formation of a saccharon have names ending in *yn*, e.g., amylin. As another instance of the authors' attempt to systematise nomenclature may be noted their rules for the use of the Greek letters  $\alpha$ ,  $\beta$ , &c., in distinguishing isomeric derivatives (pp. 861-2, *note*).

Finally, I would draw attention to the authors' manner of dealing with physical methods of solving chemical problems: the physical method is so described that one cannot forget that it is to be used by a chemist—there is not first a little physics, and then a little chemistry; the problem is clearly chemical, the method only is physical.

A suggestion made in the preface seems most admirable, it is that "Each chemical school" would do well to "make the preparation by its students of certain substances in a state of purity a part of the ordinary course of study, and to give notice that these particular compounds are at the disposal of experts for the determination of physical constants."

Is there any probability of a treatise being written on Inorganic Chemistry conceived in the same spirit and carried out, as far as possible, on general lines similar to those of this most excellent work by Armstrong and Groves?

M. M. PATTISON MUIR

#### OUR BOOK SHELF

*An Elementary Treatise on Solid Geometry.* By W. Steadman Aldis, M.A. (Cambridge: Deighton, Bell, and Co., 1880.)

THE term "elementary" diagnoses this handy book to solid geometry from the more thorough works on the same subject by Messrs. Salmon and Frost. It is, to our mind, exceedingly well adapted to the requirements of that large class of students who, whilst requiring an acquaintance with this branch of study, are unable, either

through want of time or the requisite ability, to extend their reading into the more recondite parts discussed by the above-named writers. As a proof that Mr. Aldis's labours have been appreciated, we need only say that this edition, improved by the addition of hints for the solution of some of the examples, is the third.

*Familiar Wild Flowers*: Figured and described by F. Edward Hulme. 2nd Series. With Coloured Plates. (London: Cassell, Petter, Galpin, and Co.)

WE have already called attention to the appearance of the first volume of this series, and of the second we can speak in equally favourable terms. In selecting for illustration a hundred of our familiar wild flowers, all chosen in some way for their beauty, a certain amount of arbitrariness must be allowed; but in the present instance very little complaint will be made on this head by the majority of readers. The coloured lithographs are somewhat unequal in excellence, but, as a rule, are extremely good. The book is one well adapted to awaken or to foster in young people a love of the floral beauties of our fields and hedges, woods and ditches.

*A New and Easy Method of Studying British Wild Flowers by Natural Analysis*. By Frederick A. Messer. (London: D. Bogue, 1880.)

THIS work indicates a very large amount of labour on the part of the author; whether the labour has been altogether well applied is another question. For the field botanist whose sole object is to determine the name of a wild flower it will no doubt be useful in assisting him to make out at least the order and genus, for beyond this it does not pretend to go. No botanist will be disposed to depreciate the value of field botany and of the study of critical species, which often leads to further study of some of the great questions connected with the life of plants. There is no doubt that species-botany had been exalted a quarter of a century ago to a far too prominent place by English workers, and had been much too exclusively followed, to the disregard of morphological and especially of physiological work. The inevitable reaction has set in, and is now perhaps at its height, when the number of botanists who have an accurate acquaintance with our British flora is extremely small. As an introductory work for those who are desirous of increasing this number, Mr. Messer's book may be recommended, always provided that the student does not imagine that it will materially help him in his study of the structural and genetic affinities of the different families of plants. The graphic illustrations are novel in design, and will no doubt help to impress the meaning of the technical terms on the beginner. Some few errors should not have been allowed to pass in a work bearing the date of the present year. Among these is the reference of *Selaginella selaginoides* to the genus *Lycopodium*, and the complete suppression of Selaginellaceæ as a British order of vascular cryptogams.

*Manual of the Indigenous Grasses of New Zealand*. By John Buchanan, F.L.S. (Wellington: James Hughes, 1880.)

THIS is one of those excellent manuals emanating from the Colonial Museum and Geological Survey Department of New Zealand under the admirable direction of Dr. Hector. The work is a reproduction in a handy form of the folio work ordered by the New Zealand Government in 1876, to be prepared "with nature-printed plates and descriptions of each species, and to be accompanied by an essay on the grasses and forage plants likely to prove useful in New Zealand." This explanation is extracted from the preface of the book before us, which preface has been written by Dr. Hector himself. We also learn from the same source that "the whole of the illustrations of the large edition were drawn from nature by Mr. John Buchanan. . . . The condition imposed—that the plates should be nature printed—rendered it necessary in the

first instance to publish the work in folio, but, as this large size is both inconvenient and costly, only a small edition has been issued, and the present handy volume has been printed for more general distribution. The plates now given—sixty-four in number, and including eighty-seven different species and varieties of grasses—are reductions by the process of photo-lithography from the original folio plates, and depict the grasses as of one half the natural size of the original specimens."

There can be no doubt but that the book will be very valuable, not only to the botanist, but also to those who wish to know all about New Zealand grasses for their utility for fodder or for other purposes. The plan adopted in the book is to give under each genus a brief generic description and general distribution over the world, the names of the countries being given in capitals, so that they catch the eye at once; this is followed by the etymology of the generic name. The species are then separately enumerated, the generic and specific names standing first, followed by the common name, reference to the plate, synonyms, habit of the plant, time of flowering, specific description and distribution of the particular species, after which is a good account of the properties and uses of the grass, and a detailed reference to the figures. The book is extremely well printed, the plates are well done, and there are two capital indices, the first to genera and species, and the second to popular names.

JOHN R. JACKSON

#### LETTERS TO THE EDITOR

[The Editor does not hold himself responsible for opinions expressed by his correspondents. Neither can he undertake to return, or to correspond with the writers of, rejected manuscripts. No notice is taken of anonymous communications.]

[The Editor urgently requests correspondents to keep their letters as short as possible. The pressure on his space is so great that it is impossible otherwise to ensure the appearance even of communications containing interesting and novel facts.]

#### Geological Climates

IN NATURE, vol. xxii. p. 200 *et seq.*, there occurs an important statement by Mr. J. Starkie Gardner, to the effect that fossil remains not distinguishable from *Araucaria Cunninghami* had been found among the Eocene plant beds of Bournemouth, in the south of England.

After reading Mr. Gardner's paper, I availed myself of an opportunity of studying the leaflets of the living and dead specimens of this species of *Araucaria* in the Kew Gardens, including the original specimens in the Herbarium named by Mr. Cunningham, and agree with Mr. Gardner as to the difficulty of separating the *A. Cunninghami* from the Sequoias by leaflets alone when in the fossil condition.

Assuming Mr. Gardner's conclusion to be true, viz., that the Eocene Bournemouth tree was identical, or nearly so, with the living *A. Cunninghami*, a question arises as to climate which will prove insoluble to geologists of the school of Lyell and his followers, who assume that all physical causes during geological time have been pretty much the same as at the present time and times immediately preceding the present.

The Moreton Bay Pine (*A. Cunninghami*) is found, as the name imports, on the shores of Moreton Bay, on the east coast of Australia, and has a range of 900 miles, from 14° S. lat. to 29° 30' S. lat. along that coast. It does not extend more than eighty miles inland, where, instead of being 130 feet in height, which it is on the coast, it becomes a dwarf tree, and farther inland it entirely disappears.

This tree therefore becomes a most delicate self-registering thermometer, indicating to us precisely (after the well-known manner of plants) the exact conditions of the Eocene climate that existed in Bournemouth during the earlier Tertiary period. I propose to examine the evidence given by this thermometer, and to invite my uniformitarian friends to explain how this evidence can exist in conformity with their views.

The climate of the northern limit of the Moreton Bay Pine is as follows (as regards heat):—

Mean (January).	Mean (July).	Mean (Annual).
82°° F.	71°° F.	76°·5 F.



The climate of the southern limit is—

Mean (January).	Mean (July).	Mean (Annual).
72°·5 F.	57°·5 F.	65°·0 F.

The mean of both being—

Mean (January).	Mean (July).	Mean (Annual).
77°·25 F.	64°·5 F.	70°·75 F.

The present mean annual temperature of Bournemouth is only 50°·4 F., which is 20°·35 F. below its mean annual temperature in the Eocene period.

I want to know how Lyell and his followers propose to give to Bournemouth, from present existing forces and causes, this additional 20° F. of heat. If geologists really wish to earn the respect of their fellow-workers in more exact branches of knowledge, they must condescend to consider *quantitative* as well as *qualitative* questions, and enter into numerical details. To enable them to do so I lay down the two following statements:—

1. Of all places now existing on the same parallel of latitude as Bournemouth the highest mean temperature is in 20° W. long. (in the Atlantic), where the temperature is 53°·1 F., or only 2°·7 F. above that of Bournemouth.

Of all places on the same parallel the lowest mean temperature is found at 80° W. long. (on the borders of Labrador and Canada), where it is 29°·3 F., which is 21°·1 F. below that of Bournemouth, and 2°·7 F. below the freezing point of water.

Existing forces and circumstances might therefore benefit Bournemouth to the extent of 2°·7 F. degrees, or might injure it to the extent of 21°·1 F.; but how is Bournemouth to gain the 20° of heat necessary for the flourishing of the *Araucaria Cunninghamii* on its Eocene sea-shore swamps, if existing causes only were at work?

2. The place in the northern hemisphere which is now most closely allied in climate to Moreton Bay, or to Bournemouth in Eocene times, is the central part of the Gulf of California, in Western Sub-tropical America.

Again, I ask geologists of the *uniformitarian* school to show me how they propose to convert the climate of Bournemouth into the present climate of the Gulf of California or that of Moreton Bay by mere transposition of land and water, without shifting the position of the earth's axis, which is an inadmissible hypothesis?

Trinity College, Dublin,

SAML. HAUGHTON

September 25, 1880.

### The Naini Tal Landslip

FOR the purpose of making a thorough inquiry into the details of the causes that led to the above lamentable disaster an able geologist would undoubtedly be required, as was suggested in your leader last week. I think, however, that to any one who, like myself, has resided even but temporarily at Naini Tal, the main cause of the recent slip must be sufficiently obvious without the aid of the geologist.

From the account of the particular buildings overwhelmed it is plain that the slip took place close to where an almost equally bad one occurred some years ago (in the winter of 1865, I believe), viz., just above the Victoria Hotel, on the shoulder uniting the two peaks of Cheena and Lyria Kanta.

The foot of this shoulder forms the northern border of the Tal, or lake, for which the station is justly famed; the strata composing it, as far as I can remember, dip *with* the slope of the hill southwards towards the lake. Moreover, it faces the direction from which the rain mostly comes. The conditions for the production of a landslip in the direction of the lake are thus amply fulfilled.

Though landslips are not at all infrequent from this hill (one occurred near Cheena when I was there, killing two natives), it is from its sunny aspect and *comparatively* gentle slope decidedly the favourite, the station being mainly built on its slopes or at its foot.

On the hill which forms the southern border of the lake the dip of the strata is in the opposite direction to the slope of the hill. It is consequently much freer from landslips, and much safer than the former, as only a few chips at most could be detached from it on the side facing the lake, by the action of rain. The nearly constant gloom however in which, from its northern aspect and its steepness combined, it is necessarily shrouded, as well as the lack of building area, naturally tends to limit its population. This hill again on its *southern* side, which faces the plains, repeats the same phenomena as the shoulder

before mentioned; an enormous portion of it having become detached towards the plains, and called pre-eminently "The Landslip."

When staying in the Victoria Hotel in May and June, 1877, I always felt it would take very little to bring the whole hill, and especially Government House, which appeared almost vertically above us, down on top of us. The old landslip which I mentioned as being close to the present hotel buried its predecessor, and might be thought to have furnished ample warning against choosing such a dangerous spot upon to which to rear a fresh one.

To guard against such disasters in future I would suggest that all houses in the hill-stations should, if possible, be built mainly where the strata dip in the opposite direction to the slope of the hill, and that where the strata dip in the same direction as the slope of the hill all proximity to steep slopes should be avoided, and only the gentler slopes utilised for building on.

I may add that the rainfall on the present occasion seems to have been phenomenal, if, as the *Times* says, it was thirty-three inches in seventy-two hours. Still, extraordinary and sudden downpours of this kind must be expected, where the summer rainfall has varied from forty inches in 1877 to 117 inches in 1862.

Tunbridge Wells, October 2

E. DOUGLAS ARCHIBALD

### Branch-cutting Beetles

IT is rather curious that the story which Mr. Ober was told in the Carrilbees (*NATURE*, vol. xxii. p. 216) should be generally believed in Southern Brazil also, viz., that a large beetle "seizes a small branch of a tree between its enormously long nippers, and buzzes round and round the branch till this is cut off." Only in the Antilles this cutting of branches is attributed to a huge Lamellicorn, the *Dynastes hercules*, and in Santa Catharina to a large Longicorn, the *Macrodontia cervicornis*.

Everybody here will tell you this story, but nobody, as far as I know, has ever seen the beetle at work. Branches are often cut off by some animal. On a camphor-tree in my garden six branches, from 9·5 to 13·5 centim. in circumference, have been cut off; and on a *Pithecolobium* for some time almost every morning a fresh branch had fallen down, some being even much thicker than those of the camphor-tree. The cutting is always in a plane perpendicular to the axis of the branch, as it would be were it made by a rotating beetle; but in this case an annular incision of equal depth all round the branch would be produced, and this I have never seen. On the contrary, the incision, which causes the branch to break off, consists of two parts, occupying the lower and the upper face of the branch, meeting on one or on either side of it, and being separated by a wedge-shaped interval, which is broken by the weight of the branch, and is narrower or broader according to its toughness.

Once—many years ago—I came to the *Pithecolobium* tree early in the morning, when a branch was just falling down, and with it came down the animal by which it had been amputated. It was a Longicorn beetle, the well-named *Oncideres amputator*, Fabr. I have since seen specimens of some other species of the same genus, which had been caught by others in the act of cutting branches. It is almost unnecessary to add that they do so by gnawing, and not by whirling round the branches.

Blumenau, Santa Catharina, Brazil,

FRITZ MÜLLER

August 13

### The Tay Bridge Storm

IN *NATURE*, vol. xxi. p. 468, Mr. Ley asks, relative to my letter on the Tay Bridge storm, which appeared in *NATURE*, vol. xxi. p. 443, on what evidence I state "that when the velocity of the cyclone centre is very great, the strength of the wind for any gradients is increased, or at all events becomes more squally and gusty."

I much regret the circumstances which have prevented my replying to him sooner, but may now state shortly the three principal pieces of evidence which led me to that conclusion:—

1. My own observation in a large number of cyclones where the velocity of translation was very great, there has been a quality of gustiness or squalliness and intensity generally greater than is usual for the observed gradients.

2. Ever since the barometer was invented it has been known that a rapid fall of the mercury indicates worse weather than a slow one. Now we know that the rate at which this fall takes place at any station depends:—(1) On the steepness of the

gradients. (2) On the nearness of the observer to the path of the cyclone centre. (3) On the velocity of translation of that centre.

In a great many cases I have observed, especially in the west of Ireland, that when a rapid fall of the barometer is reported, the wind is much stronger than existing gradients would seem to justify.

From this it would seem that the rate at which the change of pressures is taking place has some influence on the strength of the wind.

3. Prof. Loomis has shown in his examination of the U.S. Weather Charts that in American cyclones the area of rain-cloud extends further in front when these storms are going fast than when they are going slow.

From this it would appear that another element of intensity be-ides wind, viz., precipitation, is increased when a cyclone centre moves with great rapidity.

It was mainly on these grounds that I based the statement in my former letter.

RALPH ABERCROMBY  
21, Chapel Street, Belgrave Square, October 5

#### Deltocyathus Italicus, Ed. and H.

I FIND that Prof. Ralph Tate, F.G.S., President of the Adelaide Philosophical Society, has lately written as follows in an anniversary address. "On the other hand the Geelong coral, *Deltocyathus italicus*, Ed. and H., better known from the Italian Miocene, is considered by Count Pourtales and Sir Wyville Thomson to be specifically distinct from its living analogue inhabiting the deep waters of Florida—an opposite opinion to that held by Prof. Duncan." During the last conversation I had with the late M. de Pourtales he informed me that after having seen and studied the Italian types, he was satisfied that I was correct in the statement I had made regarding the specific identity of the Tertiary and recent forms.

F. MARTIN DUNCAN

4, St. George's Terrace, Regent's Park, N.W.

#### Temperature of the Breath

My attention has been directed to a communication under the above heading by R. F. Dudgeon, in *NATURE*, vol. xxii. p. 241. The speculations therein raised regarding the temperature of the breath are scarcely compatible with a-certain physiological truth. Mr. Dudgeon's friend's explanation, against which he argues, is undoubtedly correct. The great value of woollen clothing in preventing chill after exercise may be explained on the same principles. The hygroscopic state of the atmosphere (and material) is the condition which causes variation in different experiments. Different materials have effects corresponding to their hygroscopic properties. The following results of a few experiments which I recently made speak for themselves:—

No. 1.—Temp. of air,	87° F.—Air moderately dry (dew point not ascertained).
"	breath, 96° in mouth cavity.
"	" 102° 9.—Thermometer enveloped in four folds wool.
"	" 102° 2.—Thermometer enveloped in four folds silk.
"	" 100° 8.—Thermometer enveloped in four folds linen.
No. 2.—Temp. of air,	79° F.—Air very damp, raining heavily.
"	breath, 97° in mouth cavity.
"	" 99° " through four folds of silk.

Time occupied in each observation, three minutes.

Madra, September 9 C. J. McNALLY

#### Swiss Châlets

I DO not know whether the idea has previously occurred to any one that the modern Swiss châlet is a descendant of the old lake dwelling, but I was strongly impressed with that conviction this autumn. Not only do they actually build the smaller châlets, used as storehouses, entirely on short piles, but very many of the dwelling-houses are still one half on piles, the steps leading up to the gallery passing through a hole in the middle, so that the modern exterior gallery would represent the original platform. In the lake dwelling the probability is (I would suggest) that there was a trap-door in the centre of the platform, inside the inhabited part, with a movable ladder, so that the latter could

be drawn up and the trap-door closed if required. At the present day the ladder is represented by fixed wooden or stone steps leading up into the gallery. The house being now on land, the lower part is half or entirely closed in, and so forms an extra chamber, though the family still dwell above the platform (i.e. the gallery) as in days of yore.

GEORGE HENSLOW

#### Fascination

FASCINATION originally meant a supposed power in man and snakes of controlling or arresting the movements of various animals by a glance. Your correspondent M. Chatel's personal anecdote, with his comment thereon, suggests that the snake in some way mesmerises his victim, not by its glance but by its movements. His supposition that "the rapid gyratory motion of a shining object" leads on to the debilitating nervous attack, is open to debate. In displays of fireworks such motion occurs before crowds without making any one sick or frightened or inclined to rush into the middle of a cathartic-wheel. However then the motions of the snake, whether swift or slow, may avail in attracting and fixing attention, the final catastrophe is probably due to pure fright, according to the old saying, *Multis ipsum metuisse nocet*. We may safely infer that your correspondent himself would have felt no squeezing round his temples had he known at first that the snake was for him a harmless one, and not a viper nearly five feet long!

In the opening letter on this subject the basilisk and the bombshell seemed to be endowed alike with a semi-miraculous power of enchaining the victims that looked upon them. Now, that small birds should be paralysed with terror at the sight of a gesticulating snake is possible or probable enough; but that English officers should be rooted to the ground by mere alarm at the flight of shot or shell is an uncongenial explanation of facts which appear to me capable of interpretation on a different hypothesis.

In moral, as distinct from physical, perils, there is good reason to suppose that too close a concentration of thought upon a danger has a tendency to overpower the will and bend it to the commission of the very acts which the intellect has pronounced unchoiceworthy. But the acts so committed carry with them present gratification. To use the common simile, men fly to them as moths to a candle, not because they are panic-stricken, but because the sense of the danger is lost in the pleasure that attends it.

I am inclined, in the present state of the controversy, to group the effects of so-called fascination under three heads: (1) there is the effect of paralysing terror; (2) there is the effect of indecision; (3) there is the effect of qualities attractive and repulsive accidentally combined in the same object. The first and second effects are perhaps at times combined together in various degrees, and mixed with that absorbing curiosity of which Mr. Hodgson speaks (*NATURE*, vol. xxii. p. 383), but which by itself seems rather to deserve the name of abstraction than of fascination.

As to fascination in the original sense of the word, its nature may await discussion till observation proves that such a power in reality exists.

THOMAS R. R. STEBBING

Tunbridge Wells, September 27

#### Air-Bladder of Herring

IN *NATURE*, vol. xxii. p. 520, there was an abstract of Mr. F. W. Bennett's paper on the "Visceral Anatomy of the Herring" (*Journ. Anat. and Phys.*, July 1880). It has escaped the notice of Mr. Bennett that Dr. E. H. Weber described and figured (*Tab. vii. 63*) the posterior opening of the air-bladder of *C. harengus* into the urogenital sinus in his "De Aure et Auditu Hominis et Animalium," pars I. 1820.

Zoological Museum, Cambridge

ALFRED C. HADDON

#### The "Waiting Carriage"

M. HANREZ' proposed "waiting carriage" (*NATURE*, xxii. 519) has doubtless been schemed by many readers before now. A simpler form had long ago occurred to me, having the drum of cable in the train engine, the cable passing under the carriages and catching the waiting carriage at the tail. The running out of rope could be as well managed at one end of the train as at the other, and only an ordinary carriage without any special engine would be required, which would be dropped just before

picking up another at the next station, each carriage thus slowly shifting round the line.

But any such plan would entail a fresh build of carriages; and for discontinuous carriages a plan nearly as good would be to run a railway omnibus on the rails, with a small 6 or 8 h.p. engine all in one. This would be stopped anywhere between stations, at crossings, farmhouses, and hamlets along the line, and would serve the peasantry for going shopping, beside taking up baskets of garden produce. Passengers going a long journey would change at a main station and join the ordinary train, which would only stop about every hour at the ends of forty or fifty miles' stages. Country lines only running a train every two hours or so would be easily worked thus, the 'bus being shunted by telegraph if necessary, and the line signalled clear as usual. With double lines the 'bus would run on the goods line.

Bromley, Kent

W. M. F. PETRIE

### A NEW KIND OF ELECTRIC REPULSION<sup>1</sup>

DR. GOLDSTEIN has devoted a good part of the last ten years to an investigation of the discharge of electricity through gases, and amongst the many phenomena which he has brought to light, the one described in a memoir published in a separate form is not the least interesting and important. The facts may be stated in a few words: *A negative electrode exerts a strong repulsion on the rays of the glow proceeding from itself or from another negative electrode.* Before describing the experiments proving this statement, and the laws by which this phenomenon is regulated, we shall follow Dr. Goldstein in reminding the reader of a few facts connected with a discharge of electricity through gases which he will have to bear in mind.

It is well known that the negative electrode in a gas, for which Faraday's name of cathode may be conveniently used, is surrounded with a glow which expands as the pressure of the gas is reduced. We are able to distinguish four layers in this gas, though three of them only are easily recognised. As a first approximation we may assume the outline of these layers to be parallel to the outline of the electrode, though, as we shall have to mention, Dr. Goldstein has shown that this is not strictly correct.

The layer of the negative glow adjacent to the cathode is luminous, and shines in air with a yellowish-red tint. This first layer is surrounded by a second layer, which is very little luminous. This is the dark space mentioned by Mr. Crookes; but, as Dr. Goldstein shows, it is not entirely dark, but has in air a bluish tint. We next come to the third and fourth layers, which may very well be taken as one, and which are more generally designated by means of the term, negative glow. They form the outer boundary of the luminosity surrounding the cathode. If the pressure of the gas is sufficiently reduced to enable the glow to touch the glass, it becomes phosphorescent, and only the layer of the gas immediately touching the glass causes the phosphorescence. The phosphorescence gets stronger as exhaustion proceeds; at the same time the luminosity of the glow gets weaker. The appearance and extension of the glow does not depend on the position of the anode, while the luminous positive discharge varies very much with the relative position of the electrodes, and can be made to disappear altogether by bringing the electrodes sufficiently near.

Already Plücker, and especially Hittorf, have come to the conclusion that the negative glow is propagated in rectilinear rays from the cathode, and it can further be shown that the direction of propagation is generally in a direction nearly normal to the surface of the cathode. Dr. Goldstein draws a distinction between such elements of the cathode which lie near the edge, if the surface of the cathode has edges, and elements which are removed from the edge. While those elements not near an edge only send out rays within a cone of narrow aperture in a

normal direction, the edges send out rays in all directions. This difference in the behaviour of different elements of the same surface is, it appears to us, well explained by Dr. Goldstein's discovery of a repulsion between the electrode and a ray proceeding from the cathode. A little consideration will show that this repulsion will, whenever cylindrical or plane electrodes are used, be in a nearly normal direction for any part of the surface which is sufficiently removed from the edge, while near the edge the resultant repulsion will be away from the surface and from the greater angle with the normal the nearer the ray is to the edge. This would prove of course that the repulsion is not an electrostatic one, for in that case it would always be at right angles to the surface. If the exhaustion is such that the glass becomes phosphorescent, the phosphorescence, being produced by the rays proceeding from the cathode, it is clear, will form a luminous ribbon surrounding the electrode, which is a little larger than the electrode.

If now a solid body is introduced between the cathode and the glass inclosure, a shadow of this body will appear in the phosphorescent light on the glass; the formation of the shadow is a direct consequence of the rectilinear propagation of the rays.

We now proceed to describe Dr. Goldstein's experiment in its simplest form.

In a cylindrical vessel two parallel electrodes of equal length are introduced at one end, while the other end contains a third electrode which shall always form the anode. Let the pressure be such that phosphorescence appears, and let only one of the two parallel electrodes be connected with the negative pole of the coil, while the other is insulated. A shadow of this insulated wire is seen in the phosphorescent light on the glass. Now let the insulated wire be brought into metallic contact with the other electrode, and the whole appearance will change. In the phosphorescent light of the glass we shall see two dark surfaces of equal size and shape, and with distinctly marked edges. The two dark surfaces are situated in such a way that a plane which passes through the electrodes cuts them into two equal halves. They are partly bounded by straight lines, partly by two semicircular arcs.

The parts formed by straight lines are parallel to the electrodes, and of equal length; these straight lines are joined at the lower end, that is, at the free end of the electrodes, by means of a half circle, which is partially repeated at the upper end; but where the electrodes are sealed into the glass the curve is interrupted. The dark surfaces are bordered by a bright line of light. It will facilitate the understanding of the position and shape of these dark surfaces if we mention already here that they are such as would be produced if the rays emanating from each electrode, and propagated in a normal direction from it, suffer a repulsion and consequent deflection in the neighbourhood of the other electrode, so that the dark space is formed by the absence of the phosphorescent light which would be produced by the rays coming from the farther cathode.

We cannot here give the further description of shape and the measurement of the size of these dark surfaces, but at once describe their properties. In the first place the size and shape are altogether independent of the position, form, and size of the positive electrode. The relative position of the two cathodes, on the other hand, materially affects their behaviour; and Dr. Goldstein gives their shape, for instance, if, instead of being parallel, they are at right angles to each other, either in the same plane or one in front of the other. We have already stated that in the case of parallel electrodes the parts of the outline forming straight lines are of equal length with the electrodes, and hence the length of these dark surfaces increases with the length of the electrodes, but the breadth and half-circle joining the straight lines

<sup>1</sup> "A New Kind of Electric Repulsion," by Dr. E. Goldstein. (Berlin: Julius Springer, 1880.)

does not vary with the length of the electrodes. The further removed the glass walls are from the two electrodes the greater is the width of the surfaces. All these and other properties follow at once if we consider that the luminosity is produced by the intersection of the rays proceeding from the cathodes with the glass walls. If we increase the thickness of one of the electrodes, the size of the dark surface nearest to it is increased. We now turn to the experiments which have been made in order to clear up the cause of the phenomena. By means of very ingenious experiments Dr. Goldstein proves that it is only light produced by the nearer electrode which is seen within the boundary of the dark surface, for although we have called them dark, they are only so by contrast, and they show a faint phosphorescence. Dr. Goldstein had, in a former paper, shown that when the cathode is perfectly smooth, the phosphorescent light produced by the glow shows inequalities. By twisting the aluminium electrodes he could obtain a series of spiral curves in the phosphorescent light more luminous than the rest. If one of the two cathodes is twisted in such a way and connected with the other, the spiral curves are interrupted in the dark space which is removed from the twisted electrode, but they are visible in the dark surface nearest to it.

The dark surface cannot be considered as enlarged shadows only of the electrodes, for their shape is different, but they might as regards shape be considered as shadows of the second and non-luminous layer of the negative glow. This remark we believe to be of importance, but Mr. Goldstein shows that they cannot really be such shadows, for they appear even when by an approach of the two electrodes the two non-luminous layers fuse into one and so lose their individuality.

The following experiment proves the repulsion. A metallic diaphragm is introduced between the two cathodes. A small hole is made in the diaphragm with its centre in a line joining the electrodes. Only some of the rays proceeding from each cathode can now reach the next, and consequently we observe only a small phosphorescent speck at the opposite side of the glass wall if one of the electrodes is insulated, but the dark shadow of the nearest electrode is visible in this phosphorescent speck. If now the two cathodes are joined the phosphorescent speck is seen to divide into two which separate and clearly show that the rays producing the phosphorescent light must have suffered a deflection as soon as the two cathodes were joined. Further experiments show that the deflection takes place at right angles to the surface of the electrode, and that it takes place at sensible distances from the repelling cathode, although it rapidly decreases in strength. Near the edge of a repelling cathode the repulsion does not take place in a normal direction, and Dr. Goldstein draws again a distinction between elements of a surface according as they are removed or near an edge. We believe this distinction to be unnecessary, and that all phenomena are explained by the fact that all parts of the electrode are repelling, and not only the elements nearest to the deflected ray.

Some remarkable secondary phenomena take place in a deflected system of rays. If, for instance, a system of rays forming a cone of narrow aperture passes near a second cathode, it is not only deflected but the aperture of the cone is increased. The phenomena are such as would be produced if a cathode not only repels the rays but also induces a state in the particles forming the ray such that they now repel each other. Also parts of the same cathode repel rays proceeding from other parts, and the repulsion increases the closer the electrodes. All these facts are illustrated and proved by a series of well-arranged experiments. Dr. Goldstein next examines the influence of an anode, but we shall not follow him, as it is found that the effect of an anode is exceedingly small, and most likely always produced by secondary causes.

The deflection is the same in all gases; air, hydrogen, carbonic oxide, and magnesium vapour having been tried.

The deflection is independent of the metal of which the cathode is formed; it is independent of the pressure. It is also independent of the intensity of discharge when the two electrodes are in metallic contact, so that the current is equally divided between the two cathodes. But remarkable changes take place if the current is not so equally divided. This can be done by joining the electrodes not metallically, but with a bad conductor, as for instance a moist thread. It is then found that the dark surface nearest the cathode through which the smaller discharge passes is much reduced in size, while the other dark surface is increased. It follows from experiments such as this that the repulsion does depend on the intensity of discharge, but that while a cathode through which more electricity passes more strongly repels, a ray which proceeds from such a cathode is less strongly deflected. If therefore we have seen that the dark surfaces do not vary in size, whatever the intensity of discharge, if the two poles are connected with a piece of metal; this is due to the fact that each cathode repels more strongly, but that the rays of the other electrode (owing perhaps to the greater velocity of the molecules proceeding from it) are less easily deflected, and that the two effects counterbalance each other. Dr. Goldstein considers, rightly no doubt, that the shadows seen when one apparently insulated metallic body is introduced between the cathode and the glass are due to a similar repulsion, because we may consider that a small part of the discharge always passes through such a body, the glass into which the body is necessarily scaled not being an absolute non-conductor. The shape of the shadow confirms this supposition.

Dr. Goldstein has also obtained the repulsion from electrodes consisting of glass and mica, so that the metallic or non-metallic nature of the electrode does not influence the phenomena. He has also proved that the source of electricity is immaterial, as might have been expected.

Dr. Goldstein has also endeavoured to prove that the deflecting power of a cathode does not act through a solid screen, but he has chosen metallic screens for his experiment.

If the repulsion is of the nature of electric repulsion a metallic body might act as a screen, while a non-metallic body would allow two bodies on opposite sides of it to repel each other. As it is impossible to form any idea on the cause of these phenomena unless we know whether the deflecting power is cut off by any solid body, it is much to be wished that Dr. Goldstein will repeat his experiments with non-metallic screens.

In the last part of his book Dr. Goldstein discusses various theories which might be proposed and have been proposed for the explanation of the phenomena taking place in the neighbourhood of the negative electrode. The result is that none of them are satisfactory. While this no doubt is true, Dr. Goldstein is too severe, we believe, in his criticisms of some of the suggestions which have been made, and which may, in our opinion, after all contain the germ of the true explanation, though in their present shape they may not be quite satisfactory. Some of the facts which to Dr. Goldstein are sufficient to reject a theory may, we believe, be explained without putting too great a strain on our present ideas, and sometimes we believe Dr. Goldstein to be in error, as when, for instance, he says that a body must necessarily move in a line of force. It would at least be a sad look-out for our earth if this was true, and Dr. Goldstein would in that case have occasion to study before long the electric phenomena on the surface of the sun. We will hope, for the sake of science, that both Dr. Goldstein and his molecules do not always move in lines of force, and that he will often favour us with such interesting and valuable contributions as the one before us.

ARTHUR SCHUSTER

PHYSICS WITHOUT APPARATUS<sup>1</sup>

## VII.

IN the preceding articles on "Physics without Apparatus" it has been shown how a large proportion of the fundamental experiments in most branches of physics can be performed without employing expensive apparatus.

The next of these branches to claim consideration is the

decanter until the position is found in which its rays focus themselves upon the wall giving a clear inverted image of the candle flame upon the wall. The experiment may be varied by setting down the candle on the table and then moving the decanter to and fro until a definite image is obtained. If a large hand reading-glass be available, the image will be much clearer than with the improvised water-lens; and a further improvement in the manner of experimenting may be made by using a screen of white



table. The candle should be placed at the other end of the table, and the reading-lens moved about between them until a point is found at which it throws upon the screen a good clear image of the candle. It will be found that there are two such points, one near the candle, the other near the screen. In each case the image of the candle will be inverted, but in the first case it will be a magnified and in the second a diminished image, the size of the image, as compared with that of the real flame, being proportional to their respective distances from the lens. When the lens has been placed in a position of good focus, the candle may be removed and placed where the screen stood; if now the screen is placed where the candle was, it will be found that the image is again visible on the screen, still inverted, though altered in magnitude. This experiment, in fact, proves the law of conjugate foci.

The young beginner in science who repeats these experiments for himself will begin to understand how it is that in the photographer's camera the image in the instrument is inverted, and how it can also be true that

demonstrable with little or no apparatus of a formal kind.

An ordinary looking-glass, a lighted taper, and a foot-rule or a measuring tape are quite sufficient to demonstrate the simple geometrical laws of reflection; for with their aid it is very easy to show that the image of the candle in the mirror is virtually situated at a distance behind the mirror equal to the actual distance of the candle in front, and that, when a ray falls obliquely on the mirror, the angle of incidence is equal to the angle of reflection. A teacher who wishes to go further into the matter, and to demonstrate the laws of reflection at curved surfaces, usually provides himself with the appropriate silvered mirrors of convex and concave form. Failing these, the exterior and interior surfaces of the bowl of a bright silver spoon will probably be as satisfactory a substitute as any. We have found even a saucer of common glazed earthenware to form a very fair concave mirror, giving upon a small tissue paper screen a beautiful little inverted image of a distant gas flame.

To illustrate the geometrical laws of refraction through lenses, a good reading-glass of large size is a desirable acquisition. Spectacle-lenses, though of smaller size, and therefore admitting less light, are also of service. In the absence of any of these articles, it is generally possible to fall back upon a water-decanter, provided one can be found of a good globular form, and not spoiled for optical purposes by having ornamental work cut upon the sides of the globe. Fig. 22 shows how this decanter, filled with water, is to be employed. It is held a few inches away from a white wall, and a candle is placed at the opposite side, so that its light falls through the decanter on to the wall. The candle is moved towards or away from the



FIG. 23.

ball answers to the white screen on to which the image is

<sup>1</sup> Continued from p. 489.

thrown by the lens in front of it. It is possible indeed to show in actual fact that the image in the eyeball is inverted; the experiment is very simple, but we believe that this is the first time that it has been described in print. Take a candle, and hold it in your right hand as you stand opposite a looking-glass. Turn your head slightly to the left while you look at the image of yourself in the glass. Open your eyes very wide and look carefully at the image of your left eye. Move the candle about gently, up, down, forward, &c., so that the light falls more or less obliquely on to the eyeball. You will presently notice a little patch of light in the extreme outer corner of the eye; it is the image of the candle on the inside of the eyeball, which you see through the semi-transparent horny substance of the eye. If you move the candle up, the little image moves down, and if you succeed well, you will discern that it is an inverted image, the tip of the flame being downwards. You thus prove to your own satisfaction that the image of the candle in your eyeball is really upside down.

Fig. 23 shows a magnifying-glass of very simple con-

struction, which a few years ago found a great sale in the streets of London, at the price of one penny. A bulb blown at the end of a short glass tube is filled with water. When held in front of the eye, this forms a capital lens for examining objects of microscopic dimensions, which may be secured in place by a bit of wire twisted round the stem.

The principle by which the intensity of two lights is compared in the photometer is very easily shown. The arrangement depicted in Fig. 24 shows how to measure the relative brightness of an Argand oil-lamp and of an ordinary candle. Both these lights are set upon the table, and are so arranged that each casts on to a screen of white paper a shadow of a tall narrow object. The most handy object for this purpose is another candle unlighted. The Argand lamp, being the brighter light, will cast the deeper shadow of the two, unless it is placed further away. The measure of the brightness is obtained by moving the brighter light just so far off that the intensity of the two shadows is equal, for then we know that the relative intensities of the

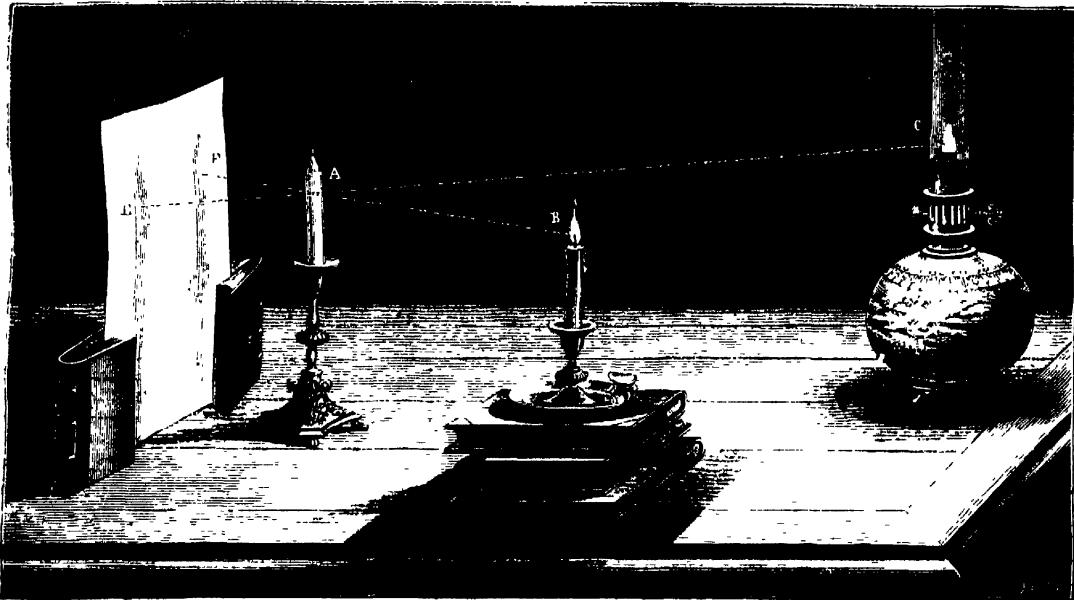

FIG. 24.

two lights are proportional to the squares of their distances from the photometer. All that remains, therefore, is to measure the distances and calculate out the intensities. If, for example, the distance of the lamp is double that of the candle when the two shadows are equally dark, we know that the brightness of the lamp is four times as great as that of the candle.

Many other facts in optics can be shown with no greater trouble than that entailed by such simple experiments as we have described. The pendant lustre of a chandelier will provide an excellent prism of glass for showing the dispersion of light into its component tints. A couple of spectacle glasses appropriately chosen will, when pressed together, afford capital "Newton's rings" at the point where they touch. Diffraction bands of gorgeous hue may be observed by looking at a distant gas-light, or at the point of light reflected by a silvered bead in sunshine, through a piece of fine gauze, or through a sparrow's feather held close in front of the eye. And yet more remarkable effects of diffraction are obtained if the point of light be looked at through substances of still finer structure, such as the preparations

of woody structure, and of the eyes of insects which are sold as microscopic objects. But the explanation of these beautiful phenomena would lead us far beyond our subject.

(To be continued.)

#### THE JAMAICA HURRICANE AND THE BOTANICAL GARDENS

THE following letter from Mr. Morris has been forwarded to us from Kew for publication:—

*Botanical Department, Gordon Town,  
Jamaica, September 7, 1880*

At the Cinchona Plantation, besides damage to our buildings and sheds of about 650l., our nurseries and seed beds have suffered so much as to reduce our stock of available seedlings from something like 500,000 down to 80,000. These were intended for planting out in the latter part of this year and the beginning of the next year. We shall in consequence be unable to distribute seedlings as we intended, and so suffer considerably in expected

revenue. At the plantations vegetation is so literally swept away that only here and there can we see a standing tree. There is not a leaf left on either the indigenous or cinchona-trees. After a careful inspection we have estimated that 20,000 cinchona-trees of all ages have been uprooted or so severely damaged that they must be immediately barked. Though we had given up barking definitely till the return of dry weather next year, we are now obliged to take it up with great energy and send the bark down to be dried in the plains. We hope to get a return of about 1,500*l.* to 1,800*l.* for "broken and twiggy" bark, but this will be but a poor result considering the sacrifice made to secure the bark at all hazards before it has dried and hardened on the trees.

Out of the small garden at Castleton, covering only about five to six acres, I found fifty-five trees destroyed, and ninety-eight severely injured. Out of the trees severely injured, *i.e.* probably blown quite down and put up again with trimmed limbs and supports, I found the Para-rubber mangosteen, Tonquin-bean, cam-wood, olive, cinnamon, nutmeg, East Indian mango, chocolate, Liberian coffee, &c. Even if they live we shall get no fruit from them during the next season, and we shall be unable to supply plants in great demand for some time.

I am glad to say that the superintendent did not suffer personally, though the roof of the residence was partially blown away, and the office canted almost on its side.

The Parade Garden, Kingston, felt the hurricane greatly, but as we had nothing there except ornamental trees and shrubs we hope to recover our losses soon.

The cocoanut plantation at the Palisadoes had sixty-one bearing trees blown down, and forty-one rather young ones just coming into bearing. This plantation is on a narrow spit of sand running six miles out and inclosing Kingston Harbour. The force of the wind being from the south and against the plantation, the waves broke over it at several places, and the harbour being consequently filled, much damage was done to the wharves and shipping.

You will, I am sure, be sorry to hear that the Old Bath Garden has also shared in the general injury. The fine old cinnamon-tree, the camphor-tree, and the pinus are down. Till the place is cleared the keeper is unable to give me fuller particulars.

The King's House Gardens and grounds have fortunately escaped much injury.

D. MORRIS

### NOTES

MESSRS. CHARLES GRIFFIN AND CO. announce that they have at last in the press the memorial volume to the late Prof. Macquorn Rankine. It is entitled "A Selection from the Miscellaneous Scientific Papers of W. J. Macquorn Rankine, C.E., LL.D., F.R.S., late Regius Professor of Civil Engineering and Mechanics in the University of Glasgow, from the *Transactions* and *Proceedings* of the Royal and other Scientific and Philosophical Societies, and the Scientific and Engineering Journals, with an Introductory Memoir of the Author, by P. G. Tait, M.A., Professor of Natural Philosophy in the University of Edinburgh; edited by W. J. Millar, C.E., Secretary to the Institution of Engineers and Shipbuilders in Scotland." The volume will contain many papers of great weight and value, at present to be found only in the Records of the various scientific and philosophical societies, and in the scientific and engineering journals, to which they were originally contributed, and therefore inaccessible to the majority of scientific workers. No doubt the bringing-together in one volume of these successive important contributions to science will be acceptable to all who knew of Rankine's high position in science. A fine portrait on steel will be prefixed to the volume.

WE have a few further details on the meeting of the German Association at Danzig. Salzburg was unanimously chosen as the town in which the next year's congress of the Association

should be held. Dr. Wernicke of Berlin gave an address "On the Scientific Standpoint in Psychiatry," and in the section for physics and meteorology Dr. L. Weber read a paper upon "Lightning Strokes in Schleswig-Holstein." In the section for the superintendence of instruction in mathematics and natural science Dr. Feyerabendt spoke with reference to mathematical school-books, which, as he showed, would bear much simplification and condensation. A point which he urged among others was that the matter taught should be divided, not upon scientific principles, but with regard to its easy and ready comprehension by the scholar.

THE death is announced, on August 22, of the Hon. John Imray, M.D., of Dominica, West Indies. Dr. Imray had done much for the botany of his island, but is best known for his successful efforts to introduce Liberian coffee and the cultivation of limes into the West Indies. Another death is that of M. Edmond Darbier, the translator into French of some of the works of Mr. Herbert Spencer and Sir John Lubbock, at the age of forty-six years.

A LAUDABLE innovation has been made in the library of the French Academy, which is not open to the public. Any one wishing to consult any of the rare and precious books in the library has only to make an application to the librarian to receive the required authority.

DR. WATT, of the Bengal Educational Department, who is now engaged in the examination at Kew of his extensive collections of Indian plants, has been deputed by the Government of India to visit Manipur, on his return from furlough, for the purpose of reporting on the forest and vegetable resources of that territory.

*Science*, the new American record of scientific progress, states that the Rev. W. H. Dallinger has consented to become Governor and Professor of Natural Sciences of Wesley College, Sheffield, U.S.A.

MR. JAMES BLYTH of Edinburgh has been elected to succeed Prof. Forbes in the Chair of Natural Philosophy at Anderson's College, Glasgow.

DR. J. VOSMÆR of the Hague intends publishing a detailed bibliography of the sponges, and it is to be hoped that all authors of works or papers on this interesting group will send copies of their writings to him at 73, de Kuyter Straat, Haag, Holland.

THE bureau of French meteorology has been revived for 1880-81, M. Hervé Mangon being continued president.

THE recent change of Ministry in France has brought forward for the second time since 1870 the Minister of Public Instruction to the direction of the Cabinet. M. Barthelemy St. Hilaire, the new head of the French Foreign Office, is not only a member of the French Senate, but also of the Academy of Moral and Political Sciences. He has published a large number of works on philosophy, among which the most considerable is a translation of the whole works of Aristotle, with a commentary. In order to be better able to understand physics and mechanics, he studied mathematics at the age of forty-five under the direction of his friend Corioles, then scientific director of the Polytechnic School. He was an intimate friend of Leverrier. He was born in Paris in 1809, and has just completed his seventy-first year.

THE Birmingham Natural History Society, which has hitherto met in the Midland Institute, has been provided with ample accommodation in the Mason Science College. The Society, which numbers 400 members, is making an effort to fit up the rooms in an appropriate and comfortable manner.

THE Epping Forest and County of Essex Naturalists' Field Club held the seventh, and probably the last, of the summer course of field meetings at High Beech and Monk's Woods on the 2nd inst., the purpose of the meeting being the observation of the *cryptogamic* flora of Epping Forest. The conductors were Dr. M. C. Cooke, Mr. Worthington Smith, F.L.S., Mr. James English, and Mr. E. M. Holmes, F.L.S.; and the party (upwards of fifty in number) included many well-known London naturalists. Several scarce *fungi* were noticed, although the weather proved very unfavourable for field-work. After tea, botanical demonstrations were given, one of the speakers being Prof. Max Cornu of Paris, who expressed the pleasure he had in being present, and said that he hoped to establish similar meetings in Paris. It is intended to make this "fungus meeting" an annual institution.

DR. ANDREW WILSON, F.R.S.E., has in the press a new work entitled "Chapters on Evolution," in which a popular *résumé* of the Darwinian and other theories of development is to be given. Messrs. Chatto and Windus are the publishers.

THE French Minister of War has authorized the erection of a meteorological observatory in the fort which has been recently constructed in the Ballon de Servance, in the Vosges.

THE Rev. A. E. Eaton states (*Entomologist's Monthly Mag.*) that "in Lisbon male field-crickets are sold in miniature cages by bird-fanciers at the rate of a penny a-piece. They are kept in stock by hundreds together in open tea-chests, laced for the first three or four inches from the top with slips of tin, and are fed upon lettuces. The natives like to have a 'grillo' chirping in the room, and make pets of them." Has this, or a similar custom, been observed by travellers in other parts of the South of Europe? No doubt there is a superstitious element in it, on the principle that sometimes induces our own people to send to the bakers for house-crickets "for luck." In China, and elsewhere, other Orthopterous insects are well known to be sold in little cages.

HERETO, we must confess, Trinity College, London, has been somewhat of a *nominiis umbra* to us; but with its fat Calendar before us it can be so no longer. It was established in 1872 mainly for the promotion of musical education. The Council, we are glad to see, take a liberal view of what is necessary to constitute a well-educated musician, and provide the means of a really liberal education. There is a faculty of music in which, among other subjects, the physiology of the vocal organs and of the ear is taught. In the faculty of arts, besides ancient and modern languages, there are classes in mathematics, chemistry, zoology, botany, geology, and physiology. The College has not only its curriculum for students in London, but has centres for examination all over the three kingdoms, and judging from the lists of names of those who have passed, these examinations must be widely taken advantage of. The Calendar contains all necessary information as to the College and its work, with the examination papers for the past year and other matters. If it is able to carry out its programme, the institute ought to do much good.

AT the Exhibition in connection with the Sanitary Congress which has been held at Exeter, there are several things worthy of some notice. It may be mentioned that the marked features of the collection are the gas stoves, improved flushing apparatus, ranges for the saving of fuel, various appliances for house drainage, ventilation, and arrangements to prevent sewer gas from rising into houses through closets and sinks. The number of manufacturers who exhibit under these heads shows the principal directions in which practical sanitarians are working. First as to the gas-stoves. These are divided into heating-stoves and cooking-stoves. In the heating group the object is to attain as much radiation as possible; in the cooking group the object is to prevent loss of heat by radiation. The Exeter

Gaslight and Coke Company, believing that gas will soon supersede coal for heating and cooking, whilst it will itself be superseded as a lighting agent, have offered four handsome silver medals for the best stoves. It is stated on the authority of a late cook of the Reform Club that the gas kitchener No. 99 in Class III. cooked 13 lbs. of meat in fifty-one minutes, at a cost of three farthings, the gas being at the rate of 3s. 6d. per thousand. The graduation of heat can be effectively regulated by the tap of the pipe which secures the gas burners. The gas water-heaters shown are of two kinds—those in which the gas jets are introduced under the bath, and those in which they are introduced into a separate boiler placed in the bath-room or outside it. No. 25, Class III., is an example of an upright cylindrical boiler with which water enough for a bath can in twenty minutes be obtained at 95°. It is impossible to draw attention to all the novelties, but there are some few deserving special attention. Class II., No. 3, is a "twin" door. Two doors a few inches apart are hinged so as to open together. There is an open space for ventilation between them. For housemaids' sinks on different landings, for closets, and for sculleries and kitchens, they are invaluable. In filters there is not much new. A French firm shows a modification of their well-known filters, it being an adaptation of their principle to table filters with the use of Carferal. The main point is that the Carferal can be so readily changed, and it is now well recognised that no filtering material is of any good after many days' use. The trouble involved is no more than that of making tea, and a lady can see to it herself without being at the mercy of careless servants.

THE *St. James's Magazine* for October contains the first instalment of an interesting series of articles on "Lightning Protection for Telegraphs."

THE remains of a lake village have been discovered in a marsh at Regnate, near Milan. They include, it is stated, shavings of flints apparently cut with bronze instruments.

THE *Daily News* Naples correspondent writes that in the excavations commenced a short time ago at Villagrande (Sardinia), there have come to light some instruments which are very remarkable if, as believed by competent persons, they belong to the bronze epoch, which, it is asserted, was exceptionally prolonged in this part of the island. The instruments in question are two bronze saws and a four-pronged fork, all is said to be found in the same repository. Near Taranto, in some new excavations opened in the vicinity of former ones, there have been found twenty-two skeletons, each in its respective tomb, not far below the surface of the ground. The tombs are all dug in the rock, disposed in various positions, and covered with square slabs of stone. Some of them were capable of holding two corpses.

MR. FROUNDES will hold, on Saturday afternoon, at 1, Cleveland Row, St. James's, the first of a series of meetings at which Japanese art with native sketches, photographs, &c., will be exhibited, and some account given of the country and people.

THE Philadelphia Court has forfeited the charters of the Eclectic Medical College of Pennsylvania and the American University of Philadelphia for selling bogus diplomas. These were the medical colleges managed by Dr. Buchanan, who is now awaiting his trial here.

THE exhibition of the Photographic Society opened at the Galleries, 5A, Pall Mall East, on Monday, and is quite worth a visit. There are several productions of special interest: among these are some fine photographs from Novaya Zemlya taken during the second Dutch Arctic Expedition last year; several excellent views of the Tay Bridge disaster; Burnham Beeches, by Lieut. L. Darwin, R.E.; magnificent portraits of lions and



tigers taken, we presume, in the Zoological Gardens; several beautiful views taken of Siam, including a group of Laotian huts. There are also several specimens of new apparatus used in photography.

AN important innovation has been made in all the French colleges by M. Ferry. Any pupil wishing to be promoted to a superior class is obliged to pass an examination. The Government is asking important credits for the rebuilding of the principal colleges of Paris and the construction of new colleges outside of the fortifications.

*Education* is the title of a new international bi-monthly magazine, devoted to the science, the art, the philosophy, and the history of education. It is published at Boston, Mass., and by Triebner and Co., London.

A USEFUL exhibition is being held in Glasgow of apparatus for the utilisation of gas, electricity, oils, &c., and of hydraulic, architectural, mining, and sanitary appliances.

UNDER the name of Tong-pang-chong a Chinese remedy for skin diseases was brought to European notice some two years since. The material as brought to this country appeared like fragments of a woody root, and it was said to be produced by a plant growing in Siam, from whence it is sent to China, where its use had become quite general. From subsequent information received from China and from examination and comparison of specimens sent to this country with those already contained in the Kew Museum, there seemed but little doubt that the plant which produced the Tong-pang-chong of the Chinese was *Rhinacanthus communis*, an acanthaceous plant. A good deal of interest was attached to this remedy when it first came to notice, since which time nothing has been heard of it until within the last few weeks, when some of the material has been received in this country, and is now in the possession of Messrs. Christy and Co. of Fenchurch Street. Whether this consignment will prove to be identical with *Rhinacanthus communis*, and so prove the accuracy of the preliminary determination which was made from scant materials, or whether it will turn out to be produced by a distinct plant will no doubt, shortly be seen. The remedy is referred to in the *Kew Garden Report* for 1877, p. 41.

HIERR TORNØE has published in the *Sitzungsberichte der k. Akademie der Wissenschaft zu Wien* (81, 924) a detailed account of the estimations of salt in the Norwegian Sea, conducted by him during the late Norwegian North Sea Expedition. The paper is a valuable contribution to the physical history of the North Sea.

THE monster python which is kept alive in the Antwerp Museum having had inflammation of the jaw, a Belgian doctor volunteered to enter its cage in order to cure it; but the brute attempted to suffocate the poor doctor, who was glad to escape with his life.

THE Queenwood College Mutual Improvement Society seems to be doing much to encourage the study of natural science among its members. The Report of the Committee for the last summer term speaks highly of the various collections made for the exhibition; several useful papers were read and interesting excursions made.

In the report of the awards made by the different juries of the Exhibition of Agriculture and Insectology at Paris it is stated that a public company has been formed in Spain for the rearing of the silkworm fed on the oak, and the number of cocoons to be collected this year will probably amount to no less than three millions. A special machine for weaving this new silk has worked during the whole time that the Exhibition has been open. A medal was awarded to an exhibitor for a lamp specially arranged to catch insects. It is suggested in the

report that the same experiment should be tried by electric light, and a recent instance has been quoted to prove that it would be really successful. A certain number of electric lights, for ordinary illuminating purposes, were used this summer in the gardens of the Meaux Exhibition, in the vicinity of the Forest of Fontainebleau. No arrangements were made for catching the insects, and they fell round the lamps, except a few that got admittance through the holes of the regulator. The number of the latter was so large that two of these lamps placed at a coffee stall in the open air had to be removed, all the consumers being covered by moths of every description.

THE piscicultural experiments at Ercildoune, Victoria, Australia, have been unusually successful; 9,100 ova were collected, of which 2,000 were salmon trout.

THE additions to the Zoological Society's Gardens during the past week include a Purple-faced Monkey (*Semnopithecus leucopymnus*) from Ceylon, presented by Mr. Wm. Collingwood; a Macaque Monkey (*Macacus cynomolgus*) from India, presented by Mr. Henry Thimbleby; a White-cheeked Capuchin (*Cebus lunatus*) from Brazil, presented by Mr. Henry Ch. Marckman de Lichtabell; two Common Cranes (*Grus cinerea*), European, presented by Mr. Norman W. Shairp; a Rose Hill Parrakeet (*Platyercus eximius*) from New South Wales, presented by Mr. Charles Porter; a Common Chameleon (*Chamaeleon vulgaris*) from North Africa, presented by Mr. Percy Day; a West African Python (*Python sebr*) from West Africa, presented by Dr. F. Speer; a Bless-bok (*Aedaphus albifrons*) from South Africa, a Prince Albert's Curassow (*Crax alberti*) from Columbia, deposited; a Sulphur-breasted Toucan (*Ramphastos carinatus*) from Mexico, purchased.

#### OUR ASTRONOMICAL COLUMN

THE BINARY STAR  $\alpha$  CENTAURI.—Mr. W. I. Elkin, who has been recently a student at the University of Strassburg, has given, in a dissertation for the degree of Doctor, a new determination of the orbit of this remarkable star, in which he has had the advantage of a fine series of measures executed by Sir T. Maclear, Mr. W. Mann, and Mr. G. Maclear at the Royal Observatory, Cape of Good Hope, collected and forwarded to him by Mr. Gill. We subjoin his elements, which, though not considered definitive, yet appear to represent the whole course of micrometrical measures very satisfactorily. Mr. Gill's measures in 1877 seem to indicate well the position of the companion about its nearest approach to the principal star, which it was feared at one time there would be danger of losing at this passage of the periastre. For the sake of comparison the provisional orbit deduced in 1879 by Dr. Doberck is annexed; the most noticeable difference is in the period of revolution.

	Elkin.	Doberck.
Passage of periastre ... ..	1875.97	1875.12
Node ... ..	25° 47'	25° 32'
Node to periastre on orbit. . . .	54° 47'	45° 58'
Inclination ... ..	79° 32'	79° 24'
Excentricity ... ..	0.5260	0.5332
Semi-axis major ... ..	17".50	18".45
Revolution ... ..	77.42 years	88.536 years.

Mr. Elkin's orbit gives the following angles and distances:—

1880.0	Position	185.7	Distance	4".79
1881.0	"	192.4	"	6.81
1882.0	"	196.1	"	8.70
1883.0	"	198.5	"	10.42
1884.0	"	200.2	"	11.98

For the absolute parallax of  $\alpha_2$  Centauri, he states that the series of 156 altitudes observed on the same days, directly and by reflection with the Cape circle in the years 1856-60, assigns + 0".793  $\pm$  0".068; Moesta from observations at Santiago had found 0".88. Although a large parallax, the largest perhaps yet detected, may still be attributed to this star, it appears to be Mr. Elkin's conclusion that it yet remains to be determined within very narrow limits. Probably Mr. Gill, with the aid of the heliometer, may in due course give a good account of it.

**THE VARIABLE R HYDRÆ.**—Dr. Gould, at Cordoba, has given much attention to the changes in this variable star, respecting which Argelander remarked that so long as observations were confined to European latitudes little would probably be understood, and he has deduced a formula closely representing the observations, excepting one by Maraldi, about which there appears to be a large error. The earliest recorded observations of this celebrated variable Dr. Gould remarks were those of Hevelius in April, 1662, published in the scarce volume of the "Machina Cœlestis" in 1679. Montanari of Bologna comparing Bayer's Uranometry with the sky on April 15, 1670, remarked it as a star of the fourth magnitude, not entered upon the map, and notified it as a new object. Its variability was recognised by Maraldi at Paris in 1704, who watched it at intervals till 1712. There then appears to be a gap in the observations until we come to those of Pigott in 1784 and 1785. Argelander collected and discussed all the observations to the beginning of 1863, and deduced a formula which fairly represented the data since 1784. The length of the period is decreasing rapidly, amounting, as Dr. Gould says, to more than nine hours at each successive recurrence—a circumstance which impeded the determination of the number of periods elapsed between Montanari's observation in 1670 and the first maximum noted by Pigott. Twelve periods having elapsed since the latest maximum included in Argelander's investigation, present data allow of clearing up several doubtful points.

Dr. Gould finds that the number of periods between the maxima of 1670 and 1784 must have been eighty instead of eighty-four, as assumed by Argelander, and the number between the maxima of 1670 and 1704 must have been twenty-three instead of twenty-five. Assuming that Maraldi's second maximum is erroneously dated in 1708, instead of 1707, he finds that all existing observations except Maraldi's first, may be represented within quite tolerable limits, "by supposing a uniform diminution in the period, upon which are superposed variable terms, according to which a symmetric perturbation completes its cycle in seventy-two years," and the following formula is finally inferred. The days are counted from the beginning of the year 1875:—

$$T = 35^{\circ}6d. + 434^{\circ}445d. n - 0^{\circ}37974d. n^2 + 32^{\circ}0d. \sin(5^{\circ}n + 10^{\circ}) + 2^{\circ}6d. \sin(10^{\circ}n + 32^{\circ}) + 6^{\circ}8d. \sin(15^{\circ}n + 205^{\circ})$$

It will be found that the formula gives the next maximum to January 18, 1881; Schmidt alone has observed the minima, which occur on the average at about 9-16ths of the interval between the maxima.

**A NEW COMET.**—On the evening of September 29 Dr. Ernst Hartwig of the Imperial Observatory, Strassburg, discovered a bright comet about 10° north of Arcturus, and having obtained observations on three consecutive nights, has calculated the following elements:—

Perihelion passage, September 6<sup>h</sup> 9<sup>m</sup> 52<sup>s</sup> M.T. at Berlin.

Longitude of perihelion ... ..	80 0'6
"  ascending node ... ..	43 32'3
Inclination of orbit ... ..	38 48'3
Logarithm of perihelion distance ... ..	9'56450
Motion—retrograde.	

Hence he finds, for Berlin midnight:—

	R.A.		Decl.		Log. distance from Earth.		Sun.	
	h.	m. s.	h.	m. s.				
Oct. 6 ...	16	7 40	...	+24 35'5	...	9'8147	...	9'9231
8 ...	16	29 22	...	22 46'2	...	9'8488	...	9'9432
10 ...	16	47 18	...	21 3'5	...	9'8827	...	9'9623
12 ...	17	2 15	...	19 29'6	...	9'9158	...	9'9805
14 ...	17	14 51	...	+18 5'0	...	9'9476	...	9'9978

The intensity of light is rapidly diminishing, being on October 14 only one-sixth of that at the time of discovery.

The above orbit places the comet at 6 a.m. G.M.T. on September 12 near to Regulus, so that it is distinct from the object notified by Mr. Lewis Swift of Rochester, N.Y.

The comet was seen for a few seconds between clouds at the Royal Observatory, Greenwich, and at Mr. Barclay's observatory, Leyton, on the 5th, and is described by Mr. Talmage as "very bright," with a long tail."

### CHEMICAL NOTES

In connection with the subject of water of hydration the results of Van Bemmelen, described in the *Berliner Berichte*, are of interest. He has determined the quantities of water

parted with, and also taken up by various hydrated oxides under different conditions of temperature and humidity of surrounding atmosphere. The results afford another instance of the graduation of chemical into physical actions. The amount of water taken up varies but little, but the strength of the combination varies much. The formation of hydrates appears to be a function of molecular weight of the oxide and of the temperature.

Two papers of great importance by Thomsen have just appeared in the *Berliner Berichte*. Thomsen attempts to base a general theory of the structure of carbon compounds on thermal determinations. He does this by measuring (indirectly, of course) the heat of dissociation of the carbon molecule, and from this and other data, finding a thermal value for the combination of two carbon atoms, to form a gaseous compound, by four, three, two, or one "link." Hence he deduces a thermal value for each "link." General equations are given for calculating the heats of formation of various isomers, assuming a certain "linking" of the atoms for each. In cases where various "linkings" may be assumed, a determination of the heat of formation may determine which "linking," and therefore which structural formula, is the more probable.

In a paper read before the Owens College Chemical Society Messrs. Bevan and Cross detail experiments on jute fibre, which lead them to regard the intercellular portion of this fibre as probably consisting of an aromatic compound of the quinone class, together with a substance allied to the carbohydrates, and somewhat of the nature of cellulose. The presence of this intercellular substance confers on jute the power of retaining various dye-stuffs. The authors also describe a method of separating cellulose from jute fibre, based on the action of chlorine or bromine, subsequent boiling with dilute caustic lye, and washing in acid. Jute fibre which has been acted on by chlorine is coloured deep magenta by immersion in a solution of sodium sulphite. The work of Messrs. Bevan and Cross promises results of considerable importance.

MR. O. HEINER publishes in the *Antylst* the results of his determinations of phosphoric acid in potable waters. He concludes that the presence of more than 0.5 parts per million of  $P_2O_5$  should be regarded with suspicion; also that absence of phosphates affords no positive proof of freedom from pollution.

It is stated in the *Chemiker Zeitung* that if a solution of two parts of citric and one of molybdic acids be evaporated to dryness, heated to incipient fusion, and dissolved in 30 to 40 parts of water, a solution is obtained which imparts a blue colour to paper immersed in it, and dried at 100°. This paper is bleached by water, and may be used as a test for the presence of water in alcohol, ether, &c.

M. DE SCHULTER states in *Comptes rend.* that he has succeeded in preparing pellucid crystals of analcite by heating a solution of sodium silicate or caustic soda along with aluminous glass in sealed tubes to about 190°.

FROM analyses and determinations of specific heat of cerium tungstate, Cossa and Zecchini (*Gazzetta chim. Italiana* for July) think that the atomic weight of cerium is better represented by 92, the number formerly adopted, than by 138, which—or more probably 141—is generally regarded as correct. The data of the Italian observers are as follows:— $Ce_2(WO_4)_3$  ( $Ce = 141$ ) = 1026,  $\times 0.0821$  (sp. heat found) = 84.2, atomic heat of  $W = 6.4$ , of  $O = 4$ ; hence molecular heat of  $(WO_4)_3 = 67.2$ , but  $84.2 - 67.2 = 17$ , which  $\div 2$  gives 8.5 as the atomic heat of cerium.  $CeWO_4$  ( $Ce = 92$ ) = 340,  $\times 0.0821 = 27.9$ ; but  $27.9 - 22.4$  (that is, molecular heat of  $WO_4$ ) gives 5.5 as the atomic heat of cerium. The careful determinations of the specific heat of metallic cerium made by Hillebrand, and the general analogies of the cerium salts, must however be regarded as of more value in determining the atomic weight of this metal than a series of estimations of the specific heat of a compound containing oxygen, concerning the influence of which element on the specific heat of compounds thereof we have so little exact knowledge.

THERE has of late been a considerable amount of discussion as to the existence of pentathionic acid,  $H_2S_5O_6$ . In a recent paper in the *Journal of the Chemical Society*, Messrs. Takamatsu and Smith bring forward evidence which appears conclusively to prove that this acid does exist.

HELL has studied the action of bromine on acids of the acetic series, and in a paper in the *Berichte* he shows that the substitution of bromine for hydrogen proceeds slowly, until from

10 to 20 per cent. of the change is completed, then more rapidly until about 60 per cent. is reached, and then again slowly. He also shows that the greater the molecular weight of the acid the more rapidly is the period of maximum action reached. In these phenomena we have fresh examples of the so-called "Chemical Induction" of Bunsen and Roscoe. This supposed special phase of chemical change would indeed appear to be of very frequent occurrence, being only absent in those changes—if such exist—which consist of a single part, the direct change only.

BERTHELOT, in the *Comptes rendus* of the Paris Academy, describes experiments which lead him to believe that by the electrolysis of dilute sulphuric acid a new oxide of sulphur— $S_2O_3$ —is produced. This substance belongs to the class of peroxides, and is analogous with ozone and hydrogen peroxide; the formation of each of these substances is attended with absorption of heat. From the study of the thermal changes accompanying the solution of chlorine in aqueous hydrochloric acid and in water, the same author thinks that a trichloride of hydrogen,  $HCl_3$ , probably exists.

BOUSSINGAULT, in *Annales Chim. Phys.*, has examined the action of heat on barium dioxide under diminished pressure, and has shown that in a vacuum this substance parts with oxygen at a low red heat, and that oxygen is readily absorbed from the atmosphere by the baryta thus produced at about the same temperature, under ordinary pressures. It seems therefore that baryta may be employed as a carrier of oxygen from the atmosphere; hitherto the high temperature required for the decomposition of barium dioxide has brought about some molecular change in the baryta produced, which has rendered it incapable of absorbing more than very small quantities of oxygen from the atmosphere.

In *Comptes rendus*, Hautefeuille states that he has obtained crystals of orthoclase and of quartz in the same tube by heating a mixture of acid potassium phosphate—previously fused with silica and alumina—with silica and a little potassium fluosilicate in a glass tube.

RADZISZEWSKI in Liebig's *Annalen* gives a careful study of the conditions under which various carbon compounds exhibit phosphorescence; he concludes that this phenomenon occurs with those compounds which combine, in presence of alkalis, with the active oxygen of ozone or other peroxide. Phosphorescence he regards as a special case of the phenomenon of combustion; during slow oxidation active oxygen is produced; hence it is in such processes of oxidation that phosphorescence is noticed. When oxidation is rapid much of the active modification of oxygen is produced, combination occurs rapidly between this and the oxidising substance, and we have the phenomenon of combustion. The phosphorescence of certain organised creatures is due, according to the author, to the slow oxidation, by the agency of active oxygen, of such compounds as lecithin, cholesterolin, spermacetti, myricylic alcohol, sugar, fats, or ethereal oils. He shows that these substances are decomposed by choloin and neurin, and generally by bases of the formula  $R_1.N.OH$  (where R is a monovalent alcoholic radicle, e.g.,  $CH_3$ ,  $C_2H_5$ , &c.), and that this decomposition is attended with phosphorescence.

A SMALL pamphlet, "Report on Two Kinds of Coal submitted by the Chesapeake and Ohio Railroad Coal Agency," published by the Bureau of Steam-Engineering of the U.S. Navy Department, contains a detailed account of the methods of determining on the large scale the relative ratios of steam coal, which must be of very considerable service to any who require to perform such determinations.

IF aluminium hydrate, obtained by precipitating a solution of alum by ammonia, be allowed to remain in contact with water for three or four months, it undergoes, according to M. Tommasi (*Comptes rendus*), a molecular change whereby it is rendered very much less soluble in acids, and is no longer capable of forming a compound with aluminium chloride.

#### PHYSICAL NOTES

THE conditions of geysers are investigated at length by Herr Otto Lang in a recent paper to the Göttingen Society of Sciences (*Nachr.*, No. 6). The theory of Bunsen he considers inadequate, and he proposes another, which has an interesting similarity to that of Mr. Mallet regarding the mechanism of the intermittent volcano at Stromboli.

OBSERVATIONS as to the changes of length of iron bars through magnetisation having been somewhat discordant, Prof. Righi has lately taken up the subject afresh (*Il Nuovo Cim.*, ser. 3, tom. vii.), and, to measure the displacements, he attached a fine steel spring, with mirror, to one end of the bar (which was magnetised by means of a spiral), the mirror being observed through a telescope. Changes in length were thus magnified 8,000 times. The results were as follows:—1. Magnetism produces in iron and steel an increase of dimension in direction of the magnetisation. 2. On cessation of the magnetising force a part of this increase remains, and more or less of it according to the coercive force. 3. The elongations are proportional to the square of the current's intensity when this is not very great. 4. When, after a strong current through the spiral, a weak current is sent in the opposite direction, it produces a shortening; but even when it is strong enough to demagnetise the bar, the latter retains a greater length than in the normal state. 5. During reversal of the polarity of a bar its length becomes momentarily less, and it oscillates in length. 6. A bar or wire of iron traversed by a current contracts at the moment of closing the circuit. 7. On opening the circuit it elongates, but this elongation is less than the initial contraction, indicating that transverse magnetism partly remains. 8. In reversal of the transverse polarity the bar elongates for a moment, and thus oscillates in length. 9. The contraction produced by the current is greater when the bar has before been longitudinally magnetised. 10. Some iron bars show a tendency to take spiral magnetisation, i.e. to rotate the magnetic axes of their molecules in the direction of the spiral. This is shown by the contractions caused by a current passing through the bars, which are different according to the direction of the current and that of the previous longitudinal magnetisation.

THE absorption of radiant heat in gases and vapours form the subject of a recent valuable paper to the Vienna Academy (July 1) by Messrs. Lecher and Pernter. They consider "vaporisation" to have been an important source of error in Tyndall's experiments. In their own method the thermopile and the heat-source were brought into the same vessel. Air-currents were avoided by causing the surface of radiation to be heated in each case suddenly from without, by means of a steam jet, to 100° C. Among other results the absorption of water-vapour is found, in opposition to Tyndall, immeasurably small. Violle found, on Mont Blanc, that a metre of the air absorbed only 0.007 per cent. of the whole radiation; according to this, a layer of 300 m. length would be necessary to produce, with water-vapour saturated at 12', that absorption which Tyndall obtains in 1.22 m. This and the authors' own experimental results are considered to prove beyond dispute the very small absorption of aqueous vapour. The authors' results for gases agree pretty well with Tyndall's. No simple connection between absorption and pressure of the substance was discoverable. The absorption, even for radiation of a heat-source of 100° C., is selective. The authors found the absorption of certain substances of the fat series examined to increase rapidly with increasing proportion of carbon. It seems to be otherwise, however, with bodies from other groups; thus, e.g. benzol, notwithstanding its six C-atoms, has a fairly small absorptive power.

MESSRS. A. P. LAURIE and C. I. BRUTON of Edinburgh have devised a new electromotor engine, in which four electromagnets act successively upon an eccentric armature of soft iron rotating about a central shaft, thus avoiding the back pull of Froment's and other forms of electromotor. The gradual approach thereby secured between the armature and the active field-magnets is a feature common to this engine and to that of Mr. Wiesendanger. The principle has long been applied, though somewhat differently, in the little motors employed for whirling Geissler's tubes.

SIGNOR MACALUSO has recently described a new form of mercurial air-pump, on the Sprengel principle, sufficiently simple to be capable of construction from the materials at hand in any chemical laboratory, and requiring no india-rubber connections. An outline diagram of the pump is given in the August number of the *Beiblätter*.

HERR A. SCHERTEL has determined the fusing-points of a number of difficultly-fusible substances by comparing them with those alloys of gold and platinum in various proportions. He gives the fusion-point of basalt as 1,166° C.; that of adularia (from the St. Gotthardt) is stated as being between 1,400° and 1,420°; and nickel between 1,392° and 1,420°.

THE electric conductivity of gas-carbon and its variability under pressure has been re-examined by MM. Naccari and Pagliani. Carbon prisms were carefully covered at certain points of their surface with copper by electro-deposition to secure good contact with the wires by which they were inserted in a Wheatstone's bridge to determine their resistance. When subjected to great pressures the resistances of the rods of carbon showed scarcely any change. Hence it appears that the changes of conductivity which carbon exhibits in the microphone and in the carbon telephone under varying pressures are due not to any alteration of the contact between the particles in the intimate structure of the substance, but to mere changes in the external contact.

DR. WERNER SIEMENS has lately described to the Berlin Academy a new series of experiments on the electric conductivity of carbon, and the way it is affected by temperature. He finds that of gas retort carbon at  $0^{\circ}$  C.  $0\cdot0136$  (mercury = 1), and the coefficient of increase of conductivity  $0\cdot000345$  per degree Celsius. The artificial carbon rods produced by compression of carbon powder also show greater conducting power with increasing temperature, but the increase is not so great (as in retort carbon). Dr. Siemens thinks other experimenters may have been led to erroneous results by faulty connections. He effected the union of the carbon ends with the conducting wires by means of galvanic coppering. The property of conducting better at higher temperatures is regarded as a property of the carbon material itself, not as a consequence of its structure. It may be explained (Dr. Siemens says) as in the case of crystalline selenium, if we assume that the carbon is an allotropic modification (containing latent heat) of a hypothetical metallic carbon.

IN his theory of the bifilar magnetometer Gauss considered that the torsion of the suspending wires, and the induction of the earth's magnetism on that of the suspended magnet, might be neglected, as very small. In the course of several years' observations, Herr Wild having found this to cause serious discrepancy between theory and experience, has (at Pawlowski Observatory) developed the theory anew, taking account of those two factors. Substituting cocoon-threads for wires, he considers the moment of torsion can be reduced to considerably less than  $0\cdot3$  per cent. of the moment of gravity (it was more than 5 per cent. with wires). The improved theory, while agreeing much better with experience, affords an excellent method of determining separately, from direct observation of the angle of torsion and the three durations of vibration of the magnet in the normal, reversed, and transverse position, its two kinds of induction-coefficient, viz., that in weakening, and that in increase of the magnetic moment by induction; also of determining the temperature-coefficient of magnets and of absolute measurement of the horizontal intensity (*Wied. Ann.*, No. 8).

IT appears from recent experiments by Herr Knoblauch (*Wied. Ann.*, No. 8) that in reflection of polarised heat-rays from metals, the rays of different heat-colours behave differently, in that they have in general different angles of polarisation, presenting, in the case of certain metals, as gold and silver, great differences, and in that of others, as copper and speculum metal, smaller. In the case of lead and arsenic these differences wholly disappear. With the former metals the transitions in reflection of different rays from linear to elliptic vibrations do not keep equal pace with each other; changing the angle of incidence from  $0^{\circ}$  to the angle of polarisation, the transformation of the vibration of one heat-tint is prominent, while in change of incidence from  $90^{\circ}$  to the angle of polarisation, it is that of another. With lead and arsenic, at all angles of incidence from  $0^{\circ}$  to  $90^{\circ}$ , the ellipses of certain constant heat-rays are always more extended than those of the other heat colours.

### GEOGRAPHICAL NOTES

THE full details of the Franklin Search Expedition published in the *New York Herald* of September 23 and following numbers do not contain much of scientific interest in addition to what we gave last week. The narrative contains a graphic and interesting account of the sledge journeys of Lieut. Schwatka's party, of the various Eskimo tribes met with, of the country traversed, and the remains of the Franklin Expedition. Some precision is given to our knowledge of the country, and many valuable hints given as to how to brave an Arctic winter. Although the extreme cold endured,  $103^{\circ}$  F. below freezing, is not so great as has been experienced in one or two previous

instances, we question whether an average temperature of  $100^{\circ}$  of frost for 16 days was ever before met with. A good many interesting relics of the Franklin party were collected, and there seems no doubt that the Eskimo did at one time have a number of books in a tin box belonging to the party who left the ships; but these, with gold watches and other mysteries, were given to the children for playthings, and have long ago disappeared. It is probable enough that among the books were some records of the progress of the expedition; but all hope of recovering them may now be abandoned. We trust that there will be no delay in the publication of the scientific observations which were doubtless made by Lieut. Schwatka's expedition.

THE new number of the Geographical Society's *Proceedings* provides us with an unusual supply of good readable papers of moderate length. Lieut. G. T. Temple furnishes "Notes on Russian Lapland," accompanied by a new map; the Rev. W. G. Lawes, the well-known missionary, "Notes on New Guinea and its Inhabitants"; the Rev. C. T. Wilson, lately of the Nyanza mission, a brief narrative of a journey over new ground in East Africa from Kagé to Tabora; and lastly, Major W. M. Campbell, R.E., an account of his visit to the previously unknown (except from hearsay) Shorawak valley and the Toba plateau, Afghanistan. The Geographical Notes supply particulars regarding the murder of Messrs. Carter and Cadenhead in East Central Africa, and Capt. T. L. Phipson-Wybrants' expedition to Umzila's country, east of Matabele-land, as well as a French surveying expedition for West Africa. These are followed by a *résumé* of some of Père Duparquet's notes on Orampo-land, an Egyptian exploring expedition in Somali-land, M. Regel's journey in Eastern Turkestan, and a summary of the Indian Marine Survey Report for 1878-79. There are also some useful additions to our knowledge of Eastern Perak, and an abstract of a Consular report on the Chinese province of Shantung. We must not omit to mention that the present number contains the map (postponed from last month) of the country between Sind and Candahar, showing the course of the proposed railway, on which Sir Richard Temple recently lectured before the Society and at Swansea.

THE new expedition despatched by the London Missionary Society to Lake Tanganyika, and consisting of the Revs. A. J. Wookey and D. Williams, with Dr. Palmer, left Zanzibar on June 14, and crossing to the mainland at Saadani, marched thence to Ndumi. Here they remained for a few days, until they got their full complement of *pagazi*, and finally started for the interior on June 21. Accomplishing some twelve or fifteen miles a day, they reached Mpedapwa on July 14, and were most kindly received by the Church Missionary Society's agents. They were to recommence their journey to the lake on July 19. Their caravan consists of 309 men, the chief of whom is Uliu, who accompanied the Rev. Roger Price, when the bullock-waggon experiment was tried some four years ago.

FROM a letter in *L'Exploration* we learn that M. Wiener had in July reached Archedona, in his exploration of the Napo, one of the great tributaries of the Amazon; unless he meets with disaster, we may expect to hear of him by and by from Pará.

THE *Mittheilungen* of the German African Society, of which six parts are published, contains much very valuable information on recent exploration in Africa by German explorers. We have detail of the progress of Herr Schütt's expedition in the Loanda region, of Rohlf's attempt to push southwards from Tunis, of Dr. Buchner to Muata Janvo's kingdom, of Dr. O. Lenz's determined and so far successful attempt to push southwards through Morocco to Timbuctoo and beyond. We have, besides, records of the doings of the International African Association, and of the various other societies for the exploration of Africa throughout the world. In the double number, 4 and 5, Dr. Reichenau gives a detailed list of the collection of birds sent home from Malanga in Angola by Herr Schütt.

A TELEGRAM from New York, October 5, states that the commander of the United States steamer *Alert* reports the discovery of a submarine volcano near San Alessandro, an island in the Pacific.

THE eruption of the volcano Fuego in Guatemala, to which we referred some weeks ago, ceased almost suddenly in the second half of the month of July. M. de Thiersant, French representative in Guatemala, writes to *La Nature* that another volcano of the same country, Pacaya, seems inclined in its turn to resume activity. At Amatitlan, a small town on the slope of

the mountain, subterranean noises succeeded each other almost constantly on July 28.

INTELLIGENCE received at Lloyd's from Christiania, dated October 1, states that the *Neptune* steamer, Capt. Rasmussen, which arrived at Vardø, previous to September 25, from the Obi, reports that on September 19, in Jugor Straits, she fell in with the *Siberiakoff's* expedition proceeding eastward.

THERE is a useful article in the last number of *La Nature* on French Guiana and its forest produce, by Dr. J. Harmand.

### SCIENCE AND CULTURE<sup>1</sup>

SIX years ago, as some of my present hearers may remember, I had the privilege of addressing a large assemblage of the inhabitants of this city, who had gathered together to do honour to the memory of their famous townsman, Joseph Priestley; and, if any satisfaction attaches to posthumous glory, we may hope that the manes of the burnt-out philosopher were then finally appeased.

No man, however, who is endowed with a fair share of common sense and not more than a fair share of vanity, will identify either contemporary or posthumous fame with the highest good; and Priestley's life leaves no doubt that he, at any rate, set a much higher value upon the advancement of knowledge and the promotion of that freedom of thought which is at once the cause and the consequence of intellectual progress.

Hence I am disposed to think that, if Priestley could be amongst us to-day, the occasion of our meeting would afford him a greater pleasure than the proceedings which celebrated the centenary of his chief discovery. The kindly heart would be moved, the high sense of social duty would be satisfied, by the spectacle of well-earned wealth, neither squandered in tawdry luxury and vain-glorious show; nor scattered with the careless charity which blesses neither him that gives nor him that takes; but expended in the execution of a well-considered plan for the aid of present and future generations of those who are willing to help themselves.

We shall all be of one mind thus far. But it is needful to share Priestley's keen interest in physical science; to have learned, as he had learned, the value of scientific training in fields of inquiry apparently far remote from physical science; to appreciate, as he would have appreciated, the value of the noble gift which Sir Josiah Mason has bestowed upon the inhabitants of the Midland district.

For us children of the nineteenth century, however, the establishment of a college under the conditions of Sir Josiah Mason's Trust, has a significance apart from any which it could have possessed a hundred years ago. It appears to be an indication that we are reaching the crisis of the battle, or rather of the long series of battles, which have been fought over education in a campaign which began long before Priestley's time, and will probably not be finished just yet.

In the last century, the combatants were the champions of ancient literature, on the one side, and those of modern literature on the other; but, some thirty years ago, the contest became complicated by the appearance of a third army, ranged round the banner of Physical Science.

I am not aware that any one has authority to speak in the name of this new host. For it must be admitted to be somewhat of a guerilla force, composed largely of irregulars, each of whom fights pretty much for his own hand. But the impressions of a full private, who has seen a good deal of service in the ranks, respecting the present position of affairs and the conditions of a permanent peace, may not be devoid of interest; and I do not know that I could make a better use of the present opportunity than by laying them before you.

From the time that the first suggestion to introduce physical science into ordinary education was timidly whispered, until now, the advocates of scientific education have met with opposition of two kinds. On the one hand they have been pook-pooed by the men of business who pride themselves on being the representatives of practicality; while on the other hand they have been excommunicated by the classical scholars, in their capacity of Levites in charge of the ark of culture and monopolists of liberal education.

The practical men believed that the idol whom they worship—rule of thumb—has been the source of the past prosperity, and will suffice for the future welfare of the arts and manufactures. They were of opinion that science is speculative rubbish; that theory and practice have nothing to do with one another; and that the scientific habit of mind is an impediment rather than an aid in the conduct of ordinary affairs.

I have used the past tense in speaking of the practical men—for although they were very formidable thirty years ago, I am not sure that the pure species has not been extirpated. In fact, so far as mere argument goes, they have been subjected to such a *feu d'enfer* that it is a miracle if any have escaped. But I have remarked that your typical practical man has an unexpected resemblance to one of Milton's angels. His spiritual wounds, such as are inflicted by logical weapons, may be as deep as a well and as wide as a church door, but beyond shedding a few drops of ichor, celestial or otherwise, he is no whit the worse. So if any of these opponents be left I will not waste time in vain repetition of the demonstrative evidence of the practical value of science; but, knowing that a parable will sometimes penetrate where syllogisms fail to effect an entrance, I will offer a story for their consideration.

Once upon a time, a boy, with nothing to depend upon but his own vigorous nature, (was thrown into the thick of the struggle for existence in the midst of a great manufacturing population. He seems to have had a hard fight, inasmuch as, by the time he was thirty years of age, his total disposable funds amounted to twenty pounds. Nevertheless middle life found him giving proof of his comprehension of the practical problems he had been roughly called upon to solve, by a career of remarkable prosperity.

Finally, having reached old age with its well-earned surroundings of "honour, troops of friends," the hero of my story beihought himself of those who were making a like start in life, and how he could stretch out a helping hand to them.

After long and anxious reflection this successful practical man of business could devise nothing better than to provide them with the means of obtaining "sound, extensive, and practical scientific knowledge." And he devoted a large part of his wealth and five years of incessant work to this end.

I need not point the moral of a tale which, as the solid and spacious fabric of the Scientific College assures us, is no fable, nor can anything which I could say intensify the force of this practical answer to practical objections.

We may take it for granted then, that, in the opinion of those best qualified to judge, the diffusion of thorough scientific education is an absolutely essential condition of industrial progress, and that the College opened to-day will confer an inestimable boon upon those whose livelihood is to be gained by the practice of the arts and manufactures of the district.

The only question worth discussion is, whether the conditions, under which the work of the College is to be carried out, are such as to give it the best possible chance of achieving permanent success.

Sir Josiah Mason, without doubt most wisely, has left very large freedom of action to the trustees, to whom he proposes ultimately to commit the administration of the College, so that they may be able to adjust its arrangements in accordance with the changing conditions of the future. But, with respect to three points, he has laid most explicit injunctions upon both administrators and teachers.

Party politics are forbidden to enter into the minds of either, so far as the work of the College is concerned; theology is as sternly banished from its precincts; and finally, it is especially declared that the College shall make no provision for "mere literary instruction and education."

It does not concern me at present to dwell upon the first two injunctions any longer than may be needful to express my full conviction of their wisdom. But the third prohibition brings us face to face with those other opponents of scientific education, who are by no means in the moribund condition of the practical man, but alive, alert, and formidable.

It is not impossible that we shall hear this express exclusion of "literary instruction and education" from a College which, nevertheless, professes to give a high and efficient education, sharply criticised. Certainly the time was that the Levites of culture would have sounded their trumpets against its walls as against an educational Jericho.

How often have we not been told that the study of physical

<sup>1</sup> An Address delivered on the occasion of the opening of Sir Josiah Mason's Science College, at Birmingham, on October 1, by Thomas H. Huxley, F.R.S.

science is incompetent to confer culture; that it touches none of the higher problems of life; and, what is worse, that the continual devotion to scientific studies tends to generate a narrow and bigoted belief in the applicability of scientific methods to the search after truth of all kinds. How frequently one has reason to observe that no reply to a troublesome argument tells so well as calling its author a "mere scientific specialist." And, as I am afraid it is not permissible to speak of this form of opposition to scientific education in the past tense; may we not expect to be told that this, not only omission, but prohibition of "mere literary instruction and education" is a patent example of scientific narrow-mindedness?

I am not acquainted with Sir Josiah Mason's reasons for the action which he has taken; but if, as I apprehend is the case, he refers to the ordinary classical course of our schools and universities, by the name of "mere literary instruction and education," I venture to offer sundry reasons of my own in support of that action.

For I hold very strongly by two convictions—The first is, that neither the discipline nor the subject-matter of classical education is of such direct value to the student of physical science as to justify the expenditure of valuable time upon either; and the second is, that for the purpose of attaining real culture, an exclusively scientific education is at least as effectual as an exclusively literary education.

I need hardly point out to you that these opinions, especially the latter, are diametrically opposed to those of the great majority of educated Englishmen, influenced as they are by school and university traditions. In their belief culture is obtainable only by a liberal education, and a liberal education is synonymous not merely with education and instruction in literature, but in one particular form of literature, namely, that of Greek and Roman antiquity. They hold that the man who has learned Latin and Greek, however little, is educated; while he who is versed in other branches of knowledge, however deeply, is a more or less respectable specialist, not admissible into the cultured caste. The stamp of the educated man, the University degree, is not for him.

I am too well acquainted with the generous catholicity of spirit, the true sympathy with scientific thought, which pervades the writings of our chief apostle of culture to identify him with these opinions; and yet one may cull from one and another of those epistles to the Philistines, which so much delight all who do not answer to that name, sentences which lend them some support.

Mr. Arnold tells us that the meaning of culture is "to know the best that has been thought and said in the world." It is the criticism of life contained in literature. That criticism regards "Europe as being for intellectual and spiritual purposes one great confederation, bound to a joint action and working to a common result; and whose members have for their common outfit a knowledge of Greek, Roman, and Eastern antiquity, and of one another. Special local and temporary advantages being put out of account, that modern nation will in the intellectual and spiritual sphere make most progress which most thoroughly carries out this programme. And what is that but saying that we too, all of us as individuals, the more thoroughly we carry it out shall make the more progress!"

We have here to deal with two distinct propositions. The first, that a criticism of life is the essence of culture; the second, that literature contains the materials which suffice for the construction of such a criticism.

I think that we must all assent to the first proposition. For culture certainly means something quite different from learning or technical skill. It implies the possession of an ideal, and the habit of critically estimating the value of things by comparison with a theoretic standard. Perfect culture should supply a complete theory of life, based upon a clear knowledge alike of its possibilities and of its limitations.

But we may agree to all this, and yet strongly dissent from the assumption that literature alone is competent to supply this knowledge. After having learnt all that Greek, Roman, and Eastern antiquity have thought and said, and all that modern literatures have to tell us, it is not self-evident that we have laid a sufficiently broad and deep foundation for that criticism of life which constitutes culture.

Indeed, to any one acquainted with the scope of physical science, it is not at all evident. Considering progress only in the "intellectual and spiritual sphere," I find myself wholly unable to admit that either nations or individuals will really advance if

their common outfit draws nothing from the stores of physical science. I should say that an army without weapons of precision and with no particular base of operations might more hopefully enter upon a campaign on the Rhine than a man, devoid of a knowledge of what physical science has done in the last century, upon a criticism of life.

When a biologist meets with an anomaly, he instinctively turns to the study of development to clear it up. The rationale of contradictory opinions may with equal confidence be sought in history.

It is, happily, no new thing that Englishmen should employ their wealth in building and endowing institutions for educational purposes. But, five or six hundred years ago, deeds of foundation expressed or implied conditions as nearly as possible contrary to those which have been thought expedient by Sir Josiah Mason. That is to say, physical science was practically ignored, while a certain literary training was enjoined as a means to the acquirement of knowledge which was essentially theological.

The reason of this singular contradiction between the actions of men alike animated by a strong and disinterested desire to promote the welfare of their fellows, is easily discovered.

At that time, in fact, if any one desired knowledge beyond such as could be obtained by his own observation, or by common conversation, his first necessity was to learn the Latin language, inasmuch as all the higher knowledge of the western world was contained in works written in that language. Hence Latin grammar, with logic and rhetoric, studied through Latin, were the fundamentals of education. With respect to the substance of the knowledge imparted through this channel, the Jewish and Christian Scriptures, as interpreted and supplemented by the Romish church, were held to contain a complete and infallibly true body of information.

Theological dicta were, to the thinkers of those days, that which the axioms and definitions of Euclid are to the geometers of these. The business of the philosophers of the middle ages was to deduce from the data furnished by the theologians, conclusions in accordance with ecclesiastical decrees. They were allowed the high privilege of showing, by logical process, how and why that which the Church said was true, must be true. And if their demonstrations fell short of or exceeded this limit, the Church was maternally ready to check their aberrations, if need be, by the help of the secular arm.

Between the two, our ancestors were furnished with a compact and complete criticism of life.

They were told how the world began and how it would end; they learned that all material existence was but a base and insignificant blot upon the fair face of the spiritual world, and that nature was, to all intents and purposes, the playground of the devil; they learned that the earth is the centre of the visible universe, and that man is the cynosure of things terrestrial; and more especially was it inculcated that the course of nature had no fixed order, but that it could be, and constantly was, altered by the agency of innumerable spiritual beings, good and bad, according as they were moved by the deeds and prayers of men. The sum and substance of the whole doctrine was to produce the conviction that the only thing really worth knowing in this world was how to secure that place in a better which, under certain conditions, the Church promised.

Our ancestors had a living belief in this theory of life, and acted upon it in their dealings with education, as in all other matters. Culture meant saintliness—after the fashion of the saints of those days; the education that led to it was, of necessity, theological; and the way to theology lay through Latin.

That the study of nature—further than was requisite for the satisfaction of every-day wants—should have any bearing on human life was far from the thoughts of men thus trained. Indeed, as nature had been cursed for man's sake, it was an obvious conclusion that those who meddled with nature were likely to come into pretty close contact with Satan. And if any born scientific investigator followed his instincts he might safely reckon upon earning the reputation, and probably upon suffering the fate, of a sorcerer.

Had the western world been left to itself in Chinese isolation, there is no saying how long this state of things might have endured. But, happily, it was not left to itself. Even earlier than the thirteenth century, the development of Moorish civilisation in Spain and the great movement of the Crusades had introduced the leaven which, from that day to this, has never ceased

to work. At first, through the intermediation of Arabic translations, afterwards, by the study of the originals, the western nations of Europe became acquainted with the writings of the ancient philosophers and poets, and, in time, with the whole of the vast literature of antiquity.

Whatever there was of high intellectual aspiration or dominant capacity in Italy, France, Germany, and England, spent itself for centuries in taking possession of the rich inheritance left by the dead civilisations of Greece and Rome. Marvellously aided by the invention of printing, classical learning spread and flourished. Those who possessed it prided themselves on having attained the highest culture then within the reach of mankind.

And justly. For, saving Dante on his solitary pinnacle, there was no figure in modern literature at the time of the Renaissance to compare with the men of antiquity; there was no art to compete with their sculpture; there was no physical science but that which Greece had created. Above all, there was no other example of perfect intellectual freedom—the unhesitating acceptance of reason as the sole guide to truth and arbiter of conduct.

The new learning necessarily soon exerted a profound influence upon education. The language of the monks and schoolmen seemed little better than gibberish to scholars fresh from Virgil and Cicero, and the study of Latin was placed upon a new foundation. Moreover, Latin itself ceased to afford the sole key to knowledge. The student who sought the highest thought of antiquity, found only a second-hand reflection of it in Roman literature, and turned his face to the full light of the Greeks. And after a battle, not altogether dissimilar to that which is at present being fought over the teaching of physical science, the study of Greek was recognised as an essential element of all higher education.

Thus the Humanists, as they were called, won the day; and the great reform which they effected was of incalculable service to mankind. But the Nemesis of all reformers is finality; and the reformers of education, like those of religion, fell into the profound but common error of mistaking the beginning for the end of the work of reformation.

The representatives of the Humanists, in the nineteenth century, take their stand upon classical education as the sole avenue to culture, as firmly as if we were still in the age of Renaissance. Yet surely the present intellectual relations of the modern and the ancient worlds are profoundly different from those which obtained three centuries ago. Leaving aside the existence of a great and characteristically modern literature, of modern painting, and, especially, of modern music, there is one feature of the present state of the civilised world which separates it more widely from the Renaissance, than the Renaissance was separated from the middle ages.

This distinctive character of our own times lies in the vast and constantly increasing part which is played by Natural Knowledge. Not only is our daily life shaped by it, not only does the prosperity of millions of men depend upon it, but our whole theory of life has long been influenced, consciously or unconsciously, by the general conceptions of the universe, which have been forced upon us by physical science.

In fact, the most elementary acquaintance with the results of scientific investigation shows us that they offer a broad and striking contradiction to the opinions so implicitly credited and taught in the middle ages.

The notions of the beginning and the end of the world entertained by our forefathers are no longer credible. It is very certain that the earth is not the chief body in the material universe, and that the world is not subordinated to man's use. It is even more certain that nature is the expression of a definite order with which nothing interferes, and that the chief business of mankind is to learn that order and govern themselves accordingly. Moreover this scientific "criticism of life" presents itself to us with different credentials from any other. It appeals not to authority, nor to what anybody may have thought or said, but to nature. It admits that all our interpretations of natural fact are more or less imperfect and symbolic, and bids the learner seek for truth not among words but among things. It warns us that the assertion which outstrips evidence is not only a blunder but a crime.

The purely classical education advocated by the representatives of the Humanists in our day, gives no inkling of all this. A man may be a better scholar than Erasmus, and know no more of the chief causes of the present intellectual fermentation than Erasmus did. Scholarly and pious persons, worthy of all

respect, favour us with allocutions upon the sadness of the antagonism of Science to their mediæval way of thinking, which betray an ignorance of the first principles of scientific investigation, an incapacity for understanding what a man of science means by veracity, and an unconsciousness of the weight of established scientific truths, which is almost comical.

There is no great force in the *tu quoque* argument, or else the advocates of scientific education might fairly enough retort upon the modern Humanists that they may be learned specialists, but that they possess no such sound foundation for a criticism of life as deserves the name of culture. And, indeed, if we were disposed to be cruel we might urge that the Humanists have brought this reproach upon themselves, not because they are too full of the spirit of the ancient Greek, but because they lack it.

The period of the Renaissance is commonly called that of the "Revival of Letters," as if the influences then brought to bear upon the mind of western Europe had been wholly exhausted in the field of literature. I think it is very commonly forgotten that the revival of science, effected by the same agency, although less conspicuous, was not less momentous.

In fact, the few and scattered students of nature of that day picked up the clue to her secrets exactly as it fell from the hands of the Greeks a thousand years before. The foundations of mathematics were so well laid by them that our children learn their geometry from a book written for the schools of Alexandria two thousand years ago. Modern astronomy is the natural continuation and development of the work of Hipparchus and of Ptolemy; modern physics of that of Democritus and Archimedes; it was long before modern biological science outgrew the knowledge bequeathed to us by Aristotle, Theophrastus, and Galen.

We cannot know all the best thoughts and sayings of the Greeks unless we know what they thought about natural phenomena. We cannot fully apprehend their criticism of life unless we understand the extent to which that criticism was affected by scientific conceptions. We falsely pretend to be the inheritors of their culture, unless we are penetrated, as the best minds among them were, with an unhesitating faith that the free employment of reason, in accordance with scientific method, is the sole guide to truth.

Thus I venture to think that the pretensions of our modern Humanists to the possession of the monopoly of culture and to the exclusive inheritance of the spirit of antiquity must be abated, if not abandoned. But I should be very sorry that anything I have said should be taken to imply a desire on my part to depreciate the value of classical education, as it might be and as it sometimes is. The native capacities of mankind vary no less than their opportunities; and while culture is one, the road by which one man may best reach it is widely different from that which is most advantageous to another. Again, while scientific education is yet inchoate and tentative, classical education is thoroughly well organised upon the practical experience of generations of teachers. So that, given ample time for learning and destination for ordinary life, or for a literary career, I do not think that a young Englishman in search of culture can do better than follow the course usually marked out for him, supplementing its deficiencies by his own efforts.

But for those who mean to make science their serious occupation; or who intend to follow the profession of medicine; or who have to enter early upon the business of life; for all these, in my opinion, classical education is a mistake; and it is for that reason that I am glad to see "mere literary education and instruction" shut out from the curriculum of Sir Josiah Mason's College, seeing that its inclusion would probably lead to the introduction of the ordinary smattering of Latin and Greek.

Nevertheless, I am the last person to question the importance of genuine literary education, or to suppose that intellectual culture can be complete without it. An exclusively scientific training will bring about a mental twist as surely as an exclusively literary training. The value of the cargo does not compensate for a ship's being out of trim; and I should be very sorry to think that the Scientific College would turn out none but lop-sided men.

There is no need however that such a catastrophe should happen. Instruction in English, French, and German is provided, and thus the three greatest literatures of the modern world are made accessible to the student.

French and German, and especially the latter language, are absolutely indispensable to those who desire full knowledge in any department of science. But even supposing that the know-

ledge of these languages acquired is not more than sufficient for purely scientific purposes, every Englishman has, in his native tongue, an almost perfect instrument of literary expression; and, in his own literature, models of every kind of literary excellence. If an Englishman cannot get literary culture out of his Bible, his Shakspeare, his Milton, neither, in my belief, will the profoundest study of Homer and Sophocles, Virgil and Horace, give it to him.

Thus, since the constitution of the College makes sufficient provision for literary as well as for scientific education, and since artistic instruction is also contemplated, it seems to me that a fairly complete culture is offered to all who are willing to take advantage of it.

But I am not sure that at this point the "practical" man, scotched but not slain, may ask what all this talk about culture has to do with an Institution, the object of which is defined to be "to promote the prosperity of the manufactures and the industry of the country." He may suggest that what is wanted for this end is not culture, nor even a purely scientific discipline, but simply a knowledge of applied science.

I often wish that this phrase, "applied science," had never been invented. For it suggests that there is a sort of scientific knowledge of direct practical use, which can be studied apart from another sort of scientific knowledge, which is of no practical utility, and which is termed "pure science." But there is no more complete fallacy than this. What people call applied science is nothing but the application of pure science to particular classes of problems. It consists of deductions from those general principles, established by reasoning and observation, which constitute pure science. No one can safely make these deductions until he has a firm grasp of the principles; and he can obtain that grasp only by personal experience of the processes of observation and of reasoning on which they are founded.

Almost all the processes employed in the arts and manufactures fall within the range either of physics or of chemistry. In order to improve them, one must thoroughly understand them; and no one has a chance of really understanding them who has not obtained that mastery of principles and that habit of dealing with facts which is given by long-continued and well-directed purely scientific training in the physical and the chemical laboratory. So that there really is no question as to the necessity of purely scientific discipline, even if the work of the College were limited by the narrowest interpretation of its stated aims.

And, as to the desirableness of a wider culture than that yielded by science alone, it is to be recollected that the improvement of manufacturing processes is only one of the conditions which contribute to the prosperity of industry. Industry is a means and not an end; and mankind work only to get something which they want. What that something is depends partly on their innate, and partly on their acquired, desires.

If the wealth resulting from prosperous industry is to be spent upon the gratification of unworthy desires; if the increasing perfection of manufacturing processes is to be accompanied by an increasing debasement of those who carry them on, I do not see the good of industry and prosperity.

Now it is perfectly true that men's views of what is desirable depend upon their characters; and that the innate proclivities to which we give that name are not touched by any amount of instruction. But it does not follow that even mere intellectual education may not, to an indefinite extent, modify the practical manifestation of the characters of men in their actions, by supplying them with motives unknown to the ignorant. A pleasure-loving character will have pleasure of some sort; but, if you give him the choice, he may prefer pleasures which do not degrade him to those which do. And this choice is offered to

ranges of self-reproach.

If the Institution opened to-day fulfilled the intention of its founder, the picked intelligences among all classes of the population of this district will pass through it. No child born in Birmingham, henceforward, if he have the capacity to profit by the opportunities offered to him first in the primary and other schools, and afterwards in the Scientific College, need fail to obtain, not merely the instruction, but the culture most appropriate to the conditions of his life.

Within these walls, the future employer and the future artisan may sojourn together for a while, and carry through all their lives the stamp of the influences then brought to bear upon them. Hence, it is not beside the mark to remind you that the prosperity of industry depends not merely upon the improvement of manufacturing processes, not merely upon the ennobling of the individual character, but upon a third condition, namely, a clear understanding of the conditions of social life on the part of both the capitalist and the operative, and their agreement upon common principles of social action. They must learn that social phenomena are as much the expression of natural laws as any others; that no social arrangements can be permanent unless they harmonise with the requirements of social statics and dynamics; and that, in the nature of things, there is an arbiter whose decisions execute themselves.

But this knowledge is only to be obtained by the application of the methods of investigation adopted in physical researches to the investigation of the phenomena of society. Hence, I confess, I should like to see one addition made to the excellent scheme of education propounded for the College, in the shape of provision for the teaching of Sociology. For though we are all agreed that party politics are to have no place in the instruction of the College; yet in this country, practically governed as it is now by universal suffrage, every man who does his duty must exercise political functions. And if the evils which are inseparable from the good of political liberty are to be checked, if the perpetual oscillation of nations between anarchy and despotism is to be replaced by the steady march of self-restraining freedom; it will be because men will gradually bring themselves to deal with political, as they now deal with scientific questions; to be as ashamed of undue haste and partisan prejudice in the one case as in the other; and to believe that the machinery of society is at least as delicate as that of a spinning-jenny, and not more likely to be improved by the meddling of those who have not taken the trouble to master the principles of its action.

In conclusion, I am sure that I make myself the mouthpiece of all present in offering to the venerable Founder of the Institution, which now commences its beneficent career, our congratulations on the completion of his work; and in expressing the conviction, that the remotest posterity will point to it as a crucial instance of the wisdom which natural piety leads all men to ascribe to their ancestors.

#### ON A SEPTUM PERMEABLE TO WATER, AND IMPERMEABLE TO AIR, WITH APPLICATION TO A NAVIGATIONAL DEPTH GAUGE<sup>1</sup>

A SMALL quantity of water in a capillary tube, with both ends in air, acts as a perfectly air-tight plug against difference of pressure of air at its two ends, equal to the hydrostatic pressure corresponding to the height at which water stands in the same capillary tube when it is held upright, with one end under water and the other in air. And if the same capillary tube be held completely under water, it is perfectly permeable to the water, opposing no resistance except that due to viscosity, and permitting a current of water to flow through it with any difference of pressure at its two ends, however small. In passing it may be remarked that the same capillary tube is, when not plugged by liquid, perfectly permeable to air.

A plate of glass, or other solid, capable of being perfectly wet by water, with a hole bored through it, acts similarly in letting air pass freely through it when there is no water in the hole; and letting water pass freely through it when it is held under water; and resisting a difference of air-pressures at the two sides of it when the hole is plugged by water. The difference of air-pressures on the two sides which it resists is equal to the hydrostatic pressure corresponding to the rise of water in a capillary tube of the same diameter as the narrowest part of the hole. Thus a metal plate with a great many fine perforations, like a very fine rose for a watering-can for flowers, fulfils the conditions stated in the title to this communication. So does very fine wire cloth. The finer the holes, the greater is the difference of air-pressures balanced, when they are plugged with water. The shorter the length of each hole the less it resists the passage of water when completely submerged; and the greater the number of holes, the less is the whole resistance to the permeation of water through the membrane.

<sup>1</sup> Paper read at the British Association by Sir William Thomson.



Hence, clearly, the object indicated in the title is more perfectly attained, the thinner the plate and the smaller and more numerous the holes. Very fine wire cloth would answer the purpose better than any metal plate with holes drilled through it; and very fine closely-woven cotton cloth, or cambric, answers better than the finest wire cloth. The impenetrability of wet cloth to air is well known to laundresses, and to every naturalist who has ever chanced to watch their operations. The quality of dry cloth to let air through with considerable freedom, and wet cloth to resist it, is well known to sailors, wet sails being sensibly more effective than dry sails (and particularly so in the case of old sails, and of sails of thin and light material).

An illustration was shown to the meeting by taking an Argand lamp-funnel, with a piece of very fine closely-woven cotton cloth tied over one end of it. When the cloth was dry, and the other end dipped under water, the water rose with perfect freedom inside, showing exceedingly little resistance to the passage of air through the dry cloth. When it was inverted, and the end guarded by the cloth was held under water, the water rose with very great freedom, showing exceedingly little resistance to the permeation of water through the cloth. The cloth being now wet, and the glass once more held with its other end under water, the cloth now seemed perfectly air-tight, even when pressed with air-pressure corresponding to nine inches of water, by forcing down the funnel, which was about nine inches long, till the upper end was nearly submerged. When it was wholly sub-



Water indicated by horizontal shading; Air by white paper.

merged, so that there was air on one side and water on the other, the resistance to permeation of air was as decided as it was when the cloth, very perfectly wet, had air on each side of it.

Once more, putting the cloth end under water; holding the tube nearly horizontal, and blowing by the mouth applied to the other end:—the water which had risen into the funnel before the mouth was applied, was expelled. After that no air escaped until the air-pressure within exceeded the water pressure on the outside of the cloth by the equivalent of a little more than nine inches of water; and when blown with a pressure just a very little more than that which sufficed to produce a bubble from any part of the cloth, bubbles escaped in a copious torrent from the whole area of the cloth.

The accompanying sketch represents the application to the Navigational Depth Gauge. The wider of the two communicating tubes, shown uppermost in the sketch, has its open mouth guarded by very fine cotton cloth tied across it. The tube shown lower in the diagram is closed for the time of use by a stopper at its lower end. A certain quantity of water (which had been forced into it during the descent of the gauge to the bottom of the sea) is retained in it while the gauge is being towed up to the surface in some such oblique position as that shown in the sketch. While this is being done the water in the wide tube is expelled by the expanding air. The object of the cloth guard is to secure that this water is expelled to the last drop before any air escapes; and that afterwards, while the gauge is being towed wildly along the surface from wave to wave by a steamer running at fourteen or sixteen knots, not a drop of water shall re-enter the instrument.

ON THE CLASSIFICATION OF BIRDS<sup>1</sup>

ABOUT twelve years ago Prof. Huxley had taken up the subject of the classification of birds in his usual zealous and original way, and from quite a new point of view. Prof. Huxley, treating birds mainly from their bones and as if they were extinct

<sup>1</sup> Abstract of a paper read at the British Association by P. L. Selator, M.A., I'h.D., F.R.S.

animals of which these parts of their structure only were known, had proposed an entirely new plan of arrangement, based mainly upon the characteristic variations of the palatal bones, which had passed almost unnoticed by previous writers. The author, who had long been dissatisfied with the Cuvierian system, which with certain modifications he had employed up to 1872, had in that year been constrained to consider the whole subject in order to decide what arrangements should be adopted in the "Nomenclator Avium Americanarum" (a joint work by Mr. O. Salom and himself), then ready for publication. Prof. Huxley had commenced his system with the lowest and most reptilian birds, and had ended it with the highest and most specialised. But it seemed to the author that by exactly reversing this arrangement he would obtain a scheme which would not very far deviate from that which he had previously employed for the first three orders, and would offer many improvements on the Cuvierian system in the remaining ones. Such a scheme had accordingly been promulgated in the Introduction to the "Nomenclator" and followed in that work. In the various subsequently issued editions of the "List of Vertebrated Animals in the Zoological Society's Gardens" a nearly similar arrangement had been followed. A certain amount of adhesion having been secured to this system, the author had been recently induced to devote some labour to its improvement and development. As now elaborated it did not profess to be in any respects original, except as regarded certain small details on points to which he had devoted special attention. The arrangement was in fact simply that of Huxley reversed, with slight modifications consequent upon the recent researches of Parker and Garrod on the anatomy and osteology of little known forms.

The author then proceeded to explain further the "Systema Avium" thus advocated, as shown in the subjoined table, in which the approximate number of known species was added after each Order.

ORDERS OF EXISTING BIRDS

SUBCLASS CARINATÆ (10,121 SPECIES)

Species.		Species.	
I. Passeres ...	5,700	XIII. Gallinæ ...	320
II. Picariæ ...	1,600	XIV. Opisthocomi ...	1
III. Psittaci ...	400	XV. Hemipodii ...	24
IV. Striges ...	180	XVI. Fulicariæ ...	150
V. Accipitres ...	330	XVII. Alectorides ...	60
VI. Steganopodes ...	60	XVIII. Limicolæ ...	250
VII. Herodiones ...	130	XIX. Gaviæ ...	130
VIII. Odontoglossæ ...	8	XX. Tubinares ...	100
IX. Palamedææ ...	3	XXI. Pygopodes ...	65
X. Anseres ...	180	XXII. Impennes ...	20
XI. Columbæ ...	355	XXIII. Crypturi ...	40
XII. Pterocletes ...	15		

SUBCLASS RATITÆ (18 SPECIES)

XXIV. Apteryges ...	4	XXVI. Struthionēs ...	4
XXV. Casuarii ...	10		

In submitting this arrangement, as one which on the whole he was disposed to regard as the best to be adopted after many years' study of the Class of Birds, the author observed that it should be recollected that, although a linear system is an absolute necessity for practical use, it could never be a perfectly natural one. It would always be found that certain groups were nearly equally related to others in different places in the linear series, and that it was a matter of difficulty to decide with which of the allied forms they were best located. But, a linear arrangement being an absolute necessity, it became our duty to make it as natural as possible.

THE GREEN COLOUR OF OYSTERS

IN NATURE, vol. xvi. p. 397, mention was made of the fact that the green colour observed in oysters in certain localities is caused by a variety of navicula, to which the name *Navicula ostræaria* has been given. Further particulars of experiments made by M. Puysegur, at Sissable, are not without interest.<sup>1</sup>

"The green slime was collected by lightly scraping the margin of one of the 'clears' with a spoon, and was put in flasks, shaken for a moment and then allowed to settle, so as to get rid of the mud, some admixture of which is inevitable. The coloured fluid, containing little or nothing besides diatoms, was then poured off into other flasks. Care and some little dexterity are requisite, as if there is too much silt or too large a quantity

<sup>1</sup> *Revue maritime et coloniale*, February, 1880.

of water, which is generally the case when the task is intrusted to a subordinate, it is sometimes next to impossible to concentrate the fluid enough to show the results with the desired plainness.

"Returning home, we poured the fluid into soup-plates set on a table before a window. The diatoms speedily settled on the sides and bottoms of the plates, coating them with a green slime, the thickness and tint of which varied with the proportion of diatoms present. In each plate, according to its size, we put three to six perfectly white oysters which had never been in the 'clears,' and the shells of which had previously been washed and brushed clean. In similar plates like numbers of the same oysters were laid in ordinary sea-water. Twenty-six hours after the commencement of the experiment the oysters in the water charged with diatoms had all acquired a marked greenish hue; the other oysters remained unaltered. The experiment was repeated many times with identically the same results. The green colour in the oysters was found to be more decided in proportion as the water was more highly charged with diatoms. In the course of the experiments the shell of one of the oysters was perforated, so as to lay bare the mantle. After the oyster had turned green, it was laid in ordinary sea-water for a few days, when the greenness disappeared altogether. It reappeared when the oyster was replaced in fresh water containing *Navicula ostrearia*. The experiment was repeated, with like results, in the laboratory of M. Decaisne, Jardin des Plantes, Paris, to which a supply of white oysters and sealed flasks of the water containing the diatoms was forwarded.

"In the course of the experiments it was observed that by the opening and closing of their valves the oysters induced currents in the water, by means of which they drew towards them and surrounded themselves with the particles of matter suspended therein. The existence and direction of these currents were shown by the disappearance of the slime and the consequent laying bare of the sides and bottoms of the plates, the diatoms remaining only at points out of reach of the currents.

"Directed towards the buccal aperture by the cilia with which the branchiæ are provided, the naviculæ enter the stomach of the mollusc, and there part with their nutritive constituents. The yellow chlorophyll is digested and decomposed; the soluble colouring matter passes direct into the blood, to which it imparts its colour. Thus it happens that the most vesicular portions of the structure, as the branchiæ, are the most highly coloured.

"Examination of the digestive tubes of the oysters experimented upon proved the fact of the absorption of the diatoms. The stomachs, intestines, and exuviae were strewed with carapaces of naviculæ. The carapaces, being siliceous, are not affected by the digestive juices, and it would seem extraordinary that with so tenacious a covering their contents should be evolved, were it not for the knowledge of the fact that the covering is not continuous, the line of suture separating the valves composing the frustule being scarcely silicified at all."

It would therefore appear to be established beyond dispute that the green hue in oysters is due exclusively to their absorption of certain naviculæ contained in the circumambient water. The facts are in perfect keeping with the observations of growers that heavy rains (which increase the supply of fresh water) cause the disappearance of the green from the "clears," while, on the other hand, dry north-east gales, which greatly increase the saturation of the water, bring it, as it is called, "into condition."

Two points of special interest in connection with the subject remain for future investigation. These are:—

1. Does the navicula in question remain all the year in the waters where it is found in winter?

2. Is the coloration of the beds accidental or temporary?—in other words, does this alga disappear from the reservoirs when the water changes its colour, or does it become itself discoloured for a time?

H. M. C.

### MODERN ENTOMOLOGY<sup>1</sup>

IT is the good fortune of your president on this occasion to welcome you to his native heath, where our favourite science has been longer, more uninterruptedly, and perhaps more zealously cultivated than anywhere else in the New World. Here, in the last century, Peck studied the Canker-worm and the

<sup>1</sup> Annual Address before the Entomological Club of the American Association for the Advancement of Science, by the President, Mr. S. H. Scudder, of Cambridge.

Slug-worm of the Cherry, and in late years *Rhynchonius*, *Stenocorus*, and *Cossus*—all highly destructive insects. Here lived Harris, who cultivated entomology in its broadest sense, and whose classic treatise was the first important Government publication on injurious insects. Here to-day we have two associations for our work, consisting, it will be confessed, of nearly the same individuals, and not many of them, but meeting frequently—one in Boston, the other in Cambridge. Harvard acknowledges the claims of our study in supporting not only an instructor in entomology at its Agricultural School, but a full Professor of the same in the University at large.

In our own day the spreading territory of the United States, the penetration of its wilds, and the intersection of its whole area by routes of travel, the wider distribution and greatly-increased numbers of local entomologists, as well as the demand for our natural products abroad, have set before us temptation to study only new forms and to cultivate descriptive work, to the neglect of the choicer, broader fields of our ever-opening science. It is this danger to which I venture briefly to call your attention to-day, not by way of disparaging the former, but rather in the hope that some of our younger members, who have not yet fallen into the ruts of work, may be induced to turn their attention to some of the more fruitful fields of diligent research.

We should not apply the term descriptive work merely to the study of the external features of insects. The great bulk of what passes for comparative anatomy, physiology, and embryology is purely descriptive, and is only to be awarded a higher grade in a scale of studies than that which deals with the external properties when it requires a better training of the hand and eye to carry it out, and greater patience of investigation. We pass at once to a higher grade of research when we deal with comparisons or processes (which of course involve comparisons). All good descriptive work indeed is also comparative; but at the best it is so only in the narrowest sense, for only intimately allied forms are compared. In descriptive work we deal with simple facts; in comparative work we deal with their collocation. "Facts," said Agassiz one day, "facts are stupid things, until brought in connection with some general law."

It is to this higher plane that concerns itself with general laws that I would urge the young student to bend his steps. The way is hard; but in this lies one of its charms, for labour is its own reward. It is by patient plodding that the goal is reached; every step costs and counts; the ever-broadening field of knowledge exhilarates the spirit and intensifies the ambition; there is no such thing as satiety—study of this sort never palls.

It is hardly necessary to point out that so-called systematic work never reaches this higher grade unless it is monographic; unless it deals in a broad way with the relationship and general affinities of insects. It is not my purpose to call attention here to the needs of science in this department, as they are too patent to escape observation; but if one desires a model upon which to construct such work, one need not look further than the "Revision of the Rhynchophora," by Drs. LeConte and Horn. Rather than linger here we prefer to pass directly to some of the obscurer fields of study.

When we compare the number of insect embryologists in America with that of their European colleagues, the result is somewhat disheartening and discreditable; although perhaps the comparison would be not quite so disproportionate were some of our students to publish their notes. But take all that has been done upon both sides of the water, and what a meagre showing it makes! Of how many families of Coleoptera alone have we the embryonic history of a single species?

In following the post-embryonal history of insects there is work for all. While allied forms have in general a very similar development, there are so many which are unexpectedly found to differ from one another, that every addition to our knowledge of the life histories of insects is a gain, and they are to be praised who give their close attention to this matter. Here is a field any entomologist, even the most unskilled, may cultivate to his own advantage and with the assurance that every new history he works out is a distinct addition to the science. The importance of an accumulation of facts in this field can hardly be over-estimated, and those whose opportunities for field-work are good should especially take this suggestion to heart. Nor, by any means, is the work confined to the mere collection of facts. How to account for this extraordinary diversity of life and habits among insects, and what its meaning may be, is one of the problems of the evolutionist. There are also here some specially curious inquiries, to which Sir John Lubbock and

others have recently called attention, and to which Mr. Riley has contributed by his history of *Epicauta* and other *Meloida*. I refer to the questions connected with so-called hypermetamorphosis in insects. In these cases there are changes of form during the larval period greater than exist between larva and pupa, or even between larva and imago, in some insects. There are also slighter changes than these which very many larvae undergo; indeed it may safely be asserted that the newly-hatched and the mature larvae of all external feeders differ from each other in some important features. The differences are really great (when compared to the differences between genera of the same family at a similar time of life) in all lepidopterous larvae, as well as in all Orthoptera which have come under my notice. No attempt to co-ordinate these differences, or to study their meanings, or to show the nature of their evident relationship to hypermetamorphosis has ever been attempted.

Not less inviting is the boundless region of investigation into the habits of insects and their relation to their environment. The impulse given to these studies by the rise of Darwinism, and the sudden and curious importance they have assumed in later investigations into the origin and kinship of insects, need only to be mentioned to be acknowledged at once by all of you. The variation in coloration and form exhibited by the same insect at different seasons or in different stations, "sports," the phenomena of dimorphism, and that world of differences between the sexes, bearing no direct relation to sexuality; mimicry also, phosphorescence and its relations to life, the odours of insects, the relation of anthophilous insects to the colours and fructification of flowers, the modes of communication between members of communities, the range and action of the senses,<sup>1</sup> language, commensalism—these are simply a few topics selected quite at random from hundreds which might be suggested, in each of which new observations and comparative studies are urgently demanded.

The fundamental principles of the morphology of insects were laid down by Savigny in some memorable memoirs more than sixty years ago; the contributions of no single author since that time have added so much to our knowledge, notwithstanding the aid that embryology has been able to bring. Nevertheless there remain many unsolved problems in insect morphology which by their nature are little likely to receive help from this source. Let me mention three:—

The first concerns the structure of the organs of flight. The very nomenclature of the veins shows the disgraceful condition of our philosophy of these parts; the same terminology is not employed in any two of the larger sub-orders of insects; names without number have been proposed, rarely however by any author with a view to their applicability to any group outside that which formed his special study; and a tabular view which should illustrate them all would be a curious sight. A careful study of the main and subordinate veins, their relations to each other, to the different regions of the wing, to the supporting parts of the thorax and to the alar muscles, should be carried through the entire order of insects; by no means, either, neglecting their development in time, and possibly deriving some assistance in working out homologies by the study of their hypodermic development.

The second concerns the mouth parts. The general homologies of these organs were clearly and accurately enough stated by Savigny, though one may perhaps have a right to consider the last word not yet said when one recalls Saussure's recent claim to have found in *Hemimerus* a second labium. What I refer to, however, is another point: it relates to the appendages of the maxillæ and the labium. Considering the labium as a soldered pair of secondary maxillæ, we have at the most, on either pair of maxillæ, three appendages upon either side. These appendages, as you know, are very variously developed in different sub-orders of insects, or even in the same sub-order; and it has at least not been shown, and I question if it can be done, that the parts bearing similar names in different sub-orders are always homologous organs. Here is a study as broad and perhaps as difficult as the last.

The third is the morphological significance of monstrosities, especially of such as are termed monstrosities by excess. The literature of the subject is very scattered, and the material much more extensive than many of you may think. At present this subject is, so to speak, only one of the curiosities of entomology, but we may be confident that it will one day show important relations to the story of life.

<sup>1</sup> Notice Meyer's beautiful studies on the perception of sound by the mosquito.

After all the labours of Herold, Treviranus, Lyonet, Dufour, and dozens of other such industrious and illustrious workers, is there anything important remaining to be done in the gross anatomy of insects? some of you would perhaps ask. Let the recent work of some of our own number answer, which has shown in the Hemiptera and Lepidoptera the existence of a curious pumping arrangement by which nutritious fluids are forced into the stomach. It is certainly strange that after all that has been said as to the mode in which a butterfly feeds, no one should have dissected a specimen with sufficient care to have seen the pharyngeal sac which Mr. Burgess will soon show us. No! the field is still an open one, as the annual reviews clearly show. The curious results of Flögel's studies of the brain, the oddly-constructed sense-organs found by Graber and Meyer (earlier noticed briefly by Leydig) in the antennæ of Diptera, the important anatomical distinctions discovered by Forel in different groups of ants, the strange modification of the tip of the spiral tongue in *Ophideres*, which Darwin, Brietenbach, and Künckel have discussed, and, above all, the extensive investigations of the nervous system in insects generally which Brandt has recently undertaken, the exquisite memoir of Grenacher on the structure of the compound eye, and the keen researches of Graber in various departments of insect anatomy, show by what has been accomplished how many harvests are still unreaped. The microtome, too, has put a new instrument of precision into the hands of the investigator in the field.

If these few words shall arouse in any one a higher ambition, leading to better work, their aim will have been accomplished.

### SCIENTIFIC SERIALS

*American Naturalist*, August 1880.—D. P. Penhallow, the fabrication of Aino cloth.—H. D. Minot, English birds compared with American.—J. S. Gardner, on the age of the Laramie formation as indicated by its vegetable remains.—J. E. Todd, on the flowering of *Saxifraga sarmantosa*.—Prof. A. N. Prentiss, distribution of obnoxious insects by means of fungoid growths.—Recent literature.—General notes.—Scientific news.

September.—J. Walter Fewkes, the Siphonophores:—No. 1, the anatomy and development of *Agalma*.—Prof. A. N. Prentiss, destruction of obnoxious insects by means of fungoid growths (concluded); the result of these experiments would seem to indicate plainly that yeast cannot be regarded as a reliable remedy against such insects as commonly affect plants cultivated in greenhouses or in windows, but the general question is by no means as yet decided.—O. B. Johnson, birds of the Willamette Valley, Oregon (concluded).—C. O. Whitman, Do flying-fish fly?

*Annalen der Physik und Chemie*, No. 8.—On electric expansion (continued), by G. Quincke.—Clausius' law and the motion of the earth in space, by E. Budde.—On the dependence of the electric conductivity of carbon on the temperature, by W. Siemens.—On the phenomena in Geissler tubes under external action, by E. Reitlinger and A. v. Urbanitzky.—Complete theory of the bifilar-magnetometer and new methods of determining the absolute horizontal intensity of the earth's magnetism, as also the temperature and induction coefficients of magnets, by H. Wild.—On the comparison of the electrodynamic fundamental law with experience, by R. Clausius.—On a direct transformation of the vibrations of radiant heat into electricity, by W. Hankel.—On fluorescence, by E. Lommel.—On the behaviour of different heat rays in the reflection of polarised rays from metals, by H. Knoblauch.—Remark on the heat conductivity of mercury, by H. Herwig.—Remarks on H. Weber's memoir on heat-conduction in liquids, by A. Winkelmann.—On air-resistance, by G. Recknagel.—On the action of hollow, in comparison with that of solid, steel magnets, by W. Holtz.

No. 9.—On the compressibility of gases, by F. Roth.—On the electric conductivity of some salt solutions, by J. H. Long.—New experimental researches on fluorescence, by O. Lubarsch.—On constants of refraction, by L. Lorenz.—Experimental researches on refraction constants, by K. Prytz.—Theory of reflection and refraction at the limit of homogeneous, isotropic, transparent bodies, with generalisation and extension of the foundations of Neumann's method, by M. Réthy.—Thermal theory of development of electricity, by J. L. Hoorweg.—On the behaviour of electricity in gases, and especially in vacuum, by F. Narr.—Defence of the law of corresponding boiling temperatures, by U. Dühring.—Equation of the state of atmospheric

occurred the great famines of 1837-38 in the North-West Provinces, of 1868-69 in Rajputana, and of 1876-77 over nearly the whole of the peninsula of Southern India. These droughts were mainly due to the failure of the south-west monsoon. The drought of 1865-66, and some of the earlier scarcities in Madras, arose from failures of the rain of the north-east monsoon on the east coast, a failure which in 1865-66 extended into Western Bengal. The famine of 1873-74 in Northern Bengal was exceptional, and is an instance of a great scarcity suddenly arising in a region of abundant average rainfall. This drought arose from a premature cessation of the rain, apparently due to an abnormal extension to the eastward of the margin of the comparatively dry area of North-Western India.

The Report touches briefly on a part of the subject which we deem of the greatest importance, namely, the supposed periodicity of fluctuations in the rainfall from year to year. These, the Report states, are in all parts of the country very considerable, variations of as much as 50 per cent. on either side of the average being often registered. The Commission refer to the opinion of those "qualified by their scientific knowledge to judge of such matters that there is evidence of these fluctuations being in some measure synchronous with those periodical variations in the condition of the sun which are indicated by the varying extent or number of sun-spots; and the recurring cycle of about eleven years, with which prolonged observation has shown that the period of sun-spot variation on the average accords, has been thus considered to correspond to the annual variations of the rainfall, the maximum and minimum of the one approximating in period to those of the other."

Of course the Commission, in the present unsettled state of this all-important question do not feel themselves justified in recommending any anticipatory measures to be taken in view of the probable recurrence of famine, on the basis of this theory. The subject, it is admitted, is scarcely advanced enough to warrant such recommendations. What they do recommend, however, demands the serious attention of the Indian Government. They state that the subject "is one deserving of careful investigation, and that it does not seem contrary to reasonable expectation that some relation should be established between the variations of the rainfall from year to year and those of the conditions of the sun's surface, on the heat derived from which, unquestionably, all terrestrial meteorological phenomena closely depend. For various reasons India is a country in which the investigation of this matter may be carried out with especial facilities, and for this reason (though other grounds are not wanting) we would urge that, as the expense of such researches would be small, the measures which have recently been taken by the Government of India to carry them out should be continued, and even extended in the future."

"As at present no power exists of foreseeing the atmospheric changes effective in producing the rainfall, or of determining beforehand its probable amount in any season, such as would admit of timely precautions being taken against impending drought, the necessity becomes the greater for watching with close attention the daily progress of each season as it passes, for ascertaining with

accuracy and promptitude the actual quantity of rain in all parts of the country, and for forming the best and earliest judgment possible from the facts as they occur whether the supply will be sufficient or otherwise. For the present at least, so far as the rainfall directly affects the subject under consideration, these are the only precautions that appear possible. Within the last few years a very satisfactory system of meteorological observations has been established all over British India, and in our opinion it is of primary importance that it shall be maintained in complete efficiency, and shall so far be strengthened and improved as to insure the early and punctual supply of information to the executive governments, and to the officials in all departments concerned with the agriculture of the country or the preparations required to meet famines, as to the actual progress of the periodical seasons of rain in all parts of the provinces for which those governments or officers are respectively responsible. So far as it may become possible, with the advance of knowledge, to form a forecast of the future, such aids should be made use of, though with due caution.

"We are also satisfied of the importance of the diffusion of more sound and accurate knowledge of the causes and mode of occurrence of the periodical rains, on which the well-being of India is so largely dependent, not only among the officers of the Government, but also among all classes of the community. Any measures which the Government may find possible with a view to the publication and diffusion of such knowledge cannot fail to be highly beneficial."

We shall look with interest for the further information on this subject, which is promised in the appendix to the Report. We need not add anything in support of the strong recommendation of the Commission. The Government would certainly not have appointed them at all unless it meant to take action upon their recommendations, and surely no line of inquiry is more promising, or could be fraught with more useful results. If the laws (for there can be no doubt that such exist) which regulate the periodicity of droughts can be clearly ascertained, it would reduce to the limit of simplicity the measure to be adopted either to prevent the occurrence of famines or to be prepared long beforehand to prevent their natural consequences.

Other recommendations of the Commission are quite in keeping with that to which we have just referred. They advocate the introduction of a more scientific method into administration and statistics, the institution of a separate agricultural department, and the need of improved agricultural, vital, and economical statistics.

Besides the map already mentioned, there are others showing the extent and comparative severity of the famines in various districts of India, from the beginning of the century downwards. Altogether the Commission have faced their task in a thoroughly business-like and scientific method; while they have sought information from every quarter likely to yield useful results, they have never lost sight of the object they had in view, and their Report is likely to be of permanent value. We shall look for the further record of their proceedings with the greatest interest.

## GAMGEE'S "PHYSIOLOGICAL CHEMISTRY"

*Physiological Chemistry of the Animal Body.* By Arthur Gamgee, M.D., F.R.S., Brackenbury Professor of Physiology in the Owens College, Manchester. Vol. i. (London: Macmillan and Co., 1880.)

THE title of this book, since it seems to indicate that the work treats of a division or kind of chemistry, suggests the question whether it ought not to have been written (and reviewed) by a chemist rather than by a physiologist. And indeed there was a time when the view that the chemistry of living beings was a kind of chemistry distinct from the ordinary chemistry had some measure of support, and when consequently the phrase physiological chemistry had a very definite meaning. At the present time however all or nearly all are ready to admit that the chemical events which take place in living bodies are in reality of the same kind as and subject to the same chemical laws as those which take place in lifeless things; and hence physiological chemistry has come to mean the same thing as chemical physiology. The study of the chemical phenomena of animals and plants may be undertaken either by the chemist who understands physiology or by the physiologist who knows chemistry. The day must sooner or later come,—may its advent be more speedy than the present outlook promises!—when the chemist will be able, on the strength of his general knowledge, to foretell with sureness and precision the varied chemical events of the animal body; but hitherto and as yet, each chemical twist and turn of the vital machine has to be worried out by direct observation and experiment, so that physiological chemistry really means at present the physiological investigation of the chemical phenomena of living beings, and thus naturally falls into the hands of the physiologist.

For some years past there has been a great want of an adequate English treatise on the subject, a treatise which should deal with the matter much more fully and completely than could possibly be done in the text-books of physiology or chemistry. The preparation of such a treatise, however, is a task of great labour, and Prof. Gamgee assumed a heavy responsibility when he undertook to bring out the work, the first volume of which is now before us. But we believe that we may congratulate him and his readers on the accomplishment, so far, of his task.

The first instalment comprises, besides a preliminary chapter on proteids, an account of the chemistry of blood, pus, lymph, and of the elementary tissues, contractile, nervous, connective, and epithelial. About 200 pages are devoted to blood alone, and these not only contain a full description and discussion of the phenomena of coagulation, of the chemistry of the serum, and of the red corpuscles, both of their stroma and their hæmoglobin, but include a special chapter "on the changes which the blood undergoes in disease," and a section on the "characters presented by the blood of invertebrate animals." Prof. Gamgee's object has been apparently threefold, viz., (1) to give the chemical data as fully and as exactly as possible, with abundant references to original memoirs and other authorities; (2) to explain even in detail the methods by which the data are determined, and in this the reader will have at once his attention

arrested and his progress assisted by the illustrations of apparatus, spectra, &c., the number and excellence of which form a very striking feature of the work, distinguishing it in a most marked manner from its predecessors; and (3) to point out and discuss the physiological bearings of the data expounded. Thus under the heading of "Oxy-hæmoglobin" will be found a description of the various methods of preparation of this substance (some eight special methods being given in detail in small print), followed by an account of its elementary composition, crystalline form, general reactions, and absorption-spectra. The physiological properties of hæmoglobin are in large measure postponed to the chapter on respiration; but the *technique* of spectroscopic examination is fully described, including the method of recording absorption-bands in wave-lengths; and hæmatin, with other derivatives and allies of hæmoglobin, as well as the action of carbonic oxide and other gases, are treated at length. The account of blood ends with a "description of certain methods of research not described in preceding sections," such, for instance, as the determination of the specific gravity of blood, the quantitative estimation of its various constituents, normal and abnormal, the extraction and measurement of the gases of blood, the measurement of the total quantity of blood in the body, &c., &c.

The other parts of the book are written in a similar fashion, and as far as we have at present, from the sections which we have subjected to a more detailed examination, been able to judge, the author has spared no pains to insure accuracy in his facts and statements, as he has certainly shown judgment in his selections, while his descriptions are remarkably clear and easy to understand.

The prominence given to methods, and the richness in illustrations, make the book one of great value to the student. There are books, some of them professedly written for students, which, though of much worth in other respects, are from the student's point of view practically useless: books of which the student's own judgment is that "he cannot find what he wants" in them. We venture to think that it will be the student's own fault if he cannot find what he wants in Prof. Gamgee's work; that is to say, if he wants what he ought to want. If he seeks in it a compendium which will give him just that amount of knowledge which may be required for an examination, so prepared as to be most easily absorbed and retained for the few weeks which precede his ordeal, he will very probably be disappointed. But if he desires to understand the chemistry of the animal body he will find it an admirable guide, and especially a most valuable book of reference. Throughout the whole of physiology, and at least no less in the chemical than in other parts, the value of the data and the trustworthiness of the conclusions founded on them depend very largely on the methods employed; and no student can form an intelligent judgment on the chemical phenomena of the body who has not understood and appreciated the methods by which the various investigations have been carried out. Hence we lay especial stress on this feature of the book before us as most important for the student.

Prof. Gamgee has gone largely into detail and even into controversy; and in this point too we think he is right. The outlines of physiological chemistry are already present in the various text-books of physiology; what

was emphatically wanted was a history and discussion of details to give shape and fulness to the more meagre accounts found elsewhere. Doubtless many will say that the work contains a great deal more than can possibly be wanted by the student of medicine or even of physiology. We will not presume to answer the difficult question, How little physiology a medical student may know without his educational status being considered "mean"; but this we may say, that there is not a page in this work, the study of which will not prove profitable not only to the medical student, but even to the medical practitioner.

We trust that the author will as soon as possible be able to complete a work of which the first part will increase his already high reputation, and certainly must be regarded as a most noteworthy addition to English physiological literature.

M. FOSTER

### PEAT-MOSSES

*The Sphagnaceæ or Peat-Mosses of Europe and North America.* By R. Braithwaite, M.D., F.L.S. (London: David Bogue, 1880.)

THE peat-mosses are a peculiarly interesting group of cryptogamic plants, which has attracted the attention of even ordinary observers from a very early period. No group of plants is more clearly defined in structure, in family likeness, and by the localities in which they are found. The wanderer over our moorlands, the sportsman in pursuit of game, are as familiar as is the botanist with their dense green or ruddy-coloured tufts, now covering over some damp spot or filling up some bog hole with a vast mass of vigorous vegetation. Nor is there wanting to them an economic value, and that of too great an importance to be overlooked by even the most careless, for it is past generations of these bog-mosses which form the vast deposits of peat, for which as an article of fuel no substitute is in many parts of Europe attainable. The name sphagnum was first used, by writers like Theophrastus and Pliny, to indicate some of the spongy lichens, but was restricted to a genus of mosses by Dillenius more than a century and a half ago, "which were like none of the terrestrial mosses, but were produced always in bogs and marshes."

Dr. Braithwaite, in the volume before us, gives a most excellent sketch of the literature of the genus, tracing it from Dillenius, Linneus, Hedwig, to Müller, Wilson, Sullivant, Schimper, Lindberg, and others. For a long time Prof. Schimper's work was the best on the subject, and Dr. Braithwaite mentions it as very complete in its details of structure, both descriptive and pictorial, and as leaving hardly anything to be desired. Of works more especially relating to the development and minute anatomy of the group, allusion is made to the important memoirs of von Mohl, Carl Nageli, Dozy, Hofmeister, Russow, Piré, and Rozé. He then proceeds in a second chapter to some general observations on collecting, preparing, and on the points to be observed in the determination of a species.

In a third chapter the vegetative system of the group is discussed. To our mind this chapter might well have been extended. The details given of the germination of the spores are too few, nor is the following chapter on the reproductive system free from the same defect; and as to the illustration of these two chapters, it will suffice to mention that it is confined to a single plate. As the

charming plates illustrating the descriptive portion of the work are, we trust, likely to serve for more than one edition of it, we would suggest that, in the event of a second edition, some half-dozen supplementary plates might be given, on which would be represented the embryology of the group.

Between fifty and sixty species of Sphagnum are known of which about one-third are tropical. They are most abundant in the north and south temperate zones, in the higher latitudes of which they often cover over a large expanse of surface. Dr. Braithwaite describes twenty species as found in Europe and North America, that is about one-third of all the known species. Of the others seven species are described as from Brazil, seven from Central America, four from Guadeloupe, seven from Australia and New Zealand, four from the Eastern Archipelago, two of these, *S. sericeum*, C. Müll., and *S. Holleanum*, Dozy and Molke, known only in a barren state, but remarkable for having the stem leaves precisely like the branch leaves in form and structure, their hyaline cells being without fibres, but with a single apical pore. The only species from tropical Africa is *S. Africanum* Duby.

Dr. Braithwaite points out that the range of variability in the species is in this group most extensive, so that in their determination one must rely on minute anatomical distinction for their essential characters, as in many cases size, colour, direction of leaves, habit, presence or absence of fibres in the hyaline cells of the stem leaves, will all alike fail. In the separation of the Sphagninæ as a subclass from the Bryinæ or frondose mosses, Dr. Braithwaite follows the earlier views of the illustrious Schimper. He groups the species described in nearly the same manner as Lindberg, adopting his three sections—Eusphagnum, Hemitheca, and Isocladus. The European species are all located in the first section. The descriptive details are very clearly given. The synonymic lists are evidently made out with great care, and the varieties which in many of the species are, as is well known, very marked, are not only described, but in several cases figured. The twenty-eight beautiful coloured plates illustrating the species and varieties are all from drawings by the author, and they contain complete anatomical details of the stem and leaf structures. The work is brought out in a style worthy of the subject, and we trust will find its way not only into the hands of the botanist but, as it well deserves to do, into the possession of all who take an intelligent pleasure in studying our native mosses.

### OUR BOOK SHELF

*Vox Populi: a Sequel to the "Philosophy of Voice."* F. Charles Lunn. (London: W. Reeves, 1880.)

WE are told in the preface that "the present work is a reprint of articles that appeared in the *Orchestra*," and that "now it has been discovered Galen (A.D. 180), 'the father of physicians,' as he is called, advanced the same physical views as those for which I (Mr. Lunn) have contended, my controversial work is ended:—it is scarce worth while to re-write." Was it then worth while to re-print? In the introduction the author tells us that his articles were written "to clear up some ambiguous points in my (Mr. Lunn's) '*Philosophy of Voice*,'" and that "this without the former work is incomplete, as the

without this." Some time ago the present writer honestly endeavoured to understand Mr. Lunn's "Philosophy of Voice," and utterly failed in his attempts. He cannot find any assistance towards understanding it in the present little tract (pp. 88) of loose writing, wonderful reasoning, and jumping exposition. Let us hope that Mr. Lunn's teaching is better than his preaching. His axioms are however rather startling, especially the second (p. 7), "All voices are naturally beautiful. All ugliness in vocal tone is the result of transferred habits acquired by the artificial use of voice in speech." If this use is "artificial," what use is "natural"? But attempts to understand and criticism are all thrown away. Notwithstanding Mr. Lunn's initial confession that he is a mere follower of Galen, he declares in his introduction (p. 1): "It is a *fait accompli*. I have founded a New Profession standing midway between the Musical and the Medical worlds, with Art on its one side, Science on the other; firm and irrefutable." In this state of suspension, like Mahomet's coffin, "midway between" two "worlds," and belonging to neither Science nor Art, which seems fitly to describe the nature of the book, we are content to leave it to the happy conviction of the author that what he says (of course when others can find out what it is) is "firm and irrefutable."

*Practical Plane Geometry and Projection for Science Classes, Schools, and Colleges.* By Henry Angel. Vol. I., Text; Vol. II., Plates, Collins's Advanced Science Series. (London and Glasgow, 1880.)

A VERY practical and useful book by an experienced teacher: it is designed to meet the requirements of students at the Royal School of Mines, at the Royal Military Academy, at Cooper's Hill, and elsewhere, and embraces great part of the two higher stages of the Science and Art Department syllabus. There is no great scope for absolute novelty in such a work, and our author acknowledges his indebtedness to the works of many, if not most, of his well-known predecessors, but the arrangement appears to be judicious, and the constructions good and clearly enunciated. In the Practical Geometry (six chapters) the student is taught the use and construction of scales, of triangles and polygons, and there are numerous problems on areas, on circles in contact, and on other plane curves with their tangents and normals. The orthographical portion treats of the projection of the five regular solids, of other simple solids, of flat and curved surfaces, intersected by cutting planes, and of solids inscribed in, or circumscribed to, the surfaces of other solids; of the interpenetration of solids, of the projection of shadows, on isometric projection, on the solution of the spherical triangle, and on horizontal projection—a very extensive and varied bill of fare. In addition there are numerous questions for practice, many of which are taken from examination papers, and the text is illustrated by several clearly-drawn figures. Part ii. contains eighty-one large-page plates to further illustrate the constructions. The two parts together ought to enable any painstaking student to take a creditable place in his examination and to acquire a solid acquaintance with the subject.

*Teorica delle Forze Newtoniane e sui applicazioni all' Elettrostatica e al Magnetismo del Prof. Enrico Betti.* 365 pp. (Pisa, 1879.)

In the session 1863-64 Prof. Betti delivered at Pisa a course of lectures, subsequently (1865) printed in the *Nuovo Cimento* under the title "La Teorica delle Forze che agiscono secondo la legge di Newton e sua applicazione alla elettricità statica"; the volume before us is what may be looked upon as its greatly enlarged second edition. It consists of an introduction and three chapters. The first chapter, in twenty-three sections, treats of Potential Functions and of Potentials (§ 11 gives Green's

theorem and some others due to Gauss; § 12 Stokes's theorem for transforming a double integral into a simple integral, and the properties of a surface which has on one face a stratum of attracting, and on the opposite face an equal stratum of repulsive matter; the other sections appear to contain nearly all the known properties of these functions). Chapter II., on Electrostatics, in sixteen sections, discusses several cases of electrostatical distribution, the method of images (Sir W. Thomson's theory) and condensers; Chapter III., on Magnetism, is divided into ten sections (on p. 304 Prof. Betti announces the theorem, "Se la superficie di un corpo è semplicemente connessa ed ha un numero finito di poli, questo numero sarà sempre pari," an advance upon Gauss, who has shown that if there be three poles there must also be a fourth).

*Kalkül der Abzählenden Geometrie.* Von Dr. Hermann Schubert. (Leipzig: Teubner, 1879.)

DR. SCHUBERT in this work gives us, in the form of a treatise of 359 pages, the principal results as yet arrived at in the "Numerical Geometry," a branch of mathematics originated by M. Chasles and subsequently studied by Zeuthen, Sturm, Halphen, Klein, and in this country by Dr. Hirst ("On the Correlation of Two Planes," vol. v.; "Correlation in Space," vol. vi.; "Note on the Correlation of Two Planes," vol. viii.; London Math. Soc. *Proceedings*). The book closes with a full historical and bibliographical list in the form of notes to the several chapters.

#### LETTERS TO THE EDITOR

[The Editor does not hold himself responsible for opinions expressed by his correspondents. Neither can he undertake to return, or to correspond with the writers of, rejected manuscripts. No notice is taken of anonymous communications.]

[The Editor urgently requests correspondents to keep their letters as short as possible. The pressure on his space is so great that it is impossible otherwise to ensure the appearance even of communications containing interesting and novel facts.]

#### The Spectrum of Hartwig's Comet

THE spectrum of this comet was examined here on the evening of October 7 with a spectroscope having a single prism of 45°, and was found to consist of three bright bands and a continuous spectrum corresponding to the nucleus. The middle and brightest band was compared with the band at W.L. 5198 in the spectrum of a vacuum tube containing alcohol vapour, and three micrometer measures gave the position of the less refrangible edge of the comet band at W.L. 5184, 5215, and 5204 tenth metres respectively. The breadth of the band was about 40 tenth metres. These measures would indicate that the principal comet-band is coincident with the band at W.L. 5198 of the vacuum-tube spectrum of carbon-compounds, and not with that of the Bunsen-flame at W.L. 5165. The observations however were made under unfavourable circumstances, the comet being low, and involved in haze and cloud. The positions of the other two bands were not determined. W. H. M. CHRISTIE.  
Royal Observatory, Greenwich, October 11

#### Wire Torsion

I HOPE you will allow me to seek information, through your aid, on a subject which is perplexing me a good deal at present. I am engaged in studying a gravimeter designed by the late J. Allan Broun, in which gravity is balanced by the torsion of a single wire; or is intended to be so. As the function of the instrument depends largely on the law of torsion in wires, I have been making experiments to satisfy myself on some points. It is in the results of one of these that I have met with my difficulty. I was using thin brass wire (diam. '08), and after stretching it till it broke, twice, I supposed it to be at or near its maximum elasticity, and proceeded to use it in the intended way. At each end of a 6-foot plank I inserted into the edge a 2-inch screw. The wire was fastened upon these so as to get a strain by turning them. The wire was in two pieces, attached to opposite sides of a ring in the middle. By turning this ring the two wires were

severally twisted in opposite directions. A straight thick wire passed through the ring, the weight of which afforded a ready means of varying the force necessary to balance the torsion of the wire. My first object was to prove that the force of the latter was, at any rate to some considerable extent, independent of the tension. Suppose that with this arrangement, the wire being horizontal, a balance has been effected when the ring has been turned about the wire as an axis three or four times. What will happen when the wire is further strained? I think it would be a natural expectation (apart from special knowledge) that the weight will rise; on the other hand, a knowledge of the law of torsion teaches (?) that there is no increase of the force sustaining the weight, which therefore will not rise. But who would suppose that, on the contrary, it would sink? Such, nevertheless, is what takes place. I continued increasing the strain, and the weight continued to sink. I had to go on lessening the weight again and again (by shifting the balancing cross-rod), in order to restore the horizontality of the ring; until at last there was scarcely any force of torsion left! To repeat the experiment of course the ring had to receive three or four fresh turns. I did so several times, always continuing, as I thought, to increase the strain. All the time the wire was absorbing the torsion, and did not break. I then thought to try the effect of a high initial torsion. But I did not seem to get any such by turning the ring more than five or six times. I then thought to see how much twisting the wire would bear. Expecting it every instant to break, I counted up to 100 half turns. *By this time the wire was quite slack!* I added another hundred half turns. The wire was now half an inch longer, without any strain having been kept on it except just enough to keep it straight. I went on twisting. At 218 one wire broke. The other then had only sixteen half-turns of twist in it, out of the 230 or more received. I afterwards went on twisting, mending each time that the wire broke, till the twist (quite visible under the microscope) amounted to sixteen turns per inch. The length kept on increasing. After breaking, the wire always untwisted one turn in four inches.

I feel myself here in presence of laws of which I know nothing; and my object in writing this short experience is to ascertain whether it is sufficiently in accord with what is known to cause no surprise to any one but myself. In that case I shall be greatly obliged to any one who will tell me where I can learn all about it.

J. HERSCHEL

Collingwood, October 4

I forgot to say that in no case did slackening of the strain reverse the sinking of the weight due to increase of strain.

### The Magnetic Storm

By the mail just arrived from Australia I have received copies of the photographic traces produced by the declination magnetograph at the Melbourne Observatory during the magnetic storm of August 12 to 14, kindly forwarded by Mr. Ellery, the Government astronomer there.

A comparison of these curves with those from the Kew instrument for the same period shows that the disturbance commenced and ended at both places at the same time.

It is not easy however to trace much similarity in the two sets of curves, as the individual excursions of the magnet east and west of the normal position which form the record of the magnetic storm, cannot be at all times followed in both curves, but the periods of greater disturbance seem to have been simultaneous. For example, the commencement of the disturbance was well marked at August 11d. 8h. 10m. p.m. at Melbourne, which corresponds to 11d. 10h. 33m. a.m. G.M.T., whilst here (vide Mr. Ellis's letter in NATURE, vol. xxii, p. 361) it commenced at 10h. 30m. a.m.; then again the large deviation to the eastward noted in the Rev. S. J. Perry's letter in NATURE, which occurred here between 12d. 11h. 30m. a.m. and 12h. 30m. p.m., seems to have had its effect, as a movement of the needle at Melbourne to the westward between 12d. 9h. 15m. p.m. and 10h. 30m. p.m. The maximum deflection which exceeded the limits of registration of the instrument, I estimate to have taken place at 10 p.m. The corresponding G.M. times for the above are 12d. 11h. 38m. a.m., 12h. 53m. p.m., and 12h. 23m. p.m.; the maximum deflection recorded here seems to have been at 12h. 25m. p.m.

The disturbed period may be considered to have died out at Kew at 14d. 8h. a.m. G.M.T., and at Melbourne at about

14d. 7h. a.m., but there is no very distinctive movement which would enable us to fix this limit with accuracy.

These interesting comparisons are extremely satisfactory, for it is but recently that the Government of Victoria was considering the advisability of discontinuing the system of photographic registration of the magnetometers at Melbourne, and consulted the Kew Committee upon the subject.

A circular was accordingly issued to the leading physicists of Europe, and their replies being almost unanimously in favour of the continuance of the recording system, the Government erected a new magnetic observatory, and decided upon carrying on the work.

Mr. Ellery has also forwarded a month's curves for the purpose of assisting in the international comparison of magnetograms now being prosecuted by the Kew Committee.

The preliminary results of their investigations have been already indicated by Prof. Adams in his recent speech at Swansea (NATURE, vol. xxii, p. 416). G. M. WHIPPLE  
Kew Observatory, October 2

### Coral Reefs and Islands

I HAVE been greatly interested in Mr. John Murray's paper on coral reefs and islands published in NATURE, vol. xxii, p. 351. I hope you will allow me space to draw scientific attention to the fact that as early as 1857 I published a paper on the Formation of the Peninsula and Keys of Florida (*Am. Jour.* vol. xxxiii, p. 46), in which I maintain that the theory of Darwin, although so beautifully (as I thought) explaining the phenomena of the Pacific reefs, *wholly fails to explain those of the Florida coast.*

In 1851 I spent the months of January and February on the Keys of Florida, assisting Prof. Louis Agassiz in his investigations on the growth of reefs and formation of keys in this region. An abstract of these investigations and their results was published in the Report of the United States Coast Survey for 1851, p. 145 *et seq.*<sup>1</sup>

In this report Agassiz shows that the Keys and nearly the whole Peninsula of Florida have been formed by the growth of successive reefs, one beyond the other from north toward the south. In my paper above alluded to, and also in my "Element of Geology," p. 152, I state further, that the reefs of Florida, if we accept Darwin's theory, are entirely peculiar. For according to Darwin barrier-reefs are formed *only by subsidence*, while on the Florida coast we have well-marked barriers with channels 10-40 metres wide where there cannot be any subsidence, for continuous increase of land is inconsistent with subsidence. Again, according to Darwin barriers and atolls always show a *loss of land*, only a small portion of which is recovered by coral and wave agency; while on the Florida coast, on the contrary there has been a continuous growth of the Peninsula by coral accretion, until a very large area, viz., about 20,000 square miles has been added.

I have attributed the formation of *successive* reefs from north toward the south to the successive formation of the depth-condition necessary for coral growth; and this latter, in the absence of any evidence of elevation, to the steady building up by sedimentary deposit, and extension southward, of a submarine bank within the deep curve of the Gulf Stream. The formation of barriers instead of fringes on a coast which has certainly not subsided—for continuous land-growth negatives the idea of subsidence—I attribute to the shallowness and muddiness of the bottom along this coast. Only at a distance of twenty to forty miles, where the depth of twenty fathoms is reached, and where therefore, the bottom is no longer chafed by the waves, the conditions necessary for coral growth would be found, and here a line of reefs would be formed, limited on one side by the depth and on the other by the muddiness of the water.

In brief then, according to my view, the Peninsula and Key of Florida were formed by the co-operation of several agents—1. The Gulf Stream building up and extending a submarine bank within its loop. 2. Corals building successive barriers on the bank as the latter was pushed farther and farther southward. 3. Waves beating the reefs into lines of islands. 4. Debris from the reefs and keys on the one side and the already formed main land on the other filling up the successive channels and converting them first into swamps and finally into dry land.

Whether this view is true in all its parts or not, there can be

<sup>1</sup> This report has been recently published in full as one of the memoirs of the Harvard Museum of Comparative Anatomy, but I have not yet seen it.



no doubt that the southern coast of Florida affords exceptional advantages for the successful study of the formation of coral reefs.

JOSEPH LECONTE

Berkeley, California, September 18.

### Geological Climates

THE dilemma into which Dr. Houghton thrusts the rigid uniformitarian school is one which was enlarged upon some years since, when reef-building corals were asserted, upon the evidence afforded by fossils, to have existed during the Miocene and Oligocene ages in seas where Tasmania now exists in the south and Hampshire in the north. There are no instances of large masses of reef-building corals in corresponding latitudes at the present day, and the range of these surface-living, high-temperature-requiring zoophytes is well known.

Uniformitarians may take comfort, however, and slip under the horns which Dr. Houghton so ably presents for their transfixment. Where I now write, on the Bagshot sands and gravels of Cooper's Hill, facing the cold north with a touch of the east, there is a patch of bamboo canes in full leaf. They were in full leaf at this time last year. The plant survived out of doors the extreme frost and fogs of last winter and other evidences of a temperate climate, and it has been in beautiful leaf all this summer.

Now everybody knows that in torrid India the bamboo grows. Therefore if the paleontologist of the year A.D. 18800 should dig up the Cooper's Hill stalks and leaves, and should have the opportunity of examining in some future Kew the bamboos of the hot parts of the earth, he would logically, geologically, palæontologically, but somehow unreasonably, come to the conclusion that Cooper's Hill and India enjoyed corresponding and intensely tropical climates in 1880, during the geological age when the earth's polar axis was certainly inclined nearly 23° to the plane of the ecliptic.

P. MARTIN DUNCAN

Royal Engineering College, Cooper's Hill, Staines, October 9

### The Yang-tse, the Yellow River, and the Pei-ho

I HAVE been much interested in the paper on the above rivers, published in NATURE, vol. xxii, p. 486. To the extent of the writer's personal observations the calculations appear to have been careful and accurate, and as near the truth as the observations of a single year are likely to be. A reference to Sir Charles Hartley's observations of the Danube, extending over ten years, shows that the mean maximum discharge of that river for one year exceeded the minimum by 3 to 1.

It is however to the use of *one* observation of the Yellow River made in 1792 by Sir Geo. Staunton that I feel compelled to enter a protest, firstly, because *one* observation is misleading in drawing general inferences, and, secondly, is especially to be suspected when it is at variance with other well-authenticated examples.

According to the writer of the paper, the mean discharge of the Yang-tse is 770,397 cubic feet per second, carrying to the sea 6,428,800,000 cubic feet of sediment per year, but the Yellow River having only a mean discharge of 116,000 cubic feet per second delivers, according to Sir George Staunton, 17,520,000,000 cubic feet of sediment per year into the Gulf of Pe-Chili. With Dominic Sampson we may well exclaim "prodigious!" It has struck me as an explanation of this anomaly that Sir George Staunton probably measured the deposit from "the gallon and three-quarters" of the Yellow River water as *wet mud*.

If so this will at once account for the excessive amount of it. The deposit of Nile mud in the reservoirs of the Cairo water-works often amounts to 1 inch in 10 feet of water,<sup>1</sup> or  $\frac{1}{10}$  part of the bulk. Dr. Letehey's analyses show that in August the proportion by weight of sediment (dried) being the maximum of the year, in Nile water is  $\frac{1}{10}$ : thus taking the specific gravity of the dry mud at 1.9, the measurement of the wet deposit by bulk exceeds the dry about 10½ times.

If the 80 grains to the pint of the Yellow River water be divided by 10½, we arrive at between 7 and 8 grains per pint of dry sediment, corresponding closely with the proportion given by the writer for the Pei-ho and Yang-tse.

I would also point out that the discharge of the River Plate as given in the table is not the *mass*, which has not yet been

<sup>1</sup> "Mediterranean Deltas." *Edin. Review*, January, 1877.

<sup>2</sup> "Egyptian Irrigation." Second Report, January, 1876. By John Fowler, engineer to the Khedive.

ascertained, but the *dry weather flow*.<sup>1</sup> Still another little error, for which the writer is in no way responsible, being a quotation from Huxley's "Physiography." The discharge of sediment by the Thames is a calculation by Prof. Geikie on an *hypothesis*, not on observation; and instead of 1,865,000 should be 18,650,000—this printer's error has been copied from Geikie's original paper by writer after writer without discovery.

I should feel obliged if the writer would explain why the surface-current of the Yang-tse and Pei-ho should vary so in velocity with the same average depth of water. It seems anomalous.

T. MELLARD READE

Blundellsands, Liverpool

### Miller's Elements of Chemistry—Part III. Organic Chemistry

IN his notice of the new edition of this work, by Mr. Groves and myself, which appears in NATURE, vol. xxii, p. 530, Mr. Muir refers to an obvious omission at p. 933. May I request those who possess the book to insert at the top of the page the words "Probably, however, the most weighty objection that can be raised to the" . . . Although in the revise, by some strange mischance this line has been dropped in printing off.

HENRY E. ARMSTRONG

### Swiss Châlets

IDENTICAL suggestions to those of Mr. George Henslow with regard to the connection in descent of modern Swiss chalet- and ancient pile lake-dwellings will be found expressed in Dr. J. J. Wild's "At Anchor" (Marcus Ward and Co.), p. 106, and with some detail in my "Notes by a Naturalist on the Challenger" (Macmillan and Co.), p. 399. Dr. Wild, who is a native of Switzerland, and I arrived at the same conclusions independently, as we only found out on reading one another's books, from the study of the modern pile dwellings of the Malay Archipelago during the voyage of the *Challenger*, and we both amongst other conclusions identified the balcony of the chalet with the ancient platform, as does Mr. Henslow.

H. N. MOSELEY

New University Club, St. James's Street, S.W.

### Spectre of the Brocken at Home

HAVING occasion ten days ago to go into my garden about half past ten o'clock at night I found there was a thick white fog, through which, however, a star could be seen here and there. I had an ordinary bedroom candlestick in my hand with the candle lighted, in order to find the object I wanted. To my great surprise I found that the lighted candle projected a fantastic image of myself on the fog, the shadow being about twelve feet high, and of an oddly distorted character, just as the spectre of the Brocken is said to be. It is of course usual on going into the open air to use a lantern with a solid back for any light that may be wanted, and with this, of course, such a shadow would not be seen; but in this charmingly foggy valley of the Thames, and in these days of "Physics without Apparatus," the effect I saw can probably be seen only too often. May not the gigantic spirits of the Ossianic heroes, whose form is composed of mist, through which the stars can be seen, be derived from the fantastic images thrown upon the mountain fogs from the camp fires of the ancient Gaels? In a land where mists abound a superstitious people might very readily come to consider a mocking cloud-spectre to be supernatural, though it was really their own image magnified. If it be true that in our earlier stages of development we resemble more nearly the past forms of life and thought, I may mention in this connection that, thinking to amuse a little child of three, I threw a magnified shadow of her on the wall with a candle, and then, by moving it in the usual way, made the figure suddenly small. Instead of the changing shadow giving the pleasure intended, the child was terrified, as the warriors of Morven may have been when they saw their shadows on the clouds.

J. INNES ROGERS

Fatney, October 8

### Ice under Pressure

THERE is a point in Dr. Carnelley's letter (NATURE, vol. xxii, p. 435) which I have been hoping to see cleared up by subsequent letters. He says, "In order to convert a solid into a

<sup>1</sup> Report by James Eateman, C.E.

liquid the *pressure* must be *above* a certain point," and goes on to describe some experiments with ice, implying that ice is in this respect a typical substance. Now our text-books speak of the behaviour of water in freezing and melting as exceptional. For instance, Prof. Balfour Stewart says ("Heat," p. 89): "If a substance expands in congelation, its melting-point is lowered by pressure, but if a substance contracts in congelation, its melting-point is raised by pressure." And (p. 91): "Bunsen found that the melting-points of paraffin and spermaceti, both of which contract when freezing, were raised by the application of pressure."

Do the new results tend to overthrow the generally received opinions on the subject? or is there some way of reconciling these seeming contradictions?

I have more interest in these matters than knowledge of them, and must apologise if I am asking a question which I ought to have been able to answer. C. A. M.

October 2

#### Mr. Haddon's Marine-Zoology Class

OWING to misconceptions which have arisen from the notice in NATURE, vol. xxii. p. 517, relative to my marine-zoology class, I should like to state that this class was formed solely for the purpose of the practical study of marine zoology, and without any idea of founding a zoological station. I would also like to take this opportunity of acknowledging my great indebtedness to Prof. Dohrn's magnificent institution at Naples.

Zoological Museum, Cambridge ALFRED C. HADDON

#### Landslips

I READ with great interest the article on landslips in NATURE, vol. xxii. p. 505. It is no doubt familiar to many that the salt districts of Cheshire, in the neighbourhoods of Northwich and Winsford, are subject to landslips of a peculiar kind. The beds of rock salt occupying the position of the Triassic salt lakes are the centre of an extensive underground drainage. The fresh water on reaching the salt proceeds to dissolve it and becomes brine. This brine is pumped up and manufactured into white salt. As the fresh water keeps constantly dissolving and eating away the solid salt, the superincumbent earths keep sinking, and on the surface deep furrows, like the dried beds of rivers, mark the course of the underground waters. At times enormous masses of earth sink bodily, leaving cavities of a funnel shape. A short time since a mass of at least 60,000 tons of earth suddenly disappeared. When these subsidences are near rivers they become filled with water, and large lakes over 100 acres in extent have been formed. Although houses are not overwhelmed they are very frequently destroyed, and this destruction of property is so serious that the sufferers are now about to appeal to Parliament for assistance.

The district of the salt manufacture presents phenomena both curious and interesting, and is well worth visiting. A fortnight ago the whole of the water in one of these subsidences of over five acres in extent disappeared, leaving a chasm or abyss in many places forty or fifty feet deep. The action of water on soluble rocks can be seen here in great perfection.

Brookfield House, Northwich THOS. WARD

#### LIQUEFACTION OF OZONE

AT a recent meeting of the French Academy, MM. Hautefeuille and Chappuis announced that they had liquefied ozone. These chemists have been able to ozonise oxygen to a greater extent than has hitherto been done, by passing the silent discharge through the oxygen at a low temperature. The tube containing oxygen was immersed in liquid methylic chloride, which boils at  $-23^{\circ}$ . After being submitted to the electric discharge for fifteen minutes at this temperature, the oxygen was conducted into the capillary tube of a Cailliet's apparatus, the temperature of which was maintained at  $-23^{\circ}$ .

After a few strokes of the pump the gas in the tube appeared azure blue; as pressure increased the depth of colour likewise increased, until under a pressure of several

atmospheres the ozonised oxygen appeared dark indigo blue. The pressure was increased to ninety-five atmospheres, and was then suddenly removed, whereupon a mist, indicating liquefaction, appeared in the capillary tube.

The stability of a mixture of oxygen and ozone rich in ozone appears to be chiefly dependent on the temperature. If such a mixture be rapidly compressed at ordinary temperatures, a considerable amount of heat is evolved and the gas explodes.

Ozone, say MM. Hautefeuille and Chappuis, is therefore to be placed in the category of explosive gases.

Berthelot has shown that the transformation of oxygen into ozone is attended with absorption of heat: the stability of products of endothermic reactions is as a rule increased by decreasing temperature.

Ozone is much more easily liquefied than oxygen; the latter must be compressed under 300 atmospheres at about the temperature of  $-29^{\circ}$  before sudden removal of pressure succeeds in producing liquefaction.

We have thus the existence through a large range of temperature and pressure of two allotropic forms of the same element; each with distinctly marked chemical and physical properties. We know that the molecule of oxygen has a simpler structure than that of ozone; the substance of simpler molecular structure is capable of existing through a much more extended range of temperature and pressure than that of more complex structure. Under special physical conditions it seems possible that new allotropic modifications of various elements might be produced.

The marked differences in colour, and in temperature of liquefaction, between oxygen and ozone, furnish another illustration of the close connection which exists between the "chemical structure" and physical properties of substances; a different "linking," even of similar atoms, being evidently associated with distinctly different physical properties.

MM. Hautefeuille and Chappuis will doubtless soon be able to furnish more details of the properties of this most interesting substance, liquid ozone. M. M. P. M.

#### THE UNIVERSITY OF NEW ZEALAND

THE University of New Zealand, with which, since 1874, the University of Otago has been affiliated, has, we are glad to find, adopted a quite modern schedule of subjects for its degree of B.A.

The subjects of examination for the B.A. degree are:—  
1. Greek Language and Literature. 2. Latin Language and Literature. 3. English Language and Literature. 4. Modern Languages and Literature. 5. General History and Political Economy. 6. Jurisprudence and Constitutional History. 7. Mathematics. 8. Physical Science, any two of the following branches: (a) Sound and Light; (b) Heat and Radiant Heat, (c) Electricity and Magnetism, (d) Astronomy and Meteorology. 9. Chemistry. 10. Natural Science, any one of the following branches: (a) Geology and Mineralogy, (b) Zoology, (c) Anatomy and Physiology, (d) Botany. 11. Mental Science. No candidate shall be approved by the examiners unless he show a competent knowledge of at least five of the above subjects of examination, of which two must be Latin and Mathematics. The examination may be passed in two sections. Either two or three subjects of examination, one of which must be either Latin or mathematics, shall constitute the first section, which may be taken at the end of the second or any subsequent year, and the remaining subjects shall constitute the second section, which may be taken at the end of the third or any subsequent year; or, at the option of the candidate, all the subjects may be taken together at the end of the third or any subsequent year.

In this curriculum the physical and natural sciences

seem to have a fair share allotted to them, and the same is also the case in the courses for the senior scholarships and honours—which latter cannot be competed for until the end of one year after the candidate takes his B.A. degree. A Bachelor of Arts obtaining honours can have his M.A. degree without special examination; all others have to pass an M.A. examination.

It is probable that for some time to come there will be great differences of opinion as to how the natural sciences should be taught and examined in our universities. Some incline to limit the courses in botany and zoology, and to require a good sound knowledge of the prescribed work; others imagine that the effect of limiting a course is to produce a specialist, which, they argue, is to spoil a student; but the mean appears to us to be not so hard to find. A sound general knowledge of development and of physiology might certainly be demanded of all students, and the field of biology being too large for any human being to work over, the student might, as to details of structure, &c., be limited to the study of some defined class. It is in this direction evidently that Prof. Hutton has framed the schedule of zoology and botany, a schedule which, while we acknowledge it to be excellent from a general point of view, is, we are firmly persuaded, longer and more profound than is expedient in a new country, where the teaching power is not great. We are fully aware that there is a tendency in classical and mathematical teachers to believe that the study of natural science is something quite easy; but those able to judge have long agreed that not only does this study call for all the best talents, but that the student too often approaches it long after the impressionable period of his life: a little Latin, perhaps less Greek, a schoolboy knows; arithmetic, algebra, and geometry he is fairly familiar with; but the natural sciences and the how he lives, moves, and has his being, of these he is fain to exclaim, But who are ye? The professors of natural science must bide their time; it is no doubt coming, for biology is now somewhat taught in our schools, and may be will be taught on the mother's knee; but in the meanwhile let them not exact too much from candidates for B.A. degrees or honours; let them progress surely, even though they be accused of progressing slowly. As to the New Zealand University, we shall follow its progress with pleasure, and trust it may soon fulfil the great expectations that we have of it.

#### DOCTORED WINES

THE French Government have just passed a most salutary measure, which will have for effect the diminution, if not the complete suppression, of the process known as *plâtrage*, now become an almost constant custom through most of the wine districts of France, and which, from having at first been performed on a very moderate scale, has lately enormously increased, till it has developed into a crying abuse. The *plâtrage* is carried on during the fermentation, and consists in merely sprinkling the grapes, as successive baskets of them are emptied into the fermentation vats, with plaster of Paris—calcium sulphate—(French *plâtre*), mineralogically known as gypsum, or selenite, in fine powder. Now the grape-juice contains several salts of potash, among which the most abundant are the tartrate and bi-tartrate, and these decompose when placed in contact with the calcium sulphate, forming calcium tartrate—an insoluble salt—and potassium sulphate.

In the case of potassium bi-tartrate, potassium bi-sulphate is formed. Now besides the salts of potash above named, the juice of the grape contains grape-sugar, a nitrogenous fermenting principle and an astringent principle—to which latter new red wines owe much of their harshness—and also a red colouring-matter, with which the astringent principle is intimately associated. The fermentation splits up the grape-sugar, as it is well

known, into carbonic acid, which escapes with effervescence, and alcohol, which remains dissolved. In pure undoctored wines, in proportion to the development of alcoholic strength, and as the wine by age tends to become more acid, potassium bi-tartrate separates as a crystalline precipitate, forming the chief constituent of the deposit in the casks known as *lees*, or, when it forms in bottled wines, as the *crust*.

Now the astringent principle which in the red grape is, as we have explained, intimately combined with the colouring-matter, seems to be held more or less in solution by the tartrates, and as these subside with age the wine grows less harsh, losing at the same time much of its colour, and is said to ripen or grow mellow. As the astringent principle however disappears, the wine, if it be one of the weaker French wines, tends to run to the acetous fermentation, and this is why we frequently find a wine become sour and unpalatable shortly after it has mellowed with age and arrived at its maximum of perfection. Many a bin of valuable claret or Burgundy has thus suddenly surprised and disappointed its possessor, changing in the short space of a few months from fine mellow wine to undrinkable vinegar.

Now, as stated above, calcium sulphate (*plâtre*) decomposes the potassium tartrates, and by withdrawing them and substituting the potassium sulphate, tends to prevent much of the colouring and astringent matter from passing into solution, so that this so-called *plâtrage* is nothing more than a means employed by the Bordelais and Burgundians for giving to their wines a fictitious effect of age, and they naturally defend a practice which enables them to bring their wines sooner into the market, economising their outlay in casks, and diminishing the chances of loss entailed by keeping a large stock of wine on hand. Further the process lends itself to fraud, permitting the wine merchants of Bordeaux and Burgundy to import the strong harsh wines of the north of Spain and the south-east of France, which, when blended with the small, poorer wines of the hill-districts of their own country, and then being *plâtrés* (that is agitated with powdered calcium sulphate), become mild and palatable. Thousands of hogsheads of wines thus blended and doctored are annually sold, and too often at the high rates commanded by pure vintage wines. Under the provisions of the new act no wine is allowed to be brought into commerce if it contains over two grammes of potassium sulphate per litre. Even this proportion is too large, *plâtrage* should be entirely prohibited; but when we consider that wines are now often sold with five or six grammes of this salt to the litre, it was time indeed that some measures should be taken. The merchants defend themselves on the basis of the practice being innocuous, and that while it promotes the keeping qualities of the wine, even four grammes of potassium sulphate could do no harm. It is the greatest possible mistake to fancy that *plâtrage* makes wine keep; for, no the contrary, it withdraws from it the astringent principle, a most potent means of its preservation. For a Bordeaux merchant to contend that forty grains of potassium sulphate to the pint of wine is not or cannot be unwholesome, is a thesis which may be agreeable to his pocket, but certainly ought to be discouraged, for, to say the least, it would surely be prejudicial to the stomachs of delicate or dyspeptic consumers. Not very many years since a case occurred of actual death by poisoning from the administration of a comparatively small dose of potassium sulphate, and this salt is well known in medicine as a drastic and dangerous purgative. We should then be most sincerely grateful to the French Minister of Commerce for the prudent forethought with which he has protected the consumers of French wines from a practice which had grown into a crying abuse, and for giving us one more guarantee for the purity of these wines, justly ranked as the most esteemed that the world produces.

MULTIPLE SPECTRA<sup>1</sup>

## III.

I HAVE endeavoured to show in the previous articles that there are many facts which justify the conclusion that the same elementary substance in a state of purity can under different conditions give us spectra different in kind. To those spectra to which special reference is now made the names of *lined* and *fluted* have been given to mark their chief point of difference, which is that in lined spectra we deal with lines distributed irregularly over the spectrum; while in fluted spectra we deal with rhythmical systems.

This was the first point, and I showed that the idea was suggested that the lined and fluted spectra, though produced by the same substance, were produced by that substance in a different molecular condition.

I have pointed out that both in lined and fluted spectra taken separately there was evidence of still further complication, that is, that a complete lined spectrum of a substance and a complete fluted spectrum of a substance, was the result of the vibration not of one kind of molecule only, but probably of several.

So that in this view we have to imagine a series, in some cases a long series, of molecular simplifications brought about by the action of heat, and ascribe the spectral changes to these simplifications.

To understand my contention, and one objection which has been taken to it, in the clearest way, let us suppose that there is a substance which gives us, under different conditions, three spectra, which we will term *a*, *b*, and *c*. My view is that these spectra are produced by three distinct molecular groupings brought about by successive dissociations. On the other hand, it is objected that they are produced by *one and the same molecule* struck, as a bell might be struck, *in different ways* by the heat waves or the electric current passing among the molecules.

In my memoir entitled "Discussion of the Working Hypothesis that the so-called Elements are Compound Bodies," I remarked as follows:—

"I was careful at the very commencement of this paper to point out that the conclusions I have advanced are based upon the analogies furnished by those bodies which, by common consent and beyond cavil and discussion, are compound bodies. Indeed, had I not been careful to urge this point, the remark might have been made that the various changes in the spectra to which I shall draw attention are not the results of successive dissociations, but are effects due to putting the same mass into different kinds of vibration or of producing the vibration in different ways. Thus the many high notes, both true and false, which can be produced out of a bell with or without its fundamental one, might have been put forward as analogous with those spectral lines which are produced at different degrees of temperature with or without the line, due to each substance when vibrating visibly with the lowest temperature. To this argument, however, if it were brought forward, the reply would be that it proves too much. If it demonstrates that the *h* hydrogen line in the sun is produced by the same molecular grouping of hydrogen as that which gives us two green lines only when the weakest possible spark is taken in hydrogen inclosed in a large glass globe, it also proves that calcium is identical with its salts. For we can get the spectrum of any of the salts alone without its common base, calcium, as we can get the green lines of hydrogen without the red one.

"I submit, therefore, that the argument founded on the over-notes of a sounding body, such as a bell, cannot be urged by any one who believes in the existence of any compound bodies at all, because there is no spectroscopic break between acknowledged compounds and the supposed elementary bodies. The spectroscopic differences

between calcium itself at different temperatures is, as I shall show, as great as when we pass from known compounds of calcium to calcium itself. There is a perfect continuity of phenomena from one end of the scale of temperature to the other."

Not only is what may be termed the bell hypothesis opposed to the law of continuity, as I endeavoured to show in the last paragraphs quoted, but it appears never to have struck the objectors that it is also opposed to the theory of exchanges as it is generally enunciated, on which the whole of our supposed knowledge of extra-terrestrial matter depends. If vapours, when relatively cool, do not absorb the same wave-lengths which they give out when relatively hot, what becomes of some of the most noted exploits of our nineteenth-century science?

Take the case of sodium. Three distinct spectra have been mapped for it. There is first the yellow line seen in a Bunsen flame, then the green line seen alone in a vacuum tube when the vapour is illuminated by an electric glow, and again there is the fluted absorption spectrum, without any lines, seen when sodium is gently heated in hydrogen in a glass tube. If we have here the same molecule agitated in different ways, I ask which is the true spectrum of sodium? And what right have we to say that sodium exists in the sun because the yellow line is represented? Why do we not rather say that sodium does *not* exist in the sun because the fluted spectrum is *not* represented.

It is not necessary to enlarge upon this point because the difficulty in which the theory of exchanges is thus landed is obvious, while, if we acknowledge different molecular groupings in the vapours of the same chemical substance, and apply the theory of exchanges to *each grouping*, then the teachings of that theory become more numerous and important than before.

It is of course of the highest importance to see whether there is any *experimentum crucis*—any mode of inquiry—by which the theory can be settled one way or the other.

I submit that the results of experiments based on the following considerations ought to be accepted as throwing light on the question.

1. At different temperatures the brilliancy of the spectral lines of the same substances as ordinarily observed changes enormously. See if these changes can be produced *at the same temperature* by employing those experimental conditions which will be most likely to bring about different molecular conditions if such exist.

2. At a low temperature some substances give us few lines while at a high one they give us many. Vapours, therefore, already glowing with few lines at a low temperature, say in a flame, should give us all their lines when the vapour is suddenly subjected to a high one, say by the passage of a high tension spark. On the bell hypothesis the spectrum should change with the mode of striking. On the dissociation hypothesis this should only happen for the lines of those molecular groupings which are *from other considerations* held to be more simple. If the flame has brought the substance to its lowest state, the passage of the most powerful spark should not cause the flame spectrum to vary.

Now what are the "other considerations" above referred to? This necessitates a slight digression.

In the *Phil. Trans.* for 1873<sup>2</sup> I gave an historical account, showing how, when a light source such as a spark or an electric arc is made to throw its image on the slit of a spectroscope, the lines had been seen of different lengths, and I also showed by means of photographs how very definite these phenomena were. It was afterwards demonstrated that for equal temperatures chemical combination or mechanical mixture gradually reduced the

<sup>1</sup> Continued from p. 522.

<sup>2</sup> *Phil. Trans.*, 1873, p. 254.

spectrum by subtracting the shortest lines, and leaving

On the hypothesis that the elements were truly elementary, the explanation generally given and accepted was that the short lines were produced by a more complex vibration imparted to the "atom" in the region of greatest electrical excitement, and that these vibrations were obliterated, or prevented from arising, by cooling or admixture with dissimilar "atoms."

Subsequent work, however, has shown<sup>1</sup> that of these short lines *some* are common to two or more spectra. These lines I have called basic. Among the short lines, then, we have some which are basic, and some which are not.

The different behaviour of these basic lines seemed, therefore, to suggest *that not all of the short lines of spectra were, in reality, true products of high temperature.*

That some would be thus produced and would therefore be common to two or more spectra we could understand by appealing to Newton's rule: "Causas rerum naturalium non plures admitti debere quam quæ et veræ sint et earum phænomenis explicandis sufficient," and imagining a higher dissociation. It became, however, necessary to see if the others would also be accounted for.

Now if not all but only *some* of the short lines are products of high temperature, we are bound to think that the *others* are remnants of the spectra of those molecular groupings first to disappear on the application of heat.

At any particular heat-level, then, some of the short lines may be due to the vibrations of molecular groupings produced with difficulty by the temperature employed, while others may represent the fading out of the vibrations of other molecular groupings produced on the first application of the heat.

In the line of reasoning which I advanced a year ago,<sup>2</sup> both these results are anticipated, and are easily explained. Slightly varying Fig. 2 of that paper, we may imagine furnace A to represent the temperature of the jar spark, B that of the Bunsen burner, and C a temperature lower than that of the Bunsen burner (Fig. 1).

a b c d e f g h i k l m

FIG. 1.—A. Highest temperature. C. Lowest temperature.

Then in the light of the paper the lines *b* and *c* would be truly produced by the action of the highest temperature, *c* would be short and might be basic, while of the lines *h* and *m*, *m* would be short and could not be basic, because it is a remnant of the spectrum of a lower temperature.

So much then by way of explanation; it is clear that to make this reasoning valid we must show that the spark, or better still the arc, provides us with a summation of the spectra of various molecular groupings into which the *solid metal which we use as poles* is successively broken up by the action of heat.

We are not limited to solid metals; we may use their salts. In this case it is shown in the paper before referred to<sup>3</sup> that in very many cases the spectrum is one much less rich in lines.

The experimental work has followed two distinct lines. I shall refer somewhat in detail to the results obtained along each. The first relates to the extraordinary and beautiful phenomena and changes observed in the spectra

of vapours of the elementary bodies when volatilised at different temperatures in vacuum tubes. Many of the lines thus seen alone and of surpassing brilliancy, are those seen as short and faint in ordinary methods of observation, and the circumstances under which they are seen suggest, if we again apply Newton's rule, that many of them are produced by complex molecules.

In this case the appeal lies to the phenomena produced when organic bodies are distilled at varying temperatures; the simplest bodies in homologous series are those volatilised at the lowest temperatures; so that on subjecting a mixture of two or more liquids to distillation, at the beginning a large proportion of the more volatile body comes over, and so on.

The novelty of the method consists in the use of the luminous electric current as an explorer and not as an agent for the supply of the vapours under examination; that is to say, the vapours are first produced by an external source of heat, and are then rendered luminous by the passage of the current. The length and bore of the tube therefore control the phenomena to a certain extent.

A form of apparatus which I have found to answer very well is shown in the accompanying woodcut (Fig. 2).

A is the tube or retort containing the metal experimented on in its lower extremity, and having a platinum wire sealed into it at a distance of about two inches from the lower end, the other end being drawn out and connected by a mercury joint to an ordinary Geissler tube, which is connected by another mercury joint to the Sprengel pump C.

Another form of tube which I have used is prepared by inserting two platinum poles into a piece of combustion tubing sealed at one end, and after inserting the metal to be experimented on, drawing out the glass between the platinum to a capillary tube.

I have also tried inserting the platinum pole at the end of the retort, so that the spark passes from the surface of the metal, but this arrangement did not answer at all.

Some other modifications have been tried, but the first form I have described is that which I have found to answer best, so far as the trials have yet gone.

D is the spectroscope.

E is the lens used for focussing the image of the Geissler tube on the slit.

F is the spirit lamp for heating the retort.

H is the battery.

K and L are the wires connected with the coil.

In the second cut (Fig. 3) the method of observing the spectrum of the vapours close to the surface of the metal is indicated; the same letters apply, D' being, however, in this case a direct-vision spectroscope, which was sometimes employed for convenience.

For determining the exact positions of the lines in the spectrum of the vapour in any part of the retort, a larger spectroscope, with its illuminated scale, was used in the place of the direct-vision spectroscope.

The secondary wires of the coil were connected, one with the pole in the upper bulb at B, and the other with the platinum at A.

B is an ordinary Geissler tube with two bulbs separated by a capillary tube. The great advantage of this arrangement is that this capillary portion can be used for ascertaining what gases or vapours are carried over by the pump without any interference with the retort, both wires being connected with the Geissler tube. If, for example, we are working with sodium which contains an impurity of hydrocarbon, the moment at which it begins or ceases to come off can be found by examining the spectrum of this capillary tube.

I now give an account of the phenomena observed when we were working with sodium, in order to show the kind of phenomena and the changes observed.

After a vacuum has been obtained the retort is heated gradually. The pump almost immediately stops clicking,

<sup>1</sup> *Proc. R.S.*, vol. xviii. p. 150.

<sup>2</sup> *Proc. R.S.*, vol. xviii. p. 162.

<sup>3</sup> *Phil. Trans.*, 1873. p. 238.

and in a short time becomes nearly full of hydrogen. The spectrum of the capillary then shows the hydrogen lines intensely bright. After some time the gas comes off far less freely, and an approach to a vacuum is again obtained. Another phenomenon now begins to show itself: on passing the current a yellow glow is seen, which gradually fills the whole space between the pole in the retort and the metal; its spectrum consists of the lines of hydrogen and the yellow line of sodium, the red and green line being both absent until the experiment has gone on for some time.

As the distillation goes on, the yellow glow increases in brilliancy, and extends to a greater distance above the pole, and the red and green lines presently make their appearance as very faint lines.

The upper boundary of the yellow is quite sharp, the lines and fluted spectrum of hydrogen appearing above it.

After the yellow glow-giving vapour (which does not attack the glass) has been visible for some time, the pump is stopped and the metal heated more strongly. On passing the current a little while afterwards, a very

brilliant leaf-green vapour is seen underlying the yellow one, and connected with it by a sap-green vapour. The spectra then visible in the tube at the same time are—

Leaf-green	...	Green and red lines of sodium and C of hydrogen; D absent.
Sap-green	... ..	Green, red, and yellow sodium lines of equal brilliancy and C of hydrogen.
Yellow	... ..	D alone and C.
Bluish-green	... ..	C and F and hydrogen structure.

To observe the green sodium line alone it is necessary to point the direct-vision spectroscope just above the surface of the metal where the green is strongest. It is also necessary to guard against internal reflections from the glass, as this may sometimes cause the D line to be seen by reflection from the surface.

This method of inquiry has been tried also with potassium, calcium, and some other metals, and with metallic salts.

With potassium and calcium we get the same inversion of phenomena, the yellow-green lines of potassium being



FIG. 2.—Distillation Apparatus.

seen without the red; while in the case of calcium the blue line alone was seen.

The fact that in these experiments we get, as before mentioned, vapours which at one and the same time exhibit different colours and different spectra at different levels in the tube, at once suggests the phenomena of fractional distillation.

It is also suggested, as a result of the application of this new method, that in the case of a considerable number of chemical substances not only the line spectrum is compound in its origin, as I suggested many years ago, but that a large number of the lines is due to molecular groupings of considerable complexity, which can be kept out of the reaction by careful low temperature distillation.

So much then for one method. Now for the other.

In this I have attempted to gain new evidence in the required direction by adopting a method of work with a spark and a Bunsen flame, which Col. Donnelly suggested I should use with a spark and an electric arc. This con-

sists in volatilising those substances which give us flame spectra in a Bunsen flame and passing a strong spark through the flame, first during the process of volatilisation, and then after the temperature of the flame has produced all the simplification it is capable of producing.

The results have been very striking; the puzzles which a comparison of flame spectra and the Fraunhofer lines has set us find, I think, a solution; while the genesis of spectra is made much more clear.<sup>1</sup>

To take an instance, the flame spectrum of sodium gives us, as its brightest, a yellow line, which is also of marked importance in the solar spectrum. The flame spectra of lithium and potassium give us, as their brightest, lines in the red which have not any representatives among the Fraunhofer lines, although other lines seen with higher temperatures are present.

Whence arises this marked difference of behaviour?

<sup>1</sup> I allude more especially to the production of triplets, their change into quartets, and in all probability into sextets, and to the vanishing of flutings into lines, by increasing the rate of dissociation.

From the similarity of the flame spectrum to that of the sun in one case, and from the dissimilarity in the other, we may imagine that in the former case—that of sodium—we are dealing with a body easily broken up, while lithium and potassium are more resistant; in other words, in the case of sodium, and dealing only with lines recognised generally as sodium lines, the flame has done the work of dissociation as completely as the sun itself. Now it is easy to test this point by the method now under consideration, for if this be so then (1) the chief lines and flutings of sodium should be seen in the flame itself, and (2) the spark should pass through the vapour after complete

volatilisation has been effected without any visible effect.

Observation and experiment have largely confirmed these predictions. Using two prisms of  $60^\circ$  and a high-power eyepiece to enfeeble the continuous spectrum of the densest vapour produced at a high temperature, the green lines, the flutings recorded by Roscoe and Schuster, and another coarser system of flutings, so far as I know not yet described, are beautifully seen. I say largely, and not completely, because the double red line and the lines in the blue have not yet been seen in the flame, either with one, two, or four prisms of  $60^\circ$ , though

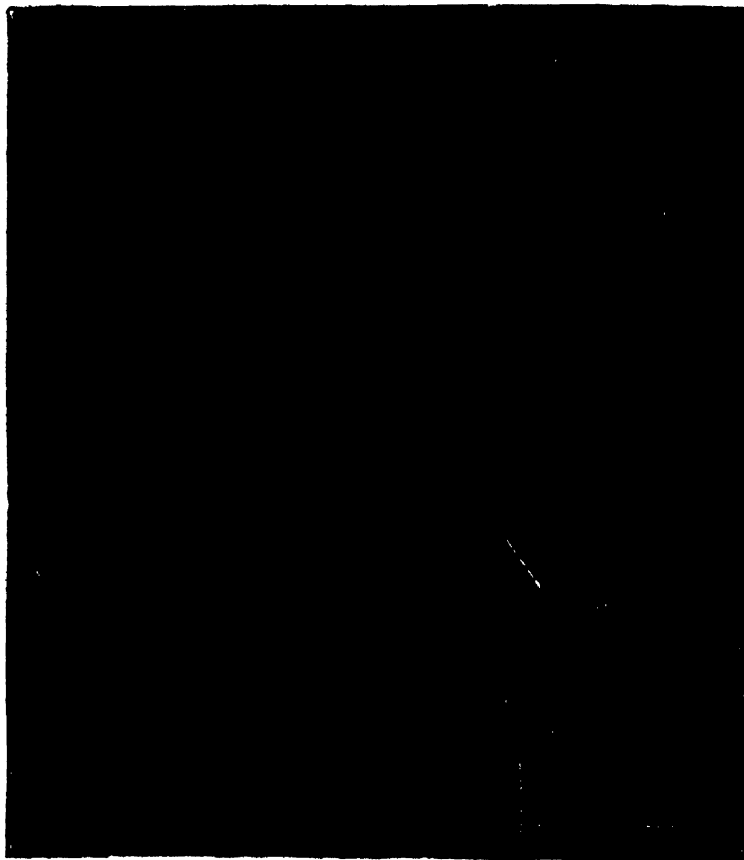

FIG. 3.—Position of Spectroscope for discovering Vapours close to the Metal.

the lines are seen *during volatilisation* if a spark be passed through the flame. Subsequent inquiry may perhaps show that this is due to the sharp boundary of the heated region, and to the fact that the lines in question represent the vibrations of molecular groupings more complex than those which give us the yellow and green lines. The visibility of the green lines, which are short, in the flame, taken in connection with the fact that they have been seen alone in a vacuum tube, is enough for my present purpose.

WILLIAM LASSELL, LL.D., F.R.S.<sup>1</sup>

THE scientific world will receive with deep regret the intelligence of the death of this distinguished astronomer. The smaller circle of those who knew Mr. Lassell personally will deplore the loss of a friend of rare worth. Mr. Lassell passed away without suffering soon after five

<sup>1</sup> Based on an obituary notice written by the present writer for the *Times*.

With regard to the second point, the passage from the heat-level of the flame to that of the spark after volatilisation is complete, produces no visible effect, indicating that in all probability the effects heretofore ascribed to *quantity* have been due to the presence of the molecular groupings of greater complexity. *The more there is to dissociate, the more time is required to run through the series, and the better the first stages are seen.*

J. NORMAN LOCKYER

(To be continued.)

o'clock on the morning of Tuesday, October 5, in the eighty-second year of his age, full of years and greatly honoured and respected.

In the words of Sir John Herschel, Mr. Lassell: "belonged to that class of observers who have created their own instrumental means, who have felt their own wants and supplied them in their own way." The qualities which enabled Mr. Lassell to do all this made him what he

was. The work was the revelation of the man. He felt precisely where lay the difficulties and wants which met him in his work, because he was sensitive and sympathetic. He could deal successfully with these difficulties, and supply these wants, often in a masterly and original way, because he could think for himself cautiously and yet boldly. He could work out his conceptions in new and difficult directions to a successful issue, because the constancy of his character showed itself here in concentration of thought and perseverance of action. These qualities, sensitive sympathy, wise prudence, constancy, were those which pre-eminently characterised him as a man and a friend.

In the history of science Mr. Lassell's name must rank with those of Herschel and the late Lord Rosse in connection with that essentially British instrument, the reflecting telescope, whether we consider the genius and perseverance displayed in the construction of these instruments, or the important discoveries which have resulted from their use. About 1820 Mr. Lassell, then in his twenty-first year, began to construct reflecting telescopes for himself. It is perhaps to circumstances which Mr. Lassell at the time considered most unfavourable that science is indebted for much that Mr. Lassell has accomplished. At that time he did not possess sufficient means to enable him to purchase expensive instruments, and besides "his business avocations were such as most men consider of an engrossing nature." The value to him in his subsequent work of the energy and power of resource which were in this way so strongly developed in his character at an early age it is difficult to appraise. His success with the two first instruments which he attempted simultaneously, a Newtonian of 7-inch diameter and a Gregorian of the same size, encouraged him to make a Newtonian of 9-inches aperture. The several mirrors made for this instrument were of great excellence. The observatory note-books of the late Mr. Dawes, which are in the writer's possession, bear record to the delicate tests for figure to which these mirrors were put on the occasions of the visits of Mr. Dawes to the observatory of his friend at Starfield, near Liverpool, where the instrument was erected.

The instrument may be said to form an epoch in the history of the reflecting telescope, in consequence of the successful way in which Mr. Lassell, on a plan of his own, secured to it the inestimable advantage of the equatorial movement.

About 1844 Mr. Lassell conceived the bold idea of constructing a reflector of 2 feet aperture and 20 feet focal length, to be mounted equatorially on the same principle. Mr. Lassell spared neither pains nor cost to make this instrument as perfect as possible, both optically and for the mechanical side. As a preliminary step he visited the late Earl of Rosse at Birr Castle, and commenced the specula for this instrument with a machine similar in construction to that employed by that nobleman. After some months work he was not satisfied with this apparatus, and was led, in consequence, to contrive a machine for imitating as closely as possible those motions of the hand by which he had been accustomed to produce perfect surfaces on smaller specula. "The essential difference of these constructions," to use the words of Sir George Airy, "as regards the movements of the grinder is this: that in Lord Rosse's apparatus every stroke is very nearly straight, while in Mr. Lassell's apparatus there is no resemblance to a straight movement at any part of the stroke." This is not the place to describe the many new contrivances in the mode of support of the mirror, in the equatorial mounting, and in the polishing machine, which enabled Mr. Lassell to bring this instrument to a high degree of perfection. I must not omit to notice, to use Sir John Herschel's words, "that in Mr. Nasmyth he was fortunate to find a mechanist capable of executing in

the highest perfection all his conceptions, and prepared by his own love of astronomy and practical acquaintance with astronomical observation, and with the construction of specula, to give them their full effect." Mr. Lassell was very successful in the great brilliancy and permanency of polish of his metal. Within the last few years the writer has been shown specula by Mr. Lassell which had not been polished for more than twenty years, and which appeared as bright as if but just removed from the polishing machine.

With this fine instrument he discovered the satellite of Neptune. This minute body was first seen on October 10, 1846, but it was not until the next year that it could be satisfactorily followed and its existence fully confirmed.

The superiority of the telescope and the vigilance and skill of the observer were further shown by the discovery in 1848, simultaneously with Prof. Bond in America, of an eighth satellite of Saturn, of extreme minuteness, which was named Hyperion.

In 1851, after long and careful search, he discovered two additional satellites of the planet Uranus (Umbriel and Ariel), anterior to the two discovered by Sir W. Herschel in 1787. In the autumn of 1852 he took his 20-foot telescope to Malta, and observed through the winter of that year.

A most careful drawing of the nebula of Orion and drawings of several planetary nebula will be found in vol. xxiii. of the *Memoirs* of the Royal Astronomical Society. With respect to the planets, to use his own words, "his discoveries were rather negative than otherwise," for he was satisfied that without great increase of optical power no other satellite of Neptune could be detected. With regard to Uranus he says, "I am fully persuaded that either he has no other satellites than the four, or if he has they remain yet to be discovered."

Mr. Lassell's energy and zeal in the cause of science did not permit him to remain content with this magnificent instrument. His last work was a much larger telescope, four feet in aperture and thirty-seven feet focus, mounted equatorially. This grand instrument was erected at Malta in 1861, and the work done with it, with Mr. Marsh's assistance during the next four years, is fully described in vol. xxxvi. of the *Memoirs*. This work consists of numerous observations of nebulae and planets and a catalogue of the places of 600 new nebulae discovered at Malta. It is not possible to suppress a feeling of regret that this magnificent instrument no longer exists.

After his return from Malta Mr. Lassell purchased an estate near Maidenhead, and erected in an observatory his equatorial telescope of 2-feet aperture. Mr. Lassell's experience in repolishing his 4-feet mirrors suggested to him some alterations in his polishing machine. After his return he was able to carry out these experiments in a workshop erected at Maidenhead, and succeeded in constructing an improved form of polishing machine, which is described in the *Transactions* of the Royal Society for 1874. In 1839 Mr. Lassell was elected a Fellow of the Royal Astronomical Society, received its gold medal in 1849, and in 1870 was elected its president, which office he held for two years. He became a Fellow of the Royal Society in 1849, and received one of its gold medals in 1858. Among other honours conferred upon him may be mentioned an honorary degree from the University of Cambridge, and the honorary Fellowships of the Royal Societies of Edinburgh and Upsala.

The numerous papers by Mr. Lassell to be found in the *Monthly Notices* and the *Memoirs* of the Royal Astronomical Society bear abundant record to his industry and skill, and make us feel that in Mr. Lassell's death we have to deplore the loss of one who contributed largely to the advancement of the science of his age.

WILLIAM HUGGINS



## NOTES

ANOTHER brilliant synthesis has recently been accomplished in the domain of organic chemistry; Messrs. Grimaux and Adam have succeeded in building up citric acid from glycerin. We shall give full details next week. Curiously enough, in the last number of the Berlin *Berichte*, Kekulé announces that he has been working at the same subject, but by a totally different method. Kekulé's work is not sufficiently advanced for him to say positively that his method of synthesis is successful, but he feels justified in saying that very probably the process adopted by him has resulted in the formation of citric acid.

THE death is announced of Dr. Hofrath von Wagner, Professor of Technological Chemistry in the University of Würzburg, and the author of several works on that science, chief of which is "Jahresberichte über Chemische Technologie" and "Handbuch der chemischen Technologie," translated into English by Mr. Crookes. He was born at Leipzig in 1823, and first taught in Nüremberg.

THE credit of the invention of binocular glasses has usually been assigned to a certain Bohemian friar, Father de Rheita, who died at Ravenna in 1660. His treatise, which bears the quaint title of "Oculus Enoch et Elise," was published at Antwerp in 1645. In 1677 there appeared at Paris a volume entitled "La Vision parfaite," by another ecclesiastic, Père Cherubin of Orleans, which contained an account of some improvements on de Rheita's discovery, illustrated by excellent copper-plate engravings. Lately however Signor Govi has unearthed in the Bibliothèque nationale a printed document which proves the antiquity of binocular glasses to be a little more remote. This document is a placard by one D. Chorez of Paris, who lived on the island of Nôtre-Dâme, at the sign of the "Compas." The placard is in old French, and is headed "Av Roy"; it states that the "admirable lunettes" it describes, and which are represented by accompanying figures, were invented by Chorez and dedicated to the king in 1625.

IN the placard of the optician Chorez referred to, the address actually printed was "la ruë de Perigneur aux Marais du Temple"; but these words have been struck out with a pen, and above is written "Lisle nostre Dame." The incident is curious as showing that two centuries and a half ago the same quarters of Paris were frequented as now by the instrument-maker M. Salleron is in the Rue Parée du Marais; M. Lemaire a little farther north, just out of the *Quartier du Temple*, in the Rue Oberkampf. On the island of Nôtre-Dâme the opticians elbow one another in shoals, not to omit M. Bregnet's modest shop. The only district of Paris which can, indeed, compete with these being the *Quartier Latin*, where instrument-makers of all kinds abound.

WITH regard to the announcement in an enterprising provincial contemporary of a projected "Natural History Survey of India," the general conduct of which is to be intrusted to Dr. George King of the Botanical Gardens, Calcutta, we believe that those most concerned know nothing which affords any foundation for the statement. The notion is intrinsically improbable, inasmuch as the "Flora of British India," which is in process of preparation at Kew, and of which the third volume is now in course of publication, covers the same ground. It would be inexpedient for the Government to take any step of the kind as far as botany is concerned till the material collected by Indian botanists since the beginning of the century has been fully worked up, and this is being rapidly proceeded with under the direction of Sir Joseph Hooker, assisted by Mr. C. B. Clarke of the Bengal Education Department, who has been detached on duty at Kew for the purpose.

THE case recently reported in the newspapers of poisoning by American tinned beef is calculated to arouse much alarm in the minds of those who use tinned meats. According to the newspaper report of the inquest, no direct evidence was given that poisoning was actually due to zinc or other metallic poison; in the present state of knowledge the explanation referred to by Mr. Dyer in his letter to the *Daily News*, viz., that it was due to the unwholesome state of the meat itself, and not to metallic poison absorbed from the tin, seems the most probable. Nevertheless, a series of well-conducted experiments, undertaken by some of the companies whose trade in these meats is so large, on the action of meat juices on tin and on solder, might do much to allay suspicion, and at the same time to advance our knowledge of natural facts.

IN the last session of the United States Congress at Washington, May 24, 1880, the "Committee on Naval Affairs" reported a bill in support of a proposed International Commission to agree upon standard tests for colour-blindness and visual power in navies and merchant marines, and standard requirements of these faculties. Resolutions in recommendation of this Commission have been passed by the American Ophthalmological Society at their Newport meeting, the Ophthalmological Section of the British Medical Association at Cambridge, and the International Congress of Ophthalmology at Milan. The next United States Congress will act on this bill to initiate the Commission. Dr. R. Joy Jeffries, 15, Chestnut Street (Beacon Hill), Boston, Mass., U.S. America, intimates that he will be greatly indebted for any public or private statistics or information in relation to this subject which any one can send him.

MR. ADAM SEDGWICK, who was elected a Fellow of Trinity College, Cambridge, on Saturday last, the 9th inst., graduated in the First Class of the Natural Sciences Tripos of 1877, when he was especially distinguished for his knowledge of zoology and comparative anatomy, human anatomy and physiology. Those of our readers who are interested in the study of the principle of heredity may be glad to know that this gentleman is the great-nephew and eldest male representative of the illustrious geologist whose name he bears.

IN reference to our note (NATURE, vol. xxii, p. 541) upon the awards of the juries of the Exhibition of Agriculture and Insectology at Paris, wherein we observed that a suggestion had been put forward to arrange the electric light as an insect-catcher, a correspondent writes that in experimenting for other purposes with a Browning electric light upon a roof at Charing Cross, besides innumerable flies and moths, single individuals of two species of sphinxes were attracted, probably from considerable distances.

THE Freedom of the City of London was conferred on Sir Henry Bessemer on Wednesday last week. Sir Henry in his address indicated the vast improvements which his process had introduced in the manufacture of steel, and at the dinner in the evening he sketched the early progress of iron manufacture.

THE French Minister of Public Instruction has caused an edition of Mr. Herbert Spencer's work on Education to be published for gratuitous distribution in France.

A PRACTICAL experiment was, on Wednesday last week, tried with the air-engine at Woolwich, designed by Col. Beaumont, Royal Engineers, and which has been for some time running on the short lines of the Royal Arsenal. Although weighing but 10 tons, it has proved capable of hauling a burden of 16 tons up a fair incline, and arrangements were made to try its powers in a more extended run, such as engines of the kind would have to encounter on the London railways and tramways. The air-reservoir, which contains only 100 cubic feet of air, was charged at the torpedo pumping-house, up to pressure of 1,000 lb. to

the square inch, and with this store of energy it was proposed to run to and from Dartford, about 16 miles. The chief feature of Col. Beaumont's method is the introduction of an almost imperceptible supply of steam, by which the air, as it is admitted to the cylinder from the reservoir, is largely heated, and thereby greatly increased in force. The engine is driven by six cylinders and a double set of machinery at one end, and, having no smoke-stack, resembles in appearance a locomotive tender rather than a locomotive. It runs on four wheels, and in size is less than that of an ordinary omnibus. It left the Royal Arsenal at Plumstead Station at 12.22 p.m., with a full charge of 1,000 lb. to the inch, passed Abbey Wood Station at 12.27 with 940 lb. on the gauge; Belvedere at 12.33, with 8.60 lb.; and Erith at 12.36, with 760 lb., arriving at Dartford at 12.50, with a remaining energy of 540 lb. on the square inch. Shunting about at the station reduced this pressure somewhat, and at 1.35 the return journey commenced with a store of 510 feet. Although the minimum for effective working is considered to be a pressure of 200 feet, Plumstead station was reached again at 2.10, but the engine was nearly pumped out, having a pressure of barely 80 lb. remaining. It was stated that another engine was being constructed, much more powerful; capable, in fact, of travelling double the distance with a single charge. The operation of pumping in the compressed air occupies about fifteen minutes, and it is calculated that an air engine on this principle as large as the usual steam locomotive of 50 tons weight would be considerably more powerful than any locomotive yet made. The objection to steam, that it frightens horses, cannot apply to this system, as there is no escape of steam visible or audible, and the only noise to be distinguished is a rumbling sound like the rattle of the street traffic.

ONE of the most satisfactory reports on the progress of cinchona cultivation and the harvesting of bark in the Government plantations in Bengal, has just been issued by Dr. King. A summary of the work of the year 1879-80 shows that the plantation was extended by about three-quarters of a million of young trees, a crop of 361,590 lbs. of dry bark was harvested, a new kind of cinchona, namely, that which yields the Carthagena bark of commerce, was brought into cultivation, and the nursery stock was maintained at a sufficiently high level for the supply of young plants for the present year. In the details of the year's planting it is shown that as in former years the species most largely planted was *C. succirubra*, and of this as many as 644,222 were put out. Of the valuable *C. calisaya* and hybrid plants a comparatively large number has been planted; of the hybrid species as many as 39,400 at Mungpoo, and 36,680 at Sittong, and of *C. calisaya* 12,782 at Sittong. The yield of bark during the year amounted to 361,590 lbs. of dry bark. Dr. King further reports that in accordance with the orders of Government arrangements were made towards the end of the year for sending a quantity of the Calisaya bark, which had accumulated in the factory store-room, to London for sale, and since the expiry of the year, part of this bark has actually been despatched: further it is stated that the amount of febrifuge used in substitution of quinine in Government hospitals and dispensaries during the past year was 5,400 lbs. Taking the average price in Calcutta of quinine for the year at Rs. 90 per lb. (a low estimate), the saving effected by this substitution has been very nearly four lakhs of rupees. The saving in former years from the substitution of the febrifuge having amounted to seven and three quarter lakhs of rupees, the total saving up to the end of last year therefore reaches eleven and three quarter lakhs, which is quite a lakh and a half more than the plantations (including compound interest at 4 per cent.) have cost since their commencement. This is a most satisfactory statement, added to which the introduction through Kew of the valuable species of cinchona, yielding Carthagena or Columbian bark, and the

prospect of its successful propagation, makes Dr. King's present report one of very great interest and satisfaction.

WE have received several numbers for the current year (vol. v.) of the *Botanical Gazette*, a Paper of Botanical Notes published at Crawfordsville, Indiana. The *Gazette* appears to have a large circulation in Western America, which, as far as we can judge from the specimens before us, it well deserves. We quote the following interesting and sensible remarks from the editorial notes:—"A new school of botanists is rapidly gaining ground in this country, and we are glad to see it. While the country was new and its flora but little known, it was very natural for systematic botany to be in the ascendency. It is a very attractive thing to most men to discover new species; but when the chance for such discovery becomes much lessened, there is a turning to the inexhaustible field of physiological botany. Systematists are necessary, but a great number of them is not an essential thing, and it is even better to have but a few entitled to rank as authorities in systematic work. But in studying the life-histories of plants or their anatomical structure, we cannot have too many careful observers. This, at the present day, seems to be the most promising field, and one botanist after another is coming to appreciate it. As microscopes are becoming cheaper, and hence commoner, the workers in the history of plants are becoming more numerous, and it is to such that the *Gazette* would now address itself." We noticed especially some remarkable observations by a correspondent of the *Gazette* on the carnivorous habits of the honey-bee of South America. These would appear, however, to require confirmation before they can be accepted without hesitation.

THE *Valley Naturalist* is the title of a small monthly journal published in St. Louis, U.S. It contains contributions in various departments of natural science; it would be of more value, we think, if it confined itself more strictly to contributions on local natural history, and had fewer miscellaneous items from foreign journals.

WE noticed a few months ago that an international metrological office had been established at Breteuil (near St. Cloud) at the expense of all the civilised nations except England. A part of the duties of this office is to deliver to the associated nations approved standard metres and kilograms for the ulterior construction of other standards, and practical verification of the usual metres and kilograms. The standards intended for France being ready, the Minister of Public Instruction appointed the French national committee, which is composed of MM. Dumas, St.-Claire Deville, Ilervé-Mangon, Mascart, and a few others. It may be noted that M. Tresca, who designed the pattern of the international metre adopted by the International Commission, is not one of the new committee.

THE Nineteenth Century Building Society has done a commendable thing in resolving, that as, in their opinion a course of lectures at the Parkes Museum of Hygiene on House Sanitation would be most valuable to the members of building societies (who to a very large extent own the house they live in), the secretary of the society be requested to ask the Committee of the Museum whether such a course of lectures could not be given gratuitously during the ensuing winter.

THE Municipal Council of St. Petersburg is at present deliberating on a proposition made by the Electrotechnik, a Russian society recently established, for illuminating with Siemens lamps the Newsky Prospect, whose length is 7,000 metres.

THE Algerian *Akhbar* says, in one of its last numbers, that the corpses of two European travellers, who according to all probability have died from want of water, have been discovered lying in the desert fifty miles southward of Wargla, the most remote oasis occupied by the French in the Algerian Sahara.

The names and nationality of these two unfortunate travellers have not been ascertained yet, according to our contemporary.

FROM a Japan paper we learn that at the Botanical Garden in Aichi ken, an Indian tea-plant, has been planted as an experiment. The leaves have lately been gathered and treated in the same manner as the Uji tea, and it has been found that the product of dried tea is greater in proportion to the quantity of leaves used than in the case of Japanese plants. Tea-growers are, in consequence, said to be devoting their attention to the new plant.

THE additions to the Zoological Society's Gardens during the past week include a Plantain Squirrel (*Sciurus plantani*) from Java, a Smooth Snake (*Coronella levis*) from Hampshire, presented by Mr. D. Tober; a Plantain Squirrel (*Sciurus plantani*) from Java, presented by Mrs. Elliot; a Common Spoonbill (*Platalea leucorodia*), European, presented by Mr. W. H. St. Quintin; a Common Kestrel (*Tinnunculus alaudarius*), European, presented by Mr. J. Young; two Central American Agoutis (*Dasyprocta isthmica*) from Central America, a Variable Squirrel (*Sciurus variabilis*), a Common Boa (*Boa constrictor*) from South America, two West African Pythons (*Python seba*) from West Africa, a European Pond Tortoise (*Emys europæus*), European, two Glass Snakes (*Pseudopus pallasi*), a Lacertine Snake (*Colepeltis lacertina*), a Common Snake (*Tropidonotus natrix*-var.), South European, deposited; a Fraser's Squirrel (*Sciurus stramineus*) from Ecuador, a Ring-tailed Coati (*Nasua rufa*), a Cayenne Lapwing (*Vanellus cayennensis*) from South America, three Californian Quails (*Callipepla californica*), purchased; two Gayals (*Bibos frontalis*) from Assam, two Sumatran Porcupines (*Hystrix longicauda*) from Sumatra, an Indian Crocodile (*Crocodilus palustris*) from India, received in exchange.

OUR ASTRONOMICAL COLUMN

HARTWIG'S COMET.—Prof. Winnecke, in a circular issued from Strassburg on October 5, expresses the opinion that it is highly probable the comet discovered by Dr. Hartwig on September 29 was observed in the year 1506, and at his request Dr. Hartwig has submitted the point to calculation, using the first approximation to the orbit which we gave last week. Laugier computed elements of the comet of 1506, from the rough accounts left by European chroniclers and one in the Chinese annals, but his places were necessarily very arbitrarily fixed in this case, as may be seen on referring to his communication presented to the Academy of Sciences at Paris on January 26, 1846. It has not been consequently from any striking similarity between the orbits that Prof. Winnecke has been led to conjecture the identity of the comets, but rather, it would appear, from a general resemblance of track, allowance being made for the somewhat later appearance in the year of the comet of 1880. The Chinese observations do certainly in some cases enable us to make reliable approximations to the orbits of comets, as, for instance, in 568 and 1337; indeed for the latter comet they furnish a remarkably good outline of its apparent path, considering the difficulties which in many cases attend the interpretation of the Chinese accounts: nevertheless for the great majority of comets recorded in their annals the descriptions are unfortunately totally insufficient for this purpose, one very common failing being the omission of dates corresponding to the positions given, as for the comet of A.D. 178, which must have passed very near the earth from the long track it described in the heavens.

As regards European observations of the comet of 1506, Pingré tells us (on the authority of the Chronicles which, according to his excellent custom, are named in his margins), that a comet was seen in the month of August in the north, or between the north and east, or lastly between the west and north, and as the comet was not distant from the Pole, so that it appeared in the evening after sunset, and in the morning before sunrise, it may have had at different hours of the night the various positions mentioned by the historians. It had a long and bright tail which extended "between the fore and hind-wheels of the chariot." On August 8 a Polish historian, an eye-witness, says it was seen near the Pole above "the seven stars or the stars of the great chariot;" on the following night it was

situated amongst the same stars, and later, on several nights, it was seen below them; declining by the signs Cancer, Leo, and Virgo, it attained the northern part of the horizon and disappeared on August 14. Some writers limit its appearance to eight days; others say it was visible for three weeks, or even a month.

With respect to Chinese observations, Pingré quotes from Gaubil's manuscript, of which he made so much use, which was preserved in the Dépôt de la Marine at Paris in his time, but since understood to be lost, and from Mailla and Couplet. We have now the fuller translations by Biot and Williams. We read that in the first year of the epoch Ching Tih, in the reign of Woo Tsung, on the day Ke Chow of the 7th moon (1506, July 31), a star was seen to the west without the boundary of Tsze Wei (the circle of perpetual apparition). . . . After some days it had a short tail. It was seen between the sidereal divisions Tsan (determined by δ Orionis) and Tsing (by μ Geminorum), the Chinese sidereal divisions, it must be remembered, being intervals of right ascension with wide limits of declination reckoned from the determining star of the division, which we have here taken from Biot. It gradually lengthened, extending in a north-westerly direction towards or to Wan Chang (θ, ζ, φ Ursæ Majoris). On August 10 it was bright, and moved to the south-east, it lengthened to about 5° and swept the upper of the stars Iea Tae (ν, ξ, Ursæ Majoris), and entered within the space Tac Wei Yuen (Biot's *Thai-Wei*), a space between stars in Leo and Virgo, to which, as also to Tsze Wei, the circle of perpetual apparition mentioned above, constant reference is made in the Chinese cometary observations. For the limits of this space Williams may be consulted. Biot and he substantially agree in their translations. Dr. Hartwig assumes the perihelion passage in 1506 to have occurred on July 1, old style, and with the elements of 1880 finds a track of which it is remarked, "Die Uebereinstimmung des so gefundenen Laufes mit dem wirklich beobachteten ist eine vollständige." The track is thus given:—

	R.A.	Decl.		R.A.	Decl.
July 19 ...	97° 1'	+39° 3'	Aug. 18 ...	250° 1'	+54° 5'
29 ...	106° 6'	61° 3'	28 ...	258° 1'	37° 0'
Aug. 8 ...	201° 9'	77° 9'			

We should incline to characterise the presumed identity of the comets of 1506 and 1880 as one rather of possibility than of high probability.

From observations at Strassburg on September 29 and October 1, and one at Leipzig on October 3, Mr. Hind has deduced the following elements:—

Perihelion passage, September 6·9182 G.M.T.

Longitude of perihelion ...	81° 1' 37"	} App. Eq.
ascending node ...	44 19 47	
Inclination of orbit ...	38 28 11	
Logarithm of perihelion distance ...	9·558048	
Motion—retrograde.		

As regards position the comet may be observed for many weeks, but the brightness will be rapidly declining. Since it was not detected till three weeks after perihelion passage, it is desirable that observations should be continued as long as practicable, if the character of the orbit is to be decided at this appearance.

GEOGRAPHICAL NOTES

THE newly-published volume of the Geographical Society's *Journal* contains some useful and even valuable contributions to geography. The veteran traveller, Capt. R. F. Burton, furnishes a memoir respecting the new map of Midian constructed by the officers of the Egyptian General Staff. Capt. Burton however, as might be expected, supplies geographical information beyond that given by the Egyptian officers. He also contributes a second paper of a different character on the subject of a visit to Lissa and Pelagosa. Even more valuable than Capt. Burton's first paper is Lieut. R. C. Temple's account of the country traversed by the second column of the Tel-Chottah field-force in the spring of 1879, with his sketch-map of part of the country passed over by it between Candahar and India. This memoir has evidently been drawn up with elaborate care, and embodies a mass of important information. The notes upon some astronomical observations made in Kordofan and Darfur

by Major H. G. Prout of the Egyptian Staff are also of value, and are accompanied by a map of routes in the two provinces, constructed by the Society's draughtsman from the reconnaissances of various officers in the service of the Khedive. Mr. E. Colborne Baber, lately our Consular representative at Chungking in Western China, also communicates through the Foreign Office some brief remarks under the heading of "Approximate Determination of Positions in South-Western China," to which are appended a number of tables of observations for latitude, &c.

In the middle of last January Mr. W. S. Jerdan and a small party started from the Elderslie station on the Diamantina River, in Western Queensland, for the purpose of exploring the Mackinlay Ranges for gold. Leaving the Booker-Booker Mountain, with its dark fringe of gidys scrub, on their left, and Mount Munro on the right, they travelled up the Diamantina over splendidly grassed downs, and as they advanced up the river they found that the grasses became even finer and herbs more plentiful. After eight days' marching the party reached the neighbourhood of the Mackinlay River, and they report that the country passed over for some time previously was principally level plain, and just at that season perfectly bare, with the exception of a few tussocks. After about another week they got out of the low country and obtained their first good view of the Mackinlay Ranges, which they describe as presenting a very picturesque appearance in the distance, with their numerous pinnacles, peaks, and flat-topped mountains. The country along the ranges is covered with granite boulders, or else consists of decomposed granite flats infested with spinifex, with numerous sandy creeks running through it in all directions. The party spent about two months in searching for gold, but met with little success.

SIGNOR BIANCHI has reported to the Milan Society, which sent him out to Shoa and other parts of North-Eastern Africa for the purpose of making commercial explorations, that he has been able to make some corrections in the position of places as given on our existing maps. Antotto he places in  $8^{\circ} 53' N.$  lat.,  $36^{\circ} 15' E.$  long., instead of its present position further north. Fanfinni is really north-north-east and not south of Antotto, while the Salala Mountains are fifty kilometres from Fanfinni, and not close to it. Lake Zouay he has not met with, though his route ought to have taken him to it, according to the map.

The United States Navy Department have received through the Russian Government a letter from the Captain of the Arctic Exploration steamer *Jeannette*, dated from Cape Serdze Kamen, August 29, 1879, which reports the arrival of the *Jeannette* at that place on the afternoon of the above date. The letter states that the members of the expedition were all well, and that they expected to sail that night for Wrangell Land, by way of Kaliutchin Bay. This news has taken more than a year to reach America. The *Corwin* has arrived at San Francisco, and is reported to have searched all the region between Point Barrow and Herald Island, without finding any trace of the expedition. Still he thinks there is no reason yet to give up hope.

The new number of *L'Exploration* is an improvement on previous ones. We have a good article on the commercial relations between France and Russia; information as to the progress to their destination of MM. Revoil and Crevaux; an interesting analysis of an article on Ausland, on the country of Muata Yanvo, a letter from Dr. Quintin on a former expedition to the Upper Niger, and letters from Matteucci on the progress of his expedition in the Sudan. The notes are also much better edited.

CAPELLO and Ivens have furnished to the Portuguese Government a detailed account of their African explorations, a great number of drawings, and a comprehensive map containing an important part of Portuguese Africa, and also the adjacent territories. Next year Capello and Ivens will return to Africa to finish their explorations, and make a complete chart of the province of Angola.

The death has just taken place at Pitminster, near Taunton, of Capt. Hobson, of the Royal Navy, who in his earlier days took an active part in the search for the remains of the late Sir John Franklin, and was the discoverer of the records which afforded the clue to the lamented explorer's fate. He was second in command, then holding the position of lieutenant to Capt. McClintock, who, in the year 1845, sailed in the *Fox* to search for the Franklin Expedition. Hobson was the leader of one of the parties which went in search of traces of Franklin, and he succeeded in finding the brief record which only too

clearly set at rest the conjectures which the public entertained as to Sir John Franklin's fate.

THE expedition which left France on October 5 for the exploration of the country between the Upper Senegal and the Niger, though mainly for military and commercial purposes, is likely, if successful, to add greatly to the fulness and precision of our knowledge of that region of Africa. Astronomical, geometrical, and topographical officers accompany the expedition, so that we may expect important scientific results. The terminus on the Niger will be either Bamakou or Dina, above Yanina and Segon.

COL. FLATTERS has returned from his explorations in the Tonareg region.

THE Wellington correspondent of the *Colonies and India* states that the area of the Crown forest lands in New Zealand in 1879 was estimated at 10,158,870 acres, but it has been proved that some of the most valuable kinds of timber have been recklessly used, and it is said that at the present rate of consumption all the splendid *kauri* forests will be exhausted in twenty-one years, and that the value of the timber will be about 11,000,000*l.* He does not however appear to have taken into consideration the very serious effect which this wholesale destruction of forests will have upon the climate of New Zealand.

### PROF. ASAPH HALL ON THE PROGRESS OF ASTRONOMY<sup>1</sup>

ASTRONOMY, in some of its forms, reaches back to the most distant historical epochs, and the changes that it has undergone during this long lapse of time give to this science a peculiar interest. In no other branch of human knowledge have we such a long and continuous history of the search after truth, of the painful struggle through which men have passed in freeing themselves from theories approved by the wise of their own times, and in overthrowing beliefs which had become incorporated into the life and culture of those times. Perhaps the grand array of the heavens, and the vast phenomena which they display, naturally led men to the invention of complicated theories; but these passed away at last before the test of observation and the criticism of sceptical men; and the Copernican theory of our solar system, Kepler's laws of elliptical motion, and the Newtonian law of gravitation, gave to astronomy a real scientific character.

The discovery of the laws that govern the motions of the heavenly bodies, and the construction of the theory of these motions, demanded from practical astronomy better observations and a more accurate determination of the orbits of the planets and the moon, or of the constants that enter into the problems of celestial mechanics; and this demand led to an improvement in the instruments, and in the art of observing. The astronomers and instrument-makers of England and France led the way in these improvements. The great national observatories of those countries were established, and in England, Flamsteed and Sharp, Bird and Bradley, were foremost in raising practical astronomy to the condition of satisfying the demands of theory. But theoretical astronomy was soon to receive a wonderful advancement. Perhaps no one contributed more powerfully to this progress than Lagrange. The writings of this man are models of simplicity and elegance; and yet so complete and general are his investigations, that they contain the fundamental theorems of celestial mechanics. By the invention and perfection of the method of the variation of the arbitrary constants of a problem, and by the establishment of the differential equations of a planetary orbit depending on the partial differential coefficients of a single function, Lagrange reduced the question of perturbations to its simplest form, and gave the means of deducing easily the most interesting conclusions on the past and future condition of our solar system. To supplement this great theorist there was needed another kind of genius. Combining the highest mathematical skill with unequalled sagacity and common sense in its application, Laplace gathered up and presented in a complete and practical form the whole theory of celestial mechanics. Besides his numerous and brilliant discoveries in theoretical astronomy, Laplace gave us some of the finest chapters ever written on the theory of attraction,<sup>2</sup> and a complete treatise on the calculus of probability.

<sup>1</sup> Address as Vice-President of Section A, at the Boston meeting of the American Association.

<sup>2</sup> "Ein schönes Document der feinsten analytischen Kunst."—GAUSS.

By such labours as these the questions of astronomy were brought into order and classified, and the attention of astronomers was directed better than ever before to the determination of the quantities which must be found from observation. Moreover, the refinement of analysis and the completion of theory brought out new and more delicate questions, not less interesting, and requiring more complete investigation and more powerful instruments. The careful examination and study of the instruments and methods of observation became necessary, as well as complete and rigorous methods of reduction; and finally there was needed a critical and satisfactory method for the discussion of observations. For these last improvements in astronomy we are indebted chiefly to the astronomers and mechanics of Germany.

Among those who contributed by means of their optical and mechanical skill to furnish astronomy with the instruments necessary for its further advancement, no one holds a more honourable place than Joseph Fraunhofer. This man began his scientific work at the age of twenty-two, and died at thirty-nine, and yet in those seventeen years he gave to astronomy great improvements in the manufacture of optical glass, driving clocks for equatorials, and telescopes and micrometers, that in the hand of Bessel and Struve gave to observations a degree of accuracy hardly thought of before. To such men as Fraunhofer and his co-workers, who have carried on and improved the construction of instruments of precision, practical astronomy owes much; and yet, after all, the principal thing in a science is the man himself. No matter how excellent the instruments may be, the question whether they shall be used for the advancement of the science, and shall contribute the full value of their peculiarities to help towards increasing the accuracy of astronomical determinations, depends wholly on the astronomer. Again, astronomy is now so completely a science, and all its operations are so closely connected with theory, that no one is fit to have charge of an extended series of astronomical observations who has not a fair amount of theoretical knowledge. Without such knowledge his labour is apt to be thrown away, and is never so effective.

As a good example of what the modern astronomer should aim to be, we may take Bessel. To this man we owe a large part of our best methods for the examination and determination of the errors of our instruments and the introduction of complete and rigorous methods for the reduction of observations. Bessel's reduction and discussion of Bradley's observations was a masterpiece of its kind, bringing out the value of Bradley's work, which had lain unnoticed for more than half a century, and forming a starting-point for sidereal astronomy. This work was continued and perfected in his tables for the reduction of astronomical observations, published twelve years afterwards, a work that has done more than anything else to introduce order and system into practical astronomy. In the discussion of instruments and the determination of their errors, Bessel's conception of an instrument was that of a geometrical figure, and the positions of the lines and divisions of this instrument were considered with corresponding rigour. Although devoted almost entirely to astronomy, yet Bessel was an able mathematician, and of this he has left abundant proof. It seems to be necessary that a man should die and be forgotten personally before his work can be fairly estimated; but time adjusts these matters at last, and I know of no astronomer whose work promises to endure the judgment of the future better than that of F. W. Bessel.

It has been said that for producing the most puzzling compound of metaphysics and mathematics something which has neither height nor depth, nor length nor breadth, and which no one can understand, the German mathematician is unequalled. And at the same time it must be said that, for clearness of conception and beauty and precision of expression, Germany has produced in Gauss a mathematician who is unsurpassed, and who is worthy a place by the side of Lagrange. Omitting all reference to the works of Gauss in theoretical astronomy and in geodesy, which are many and important, I refer here only to his method for the discussion of observations and of deducing the most probable values of our constants. Almost the entire work of astronomy is a vast system of numerical approximation, in which the first steps are obvious and easy, but where the theory soon becomes complicated and the labour enormous. Thus the calculation of the approximate orbit of a planet or of a comet is the work of only a few hours; but the computation of the perturbations and the correction of the elements from all the observations may be the work of months and years. It is therefore of the highest importance that we should have a method for the discus-

sion of observations that will give us the best result, and which will introduce order and system into this department of astronomy. Such a method is that of least squares. For the complete theory of this method and for nearly all the arrangements and algorithms necessary for its practical application, we are indebted to Gauss. The invention and application of this method to the discussion of observations of all kinds seems to me one of the greatest improvements of modern times, and its proper use will lead to a steady progress in astronomy. We must remember, however, that this method does not undertake the improvement of the observations themselves, as some have seemed to think; but, when rightly used, it produces simply the best result we can hope for from a given series of observations. It does not therefore dispense with skill and judgment on the part of the astronomer, but one is tempted to say that, if he has not these prime qualities, then the next best thing for him to have is the method of least squares. The use of this method has become one of the chief characteristics of modern astronomy, and if we compare the results of its application with those of the older methods, we shall see its superiority. Thus, for example, no astronomer of to-day who is accustomed to the modern methods of discussion, would be satisfied with the manner in which Bouvard represents in his tables the observations of Jupiter and Saturn, but would suspect at once some error in his theory of the motions of these planets.

The present condition of astronomy is the result of the continued labours of our predecessors for many generations; and to this result the lapse of time itself has largely contributed. For the full development of the secular changes of our solar system, for an accurate knowledge of the proper motions of the stars of our sidereal universe, and of the great changes of light and heat that are going on among them, the astronomer must wait until future ages. It is his present duty to prepare for that future by making the observations and investigations of his own day in the best manner possible; and to do this needs a careful consideration of the present condition of the science. Although the objects for observation have become so numerous, and the range of investigation so wide, that there is room for the most varied talent and skill, yet there is danger that there may be a waste of labour either in duplicating work, or in doing it in an improper manner. Especially may this happen in observations of the principal planets of our system, and of the fixed stars. In the case of the planets the observations are abundant, and the orbits are already well determined, except that of Neptune, for which, on account of its slow motion, we must of necessity wait for time to develop its small peculiarities, if such there be. For all these planets the observations at one or two observatories are amply sufficient, and even then the observations ought to be confined to a short time near the opposition, or at quadrature, and so made that they may be easily combined into a single normal position, which will suffice for the theoretical astronomer. To scatter such observations over a period of several months is to throw away one's labour, and to leave to the computer the disagreeable duty of rejecting a part of the observations as useless. It seems to me, therefore, unwise for several observatories to continue heaping up observations of the four outer planets of our system, when ten observations a year of each planet will give all the data that are needed. Again, for all the principal planets, observation is now in advance of theory, except, perhaps, in the case of one or two of them. Thus, for Saturn, all the tables are decidedly in error, and, although an attempt has been made to accuse the observations of this planet, it is quite certain that the trouble lies in the theory; for in the case of Jupiter and Saturn we have the most complicated planetary theory of our system, and one that has not yet been completely developed. It seems to me, also, that observations of our moon might well be confined to one or two observatories. Here again observation is far in advance of theory, if indeed there be now in use anywhere a pure lunar theory. All the lunar ephemerides that we have are affected with empirical terms, and the lunar theory itself remains an unsolved mystery. In this case there is no attempt to impeach the observations. The trouble seems to be with the perturbations of long period, and this does not call for numerous observations during each lunation. By a proper consideration of these matters astronomers may, I think, save themselves much useless labour.

Observations of the fixed stars are of the utmost importance in astronomy, since the positions of the stars are of the fundamental points on which depends our knowledge of the motions of the planets, the moon, and of the stars themselves; and it is

on account of this fact that Bessel's tables, published in 1830, were of such great service, since they introduced correct and elegant methods of reduction, and clearly defined all the constants and epochs. We now have the positions of several hundred stars so well known that they may be safely used in the reduction of observations; and for these accurate positions we are largely indebted to the astronomers of the Pulkowa Observatory, who have made such absolute determinations a special work. There is still an opportunity for the improvement of these positions, and every well-executed determination will be of value; but it is doubtful if crude and irregular observations can add anything to our knowledge of the positions of these stars. Neither can the routine, mechanical style of observing, that is apt to prevail in large observatories, be of much use here. It would be better in most cases for such observatories to assume the positions of the fundamental stars, and to leave the further improvement of their places to skilful astronomers who understand the theory of such work, and who carefully study and become masters of their instruments. In these refined observations the refraction of light by our atmosphere also plays an important part, and this question will need to be examined at every observatory that undertakes to do independent work. It is true that every new and good meridian instrument may, and perhaps ought, to contribute something towards removing constant errors, and giving us a more accurate knowledge of a star's position; but when this position is very well known, the only way for further improvement is through complete and careful observations, and their thorough reduction and discussion.

In the observations of double stars but little had been done before the present century, and the labours of W. Struve form the real starting-point in this branch of astronomy. These labours have been ably continued by his son, the present director of the Pulkowa Observatory, and the observations of these two astronomers, extending over a period of nearly sixty years, are of the greatest value for our knowledge of the motions of the double stars. This is a branch of the science into which irregular workers are apt to enter, and where some of them have done good service; but if any amateur astronomer will compare his own work with that of the Struves, and will study the methods followed by them in determining their personal and instrumental errors, and will emulate the steadiness with which they have followed out their purpose, he can do much to enhance the value of his labour. Here the observations are simple, and easily reduced, and the chief requisites are skill and patience on the part of the observer. He should not be discouraged because he obtains no immediate or great reward for his work, or public notice, or because some one who rants about the nebular hypothesis and kindred subjects of which he knows nothing is for a time the great astronomer of the day. The observer will learn finally that a good observation of the smallest double star, or of the faintest comet or asteroid, is worth more than all such vague talk. The observation has a positive value, however small, but the physical theories of the universe, of which modern popular science is so productive, are generally worse than useless.

The first step towards a rational and trustworthy knowledge of our sidereal universe must come from a determination of the distances of the stars. The solution of this problem was attempted soon after the Copernican theory of our solar system was established, when it was seen that we have a long base line for our measures, or the diameter of the earth's orbit, and it was supposed that the solution would be easy. These early trials were all failures, but they led to some very interesting and important discoveries, such as Bradley's discovery of the aberration of light; to the knowledge of the fact that the determination of the parallaxes, or the distances of the stars, although simple in theory, is practically a difficult question; and then to an improvement in the instrumental means of observation, to a careful study of the methods of observation and the instruments, and to a recognition of the necessity of a complete and rigorous reduction of the observations. An examination of these early attempts is an instructive study. It is only about forty years ago that the solution of this problem was at last attained, and then only by the application of the most powerful instruments, and the best observing skill. An interesting result of the determinations of stellar parallax is obtained at once in the check it puts on speculations concerning the structure of the sidereal universe. The first astronomers who considered the parallaxes of the stars very naturally assumed that the bright stars are nearer to us than the faint ones, and therefore they observed the bright stars for parallax. Now, while this assumption may be true as a general statement, the actual determinations of parallax show that some

of the faint stars which are not visible to the naked eye are much nearer to us than the brightest stars of our northern sky. Again it was assumed that a large proper motion is a certain index of a star's nearness to us; but observation shows that this also may be an erroneous assumption. This is a problem whose solution is only just begun, but already we know enough of its difficulties to see that we need the most powerful micrometrical apparatus that can be brought into use. The invention of some micrometer that, while as accurate as the present filar micrometer, would give the observer a much greater range of observation, and enable him to select suitable stars of comparison, is something much to be desired. At present the heliometer seems to be the best instrument for observations of this kind. Formerly it was thought that photography would furnish a good method for such delicate determinations; but so far the photographic methods have not given the necessary degree of accuracy in the measurements, and the astronomical use of photography is confined mostly to descriptive astronomy, where, especially in solar eclipses, it has rendered excellent service. Closely connected with the parallaxes of the stars and their proper motions is the interesting question of determining their motions to or from our sun according to the theory of Doppler. Here likewise the numerical determinations are so discordant, that we cannot have much confidence in the results. In both these cases we need more powerful apparatus, and a complete and thorough investigation of the methods of observation. Perhaps some of the large instruments now constructing may be employed in these methods, and we may soon have better results.

A great advance has been made in cataloguing the fainter stars. This work was begun by the French astronomers nearly a century ago, and was continued by Bessel, Argelander, and others. An important step towards the completion of this work was taken by Argelander and his assistants in their great catalogue of the approximate positions of 324,198 stars, which was finished in 1861. This census of the stars will soon be extended, we hope, over the whole heavens; and it already forms the groundwork for the great zone observations of stars now going on in Europe and in this country, and which must be nearly finished. These observations will doubtless reveal many interesting cases of the proper motion of the stars, and will certainly form the basis for a knowledge of the motion of our solar system in space, and for sidereal astronomy generally, such as we have never had before. Our American observatories can render a good service by observing stars of southern declination, since our observatories are ten or twelve degrees farther south than those of Europe, and thus have an advantage of position which ought to be made use of; and which may serve to unite into a harmonious system the observations made in the northern and southern hemispheres. The work of mapping the very faint stars near the ecliptic has also been greatly extended, and it is to this extension that we owe the rapid increase in the number of the small planets between Mars and Jupiter. But besides aiding in the discovery of the asteroids, accurate charts of the small stars have a permanent value in giving us a knowledge of the heavens at their epoch, and also some idea of the distribution of the stars in space.

It is an interesting question whether, among the thousands of nebulae that are scattered over the heavens, any of them show changes of form or of brightness. These objects seem to be at least as distant as the stars, and as they have sometimes an area of several degrees, they must be bodies of an enormous extent. That changes are going on in these bodies seems probable, but to be visible at such distances the changes must be very great. In this case there is need of much caution in the discussion of the drawings made at different epochs, and by different astronomers with telescopes of different power; since the nebulae change their appearance with the telescope used, with different conditions of the air, and with a variation of their altitude above the horizon. Here the excellent photometers that have been recently invented, and which are being so well applied to the determination of the brightness of the stars, may give us assistance. Perhaps also new drawings of the nebulae, and their criticism and discussion, and a full recognition of the difficulties of making such drawings, will soon lead to a decision of the question of their change of form. Since the study of the light of the stars with new and improved photometers has now become a specialty, we may look for more exact and continued observations of the variable stars. This is a matter of which we know but little, and it is one where a persevering observer may do good service. Although he may not find any immediate encouragement in the discovery of remarkable relations among

these stars, or the probable cause of their variability, he will be collecting observations that must form the test of every theory. As examples of the result of intelligent and persevering observation, we have the case of the sun-spots, which led directly to the discovery of their period, and its singular variability; and that of the shooting stars, which has shown us a very curious relation between these meteors and the comets, and one which may open to us the most extensive views of the relations between our own solar system and other systems in space.

The present condition of astronomy, with its vast and rapidly increasing store of accurate observations, offers many interesting subjects to the theoretical astronomer. The observations of the stars are now so numerous, and have been so fully reduced and criticised, and the time during which the observations have been made is so extended, that we shall soon have excellent data for a new and very exact determination of the constant of precession. The orbits of the planets and the moon, and their masses, are now so well known, that little uncertainty can arise from this source; and by taking into the calculation a great number of stars in different parts of the heavens, we may be able to determine the motion of the solar system in space, as well as the constant of precession. The constant of aberration also needs a new determination, and since this constant is so closely connected with the theory of light and its velocity, and the methods of its determination are still under discussion, it would be well if several astronomers could determine this constant independently. The value we now use was found by W. Struve from prime-meridian observations, and is apparently very accurate; but no astronomical constant should depend on the work of a single astronomer with a single instrument, when it can be determined so easily and by other methods. The old method of finding the value of this constant from the eclipses of Jupiter's satellites may yet give us a trustworthy value. The value of the other constant necessary for the reduction of observations, that of nutation, must be nearly that found by Peters in his well-known investigation of this question. This value may be verified by a new series of observations of Polaris, or of the declinations of stars situated so that this constant has its full influence on the reductions.

There are many subjects in astronomy that need investigation, but in most cases the labour required is very great, and the completion of the work would occupy a long time. This follows of course from the fact that, with the refinement of observations and their exact reduction, many small terms must be considered which formerly could be neglected. The lunar theory has been a vexed question for the last two centuries, and may remain so for a long time to come. This will no doubt be the case until some able astronomer, with the will and perseverance of Delaunay, shall undertake its complete revision. This question should now be looked on as a purely scientific one, and its definite solution should be undertaken. The theory should not be patched up by guesswork to fit the observations, but should be carried out with the utmost rigour. This is a problem to which a young and able mathematician may well devote his life, and we must expect its solution from some such clear-headed devotee of science. Several of the planetary theories need a new investigation, and some of them are already in the hands of able astronomers. That of mercury is especially interesting in connection with the intra-Mercurial planets, and it is to be hoped that Leverrier's theory of this planet may soon have a careful revision.

Again, among the secondary systems, the satellites of Jupiter and Saturn offer many interesting questions to the astronomer. At present the satellites of Jupiter demand a more complete theory and new tables of their motions. Corrected elements of these satellites may be required for reducing observations of their eclipses, and for deriving a new value of the constant of aberration. These satellites form a peculiar and interesting system, and their theory is so complicated that the labour of correcting their elements and forming new tables would be great, but still within the power of a persevering astronomer. The recent discovery of the connection of comets with streams of meteors has given additional interest to cometary astronomy, and there is plenty of hard work to be done in reducing observations, in computing perturbations, and in deducing the best orbits of the comets. The periodical comets have another interest, since they may give us information concerning the matter filling space. It seems to be probable from different reasons, such as the consideration of the light of the stars, that there must be matter spread throughout the celestial spaces; but the only heavenly body that has directly given us information on this subject

is Encke's comet, which has a period of three years and a third. For a long time the motion of this comet was very completely computed by Encke, whose calculations show very strong proof of a resisting medium. These calculations were continued by Von Asten, whose early death prevented him from finishing his work, and the theory of this comet is left in an unsatisfactory condition. It is very desirable that the motion of this comet should be completely investigated, and although the method of the special perturbations of the elements followed by Encke is probably the best that can be used, still in such a case it would be well to apply various methods. Here again, on account of the frequent returns of the comet, the labour of computation is very great, and probably would be enough fully to occupy the time of one astronomer. The interesting questions connected with the motion of this comet ought to induce some one to undertake this laborious work, and these questions are so important that two or three astronomers might well be employed on its theory.

The methods of astronomy have now become so well established that the future advancement of the science is assured, especially since long intervals of time give an increased value to observations. Yet we may hope for improvement in instruments, for the introduction of new methods of observing, for better trained and more efficient astronomers; and perhaps also the rapid advancement of the physical sciences may furnish us with new and more powerful methods of investigation. There is an intimate relation between the instrument-maker and the astronomer, and they should understand each other better than is generally the case. It may seem a small matter that the divisions of a circle, or of a scale, should not be too finely or too coarsely cut; that the reading scale should not be placed in an inconvenient position, and that the illumination of the instrument should be carefully studied, and brought under the control of the astronomer; but these are really essential points, and, if not rightly arranged, are certain to weary the observer and to impair the quality of his work. Such mistakes will not be remedied until the makers better understand the uses of an astronomical instrument, and have correct ideas of the end to be attained. Since our American opticians have placed themselves at the head of their craft, we may hope that our instrument-makers will do likewise, and that they will soon be able to furnish us with the best instruments of precision.

There is one point to which astronomers should give more attention, and from which we may reasonably hope that great advantages to astronomy may come; and that is to the selection of sites for new observatories. It is possible, perhaps probable, that our instruments may be greatly enlarged and improved, and that important discoveries and improvements in the manufacture of optical glass may be made; but it seems certain that we have within easy reach very decided advantages for astronomical work by the choice of better positions for our instruments. Very few American observatories have been established for the purpose of doing scientific work, or with much thought or care for their future condition; but generally they are built in connection with some college or academy, and are the product of local and temporary enthusiasm, which builds an observatory, equips it with instruments, and then leaves it helpless. The atmosphere that surrounds us, and its sudden changes of temperature, are the great obstacles to the good performance of a telescope; and the larger the instrument, and the higher the magnifying power, the more serious are these hindrances. Now, with our present means of travel, we can easily place our instruments at an altitude of eight or ten thousand feet, and above a large part of the atmosphere. In this way we may be able to do with small instruments what at common altitudes can be done only with large ones; and when possible it is always better to use small instruments, since they are more easily handled, and are relatively stronger and better than large ones. Uniformity of temperature may be secured by seeking locations in the tropical islands, or on coasts like that of California, where the ocean winds keep the temperature nearly uniform throughout the year. At great altitudes we may secure a clearness of vision that would be of the greatest value in the examination of faint objects, and by this means, and by persevering and continuous observation, interesting discoveries may be made. It is a matter of course that, except in the case of comets, the future discoveries in astronomy will belong to faint and delicate objects; but these are interesting, and should not be neglected. A uniform temperature, which secures good definition, and steady images of the stars, is necessary for accurate determinations of position, and for all measurements of pre-

cision. This condition is especially important in such work as that of stellar parallax, the determination of the constant of aberration, and wherever the yearly change of temperature may act injuriously. In the selection of better sites for observatories I think we have an easy means of advancing astronomy.

As this science grows and expands, it will become more and more necessary to study the economy of its work, in order that astronomers may bestow their labours in the most advantageous methods, and may rid themselves of all cumbersome and time-consuming processes. The manner of publishing observations has already been much abbreviated, and improved I think, by some of the European astronomers, and this change seems destined to become universal. As the positions of many objects are now well known, the need of printing all the details of the observation, such as the transits of the wires, the readings of the micrometers, &c., is very slight; and this printing may be safely abandoned. Even this change will lead to a great saving in the time and cost of printing. But this will necessitate a more complete discussion of the work, and a more careful examination of the instruments; things to be desired, since they tend to lift the observer out of his routine, and make him a master of his business. There are objections to this change, and some of them are real, such as the importance of publishing a complete record; but this is overestimated, I think, since the original records ought always to be referred to in case of doubt; and other objections are factitious, such as the need of publishing a large and showy book in order to impose on the public.

We may hope also for improvements in theoretical astronomy, and for the better training and preparation of students of this science. I know that it is sometimes said that theoretical astronomy is finished, and that nothing more can be done. Such assertions come from professors who are old and weary, or from those young men who tire out early in life; but they are wrong. The improvements that Hansen has made in the theory of perturbations, and Poinso's study of the theory of rotation, show what careful investigation may do, and assure us of further progress. It must be confessed that some of the astronomical work done in our country bears evidence that the astronomers did not understand the correct methods of reduction, and much of it shows evidence of hasty and ill-considered plans. This is perhaps a natural condition for beginners, but we trust that it has been outgrown. An actual need for the astronomical students of our country is a good book on theoretical astronomy, similar to Pontécoulant's work, in which the whole subject shall be presented in a complete form, such as we find in the "*Mécanique Céleste*," together with an account of the improvements made by Gauss, Poisson, Hansen, and others. There is no American book of this kind, and the English works are too partial, designed apparently to fit the student for college examinations, and not to give him a complete knowledge of the science. Such a book has hardly been attempted in our language, unless that of Woodhouse may be an exception, and it may be a long time in coming, since it requires a man qualified to do the work, and will involve an expense of labour in the preparation and of cost in publishing such as few are willing to incur. In the mean time it is far better for the student to go directly to the writings of Lagrange and Laplace, of Gauss and Poisson and other masters, rather than to spend time in reading second-rate authors who endeavour to explain them. And generally this will be found the easier way also, since the student avoids the confused notions and symbols, and the grotesque expressions and egotism of small men, and is lifted into the region of ideas and invention.

In presenting his exposition of the nebular hypothesis, which has since become so celebrated, Laplace says: "I present this hypothesis with the distrust which everything ought to inspire that is not a result of observation or of calculation." It is a singular fact that, among all the writings on the nebular hypothesis, I have never seen a reference to this presentation of it by its most distinguished advocate; and yet this is the true spirit of scientific astronomy. Laplace did not wish to exempt his own theories from criticism, and neither should any one. In astronomy there is no final human authority, no synod or council, but simply an appeal to reason and observation. If a theory or a discovery be true, it will stand the test of observation and of calculation; if false, it must pass away to that Miltonian limbo where so many things have gone and are going. The question is sometimes asked, Of what use is astronomy? and the reply generally made is that it has conferred great benefits on navigation and on commerce, since it is by means of his astronomical knowledge that the sailor determines the position of his ship on

the ocean. There is a truth in this reply, but it is only partial. The great value of astronomy is that it is really a science and that it has broken the path and led the way through which all branches of science must pass if they ever become scientific. It is the spirit of honest, unrelenting criticism, and of impartial examination, that finally eliminates error and awards to every one his just due, that makes astronomy honourable and attractive; and it is by cultivating this spirit that astronomy confers its chief benefit, for it is this that shall break in pieces and destroy all false assumptions in science and in philosophy.

#### SCIENCE IN NORWAY

WE have received several publications from Norway of scientific interest.

*Nyt Magazin for Naturvidenskaberne.* B. 25, H. 4. (Kristiania, 1880.)

In this number of the Norwegian "New Magazine for Natural Sciences" Herr Hansen continues his description of the annelids yielded by the Norwegian North Sea Expedition of 1878, to which he appends drawings of his own of all the rarer forms.—Herr L. Schmelck gives the results of his analysis of sea-water obtained in the same voyage within and near the Polar circle. The water was taken at various depths, and was obtained from a stratum intermediate between the surface and the bottom by means of an apparatus devised for the purpose by Herr Törnøe.—Herr Brøgger and Reusch's observations on the character and localities of Norwegian apatite, which originally appeared in 1875 in the *Zeitschrift d. deutschen geologischen Gesellschaft*, are here translated into Norwegian by the authors, who have made various additions to their paper, which is illustrated with numerous drawings.—In a paper on the Lepidoptera of Norway by W. M. Schøyen the author draws attention to the number of new forms added to this branch of the Norwegian fauna since the publication, in 1876, of Siebke's list of the insects of Norway. The number given at that time for the lepidoptera was 934; it is now raised to 1,019. The writer's own contribution to these is 38 hitherto undetected Norwegian species, the habitats and characters of which he describes.

*Kort Fremstilling af de Norske Kursteders Udvikling, &c.* Ved Axel Lund, M.D. (Kristiania, 1880.)—In this brochure we are reminded that Norway, from her geognostic character, is naturally deficient in thermic springs, and we are shown that till recently the *water-cure*—taking the words in a comprehensive sense to include the use of waters internally and externally—was unknown in the country. In fact even now the Norwegians stand exceptionally low in the scale of water-using nations, although an encouraging change in this respect has been manifested of late years by the establishment of mineral and sea-bathing places in various parts of the kingdom. These Dr. Lund describes at great length, giving the analysis of the waters yielded by the few springs that have been opened, and the amount of salt present in the sea-water at the various marine stations, with the medical reports of each and the mode of treatment adopted. In the last respect the only difference that we observe from the system generally followed at German baths is that at the sea-bathing establishment in the Sandefjord, a small species of *Medusa* is used to excite local irritation in cases of cerebro-spinal, rheumatic, or neuralgic affections, by passing the animals rapidly over the parts affected. To Dr. Thaulow, the founder of the baths at the Sandefjord and at Modum, the Norwegians owe a large debt of gratitude as the first of their countrymen who drew public attention to the paramount importance of baths as a hygienic agent. Sweden has long been in advance of Norway in its appreciative comprehension of the curative value of mineral and sea-waters; and from Dr. Lund the reader will learn all that there is to learn in regard to the water-establishments, springs, and baths of the sister kingdom, while he may also gather some information respecting similar institutions in the Danish dominions. In conclusion, we may observe that some of the newly-opened Norwegian water-cure establishments, as that of Modum, lying in the midst of pine-woods, and the sea-bathing places on the Sandefjord and Kristianiafjord, offer numerous attractions to foreigners in respect to salubrity of air, beauty of position, and moderate cost of living.

*Knudshø, eller Fjeldfloraen.* J. B. Barth. (Kristiania, 1880.)—Herr Barth, who is well known for his animated descriptions of the natural scenery of his country, and his lively narrative of



the adventures of a sportsman in Norway, supplies us in the present sketch with a comprehensive résumé of the flora of the Fjelds. The spot he has chosen for his point of observation is the double-topped hill Knaudabb, near Kongsvold, well known to the botanists of other countries, as well as to those of Norway, for its exceptionally rich and varied Alpine flora. Here may be gathered the rare *Artemisia norvegica*; the gentians, *nivalis* and *glacialis*; some of the less common saxifrages, numerous species of *Carex* and *Salix*; and some Alpine forms, as *Kobresia caricina*, *Chamaerops alpina*, which are not found elsewhere so low down; while here, too, the collector will find close at hand a number of sub-Alpine and south-Norwegian plants of rare occurrence in other parts of the country. Herr Barth, himself an enthusiastic botanist and a practised collector, never fails to give the local and ordinary Norwegian name of the plant he describes, in addition to its scientific designation; and thus supplies foreigners with very valuable and much-needed information, the want of which often proves to be a matter of great inconvenience in studying the flora of a foreign country.

*Om Grantörken og Barkbilleren.* J. B. Barth.—In this little pamphlet the author, who is one of the first authorities in Norway on questions of forestry and arboriculture generally, explains his reasons for differing from the opinion commonly received, that the desiccation and ultimate death of the Norwegian spruce (*Abies excelsa*) are due to the attacks of *Tomicus typographus* (*Bostrychus typographus*), which is usually regarded as the most pernicious of all the insect-enemies of the Coniferae. Herr Barth does not dispute the fact that this beetle is to be found often in large numbers on trees affected by abnormal drying up, whether still standing or cut down; but, in his opinion, although disease in the tree may be the cause, it is not the result of the presence of the *Tomicus*, which he believes to have absolutely no effect on the condition of the bark. According to this view the numerous agents employed in Germany and elsewhere to eradicate this beetle have no result but waste of labour and money; the only remedy against the drying up of the bark being a more scientific mode of clearing forests, in which the trees often perish either through overcrowding, or more frequently through reckless felling, by which cold blasts are allowed to fall directly on the interior. Herr Barth's views are in opposition to those of the majority of the working foresters of Germany and Scandinavia, but his extensive acquaintance with home and foreign forests, his great practical experience, and his reputation as a naturalist, entitle them to all possible respect, although it is not to be supposed that his plea for the innocuousness of the *Bostrychus typographus* will be admitted without much sifting of the evidence, seeing that this insect is generally believed by German foresters to have been the cause of the destruction of the forests of the Harz Mountains, when between 1780 and 1790 two million trees died of desiccation.

### SPECTROSCOPIC INVESTIGATIONS<sup>1</sup>

AS I have stated in my former communication,<sup>2</sup> all chemically related elements exhibit a homology of spectra, the various spectra of the elements of a group differing solely in the manner in which their groups of lines are shifted towards one end or other of the spectrum.

In a comparative investigation on the alkaline earths, I have arrived at conclusions which may explain these remarkable analogies in chemically-related elements.

I have now the honour of laying before the Academy a brief account of my investigations; on another occasion I shall report on this subject more fully.

If the spectra of the alkaline earths are produced by a jar-spark in a hydrogen-atmosphere,<sup>3</sup> spectra are obtained which show the homology of the spectral lines very beautifully. The spectrum of magnesium cannot be compared with the spectra obtained in this manner, because it does not contain the less refrangible lines. However, without the jar, or employing a smaller battery and a smaller induction-coil, it appears that in the spectra of calcium and strontium all lines in the red and yellow disappear, and the spectra which become visible are remarkably similar to those of magnesium.

<sup>1</sup> By G. Ciamician, in *Sitz. Ber. der k. Akad. der Wiss.*, Vienna, Vol. Lxxiv. Heft I.

<sup>2</sup> "Ueber die Spectren der chemischen Elemente und ihrer Verbindungen" (vol. Lxxvi, chapter ii., October, 1877). "Ueber den Einfluss der Dichte und der Temperatur auf die Spectren von Dämpfen und Gasen." (vol. Lxxviii, chapter ii., October, 1878.)

<sup>3</sup> With four of six medium Bunsen's elements and a great Galiffe's induction coil giving a spark of 10 centimetres.

Comparing the less refrangible part of the spectrum of the alkaline earths, which are only rendered visible by increased temperature with the less refrangible half of the entire oxygen spectrum, we find the remarkable fact that these two halves of the spectra show a decided resemblance or homology. From this we may conclude that the spectrum of the groups of the earth-alkali metals is composed of the spectrum of magnesium and of that of the less refrangible parts of oxygen.

In order to determine the real importance of these remarkable analogies—it being known that the atomic weights of baryum, strontium, and calcium are capable of being composed of the atomic weights of magnesium and oxygen<sup>1</sup>—I found it necessary to analyse the spectra of combinations, which are not saturated, but behave as compound radicals, and thus most resemble in chemical behaviour the simple radicals or elements.

Hitherto I have analysed cyanogen and carbonic oxide. The cyanogen spectrum comprises two portions, one of which is the homologue of the nitrogen spectrum, the other the homologue of the less refrangible part of the carbon spectrum.

Also in the carbonic oxide spectrum there are present the well-known groups of carbon appearing as bands, and displaced in the red field there are several lines homologous to those of oxygen. Therefore the same relation exists between the spectra of nitrogen and carbon, and between the spectra of cyanogen, carbon, and oxygen, and carbon oxide spectrum, which prevails between the spectra of magnesium and oxygen and the spectra of the earth-alkali metals.

One can go further and say that in general the homology of the spectral lines of chemically-related elements is in all probability based upon the circumstance that the elements of such natural groups conform to the laws of Mendelejeff on atom-weights, and consist of identical components.

### UNIVERSITY AND EDUCATIONAL INTELLIGENCE

CAMBRIDGE.—The Science Lectures at Cambridge this term include Prof. Living on the General Principles of Chemistry, and on Spectroscopic Analysis; and Prof. Dewar on Physical Chemistry. One of the demonstrators will give demonstrations in Volumetric Analysis; and Mr. Scott, assistant to Prof. Dewar, will give a course of demonstrations in Elementary Organic Chemistry. For permission to carry out special investigations in the University laboratories application should be made to one of the Professors.

Lord Rayleigh will lecture on Galvanic Electricity and Electro-Magnetism in the Cavendish Laboratory; Dr. Schuster will lecture weekly on Radiation; Mr. Glazebrook will give an elementary course of demonstrations in Electricity and Magnetism; and Mr. Shaw will give demonstrations on the Principles of Measurement and the Physical Properties of Bodies. Courses of demonstrations are announced for the Lent Term on Heat and Advanced Electricity and Magnetism; and for the Easter Term on Light, Elasticity, and Sound.

Mr. W. J. Lewis will lecture on the Silicates, in the Mineralogical Lecture-room.

Mr. F. M. Balfour will give elementary and advanced courses on the Morphology of Invertebrata, with practical work. Prof. Humphry will lecture on the Osseous System; Prof. Hughes on the Principles of Geology, with Field Lectures; Prof. Latham on Therapeutics; Prof. Newton on Invertebrata; Prof. Stuart on Mechanism.

It is to be hoped that something may be done this term to relieve science students in the matter of Greek, and to encourage French and German studies, for want of which there is so much hindrance to science, as well as literature. The Sedgwick Geological Museum, with money accumulating, must still wait, we suppose. Will the Museum be ready for 1900?

Mr. Sedley Taylor will lecture on the Acoustics of Music in the Cavendish Laboratory.

### SCIENTIFIC SERIALS

*Bulletins de la Société d'Anthropologie de Paris*, tome iii. fasc. 2 (1880).—M. Robin, Inspecteur primaire du Département de Loir-et-Cher, has laid before the Society his scheme for obtaining important anthropological measurements by the help of teachers of schools. The proposed questions, with a full description of the various appliances by which such measurements could be

<sup>1</sup> It is, namely,  $84 + 16 = 40$  (calcium),  $84 + 4 \times 16 = 88$  (strontium), and  $24 + 17 \times 16 = 136$  (barium).

taken, have been submitted to the consideration of a special commission.—M. J. Parrot's paper on the development of the brain in infants, considers the subject chiefly in reference to the modifications of colour which the medullary substance undergoes.—The present number of these *Bulletins* gives M. P. Broca's remarks on his "goniometre flexible," of the various parts of which drawings are appended.—M. Harmand makes the interesting communication that some Cambodian inscriptions, hitherto undeciphered, have been found by Prof. Kern, of Leyden, to be Sanskrit, written in Kawi and Kalinga characters.—M. Vinson suggested that fixed rules should be drawn up for the transcription of foreign words, and should form part of the official anthropological instructions provided for travellers and explorers in savage countries. His suggestion has been accepted.—In addition to the article already referred to on the flexible goniometer, these *Bulletins* contain several papers from the pen of the late M. Paul Broca, which will be read with the more interest as being among the last of his communications to the Society; these are his post-mortem reports of the appearances presented in the thorax of a young Zulu girl, with his remarks on a retrogressive anomaly in the aorta of this girl; a description of the appearances of the cranium of the assassin Prévost, more especially with reference to the assumed importance of the protuberance between the occipital and parietal, to which Gratiolet applies the term *calotte*, and which he regards as a simian character. M. Broca considered that in the interests of physical science it would be desirable that greater facilities should be afforded to scientific men for obtaining the heads of those who die in public prisons, asylums, &c. Finally we have the report of M. Broca's remarks on the case of an illiterate boy of eleven, possessed of extraordinary powers of calculation, and evincing surprising facility in extracting cube-roots. The consideration of this case gave additional interest to the discussion that had been raised at an earlier meeting, in regard to Galton's observations on the vision of serial numbers.—M. Moudiere has drawn up a monograph on the women of Cochinchina, in which he has embodied the results of six years' laborious anthropological researches. The three races of Annamites, Cambodians, and Chinese, of which the Cochinchina population is composed, were severally studied.—M. Bertillon gives the results of his comparative analysis of the statistical tables of suicides for France and Sweden. The results show singular accord between the two countries, and the author considers himself justified in maintaining that they establish the two following laws:—1. That widowers commit suicide more frequently than married men. 2. That the existence and presence in the house of children diminishes the inclination to suicide both in men and women.—M. René de Semallé gives a comparative table of the mean length of the generations of mankind, based on the genealogy of the reigning and other princely families in Europe. From these it would seem that the period of thirty years, which in common parlance is accepted as that of a generation, very closely corresponds with the means obtained from these genealogical data.—M. Fourdrignier gives the result of his exploration of the double tumuli found at Thuizy, near Rheims, among a large number of other graves in which only one individual had been interred. Where these graves have escaped earlier spoliation, the human remains and the broken fragments of ornaments found in them would appear to show that the individuals buried together were of different sex. M. Fourdrignier has made an interesting discovery of the several parts of two conical casques. The fragments of these singular head-coverings were extracted from two of the double graves, and, according to their discoverer, they belong to a Gallic race of the pre-Roman period, and must in form have closely resembled the modern German "Pickelhaube."

### SOCIETIES AND ACADEMIES

#### PARIS

Academy of Sciences, October 4.—M. Wurtz in the chair. M. Perrier presented a *Compte rendu* of the determinations of longitudes, latitudes, and azimuths in Africa under his direction, at Géryville, Laghouat, Biskra, and Carthage in 1877 and 1878, with a description of instruments and methods. In the exchange of signals it was possible to calculate the mean retardation of transmission of a signal along a serial conductor, from chronograph to chronograph, for distances comprised between 414 km. and 1,236 km. The mean velocity of propagation was found about 40,000 km. At this rate an electric signal would go round the earth in a second.—Military and geographical explo-

ration of the region comprised between the Upper Senegal and the Niger, by M. Perrier. A Government expedition under Commandant Desbordes was to start on the 5th, Commandant Derrien having charge of the topographical department. They go to St. Louis, and make their way to Bafoulabé, at the confluence of the Bafing and the Bakhoï. Here they construct their first fort, and organise escorts and convoy, with a view to a general triangulation of the region between Bafoulabé on the Senegal, and Dina and Bamakou on the Niger. The railway contemplated would run from Medina, by Bafoulabé and Fangalla, to the Niger.—Order of appearance of the first vessels in the spike of *Lepturus subulatus*, by M. Trécul.—M. de Lesseps presented the "Bimensual bulletin of the Inter-oceanic Canal" for September.—On utilisation of the crystals of lead-chambers, by M. M. Girard and Pabat. The crystals offer an abundant and economical source of nitrous acid, and the authors have been able to prepare on a large scale, the dinitric bodies, amidoazobenzol and nitroalzarine, by making the nitroso-sulphuric acid act on the corresponding amidised derivatives, or aniline and alizarine. But the crystals can only be employed in presence of a quantity of sulphuric or nitric acid (preferably the former) sufficient to prevent their decomposition by water.—Observations of Faye's comet made at the Observatory of Florence-Arcetri, by M. Tempel.—On some thermometric questions, by M. Crafts. It is very probable that the least change of volume of a thermometer is accompanied by a change of the coefficient of dilatation.—On the decomposition of salts by liquids, by M. Ditte. The laws of dissociation by heat which apply to decomposition of salts by pure water and by saline or acid solutions, apply also to decomposition by alcohols, and probably in general to decompositions of salts by the wet way, whatever the solvent.—On the physiological action of *Conium maculatum*, by M. Bochefontaine. Conine diminishes or abolishes the physiological properties of the nervous centres before acting like curare on the "nervo-muscular junctive substance" (Vulpian). In the dog and frog it at length abolishes the nervous excitomotricity if given in sufficient quantity, and it is fatal for batrachians as well as for mammalia. Hemlock then may act like curare, but it has additional physiological effects.—Floral dimorphism and staminal petalody observed in *Convolvulus arvensis*, L.; artificial production of this latter monstrosity, by M. Heckel. Petalody is the effect of direct fertilisation long continued. The autogamic process in plants as in animals (but in a longer period with the former) has the result of altering the organs of reproduction and leading to absolute infertility.

### CONTENTS

	PAGE
THE INDIAN FAMINE COMMISSION . . . . .	551
GAMGEE'S "PHYSIOLOGICAL CHEMISTRY," By Dr. M. FOSTER, F.R.S. . . . .	551
PEAT-MOSSES . . . . .	551
OUR BOOK SHELF:—	
Lunn's "Vox Populi" . . . . .	551
Angel's "Practical Plane Geometry and Projection for Science Classes, Schools, and Colleges" . . . . .	551
Bell's "Teorica delle Forze Newtoniane e sui Applicazioni all' Elettrostatica e al Magnetismo" . . . . .	551
Schubert's "Kalkül der Abzählenden Geometrie" . . . . .	551
LETTERS TO THE EDITOR:—	
The Spectrum of Hartwig's Comet.—W. H. M. CHRISTIE . . . . .	551
Wire Torsion.—Major J. HERSCHEL, F.R.S. . . . .	551
The Magnetic Storm.—G. M. WHIPPLE . . . . .	551
Coral Reefs and Islands.—Prof. JOSEPH LECONTE . . . . .	551
Geological Climates.—Dr. P. MARTIN DUNCAN, F.R.S. . . . .	551
The Yang-tse, the Yellow River, and the Pei-ho.—T. MELLAND	551
READER	
Miller's Elements of Chemistry—Part III. Organic Chemistry.—Prof. HENRY E. ARMSTRONG, F.R.S. . . . .	551
Swiss Châlets.—H. N. MOSLEY . . . . .	551
Spectra of the Brocken at Home.—J. INNES ROGERS . . . . .	551
Ice under Pressure.—C. A. M. . . . .	551
Mr. Haddon's Marine-Zoology Class.—ALFRED C. HADDON . . . . .	551
Landalps.—THOS. WARD . . . . .	551
LIQUEFACTION OF OZONE . . . . .	551
THE UNIVERSITY OF NEW ZEALAND . . . . .	551
DOCTORED WINES . . . . .	551
MULTIPLE SPECTRA, III. By J. NORMAN LOCKYER, F.R.S. (With Illustrations) . . . . .	551
WILLIAM LASSELL, LL.D., F.R.S. By Dr. WILLIAM HUGGINS, F.R.S. . . . .	551
NOTES . . . . .	551
OUR ASTRONOMICAL COLUMN:—	
Hartwig's Comet . . . . .	551
GEOGRAPHICAL NOTES . . . . .	551
Prof. ALAFRÉ HALL ON THE PROGRESS OF ASTRONOMY . . . . .	551
SCIENCE IN NORWAY . . . . .	551
SCIENTIFIC INVESTIGATIONS. By G. CIAMCIAN . . . . .	551
UNIVERSITY AND EDUCATIONAL INTELLIGENCE . . . . .	551
SCIENTIFIC SERIALS . . . . .	551
SOCIETIES AND ACADEMIES . . . . .	551





THURSDAY, OCTOBER 21, 1880

## SCIENTIFIC WORTHIES

XVI.—RICHARD OWEN

**A**MONG time-honoured sayings there is none the truth of which comes more frequently home to the scientific worker than that which reminds him that a prophet is not without honour save in his own country and among his own kin. Its very truth would seem to make it short of impossible for us to take full cognisance of our own Scientific Worthies. The subject of this notice, still in hale strength, though now in full years and full of honours, is however in a very great measure an exception to the above proverb. Foreign men of science and foreign countries when they came to offer him their rewards found him already decorated. That a life abounding in labour, some of the results of which will remain as the heritage of mankind, was not undeserving of human recompense the following lines will abundantly show.

Richard Owen was born on July 20, 1804. He matriculated in the University of Edinburgh in 1824. Entering Bartholomew's Hospital the following year, he took the diploma of the Royal College of Surgeons in 1828. In 1825 he visited Paris, making the acquaintance of Baron Cuvier. On the completion of his medical studies Owen settled down to practise in Serle Street, Lincoln's Inn Fields. While at Bartholomew's Hospital he had been one of Dr. Abernethy's dissectors, and in 1828, on Dr. Abernethy's suggestion, he was employed at the College of Surgeons to make the catalogue of the Hunterian Collection in that institution. Mr. Clift was the Conservator of the College Museum at this time. The first catalogue of the invertebrate animals in spirits was published by the College in 1830, and in the following year appeared the memoir on the Pearly Nautilus (*Nautilus pompilius*), with some excellent drawings from the author's pencil.

The Zoological Society of London had been at this time in existence for some years, but up to 1830 it can scarcely be said to have had any scientific life. Some few of the then Fellows determined it should be otherwise, and after some little opposition the Council of the Society allowed the formation of a committee of science, who were further permitted to publish their own *Proceedings*. The first meeting of this committee was held on November 9, 1830, at which Owen read a paper on the anatomy of the Orang-Utan. It is not without interest to note that at the next meeting, held December 28, 1830, a letter was read from Vaughan Thompson, mentioning his discovery of a metamorphosis in Crustacea. From 1830 to the present date the contributions to the *Transactions* and the *Proceedings* of the Zoological Society of Mr. Owen have been both numerous and important, and for many years he was the unpaid prosector to the Society. He also at this period read several papers on pathological subjects before the Medical Society of St. Bartholomew's and the Medical and Chirurgical Society of London, one of the most remarkable of which was that describing the anatomical results of the ligature of the internal iliac artery, by Dr. Stevens, at Santa Cruz in 1812.

In 1834 a Chair of Comparative Anatomy was founded

VOL. XXII.—No. 573

for Mr. Owen at St. Bartholomew's Hospital. In the year 1835 he published an account of a remarkable nematoid worm found living in the muscles of the human body (*Trichina spiralis*), and giving rise to a serious and often fatal disease called trichinosis, since, unfortunately, too well known. In 1834 he was elected a Fellow of the Royal Society, and in the same year was appointed the first Hunterian Professor at the Royal College of Surgeons. This chair he continued to fill until 1855. Mr. Owen, on succeeding his father-in-law, Mr. Clift, as Conservator of the Museum of the College of Surgeons, gradually retired from professional practice, and after a short time devoted himself exclusively to scientific pursuits. Of the thirty years during which he worked at Lincoln's Inn Fields, the last twenty were mainly spent in the study of comparative anatomy. A very rapid survey of the immense amount of work accomplished by him during this period will not be without interest. The catalogue of the physiological specimens in the Hunterian Collection consists of five quarto volumes, which were published by the Council of the College of Surgeons between 1833 and 1840. The catalogue of osteological specimens is contained in two quarto volumes published in 1853, and that of the Fossil Vertebrates and Cephalopods in three quarto volumes published in 1855.

The great work on the study of teeth was issued between 1840-1845. In preparing the drawings for this work Prof. Owen was threatened with an attack of retinitis, and was compelled to commit the further preparation of the illustrations to the excellent artists Lens Alden and Eideben.

The well-known Lectures on Comparative Anatomy and Physiology appeared between 1843 and 1846. After a one-and-twenty years' study of the homologies of the vertebrate skeleton, Prof. Owen's era-marking work on the "Archetype and Homologies of the Vertebrate Skeleton" was published. After having made a certain progress in comparative anatomy the evidences of a greater conformity to type, especially in the bones of the head of the vertebrate animals, than the immortal Cuvier had been willing to admit, began to enforce on Prof. Owen a re-consideration of Cuvier's conclusions to which for long he had yielded implicit assent. The results of these reconsiderations were successively communicated to the Royal College of Surgeons of England in the Course of Hunterian Lectures for 1844-45, and a sketch of his general views on the subject was laid before the British Association at Southampton in 1846. In 1849 were published the memoirs "On the Nature of Limbs," and "On Parthenogenesis." The term "parthenogenesis" was devised to replace a phrase somewhat cumbrous and incorrect, which was to this time applied to designate a phenomenon as interesting as strange.

Nor was all this sufficient for the superabundant energy of the Hunterian professor. The Palæontological Society succeeded in enlisting his services for a series of monographs of British fossil vertebrates, and during this period were published a memoir on the "Fossil Chelonian Reptiles of the Purbeck Limestones and Wealden Clays" (1853), the various supplements to which date from 1859 to 1879; "On the Fossil Reptiles of the London Clay" (1849, 1850), the portion of this memoir relating to the Chelonia was in part written by the late Prof. Bell; "On

C C

the Fossil Reptiles of the Cretaceous Formations" (1851). A remarkable series of papers on the Fossil Birds of New Zealand and on some Fossil Mammals of Australia also about this date appeared in the *Transactions* of the Zoological Society, and a very elaborate memoir on the great American Megatherium in the *Philosophical Transactions*.

But even amid a scientific activity that rivalled that of his great friend Baron Cuvier, Prof. Owen had the energy to devote some time during these thirty years to the more direct benefit of his fellow men. He was appointed one of the Commissioners to inquire into the Health of Towns. This Commission sat during 1843 and 1846. A special report from his pen on the sanitary state of his native town, Lancaster, appeared in 1848, and the improved sewage of that town with a new water supply on the intermittent system followed. He was appointed as one of the Commissioners on the Health of the Metropolis, 1846, 1848, and again on the Commission on the Meat Supply in 1849; as the result of this latter Commission it will be remembered that the famous market at Smithfield was suppressed, and the large Cattle Market was transferred to Islington.

Prof. Owen was also one of the Commissioners for the Great Exhibition of 1851; Chairman of the Jury on Raw Animal Products applied to Food and Manufactures, and Vice-Chairman of the Jury for "Les Substances Alimentaires" in the Great Exhibition of Paris in 1855. Labours so abundant were not without reward. In 1842 the Royal Society conferred on him the Royal Medal for his memoirs on the General Economy of the Monotremes and Marsupials. In 1846 the same society decreed to him the Copley Medal. In 1851 the King of Prussia sent to him the "Ordre pour le Mérite." In 1852 her Most Gracious Majesty assigned to him a residence in Richmond Park, and in 1855 the Emperor of the French bestowed on him the cross of the "Légion d'Honneur." The old Universities of Oxford, Cambridge, and Dublin conferred on him honorary degrees. The Royal College of Surgeons of Ireland made him an Honorary Fellow, and most of the learned societies of Europe and America numbered his name on their lists of Honorary or Corresponding Members.

John Hunter had left behind him a very abiding monument of his labours, some idea of which could now be obtained from the patient labours of the first Hunterian professor; but on terminating those labours Prof. Owen bethought him of yet another way in which he could make known the thoughts and works of the founder of philosophical surgery, which was, by the publication of Hunter's original papers. Between 1793 and 1800 Mr. Clift, F.R.S., had sole charge of the Hunterian collection and manuscripts, and during this period he had copied some proportion of the latter before they were removed from the Museum in Castle Street, Leicester Square, by the executor, Sir Everard Home. A short time previous to Mr. Clift's death he placed in Prof. Owen's hands the whole of his transcripts of the Hunterian manuscripts, with an autograph statement of the important fact. These were published in two volumes in 1861, and thus, after an entombment of nearly seventy years, were added "to the common intellectual property of mankind."

Prof. Owen's connection with the Royal College of

Surgeons ceased in 1856, when he was appointed Superintendent of the Department of Natural History in the British Museum. He was the Lecturer on Palæontology at the School of Mines in Jermyn Street in 1856, a Fullerian Professor of Physiology in the Royal Institution of Great Britain in 1858.

When Prof. Owen entered on his duties at the British Museum his attention was at once called to the subject of the want of space wherein to stow the rapidly increasing natural history collections. For several years already had Dr. Gray, to whom this Museum owes so much, urgently demanded additional space. In 1851, in 1854, and again in 1856, Dr. Gray implored for more room; scarcely half of the zoological collection was exhibited to the public, and their due display, he declared, would require more than twice the space devoted to them. Numerous suggestions were made to remedy this state of things, but without avail. Even such distinguished trustees as the late Sir Roderick Murchison and Sir Philip Grey Egerton, backed though they were by a large and most influential body of scientific memorialists, were powerless to obtain the least of the additions to the British Museum which they had recommended—additions which long ere this date would have been overcrowded in their turn. The Government declined to carry into effect any alterations in the present building in Great Russell Street, preferring the alternative of a severance of the Natural History Department from the British Museum. At this juncture it seemed to Prof. Owen to be unwise and indeed even wrong to hazard the safety and utility of these collections by persisting in the advocacy of a course which was futile, and having satisfied the then Chancellor of the Exchequer of the exigencies of the case, plans were obtained for a large new museum at South Kensington which would afford a superficial space for display of the collections, systematically arranged, of about five acres. Prof. Owen's report (1859) was approved of, but a vote on account of the new building was negatived by the House of Commons. This led to the publication of a pamphlet by Prof. Owen, "On the Extent and Aims of a National Museum of Natural History," in 1862, and as a final result the Government obtained the sanction of Parliament in 1872 to the erection at South Kensington of the magnificent range of buildings there just completed, in which in process of time the whole of the natural history treasures of the British Museum will be systematically arranged.

For long the propriety of moving this collection from Great Russell Street was hotly contested, and as in other great questions the weight of authority could at one time be quoted as against the move. Scientific men are however as a rule not often to be unduly swayed even by authority and they are generally philosophical enough to accept accomplished facts. In this immense building the State has provided ample accommodation, so far as space is concerned, for the present collections and for the probable increase of these for another generation; and not content with this, there is in addition room enough for future generations if they feel inclined, to nearly double the available space, and thereby even add to the beauty and completeness of the whole structure. In the obtaining of this splendid casket in which to display Nature's gems, Prof. Owen has seen accomplished one great object of

his life; and even those who think it might have been better for science had their own peculiar plans been carried into effect, will hardly grudge Prof. Owen the palm of victory which he may have won from them.

The necessary and often arduous routine work required of Prof. Owen as head of so large a department did not in any great measure diminish the extraordinary activity with which he from time to time published original works. Nearly a quarter of a century has elapsed since he entered on his duty at the British Museum, and the record of his contributions to science during this period equals, if it does not surpass, that of the previous thirty years period. Among the more important of these we must notice: Memoir on the British Fossil Reptiles of the Mesozoic Formations—Pterodactyles, 1873-1877; on the British Fossil Reptiles of the Liassic Formations—Icthyosaurs and Plesiosaurs, 1865-1870; on the British Fossil Cetacea of the Red Crag, 1870; on the Fossil Reptiles of South Africa, 1876; on the Classification and Geographical Distribution of Mammals, 1859; a Manual of Palæontology, 1861. The long list of papers published in the *Proceedings* of learned societies, to be found in the Royal Society's invaluable Catalogue (numbering over 360), includes many, the scientific value of most of which would have given an abiding fame to their author. It would be impossible here to give even a tithe of their titles, but we quote a few to show that Prof. Owen left few of the classes of the animal kingdom unnoticed:—On the Andaman Islanders; on the Anthropoid Apes; on the Aye-Aye; on the Giraffe; on the Great Anteater; on the Great Auk; on the Dodo; on the *Apteryx australis*; on *Lepidosiren annectens*; on the *Argonauta argo*; on *Spirula australis*; on Clavagella; on *Limulus polyphemus*; on Entozoa; on *Euplectella cucumer* and *E. aspergillum*.

In 1857 he was elected president of the British Association for the Advancement of Science. In 1859 he was chosen one of the eight Foreign Associates of the Institute of France (in succession to Robert Brown). The King of Italy conferred on him the "Ordre de St. Maurice and St. Lazare" in 1862. The Emperor of Brazil in 1873 gave him the Imperial Order of the Rose, while in the same year the Queen conferred on him the Order of the Bath. In 1874 the Academy of Medicine, Paris, elected him as one of their Foreign Associates in succession to Baron Liebig.

At an age when most men have to cease from their labours, the subject of this necessarily brief notice works on. No better proof could there be of a spirit still young, than to witness the energy with which he has entered on the occupation of the new home for natural history at South Kensington; and who will not join in the hope that he may live to see its treasures arranged in an orderly sequence. In this sketch we have presented Prof. Owen as one eminently qualified to take high rank among our Scientific Worthies. What niche in the temple of fame he may permanently occupy is perhaps better left to a generation removed from our own to determine. To us it would seem as if a double portion of the spirit of Cuvier had without doubt fallen upon Owen, who has raised for himself a monument of work that is truly stupendous.

## INSECT VARIETY

*Insect Variety: its Propagation and Distribution. Treatment of the Odours, Dances, Colours, and Music in all Grasshoppers, Cicada, and Moths; Beetles, Leaf-Insects, Bees, and Butterflies; Bugs, Flies, and Ephemera; and Exhibiting the Bearing of the Science of Entomology on Geology.* By A. H. Swinton, Member of the Entomological Society of London. (London, Paris, and New York: Cassell, Potter, Galpin and Co. No date.)

WHEN Mr. Darwin published his "Descent of Man" in 1871 non-entomological readers were first made acquainted with a host of interesting facts connected with the various sounds produced by insects, the different colours in the two sexes, with their corresponding senses, emotions, and habits, so far as these bore upon the question of sexual selection. As in so many other cases Mr. Darwin's volume was the means of attracting the attention of working entomologists to this interesting field of observation, which has since been assiduously worked by Dr. Fritz Müller in Brazil, while in this country Mr. Swinton has for many years devoted himself to its study, both by personal observation and by collecting together the scattered observations spread over the entire literature of entomology, the result of his labours being embodied in the present volume.

No more interesting or instructive subject could be found for a great entomological work. The author appears to have spared no pains in the collection and elaboration of his materials. The book is full of original observations, and carefully drawn tabular statements of facts. It is copiously illustrated with roughly executed but characteristic figures; and the writer is evidently a man of wide information and some literary skill. But notwithstanding all these points in its favour, the book—except as a mere collection of facts—is a disappointing one. The arrangement is frequently defective; the style is often so vague and high-flown as to be actually unintelligible; while whenever an attempt is made to generalise the facts adduced, the writer appears to have no definite views of his own, or if he has is quite unable to convey them to the reader. A few examples will serve to illustrate the several merits and defects here pointed out.

In discussing the combats of male insects as tending towards a selection of powerful males from which to continue the race, our author well remarks that the law of the prior appearance of the males subjects them also to all atmospheric and other influences, "rendering them inured to manifold terrestrial strife previous to propagating their kind." This is a good observation; but what is probably a more important function of the early appearance of the males is, that the females should not have to wait long in order to be impregnated and thus be exposed to the dangers of destruction, owing to their usually slower flight and consequent defencelessness, before their great duty of oviposition has been safely performed.

The remarkable discovery by Dr. Fritz Müller of scent-producing organs in a variety of Brazilian butterflies, is here supplemented by an account of the numerous cases in which analogous organs, often of very varied kinds, have been found in moths, though in comparatively few instances has any odour been actually detected. It may

however very possibly exist even though quite imperceptible to us. Most of these organs occur in male insects only, whereas it is undoubtedly the case that the males discover the females at great distances, and we should therefore anticipate that the latter would have the scent-producing organs, the former the sense-organ capable of perceiving the odour. The investigation of this obscure subject is however still in its infancy.

Whether the antennæ are organs of touch only or of some other sense is yet undecided, but the question might probably be solved by an experimenter as ingenious and persevering as Sir John Lubbock. Mr. Swinton speaks of the male butterfly or moth "running over his partner with snuffing antennæ," but this is begging the question; and the following observation, though interesting, does not throw much additional light on the subject: "One dull afternoon on the 4th of September during the wet season of 1879 my eye was arrested by the pretty dappled wings of a female of the large Magpie Moth who was flying most purposely from leaf to leaf along a hedgerow. She successively visited a reddening bramble, a hawthorn, clematis, and guelder-rose, fruitlessly touching over their glandular surfaces with a quick alternate vibration of her black antennæ, in search, as I at first supposed, of honey-dew. The crisping foliage of a thorny sloe finally arrested her, and seemed to confer satisfaction on her tactile perception; for raising simultaneously her feelers and crawling on to the centre of a leaf, she hung on at its upper surface, elevated her wings, and by curling her abdomen round its apex, began to methodically attach her oval and shagreened eggs to the underside close to the midrib. She could distinguish *Souchong* from *Pekoe*."

The account of light-giving insects is very unsatisfactory, the old theory of the light serving as a guide and attraction to the male being the only one given. Yet in the list of luminous insects appended to the chapter we find no less than six cases recorded in which larvæ or pupæ are luminous, a fact which might surely have suggested a doubt as to the use of luminosity as a sexual attraction in the case of the glowworm and fireflies. There being so many luminous larvæ, taken in connection with the fact (not mentioned by Mr. Swinton) that glowworms are distasteful to birds, renders it almost certain that Mr. Belt's explanation is the true one, and that luminosity is, primarily, a warning of uneatableness, and is therefore a protective character, though it may of course, like colours, serve the purpose of aiding discovery and recognition by the opposite sex.

The whole subject of colour is treated with vagueness and indecision, and we find no systematic grouping of the facts nor any firm grasp of a principle by which to interpret them. The following characteristic passage will illustrate these deficiencies:—"The attractive quality of insects' colours from the foregoing appears nearly that presented to the human eye, and, utilised in sedentary or aerial display, originates phenomena of love and rivalry, battles, dances, and gregariousness in evident parallelism with those evoked by music. But this attractive virtue, which must be considered as stimulative, does not reside especially in either sex, as some at first sight might be inclined to assert; for we find conspicuous colorisation, though for the most part distinguishing the males, sometimes by a species of inversion appearing in the females;

the sexes also are often very similar in hue. And the reason of this is that the females very generally attract the eager males by sedentary display, of which the moth kind affords notable instance. Here we may remark the paler hues of many heavy *Bombycina* females who exhibit on herbage, and the grey, white, or satiny shades of moths that repose on tree-trunks, sexually marked in the Gipsy Moth, who is rendered in measure terrestrial by her limp wings. Others more or less apterous, like the Vapourers and *Psychidæ*, owe what little chromatic attraction they possess to their conspicuous cocoons."

There is hardly a sentence in this paragraph that is not open to discussion or that is not more or less inconsistent with some other sentence; while the whole is completely neutralised by the succeeding paragraph which goes on to describe how the male moths are evidently attracted to their partners by odour, and not by sight at all!

The chapter on the sounds produced by insects is crowded with interesting observations and is certainly of great value, yet here too we meet with the same looseness of remark and incapacity to see the importance of certain facts. Thus, we find the strange, and in the present state of our knowledge altogether unproved statement that—"In *Lepidoptera* music is in direct relation to colour, sound to beauty;" while the fact that the *pupa* form of some *Hemiptera* stridulate, taken in connection with many proofs that the sound is produced under the influence of fear, shows that in some cases at all events these sounds are protective rather than sexual; and this opens up a field of inquiry analogous to that of the diverse uses of colour, but which our author passes over almost without remark.

Among the smaller errors and misconceptions in the volume we must note the statement that Darwin adopts the pressure theory of the formation of the bee's cell (p. 58); the total misconception of the theory of mimicry (at p. 81); and the extraordinary account of tropical colour, certainly evolved out of the writer's own consciousness. He says:—"In the Brazils, for example, all colours whether of birds, insects, or flowers, are brilliant in the extreme. Blue, violet, orange, scarlet, and yellow are found in the richest profusion, and no pale faint tints are to be seen"! In the matters of *Palæontology* and *glacial* epochs the author's authority is Mr. Page; but the subject is evidently beyond him, for he confounds the precessor of the equinoxes with the obliquity of the ecliptic, and winds up with "glacial phenomena at the poles now exposed to the continuous action of cold interstellar space, with a collapsing in the earth's superficies, giving birth to the ensuing wrinkling marked by earthquakes volcanic action, and land depression, or *vice versa*."

We also notice many errata, indicating some carelessness in passing the volume through the press. Dr. Falconer is called "Faulkener" (p. 15); *arthropods* is written for *arthropods* (p. 86); *Leucanidæ* for *Lucanidæ* (p. 99); *Grophilus* for *Geophilus* (p. 101); and *Libuella* for *Libellula* (p. 311); but the chief fault of the volume is a constant effort at fine writing, which, combined with an inveterate obscurity of style, often renders it utterly impossible to comprehend what is meant. Scores of passages might be quoted illustrative of this peculiarity, but the following will serve our purpose:—

"Dealing with geological chronology, the phenomena



of generic and specific variation should also be applicable in explanation of certain plants and insects of constant character, being discovered confined to various geological soils within the radius of their distribution, or to favourite haunts postulating more than simple dispersion from a centre. And the pale blue of butterflies frequenting limestone and chalky downs need evoke no interference in the law of albinism if the honeyed cowslips and downy oxlips over whose leaves they flutter are, as reputed by Linnæus and Prof. Henslow, specifically identical with the shadow-seeking primrose, and may be raised from the same root. So likewise the local feature of melanism may be regarded as not only manufacturing annual varieties, but as pervading the black, brown, and drab tribes of the Alpine, Arctic, and woodland faunas, and may give a reason for their dark trait of beauty."

We give up the above in despair of extracting its meaning, if it has any; and cannot but regret that a book so full of valuable facts and good observations should be spoilt by constant efforts at philosophical disquisition, for which the tone of mind of the writer quits unfits him.

#### WEAPONS AND POLITICS OF THE ANCIENT HINDUS

*On the Weapons, Army Organisation and Political Maxims of the Ancient Hindus, with Special Reference to Gunpowder and Firearms.* By Gustav Oppert. (Madras: Higginbotham and Co.; London: Trübner and Co., 1880.)

"WHILE pursuing my researches into ancient Indian history," says Dr. Oppert, "I lighted upon two ancient Sanskrit manuscripts containing interesting information on many new and important topics. One of them, the *Nītiprakā'sikā*, has been, I believe, up to now utterly unknown, and the other, the *'Sukranīti*, though known to exist, has never been described and published." The manuscripts relate to the weapons and military organisation of ancient India, a subject upon which fresh light was much needed. If for no other reason, therefore, they deserved to be edited and translated. But one of them at least also contains statements sufficiently novel and startling to claim for them a special hearing. If we may believe it, not only was gunpowder invented in India long before the days of Berthold Schwarz or Roger Bacon, but firearms, including both cannon and guns, were known and used. The guns were even provided with sights and flints. "The tube" of one of them, it is said in the *'Sukranīti*, "is five spans long, its breech has a perpendicular and horizontal hole, at the breech and muzzle is always fixed a sesame-bead for aligning the sights. The breech has at the vent a mechanism which, carrying stone and powder, makes fire by striking. Its breech is well-wooded at the side, in the middle is a hole, an *angula* broad; after the gunpowder is placed inside, it is firmly pressed down with a ramrod. This is the small gun which ought to be carried by foot-soldiers. . . . A big gun is called (that gun) which obtains the direction of the aim by moving the breech with a wedge; its end is without wood; but it is to be drawn on cars. . . . The ball is made of iron, and has either small balls in its inside or is empty." Dr. Oppert believes that the *Nītiprakā'sikā* also contains references to firearms, though the passages he quotes seem rather to refer to supernatural weapons or to fire-machines like those used by the Greeks of the Eastern

Empire. A work, too, which mentions the Hūnās ("Huns," or Europeans) cannot be of the antiquity to which he would assign it.

Dr. Oppert seeks further support for the early use of firearms in India in a passage from a portion of the *Atharvānārāhasya*, which he renders: "the fire prepared by the combination of charcoal, sulphur, and other material depends upon the skill of its maker." It is plain, however, that there is no necessary allusion to gunpowder in these words, much less to firearms. A quotation from *Manu*, in which fighting with "darts kindled by fire" is forbidden, is equally inconclusive.

The statements of the *'Sukranīti* must therefore stand by themselves. In spite of Dr. Oppert's arguments to the contrary, it is difficult to admit that in its present form it can be earlier than the thirteenth century. The prohibition to use firearms in "fair" fighting would not account for the total absence of any reference to them in the law-books and epics and other literature of ancient India, and had they existed in the seventh century, or had the Hindus been acquainted with gunpowder at that time, we can hardly suppose that the fact would have remained unknown to the inquisitive Buddhist pilgrims from China who have left us accounts of their travels in the Peninsula. The Greek fire had nothing to do with gunpowder, and we do not therefore see why Dr. Oppert introduces it into the discussion, while there is no proof that the *manjanīk* or machine employed by Mohammed Kasim at the siege of Daibal (A.D. 711) was propelled by gunpowder. The flaming thunderbolts launched by the Indians against the army of Alexander, according to the pseudo-Aristotle, belong to the region of myth, like the storms of lightning with which Herakles and Dionysos were received when they invaded India, as related in the romance of *Philostatos*. Gunpowder may indeed have been invented in India, as Beckmann believed, but if so we want further evidence before we can admit that the invention was earlier than the twelfth or thirteenth century of our era.

Among other interesting points noticed by Dr. Oppert are the (ideal) rate of pay received by the officers and privates of a Hindu army at the time the *Nītiprakā'sikā* was composed, and the identification of Manipura, the capital of the Pāndya kings, with the modern Madura. He also points out that the boomerang is well known in many parts of India, especially in the south, and that he himself possesses four wooden ones, besides an iron one, which he obtained from Pudukoṭa. Two ivory ones, from the armoury of the late Rajah of Tanjore, are preserved in the Madras Museum. The Tamil name of the boomerang is *valai tadai*, or "bent stick," and it is employed in hunting deer. It is one of the weapons described in the *Nītiprakā'sikā* under the name of *astarā* or "scatterer."

#### OUR BOOK SHELF

*Lehrbuch der organischen Qualitativen Analyse.* Von Dr. Chr. Th. Barfoed. (Kopenhagen: Andr. Frest und Sohn, 1880.)

THERE is no branch of qualitative chemical analysis in such an unsatisfactory condition as that which deals with organic acids and bases. The plans on which examines



## LETTERS TO THE EDITOR

[The Editor does not hold himself responsible for opinions expressed by his correspondents. Neither can he undertake to return, or to correspond with the writers of, rejected manuscripts. No notice is taken of anonymous communications.]

[The Editor urgently requests correspondents to keep their letters as short as possible. The pressure on his space is so great that it is impossible otherwise to ensure the appearance even of communications containing interesting and novel facts.]

## Photograph of the Nebula in Orion

DURING the night of September 30 I succeeded in photographing the bright part of the nebula in Orion in the vicinity of the trapezium. The photographs show the mottled appearance of this region distinctly. I intend shortly to publish a detailed description of the negatives. They were taken by the aid of a triple objective of eleven inches aperture made by Alvan Clark and Sons, and corrected especially for the photographic rays. The equatorial stand and driving-clock I constructed myself. The exposure was fifty minutes.

HENRY DRAPER

New York, October 2

## An Annelidan Entozoon

WHILE examining the intestinal tract of *Megaderma frons* from the Gold Coast, I found coiled up spirally and adhering to the wall of the lower part of the ileum a small parasite about half an inch in length. On placing this under the microscope I was much surprised to find that it belonged to a class of worms (*Annelida*), none of the species of which have hitherto been known as Entozoa, and further that I was unable to refer it to any of the orders of that class.

On showing it to Dr. J. D. Macdonald, F.R.S., he quite agreed with my opinion that it represents a new order of Annelids, and is moreover disposed to consider it as a connecting-link, hitherto wanting, between the *Chaetopoda* and the true leeches.

The specimen in question is about half an inch in length without distinct segmentation, except what is indicated by the perfectly regular disposition of the cephalo-somatic appendages—seventy-three pairs, extending from the anterior almost to the posterior extremity of the body—whereof those occupying the anterior attenuated fourth of the body are fin-like lamellæ, apparently branchial, with a single unarmed mouth not provided with a proboscis, with the intestine spirally coiled round the ovarian tube and terminating inferiorly at the posterior extremity of the body.

*Megaderma frons*, the host of this remarkable annelid, is a species of bat of very peculiar aspect, which is apparently widely distributed throughout and restricted to the tropical parts of the Ethiopian region. It belongs to a genus whereof one of the species at least is known to suck the blood of smaller bats, which it captures on the wing (see my "Monograph of the Asiatic Chiroptera," p. 77), and as all the species closely resemble one another in structure, it is exceedingly probable that they have all much the same habits.

Although I found remains of insects in the intestinal canal of the specimen from which the above-noticed parasite was taken, yet there was also mixed up with them a large quantity of hair, not from its own body, but evidently (judging from its microscopic structure) that of some other bat on which very likely it had been feeding. It is also worthy of notice that the intestine of the parasite is filled with a reddish matter like the remains of blood.

I have handed over this very interesting specimen to Dr. Macdonald, who will shortly publish a full description of it with figures.

G. E. DOBSON

Royal Victoria Hospital, Netley, October 7

## Sounds made by Ants

FROM the very interesting remarks lately made by Sir John Lubbock regarding the habits and capabilities of ants, I gather that he seems to consider them as a silent group. The modes of producing sounds among insects are as various as beautiful, whether by internal or external agency. As a rule the larger animals produce sound by internal means, *i.e.* voice, and insects by some external means.

Among ants I know of two varieties or distinct kinds, a black and brown, that make a concerted noise loud enough to be heard

by a human being at twenty or thirty feet distance, and which sound is produced by each ant scraping the horny apex of the abdomen three times in rapid succession on the dry crisp leaves of which the nest is usually composed.

The noise made by a single ant is sufficiently loud to be heard on a very dry leaf if attention is directed to it, and no doubt by this means of a vibrating medium they can without special auditory organs communicate with each other. I had the honour of first discovering that the great *Mygale stridulans* made a noise; the apparatus by which it was produced was discovered and fully described by Mr. J. Wood Mason of the Indian Museum, and I should be glad if I am the means of making a similar discovery regarding ants. White ants (so-called) make a noise which is audible—if put on crisp paper—by suddenly shaking the whole body, and seem to warn each other by this means.

Sapakati, Sibsagar, Asam, August 20

S. E. PEAL

## Faraday Exhibiting Ghosts

MR. J. INNES ROGERS' communication on a "Spectre of the Brocken at home" reminds me of a passage in Dr. Hence Jones's "Memoir of Faraday," vol. i. p. 422.

Faraday's niece, Miss Reid, thus writes: "One evening a thick white mist rose and completely hid everything before us. About ten o'clock my uncle called me into his room to see a spectre. He placed the candle behind us as we stood at the window, and there, opposite to us, appeared two gigantic shadowy beings, who imitated every movement that we made."

Ardchapel, N.B., October 16

W. S.

## Ice under Pressure

IN reply to C. A. M.'s letter of last week I would make the following remarks:—Ice is not an exceptional substance, for mercuric chloride has also given experimentally the same results, and though I have not yet had the opportunity of submitting other substances to the same conditions, yet I conclude from other experiments that all the bodies which I have so far investigated, and which are of the most varied description, will also exhibit the same phenomenon. As I have not yet published my detailed results, I do not wish at present to enter more fully into the subject, but I may say that the influence of pressure in the present case is not of the same kind as that referred to by C. A. M. as occurring in the text-book named, for the following amongst other reasons. From Prof. Thomson's prediction and Sir Wm. Thomson's experiments it resulted that the melting-point of ice is lowered by pressure, and lowered in proportion to the pressure, whereas in my experiments, at any rate so far as I have at present seen, we do not vary the melting-point by diminishing the pressure, but we prevent the substance from melting at all. If the pressure be increased even but slightly above the critical pressure, the ice melts at its ordinary melting-point. The influence of pressure in this case is not one of degree varying with the amount by which the pressure is reduced. The two cases are, I consider, entirely different, and are not contradictions. Similar remarks would probably apply to paraffin and spermaceti, though these are bodies which have not come within the range of my experiments.

Firth College, Sheffield, October 6

THOS. CARNELLEY

## A Peat Bed in the Drift at Oldham

IN NATURE, vol. xxii. p. 460, there is a letter by Mr. Jas. Nield, giving an interesting description of unique, or nearly unique, appearances in the boulder clay near Oldham. It appears that this glacial deposit has one or more beds of peat, or fragments of peat, intercalated along with it at various depths, leading to the inference that the clay had been stirred up and the fragments of peat had in some manner been mixed with it. That peat bogs, or surface black peaty mould, had existed at no great distance is a conclusion forced upon us, and that the action of ice and snow, probably during a submergence, had mashed up the clay and distributed the peat amongst it. The boulder clay, and the scratched mountain sides, and the travelled fragments of rock, do not extend over the whole of England. It used to be said by geologists that the effects of a severe Arctic climate could not be detected south of a line drawn across the country from London to Bristol; by which it was inferred that all the land north of that line had been under water, subject to the influences of snow

and floating icebergs, and all the country south of it above water and clear of those influences. Since then the large granite boulder on the shore of Barnstaple Bay, estimated to weigh ten tons, has been brought more prominently under our notice by Mr. W. Pengelly (*Trans. Dev. Assoc.* vi. 211), and several others by Mr. T. M. Hall (*Id.* xi. 429), discovered by excavation. All these are travelled blocks, and probably ice-borne. Many attempts have been made by ardent and intelligent students of late years to detect proofs of glacial action further south, and even to the shores of the British Channel, but hitherto with doubtful success. There lies on the greensand of Haldon, near Exeter, and on the Blackdown Hills, stretching away towards the south-east corner of the county of Devon, a stratum of tough yellow clay full of white flints, mostly angular. About Haldon and eastward over Pitminster and Churchstanton, many white quartz rounded pebbles, foreign to the accompanying beds, are met with. Farther south, between Honiton and the sea, this stratum of flints and clay in some places is seen to be from forty to fifty feet thick, and the best section of it is in the gravel pits near the cliff on Peak Hill, on the west of Sidmouth. By some persons this deposit has been regarded as the thinned-out edge of the plastic clay formation, containing the remaining flints of the washed-out chalk, still found more perfect at Beer Head, a few miles east. Whether it was this, or whether it was a boulder clay, so called, it is well to remark that, though thickest on the flat tops of the hills, it seems to lap down over their sides, as if it had been deposited after the valleys and the elevations had come to their present conformation; and at two places at least to be visible in the valley of Sidmouth—one under the great blocks of breccia in the orchard near the brook on the Boomer or Boughmoor Estate, and the other on a subordinate hill in a grass field, at about 200 yards from Jenny Pine's Corner, walking down the new road towards Cotmaton, and on the right-hand side. Most of this latter patch of clay and flints was dug away two or three years ago to assist in forming the new road.

When engaged in making certain trenches and excavations on the top of Salcombe Hill in 1879 for archaeological purposes (see *Proceedings Soc. Antiq. Lon.* viii. 209) it appeared that the yellow clay, to the depth of two or three feet, was not so much encumbered with flints as deeper down. But whilst thus engaged, what struck me as rather strange was that numerous fragments of black peat were more or less generally but irregularly distributed through the upper two feet; and bearing in mind Mr. Nield's letter, I have in my foregoing remarks been trying to lead up to this point. The cases may not be similar, but they are worth comparing. The land on the top of the hill at this place still bears its wild growth of heath and furze, and has never been subjected to the plough or to cultivation of any sort; so that the clay has not been disturbed by the hand of man. It is too soon to say that this capping of clay and flints is of glacial origin; but some of the indications that have suggested the idea may be observed in the section in the gravel pits on Peak Hill, especially when fresh dug down. They are: (1) that no horizontal bedding is visible, as there would be if the deposit had been made in a large body of undisturbed water; (2) that, on the contrary, waving and distorted lines are sometimes very plain, one instance of which I carefully sketched and coloured in January, 1875; (3) and that the long axes of the embedded flints do not as a rule lie horizontally, as they would necessarily do if they had settled at the bottom of a sea or pond, just as an egg will lie on its side, and not on its point, but they are distributed through the soft mass at all angles, as raisins lie in a pudding that has been kneaded up together.

My object in this communication has been merely to compare the case of the peat mixed with the clay on Salcombe Hill with the somewhat similar case occurring near Oldham.

P. O. HUTCHINSON

Old Chancel, Sidmouth, Devon, October 4

IN NATURE, vol. xxii. p. 511, I find a letter from Mr. G. H. Morton, in which he expresses an opinion contrary to that expressed by me (vol. xxii. p. 460), as to the age of the "peat bed in the drift of Oldham." The section therein alluded to is fairly described by him, but I am surprised that he should for an instant entertain the belief that the clay "has simply slipped down off the sand on to the surface of the peat at a lower level." Had the clay slipped down we ought to have been able to see some indications of the conjectured displacement. Let me say, however, that during my repeated visits to the place and my examinations of the section I have utterly failed to perceive any

trace of such indications, and, moreover, I do not remember that one person out of some scores who have in presence of the section pointed out to me the slightest appearance of disturbance. There is not a broken or crumpled line in the whole section.

The peat bed, and indeed the whole of the section, is now, I am sorry to say, covered up; but in and about Oldham we have a large area covered by what I believe to be typical beds of the "Middle" and the bottom of the Upper Drift—alternations of gravel, pebbles, fine and coarse sand, the latter showing lines of "current bedding," and occasionally clay with boulders—in which many similar sections, but wanting in the peat, of course, may be seen, and in which the position and surroundings of the beds quite forbid the possibility of "slipping." The idea of the upper clay "having been excavated and thrown down" is, I think, too improbable to be seriously entertained, seeing that the surface-soil and subsoil on the top of it are of the usual thickness common to the neighbourhood.

The "blue silt" alluded to by Mr. Morton as giving strength to his suspicions, I can assure him is one of the supports upon which I rest my opinion that there has been no disturbance. Do I understand him to mean that the silt is the result of the washings of some passing stream? If so, let me recommend him to visit the railway cutting across the large peat bog a few miles from here, and known as the "Ashton Moss," where he will find, at the bottom of a bed of recent peat, of from two to three yards in thickness, a thicker, but in every other respect a similar band of blue silt, upon which the peat rests throughout the length of the whole cutting. This silt seems to have its equivalent in the "floor clay" which accompanies our seams of coal. I believe that the removal of so much of the peat bed and drift deposits from the face of the excavation as has already taken place has served all the purposes of the "few hours digging at a right angle to the present exposure," suggested by Mr. Morton.

Perhaps a more complete acquaintance with the Oldham drift beds would bring Mr. Morton nearer to my way of thinking. I shall be glad to see him here again, and to assist him in making a wider, and more thorough examination of them.

29, Radclyffe Street, Oldham, October 7 JAMES NIELD

#### Temperature of the Breath

MR. McNALLY has, it appears to me, missed the point of my observations on this subject.

His own experiments, though they show a temperature obtained by breathing on a thermometer through silk, wool, and linen, considerably above the accepted temperature of the breath, are by no means an exact repetition of mine. He only breathed through four folds of the material for three minutes. I breathed through a much greater amount of material and for a longer time, viz., twenty to thirty folds tightly encircling the thermometer bulb for five minutes.

The temperatures I obtained were very much higher than those observed by your correspondent. Thus on a warm summer day the temperature obtained on rising in the morning before dressing and before eating was 106°. In the afternoon, after playing a game of golf, when returning home by rail with all the windows open, the temperature observed was 107°. The same day, after dinner (without alcoholic stimulants), the thermometer rose to 108° when breathed on in the way described. The temperature of the air that day averaged 70°. Since then I have not obtained a higher temperature than 107° 5.

These temperatures were obtained by breathing through a silk pocket-handkerchief tightly rolled round the thermometer, but I have obtained temperatures nearly as high when the thermometer was wrapped up in cotton or woollen stuff.

Mr. McNally asserts that the explanation suggested by my friend that the high temperature thus obtained was owing to the heat evolved by the condensation of the aqueous vapour contained in the breath is "undoubtedly correct," but he gives no answer to the obvious objection to this explanation, viz., that if the real temperature of the breath be, as stated in physiological works, 95° to 97°, condensation of the aqueous vapour in it would only take place as long as the material through which it is propelled was of lower temperature than the breath. When the material attained a higher temperature than 97° the aqueous vapour, in place of being condensed, and thus evolving heat, would be still further evaporated, and hence be a cause of reduction of temperature.

The fact that woollen clothing prevents chill after exercise has

no bearing on the subject of the high temperatures obtained by breathing through woven material on the bulb of a thermometer, for no one has yet observed that woollen clothing will develop a heat greater than that of the body it covers, viz., 98°·5.

The hygroscopic properties of different materials afford no explanation of the phenomena, for the power of materials to imbibite moisture will not account for an increase of their temperature by breathing through them.

My speculations may be right or wrong; Mr. McNally has not shown them to be either. My facts are not the less true from being incompatible with "ascertained physiological truths," for ascertained physiological truths are only true so long as they are not controverted by other ascertained physiological truths.

My experiments show that the temperature obtained by breathing on the thermometer in the manner described is higher when less caloric is abstracted from the surface of the body, lower when the surface of the body is losing more caloric. Thus on a warm summer day my breath raised the thermometer to 108°, whereas to-day (a cold wet day) it only raised the thermometer up to 103°. Does not this seem to show that respiration is a means of getting rid of the superfluous caloric generated in the body, and that when this excess of caloric cannot be got rid of by the skin it passes off by the breath? R. E. DUDGON

October 9

### Selenium

As the only chance of being able to transmit images of reflection through a conducting wire, in the way sound is repeated to a distance by telephone, appears to lie in the preparation of a fairly transparent sheet of metallic selenium; it may tend to advance the subject if the difficulties experienced in dealing with this substance are mentioned.

Selenium in its vitreous condition melts about 220° Fahrenheit, and can be drawn out between mica plates over a lamp, to a thin transparent red film. But heated for some time it turns black and granular, apparently absorbing hydrogen, then melts only at 423° F., and is brittle and intractable. Unfortunately it is only in this crystalline state that its power of conducting electricity appears, and varies with the light under which the selenium is placed.

Prepared in the mass, electrically conducting selenium is as compact as the hardest gas carbon, with the shiny appearance and surface of graphite. How to reduce such a substance to any degree of transparency is perplexing. By reducing it to fine powder, and subjecting the black selenium to severe hydraulic pressure between hot polished steel plates, the desired effect might be produced. Selenium also dissolves freely in chloride of selenium,  $Se_2Cl_2$ , and precipitates slowly in a botryoidal mass of black selenium. It also separates in the crystalline form from concentrated solutions of selenide of potassium or sodium.

There is some uncertainty as to whether a transparent sheet could be more easily obtained by the method of precipitation, than by mere mechanical treatment. But the investigation is one that requires to be carried out with the aid of a fully equipped laboratory, and is beyond the power of an ordinary experimentalist.

To devise a successful mode of making a black substance like graphite at all translucent, requires a distinct understanding of the reason why bodies are opaque. Something more than an explanation in general terms is needed before camera pictures can be resolved into electric currents, and again integrated upon a receiving plate.

Perhaps some of the readers of NATURE may be able to suggest a method of dealing with selenium that will produce thin transparent sheets capable of conducting electricity.

London, October 16

A. T. F.

### Dynastes Hercules

THE reviewer of Ober's "Camps in the Caribbees" (NATURE, vol. xxii. p. 216) appears to doubt the story of the habits of the large Hercules beetle, *Dynastes hercules*, given by Ober on the authority of his guide. It is nevertheless perfectly true, and I have myself witnessed the occurrence twice in this neighbourhood, where the beetle is not uncommon. In the first instance I noticed it on a branch of *Ochroma lasopus*, and the second time on a species of *Bambax*, both very soft-wooded trees. The branches in each case were about three-quarters of an inch in diameter, half an inch being formed by the wood. In both cases I saw the performance of the animal most distinctly, just as described by

Ober's guide, and I took not only a piece of the severed branch with me, but secured also the second animal. The noise is not so much produced by the cutting of the branch as by the open wings passing rapidly through the air during the rotation of the beetle. I do not believe there is anything of a sexual call in the manoeuvre. The beetle wants to get at the abundant juice of the young branches. It is called in this country *aserrador*, i.e. *sawyer*. *Golefa porteri*, an allied insect of the same family as *Lamellicornes*, behaves in a similar way, but chooses of course thinner branches. A. ERNST

Caracas September 9

### What is Alrese?

IN the large *Encyclopédie* published by Diderot and d'Alembert, vol. xii. p. 224 (edit. in folio) there is mentioned amongst the substances used for poisoning water to catch the fish, *l'herbe qu'on appelle l'ALRESE*. Littré has no such word, nor anything like it, nor indeed any other lexicographer I am able to consult here. I should be much obliged for any information on this name, or the plant referred to. A. ERNST

Caracas, September 9

### Rainfall of Sierra Leone

AS I believe there is little account taken of this climate at home, and as perhaps it might interest you, I send you an account of one day's rainfall this month, which is an excessive amount even for Freetown, and equal to one-third the whole year's rainfall for Dublin, I believe:—

Rainfall registered in the Colonial Hospital, Freetown, 50 feet above Sea-level

	Inches.
From 6 a.m. to 4 p.m. September 11 ... ..	6·35
From 4 p.m. to 6 a.m. September 12 ... ..	4·05
Total in 24 hours ... ..	10·4

Garrison House, Freetown,  
September 16

W. HUME HART,  
Colonial Surgeon

### An Octopus

I INCLOSE an account of an enormous octopus which was thrown on the shore at Kilkee, Co. Clare, in the last great storm. As strangers find my uncle's hand very hard to read, I have copied his letter.

Ardanoir Foynes

C. G. O'BRIEN

"Saturday, October 9, 1880

"I am sorry you were not at Kilkee when a great octopus was stranded on the side of the Duggerna reef on Thursday last. Its arms had been partially broken: there were eight of them, each as thick as a strong man's upper arm, and beneath each were two rows of suckers like cupping-glasses, more than a shilling size in circuit. When perfect, each of these arms must have been from twelve to fifteen feet long, and from the point of one arm to that of its opposite was a length of nearly thirty feet. The animal's length from the insertion of its suckers to the end of its body must have been nearly twenty feet, perhaps more. Its mouth, like a parrot's beak, was as large as two joined hands of a large man with the fingers outstretched. It weighed about 4 cwt. Its head was 1½ inch in diameter, about three feet long; its eyes of the size of the inner circuit of a breakfast-plate. A monster. The under colour that of the under side of a turbot." —(From a letter of the Rev. R. J. GABBETT.)

### SYNTHESIS OF CITRIC ACID

AS we intimated last week, another brilliant synthesis has recently been accomplished in the domain of organic chemistry. Messrs. Grimaux and Adam have succeeded in building up the characteristic acid of lemons from glycerin. Glycerin may be regarded as trihydroxypropane,  $C_3H_5(OH)_3$ , and citric acid as hydroxypropionic-tricarboxylic acid,  $C_3H_4(OH)(CO_2H)_3$ . To convert glycerin into citric acid it was therefore necessary to replace two hydroxyl groups, and one hydrogen atom, by the group  $CO_2H$  (carboxyl). This was done as follows:—By the action of hydrochloric acid on glycerin, dichlorohydrin,

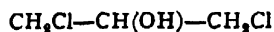

was produced; this was oxidised by potassium dichromate and sulphuric acid, to dichloracetone,

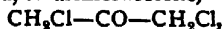

which, when acted on by concentrated hydrocyanic acid, yielded dichloracetone cyanhydrin,

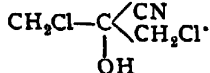

The acid corresponding to this cyanhydrin having been produced by saponifying with hydrochloric acid, the sodium salt of this acid, viz.,

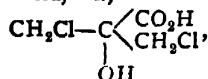

was treated with potassium cyanide, whereby a dicyanide,

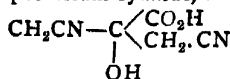

was produced. When decomposed by hydrochloric acid, this dicyanide yielded citric acid, in all respects identical with that obtained from the lemon and other fruits. The generally accepted structural formula for citric acid, viz.,

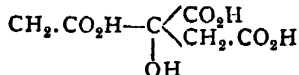

is confirmed by the synthesis of Grimaux and Adam. Glycerin may be prepared from trichlorhydrin,

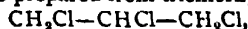

which is itself obtained by the action of chlorine in daylight on propylenic chloride,

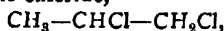

one of the products of the chlorination of propylene,  $\text{C}_3\text{H}_6$ . Finally this hydrocarbon, propylene, may be produced by passing a mixture of carbon monoxide and marsh gas through a red-hot tube. Inasmuch as carbon monoxide and marsh gas are easily built up from carbon, hydrogen, and oxygen, the synthesis of citric acid from these three elements is now an accomplished fact.

In connection with this synthesis, it is worthy of remark that in the last number of the Berlin *Berichte*, Kekulé announces that he has been working at the same subject, but by a totally different method. Kekulé's work is not sufficiently advanced for him to say positively that his method of synthesis is successful, but he feels justified in saying that very probably the process adopted by him has resulted in the formation of citric acid.

M. M. P. M.

#### PLANTS FROM LAKE NYASSA AND LAKE TANGANYIKA

MR. THOMSON, who has recently returned from the expedition of the Royal Geographical Society to Central Africa, has brought to Kew a considerable collection of plants from the plateaux round Lake Nyassa and Lake Tanganyika. The plants from an elevation of 6,000 to 8,000 feet above sea-level contain a large proportion of Cape and characteristically temperate types. Amongst the former are the well-known *Dierama* (*Sparaxis*) *pendula*, *Scilla rigidifolia*, *Buphane toxicaria* (the great poison bulb of Natal and the Transvaal), a fine *Moræa* with a long tube and bright purple flowers as large as those of *Iris fatidissima*, a *Gladiolus*, a *Pelargonium*, more than one species of *Gnidia* and *Helichrysum*, and a proteaceous shrub (probably *Faurea*, which extends to Abyssinia) with large heads of flowers. Of characteristically temperate types there are species of *Geranium*, *Rumex*, *Cerastium*, *Coelamintha*, and a *Scabiosa*, perhaps

identical with our European and English *S. Columbaria*. Upon the plateaux below 6,000 feet the vegetation assumes a sub-tropical character. Here he met with a tree-fern of the genus *Cyathea*, *Agauria salicifolia*, Hook, fil, an ericaceous shrub common to Bourbon, Madagascar, and the Cameroons, representatives of *Mimulopsis*, *Hibiscus*, *Clematis*, *Phyllanthus*, *Gerbera*, *Smithia*, *Acalypha*, *Pentas*, *Thunbergia*, *Buchnera*, *Striga*, a shrubby *Spermacoce*, a curious *Loranthus* with broad leaves and tubular flowers densely clothed with yellow hairs, *Hyppoxis villosa*, several fine *Dombeyas*, *Vernonias*, and *Combretums*, a genus of *Hedysaræa* with flowers in heads like those of the hop, and a curious broad-leaved *Euphorbia*, with very large hand-like glands to the involucre. The specimens are well selected and excellently dried. It is probable that nearly all of them are in a condition in which their botanical position can be settled, and that although upon a hasty glance there do not seem to be any strongly-marked new generic types, a good many of the species will prove new to science. The marked northern extension of the Cape flora at comparatively high elevations in Central Africa is a fact of importance. It quite supports the theory that that flora is of great antiquity, and that what exists of it at the Cape is only a survival from a period when it was probably far more extensively diffused, though perhaps less highly specialised. It is much to be desired that travellers in Central Africa would do all in their power to collect dried specimens of the vegetation of elevations above 6,000 feet.

#### GRAHAM BELL'S EXPERIMENTS IN BINAURAL AUDITION

PROF. GRAHAM BELL has published in the *American* (quarterly) *Journal of Otology* a memoir on some experiments relating to binaural audition, read by him last autumn at the session of the American Association for the Advancement of Science. Some of his observations confirm the work of previous observers, but are of additional value in affording a more systematic examination of some of the phenomena than has hitherto been attempted. The following summary of the results obtained by him will therefore be of some interest.

When we close one ear and listen to sounds through the other only, there seems to be a oneness about them, as there is about objects perceived by one eye. When both ears are employed simultaneously a sort of stereoscopic effect of audition is perceived. Sounds assume a "solidity" which was not perceptible so long as one ear alone was employed. The difference between *monaural* and *binaural* audition is especially well marked when we attempt to decide by ear the *locality* of a particular sound. Whatever power a single ear may possess of determining the direction of a source of sound, both ears are certainly much more effective for this purpose.

The following experiment, designed to produce artificially the stereophonic phenomena of binaural audition, was therefore devised by Prof. Bell while in this country in 1878. Four telephones were arranged, as in the figure. The telephones A and B in one room; C and D in another. The mouthpieces of A and B were turned away from one another like the auricles of a person's ears, and the diaphragms were about as far apart as the tympana of the two ears. The expectation was that a person holding C and D to his ears should not simply hear speech when any one was talking near A and B, but that he should be able to perceive the *direction* of the speaker's voice relatively to A and B. In fact, the listener's ears were, as it were, electrically prolonged to A and B respectively. The sensations produced were decidedly novel; but not exactly such as had been expected. Using various sources of sound—speaking, ringing a loud dinner-bell in various parts of the room, &c.—it was found that the location of the sound could be determined to a limited extent. The

general result was as follows : imagine a globe, E, F, G, H, in the interior of which are the telephones A and B ; let E and G be the two poles, and imagine the usual meridian lines and parallels of latitude. It was found as the result of the experiments that the observer at C, D could determine with tolerable accuracy the *latitude* of a sound made near A, B, but that *he had no idea whatever of its longitude*. In a later experiment two Blake transmitters were employed. They were placed back to back at about five feet from the ground in the open air. The receiving telephones were indoors, whence the speaker could be observed. The results of observation coincided with those already described. In order more closely to imitate the natural arrangement of the ears the transmitters were then set so that the diaphragms were at 45° to each other. A sound made at H here produced a feebler effect than one made at F ; and *after a few experiments* the ear seemed to be able to distinguish whether the speaker were in front of, or behind the transmitters. Unfortunately the two transmitters were not equally sensitive, and the ear had to get accustomed to the slight inequality in the intensity

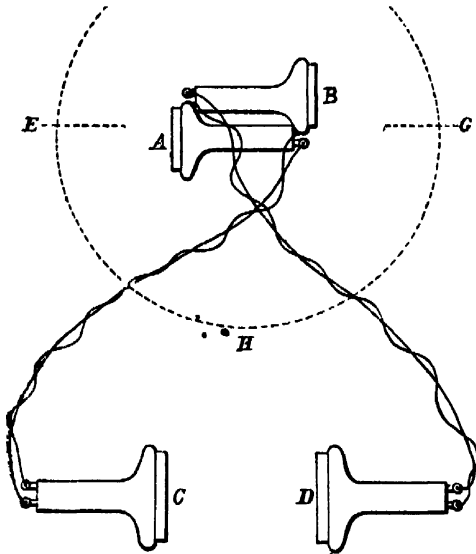

of the transmitted sounds. Prof. Bell suggests that the sensations experienced by deaf persons might be studied by persons possessed of normal hearing powers by purposely using transmitters of unequal power, or by introducing artificial resistances into the circuits.

It also occurred to Prof. Bell that the telephone might afford a means of ascertaining to what degree the human ear normally has the power of appreciating the *direction* of sound. For this purpose a number of telephones were hung up in different parts of a summer-house, and were connected with a switch-board so that an interrupted current from a rheotome in a distant place could be sent through any one at will. A person stationed at the middle of the summer-house, with his eyes closed, and holding his head perfectly still, was required to indicate the point from which the sound seemed to emanate. The indicated direction usually differed considerably from the true direction, and it was found that the observer soon came to recognise each individual telephone by its particular timbre. To obviate this a single telephone was

nevertheless a long series of experiments were carried out, and their results carefully set down in a series of eight tables. Five young men were employed as observers, the power of each of their ears being previously ascertained by an independent test. The experiments thus carefully made and tabulated are still too few, and in Prof. Bell's opinion too imperfect in several respects, to admit of accurate generalisation ; but some deductions are unmistakable. The tables establish beyond dispute (a) that the perception of the direction of a source of sound is less perfect by a single ear than by both ears ; (b) they disprove the idea that direction cannot be appreciated by monaural observation ; (c) they show that the direction of sound is more accurately defined as it approximates to the axial line of the ears [this entirely negatives Steinhäuser's theory of binaural audition] ; (d) that the indications are proportionately at fault as the true source is in any other direction, the angular error sometimes amounting to 180° when the source is 90° from the axial line ! (e) the perception of direction is absolutely unreliable when the source of sound is at the nadir with respect to the observer. It should however be remembered that in experiments thus made in an apartment reflexion of the sound comes into play, and partially vitiates any general deductions by introducing slight though unknown complications.

The method adopted by Prof. Bell to measure the relative hearing power of the separate ears was as follows :—Two flat coils of wire were placed upon a long wooden rod which passed through their centres. One of these coils, the "primary," was a fixture, and was put in circuit with a battery and a vibrating interrupter in a distant room. The other coil, the "secondary," was joined up to a telephone. When placed close to the primary the induced current produced loud sounds ; the observer, holding the telephone to his ear, was then directed to slide the secondary coil away from the primary until he ceased to hear anything. The distance between the two coils was then measured. It will be seen that this arrangement anticipated to some extent the sonometer of Prof. Hughes.

We venture to hope that Prof. Bell will continue these interesting researches in this promising, and hitherto almost unexplored field. S. P. T.

THE GEOLOGY OF THE LIBYAN DESERT<sup>1</sup>

IN his very interesting anniversary address before the Academy of Sciences in Munich Dr. Zittel has brought together all the known facts concerning the geology of the northern districts of Africa, in a manner which is calculated to render the greatest service to his fellow-workers in science. The address, with its accompanying map and numerous explanatory notes, constitutes indeed by far the best monograph on North African geology which has yet appeared. The author not only reviews the works of the various travellers who have furnished materials bearing upon the question, from Browne and Hornemann to Fraas, Röhlf's, and Schweinfurth, but what is of far more importance, gives the results of his own accurate study of the rocks and fossils collected and brought home by recent investigators. The general results arrived at by Dr. Zittel are as follows.

To the east of the Nile rises a mountain range composed of highly crystalline rocks—granite, diorite, and hornblende gneiss. The peaks of this range rise to heights varying from 5,000 to 8,000 feet.

The oldest stratified rocks of the district appear to be of crystalline age. Lying upon the axis of crystalline rocks, and south of the Great Desert, i

Ueber den geologischen Bau der libyschen Wüste. (Festrede anlässlich der Sitzung der k. b. Akademie der Wissenschaften zu München am 1. März 1880.) Von Dr. Zittel.

formation. Concerning the age of these sandstone rocks a considerable amount of controversy has taken place in recent years, and they have been referred by different authors to the Triassic, the Jurassic, and the Neocomian systems. The fossils found by Overweg and others, however, seem to leave no room for doubt that the real age of the Nubian sandstone is the Cenomanian, or lower portion of the Upper Cretaceous.

Lying upon these sandstones are found great deposits over 600 feet in thickness, consisting of dark green and grey, finely-laminated marls in their lower, and of white, earthy limestones in their upper part. These rocks contain many characteristic Upper Cretaceous fossils, such as *Ananchytes avatus*, *Ventriculites*, and *Rudistes*. These Upper Cretaceous rocks have been found not only forming the whole southern margin of the Desert, but also rising above the sandy wastes in the hilly masses which form the oases.

The deposits which underlie the greater part of the Sahara appear to be of Tertiary age and referable to the Nummulitic and Miocene periods. There would seem to be no sharp line of demarcation between the Cretaceous and the Tertiary deposits in this area, and in this, as in many other particulars, which are pointed out by Prof. Zittel, the North African formations of these periods remind us of those of the Rocky-Mountain regions of North America.

The older Tertiary deposits of Northern Africa are divided by Dr. Zittel into two members, which he designates the "Lybysche Stufe" and the "Mokattam Stufe." In the lowest of these (the Lybysche Stufe) a widely-spread and very characteristic fossil is the Belemnite-like *Graphularia desertorum*, Zitt.; many nummulites and other well-marked Eocene fossils also occur.

There appears to be still some doubt as to whether the "Mokattam Stufe" of Dr. Zittel should be classed as Eocene or Oligocene.

In the northern part of the area various freshwater and marine deposits are found which are now referred to the Miocene. No less than sixty-eight forms of marine mollusca have been determined by Dr. Theodor Fuchs as occurring in these beds, and he is led to regard them as indicating a horizon not far removed from that of the Leitha-kalke of the Vienna basin.

The several formations described succeed one another from south to north, this being the direction of the dip of the beds; their relations to one another are well illustrated in the map and sections which accompany the work.

In the midst of the Beharieh oasis a mass of igneous rock is found rising through the midst of the Upper Cretaceous limestones. This rock has been studied by Prof. Zirkel of Leipzig, who pronounces it to be an ordinary plagioclase basalt, very similar in character to that of the Giant's Causeway in Ireland.

Over the whole of these formations the great mass of sands of the Desert is spread, and rises in places into hills several hundreds of feet in height.

In reading this address we cannot but feel that Dr. Zirkel has made admirable use of the collections which Dr. Schweinfurth and others have placed in the museum at Munich; and that by their careful study he has been enabled to clear up many of the difficulties which every one must have felt who has endeavoured to understand the geological structure of the great African continent.

#### PHYSICS WITHOUT APPARATUS<sup>1</sup> VIII.

IN the preceding articles of this series we have shown how in every department of physics a large number of instructive experiments may be performed without the aid of any more formal apparatus than the usual domestic

<sup>1</sup> Continued from p. 538.

appliances of an ordinary household. There remain to be described a few miscellaneous experiments, before concluding the subject.



FIG. 25.

Many years ago Prof. Faraday observed that if two pieces of ice are pressed against one another they freeze



FIG. 26.

firmly together at the point of contact, even though they may themselves be thawing at the surface. To this



peculiar property of ice he gave the name of *regelation*. The true explanation of this property was not at once arrived at. From theoretical considerations Prof. James Thomson was led to predict that the application of pressure to ice would lower the temperature of its melting-

a copper wire a heavy weight. It is found that in the course of a few hours the weight will have dragged the wire through the ice, as if it were no harder than a piece of cheese, yet that the ice has healed up as fast as the wire cut into it, and that it is still one solid block. This extraordinary fact can be accounted for in the following way. In the neighbourhood of the wire where it passes through the ice the pressures are not uniform, for just below the wire the portions of the ice are under pressure, owing to the pull of the heavy weight, while immediately above the wire the ice is subjected to a stress tending to draw the particles asunder, or, in other words, it is subjected to a *pull* or "negative pressure." The pressure on the ice under the wire lowers its melting-point, and causes very small quantities of it to melt; these liquid portions immediately are squeezed out; and find their way round the wire to the space above it, where, the pressure being reduced, they again freeze hard.

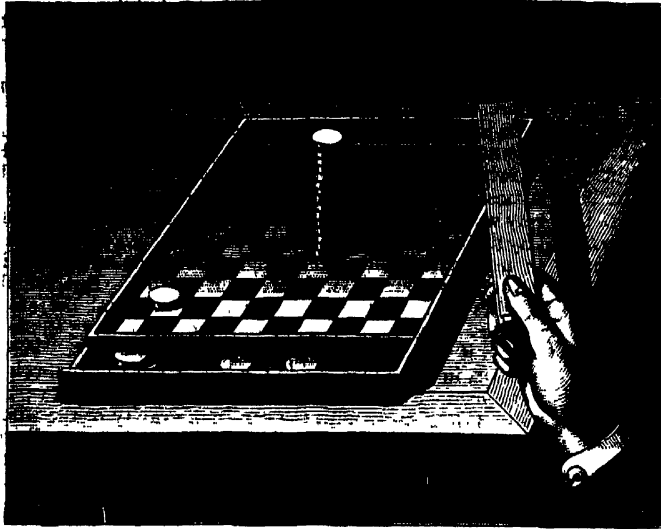

FIG. 27.

point, and cause it to melt even though as cold as, or colder than, the usual "freezing-point." This prediction was afterwards verified by Sir William Thomson, who melted ice by subjecting it to great pressure. More

one-half of its original volume it would be necessary to plunge the wine-glass about thirty-four feet deep into water; for to halve the volume of the air inside we must double the external pressure. The pressure of the air is already

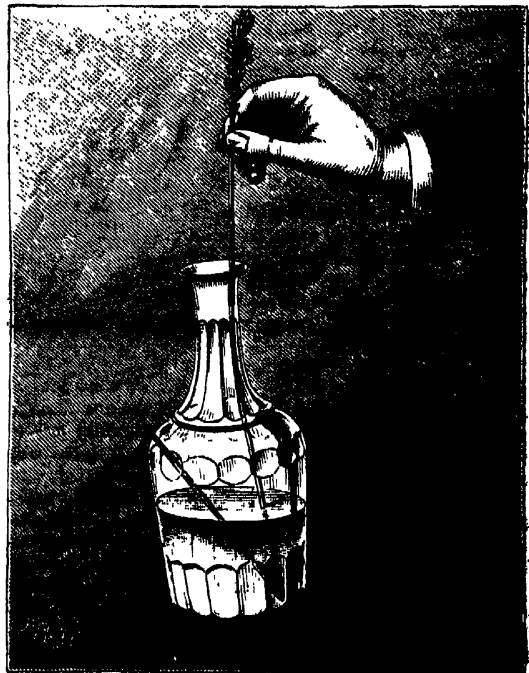

FIG. 29.

recently Mr. James Bottomley has devised a very beautiful experiment on regelation which requires no special apparatus for its performance. A block of ice (Fig. 25) is placed upon a suitable support, and over it is hung by

about fifteen pounds on every square inch, and to double that pressure requires the additional weight of thirty-four feet of superincumbent water, for that is the weight which the wire itself presses with a force of fifteen

pounds on each square inch of surface. M. Tissandier, in describing this simple experiment in the pages of *La Nature*, has suggested that a few imprisoned flies or other insects may without any cruelty or hurt do duty as divers within the miniature diving-bell, and afford proof that life can go on in the inclosed air even though below the surface of water.

In speaking in a former article of the subject of *inertia* we mentioned the following familiar trick: a number of the round wooden "men" used in playing the game of draughts are piled up in a column one upon another. If the lowest one of the pile is dextrously hit with the edge of a paper-knife or other suitable article it may be knocked away from under the others without overthrowing the others. Fig. 27 shows how the experiment is arranged, the narrow slip of wood which serves as the lid of the box being here used as the weapon. Beginners in science must not mistake the meaning of the term *inertia* as applied to matter. Matter is not in itself lazy or inert. But it possesses the property of *mass*, and to set mass in motion requires the expenditure of *energy*. If we skilfully



FIG. 30.

spend the energy of the rapid blow upon the one draughts-man, it is knocked away before there is time for any considerable part of the energy to be imparted to the others that are piled upon it.

Another simple experiment, depending partly upon the inertia of matter and partly upon elasticity, is often shown as an after-dinner trick. Upon a linen tablecloth is placed a threepenny-piece between two pennies or other larger and thicker coins. Over this an empty wine-glass is placed, and the puzzle is how to get out the smaller coin without touching the glass. The very simple operation of scratching with the finger-nail upon the cloth, as shown in Fig. 28, suffices to accomplish the trick, for the little coin is seen to advance gently towards the finger until it has moved completely away from under the glass. The fibres of the linen cloth are elastic; when you scratch with your finger-nail they are drawn gently forward until the force of their elasticity becomes too great and they fly back, to be once more drawn forward, again to slip back,

and so on. While the fibres are drawn forward slowly, they drag the coin with them to a minute distance. But when the slip occurs and they fly backward, they do so very rapidly, and slip back under the coin before there is time for the energy of their movement to be imparted to the coin to set it in motion. So the coin is gradually carried forward over the surface of the cloth.

We will next give a simple experiment which illustrates the principle that a substance which is very weak in one direction may be very strong in another, the "strength" of the material (that is to say, the resistance it offers before it will break) depending on the way in which a force is applied to it. It is possible to lift a decanter full of water by means of a single straw. To do this the straw must be bent as Fig. 29 shows, so that the weight comes longitudinally upon the straw. The straw is a very weak thing if it has to resist a force applied laterally. Lay a single straw horizontally, so that the two ends are supported, and then hang weights on to the middle of it: a very few ounces will break it across. But let the weights be fixed to one end of the straw, and the straw itself be hung downwards so that the pull is exerted along it, and it will support one or two pounds at least. When bent, as in the figure inside the bottle, most of the weight is applied as a thrust against the end of the straw; the bottle tilts slightly until the centre of gravity of the whole is below the point from which it hangs between finger and thumb; but in this position the sideway thrust against the middle of the straw is very small, and the material is strong enough to stand the strain to which it is subjected lengthways.

Lastly we offer an illustration (Fig. 30) of an experiment known to every schoolboy. A can or jar containing water may be whirled round the head without spilling a single drop, provided the motion be sufficiently rapid. When a moving body is subjected to the constraining action of a force which acts, like the pull of a string held in the hand, towards a fixed centre, the result is a motion around the centre of force. Were it not for the constraining force the moving body would fly away at a tangent; and to the reaction exerted successively in all directions away from the centre the name "centrifugal force" was formerly given. The water in the can, being heavy, is also subjected to this so-called centrifugal force as it moves around the fixed centre, and hence it does not fall out of the can while passing through the inverted position in the air if its speed be sufficiently accelerated.

#### THE GERMINATION OF *WELWITSCHIA MIRABILIS*

HAVING been supplied, through the kindness of the Director of Kew Gardens, with young seedlings of *Welwitschia mirabilis*, I have been enabled to draw some fresh conclusions as to the homology of the large leaf structures, which have hitherto been described as persistent cotyledons. It is true this description has been confessedly provisional, since the process of germination has not hitherto been traced.

The seeds germinate in a manner corresponding in the main with that described by Strasburger for *Ephedra campylopada* ("Conif. und Gnet.," p. 320). The radicle first breaks through the testa, the point of perforation depending apparently upon the position of the seed during germination. The cotyledons also break through the testa, but at a different point from the radicle. The cotyledons are two in number; in one case I observed three, one being smaller than the others. They free themselves entirely from the seed, and expand to a length of 1 inch to 1½ inch, with a breadth of ½ inch, or rather more; it is possible, however, that they may by growth attain a larger size. The cotyledons when expanded are green, though while still in the seed they are yellow.

Their form is linear, margin entire, glabrous. Each has two main fibro-vascular bundles parallel to one another, and two or more lateral ones, also parallel to these; they all give off lateral bundles which anastomose freely. The hypocotyledonary portion of the stem extends to a length of about one to two inches; it is compressed in a plane parallel to that of the cotyledons, and is slightly swollen immediately below the point of junction with them.

Though the cotyledons are completely withdrawn from the seed at an early stage, a physiological connection is kept up between the seedling and the endosperm by a peculiar structure, produced apparently by a lateral swelling of the hypocotyledonary portion of the stem. The time and manner of its development I have not yet been able to ascertain, but in one seedling of twelve days it was found lying parallel to the cotyledons, these being still inclosed in the endosperm, whereas in the mature seeds I have not been able as yet to see any trace of it.

This structure remains in close connection with the endosperm, and is probably useful in transferring the nutritive substances from it to the embryo after the cotyledons have been withdrawn. As far as I can see at present, this lateral structure is produced merely by a process of lateral extension of tissues. The fibro-vascular bundles curve slightly into the protrusion, but I have observed no special modification of the tissues further than a lateral extension. If this be the case, it may be considered morphologically as an emergence.

It has been already observed by Strasburger ("Angiospermen und Gymnospermen," p. 155, Plate xxii., Figs. 90, 91, 93) that in the ripe embryo of *Welwitschia* an apical papilla is to be seen between the cotyledons; but his observations were conducted only on embryos in mature but ungerminated seeds; and here, as in other members of the group, the plumule does not develop beyond this condition of a mere papilla till germination begins. In the young seedlings (about six weeks old) which I have had the opportunity of observing, the plumule consists of two leaves, decussating with the cotyledons, and between these there is an apical papilla. In the most advanced specimens now growing at Kew these leaves of the plumule are about one-sixteenth of an inch in length, but no further development of leaves is at present to be seen.

These observations suggested a comparison with the youngest specimens preserved in the Kew collections: the result is the discovery of evident traces of the bases of leaf-structures below the well-known pair of large leaves, in the form of ragged ends of fibro-vascular bundles, which run directly into the tissues of the stem. These earlier leaves appear to have been at right angles to those of the existing leaves of the plant, and we may with good reason conjecture that they were the cotyledons. Full proof of this will be afforded if the plants at present growing at Kew remain healthy. If this conjecture be true the pair of large perennial leaves are the first and only pair of leaves developed from the plumule, and not cotyledons, as they have been hitherto assumed to be.

Other interesting points in the germination of this plant, together with a description of its minute histology, must be deferred till a later notice. This I hope to be able to publish with illustrations in an early number of the *Quarterly Journal of Microscopical Science*.

F. ORPEN BOWER

The Jodrell Laboratory, Royal Gardens, Kew,  
October 9

### NOTES

IN the second of a series of articles in the *Pall Mall Gazette* "On Vain Discourse," in the quaint and leisurely style of our remote forefathers, the writer speaks of "the talker who thinketh

he hath a vocation to popularise science, not as some of our masters come forth to stir up interest in these matters, but from folly and emptiness." He then proceeds to define him:—"He is a great breeder of vain discourses, for he deemeth that the strong meat of knowledge will sit ill on dainty stomachs, and so sets himself to save them the digesting. He watereth first to the consistency of a small fact to the page, and sweeteneth with many a line of poetry; and if there be a tough morsel of reasoning or a sharp fragment of logical defining, that he carefully throweth aside, 'et pondera rerum minutissimis verbis frangit.' For seasoning there are divers sorts of lights or colours or smells to wonder at, and pictures and tales, and praise of the wonderful nineteenth century, and of science and of such as study it. And so there is made a thin and limpid pabulum, or *extractum scientia dilutum*, which will not harm the delicatest, nor indeed do them any good, though it be sweet to the taste and pleasant to the eyes, and have the savour of wisdom. For knowledge that is worthy of being attained needeth faithful striving and endeavour, and skill cometh not but by assiduity in act and exercise—*χαλεπὰ τὰ καλά*." The lecture season is now beginning, and it would be well that those who attend science lectures should learn to distinguish between the true and the false, and this they can easily do by applying the test given by the *Pall Mall*. The spread of efficient education in science will either extinguish the popular lecture or greatly alter its character. We are glad to see the growth of outside opinion on the subject, as may be inferred from the article alluded to.

WE regret to record the death of Dr. E. J. Sparks, F.R.C.P., of Mentone, which occurred at Crewkerne on the 11th instant. Dr. Sparks has been in failing health for several years, but he is one of those striking instances of what work can be done by an active mind in spite of physical weakness. He was well known as a constant contributor to the *Medical Times*, in which appeared the series of letters on the climate of the Riviera, which were afterwards developed into his excellent book on the Health-Resorts of the Riviera. The preparation of this work occupied the best portion of Dr. Sparks' later years, and it is only three months since he revisited several of the less frequented places on the Eastern Riviera for the sake of a second edition. The book is a truly scientific work. Statistics relating to climate and the various diseases for which the Riviera has been recommended have been collected and tabulated with the greatest diligence and care; and the experience of observers, both lay and medical, as to the beneficial influence of the climate is given with the greatest candour. Besides this work, Dr. Sparks published a few years ago a translation of Dr. King's "Therapeutics," the value of which was greatly enhanced by the introduction of a quantity of new matter carefully collected together from medical periodicals. It was a work of no small labour, necessitating as it did the transformation of all quantitative relations from the German into those employed in the English and American Pharmacopœias. It received on the other side of the Atlantic prompt appreciation in a manner both hurtful and complimentary. Before it could be reprinted from the stereotype plates sent over for the purpose, a pirated fac-simile edition was produced by a publisher who has hitherto forgotten to send a cheque. He brought to his medical practice an unusually thorough knowledge of the science of his profession, and a high-minded devotion to the welfare of his patients which quickly secured the confidence of all who consulted him. In friendship he was staunch, loyal, and self-sacrificing, and his loss will be long felt by a wide circle of friends.

THE following are among the scientific and geographical publications announced for the present season:—By Mr. Murray: "Japan; its History, Traditions, and Religions, with the

Narrative of a Visit in 1872," by Sir E. J. Reed, K.C.B., M.P.; "Unbeaten Tracks in Japan," by Isabella Bird (these works are just published); "Personal Life of David Livingstone," by Dr. W. G. Blackie; "A Pilgrimage to Nejd," by Lady Anne Blunt; "The Power of Movement in Plants," by Charles Darwin, assisted by Francis Darwin; "The Cat; an Introduction to the Study of Back-boned Animals," by St. George Mivart; "Siberia in Europe, a Naturalist's Visit to the Valley of the Petchora," by Henry Seebohm; "The Gardens of the Sun: a Naturalist's Journal on the Mountains and in the Forests and Swamps of Borneo and the Sulu Archipelago," by F. W. Burbidge. Messrs. Allen and Co. announce: "The Expiring Continent; a Narrative of Travel in Senegambia," by A. W. Mitchelson; "A Dictionary of Ethnological and Philological Geography," by Dr. R. G. Latham; "Incidents of a Journey through Nubia to Darfur," by Sydney Ensor, C.E. Among Messrs. Crosby, Lockwood, and Co.'s announcements are: "The Fields of Great Britain; a Text-Book of Agriculture," by Hugh Clements; "A Rudimentary Treatise on Coal and Coal-Mining," by Warrington W. Smyth, F.R.S. Messrs. Sampson Low and Co. announce: "New Guinea," by L. M. D'Albertis; "Seven Years in South Africa," by Dr. Holub. Messrs. Longmans promise the second series of Helmholtz's "Popular Lectures on Scientific Subjects," translated by Dr. E. Atkinson. Messrs. Chatto and Windus: "A Simple Treatise on Heat," by W. M. Williams. Macmillan and Co.: "Island Life," by A. R. Wallace; "A Visit to Wazan," by L. S. Watson; "Voyage of the *Vega*," by A. E. Nordenskjöld; "Text-Book of Geology," by Prof. Geikie; "Ideal Chemistry," by Sir Benjamin Brodie, Bart.; "A Treatise on Organic Chemistry," by Professors Roscoe and Schorlemmer; vol. ii. of Mr. F. M. Balfour's "Treatise on Comparative Embryology"; "Anthropology," by Dr. E. B. Tylor; "Mathematical Papers," by the late Prof. Clifford; "History of the Steam Engine," by R. L. Galloway.

THE inauguration of the Paris Popular Observatory took place at the Trocadéro Palace on October 11, on the second terrace of the Eastern Tower. Four telescopes—three reflectors and a refractor, have been placed at the disposal of the public. No fee is taken from the visitors, who have only to make application to the Popular Observatory Office, Trocadéro, and register their names. A series of lectures on practical observations will soon begin. A room is also reserved for microscopical observations, which will be opened during the daytime.

THE Sheffield Public Museum boasts of an equatorially mounted telescope which the public are permitted to use under certain restrictions and under the direction of Mr. E. Howarth, the curator.

M. HERVÉ-MANGON, the new director of the Conservatoire des Arts et Métiers, gave yesterday a great dinner in honour of Mr. Graham Bell, the inventor of the photophone, which was exhibited and tried in that establishment.

THE Calisaya bark plants cultivated in Jamaica appear to have been replaced by an inferior hybrid between true *Cinchona Calisaya* and *C. succirubra*. In order to remedy this state of things Mr. J. E. Howard, F.R.S., the well-known quinologist, liberally placed cuttings from his authentic plant of *Cinchona Ledgeriana* at the disposal of the Royal Gardens, Kew. Three healthy plants raised from this source have lately reached Jamaica, besides others which have been sent to Ceylon.

*Camoensia maxima*, the most striking leguminous plant known, has flowered for the first time in cultivation in the Botanic Garden, Trinidad, to which it was sent two years ago from Kew. Welwitsch found it abundantly in the forests of Angola. The flowers are nearly a foot long, with a reddish calyx and cream-coloured petals with a golden border. The standard is 3 4 in.

broad, which gives some idea of the scale of the other parts. There are living plants also at Kew, but at present it has shown no indication of flowering under glass.

A CORRESPONDENT states that when he was a schoolboy at Hamburg, male crickets (species not indicated) were sold there in cages made of four playing-cards, and at the rate of a penny a-piece.

ANOTHER correspondent states that the electric lamps illuminating a large concert-room in the Champs Elysées at Paris, a year or two ago, were extremely attractive to insects of various orders. Who knows that the Thames Embankment may not become the nightly resort of members of the Entomological Society?

THE Committee of the Topographical Society of London, which has been formed for the purpose of collecting and publishing maps, views, and other materials for the history of London, have made arrangements for the holding of the inaugural meeting of the Society on Thursday, the 28th inst., at 4 o'clock. The Lord Mayor has granted the use of the Long Parlour at the Mansion House, and will preside on the occasion. Cards for the meeting may be obtained from Mr. Henry B. Wheatley, F.S.A., 18, John Street, Adelphi, W.C.

WE are glad to see a new edition of the late Sir J. W. Lubbock's Star Maps, under the title of "The Stars in Six Maps on the Gnomonic Projection," with explanatory notes by Mr. James Glaisher, F.R.S. Letts, Son, and Co. are the publishers.

IT is proposed that an International balloon race should take place at Paris on October 31. Active steps are being taken, and the necessary authorisation will be procured without difficulty from the public authorities, but an obstacle of a quite unexpected nature remains to be solved. For motives, which it is very difficult to determine, the Parisian Company who monopolise the gas, and sell it at the enormous price of three-pence per cubic metre, refuse to dispose of the commodity to aeronauts. As no provision in the charter has been made for the right of inflating balloons, it remains to be seen whether or not the gas monopolists will persist in their refusal.

M. SADI CARNOT, the French Minister of Public Works, has appointed a Commission to explore the antiquities of the Regency of Tunis, and determine what works could be executed with advantage in a country of which the welfare is of such importance for the good of the largest French dependency.

THE *Pester Lloyd* gives a detailed account of the earthquake which seems to have been felt generally all over Transylvania on the night between the 3rd and 4th inst. From about 7 o'clock in the evening rumbling noises were heard throughout the night, especially in the hilly districts. About 6.15 a.m. a shock was felt which lasted a couple of seconds, and the shock was repeated, in some places twice, in others as often as ten times. Doors were opened and shut, windows rattled, bells were rung. In several places a movement of the ground was felt, in a direction from north-west to south-east; in some places this movement lasted as long as ten seconds. In the neighbourhood of Tövis a small railway-station building was overthrown. At Felvinez the shocks were very severe, lasting fully two minutes. Several public buildings had rents in the walls, and nearly the whole of the ceiling of the Reformed Church fell. At Bistritz the people were so alarmed that they rushed from their beds into the streets and open places. In general the disturbance was greater in the western portion of the province.

AN interesting "Note on the Distribution of some of the more important Trees of British Columbia" has been contributed by Mr. George M. Dawson to a recent number of the *Canadian*

*Naturalist.* In a brief review of the general characters of the vegetation of the country the peculiarities in distribution are pointed out. The arrangement of the trees referred to is not based on any scientific principle, the Coniferæ being "placed first, as having the greatest importance both from an economic point of view and from the vast extent of country which they cover almost to the exclusion of other trees." Considering the variety of well-known timber trees to be found in British Columbia one is scarcely prepared to find it stated, with regard to the Douglas Fir (*Pseudotsuga Douglasii* or *Abies Douglasii*), that it is the "most important timber tree of British Columbia, and the only one of which the wood has yet become an article of export on a large scale." The best grown specimens of this noble tree are stated to be found near the coast in proximity to the waters of the many bays and inlets which indent it. In these situations the tree frequently exceeds eight feet in diameter at some considerable height from the ground, the height of the tree itself ranging from 200 to over 300 feet. "The wood varies considerably in appearance and strength according to its locality of growth and other circumstances. It is admirably adapted for all ordinary purposes of construction, and of late has obtained favourable notice in shipbuilding, remaining sound in water for a long time. For spars and masts it is unsurpassed, both as to strength, straightness, and length. Masts for export are usually hewn to octagonal shape from 20 to 32 inches in diameter by 120 feet long. Yards are generally hewn out from 12 to 24 inches in diameter and 50 to 102 feet long. Masts and spars are generally sent to Great Britain; other forms of timber to South America, Australia, India, China, and the Sandwich Islands. Of the *Thuja gigantea*, which in favourable situations on the coast reaches a height of 100 to 150 feet, the pale yellowish or reddish wood is stated to be very durable, though not extensively used except for shingles. The large and elegant canoes of the Indians are made of the hollowed trunks, and the fibre of the inner bark is used for ropes and cordage, as well as for paper-making and other purposes. One of the most remarkable uses for a wood is referred to under *Pinus contorta*, where it is said that the cambium layer contains much sugar, and for that reason it is eaten by the natives in the spring of the year, and in some instances large quantities of it are collected and dried for winter use.

The *Boston Herald* gives the following account of an American experiment made on September 2:—"A novel exhibition of powerful electric lights was made last evening in the vicinity of the Sea Foam-house, Nantucket Beach, and the display was witnessed by quite a crowd of interested spectators. The Northern Electric Light Company have erected three wooden towers, each 100 feet high, and mounted upon each of these a circular row of twelve electric lights of the Weston patent, each light being estimated at 2,500-candle power. As these towers are but 500 feet apart and in a triangle, it will be seen that the light of 90,000 candles was concentrated within a limited territory. The design of the exhibition was to afford a model of the plan contemplated for lighting cities from overhead in vast areas, the estimate being that four towers to a square mile of area, each mounting lights aggregating 90,000-candle power, will suffice to flood the territory about with a light almost equal to midday. Last evening a motive power of thirty-six horses was used in generating the electricity from three Western machines, and the lights, with one single slight flicker, burned steadily and brilliantly all the evening. It is difficult to say whether the experiment proved anything or not. The claim put forward by the company is for an original plan of lighting cities and towns by grouping and elevating electric lights of any kind."

We have received Part I of the *Transactions* of the Epping Forest and Essex Field Club, containing Mr. Henry Walker's interesting lecture on "A Day's Elephant Hunting in Essex."

AT the Leeds Philosophical and Literary Society the following are among the lectures to be given this winter:—October 20, Prof. Silvanus P. Thompson, D.Sc., "Waves of Sound and the Photophone"; November 16, H. Clifton Sorby, LL.D., F.R.S., "The Structure and Origin of Meteorites and Meteoric Iron"; December 7, Dr. Sydney H. Vines, "The Nutrition of Plants"; December 21, Prof. E. Ray Lankester, F.R.S., "Degeneration"; February 15, 1881, Prof. T. E. Thorpe, Ph.D., F.R.S., "The Azores"; March 1, J. W. Swan, "The Electric Light, with Demonstrations."

OUR ASTRONOMICAL COLUMN

THE BINARY STAR  $\delta$  EQUULEI.—Mr. Burnham publishes a new epoch for this star, which there is now good reason to conclude will prove to be the most rapid revolver amongst the binary systems; on this account it well deserves the attention which Mr. Burnham claims for it at the hands of those observers who are in possession of instruments competent to cope with so close a double-star. The duplicity was detected by M. Otto Struve on August 19, 1852, with the Pulkowa refractor, when definition was unusually good, and the components almost equal in magnitude were "à peine séparées par une ligne noire." In 1853 and 1854 it appeared single in the same instrument. The object was elongated in the summer of 1857, and at the date 1858.59 M. Struve saw the stars separated at moments, and they were again divided in the autumn of 1874. As is pointed out in the Pulkowa Observations, vol. ix., the case is evidently a similar one to that of  $\alpha$  Comæ Beren., the visual ray coinciding very nearly with the plane of the orbit, so that the companion appears to oscillate backwards and forwards almost in a right line, and that of very small extent. M. Struve has established the period of revolution of  $\alpha$  Comæ to be only about twenty-five years, but  $\delta$  Equulei appears to indicate a period of only thirteen or fourteen years. Mr. Burnham finds from five nights' measures with the 18½-inch Chicago refractor, 1880.60, Position  $29^{\circ}1$ , Distance  $0''35$ .

In September, 1870, Dunér remarked of this star: "Oblongue, j'en suis bien sur. Les diamètres sont comme 3 : 5," and the angle was estimated  $8^{\circ}$ . The only measures except Mr. Burnham's are those of M. Otto Struve. The magnitudes of the components are so nearly equal (the American observer considered there was a difference of only about two or three tenths of a magnitude), that care will be necessary to place the smaller star in its proper quadrant. Mr. Burnham adds: "It seems certain that it is measurable with any good instrument of ten inches aperture and upwards at least one year in every six years," and he believes that it is now near its maximum distance.

FAYE'S COMET.—The following positions are extracted from Dr. Axel-Möller's ephemeris for Berlin midnight:—

	R.A.			N.P.D.			Log. distance from	
	h.	m.	s.	°	'	"	Earth.	Sun.
Oct. 22	22	48	22	88	50	8	0'0506	0'2892
24	—	48	58	89	9	8	0'0532	...
26	—	49	43	89	27	8	0'0561	0'2855
28	—	50	37	89	45	0	0'0591	...
30	—	51	39	90	1	2	0'0623	0'2819
Nov. 1	—	52	50	90	16	5	0'0656	...
3	—	54	9	90	30	7	0'0691	0'2785
5	—	55	37	90	43	8	0'0727	...
7	22	57	2	90	55	9	0'0764	0'2751

The comet remains sensibly at the same intensity of light (not far from the maximum of the present appearance) during this period. On October 26 it will be within  $20'$  from  $\beta$  Piscium (B.A.C. 7985), and on November 3 very close to  $\gamma$  Piscium (B.A.C. 8012), stars of the sixth magnitude.

HARTWIG'S COMET.—The subjoined places of this comet are from the calculations of Dr. Oppenheim, and are also for Berlin midnight:—

	R.A.			N.P.D.			Log. distance from	
	h.	m.	s.	°	'	"	Earth.	Sun.
Oct. 22	17	52	1	76	23	8	0'0582	0'0610
24	17	53	30	77	13	0	0'0826	...
26	18	4	22	77	57	3	0'1057	0'0883
28	18	9	43	78	37	2	0'1276	...
30	18	14	39	79	13	2	0'1483	0'1136
Nov. 1	18	19	13	79	45	7	0'1682	...
3	18	23	26	80	15	1	0'1868	0'1170

COMETS 1880, *d* AND *e*.—M. Bigourdan has continued his ephemeris of the comet discovered by Schäberle on April 6, but states from observations made at Paris that the intensity of light has diminished much more rapidly than is due to change of distance from the earth and sun; on September 30 he estimated the comet to be of the same brightness as on May 18; it is still in a favourable position for observation, as will be seen from the following extract from M. Bigourdan's ephemeris for Paris midnight:—

	R.A.			N.P.D.		R.A.			N.P.D.					
	h.	m.	s.			h.	m.	s.						
Oct. 22 ...	5	56	3	...	89	49		Oct. 30 ...	5	34	22	...	94	55
24 ...	5	50	57	...	91	4		Nov. 1 ...	5	28	27	...	96	12
26 ...	5	45	38	...	92	21		3 ...	5	22	21	...	97	28
28 ...	5	40	6	...	93	38		5 ...	5	16	6	...	98	44

The Astronomer-Royal has notified the discovery of another comet by Mr. Lewis Swift of Rochester, N.Y., on the night of October 11, in R.A. 21h. 30m. and Decl. + 18°.

### METEOROLOGICAL NOTES

PROF. LOOMIS, in his thirteenth contribution to meteorology, investigates the question of the great and sudden changes of temperature which are so marked a feature in the climates of a large portion of the United States. Six years' observations of the Signal Service stations have been examined, with the result that there are 118 stations at which there has occurred at least one case of a daily range not less than 40°o. Limiting the inquiry, however, to stations at which the average number of cases amounted to six annually, it is seen that there are thirty-six such stations. The stations where the great fluctuations of temperature occur most frequently are situated south of lat. 35°, in which region the fluctuations of pressure attending the progress of storms are but little felt; and it is to be noted that these great fluctuations of temperature occur most frequently in the summer months. Thus at Wickenburg (lat. 34°o, long. 112°7'), which is situated in a desert sandy region, with an annual rainfall of only 4.99 inches, on ten of the nineteen days ending with August 14, 1877, the temperature showed a daily range of at least 62°o, reaching in one case to 76°o. These enormous temperature changes are due to the extreme dryness of the air, by which the sand becomes intensely heated by the sun during the day, whereas by night the loss of heat by radiation is as great as perhaps anywhere on the globe. The general result of the inquiry is that the most remarkable cases are merely examples of the ordinary diurnal change of temperature, unaffected by the passage of storms, whilst the remaining cases, which occur in the higher latitudes of the States, are to be ascribed to the influence of storms along with the ordinary diurnal change of temperature. It also appears from a careful investigation that dry air, even when greatly heated, has but little ascensional force, and that the violent uprising of heated air, so frequently witnessed in moist climates, particularly during thunderstorms, is mainly due to the large amount of aqueous vapour with which it is charged. As regards great fluctuations of temperature in winter, Prof. Loomis points out that while, for example, a temperature of -20°o occurs at Denver on the east side of the Rocky Mountains, an average temperature of 30°o prevails in the Salt Lake Basin, and remarks that by the movements of the atmosphere attending the progress of a great storm these contiguous masses of air with temperatures so different from each other are brought successively over the same station, and thus bring about a change of temperature amounting on occasions to 50°o in a single hour.

PROF. LOOMIS also carefully investigates the storms, with their characteristic low barometer, which cross the Rocky Mountains, and shows that no great barometric disturbances originate in the Salt Lake Basin; that nearly all the great barometric disturbances experienced in the Salt Lake Basin come from the Pacific, and generally from the north-west; and that nearly all these disturbances can be followed to the Atlantic, meeting it near lat. 47°o, and occupying from two to six days in the passage, or an average of three and a half days, corresponding to an onward movement of about 700 English miles a day. As has been shown to obtain in other regions of the globe, the isobars which define storms are often not so symmetrical over a mountainous region as over a level country. In not a few cases however the isobars show considerable symmetry over the Rocky Mountains, and this feature becomes the more noticeable in very violent storms. From the observations made at Pike's Peak, 14,200 feet high,

as well as at Mount Washington, 6,285 feet, it appears that the winds at great elevations circulate about a low barometer, just as they do near the level of the sea; but the position of this centre at great heights sometimes differs considerably from the low centre prevailing at the surface of the earth, and when such deviation does occur it is generally toward the north-west. Of the thirty-six cases examined, the low centre at great elevation was, in twenty-seven cases, vertical over the low centre at lower levels, in five cases to north-west, in one case to north, in another case to west, and in two cases to east. It must however not be lost sight of that this important point in the phenomena of storms cannot be exactly determined but by a multiplication of high-level stations.

DISPLAYS of auroras appear to have been remarkably frequent in America during August last. In Mr. Carpmal's Weather Report of the month for Canada it is stated that the aurora of the 12th was very brilliant, and was seen at nearly every station from Manitoba to the Atlantic. From the United States Monthly Weather Report we learn that auroras were frequent during the month, occurring on no fewer than twenty-one nights, the auroras of the 12th and 13th being of remarkable brilliancy, as well as widespread. On these nights the aurora was seen at about 100 stations from Maine westward, as far as clear skies allowed its being seen. The more prominent features of these auroras as detailed in the Report are of such interest as to suggest that a more detailed account of them, as seen in the northern hemisphere during the night of August 12 and 13, could not fail to contribute data of the greatest importance in this little-understood branch of physics.

In the *Journal* of the Scottish Meteorological Society, recently published, there is a paper of some interest, by Mr. Buchan, on the diurnal periods of thunderstorms in Scotland. There are two well-marked types of thunderstorms, the one occurring in the summer months, and having its daily maximum frequency from 1 p.m. to 6 p.m., and the other occurring in the winter months, with its maximum from 9 p.m. to 3 a.m. Stations in the eastern division of the country where the annual rainfall is small, or only of moderate amount, have all, or nearly all, their thunderstorms during the summer months; whereas in the west, or where the climate is wet and the rainfall heavy, a very considerable proportion of the thunderstorms occur during the winter months, and these are nearly always of short duration, and are the accompaniments of the winter cyclones of North-Western Europe. In this connection it is interesting to note that the thunderstorms of Stykisholm in Iceland are phenomena of the winter months and of the nights, only three being recorded as having happened at a time of the day when the sun was above the horizon. The maximum daily period of the summer thunderstorm coincides with the hours when the ascending columns of heated air from the earth's surface are in full activity, and the result is no doubt largely due to the circumstance that these ascending masses of heated air develop a charge of electricity as their moisture condenses into cloud. The period of maximum frequency of the winter thunderstorm occurs some hours before and after midnight, or during those hours of the day when the land surface presented to the vapour-laden winds of the Atlantic approaches to and reaches its diurnal minimum temperature, and when consequently the condensation of the vapour may be expected to reach its daily maximum. On the other hand, the minimum period in summer occurs during the early morning, the absolute minimum being at the hour just before the ascending columns of heated air are set in motion, and the number remains few till about 11 a.m., or till the tops of the heated columns have risen to some height in the atmospheres.

IN the *Journal* of the Meteorological Society for April and July last are given the results of observations made during the first six months of 1880 at about forty "climatological stations" recently established by the society. At these stations observations are taken only once a day, viz., at 9 a.m., and are restricted to temperature, cloud, and rain. An extension of these stations which would include the whole of the English sanatoria, and which doubtless will gradually be effected, would furnish data for a correct presentation of the comparative climatology of the health resorts of England.

### BIOLOGICAL NOTES

NEST-BUILDING AMPHIPODS.—Mr. S. J. Smith, in a memoir on some amphipods described by Thomas Say (*Trans.*, Connecticut Acad., July, 1880), states that the tubes which certain

species make to live in are to a great extent formed of pellets of their excreta. In 1874 he watched carefully the process of constructing the tubes in several species of Amphipoda. *Microdeutopus grandimanus* (*M. minax*, Smith) was a particularly favourable subject for observation. When captured and placed in a small zoophyte trough with small branching algae, the individuals almost always proceeded at once to construct a tube, and could very readily be observed under the microscope. A few slender branches of the alga were pulled toward each other by means of the antennæ and gnathopods, and fastened by threads of cement spun from branch to branch by the first and second pairs of pereopods. The branches were not usually at once brought near enough together to serve as the framework of the tube, but were gradually brought together by pulling them in and fastening them a little at a time, until they were brought into the proper position, where they were firmly held by means of a thick network of fine threads of cement spun from branch to branch. After the tube had assumed very nearly its completed form, it was still usually nothing but a transparent network of cement threads woven among the branches of the alga, though occasionally a branch of the alga was bitten off and added to the framework: but very soon the animal began to work bits of excrement and bits of alga into the net. In this case the pellets of excrement, as passed, were taken in the gnathopods and maxillipeds, and apparently also by the maxillæ and mandibles, and broken into minute fragments and worked through the web, upon the outside of which they seemed to adhere, partially by the viscosity of the cement threads, and partially by the tangle of threads over them. Excrement and bits of alga were thus worked into the wall of the tube until the whole animal was protected from view, while, during the whole process, the spinning of cement over the inside of the tube was kept up. When spinning the cement threads within the tube the animal was held in place on the ventral side by the second pair of gnathopods and the caudal appendages, the latter being curved beneath the anterior portion of the pleon, and on the dorsal side by the third, fourth, and fifth pairs of pereopods extended and turned up over the back, with the dactyli turned outward into the web. The spinning was done wholly with the first and second pereopods, the tips of which were touched from point to point over the inside of the skeleton tube in a way that recalled strongly the movements of the hands in playing upon a piano. The cement adhered at once at the points touched and spun out between them in uniform delicate threads. The threads seemed to harden very quickly after they were spun, and did not seem even from the first to adhere to the animal itself.

**DEATH BY HANGING.**—Recent experiments regarding the nature of death by hanging or strangulation induce Prof. Tammasia to reject the view that the chief cause of such death is compression of the pneumogastric, causing paralysis of the heart (*Reale Ist. Lomb.*, fasc. xiii.). In the great majority of cases, he says, the proximate cause of death is the occlusion of the respiratory passages. The greater or lesser rapidity of the death depends on the degree of such occlusion. Compression of the pneumogastric and of the vessels of the neck may strengthen the efficacy of that direct cause, but, in the absence of the latter, it is insufficient to cause any instantaneous lethal phenomenon, as some have supposed.

**HÆMOGLOBIN IN ECHINODERMS.**—The presence of hæmoglobin in the aquiferous system of an Echinoderm (*Ophiactis urens*, one of the Ophiurida) has lately been demonstrated by M. Foottinger (Belgian Acad. *Bull.*, No. 5). The only branches of the metazoa in which it had not before been found were echinoderms and zoophytes. Simroth observed certain globules in the ambulacral canals of the former, but not observing live individuals, he missed the hæmoglobin, which may be observed if one of the arms of the living animal be broken; a drop of red colour appearing presently at the extremity. With the spectro-scope the identity of the colouring matter with that of the blood of vertebrates can be easily proved. The hæmoglobin is connected with globules, of varying form and size. Most have a nucleus and are true cells. Along with these are free nuclei and small un-nucleated corpuscles charged with hæmoglobin.

**AN OPTICAL PROPERTY OF THE CORNEA.**—Prof. Fleischl of Vienna has recently examined fresh corneas in polarised light, and found that the corneal fibres became, under tension, doubly refractive, and then occasionally give phenomena similar to those occurring in starch granules (the theory of which has been examined by von Lang). With this condition also is connected the opacity of the cornea on rise of intraocular pressure.

**PHOSPHORIC ACID IN THE URINE OF COWS.**—It is generally supposed that the urine of herbivora does not contain phosphoric acid. M. Chevron, however, lately had occasion (*Bull. de l'Acad. Roy. de Belg.*, No. 8) to observe phosphates (a combination of potassico-magnesian phosphate with bimagnesian phosphate) in the urine of cows which had been receiving linseed oil-cake (1½ kil. per head daily), bran (1½ kil.), beet (25 kil.), and straw (7½ kil.), a diet which is rich in phosphoric acid (oil-cake and bran) and in potash (beet). The phosphoric acid diminished and disappeared when green clover or lucern was substituted for the beet. It appears from experiments made by Herr Bertram in Leipzig, in 1878, that lime has the property of eliminating phosphoric acid from the urine of herbivora, and M. Chevron points out that the green fodder specified undoubtedly imparted more lime than the beet did. He proposes further experiment, however, to determine exactly the cause of elimination of the acid.

**RUDIMENTARY COMA IN GODETIA.**—While investigating the development of the embryo sac in the different genera of Onagraceæ, writes Mr. John M. Coulter, editor of the *Botanical Gazette*, Indiana (vol. v. Nos. 8 and 9, p. 75), my attention was attracted to certain hair-like projections which appeared upon the forming ovule of *Godetia* (probably *G. grandiflora*). A careful examination showed them to be identical in structure with the forming hairs in the coma of *Epilobium*. They occurred almost exclusively at the chalazal end, one or two scattered ones being detected farther down upon the raphe. A study of the development of the coma of *Epilobium* shows that the first indication of it is a tuberculated appearance of the chalazal end. Presently these tubercles push out into elongating nucleated cells, which eventually develop into the long hairs of the coma. Now *Godetia* permanently retains this tuberculated margin at the upper end, but does not usually develop its coma any further. In the cases examined, however, the forming ovules (either in reminiscence or prophecy) stretched out their tubercles into incipient hairs. Tracing these ovules in their subsequent development, it was found that these hairs gradually disappeared until, when the ovules had become anatropous, there was no indication of them. As *Godetia* has been merged into *Enothera*, many species of the latter were examined, to see if any such thing occurred in them; but no trace of such growth was detected. This would seem to indicate that if *Godetia* be not entitled to generic rank, it is at least that part of *Enothera* which approaches *Epilobium*. A discrepancy must, however, be noticed here. In *Epilobium* the hairs of the coma do not begin to form until the ovule has become completely anatropous; but in the *Godetia* observed the incipient coma had all disappeared by the time the ovule had become anatropous, beginning to form before the nucleus is half covered by the coats. These hairs appeared in greatest size and abundance when the axis of the ovule was at right angles to its anatropous position.

#### PHYSICAL NOTES

A BEAUTIFUL illustration of the laws of polarisation of light has lately been made by M. G. Govi. To understand it requires a somewhat careful explanation. Let a parallel beam of light be passed through a polariser, then through a thin slice of quartz cut perpendicularly to the optic axis, then through an analysing Nicol prism. It is seen, as is well known, to be coloured. This coloured light when passed into a spectro-scope gives a spectrum marked by one or more dark bands, corresponding to the particular rays whose relative retardations in passing through the crystal slice have produced interference. These bands are not always in one place; they are displaced right for left (according to whether the crystal is a right-handed or a left-handed specimen) if either the analyser or the polariser be rotated. A slice of quartz about 4.3 millims. thick produces a single band. One of 8.6 millims. two bands at once in the visible spectrum, the number of bands being proportional to the thickness of the crystal. Now suppose a mechanical contrivance by which both the analyser and the spectrum can be rotated at the same velocity. A direct-vision prism attached to the front of the Nicol prism realises the optical portion of this combination. There will be seen on rotation a circular spectrum, having either red or violet at the centre and either violet or red at its outer circumference. Now since the dark band spoken of is displaced by a quantity proportional to the amount of rotation, interference will take place in this circular spectrum along points which form geometrically a spiral of Archimedes. The persistence of impressions on the retina will enable this dark spiral to be seen in its entirety,

provided the rotation be sufficiently rapid. If a thicker piece of quartz be used, giving two, three, or four dark bands, the rotation-spectrum will present a most beautiful appearance, being crossed by a two-branched, or three-branched, or four-branched spiral, the separate lines of which proceed from the centre to the circumference. The sense of these dark spirals will change with the sense of the impressed rotation. The effects are very striking.

SEVERAL ingenious contemporaries of ours on this side of the Atlantic have furnished the eager appetites of their readers with diagrams of Graham Bell's photophone, of which the most casual observer cannot fail to notice the utter want of resemblance to one another. More than one at least of these is *ben trovato*.

LIQUID OZONE has been obtained by MM. P. Hautefeuille and J. Chappuis, and is found to be of a beautiful blue colour. If a mixture of oxygen and ozone at a temperature of about  $-23^{\circ}$  or  $-25^{\circ}$  be subjected to a considerable pressure, the ozone liquefies and will remain liquid even though the pressure be reduced to 10 atmospheres. Experiments involving alterations of pressure must however be carefully made; for the ozone is liable to change into oxygen with a sudden evolution of heat, producing an increase of pressure with explosive violence. It is necessary to interpose a layer of sulphuric acid upon the top of the column of mercury by which the pressure is applied in the instrument, as ozone acts directly on the mercury.

HERR HANKEL has recently (*Wied. Ann.*, No. 8) endeavoured to prove the direct transformation of vibrations of radiant heat into electricity. He had formerly shown that rock crystal has thermo-electric polar axes in the direction of its secondary axes (the six successive poles being alternately positive and negative), and he supposes the ether within the crystal to be so arranged that under influence and with participation of the material molecules it is movable in circular paths round the secondary axes, and more easily movable in one direction than in the other. Thus all along a secondary axis the more easily occurring rotation has the same direction, but looked at from without, the direction is opposite at one end to what it is at the other, so giving the opposite modifications of electricity. When radiations from without strike along such an axis, those vibrations in them whose direction coincides with that of the easier rotation of the ether-molecule in the crystal should induce rotation of this along with the material molecule, and at the two ends of the secondary axis there should be electric tensions, with opposite electricity. Herr Hankel verified this by placing an insulated metallic ball connected with a gold-leaf electroscope in the middle of one edge of a rock crystal fixed with its principal axis vertical, while sunlight was thrown from the other side along the secondary axis terminating at the ball; then the arrangement was reversed. The electroscope indicated opposite electricities in the two cases. A gas-flame or a heated ball gave similar effects, which, moreover, were proved to be due to the dark heat rays (not to the luminous rays).

THE specific rotatory power of paraglobulin in blood serum is  $47^{\circ}8$  for yellow light; that of albumen,  $57^{\circ}3$ . As these are the only albuminoid substances present in any considerable quantity, two determinations with the aid of the polariscope suffice (as M. Fredericq has shown to the Belgian Academy) for ascertaining their relative proportions. The rotation produced by the whole liquid is first determined; then the paraglobulin is precipitated with  $MgSO_4$ , then redissolved in a volume of water equal to that of the original serum, and the rotation-number got from this is deducted from that got previously. Each of the numbers divided by that representing the specific rotatory power of the corresponding substance indicates the quantity of the substance in 100 cc.

IN a recent brief memoir to the *R. Accademia dei Lincei* (Atti, June, 1880), Dr. Bartoli describes an ingenious application of the Bunsen calorimeter to determination of the mechanical equivalent of heat. A given mass of mercury at zero temperature is subjected to a considerable pressure, exactly determined, and passed through a steel tube of so small internal diameter and such length that its velocity of outflow is virtually *nil*, and so the work equivalent to the kinetic energy of the mercury issuing from the tube becomes negligible in presence of the work consumed by friction between the mercury and the walls of the tube. This tube penetrates into a metallic cylinder situated within the reservoir of the Bunsen calorimeter. The quantity of ice melted in the calorimeter serves as measure of the heat developed by the work of efflux of mercury. It is stated that the numerical

results are noteworthy for their agreement with the mean of former determinations, and still more for the narrow limits between which the extreme values arrived at are comprised.

EXPERIMENTS with regard to interpretation of the unequal reversal of magnesium lines in the green part of the solar spectrum are detailed by M. Fiévez in a recent paper to the Belgian Academy (*Bull.* No. 8). He first examined the influence of relative intensity of bright magnesium lines on their visibility by observing them separately and projecting them on the solar spectrum. Then he repeated the experiments of simplification of the spectrum by varying the intensity of the spark. Lastly, he studied the influence of greater or less dispersion and definition on the number and visibility of the lines, comparing prismatic with diffraction spectra. The experimental arrangements were mainly the same as in his recent researches on the spectra of hydrogen and nitrogen. The conclusion he arrives at is that the unequal reversal in question is due merely to a difference in the intensity of the bright lines, not to a dissociation of the metal.

M. BOUTY considers he has proved (*Journal de Phys.*, September) that in simple electrolysis the Peltier phenomenon is produced according to the same laws as at the surface of contact of two metals. It is a purely physical phenomenon without known relations with the heat of combination, or with the latent heat of solution, but connected by a precise law with the thermo-electric forces of corresponding couples. Chemical actions intervene in the production of one or other of the two inverse phenomena merely as disturbing causes, either altering the nature of the surfaces or producing a secondary liberation of heat. They may mask, more or less, the phenomenon on which they are superposed, but they do not produce it.

#### GEOGRAPHICAL NOTES

MR. LEIGH SMITH, during his Arctic cruise in his yacht *Eira*, has evidently done some very good work this summer. After cruising about the east coast of Greenland and in the neighbourhood of Spitzbergen, finding the ice-pack too dense and too far south to get far north without danger—although he reached  $79^{\circ}40' N.$  in  $46^{\circ}50' E.$ , the farthest point yet reached in that direction—Franz-Josef Land was reached on August 14. Here much exploring work was done. Land was found stretching away west and north-west from that discovered by the Austrians. A fine harbour, called after the *Eira*, was found in  $80^{\circ}5'25'' N.$ ,  $48^{\circ}50' E.$ , and several excursions were made from this basis, among the numerous fjords that pierce the mainland north and north-west. From the point named by the last Dutch expedition Barentz Hook, land was traced westwards some 110 miles, and from the extreme north-west point reached land was sighted forty miles further north-west. In the sea between were several large and small islands, all covered with glaciers and snow-fields, with bluff black headlands on the southern exposure, covered with vegetation. Several Arctic flowers were collected and brought home; a number of soundings and dredgings were made, yielding interesting results, and two bears which were caught have been sent to the Zoological Gardens. Evidently there is here a considerable archipelago, if not continuous stretch of land, giving some support to Petermann's theory that the Pole is probably surrounded by numerous islands. It is stated that Mr. Leigh Smith goes back next year; we trust he will reach Eira Harbour early, and be able to still further extend our knowledge of these new Arctic lands.

THE October number of *Petermann's Mittheilungen* contains several good papers. There is an interesting account of the progress of the Japanese trading station in Corea, which now contains about 2,000 Japanese inhabitants. Important information is given as to the results of Dr. O. Finsch's voyage in the Pacific. During a stay in the Sandwich Islands he made considerable additions to our knowledge of their natural history; thence he went to Jabut (Bonham) in the south of the Marshall Group, where his collections and observations in all directions were numerous and of great value. Thence he proceeded to the Gilbert or Kingsmill Group, and afterwards to the Carolines. Some idea of the results so far may be obtained from the fact that he has sent to Europe something like thirty boxes of collections; the materials collected in ten months embrace 70 mammals, 180 birds, 800 reptiles, 1,200 fishes, 15,000 molluscs, 800 crustaceans, 400 spiders, 1,400 insects, and about 150 other animals, besides 700 plants, and two boxes of minerals. In anthropology there are 50 skulls and 55 casts of faces, representing the peoples





The fauna of the Grand Banks and other off-shore fishing-grounds has been partly explored. In 1872, 1873, and 1874 dredging was carried on from the Coast Survey steamer *Bache* by Prof. Packard and Mr. Cooke, Prof. Smith, Mr. Harger, and Mr. Rathbun. In 1879 Mr. H. L. Osborne spent three months in a cod-schooner collecting material on the Grand Banks, and Mr. N. P. Scudder as long a time on the Holibut Grounds of Davis's Straits.

A most remarkable series of contributions has been received from the fishermen of Cape Ann. When the Fish Commission had its head-quarters at Gloucester, in 1878, a general interest in the zoological work sprang up among the crews of the fishing-vessels, and since that time they have been vying with each other in efforts to find new animals. Their activity has been stimulated by the publication of lists of their donations in the local papers, and the number of separate lots of specimens received to the present time exceeds 800. Many of these lots are large, consisting of collecting-tanks full of alcoholic specimens. At least thirty fishing-vessels now carry collecting-tanks on every trip, and many of the fishermen, with characteristic superstition, have the idea that it insures good luck to have a tank on board, and will not go to sea without one. The number of specimens acquired in this manner is at least 50,000 or 60,000, most of them belonging to species otherwise unattainable. Each holibut vessel sets, twice daily, lines from ten to fourteen miles in length, with hooks upon them six feet apart, in water 1,200 to 1,800 feet in depth, and the quantity of living forms brought up in this manner, and which had never hitherto been saved, is very astonishing. Over thirty species of fishes have thus been added to the fauna of North America; and Prof. Verrill informs me that the number of new and extra-limital forms thus placed upon the list of invertebrates cannot be less than fifty.

A permanent collector, Mr. Vinal N. Edwards, has been employed at Wood's Holl and vicinity since 1871, and many remarkable forms have also been discovered by him. No dredging has yet been attempted by the Commission south of Long Island. Dr. Yarow, Mr. Earll, and others, have collected from Cape May to Key West. The Gulf States Coast was explored last winter by a party conducted by Mr. Silas Stearns, who spent nine months in studying the food-fishes and useful invertebrates in behalf of the Commission and the Census. The entire Pacific coast has been scoured by Prof. Jordan for the Commission and the Census, and the ichthyology of that region has been enriched by the discovery of sixty species new to the fauna, forty of them being new to science. A similar investigation on the great lakes has been carried over a period of several years by the late Mr. Milner and Mr. Kumlien. The ichthyology of the rivers of the country has received much attention from the many experts employed by the Commission in fish-cultural work.

In addition to these local studies may be mentioned the general explorations such as are now being carried on for the oyster by Mr. Ernest Ingersoll and Mr. John F. Ryder, for the shad by Col. McDonald, for the smelt and the Atlantic salmon by Mr. C. G. Atkins, and the Quinnet salmon by Mr. Livingston Stone.

A partial indication of what has been accomplished may be found in the number of species added to the various faunal lists. Take, for instance, the cephalopod mollusks of New England, in Prof. Verrill's recently published monographs; twenty species are mentioned, thirteen of which are new to science. Ten years ago only three were known.

I am indebted to Prof. Verrill for the following estimate of the number of species added within the past ten years to the fauna of New England, mainly by the agency of the Commission:—

	Formerly known.	Additions.	Now known.
Crustacea ... ..	105	193	298
Pycnogonida ... ..	5	10	15
Annelida ... ..	67	238	305
Vermes ... ..	39	100	139
Mollusca ... ..	317	109	426
Echinodermata ... ..	47	41	88
Anthozoa or Polyyps ... ..	20	35	55
Hydrozoa or Acalepha ... ..	102	78	180
Tunicata ... ..	26	25	51
Polyzoa ... ..	56	91	147
Brachiopoda ... ..	5	0	5
Sponges ... ..	10	80	90
	800	1,000	1,800

It is but just to say that many of these species were obtained by Prof. Verrill in the course of his independent explorations in Maine and Connecticut previous to 1871.

A similar estimate for the fishes indicates the discovery of at least 100 species on the Eastern Atlantic coast within ten years; half of these are new to science. Forty species have been added to the fauna north of Cape Cod; sixteen of these are new and have been found within three years. Seventeen have been described as new from the Gulf of Mexico. Sixty and more have been added upon the west coast. The results of the summer campaigns are worked in winter in the Peabody Museum of Yale College, under the direction of Prof. Verrill, and by the specialists of the National Museum.

One of the important features of the work is the preparation of life-histories of the useful marine animals of the country, and great quantities of material have been accumulated relating to almost every species. A portion of this has been published. More or less complete biographical monographs have been printed on the bluefish, the scup, the menhaden, the salmon, and the whitefish, and others are nearly ready. Another monograph which may be referred to in this connection is that of Mr. Starbick on the whale-fishery, giving its history from the earliest settlement of North America.

The temperature of the water in its relation to the movements of fish has from the first received special attention. Observations are made regularly during the summer work, and at the various hatching-stations. At the instance of the commissioner, an extensive series of observations have, for several years, been made under the direction of the chief signal officer of the army, at lighthouses, light-ships, life-saving and signal stations, carefully chosen along the whole coast. This year thirty or more fishing schooners and steamers are carrying thermometers to record temperatures upon the fishing-grounds, a journal of the movements of the fish being kept at the same time. One practical result of the study of these observations has been the demonstration of the cause of the failure of the Menhaden fisheries on the coast of Maine in 1879—a failure on account of which nearly 2,000 persons were thrown out of employment. Another important series of investigations carried on by Commander Beardsley of the Navy shows the error of the ordinary manner of using the Casel-Miller deep-sea thermometer; still another series made by Dr. Kidder of the Navy, and to be carried out in future, had for its object the determination of the temperature of the blood of marine animals. Observations have also been made by Mr. Milner upon the influence of a change from sea water into fresh water, and from fresh water into sea water upon the young of different fishes. Mr. H. J. Rice carried on a series of studies upon the effect of cold in retarding the development of incubating fish-eggs. A series of analyses have been made by Prof. Atwater to determine the chemical composition and nutritive value of fish as compared with other articles of food. This investigation is still in progress. In connection with the work of fish-culture, much attention has been paid to embryology. The breeding times and habits of nearly all of our fishes have been studied and their relations to water temperatures. The embryological history of a number of species such as the cod, shad, alewife, salmon, smelt, Spanish mackerel, striped bass, white perch, and the oyster, have been obtained, under the auspices of the Commission, by Messrs. Brooks, Ryder, Schaeffer, Rice, and others.

The introduction of new species in water in which they were previously unknown is of special interest to the student of geographical distribution. Through the agency of the Commission the German carp has already been placed in nearly every State and Territory, although the work of distribution has only just begun, and the tench (*Tinca vulgaris*) and the golden orfe (*Ibus melanotus*) have been acclimated; the shad has been successfully planted in the Mississippi valley and on the coast of California, and the California salmon in the rivers of the Atlantic slope. The lake whitefish of Europe has been introduced into a lake of Wisconsin. As an act of international courtesy, California salmon have been successfully introduced into New Zealand and Germany. The propagation work has increased in importance from year to year, as may be seen by the constant increase in the amount of the annual appropriation. A review of the results of the labours of the Commission in increasing the food supply of the country may be found in the annual reports. The rude appliances of fish-culture in use ten years ago have given way to scientifically devised apparatus, by which millions of eggs are hatched where only thousands were before, and the demonstration of the possibility of stocking rivers and lakes to any

desired extent has been greatly strengthened. This work was for six years most efficiently directed by the late Mr. James W. Milner, and is now in charge of Major T. B. Ferguson, also Commissioner for the State of Maryland, by whom has been devised the machinery for propagation on a gigantic scale, by the aid of steam, which is now so successfully in use.

The investigation of the statistics and history of the fisheries has perhaps assumed greater proportions than was at first contemplated. One of the immediate causes of the establishment of the Commission was the dissension between the line and net-fishermen of southern New England with reference to laws for the protection of the deteriorating fisheries of that region. The first work of Prof. Baird as Commissioner was to investigate the causes of this deterioration, and the report of that year's work includes much statistical material. In the same year a zoological and statistical survey of the great lakes was accomplished, and various circulars were sent out in contemplation of the preparation of monographic reports upon the special branches of the fisheries, some of which have already been published.

Some thirty trained experts are now engaged in the preparation of a statistical report on the present state and the past history of the fisheries of the United States. This will be finished next year, but the subject will hereafter be continued in monographs upon separate branches of the fisheries, such as the herring fishery, the mackerel fishery, the shad fishery, the cod fishery, the herring fishery, the smelt fishery, and various others of less importance.

Hundreds, and even thousands of specimens of a single species are often obtained. After those for the National Museum have been selected, a great number of duplicates remain. These are identified, labelled, and made up into sets for exchange with other museums; and for distribution to schools and small museums. This is in accordance with the time-honoured usage of the Smithsonian Institution, and is regarded as an important branch of the work. Several specialists are employed solely in making up these sets and in gathering material required for their completion. Within three years fifty sets of fishes in alcohol, including at least ten thousand specimens, have been sent out, and fifty sets of invertebrates, embracing 175 species and 25,000 specimens. One hundred smaller sets of representative forms intended for educational purposes, to be given to schools and academies, are now being prepared. The arrangement of the invertebrate duplicates is in the charge of Mr. Richard Rathbun; of the fishes, in that of Dr. T. H. Bean. Facilities have also been given to many institutions for making collections on their own behalf. Six annual reports have been published, with an aggregate of 5,650 pages. These cover the period 1871 to 1878. Many papers relating to the work have been published elsewhere, particularly descriptions of new species and results of special faunal exploration.

The season of 1880 was opened by the participation of the Commission in the International Exhibition at Berlin. The first honour-prize, the gift of the Emperor of Germany, was awarded to Prof. Baird, not alone as an acknowledgment that the display of the United States was the most perfect and most imposing, but as a personal tribute to one who, in the words of the president of the Deutscher Fisherei Verein, is regarded in Europe as the first fish-culturalist in the world.

### UNIVERSITY AND EDUCATIONAL INTELLIGENCE

OXFORD.—This year the term commences somewhat later than usual. The professorial lectures on natural science begin next week. At the University Museum Dr. Odling lectures on Typical Alcohols, Prof. Clifton on Experimental Electricity, Prof. Price on Hydro mechanics, Prof. Story-Maskelyne, M.P., on the Elements of Crystallography, Prof. Prestwich on Stratigraphical Geology, and Prof. Rolleston on Digestion.

Lectures are also given in the Chemical Department at the Museum by Mr. W. W. Fisher, on Inorganic Chemistry, by Mr. J. Watts on Organic Chemistry, and by Dr. F. D. Brown on Chemical Affinity. In the Biological Department Messrs. C. Robertson, W. H. Jackson, and A. P. Thomas form classes for instruction in Microscopy and Zoology. Mr. Barclay Thompson gives a course on the Comparative Anatomy of the Mammalia. In the Clarendon Laboratory Mr. Stocker lectures on Elementary Mechanics, and, with Mr. V. Jones, gives instruction in practical physics.

At the University Observatory Prof. Pritchard will lecture on

Spherical Astronomy, including instruments, and will give a course of six lectures on the Precession of the Equinoxes, including the Lunar Physical Libration. The Observatory is opened on Monday and Tuesday evenings during the term to members of the University who desire to obtain instrumental practice. In his annual report to the Board of Visitors the Professor gives an account of the work carried on during the past year at the Observatory. The long series of observations in reference to the Inequalities in the Moon's Rotation are now finished, and the results will be shortly published. The calculations were brought to a successful issue during the Long Vacation, and afford a general confirmation of the investigations of Bouvard, Nicollet, and Wichmann, and establish the existence of small but sensible inequalities in the moon's rotation. Careful measurements have also been made by Mr. Plummer of the relative positions of forty stars in the Pleiades, and Mr. Jenkins has measured the relative co-ordinates of 250 stars in the cluster 39 Messier. Careful observations have also been made of the component stars of  $\xi$  Ursæ Majoris and  $\gamma$  Ophiuchi. With regard to the instruments the Professor writes:—

"The large refractor has been thoroughly examined and cleaned by Mr. Grubb, the artist who constructed it. This at present is in an efficient working condition in every respect. From our own resources we have thoroughly overhauled the De La Rue Reflector, and it also is in excellent condition. It is fortunate for the University that both these instruments pass from time to time under the experienced and critical eye of Dr. De La Rue himself. For a time Dr. De La Rue's metallic speculum was replaced by an excellent silvered glass mirror, executed by Mr. With; the newer mirror possessed the greater capacity of the two, in point of brilliancy of reflected light, but was not deemed quite equal to Dr. De La Rue's in point of definition; we have therefore returned to the use of the original speculum.

"In order to carry out a new and important series of astronomical observations I soon found that the use of a chronograph was indispensable; accordingly I have, in conjunction with Mr. Grubb, devised a very inexpensive but practically efficient form of that instrument. The total cost of this instrument, together with a corresponding and necessary addition to the mechanism of the sidereal clock, has not exceeded 10*l*. I am told on the best authority that this form of the chronograph will henceforth prove a desirable adjunct in other observatories.

"With the view of bringing practical astronomy within the reach of a moderate expenditure I have (again in conjunction with Mr. Grubb) devised a modification of existing small equatorial telescopes, which I anticipate will prove a boon to beginners in astronomical science.

"Lastly, I have devised and carried into execution a simple form of precessional globe for the use of students in astronomy. It affords very ready means of representing the risings and settings of the stars, and the general aspect of the heavens at the remotest periods of time, past and future, and as seen at any locality."

In the Botanic Garden Prof. Lawson will give instruction on the Minute Anatomy of the Vegetable Tissues.

The following lectures are given in those colleges which possess laboratories. At Christ Church Mr. Vernon Harcourt lectures on the Non-metallic Elements, and Mr. R. E. Baynes on Dynamical Electricity and Conduction of Heat. At Balliol College Mr. J. W. Russell lectures on Problems in Mechanics, and Mr. H. B. Dixon on Elementary Heat and Light. At Exeter College Mr. Lewis Morgan lectures on Practical Histology, and at Magdalen College Mr. C. J. Yule gives a course of demonstrations on the Chemical Composition of the Body.

AN examination for Natural Science Scholarships is being held by Trinity and Exeter Colleges. The former College has this year for the first time offered a scholarship for proficiency in science. At Merton College the science scholarship (Post-mastership) was not awarded.

AT Balliol College there will be offered next month a science scholarship, on the foundation of Miss Brakenbury, open to all candidates without limitation of age, who shall not have exceeded eight terms from matriculation. The scholarship is of the annual value of 80*l*., and is tenable for four years during residence. Papers will be set in the following subjects:—(1) Mechanical Philosophy and Physics, (2) Chemistry, (3) Physiology. Candidates will not be expected to offer themselves in more than two of these. There will be a practical examination in one or more

of the above subjects if the examiners think it expedient. Intending candidates should communicate with the Master of Balliol before November 12. There will also be offered two exhibitions worth 40*l.* a year, the examination for which will comprise the elements of Physics, Chemistry, or Physiology, as well as Classics and Mathematics.

CAMBRIDGE.—Dr. Michael Foster will lecture on elementary physiology; Mr. Langley will lecture to the advanced class on general physiology twice a week; Mr. Lea takes physiological chemistry; and Dr. Gaskell the physiology of the circulation.

Mr. VERNON will lecture during the next two terms on scientific method.

MR. FREEMAN of St. John's College is to lecture as deputy for Prof. Challis, owing to his infirm health.

DR. REGINALD THOMPSON of Trinity College is to be one of the Examiners for 3rd M.B., and Dr. Cheadle to be Assessor to the Regius Professor of Physic.

The list of lecturers at Newnham College this term includes the names of Miss Crofts (English History and Literature), Miss Merrifield (Greek), Miss Harland (Algebra), and Miss Scott (Analytical Conics). The lectures are now delivered at the College, and not in Alexandra Hall.

AT St. Thomas's Hospital Medical School Mr. Robert Lawson has obtained the Entrance Scholarship in Natural Science, of the value of 100*l.*, and Mr. Herbert Lankester that of 60*l.*

AT the meeting of the Council of the College of Physical Science, Newcastle-on-Tyne, on October 11, it was decided without opposition that a lady candidate, Miss Isabel M. Aldis, should be allowed to hold an exhibition in the College. This decision completes the opening of the advantages of the College to lady students. They were previously admitted to all the lectures, but this is the first time that a lady has been a candidate for an exhibition.

SOCIETIES AND ACADEMIES  
PARIS

Academy of Sciences, October 11.—M. Wurtz in the chair. The following papers were read:—On the *role* of time in the formation of salts, by M. Berthelot. Experiments with several hundred saline mixtures prove that the period of change in saline reactions, comprised between the moment when the system has become physically homogeneous and that when it attains its chemical equilibrium, is excessively short, and wholly included in the short duration of the calorimetric experiment. The same period in ethene reactions, on the other hand, is incomparably longer. The instantaneity in the former case is proved by an application of the author's theorem of slow actions.—On pellagra in Italy, by M. Faye. In the past year there have been 40,000 well-marked cases of the disease in Lombardy, and 30,000 in Venetia, the richest and most productive provinces in Italy. It is unknown in Naples, Sicily, and Sardinia (so poverty and bad hygiene do not seem to be the causes). Wherever pellagra appears in the endemic state *pelesta* or *cruchade* are eaten, *i.e.*, varieties of unfermented bread (made from maize and millet), and M. Faye thinks the substitution of fermented bread would prove salutary.—On the photophonic experiments of Prof. Bell and Mr. Sumner Tainter, by M. Breguet.—On algebraic equations, by Mr. West.—Earthquakes at Smyrna on July 29, by Dr. Charpentin. The ravages and phenomena of this earthquake were limited to the Sipyle chain and the adjoining plains in a perimeter of only a few leagues; but the *contra-coup* was felt at great distances (Broussa, Rhodes, &c.). Chronometers at Athens were stopped. More than 3,000 years ago there seems to have been a volcano under Sipyle, and this point has been the centre of earthquakes in that region. The approximate coincidence (in time) of this last Smyrna earthquake with earthquakes at Manila, the Azores, and Naples, is remarkable.—On the effects produced by cultivation of absinthae as insectifuge, and on its preventive application against phylloxera, by M. Poirot. Among the absinthae plants covering large tracts in North America the author has never seen flies, ants, worms, or any insects, nor yet scorpions, tarantulas, nor rattlesnakes. Land manured with absinthae might be fatal to the metamorphoses of phylloxera.—Ephemerides of comet *b* 1880 (continued), by M. Bigourdan.—Observations of comet *d* 1880 (discovered by Dr. Hartwig at Strassburg) at the Paris Observatory, by M. Bigourdan.—On the resolvent function of the equation  $x^m + px + q = 0$ , by M. Fuiet.—On a property of Poinson's function, and on the integration of equations with partial

derivatives of the first order, by M. Gilbert.—On a very extensive class of linear differential equations with rational coefficient whose solution depends on the quadrature of an irrational algebraic product, by M. Dillner.—Principle of an algebraic calculus which contains as particular species the calculus of imaginary quantities and quaternions, by M. Lipschitz.—On the partition of numbers, by M. David.—On the mechanical actions of light theoretical considerations capable of serving in interpretation of Prof. Bell's experiments, by M. Cros. In 1872 M. Cros presented a memoir to the Academy, in which, guided by theoretical considerations, he affirmed *a priori* the results of experiments which he thinks have a notable similarity to Prof. Bell's. In one experiment a ray of light interrupted *n* times a second was to be sent into a tube resonating with a note of *n* vibrations. The alternate rarefaction and condensation of the gaseous medium might make the tube speak.—Study of the distribution of light in the solar spectrum, by MM. Macé and Nicati. The maximum intensity is in the yellow, very near D. The perception of blue and violet diminishes much more slowly with diminished illumination than that of less refrangible colours. From the extreme red to green of about 0.5  $\mu$  wave-length, the law of distribution of intensity is the same whatever the illumination. Between eyes equally capable of discerning colour, there are very sensible differences.—Vibratory forms of circular pellicles of saponaceous liquid, by M. Decharme. With a given diameter of pellicle the numbers of nodals are inversely proportional to the corresponding lengths of the vibrating rod (which produces the waves).—On the place which boron occupies in the series of simple bodies, by M. Etard. He places boron in the family of vanadium, very near that of phosphorus.—On propylacetal and isobutylacetal, by M. de Girard.

CONTENTS

PAGE

SCIENTIFIC WORTHIES, XVI.—RICHARD OWEN ( <i>With Steel Plate Engraving</i> ) . . . . .	57
INSECT VARIETY . . . . .	57
WEAPONS AND POLITICS OF THE ANCIENT HINDUS . . . . .	58
OUR BOOK SHELF:—	
Barfod's "Lehrbuch der organischen Qualitativen Analyse" . . . . .	58
Carr's "Synopsis of Elementary Results in Pure and Applied Mathematics" . . . . .	58
Quiroga's "Estudio Micrografico ne Algunos Basaltos de Cuidad Real" . . . . .	58
Cameletti's "Il Binomio di Newton" . . . . .	58
LETTERS TO THE EDITOR:—	
Photograph of the Nebula in Orion.—Prof. HENRY DRAPER . . . . .	58
An Amœbian Entozoon.—G. E. DOBSON . . . . .	58
Sounds made by Ants.—S. E. PEAL . . . . .	58
Faraday Exhibiting Ghosts.—W. S. . . . .	58
Ice under Pressure.—Dr. THOS. CARNELLEY . . . . .	58
A Pert Bed in the Drift at Oldham.—P. O. HUTCHINSON; JAMES NIELD . . . . .	58
Temperature of the Breath.—Dr. R. E. DUDGON . . . . .	58
Selenium.—A. T. F. . . . .	58
Dynastes Hercules.—Dr. A. ERNST . . . . .	58
What is Alresne?—Dr. A. ERNST . . . . .	58
Rainfall of Sierra Leone.—W. HUME HART . . . . .	58
An Octopus.—C. G. O'BRIEN . . . . .	58
SYNTHESIS OF CITRIC ACID . . . . .	58
PLANTS FROM LAKE NYASSA AND LAKE TANGANYIKA . . . . .	58
GRAHAM BELL'S EXPERIMENTS IN BINAURAL AUDITION ( <i>With Illustration</i> ) . . . . .	58
THE GEOLOGY OF THE LIBYAN DESERT . . . . .	58
PHYSICS WITHOUT APPARATUS, VIII. ( <i>With Illustrations</i> ) . . . . .	58
THE GERMINATION OF WELWITSCHIA MIRABILIS. By F. ORPEN BOWER . . . . .	59
NOTES . . . . .	59
OUR ASTRONOMICAL COLUMN:—	
The Binary Star $\epsilon$ Equulei . . . . .	59
Faye's Comet . . . . .	59
Hartwig's Comet . . . . .	59
Comets 1880, <i>d</i> and <i>e</i> . . . . .	59
METEOROLOGICAL NOTES . . . . .	59
BIOLOGICAL NOTES:—	
Nest-Building Amphipoda . . . . .	59
Death by Hanging . . . . .	59
Hæmoglobin in Echinoderms . . . . .	59
An Optical Property of the Cornea . . . . .	59
Phosphoric Acid in the Urine of Cows . . . . .	59
Rudimentary Coma in Godesia . . . . .	59
PHYSICAL NOTES . . . . .	59
GEOGRAPHICAL NOTES . . . . .	59
THE FIRST DECADE OF THE UNITED STATES FISH COMMISSION—ITS PLAN OF WORK AND ACCOMPLISHED RESULTS, SCIENTIFIC AND ECONOMICAL. By G. BROWN GOODE . . . . .	59
UNIVERSITY AND EDUCATIONAL INTELLIGENCE . . . . .	59
SOCIETIES AND ACADEMIES . . . . .	60

THURSDAY, OCTOBER 28, 1880

**BALFOUR'S "COMPARATIVE EMBRYOLOGY"**

*A Treatise on Comparative Embryology.* By Francis M. Balfour, M.A., F.R.S., Fellow and Lecturer of Trinity College, Cambridge. In Two Volumes. Vol. I. (London: Macmillan and Co., 1880.)

IT is scarcely possible to exaggerate the expressions of gratitude which are due from zoologists to Mr. Balfour for the execution of the great task which some three or four years ago he set himself. Zoologists have to be thankful to him not only for the admirable style in which he has carried out his work, but for the promptitude with which he has achieved it. Mr. Balfour's object was to produce a work in which all that has been written during the last ten or fifteen years on the structural features exhibited by animals during their growth from the egg to the adult condition should be digested, and its import carefully estimated; the result being set forth in a systematic way, so that the broad conclusions arrived at by the almost innumerable studies of "development from the egg" in all sorts and conditions of animals should be pointedly placed before the reader. At the same time he aimed to provide for the purpose of reference and for the guidance of future students something like a complete bibliography, accompanied by an analysis in many cases, of the works which have been published on special forms.

It is very well known to those who are in a position to make a comparative estimate, that during the last fifteen years in no branch of science has there been such activity, such abundance of discovery, of careful observation and ingenious speculation, as in biology; and this activity has tended more and more to concentrate itself upon the study of the mode in which the complex adult organism (whether plant or animal), with all its astounding powers and its beauty of form—slowly, surely, and yet by most improbable and devious ways, advances to its complete estate from the condition of a microscopic structureless globule of albuminous slime. This marvel of development is one which has only recently come to man's knowledge, and it seems likely that the fascination which the study of it can exert will be such as to attract the energies of an ever-increasing crowd of observers.

Mr. Balfour's book gives for those who are to come a *résumé* or summing up of the labours of those who have up to this date worked for and created our knowledge of what this process of growth from the egg is and signifies.

The first volume deals with the history of development in all groups of animals excepting the Vertebrata. The labour which it has involved will be understood when it is stated that the author gives references to five hundred and seventy-two separate memoirs or books, most of which he has thoroughly read, and from many of which he gives extracts or carefully condensed abstracts.

The thoroughness with which the subject is presented to the student may be appreciated by a consideration of the fact that two hundred and seventy-five woodcuts are given in this volume, which are, with few exceptions, prepared especially for this work, either from the author's original drawings or from the drawings of the writers whom he is summarising.

Vol. XXII.—No. 574

The work is divided into an "Introduction" and a "Systematic Embryology." In the Introduction we have chapters on "The Ovum and the Spermatozoon," on "The Maturation and the Impregnation of the Ovum," and on "The Segmentation of the Ovum." The systematic portion is divided into chapters, each of which corresponds with one of the large divisions of animals, e.g. Porifera, Platyelminthes, Rotifera, Mollusca, Chætopoda, &c.

Mr. Balfour, it is hardly necessary to say, has not performed his task as an ordinary maker of books. He is, as all zoologists know, one of the foremost students of embryology in Europe, and has added a very large proportion himself to that great heap of isolated embryological memoirs and monographs which it is the purpose of his book to condense and render accessible to a wider circle of students. Consequently we find not only new and original observations scattered here and there in the chapters of this treatise, but on the very numerous matters which call for the expression of an opinion or the exercise of judgment between conflicting statements of preceding observers, we have the conclusions, always modestly formulated, of a thoroughly competent critic.

In fact those who are already advanced in the study of embryology will find that Mr. Balfour has freely and most legitimately made use of speculative views of his own, as a series of strings on which to thread the almost innumerable observed facts which have to be put on record and kept ready, as it were, for the future building up of embryological doctrine. The reader, on the other hand, who has not yet reached the degree of knowledge at which such speculations become intelligible, will find that there is so much in Mr. Balfour's pages of hard, solid, descriptive record of the actual developmental changes of one animal after another, that he will certainly not feel cause to complain.

It would be out of place to discuss in these pages any of the new theoretical considerations which Mr. Balfour puts forward. With some of them it is possible to find fault; at the same time they are all ingeniously supported and indicate close reasoning and a large survey of facts on the author's part. They serve, as Mr. Balfour himself recognises, to stimulate inquiry, and when advanced not by a paper-philosopher, but by a most exceptionally industrious observer, they cannot fail to command respect.

If we venture to offer any remark which suggests how possibly Mr. Balfour's book might have been even more excellent than it is, it must be clearly understood that as it stands we hold it to be a perfect mine of valuable information and well-considered suggestion. We should, however, have been glad had it been possible for the author to give more attention to the history of the various stages of progress in our knowledge of embryology in general, and of each particular group. Full justice is done to recent authors, and his own contemporaries receive ample recognition from Mr. Balfour; but the successive steps by which a particular point of view has been arrived at are not always definitely indicated and due merit assigned to each of those who in past times has laboured to bring about the present phase of science. This, no doubt, has not entered into Mr. Balfour's plan on account of the additional responsibility and labour which it would have involved, and the increase in size of what is already

D D

a voluminous treatise. But such treatment of the subject has a very high educational value and a certain ethical importance.

Further, it may be noted that the author has necessarily a difficulty to contend with in the scope itself of his book. Embryology is not a natural nor a convenient division of biological science. The study of the organism in its complete form cannot be advantageously separated from the study of the coming about of that form, and indeed it is very difficult for a writer who proposes to himself to describe the developmental changes of organisms to draw the line consistently in the various cases which he describes, and to say that at such a point his business with the organism ceases and that of the "antipædologist" begins. It is because the knowledge of embryological facts is to so large an extent new, that separate treatises on embryology are necessary. It is as a supplement to treatises on the structure or anatomy of animals which do not sufficiently deal with embryology that such a distinct treatise is needful, and such need is merely the result of the late development of embryological research.

In the course of time we shall no doubt see a complete fusion of "embryology" and "antipædology"—the facts of structure to be observed in the youth and in the maturity of organisms being treated as a matter of course concurrently. Nothing could conduce more directly to this desirable state of things than the really remarkable and successful effort which Mr. Balfour has made to gather together and present in a compact and logical form the embryological results which have been and still are pouring forth from Russian, German, English, French, and American laboratories in an overwhelming stream, calculated to daunt by its velocity any but the most determined student.

E. RAY LANKESTER

### THE SIEVE-TUBES OF DICOTYLEDONOUS PLANTS

*Beiträge zur Kenntniss des Siebröhrenapparates dicotyler Pflanzen.* Von Dr. Karl Wilhelm. (Leipzig: W. Engelmann, 1880.)

IT is perhaps natural, owing to its peculiarities, and especially to the character of the cell walls, that the soft bast was comparatively lately investigated and described;<sup>1</sup> but it is surely a surprising fact that the ground should have been left open till the present year, for a thorough investigation of the development of those tissues which are characteristic of the phloem.

In the "Comparative Anatomy" of De Bary we find a full account of what was known in 1877 of the structure and development of the soft bast; at the same time the writer pointed out several questions concerning which further investigation was required. He drew especial attention to our want of knowledge of the relation of the cambiform cells<sup>2</sup> to the sieve-tubes, and of the development of the sieve plate, the callus mass, and the contents of the sieve-tube. It has been the object of Dr. Wilhelm's researches to supply information on these several points;

<sup>1</sup> The sieve tubes were discovered by Hartig (1837). His observations were many years after verified by other observers, especially von Mohl, Nageli, and Hanstein.

<sup>2</sup> De Bary, "Vergl. Anat." p. 337.

while at the same time he affords us many other interesting details.

Owing to the wideness of the subject it was impossible for the author to extend his researches beyond a limited number of types. Those selected were *Vitis vinifera*, L., *Cucurbita pepo*, L., and *Lagenaria vulgaris*, Ser. It will be seen that Dr. Wilhelm has selected plants having sieve-tubes of the two different types common among the Dicotyledons, viz., *Cucurbita* and *Lagenaria* where the structure is more simple, *Vitis* where it is complicated by the presence of several sieve-plates side by side on the same cell wall. In a note at the end of the paper the author specially asserts that his results only apply to the plants named; while further research must show whether the structure described is really typical.

The main results arrived at are as follows:—Those formative cells of the bast which are set apart for the development of a member of a sieve-tube, usually suffer a longitudinal division into two unequal cells: the larger forms one member of the sieve-tube; the other, which is smaller and shorter, develops into the companion-cell (*Geleitzelle*). The latter may, in *Cucurbita* and *Lagenaria*, again divide. The walls separating the companion-cells from the sieve-tube are fitted, and the cell contents richly protoplasmic. It will be seen that these cells, being sister cells of the members of the sieve-tubes, must be distinguished from the larger cells, which are usually termed "cambiform;" these latter being formed by division from formative cells of the bast, but not being in direct genetic connection with the cells, which develop into members of the sieve-tubes.

Dr. Wilhelm finds that the "callous" condition of the sieve-plate is not, as previously supposed, the result of a secondary change of the plate; on the contrary, the differentiation of the sieve-plate begins by the change of the cellulose to "callus" at a number of points. It is in the callus masses, formed at these points, that the pores of the sieve later appear. The callus may extend itself from these points so as to cover the whole face of the plate, and completely inclose the cellulose sieve. A callus-skeleton is thus formed which may be isolated.

The callus varies in volume, increasing with age, or on approach of the period of rest; in which case the pores may be completely stopped; or decreasing as the period of summer activity approaches, when the pores are again opened. This result may be obtained by artificial means. It is best seen in *Vitis*; it is probable that this variation of volume of the callus is by no means universal.

As regards the substance of the callus it will be seen from the following reactions that it cannot be identified with any of the substances previously described. With acids and alkalies it swells quickly; if the reagents be strong it is dissolved. Ammoniacal sub-oxide of copper attacks it only slightly, or not at all; by use of this reagent the callus-skeletons before mentioned may be obtained free. Solution of iodine in alcohol does not colour it; solution of iodine in potassium iodide colours it yellow to brownish yellow. This with Schultz's solution gives a deep red brown; when used alone the latter reagent gives no colour, but causes considerable swelling.

Thus far we have only discussed the cell walls. While the development of the sieve has been going on, but before the perforations are formed, a change appears in

the contents of the young sieve-tubes. Isolated drops or irregular masses appear in the layer of protoplasm lining the cell cavity before the disappearance of the nucleus. These consist of a slimy stuff (*Schleim*) apparently rich in nitrogen.<sup>1</sup> The separate masses later fuse together to form a band, which is usually much narrower than the girth of the cell. Between this and the wall of the sieve tube a protoplasmic envelope intervenes (*Hüllschlauch*). The central cavity within these is filled with "sieve-tube sap." For further details concerning the contents of the sieve-tubes the reader must be referred to the original work.

The author has not been able to observe directly the first appearance of connection through the pores of the sieve; but suggests that it is effected by the outgrowth of protuberances of the envelope (*Hüllschlauch*) from opposite sides of the sieve, which penetrate it and coalesce to form the connecting strings.

The presence of starch grains noticed by Briosi is confirmed by Wilhelm in *Vitis*. He finds them in members of sieve-tubes which are still closed. He opposes the idea that they pass through the sieve on ground of their size. In *Cucurbita* and *Lagenaria* they are absent. Besides the communication of sieve-tubes with one another laterally, so as to form a complete system, Dr. Wilhelm has observed in the case of *Vitis* a further connection, through the medullary rays, of tubes lying on opposite sides of the ray. This is effected by special sieve tubes, produced by transformation of cells of the medullary ray, so as to form a series of very short members; these correspond in development and structure with the ordinary sieve-tube. They traverse the medullary rays in an obliquely tangential direction. Such communications are not found in *Cucurbita* or *Lagenaria*.

The question of function has not been solved by these observations. Dr. Wilhelm still holds the view, propounded by Nägeli, that the function of the sieve-tube is the transference of indiffusible substances from place to place in the plant.

In conclusion it may be remarked that the paper is well written, but that it is of such a character as to be interesting only to the specialist. The plates, of which there are nine, are executed with great skill and exactitude.

F. ORPEN BOWER

#### OUR BOOK SHELF

*The Elementary Geometry of Conics.* By C. Taylor, M.A. Third Edition. (Cambridge: Deighton, 1880.)

MR. TAYLOR has been before the public as a writer on geometrical conics since 1863, in which year he brought out his "Geometrical Conics"; in 1872 we have the first edition, and in 1873 the second edition of his "The Geometry of Conics," a smaller work than his first book (1863). Now we have a third edition with the above title. In May, 1875, Mr. Taylor, in a paper entitled "On the Method of Reversion applied to the Transformation of Angles" (read before the Mathematical Society, and subsequently printed in a more extended form in the *Quarterly Journal*, No. 53, 1875, with the title "The Homographic Transformation of Angles"), called attention to a "neglected work on conics by G. Walker, R.S. (1794)": in this work we first meet with the properties of a circle, which Walker calls the *generating circle*, but which Mr. Taylor, in the work before us, styles

<sup>1</sup> Cf. De Bary, "Vergl. Anat.," p. 285.

the *eccentric circle*; in the free use of this circle consists the main feature in the alterations made in this new edition; further, though still keeping well in view the proving chord-properties independently of tangent-properties, there is a rearrangement of the text; so that the two properties are not treated of in distinct chapters. In other ways also we think this little work is improved, but we need say no more upon a third edition.

#### LETTERS TO THE EDITOR

[The Editor does not hold himself responsible for opinions expressed by his correspondents. Neither can he undertake to return, or to correspond with the writers of, rejected manuscripts. No notice is taken of anonymous communications.]

[The Editor urgently requests correspondents to keep their letters as short as possible. The pressure on his space is so great that it is impossible otherwise to ensure the appearance even of communications containing interesting and novel facts.]

#### Ceraski's New Variable Star

UNLESS the principal fact mentioned below has already come to your notice, you may like to bring it before the astronomical public in the columns of NATURE.

The true period of the variable star recently discovered at Moscow (*Durchmusterung*, zone + 81°, No. 25) appears to be two days and a half, instead of five as given in NATURE, vol. xxii. p. 455. Minima were observed at the Harvard College Observatory on September 23 and 28. The changes of the star will accordingly be visible in England on October 13, 18, 23, 28, &c., during the three or four hours before or after midnight. The rapidity of the change is probably greater in the case of this star than in that of any other known variable, the variation exceeding a magnitude in the course of one hour. The total variation is more than two magnitudes. A star of about the eighth magnitude (No. 30 of the same zone) is within a few minutes of the variable, and may readily be compared with it. The phenomenon of the variation is consequently a striking one, even as seen in a small telescope. The approximate place of the variable for 1881 is in R.A. oh. 51m. 48s., Decl. +81° 14' 1".

EDMUND C. PICKERING  
Harvard College Observatory, Cambridge, U.S., October 2

§ LORD LINDSAY'S Dun Echt Circular, No. 10, which I received on Saturday morning, October 23, prepared me to watch for a probable minimum of M. Ceraski's remarkable variable star B.D. + 81° 25' on the same night. From my observations the minimum appears to have occurred at about 11h. 10m. G.M.T., the star then being of about 9.1 magnitude. At 9h. 5m. I noted it about equal to a neighbouring star, B.D. + 81° 30', which I gauged 8.1 mag., and at 13h. 50m. it had regained the same magnitude. When about minimum I thought the variable to be slightly ruddy, but as it brightened up again it lost this tint and appeared to be white, or bluish white, as when I first observed it. It has a small bluish 11½ mag. companion, the P. and D. of which I roughly estimated to be 60" and 10" respectively. The star was observed by Carrington in 1855, on December 19, 21, and 30, his estimated mags. being 8.0, 8.0, 9.0. Possibly the star may have been near minimum at his third epoch.

Knowles Lodge, Cuckfield, October 25 GEORGE KNOTT

#### "Solid Ice at High Temperatures"

THE interesting results announced by Prof. Thomas Carnelley, of Firth College, Sheffield, in relation to the physical conditions under which ice persistently maintains its *solid state* when exposed to the influence of heat (NATURE, vol. xxii. p. 435), deserves some notice. When he speaks of obtaining "solid ice at temperatures so high that it was impossible to touch it without burning one's self," it is evident that this *burning quality* appertains to the hot vessel containing the ice, and not to the solid ice itself. For it is obvious that under the given conditions the temperature of the surface of the ice is kept at least as low as 0° C. by the rapid vaporisation of it while in a solid state.

The phenomenon of a body remaining persistently at a low temperature when surrounded by a hot vessel—through the influence of the rapid change of state—is analogous to the well-known results of Boutigny and Faraday in relation to the freezing of water and mercury in a hot vessel.

globules of sulphurous acid and liquid carbonic acid while in a "spheroidal condition." In these cases, notwithstanding the proximity of the hot vessel, the temperatures of the globules of SO<sub>2</sub> and CO<sub>2</sub> are respectively as low as - 10° and - 73° C.

It has long been remarked by physicists that some substances pass directly from the solid to the gaseous state, without undergoing liquefaction: that is, when heated, they sublime without melting. Such bodies, under ordinary atmospheric pressures, have their boiling points lower than their temperatures of fusion; hence they volatilise without melting. Moreover it has long been known that such substances may be made to fuse by subjecting them to an abnormal pressure sufficient to raise their boiling points above their points of fusion. Thus the classical experiments of Sir James Hall show that carbonate of lime may be fused when heated under a pressure sufficient to prevent the CO<sub>2</sub> from escaping (*Trans. Royal Soc. Edin.*, vol. vi. pp. 71-186, 1805). In like manner metallic arsenic sublimes without melting at 180° C., under the ordinary pressure of the atmosphere; but the experiments of Landolt in 1859 show that under artificial pressure it melts in globules at a low red heat. It is evident that in these cases the rapid vaporisation of the solids under ordinary circumstances prevents the temperature from reaching the point of fusion; but when subjected to additional pressure the conditions of liquefaction are secured. On the other hand, in the case of ice, it is obvious that the withdrawal of pressure by lowering its boiling-point places it in the same category with metallic arsenic under ordinary conditions of pressure.

In relation to the literature of this subject it is proper to add the following quotations from M. V. Regnault's "Elements of Chemistry" (American Translation, Philadelphia, 1865, vol. i. p. 279). In speaking of the fusion of metallic arsenic under pressure he says:—"The distance between the point of fusion and that of ebullition of any body may, however, be increased at pleasure. For the point of ebullition of a body is the temperature at which the tension of its vapour is equal to the pressure exerted upon it; and hence by increasing the pressure the boiling-point is raised without sensibly affecting the point of fusion." Again, he says:—"Reciprocally it is evident that a volatile solid body may be always subjected to so slight a pressure that it will boil at a temperature inferior to that at which it melts. Thus ice at the temperature of - 1° C. possesses an elastic force represented by 4.27 mm.; in other words, it boils at a temperature of - 1° C. under the pressure of 4.27 mm. Ice may therefore be entirely volatilised by ebullition under this feeble pressure, without reaching its point of fusion, which is 0° C."

Berkeley, California, September 30 JOHN LECONTE

### Wire Torsion

THE phenomena described by Major Herschel in his letter to NATURE, vol. xxii. p. 557, and about which he asks for information, are, we think, quite easily explained by what is known of the fluidity of metals. Yielding, or flowing, seems to occur in all metals after a certain limiting stress has been reached; indeed it probably occurs, although perhaps to an immeasurably small extent, even with small stresses (see *Proc. Roy. Soc.* No. 204, p. 411, 1880); but there is generally a limiting stress beyond which the increase of strain due to yielding becomes comparable in magnitude with the ordinary strains, which instantaneously disappear on the removal of the load. The bell-smith pulls his copper wire, and makes it much longer before he thinks it fit for use; in a similar way the telegraph constructor stretches, or kills the iron wire before he erects the line. Up to a certain limit of pulling force, the wire obeys the well-known laws of elasticity; slightly above that limit there is considerable fluid-yielding, there being but very little yielding below that limit; and at any instant during the lengthening if the man ceases to pull, the wire shortens a little. In fact at any stage the wire obeys the elastic law for small stresses. Eventually the man ceases to pull, knowing that the metal has lost most of its fluid properties, which can only be restored to it by annealing. The same thing occurs in brass, although to a smaller extent than in copper, which can be experimentally proved in the following way:—Stretch a piece of well-annealed brass wire in the manner described by Major Herschel until it is nearly breaking; and immediately set the wire vibrating. Now the note given out by the stretched brass wire, which, as is well known, depends on the tensile stress, will be found rapidly to go down in pitch. If the wire be tightened up again

and the pitch will again go down, but not so rapidly as before. Repeat this process until no flattening of the note is heard; then in this state we think that the experimenter will find the wire to break with much less torsion than before, and to obey Hooke's law more exactly. If it be desired to repeat the yielding or flowing process, the wire must be previously again annealed.

Mere sudden straining, even nearly up to the breaking stress, is not sufficient to destroy the fluidity of brass; time is required. The yielding behaviour of a brass beam when loaded has been studied by Prof. Thurston (*Trans. American Soc. of Civil Eng.* vol. vi. p. 28), and we may add that we have found that the permanent state is always more rapidly reached when the wire is subjected to rapid vibrations.

It may be because torsion of a wire is more visible than longitudinal strains (the twist being inversely proportional to the fourth power of the diameter for a given twisting moment, whereas the longitudinal strain for a given load is inversely proportional to the square of the diameter) that fluidity is so much more apparent in torsional experiments; but we think it probable that fluidity will be found always much more apparent when the volume of the material acted on is unchanged, that is, when the stress is mainly one of shear as it is in torsion.

However this may be we can explain why wire which has been "killed" for pulling forces is not "killed" for twisting, and why it is more difficult to kill for twisting than for tensile stresses. It is well known to wire-drawers that in whatever state copper or brass wire may be, whether annealed or not, it may be drawn smaller, although no doubt it requires less care to draw it if it is annealed. We cannot merely pull wire much smaller, it has to undergo a lateral pressure such as the die gives it. Now in twisting a wire it everywhere receives this lateral pressure, that is—imagine a right-handed spiral filament being lengthened by the twist—then the other component of the twist gives to the filament a compression at right angles to its length which enables it to extend. It seems that this lateral pressure is needed to overcome some sort of friction in the particles of the metal tending to prevent their moving into the axis of the wire; and which therefore is greater as the section of the wire is larger, and it is probably for this reason that a very thin wire extends much more, for a given initial length, before it is killed than a thick wire. We have known a length of about fifteen inches of fine copper wire which had just been drawn, and which had been well killed, to bear six or seven hundred complete turns in a lathe, one end being fixed, the other end turned, and the wire kept pretty taut before it was accidentally broken, and even afterwards parts of the wire could be considerably lengthened by pulling. The nature of the explanation of this apparent annealing for tensile stresses arising from previous torsion will be gathered from what follows.

We infer that the three or four turns given to the wire at the beginning in Major Herschel's experiment were not sufficient to produce permanent torsional set; why then should increasing the tension during the torsion cause torsional set as well as lengthening of the wire? This is, we think, a more important question than the one presented to us by the observations of fluidity in the latter half of Major Herschel's letter, and which arose from the metal having belonged to what Prof. Thurston calls the "tin class" as distinguished from metals of the "iron class."

The explanation we think is as follows, and it leads to the conclusion that torsional fluidity is not independent of tensile stress:—

Suppose right- and left-handed spirals had been imagined in the wire in question, making everywhere angles of 45° with the axis of the wire; then torsional strain, however set up, would consist in the production of a difference in length of these two sets of spirals. Now a twisting moment produces this effect; it lengthens, say the right-hand spiral and shortens the left, and we know that up to a certain limit, which is tolerably high, the same effect is produced whatever be the tensile stress in the wire, which latter simply tends to lengthen both spirals equally. In fact if Hooke's law is true, the torsion is independent of the tension. But above a certain limit of pull in the wire, the strain in the direction of the right-handed spiral being everywhere due to the sum of two tensile stresses, becomes so great that fluidity sets in and permanent set is produced; whereas in the direction of the left-handed spiral the stress is due to the difference between the tensile stress and the compressive part of the torsional shearing stress, and this difference being small, no permanent tensile set is produced, or at all events one much less than in the case of the other spiral. Consequently if all stresses now cease to act



a permanent difference would remain in the lengths of the two spirals, that is, there would now be a permanent twist.

Information regarding the fluidity of tempered steel, copper, brass, lead, tin, &c., will be found in the papers of M. Tresca, and in the second of the Cantor lectures delivered by Mr. Anderson before the Society of Arts April 19, 1869, as well as in Mr. Anderson's book on the "Strength of Materials," and in Mr. Bottomley's reports communicated at the Meetings of the British Association in 1879-80. We do not think, however, that much of the valuable information on the fluidity of metals which is scattered through the *Proceedings* of the different societies has yet been collated. Wire-drawers, watch and clockmakers, as well as the makers of philosophical instruments and of other small machinery, have a considerable amount of knowledge of this subject which they cannot systematise and make known to others, but which, nevertheless, they make ready use of in their work.

Finally, we would suggest that if Major Herschel wants his wire to obey Hooke's law for small twists only, he will not find it necessary to destroy the properties which are due to its being annealed. If, however, he desires to use greater twists, it will be necessary to leave the wire under a fairly large pull for a considerable time without twisting it until it ceases to continuously yield to tensile stresses of greater intensity than that of the shear stress to which it has afterwards to be subjected. And if in Mr. Allan Broun's gravimeter it be necessary to employ such large twisting couples as Major Herschel was using in his experiments, we would suggest the employment of a longer and thicker wire.

JOHN PERRY  
W. E. AYRTON

London, October 18

#### On the Skin-furrows of the Hand

IN looking over some specimens of "prehistoric" pottery found in Japan I was led, about a year ago, to give some attention to the character of certain finger-marks which had been made on them while the clay was still soft. Unfortunately all of those which happened to come into my possession were too vague and ill-defined to be of much use, but a comparison of such finger-tip impressions made in recent pottery led me to observe the characters of the skin-furrows in human fingers generally. From these I passed to the study of the finger-tips of monkeys, and found at once that they presented very close analogies to those of human beings. I have here few opportunities of prosecuting the latter study to much advantage, but hope to present such results as I may attain in another letter. Meanwhile I would venture to suggest to others more favourably situated the careful study of the lemurs, &c., in this connection, as an additional means of throwing light on their interesting genetic relations.

A large number of nature-prints have been taken by me from the fingers of people in Japan, and I am at present collecting others from different nationalities, which I hope may aid students of ethnology in classification. Some few interesting points may here be mentioned by way of introduction.

Some individuals show quite a *symmetrical* development of these furrows. In these cases all the fingers of one hand have a similar arrangement of lines, while the pattern is simply reversed on the other hand. A Gibraltar monkey (*Macacus innus*) examined by me had this arrangement. A slight majority of the few Europeans I have been able to examine here have it also.

An ordinary botanical lens is of great service in bringing out these minor peculiarities. Where the loops occur the innermost lines may simply break off and end abruptly; they may end in self-returning loops, or, again, they may go on without breaks after turning round upon themselves. Some lines also join or branch like junctions in a railway map. All these varieties, however, may be compatible with the general impression of symmetry that the two hands give us when printed from.

In a Japanese man the lines on both thumbs form similar spiral whorls; those of the left fore-finger form a peculiar oval whorl, while those of the right corresponding finger form an open loop having a direction quite opposite to that of the right fore-finger in the previous example. A similar whorl is found on both middle fingers instead of a symmetrically reversed whorl. The right ring-finger again has an oval whorl, but the corresponding left finger shows an open loop.

The lines at the ulno-palmar margin of this particular Japanese are of the parallel sort in both hands, and are quite symmetrical, thus differing from the Englishman's considerably. These in-

stances are not intended to stand for typical patterns of the two peoples, but simply as illustrations of the kind of facts to be observed. My method of observation was at first simply to examine fingers closely, to sketch the general trend of the curves as accurately as possible, recording nationality, sex, colour of eyes and hair, and securing a specimen of the latter. I passed from this to "nature-printing," as ferns are often copied.

A common slate or smooth board of any kind, or a sheet of tin, spread over very thinly and evenly with printer's ink, is all that is required. The parts of which impressions are desired are pressed down steadily and softly, and then are transferred to slightly damp paper. I have succeeded in making very delicate impressions on glass. They are somewhat faint indeed, but would be useful for demonstrations, as details are very well shown, even down to the minute pores. By using different colours of ink useful comparisons could be made of two patterns by superposition. These might be shown by magic lantern. I have had prepared a number of outline hands with blank forms for entering such particulars of each case as may be wanted, and attach a specimen of hair for microscopic examination. Each finger-tip may best be done singly, and people are uncommonly willing to submit to the process. A little hot water and soap remove the ink. Benzine is still more effective. The dominance of heredity through these infinite varieties is sometimes very striking. I have found unique patterns in a parent repeated with marvellous accuracy in his child. Negative results, however, might prove nothing in regard to parentage, a caution which it is important to make.

I am sanguine that the careful study of these patterns may be useful in several ways.

1. We may perhaps be able to extend to other animals the analogies found by me to exist in the monkeys.

2. These analogies may admit of further analysis, and may assist, when better understood, in ethnological classifications.

3. If so, those which are found in ancient pottery may become of immense historical importance.

4. The fingers of mummies, by special preparation, may yield results for comparison. I am very doubtful, however, of this.

5. When bloody finger-marks or impressions on clay, glass, &c., exist, they may lead to the scientific identification of criminals. Already I have had experience in two such cases, and found useful evidence from these marks. In one case greasy finger-marks revealed who had been drinking some rectified spirit. The pattern was unique, and fortunately I had previously obtained a copy of it. They agreed with microscopic fidelity. In another case sooty finger-marks of a person climbing a white wall were of great use as negative evidence. Other cases might occur in medico-legal investigations, as when the hands only of some mutilated victim were found. If previously known they would be much more precise in value than the standard *mole* of the penny novelists. If unknown previously, heredity might enable an expert to determine the relatives with considerable probability in many cases, and with absolute precision in some. Such a case as that of the Claimant even might not be beyond the range of this principle. There might be a recognisable Tichborne type, and there might be an Orton type, to one or other of which experts might relate the case. Absolute identity would prove descent in some circumstances.

I have heard, since coming to these general conclusions by original and patient experiment, that the Chinese criminals from early times have been made to give the impressions of their fingers, just as we make ours yield their photographs. I have not yet, however, succeeded in getting any precise or authenticated facts on that point. That the Egyptians caused their criminals to seal their confessions with their thumb-nails, just as the Japanese do now, a recent discovery proves. This is however quite a different matter, and it is curious to observe that in our country servant-girls used to stamp their sealed letters in the same way. There can be no doubt as to the advantage of having, besides their photographs, a nature-copy of the for-ever-unchangeable finger-furrows of important criminals. It need not surprise us to find that the Chinese have been before us in this as in other matters. I shall be glad to find that it is really so, as it would only serve to confirm the utility of the method, and the facts which may thus have been accumulated would be a rich anthropological mine for patient observers.

HENRY FAULDS

Tsukiji Hospital, Tokio, Japan

[Some very interesting examples of nature-printed finger-tips accompanied this letter.—ED.]

### Metamorphic Rocks, Ireland

THERE appears to be confusion as to the times when metamorphic action occurred among the Irish rocks; my experience would point to the following:—

In the Carnore district, South-East Wexford, there are metamorphic rocks for a long time supposed to be of Lower or Cambro-Silurian age; I however proved that they were upturned, contorted, metamorphosed, and denuded, prior to the overlying fossiliferous Cambro-Silurian rocks being deposited, and for the reasons given in the Geological Survey Memoir it is probable these metamorphic rocks are of Cambrian age.

In the hills north of Pomeroy, Co. Tyrone, there are metamorphic rocks, which were upturned, contorted, metamorphosed, and denuded, prior to the overlying fossiliferous "Pomeroy rocks" having been deposited. The fossils in the latter would point to their being Cambro-Silurians; consequently the metamorphic rocks are older, and for reasons given in a paper read before the Royal Irish Academy I believe they are the equivalents of the "great micaceous series," West Galway, or the equivalents of the Arenig group of Wales. That is either Upper Cambrian, or *Passage beds* between the Cambro-Silurian and Cambrian.

In Eris, North-West Mayo, there is a tract of excessively metamorphosed rocks, supposed by Griffith to be older than the associated altered Cambro-Silurians, and this opinion is shared in by Mr. McHenry, who more recently examined them.

From the above it is evident that there was a *period of intense metamorphism prior to the Cambro-Silurian age.*

The Cambrian (Arenig group?) and Cambro-Silurian of Galway and South-West Mayo must, in part, have been altered prior to the deposition of the Upper Silurians on them; while the general metamorphism of the South-East Ireland Cambro-Silurians, which was quite irrespective of the intrusion of the *Leinster granite*, was probably at about the same time. If the Comeragh Mountain rocks are Glengariff grits, *i.e.* Silurians, the age of the metamorphic action is evident, as in Waterford these rocks underlie those of the Comeragh Mountains. In addition to the general metamorphism in the rocks of South-East Ireland, there was also a local and secondary action in connection with the protrusion of certain granitic rocks.

The testimony of the West Galway and South-West Mayo rocks alone, however, would prove a *period of intense metamorphic action at the close of Cambro-Silurian time.*

In South-West Mayo, as proved by Mr. Symes and myself (*Maps and Memoirs of the Geol. Survey*), there is a considerable area of metamorphosed Upper Silurian rocks, which prove another *period of intense metamorphic action subsequent to the dawn of Upper Silurian times.* The secondary metamorphism previously mentioned in South-East Ireland may also be of this age, as the granitic rocks allied with the metamorphic, in both areas, are very similar.

Thus there are records of at least three periods of intense metamorphic action, and probably there were two others subsequently—one in the Triassic and another in the Miocene time—to account respectively for the metamorphic rocks in the neighbourhood of the Mourne granite, Co. Down, and those associated with the granitic rock near Portrush, Co. Antrim.

Formerly, as mentioned by me in the "Geology of Ireland," the period of greatest metamorphism was considered to have been at the close of the Cambro-Silurian time; now, however, more recent research has taught us that metamorphic rocks, formerly supposed to be Cambro-Silurians, are Cambrians; so it seems possible the metamorphic action prior to Cambro-Silurian time may have been greater than that subsequent to it.

Ovoca, Ireland

G. H. KINAHAN

### The Number of Known Species of Hemiptera-Heteroptera

As Mr. Pascoe, in his very "handy book of reference" for zoological classification, says of the Hemiptera-Heteroptera that "in round numbers there may be about 10,000 species in this sub-order," I am induced to give my census of the group.

On completing, about a year ago, MS. lists of the families which Stål unfortunately did not live to include in his "Enumeratio Hemipterorum," I was tempted to try and ascertain the total number of species that had been described. This I found to be about 7,800 (the actual number arrived at is 7,780). Of these 7,780 belong to the Geocorisæ or Gymnocerata (mostly but including four families which inhabit the

surface of water), and 334 to the Hydrocorisæ or Cryptocerata (almost all aquatic species). Of the Geocorisæ 1,503 are European, 3,248 are natives of the rest of the Old World, and 2,694 are American; of the Hydrocorisæ the corresponding numbers are 95, 120, and 119. The largest family of the Geocorisæ in Europe is the Capsidæ with 500 species, as against 134 and 312 in the rest of the Old World and America respectively. Amongst the Hydrocorisæ the family Corixidæ is most numerous in species, the numbers being: for Europe 72, the rest of the Old World 17, and America 34. But as these two families contain many inconspicuous species, and species having a strong resemblance *inter se*, and as Europe has been (naturally) more thoroughly investigated than the other regions, it is likely that many extra-European species of these families remain yet to be discovered.

Of what may be the actual number of species of Hemiptera-Heteroptera existing it is difficult to form an estimate. It is only of late years that much attention (comparatively) has been directed to the order, and from the number of new species sent home by the few collectors who condescend to collect bugs, it is evident that very great additions to the list will in course of time be made. Even within the last twenty years the list has been more than doubled, as in A. Dohrn's catalogue, published in 1859, only 3,627 are mentioned.

Of the sub-order Homoptera it would be rather difficult to make a census. In Dohrn's catalogue somewhere about 3,000 species are catalogued—a number not very far short of that of the Heteroptera. In the British and European lists the number of Homoptera is about two-thirds that of the Heteroptera.

Perth, October 19

F. BUCHANAN WHITE

### On the Classification of Rivers

IT has often occurred to me that a convenient classification of rivers might be obtained by arranging them according to their "water-discharge." Such a classification would not only indicate the relative position of one river to another in a descending scale, but would enable a rough estimate to be borne in the memory of the amount of water any particular river may discharge.

I therefore venture to suggest the following arrangement: and have given below the names of seventeen rivers, the discharges of which I have obtained from various sources, for which I would refer the reader to NATURE, vol. xxii. p. 486.

#### Discharge of Cubic Feet per second

First Rate. Above 2,000,000.	Second. Above 1,000,000.	Third. Above 500,000.	Fourth. Above 250,000.	Fifth. Above 100,000.
Amazon.	Congo.	Yang'tse. Plate. Mississippi.	Danube. Shat-el-Arab.	Ganges. Indus. Atrato. Nile. Yellow River.
Sixth. Above 50,000.	Seventh. Above 25,000.	Eighth. Above 10,000.	Ninth. Above 5,000.	Tenth. Below 5,000.
Rhone. Rhine. Po.			Pei-ho.	Thames.

Woodlane, Falmouth, October 19

H. B. GUPPY

### Yuccas under Cultivation

IN NATURE, vol. xxi. p. 315, in the report of the *Proceedings* of the Linnean Society, it is stated that "the yuccas fruit rarely under cultivation, the large white pendulous flowers being in the wild plant fertilised by a moth of the genus *Pronuba*." The yucca has been introduced and is very abundant in this colony, especially round Noumea. It fruits freely; in fact I rarely see a plant in which many, if not most, of the flowers do not produce seed-pods. In my own garden they seem to be fertilised by the common bee, of which I have a hive, others being in the neighbourhood. If I remember rightly, *Pronuba* is a genus of large moths having yellow underwings. We have a species identical with, or closely resembling, an old *Ceanothus* friend but it is rare; still it does exist here, and may assist in the

tion, though I should say, from the number of flowers fertilised, that other agencies preponderate.  
E. L. LAYARD  
British Consulate, Noumea, New Caledonia, July 31

#### Intellect in Brutes

I CONFESS I do not see much "intellect" in a snake biting its own tail (cf. NATURE, vol. xxii. p. 40); on the contrary, I consider the creature evinced remarkable stupidity. Perhaps however you will think what I now relate will show that snakes do possess reasoning powers.

Many years ago, while in Ceylon, I lived in a house in "Slave Island," raised on a high platform. The steps up to the door had become loosened, and behind them a colony of frogs had established themselves. One morning I watched a snake (a cobra) creep up, insert his head into a crack, and seize a frog, which he there and then swallowed. But the crack that admitted the thin flat head and neck of the ophidian would not permit of the same being withdrawn when the neck was swollen with the addition of the frog inside it. The snake tugged and struggled, but in vain, and after a series of futile attempts disgorged its prey and withdrew its head. But the sight was too tantalising. Again the head was inserted in the crack and the coveted morsel swallowed, and again the vain struggles to withdraw were renewed. I saw this repeated several times, till, gaining wisdom by experience, the snake seized the frog by one leg, withdrew it from its coigne of vantage, and swallowed it outside.  
E. L. LAYARD

I SEND you the following dog story, the truth of which is vouched for by the young lady who owned the animal. Her pet dog, a black-and-tan-terrier, was well known to the neighbours for his intelligence. He had established a remarkable friendship for a certain kitten, although given to fierce attacks on all others. This kitten was infested with fleas, which, when the dog discovered, he took her by the nape of the neck, in truly parental fashion, and *soused her up and down in a bucket of water*. He would then take her out into the sunshine and carefully pick out the drowned fleas.

A friend of mine, a naturalist, and a very conscientious man, whose word can be implicitly trusted, gives the following, to which he was an eye-witness. His grandfather, then a very old but hale and hearty man, had a splendid Newfoundland. There was a narrow and precipitous road leading from the fields to the house. It was regarded as a very dangerous place. One day when the old gentleman was doing some work about the farm his horse became alarmed and started off with the wagon along this causeway. The chances were that he would dash himself and the empty wagon to pieces. At once the dog seemed to take in the situation, although until that time he had been impassive. He started after the horse at full speed, overtook him, caught the bridle, and by his strength arrested the frightened creature until help could reach him. My friend gives many other stories of this fine dog, and thinks he had a decided sense of humour. I will repeat that both of these tales come to me well authenticated, and I could, by seeking permission, give names and places.  
W. WHITMAN BAILEY

Brown University, Providence, R. I. (U.S.A.), October 10

#### Atmospheric Phenomenon

LAST evening (October 21) at 5.45 p.m. I observed four huge radiating arms of faint white light, like the spokes of a gigantic wheel, rising from a centre apparently on the west-south-west horizon, and extending almost to the zenith. I say apparently on the west-south-west horizon, because an intervening house prevented me from seeing the nucleus of the diverging rays. The aspect of the phenomenon was more suggestive of an aurora than anything else I know of, but the beams of light seemed to be quite stationary, and although I fancied their brilliancy increased at one time for a few moments, I cannot be sure. Other fainter rays appeared to me to divide the west-south-west sky with those I have mentioned; but on that point I am also not sure. The sun set at 4.53 p.m., and twilight ended about 6.43 p.m., at which time the appearance I have attempted to describe was no longer visible. The sky was heavily clouded.

I should very much like to know the cause of this (to me) singular exhibition of light.  
B.

#### Temperature of the Breath

WITH reference to the high reading, 107°-108°, noticed by Dr. Dudgeon when a thermometer tightly wrapped up in the folds of a silk handkerchief was kept in the mouth for five minutes, might I ask Dr. Dudgeon if he has verified this reading by immersing the thermometer, with a handkerchief tightly rolled round its bulb, in a vessel of water, at say 108°, the temperature of the water being simultaneously taken by a standard thermometer with its bulb uncovered? It seems to me that there is some danger of actually squeezing up the reading of a delicate thermometer when twenty or thirty folds of a silk handkerchief tightly encircle its bulb.  
F. J. M. P.

October 23

#### Crossing Rapid Streams

HAVING read some letters lately in your paper on the subject of crossing rapid streams by means of carrying heavy stones, it strikes me that the following may be of interest to your readers. It is an extract from a survey report by Lieut. (now Major) Woodthorpe, R.E., written in 1876, describing the method, which he saw practised by men of the Nagà tribes, for crossing a deep stream too rapid for their feeble powers of swimming, and about twenty yards wide:—

"Taking large stones in their hands, they waded in up to their necks, and throwing up their legs and lowering their hands, the stones carried them to the bottom, along which they crept on all-fours till they reached the shallows on the other side."

The rough bottom afforded them sufficient hold to withstand the modified current and resist flotation.  
C.

Mussoorie, September 28

#### Construction of Telescopes and Microscopes

PERHAPS some of your readers may be able to inform me whether there exists in English or French a work on geometrical optics, in which the author applies himself thoroughly to explain the optical (not the mechanical) construction of telescopes and microscopes. Works like those by Parkinson and Polter stop short exactly where the application of theory to the construction of the best instruments begins.  
P. C.

September 30

#### BENJAMIN PEIRCE, F.R.S.

WE regret to have to record the death at Cambridge, Mass., on October 6, of Prof. Peirce of Harvard University, following upon an illness of three months from Bright's disease. Prof. Peirce was the son of a former librarian of the university, Benjamin Peirce, who died in 1831. For the past thirty-five years he has occupied a professorship at Harvard; and as a lecturer, author, thinker, and investigator, has not only ranked amongst the first of a numerous corps of professors, but also among the first of American men of science. Devoting himself originally to mathematics, Prof. Peirce has successively pursued exhaustive studies in all the branches more closely allied to mathematics, and has obtained eminence equally in physics, astronomy, mechanics, and navigation. His numerous investigations in these various departments, while read before various scientific societies, have been published, unfortunately, for the most part in the briefest possible form, and the results of many of his researches are to be found only in the manuals he published on various subjects. As an author Prof. Peirce was highly esteemed upon both sides of the Atlantic, his work on analytical mechanics, which appeared in 1857, being regarded then even in Germany as the best of its kind. His chief works are a "Treatise on Algebra," a "Treatise on Plane and Solid Geometry," "Pure Mathematics," a "Treatise on Sound," "Ocean Lanes for Steamships," "Tables of the Moon," "System of Analytic Mechanics," "Potential Physics," "Linear Associative Algebra," "Analytic Morphology," and "Criterion for the Rejection of Doubtful Observations." As a lecturer Prof. Peirce was highly esteemed in both scientific and popular

lectures on astronomy, he so excited the public interest that the necessary funds were supplied for erecting an observatory at Harvard. A remarkable series of lectures on "Ideality in Science," delivered by him in 1879 before the Lowell Institute in Boston, attracted the general attention of American thinkers, on account of the thoughtful consideration of the vexed question of science and religion.

Much of Prof. Peirce's activity was absorbed by his duties as the head of the American Coast Survey, a position in which he succeeded Prof. Bache. He brought to this work the same degree of zeal and ability which were so brilliantly evidenced by his predecessor, and constantly maintained the well-earned reputation of the Coast Survey among the hydrographic efforts of our day. Prof. Peirce was one of the founders of the American National Academy of Sciences. In 1853 he presided over the American Association for the Advancement of Science. The degree of LL.D. was conferred upon him twice, by the University of North Carolina (1847), and by Harvard University (1867). He was elected an Associate of the Royal Astronomical Society (1849), and a Fellow of the Royal Society of London (1852), and of the Royal Societies of Edinburgh and Göttingen.

Prof. Peirce leaves behind him his wife, a daughter, and three sons. Of the latter one is Professor of Mathematics at Harvard, and another is Professor at Johns Hopkins University.

#### RECENT CHEMICAL RESEARCH

THE masses of facts accumulated in the text-books on chemistry are already portentous: each month, almost each week, adds to the store.

The difficulty of getting a stable standing-ground from which to survey, in order, if possible, to find the meaning of these facts, increases likewise.

Fortunately from time to time there are found investigators who, turning from the easy toil of adding new compounds to those which are as yet but imperfectly known, concern themselves with the fundamental questions of chemical science.

Why are the properties of bodies so largely modified under certain conditions? This is the all-important question for the chemist. Before this question can be answered for a series of substances the properties of those substances must be accurately known, and the variations in their properties under varying conditions—themselves definitely ascertained—must be determined. Among the properties of substances those which we usually call physical are, as a rule, more susceptible of accurate measurement than those which we call chemical.

But these physical properties must be connected in some way with the chemical structure of the little parts, or molecules, of which we conceive the substances to be built up.

To determine what this connection is in the case of a definite physical property, and for a series of chemical substances, is at present one of the most promising problems which presents itself to the chemical inquirer.

But these physico-chemical problems require for their solution, a practical knowledge both of chemical and physical methods; methods of laboratory work and methods of reasoning on the results obtained. Students of nature trained in both methods are not extremely abundant.

The suggestion made in the preface to Armstrong and Grove's new volume on Organic Chemistry, that each chemical school should regularly prepare special series of pure compounds, and should let it be known that physical observers can procure these compounds in order to determine their physical properties, is well worthy of being acted on by all in whose hands may rest the arrangement of the work of any chemical school.

The older method of regarding chemical physics as consisting of a little chemistry loosely tacked on to a great deal of ordinary physics, is disappearing; and chemists and physicists now recognise that the problems which each attacks are, in very many instances, but different aspects of the same question.

The more thoroughly the chemical worker is trained in the correct use of dynamical principles and dynamical reasoning, the more likely is he to succeed in his search for chemical truth.

Very recently two papers have appeared, the contents of which illustrate the importance of the results obtainable by physico-chemical methods.

Brühl has published in Liebig's *Annalen*—and in a condensed form in the Berlin *Berichte*—the results of his investigations on the connection between physical properties and chemical constitution of carbon compounds; and Thomsen, in the *Journal für praktische Chemie* (and also in the *Berichte*) has given the first two instalments of his thermal work bearing on the isomerism of carbon compounds.

I propose to give a short account of the work of these two chemists: let us begin with Thomsen's.

The "heat of formation" of a compound substance is the difference between the sum of the heats of combustion of the constituent elements of the compound, and the heat of combustion of the compound itself. But this heat is not the true "heat of formation" of the molecule of the compound; it is only the algebraic sum of various heat disturbances. The thermal change which accompanies the formation of a compound molecule from various elementary molecules consists of various parts: (1) heat absorbed in dissociating the molecules of the different elements; (2) in some cases, heat absorbed in liquefying or gasifying the constituent elements; (3) heat evolved in the formation, from the dissociated elementary atoms, of the new compound molecules; and (4) in some cases heat evolved in the liquefaction or solidification of the gaseous compound molecules. If the physical state of the various substances concerned be constant throughout the experiment, (2) and (4) may be neglected; and the heat of formation will be equal to the difference between the heat absorbed in splitting the elementary molecules, and that evolved in the falling-together of the atoms so produced, in the new configuration. The value of the first part of this operation will always be constant for the same element or elements; but the value of the second part will depend upon the configuration assumed by the elementary atoms in the new compound molecules.

Now the generally accepted chemical theory of isomerism is that it (isomerism) is dependent on varying configuration of the same atoms. Some chemists have urged that isomerism is more probably due to the possession, by the different compounds, of different amounts of energy. But these two theories are really parts of the same theory. Thomsen's method, indeed, may be said to be based on this fundamental identity.

Given the dissociated elementary atoms, they may arrange themselves in various ways, each arrangement will be attended with a definite but different evolution of heat, hence, inasmuch as the heat absorbed in the preliminary elemental dissociation is fixed, the heats of formation of the various isomeric molecules will be different.

But when it is said that isomerism depends on atomic configuration, two things are included in this statement. Let us consider isomerism in a hydrocarbon: the carbon atom combines with four, and not more than four, hydrogen atoms to form a compound molecule. The carbon atom is said to be tetravalent; this is usually graphically expressed by the symbol  $=C=$ . The maximum number of hydrogen atoms which two carbon atoms can combine with to form a definite molecule will be six,

and the molecule will be graphically represented as

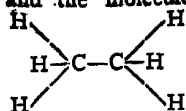

But we also know of a compound the molecule of which contains two carbon, but only four hydrogen atoms, this is represented as

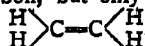

and a third hydrocarbon,  $\text{C}_2\text{H}_2$ , is represented as  $\text{H}-\text{C}\equiv\text{C}-\text{H}$ . In the first molecule the carbon atoms are commonly said to be "singly-linked," in the second "doubly-linked," and in the third "trebly-linked." We do not as yet attach any definite physical conception to these phrases; a compound said to contain "singly-linked" carbon atoms is, as a fact, incapable of combining with hydrogen or other monovalent element, whilst a compound said to contain "doubly-linked" carbon atoms can combine with two monovalent atoms for each pair of doubly-linked carbon atoms it is represented as containing; and a compound said to contain "trebly-linked" carbon atoms is capable of combining with four monovalent atoms for each pair of trebly-linked carbon atoms in the graphic formula thereof.

These are instances of isomerism said to be due to differences in the linking of the atoms of the isomeric molecules. But according to the generally accepted theory isomerism may arise among hydrocarbons in which all the carbon atoms are singly-linked; such isomerism is due to different relative arrangements of parts of the molecule. We may suppose all the carbon atoms arranged in a chain, or we may suppose ramifications of these atoms; thus the hydrocarbons represented as

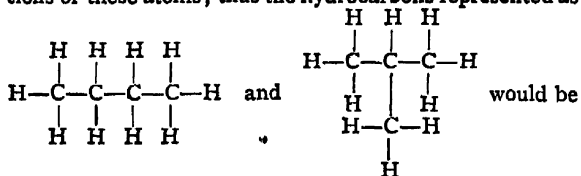

isomeric.

Thomsen deals only with isomerism due to differences in the linking of atoms. If from a certain number of dissociated carbon and hydrogen atoms a compound be produced containing only "singly-linked" carbon atoms, that compound is not capable of taking up any more hydrogen; but if a compound be produced containing "doubly-linked" carbon atoms, that compound is capable of taking up more hydrogen. But in the act of combining with more hydrogen, heat will be evolved; hence the heat of formation of the first compound is greater than that of the second. The heat of formation of an isomeric compound containing "trebly-linked" carbon atoms would be less than that of either of the preceding.

Thomsen, from the results of his own and other experiments, has calculated the heat of formation, from amorphous carbon, of a pair of singly-linked, a pair of doubly-linked, a pair of trebly-linked, and a pair of quadruply-linked carbon atoms. From these values he has calculated the heats of formation of isomers containing singly, doubly, or trebly-linked carbon atoms. The calculations involve certain assumptions, but the applications of his results to actual hydrocarbons show very close agreement between the calculated and the actually determined "heats of formation."

Thomsen furnishes us with a thermal value for the formation of each of the three possible linkings of the group  $\text{C}_2$  in the molecule of compounds. The value of this result to the chemist is great; a determination of the heat of combustion of a hydrocarbon may now yield him much information as to the structure of the molecule of that hydrocarbon.

Thomsen's results also strengthen the commonly-

accepted theory of isomerism, and they point towards a dynamical explanation of this theory and to the possibility of attaching a definite physical idea to the phrases "singly" or "doubly-linked" atoms.

As Thomsen has succeeded in tracing a quantitative connection between the heats of formation of certain molecules containing carbon and the linking of the carbon atoms in these molecules, so Brühl has shown that the linking of carbon atoms exerts a definite, measurable influence on the *molecular refractions* of compounds of this element.

Landolt showed many years ago, that in many compounds, the atoms of each elementary substance, possessed a definite specific refractive capacity independently of the way in which the atoms might be grouped.

Molecular refraction is defined as  $\left(\frac{\mu-1}{d}\right) \cdot M$ , where  $\mu$  = refractive index,  $d$  = density of substance, and  $M$  = molecular weight.

The difference between the molecular refraction of a compound containing carbon, hydrogen, and oxygen, and that of a compound containing the same number of carbon and hydrogen atoms, but free from oxygen, gave the atomic refraction of oxygen. Numbers were thus found expressing the atomic refraction of carbon, hydrogen, oxygen, and a few other elements. Gladstone and Dale showed, however, that the observed molecular refractions of many carbon compounds, especially the compounds existing in essential oils, were greater than the refractions calculated from Landolt's numbers: it seemed that the grouping of atoms did exert, in certain cases, an influence on the refractive power of molecules.

Brühl finds that certain groups of isomeric carbon compounds possess but one molecular refraction; in these groups the refractive power of the molecules is independent of the grouping of the atoms; in other isomeric groups, however, the molecular refraction varies. The members of the latter groups of isomers are always represented in structural formulæ as containing "doubly-linked" carbon atoms. Now if the molecular refraction be conditioned by the linking, but not by the grouping, of the atoms in the molecule, it follows that the atomic refraction of each monovalent element must be a constant number, inasmuch as there is but one way of linking a monovalent atom to other atoms. Such isomers as ethylene chloride,  $\text{Cl}_2\text{HC}-\text{CH}_2\text{Cl}$ , and ethylidene chloride,  $\text{Cl}_2\text{HC}=\text{CH}_2$ , should possess the same molecular refraction. But the atomic refraction of any polyvalent atom, e.g. oxygen, must vary according as the atom is linked by one, two, or more "bonds" to other atoms: such isomers

as allylic alcohol  $\begin{array}{c} \text{CH}_2 \\ || \\ \text{H}-\text{O}-\text{CH}_2 \end{array}$ , acetone  $\begin{array}{c} \text{CH}_3 \\ | \\ \text{C}=\text{O} \\ | \\ \text{CH}_3 \end{array}$ , and pro-

pylene oxide  $\begin{array}{c} \text{CH}_2 \\ / \quad \backslash \\ \text{O} \\ \backslash \quad / \\ \text{CH} \\ | \\ \text{CH}_2 \end{array}$  should possess each a distinct mole-

cular refraction. Brühl's actual results confirm these deductions. There is then a definite value for the atomic refraction of the carbon, or oxygen, atom according as that atom is "singly-linked" or "doubly-linked" to other atoms: in other words, the molecular refraction of a

compound containing the group  $\begin{array}{c} \diagdown & \diagup \\ & \text{C}-\text{C} \\ \diagup & \diagdown \end{array}$  is different

from that of the isomer containing the group  $\begin{array}{c} \diagdown & \diagup \\ & \text{C}=\text{C} \\ \diagup & \diagdown \end{array}$ ;

and the molecular refraction of a compound containing the group  $\begin{array}{c} \diagdown & \diagup \\ & \text{C}=\text{O} \\ \diagup & \diagdown \end{array}$  is different from that of the isomer

containing the group  $\begin{array}{c} \diagup \\ \text{C} \\ \diagdown \end{array} \text{—O—}$ . Brühl obtains a definite numerical value for the refractive power of each of these groups.

Now although the molecular refraction of isomers with similarly linked, but differently grouped, carbon or oxygen atoms is constant, the refractive indices and the densities of these isomers are not the same. There is, therefore, a definite connection between the densities and refractive indices of carbon compounds, and the grouping, as distinguished from the linking, of the atoms in these compounds. The densities and refractive indices of the isomers, ethylene chloride and ethylidene chloride (see *ante*) are not the same. Brühl has not determined any exact numerical value for the refractive power of this or that grouping of carbon or other atoms; generally, however, he has shown that the more ramifications there are in the structural formula of a carbon compound, the smaller is the density and the smaller the refractive index of that compound. Thus the density of butylic iodide,  $\text{CH}_3\text{—CH}_2\text{—CH}_2\text{—CH}_2\text{I}$ , is 1.6166, and the refractive index ( $\mu$ ) is 1.49601; but the density of the

isomeric isobutylic iodide,  $\begin{array}{c} \text{CH}_3\text{—CH—CH}_3 \\ | \\ \text{CH}_2\text{I} \end{array}$ , is 1.6056,

and the refractive index is 1.49192.

Generally, then, it would appear that when rays of light pass through a series of isomeric carbon compounds, the isomerism of which is traceable only to differences in the grouping of the constituent atoms, then that ray which passes through the densest compound is more bent from its original course than any of the other rays; but that when isomerism is due to differences in the linking of the atoms, then the amount to which the rays are bent is dependent not only on the density, but also on the molecular "structure" of the compounds.

Brühl considers also the connection existing between the boiling points, and other physical constants, of isomeric carbon compounds containing only singly-linked polyvalent atoms, *i.e.* compounds the isomerism of which is due only to variations in the grouping of the atoms, and the structural formulæ of these compounds. His results establish a considerable probability in favour of the rule, that in such isomeric groups, those compounds which have the smallest molecular volumes, have also the highest boiling points, greatest specific gravities and refractive indices (*not* greatest molecular refraction), and longest time of flow through capillary tubes; and very probably these compounds have also the smallest amount of ramification in their molecular structure.

Brühl thus put into the hand of the chemist another means whereby he may readily learn much concerning the inner structure of the substances which he examines. Brühl's results, as also those of Thomsen, exhibit a close connection between physical properties of compounds and the valency, or specific saturation power, of the elementary atoms which build up these compounds.

As the theories of modern chemistry are so largely based on the idea of valency, the results of Brühl and Thomsen are most welcome, as at once tending to confirm the general soundness of the methods of the Newer Chemistry, and exhibiting at least two measurable physical phenomena as closely connected with the exercise of valency.

The results of both observers emphasise the difference which chemists have long recognised between two kinds of isomerism: that due to "grouping," and that due to "linking" of atoms. Is it not at least possible, in view of these results, that a greater part of the chemical energy of molecules containing doubly (or trebly) linked polyvalent atoms is kinetic, than is the case in isomeric molecules, the atoms of which are all singly-linked? if indeed the chemical energy of the latter molecules be not wholly

potential. Double-linking might then mean greater kinetic energy; and the entropy of a molecule containing only singly-linked atoms would be greater than that of its isomer, some of the atoms in which were doubly-linked.

The consideration of valency of atoms is closely connected with the more general subject of chemical affinity; and the work of Thomsen and Brühl suggests many questions connected with affinity which press for answers.

A short account was given in this journal (vol. xx. p. 530) of the work of Guldberg and Waage, and of Ostwald, on chemical affinity. The latter naturalist has recently extended his methods of observation: in his earlier papers he used physical methods, determining the changes in the specific volumes, and also in the refractive indices, of solutions of acids and bases when these acted chemically on each other, and hence calculating the amount of chemical action. Ostwald now employs a more purely chemical method; he allows acids of known strength to react on a solid salt in excess, and determines the amount of action at definite intervals. His results, so far as they have extended,<sup>1</sup> strikingly confirm the numbers which he before obtained for the relative affinities of the commoner acids.

The application of the theory of Guldberg and Waage to reactions between a solid and a liquid, the former being in excess, requires that a definite and stable condition of equilibrium should be reached at the expiry of not too great a time. Doubt was thrown on Ostwald's results because it was said that such equilibrium had not been attained. In his latest paper Ostwald has carefully examined this point, and has shown that the required equilibrium is attained, and maintained, and that therefore such reactions are well suited for the study of general problems of affinity. Ostwald's future results, as he extends the application of the chemical method, will doubtless be very interesting.

All the work which has been here shortly noticed tells unmistakably that chemistry is rapidly passing out of the natural history stage of progress into that stage where her facts will be accurately grouped under general laws, which laws will admit of quantitative statement, and of quantitative deductions being made from them.

The recent work in chemistry also illustrates the need of a wide training in the methods of various sciences for the investigator of this branch of natural phenomena. One man begins with a purely chemical investigation, another with one which appears wholly physical; before long they find that their paths meet, and that the problem which each had attacked without thought of the other, can be solved, and even then solved but partially, only by the united effort of both.

M. M. PATTISON MUIR

## JAPAN<sup>2</sup>

### I.

MR. MURRAY is to be congratulated on being able to bring out simultaneously two such excellent books on a country which for some years has probably attracted more interest than any other country in the world. Although they both treat of the same subject, they differ much in their method of treatment. Indeed the one may be said to be complementary of the other; and any one who reads them both with care will be able to form a very complete idea of the present condition of an unusually interesting country and people. Sir Edward Reed went out practically as the guest of the Japanese Government, and had ample opportunities of seeing the

<sup>1</sup> His papers are in the *Journal für praktische Chemie* of the last and present year.

<sup>2</sup> "Japan: its History, Traditions, and Religions, with the Narrative of a Visit in 1870." By Sir Edward J. Reed, K.C.B., F.R.S., M.P. Two vols. With Map and Illustrations. (London: John Murray, 1880.) "Unbeaten Tracks in Japan." By Isabella L. Bird. Two vols. With Map and Illustrations. (Same Publisher.)

official side of the life of the country, of gaining a knowledge of what is being done to graft the results of Western civilisation on a civilisation centuries older, and which has been developed on totally different lines. From first to last he was in the hands of the leading Government officials of the country, who spared no pains to make his visit as pleasant as it could possibly be. During the whole of his three months' visit to the country, from the beginning of January, 1879, he had seldom an hour to himself, and what time he could subtract from his sleep was given to the writing up of his notes on his day's work, for work it must have been, harder than even an obstruction night in Parliament. From the young Mikádo down to the most subordinate provincial official, every one was anxious to convince the great English engineer that the enthusiasm with which they received him was genuine, and that they would only be too glad to let him inspect every detail of the great work they were endeavouring to carry out for their country. From beginning to end his visit to the country was a triumphal progress, and, as might have been expected, Sir Edward Reed left the country with a high opinion of its Government, and deeply impressed with the genuineness and thoroughness of its progress. Miss Bird, on the other hand, went to Japan, as she went to the Sandwich Islands and the Rocky Mountains, solely in pursuit of health, which she sought and found by travelling alone in those parts of the country rarely if ever frequented by foreigners, living in common inns and humble houses, and finishing up with a sojourn among that curious people known as the Ainos, the probable aborigines of Japan. She of course had every protection which the influence of Sir Harry Parkes, our representative, could procure her, and her passport was powerful enough to secure a courteous reception wherever she went; indeed she found travelling safer in Japan than it is in some European countries. To some extent it may be said that Sir Edward Reed was shown the outside and the brightest side of Japanese life, while Miss Bird plodded her way through the unfrequented heart of the country, and saw much of the light and shade in the everyday life of the common people. The two travellers had this in common, that no obstacle was put in the way of their seeing all that they desired to see, leaving one with the conviction that the Japanese Government has really nothing to conceal, and that their enthusiasm for progress is, for the present at least, genuine. Thus the two works, as we have said, afford a fairly complete picture of all sides of Japanese life.

Sir Edward Reed's headquarters were of course at Tokio, where he was courteously received by the young Emperor, who impressed him as a man thoroughly anxious to do the best he can for his people, but old and careworn beyond his years from the many trials he has had to undergo since his accession. Here he met with most of the ministers and other public officials, and he has a good word to say about every one of them. All the public sights were of course seen, and especially the great temples, both Shinto and Buddhist. Indeed a great part of the narrative is occupied with accounts of the numerous temples visited by Sir Edward, their architecture, ornaments, relics, and history, and the legends connected with them; and they seem to be all so much alike that we think some of the space thus occupied might have been devoted to other details of his interesting journey. After a month's stay in Tokio, Sir Edward and his son, who accompanied him, and a few of whose interesting notes are embodied in his father's narrative, were taken in a lighthouse steamer round the south coast of the main island through the Inland Sea to the outside of Shimonoséki Strait. The number of excellent lighthouses, constructed on the very latest principles, is remarkable in a country whose adoption of Western institutions is scarcely ten years old. Various points on the coast were

touched at, and the vessel finally left at Osaka. From this point the journey into the interior of the main island and back to Yokohama was performed in those curious man-cabs known as "jinriki-shas," which were only introduced seven years ago, but which look as long-established as cabs in London, up to Kioto, the old capital of the country, down to the sacred city of Nara, and back by the ancient Shinto shrines of Isé, at the south entrance to Owari Bay. During this busy journey the time not devoted to inspecting Shinto and Buddhist temples was spent in visiting public works of various kinds, manufactories, schools of all grades, dining, mostly in Japanese fashion, and being amused by dances and other spectacles of a strictly indigenous kind. How much the great bulk of the people have yet to learn is evident from the fact that in many parts of their route through the most frequented part of the country the people would crowd to the doors and run from their work in the fields to get a look at the "Chinese" riding in their jinriki-shas.

It would be impossible to give the reader any idea of one-tenth of the things which Sir Edward Reed saw and which he tells about. As an engineer he was naturally much interested in the public works and manufactures of the country, and the magnitude of some of the Government factories, and the perfection which they have already reached, impressed and delighted him. Even the engineering feats of Old Japan astonished him sometimes, as in the case of the great blocks of stone in the castle of Osaka, the beauty and grandeur of which he says it would be impossible to exaggerate. "The whole or most of the walls are notable for these very large blocks of granite, which vie with the largest of those built into the great pyramid of Cheops, near Cairo, in Egypt; but as the main entrance to the castle proper is approached, one sees block after block of the most astonishing proportions, until at and opposite to the entrance itself are single stones of such immense size that one is almost driven to doubt whether his senses are not deceiving him. It is so difficult to understand how such huge masses can have been quarried, transported, raised to such a height, and there worked into walls. I could not conveniently measure the largest stones, but I feel sure that some of them must be over twenty feet in height, nearly twice that in length, and several feet thick, and must weigh three hundred to four hundred tons."

Into their paper-manufacture the Japanese have introduced the best modern machinery, and paper has for centuries played an important part in the everyday life of the Japanese. Partitions, table-cloths, napkins, curtains, carriage-covers, and innumerable other things are made of this material, and Sir Edward thinks it would be a good thing to introduce some of the articles thus made into our own country. He paid much attention to the native art of the country, of which it is evident we have the most erroneous ideas. The ordinary reproductions of Japanese pictures which we see here, are wretched caricatures, and in this as in many other points we have much to learn before we have any adequate idea of the real nature of Japanese civilisation. They have ever so many schools of art going back for centuries, and many of their pictures are well worth studying, and capable of affording genuine pleasure. Their method of producing their famous lacquer-work, and their various contrivances for casting, interested him greatly, and he gives much curious information on these and similar matters.

Some idea of the multifarious industries of the country and of the zeal of the Government in encouraging them may be gathered from Sir Edward's account of the industries of Kioto. "Under the city government of Kioto there is an industrial department, the Kuwangiyoba, which was established in 1870 specially for the promotion of the industrial arts, and which has the following branches:—

1. An experimental gardening department (Saibaishi

Kenjo), commenced in 1872, for the cultivation of foreign and Japanese fruits and vegetables; 2. A shoe-manufactory (Seikuwajo), begun at the same time, for extending the manufacture of boots and shoes of European style; 3. A weaving-factory (Shokkoba), begun in 1873, where silks and other fabrics are woven, principally in foreign looms; this branch sent three workmen to Europe to learn the art of foreign weaving; 4. A physical and chemical branch (Semikiyoku), which has a sub-branch at Miyadju, in Tango, eighty miles distant, and which, with the assistance of two foreign workmen, is promoting and teaching the manufacture of chemicals, soap, effervescing and lemon drinks, *cloisonné* ware, porcelain, &c.; adjoining it is the Senkojo, for teaching dyeing on foreign methods; 5. The female industrial school, Jokoba, already mentioned; 6. The Bokujo, or more properly Bokuchikujo, which is an experimental farm, established in 1871 with the object of improving the breeding of cattle and of

teaching agriculture, the foreign cattle and sheep being chiefly purchased in America, and the milk produced being sold in the city; a branch farm exists at Komo in Tamba, about sixteen miles from Kioto; 7. A department (Yosanba) for promoting the multiplication of silkworms; 8. A pauper industrial department (Jusansho), established in 1869, with a branch at Dosembo, in the south-eastern part of Kioto County, where agriculture and the manufacture of earthenware are the principal employments of the pauper colony; 9. A street-sweeping department (Kuwakaisho), where compost is prepared on the French method; 10. A paper-manufactory, established in 1875. There exist also separate branches for making and teaching how to prepare leather, beer, and mineral waters. A museum is in course of formation."

Of course the educational establishments of the country interested Sir Edward greatly. We have heard much of the admirable university of Tokio and its famous engineer-

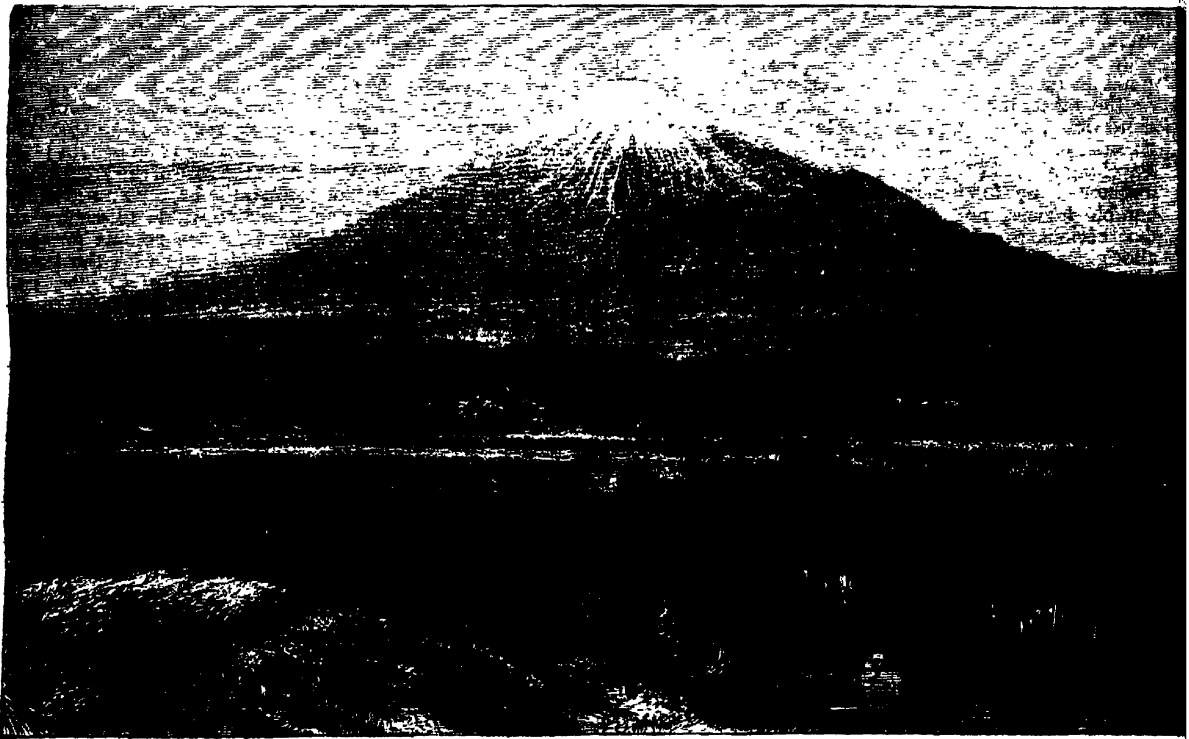

FIG. 1.—Mount Fuji.

ing school. But all over the country, at least so much of it as Sir Edward Reed visited, Government is evidently doing what it can to give facilities for education of the best kind. Schools of all grades and for all classes and both sexes are being everywhere established, and some of those Sir Edward visited seemed to be admirably organised, though some of the subjects taught, especially to girls, are amusing. We all know what a hold science has taken upon the Japanese ever since they opened their country to European and American influence. They have been shrewd enough to see that through the encouragement of science lies the surest road to national progress, and the Government has spared no pains nor expense to place education in science in the first rank; and this feature is seen throughout all their schools. The present purpose of the Government is evidently to make education universal all over the country, and to bring it up to a standard equal to that of the foremost countries in Europe. Every soldier Sir Edward Reed noticed in the

barracks at Osaka had a little library of books all to himself, and this is a relic of the old days of Japan, when the *samurai* class were at once the soldiers and scholars of the country. Sir Edward is sanguine enough to hope that the time may come in this country when soldiers will occupy a comparatively high position in the social scale, "and when the army will attract to it the surplus members of the civil community of all grades that are respectable and well instructed." Sir Edward was, moreover, struck with the size of the men in various parts of the country, as contrasted with the little fellows that are sent over here to be educated, and with the common idea entertained in Europe of the stature of Japanese. Indeed Sir Edward's testimony on this point is so novel and so different from that which has been generally accepted, that we should like to see some attention given to the subject by those in a position to throw light upon it. Sir Edward met at Kioto Mr. Akamatz, a highly-educated Buddhist priest, who had been to Europe to study and report on the



religions of the West, and who spoke English well. "It may be interesting," Sir Edward says, "to some of my readers to learn that this excellent priest, possessing a knowledge of England and the English, and also the chief priest who was our host on this occasion, find embraced in their section of the Buddhist faith all that they consider good and true in the Christian religion, and are not without hope of seeing England adopt this view, and with it the tenets and practice of their faith, which they consider most excellent. It will be gratifying, doubtless, to the many good people at home who look upon Buddhists as eligible for conversion to their particular views of the Christian religion (whatever they may happen to be in each case), to find their own generous and beneficent intentions so entirely reciprocated."

Over Sir Edward, as over others who have been to Japan, the quiescent (not necessarily extinct) volcano, Fuji-yama, seems to have exercised an influence akin to

fascination. He was never tired of looking at the snow-covered cone, rising nearly 13,000 feet above the sea in solitary grandeur, and like no other mountain in the world. For hundreds of miles around it is the prominent feature in the landscape, and the first object that meets the traveller's sight coming from south or east. "But the best evidence of the sacred character of Fuji is to be found, I think, in the fact that every person who speaks or writes about it seems naturally to rise more or less into a reverent state of feeling as he does so. It has a real, a strong, and a solemnising influence on all who behold it. Even when it is viewed from beyond other mountains, its sovereign character is very striking; and when it is seen springing with one tremendous and sublime flight from sea to sky, it is of more sovereign character still."

But the record of what Sir Edward Reed saw while he was in Japan forms a comparatively small part of the two

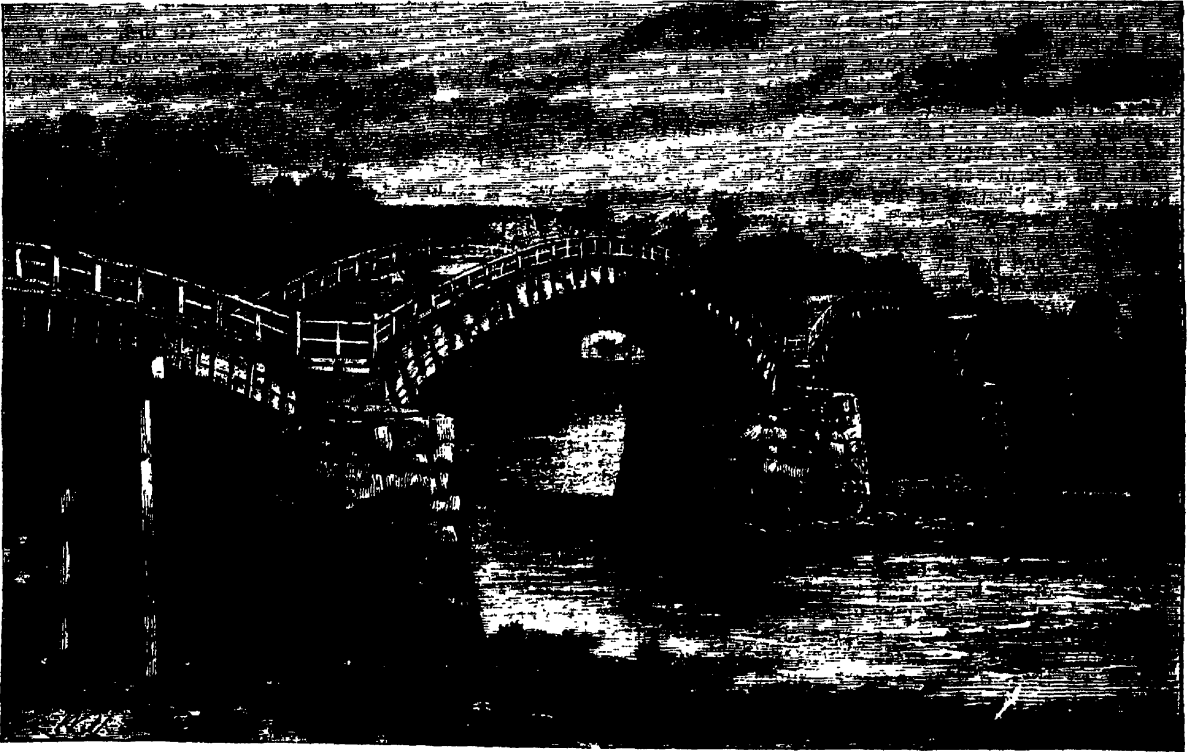

FIG. 2.—Curious Japanese Bridge.

volumes he has written. His interest in the country and its people is so great that he has put himself to considerable trouble to master their history, their religions, their political and social systems, their art and manufactures, in short everything that could enable him to understand a civilisation so real, but so entirely different from anything in Europe. The results of all this study, with the conclusions he has come to both from this and from his visit to the country, occupy a considerable part of the work. That a man of the scientific eminence and political experience of Sir Edward Reed should take so much interest in Japan seems to us a proof that it really deserves the attention of all thoughtful men; and whatever conclusions such an observer may come to ought to have considerable weight with those who are not quite sure what to think of the strange social and political phenomenon that has been taking place for upwards of ten years in the farthest East. Unless, however, the subject is

approached in the spirit with which Sir Edward Reed has taken it up, a spirit of thorough seriousness, with an adequate idea of the worthiness of the subject for earnest inquiry, it had better be left alone. A little learning here is a dangerous thing, and has led some triflers to find only amusement in Japanese history and Japanese ways, as if this were merely a toy civilisation, and not a complicated system which has been the development of ages. Sir Edward traces, in his first volume, the history of the Japanese from the earliest "God-period" down to the present time; discusses their two great religions, the native Shintoism and imported Buddhism, their political and social system, their foreign relations, the recent reforms, and the existing government. In the second volume, besides the narrative of his journey, he has interesting chapters on art and on the proverbs and phrases of the people; and both in the second volume and in the introduction he has elaborate

discussions on the ethnology of the Japanese, their language and literature. Sir Edward does not profess to know all these subjects at first hand, but has, with perhaps only one exception, chosen for his guidance the most trustworthy authorities attainable. Sir Edward gives several examples of what the Japanese language is capable of in the way of poetry; we have space for only one specimen:—

“Types of our children are the tiny grasses,  
Tender and fragile in the ample moorland;  
We know not to what fragrance their infant sprouts may blossom,  
Nor wist to what sweetness their unborn fruits may ripen,  
But hoping ever wait till autumn tells their story.  
Oh! cherished children, may ye never perish,  
Flowerless, fruitless, in the early springtime,  
Nor like this petal trampled by the wayside,  
Fall in the fuller promise of your prime.”

A people that are capable of thinking and writing thus deserve better than to be laughed at.

Sir Edward Reed left Japan with the highest respect for the people and their efforts to bring themselves abreast of the civilisation of Europe and the United States, and with a firm belief in the determination and earnestness of the Emperor and his ministers. He evidently is strongly of opinion that the new phase upon which Japan has entered is no mere spurt which will collapse in a few years, but a permanent change for the better in the direction of the civilisation of the country. That the result will be a complete assimilation to European ways, as some people seem to think and hope, is not to be wished for and not in the nature of things to be expected. With all their admiration for the science and the arts of Europe, the Japanese respect themselves sufficiently to see that there is much in their old civilisation that may well be retained. Indeed the problem is one of the meeting of two forces. A new force from an entirely different direction has struck in upon the course of the old civilisation, with the result of a permanent change of direction; but that change cannot be entirely in the direction of the new force. Nor will the final result be a lapse back into the old ways; even in the brief period since the country was opened to European influence the change has been so wide and deep that any such lapse is inconceivable. Those who are in the habit of decrying the country tell us that the Japanese are everything by turns and nothing long; their upwards of 2,000 years of gradual development in one direction, and their steady continuance in the course entered upon about fifteen years ago, belies the sneer, which probably owes its origin to that official quarter whose contemptuous treatment of the Japanese Government Sir Edward Reed so strongly laments. We earnestly hope that the Japanese will go on during the next fifteen years as they have done in the past, and by that time the current in the new channel will be so broad and powerful that it will require a force of equal power to seriously change its direction, and we do not know where that is to come from. The problem in national development being worked out by the Japanese is of the highest possible interest, and what is its real nature cannot be better learned than from the two valuable volumes which so busy a man as Sir Edward Reed has found time to put together.<sup>1</sup>

#### NOTES

THE foundation-stone of the new museum of McGill College, Montreal, to which we referred some time ago, was laid on September 21 by the Marquis of Lorne. Principal Dawson in thanking Mr. Redpath, the donor, for his generous gift, stated that the museum would be not merely a place for the exhibition

<sup>1</sup> For the illustrations in this article we are indebted to the courtesy of Mr. Murray.

of specimens, but a teaching instrument and a laboratory of original research; a great natural science department of the University, in which the classes in geology and biology would receive their instruction, original workers would be trained in all departments of natural science, and from which would go forth the men—and, he trusted, the women also—best fitted to bring to light the hidden treasures of the Dominion, and to avert by the aid of science the injuries with which any of its industries might be threatened. Dr. Dawson referred to other noble examples of private local or national liberality on the American continent, besides those of which Montreal can boast—to “the great National Museum at Washington, which is intended to rival, and if possible surpass, the British Museum; the Central Park Museum of New York, on which that great city has lavished vast sums of money; the Zoological Museum of Harvard, whose revenues would suffice to support some entire universities in this country; or the foundations of Mr. Peabody, which have established great museums in several American cities.” And he hoped that this latest gift to Montreal would stimulate other benefactions, especially for their Faculty of Applied Science, so that the physical apparatus and class-rooms of the University might be as well provided for as their natural science collections.

MR. MERRIFIELD, F.R.S., the retiring president, proposes at the annual meeting of the London Mathematical Society on November 11, to cast his valedictory address into the form of “Considerations respecting the Translation of Series of Observations into Continuous Formulæ.” The following is the proposed new Council:—Mr. S. Roberts, F.R.S., president; Dr. Hirst, F.R.S., and Mr. J. W. L. Glaisher, F.R.S., vice-presidents; Mr. C. W. Merrifield, F.R.S., treasurer; Messrs. M. Jenkins and R. Tucker, honorary secretaries; other members, Prof. Cayley, F.R.S., Mr. I. Hart, Prof. Henrici, F.R.S., Dr. Hopkinson, F.R.S., Mr. A. B. Kempe, Mr. R. F. Scott, Prof. H. J. S. Smith, F.R.S., Messrs. Lloyd Tanner, H. M. Taylor, and J. J. Walker.

WE take the following from the New York “Monthly Index to Current Periodical Literature,” &c.:—“The new Warner Observatory which is being erected at Rochester, N.Y., is attracting much attention in social and literary as well as scientific circles. The new telescope will be twenty-two feet in length, and its lens sixteen inches in diameter, thus making it third in size of any instrument heretofore manufactured, while the dome of the Observatory is to have some new appliances for specially observing certain portions of the heavens. It is to be the finest private observatory in the world, and has been heavily endowed by Mr. H. H. Warner. Prof. Swift has laboured under numerous disadvantages in the past, and the new comet which he recently found was in spite of many obstacles; but as the new institution is to be specially devoted to discoveries, there are good reasons to expect very many scientific revelations in the near future from the Warner Observatory at Rochester.”

THE *Times* has shown considerable pluck in having erected at its office one of Mr. Jordan's glycerine barometers, described in *NATURE*, vol. xxi. p. 377. In the issue of the 25th inst. and following days are published the readings of this gigantic barometer at intervals of two hours from 2 p.m. to 2 a.m. This will be continued regularly, a second edition of the paper giving the two-hourly readings from midnight to noon. These daily records with a barometer on such an enormous scale will be of the greatest value. The *Times* rightly states that it seems unquestionable that an instrument of this kind is admirably suited for practical use at meteorological stations, at seaports, in collieries, and in all other situations where it is of importance for the unpractised eye to notice frequently and easily the changes taking place in atmospheric pressure.

THE results of the observations made from the two balloons sent up from the Crystal Palace on Thursday last have not yet been discussed. But it may be stated that the direction of the wind was remarkably steady, as during the run the two balloons were constantly kept in view of each other in spite of the want of light and transparency of air. This result is all the more to be noted that the variations in the altitude of the two balloons were frequent and considerable, 0 to 5000 feet. The variation of temperature did not amount to more than 5° C. between the maximum of the readings and their minimum. A peculiar current was observed just on arriving on the coast, which is usual under such circumstances. The composition of the clouds was very complex. First, a layer of transparent fog covered almost the whole of the land and gave a watery appearance to it; second, cumuli described as analogous to pulled bread were floating at a height of 1000 metres and descended gradually as the sun was nearing to the horizon; and lastly, a large number of parallel strati stretching south-westerly in the direction of the sun, and seemingly diverging from it. The velocity of the wind was about half a mile per minute, and pretty well determined by observers located in one of the two towers of the Crystal Palace. As to the prognostication of the route, it was nicely done by Mr. Coxwell, who told M. de Fonvielle that he should land between Portsmouth and Winchester. A question arose between M. de Fonvielle and Commander Cheyne about the bearing, the latter's compass having been reversed by an optical illusion, but the azimuth was given with great accuracy, and the uncertainty between the two would not have lasted for a minute if the possibility of the error could have been ascertained. The swinging of the balloon round its axis was sufficient to prevent the use of a new compass designed on purpose for aeronauts.

It has been represented to us that in our notice of Prof. Owen's work the statement that "he was lecturer on palæontology at the School of Mines in Jermyn Street in 1856" may lead to a misapprehension. We have therefore to state that although Prof. Owen delivered a course of lectures in the theatre of the School of Mines in the year in question, he held no appointment in that institution.

MR. GRAHAM BELL has been honoured in the scientific, as well as other circles of Paris during the past week. He exhibited his photophone at the establishment of M. Antoine Breguet and elsewhere, and was the object of much curiosity wherever he went as "l'homme qui fait parler la lumière."

AT the opening meeting of the Geologists' Association on November 5, the president, Prof. Rupert Jones, will read a paper on the origin and progress of that society.

THE next number of the Victoria Philosophical Institute's *Journal* is announced to contain papers by Prof. Stokes, F.R.S., Prof. Hughes of Cambridge, Prof. Nicholson, M.D., F.R.S.E., of St. Andrew's, and Dr. Hormuzd Rassam, with maps and details of his discoveries.

MR. FLETCHER of Warrington has sent us a specimen of a new gas-heating burner which seems well adapted for many purposes and trades which are as yet unsupplied with satisfactory heating apparatus. It seems to us to have all the advantages claimed for it by Mr. Fletcher. It has from three to four times the power of any burner similar in appearance; the flame is *solid*, intensely hot, and perfectly free from smell; it gives a duty higher than the calculated theoretical maximum for the gas consumed, and it cannot be damaged by the dirtiest work. In case the perforated copper dome gets choked with dirt, it can when the burner is warm be lifted off and washed or brushed clean. Any liquid spilt so as to get inside the burner

the burner. The body of the burner is cast all in one piece, without a joint, thus doing away with one great fault, causing liability to leakage in most of the burners at present in use. Altogether this burner seems to be one of the greatest advances yet made in the practice of heating by gas. Mr. Fletcher has also sent us a useful practical paper on Heating (including cooking) by Gas, read the other day before the Philosophical Society of Glasgow.

PART iii. is to hand of the magnificent "Bedfordshire Pomona," the illustrations of the apples and pears in which continue to be as numerous and life-like as ever, so much so as to make one's mouth water. The papers in this part are on "The Crab, its Characteristics and Associations," by Mr. Edwin Lees, F.L.S.; "The Orchard, its Products: Cider and Perry," by the Rev. C. H. Bulmer; the latter a paper of considerable length, minute detail, and great practical value. Mr. David Bogue is the London publisher.

AMONG the lectures to be given this winter at the Museum and Library, Queen's Road, Bristol, are the following:— November 22, Prof. S. P. Thompson, B.A., D.Sc., "The Rainbow," illustrated with experiments by the electric light; January 17, 1881, Prof. Rolleston, M.A., M.D., F.R.S., F.L.S., Linacre Professor of Anatomy and Physiology, Oxford, "The Early Races of the British Isles"; January 31, Sir John Lubbock, Bart., M.P., F.R.S., F.L.S., "Fruit and Seeds"; February 14, Rev. J. M. Wilson, M.A., F.R.A.S., Head Master of Clifton College, "Double and Multiple Stars"; February 28, Dr. W. H. Stone, F.R.C.S., Lecturer on Physics at St. Thomas's Hospital, "The Measurement and Determination of Musical Pitch," illustrated with experiments; March 14, Prof. W. J. Sollas, M.A., F.R.S.E., F.G.S., Curator of the Bristol Museum, "Coal and the Bristol Coalfields."

WE have received the Catalogue of the General Lending Department of the Newcastle-on-Tyne Public Library, a very thick volume, with a much thinner one containing a list of the books of the Juvenile Lending Department. We may notice them more at length in a future number.

WE have received a very favourable Sixth Annual Report from the West London Scientific Association and Field Club, which commenced its new session on the second Tuesday of this month.

THE *Reports* of the Dunedin (N.Z.) Naturalists' Field Club for 1878-80 are, we regret to see, desponding. It finds some difficulty in keeping up the interest of its members, rather a strange thing in the land of the New Zealand Institute. The Report contains catalogues of the indigenous and introduced flowering plants occurring in the Dunedin district.

ON September 23 Rangoon was visited by three distinct shocks of earthquake; all parts of the province had previously been visited by shocks. A shock of earthquake lasting two seconds was felt at Cordova on the 21st inst., accompanied by a loud subterraneous rumbling. A slight shock, lasting six seconds, was also felt at Madrid on the same day. The shock was stronger in the centre of the city than in the outskirts, and shocks occurred in several towns of the province of Zamora, but no damage has been done. On the same date a shock, the after effects of which were felt in almost every part of the country, occurred both at Lisbon and Coimbra, without however doing any damage.

IT is stated that at the National Exhibition to be opened at Milan next year there will be a captive balloon, on the model of the one which was so successful in Paris in 1878. It will measure not less than 180 feet in circumference, 84 feet in

attached a safe and solid car, capable of containing seats for at least eight persons. A steam-engine is to regulate the ascent and descent, and it will rise to a height of about 900 feet, affording a splendid view of Milan and the plains of Lombardy. The balloon will be constructed at Milan, M. Henri Beudet, the well-known and experienced aeronaut, having been sent for to direct the work.

THE coal-beds on the Souris River, Manitoba, have proved very rich, and are to be developed during the winter.

THE Japan papers call attention to the almost limitless mineral wealth lying dormant in the country, and which is only waiting for development to become a profitable source of revenue. Of coal there is an abundant supply, but only the Takashima mine has been fitted with modern appliances. There are several other coal mines which are only unprofitable because improperly worked, and now it is averred that Prof. Atkinson during a sojourn in the Mitake Mountains of the Koshu Province has discovered another valuable deposit of coal.

MR. NORTH, who was sent by the Natal Government to examine the Newcastle coal-fields, has reported favourably on the quantity and quality of the coal.

ON Friday evening, October 22, previous to distributing at the Manchester Mechanics' Institute the prizes and certificates gained by the students at this year's Science and Arts, Society of Arts, City and Guilds of London Institute, and Union of Lancashire and Cheshire Institute's examinations, Prof. Ayrton delivered an address on Technical Education and on the future of Mechanics' Institutions. Of the two original objects for which Mechanics' Institutions were established fifty years ago, to provide clubs for artisans and places for giving popular scientific lectures, it was shown that the latter had to a great extent been abandoned; also that the mere novel utility of such institutions in furnishing the means for the holding of science and art classes would also be taken away from them when the teaching of elementary science became the duty of our elementary schools. There remained, however, for Mechanics' Institutions a great new field of activity in the teaching of applied science to mechanics, not the teaching of abstract scientific principles and the applications only perhaps afterwards, but the teaching of these scientific principles through the apparatus in use in daily life; in fact, that Mechanics' Institutions could well furnish the machinery by means of which numerous technical classes throughout the country which were so much needed could be rapidly established, the money voted by the City and Guilds of London Institute as payment on the results of the technological examinations, together with funds locally subscribed, furnishing the motive power. What the lecturer thought technical teaching should consist of was illustrated by the kind of work now going on at the temporary laboratories of the City Guilds Institute at Finsbury; stress was laid on the fact that there were no distinct students' fees there for laboratory work and for lectures, but that every fee, small as it was, entitled each student to at least two hours' practical work in the laboratories for every one hour of lecture; so that in fact all the 150 students had laboratory work which did not consist in the mere repetition of qualitative lecture experiments, but in the making of accurate quantitative measurements, all bearing as far as possible directly on each student's trade. Of this practical illustrations were given. Prof. Ayrton concluded by warning technical instructors from attempting to follow ordinary college methods of *synthetical* teaching, which, although most valuable for a young lad prepared to spend several years at college, was quite unsuitable for an artisan engaged all day in following his trade. Technical education, he considered, must be distinctly *analytical*—the complete machine as the artisan knew it must be taken at once, and the science developed,

so to say, from the machine itself; and that it was men with a good practical knowledge of their trade and with an aptitude for science rather than men versed in science, but with only a mere book knowledge of industries, that were wanted both as candidates for the technological examinations and as students to be trained up as technical instructors.

IN the note on the late Dr. Sparks in NATURE, vol. xxii. p. 591, for Dr. King's "Therapeutics" read Dr. Binz's "Therapeutics."

THE additions to the Zoological Society's Gardens during the past fortnight include a Macaque Monkey (*Macacus cynomolgus*) from India, presented by Mr. W. B. Tustin; two Polar Bears (*Ursus maritimus*), an Ivory Gull (*Larus eburneus*) from the Arctic Regions, presented by Mr. Leigh Smith, F.Z.S.; a Crested Porcupine (*Hystrix cristata*) from India, presented by Mr. W. Middleton; three Gaimard's Rat Kangaroos (*Hypsiprymnus gaimardii*) from Australia, presented by Mr. A. B. Gow; a — Brocket (*Cariacus sp. inc.*), a White-bellied Opossum (*Didelphys albiventris*), a Brazilian Hare (*Lepus brasiliensis*) from Quipapá, Pernambuco, a White-bellied Guan (*Ortalia albiventris*), a Black Tortoise (*Testudo carbonaria*) from Maranhuns, presented by Mr. W. A. Forbes, F.Z.S.; a Frigate Bird (*Fregata aquila*) from Fernando de Noronha, presented by the Rev. G. Bayldon; a Yellow-headed Conure (*Conurus jendaya*) from Pernambuco, presented by Mr. C. A. Craven; two American Black-backed Geese (*Sarcidiornis carunculata*) from the Seratoes of Pernambuco, presented by Miss Davis; a White-throated Finch (*Spermophila albogularis*) from Pernambuco, presented by Mr. S. Jones; a Herring Gull (*Larus argentatus*), British, presented by Mr. J. Palmer; a Horrid Rattlesnake (*Crotalus horridus*) from Quipapá, Pernambuco, presented by Mr. H. E. Weaver; a Bonnet Monkey (*Macacus radiatus*) from India, a Black Iguana (*Metopoceros cornutum*) from Galapagos (?), deposited; a Rock Cavy (*Cereton rupestris*), a Green-winged Trumpeter (*Psophia viridis*), a White-bellied Parrot (*Caica leucogaster*), a Red-vented Parrot (*Pionus menstruus*), two Golden-headed Parakeets (*Brotogerys tui*), two Toco Toucans (*Ramphastos toco*), an Orinoco Goose (*Chenalopex jubata*) from Brazil, a Rufous Pigeon (*Columba rufina*), a Yarell's Siskin (*Chrysomitris yarelli*), two Scaly Doves (*Scardafella squamosa*) from Parahyba, three Picauro Pigeons (*Columba picauro*), a Black Tanager (*Tachyphonus melaleucus*), a Black-headed Tanager (*Orchesticus ater*), a Passerine Ground Dove (*Chamaepelia passerina*), three Yellow-shouldered Hangnest (*Icterus tibiatis*), from Pernambuco, a Brazilian Tanager (*Ramphocelus brasiliensis*), a Blue and Black Tanager (*Calliste brasiliensis*) from Bahia, a White-eyebrowed Guan (*Pendolope superciliaris*) from Panellas, four Cactus Conures (*Conurus cactorum*), two Banded Tinamous (*Crypturus noctivagus*), seven Tataupa Tinamous (*Crypturus tataupa*) from Maranhuns, a Great-Billed Rhea (*Rhea macrorhyncha*) from Agoas Bellas, Pernambuco, two Orchard Hangnests (*Icterus spurius*), a Baltimore Hangnest (*Icterus baltimore*) from North America, purchased; two Squirrel-like Phalangers (*Belideus sciureus*), born in the Gardens; a Macaque Monkey (*Macacus cynomolgus*) from India, presented by Mr. F. W. Manley; a Dunlin (*Tringa cinclus*), a Sanderling (*Calidris arenaria*), British, presented by Mr. Edmund Elliot, M.R.C.S.; a Horned Lizard (*Phrynosoma cornutum*) from Texas, presented by Mr. W. C. Boyd; a Waxwing (*Ampelis garrulus*), European, deposited; a Black Saki (*Pithecia satanas*) from Lower Amazons, a Roseate Spoonbill (*Platalea ajaja*), a Great-billed Rhea (*Rhea macrorhyncha*) from South America, purchased.

#### OUR ASTRONOMICAL COLUMN

CERASKI'S VARIABLE OF SHORT PERIOD.—It will be seen from a letter which Prof. Pickering, the Director of the Observatory of Harvard College has addressed to us, that, contrary to

the opinion expressed by Dr. Julius Schmidt from his earlier observations, the true period of this notable variable star, instead of being a little less than five days, appears to be a little less than half this interval, otherwise *minima* observed at Harvard College, will not accord with those of May and August observed in Europe.

It is probable that Schwed observed the star near a *maximum* at meridian transit at Speyer on March 11, 1828, when he estimated its magnitude 6.7, and near a *minimum* at transit on May 12 in the same year, when he rated it only 10m. If we compare the observation of March 11 with that of Dr. Schmidt, who fixed a *minimum* to August 12 at 6h. mean time at Athens, and assume 7662 periods to be included in the interval, we get for the duration of one period 2.49084d., or 2d. 11h. 46.81m., which closely accords with half the period assigned by Schmidt from his own observations and those of Ceraski. This reckoning from August 12 1841 Greenwich mean time, and correcting for the light-equation, will give the following times of geocentric minima observable in this country:—

	h. m.	G.M.T.		h. m.	G.M.T.
Oct. 28 ...	9 33		Nov. 17 ...	7 47	
Nov. 2 ...	9 7	"	22 ...	7 21	"
7 ...	8 40	"	27 ...	6 54	"
12 ...	8 14	"	Dec. 2 ...	6 28	"

And for the times of visible maxima, supposing this phase to occur midway between the minima, we find—

	h. m.	G.M.T.		h. m.	G.M.T.
Oct. 29 ...	15 27		Nov. 18 ...	13 40	
Nov. 3 ...	15 0	"	23 ...	13 14	"
8 ...	14 33	"	28 ...	12 48	"
13 ...	14 7	"	Dec. 3 ...	12 21	"

If S be the sun's longitude, and R the earth's radius-vector, the correction for the light-equation (geocentric—heliocentric) for 1880 may be found from

$$\text{Cor.} = 224.08 R. \sin(S + 19^\circ 17'4).$$

We have received from Lord Lindsay a circular containing the same information that is given in Prof. Pickering's letter, with the addition of a diagram showing the *Durchmusterung* stars in the vicinity of the variable, which for 1881.0 has R.A. oh. 51m. 48s., N.P.D. 8° 46'.0.

[Mr. Knott's observation on October 23, received since the above was in type, as compared with Athens, August 12, seems to require a somewhat longer period, with minima a half hour or so later than we have computed.]

**THE ROTATION OF JUPITER.**—In No. 2,342 of the *Astronomische Nachrichten* (to which we refer for numerical details) Dr. Julius Schmidt has a communication wherein he finds, from observations of the red spot upon the disk of Jupiter by himself and others in 1879–80, an interval of 9h. 55m. 34.4s. for the time of the planet's rotation upon its axis, a result that he considers may be adopted until the observations generally have attained a greater degree of precision than they appear to possess at present. With due care and practice, however, he believes that such observations will be found to admit of much greater accuracy, and illustrates this by his own experience at Athens in the present year. In the same communication he also discusses observations of a dark oval spot (a more favourable object than any used by Airy and Mädler) during 104 rotations in 1862; these observations give 9h. 55m. 25.68s. for the period of rotation, a result closely agreeing with those of 1834–35.

### CHEMICAL NOTES

A NEW method of preparing acetylene is described by Dr. W. Suida in *Wien. Akad. Ber.* The method consists in heating iodoform and mercury ethide in sealed tubes to 120°; the products of the reaction are acetylene, ethylene, ethylic iodide, and mercury ethylidide.

The same *Berichte* contains a paper by Herr v. Dumreicher on the relative stabilities of nitrous and nitric oxides, and of nitrous and nitric oxides when acted on stannous chloride. Nitrous oxide is not reduced even at 100°; nitrous acid is reduced to nitrous oxide; nitric oxide and nitric acid are reduced to hydroxylamine, and subsequently to ammonia. The reaction may be applied to the estimation of nitric acid.

In the *Proceedings* of the Academy of Rome Signor Cossa communicates the results of experiments on didymium tungstate; he has determined the specific heat of this salt to be 0.0831—

temperature limits are not given. Taking the atomic heat of tungsten as 6.4, and that of oxygen as 4, this result points rather to the formula for didymium tungstate,  $\text{DiWO}_4$  ( $\text{Di} = 98$ ), than to that now generally accepted,  $\text{Di}_2(\text{WO}_4)_3$  ( $\text{Di} = 147$ ).

A NEW organo-metallic compound containing the divalent radicle  $(\text{CH}_2)_2''$  is described in the *Journal* of the Chemical Society by Sakurai; the formula of the new substance, for which the name *Monomeric methylene iodide* is proposed, is  $\text{I}(\text{CH}_2)_2\text{HgI}$ . This is the first known metallic compound containing a *divalent* hydrocarbon radicle.

G. BOUCHARDAT claims, in *Compt. rend.*, to have converted amylene, by successive removals of hydrogen, into cymene. Hitherto attempts to pass, by a simple series of reactions, similar to those by which the passage from one isologous group to another is effected, from the paraffin to the aromatic group of compounds, have not been successful.

ACCORDING to the experiments of Macagno (*Bid. Centralblatt*) the mellowness of old wine is due more to an increase in the amount of glycerine present, than to a decrease in the tannin; there must also be a certain proportion between the amounts of alcohol and tannin, in order that the wine may keep well.

In the *Annales Chim. Phys.* Berthelot describes an apparatus in which the combination of two gaseous constituents to form a gaseous compound may be conducted, so as to allow of an accurate measurement of the thermal change which accompanies the chemical change.

A DISCUSSION as to the value to be assigned to the atomic weight of antimony is at present being carried on. From analyses of the bromide and other salts, Prof. Cooke of Harvard concludes that the generally-accepted number, 122, is too large, and that 120 is more nearly correct. Herr Schneider, whose experiments had been criticised by Cooke, replies in the *Journal für Pract. Chem.* He sharply criticises Cooke's methods, gives the details of new experiments, and asserts strongly that 122 is much more nearly correct than 120.

No results of special importance have lately been published regarding the densities of the vapours of the halogen elements. An objection made by Pettersson and Ekstrand to V. Meyer's method, viz. that solid bodies condense air on their surface, which air they again give up when strongly heated, has been shown by Meyer, in the last number of the Berlin *Berichte*, to have no weight against his experiments.

TWO important papers on atmospheric ozone have been published in the *Berichte* by E. Schöne. This observer, who has given much careful study to the subject of ozone, says that the smell of ozonised oxygen does not at all resemble the peculiar odour noticed after a lightning flash. The true smell of ozone is, however, frequently noticeable in ordinary air, and coming from the clothes of persons who may enter a room from the open air in winter. The ordinary potassium iodine papers are valueless as ozone measurers, according to Schöne. A small amount of ozone in moist air produces a greater depth of colour on these papers than a larger amount of ozone in dry air. The humidity of the air and the hygroscopic character of the material from which the paper is made therefore largely influence the depth of colour produced. It has been supposed that much ozone is produced in the neighbourhood of waterfalls, but the increased depth of colour of the potassium iodide papers is only due, says Schöne, to the great humidity of the air. Schönbein's "ozonometer" serves as a very rough hygrometer. Paper coated with thallic hydrate is recommended as a measurer of the relative amount of "oxidising principle" in the air: the paper is coloured brown—owing to production of thallic oxide—by ozone or hydrogen peroxide. A table is given showing the variations in "oxidising principle" during 1879. The general conclusions are briefly these:—1. The papers are coloured more deeply during the day than during the night; this difference is more apparent during the long days of the year. 2. Increased wind-force causes increased coloration, because a greater amount of oxidising substance is brought in contact with the paper during the time of exposure. 3. Cloudiness and rain especially influence the coloration; the heavier the rain the smaller the coloration of the paper. Direct determinations of hydrogen peroxide have shown that when the thalium papers are much coloured this compound is present in the atmosphere in comparatively large quantity. Herr Schöne regards the actual existence of ozone in the atmosphere as at present an open question.

MR. A. VILLIERS publishes in the September number of *Annales Chim. Phys.* a lengthy and important paper on the

conditions of equilibrium of mixtures of alcohols and mineral acids. He considers in detail the velocity, and limits of etherification of the more important mineral acids, and arrives at many valuable results.

### GEOGRAPHICAL NOTES

AT the last meeting of the Berlin Geographical Society news was received through a German trade house in Tangier that Dr. Lenz had reached Timbuctoo, and that he hoped to be at St. Louis, in Senegal, in the month of July. If this is correct Dr. Lenz has made a rapid journey in this direction, as he only left Tangier on December 22 last. Caillé, however, in 1828, travelled from Timbuctoo to Fez in four months. The last letter received from him by the Society was from Tenduf, in the beginning of May, twenty days' journey from Timbuctoo.

THE *Zeitschrift* of the Berlin Geographical Society, Nos. 88, 89, has a valuable map by Herr Richard Kiepert, showing the work done in Angola in 1876 by Dr. H. von Barth in the region of the Bengo and Lucalla, and of Herr Otto Schütt in 1877-79 on the Lower Quanza. Dr. von Möllendorff discusses the methods of transcribing Chinese geographical names, and concludes that the Pekin form of the Guan-hua, or so-called Mandarin dialect, would be best for general purposes. But Dr. von Möllendorff asks whether, while selecting this form generally, it is advisable to make exceptions in certain cases. Such names, for example, as already exist in familiar forms might be excepted, as Pekin, Canton, Hongkong, Swatow, &c. With other names, especially for special maps, a change from the uniform method of writing might be adopted. Maps of districts for the use of travellers would evidently be of greatest service when the local forms of names were given. Perhaps the Guan-hua might be used for the names of great towns, large rivers, and mountains, while smaller places might have the local forms of their names. For a map of the whole of China, or of the greater part of it, containing little more than the district towns, evidently the Guan-hua would be the preferable form. In books it would perhaps be best to give both forms. It is, no doubt, high time that some attempt at uniformity should be made, but the difficulty is by no means easy of solution, owing partly to the letters of the alphabet not being sounded uniformly in all European languages. Herr von Möllendorff instances the absurdity of the present want of system by the ways in which the Chinese name of the Yellow River is spelled. These are confusing enough, but what will he say when he sees "Houan Hé" (for Hwang-ho) at the head of the interesting communication just received from Col. Prejevalsky? We cannot entirely concur in Herr von Möllendorff's definition of "Kwan-hwa," popularly translated "Mandarin dialect," and he himself makes the orthographical jumble much worse by writing "Guan-hua," which we should imagine few sinologues would attempt to defend. The vexed question, however, may find a solution before long in an unexpected quarter, for the Statistical Department of the Chinese Maritime Customs at Shanghai, we believe, have under consideration a system of spelling for adoption in their reports and other publications, and this, if adopted, will probably come by degrees into general use. Dr. Hildebrandt gives an account of a visit he made to the Amber Mountains in the north of Madagascar; Herr K. Himy continues his elaborate paper on the region around the Kara-Kul, and much of the number is occupied with the journal in North Africa of the late Dr. Erwin von Bary.

The new number of the Lyons Geographical Society's *Bulletin* contains several items of interest. M. Morice's paper on French Cochinchina is published with a sketch map, followed by some notes by the Abbé Desgodins on the hydrography and orography of Tibet, and a communication by the Abbé Faure on Potosi in Bolivia. Among the other contents are Père Brucker's notes on the geographical positions in Eastern Turkistan and Jungaria determined in 1876 by two Jesuit missionaries, and the report on Col. Flatters' explorations in the Central Sahara last spring.

M. VENUKOFF has just published at Geneva an historical sketch of the geographical discoveries made in Asiatic Russia from the most remote times to our own days, illustrated by Perthes' map of North and Central Asia.

THE China Inland Mission have been informed by Mr. Samuel Clarke, one of their agents in the Chinese province of Szechuen, that, in company with Mr. Mollman, of the British and Foreign

Bible Society, he lately made a journey from Chungking, on the Upper Yangtze-kiang, to Chéngtu-fu, the capital of the province, on which he travelled by unfrequented roads, where, so far as he could learn, no foreigner had ever been seen before; several previously unvisited towns were also entered. Mr. Clarke calls especial attention to the commercial activity prevailing along his route, and the frequency with which markets were held.

THE Asiatic Society of Bengal have just published, as an extra part of their *Journal*, a "Vocabulary of the Language of Eastern Turkistan," by the late Mr. R. B. Shaw, the well-known traveller, supplemented by two Turki vocabularies of birds and plants by Mr. J. Scully, lately on special duty at Kashgar.

FROM the Vienna *Allgemeine Zeitung* we gather that Dr. Emil Holub contemplates undertaking another lengthened journey in Central South Africa, providing that he can obtain the necessary funds. It is estimated that 50,000 florins will be required for the purpose, and it is proposed to raise this sum by a public subscription, the Austrian Geographical Society heading the list.

THE September number of the *Boletín* of the Madrid Geographical Society contains a detailed account of the Marquesas Islands, with map, by D. Ricardo Beltrán of Rózpide.

IT is stated that the *Culnare*, with Capt. Howgate's expedition, landed at Rittenbank in Greenland, Dr. Pavy and Mr. Clay, whose intention is stated to be to make natural history collections and explore the northern limits of Greenland. This, we believe, is the same M. Pavy (a Frenchman) whose projected polar expedition suddenly collapsed in San Francisco seven years ago.

THE Austrian *Monatsschrift für den Orient* for October contains an article by Prof. Vambéry on the commercial importance of the Upper Oxus, in which he endeavours to show that there, and not on the Lower Oxus, is trade likely to be developed. Dr. Paulitschke gives an interesting sketch of the progress of African exploration during the past seventy years.

### ON MAXIMUM AND MINIMUM ENERGY IN VORTEX MOTION<sup>1</sup>

I. A FINITE volume of incompressible inviscid fluid being given, in motion, filling a fixed, simply continuous, rigid boundary, the fact of its being in motion implies molecular rotation, or (as it may be called for brevity) vorticity. Helmholtz's law of conservation of vorticity shows that, whether the boundary be kept fixed as given, or be moved or deformed in any way, and brought back to its given shape and position, there remains in every portion of the fluid which had molecular rotation a definite constant of vorticity; and his formula for calculating energy for any given distribution of vorticity allows us to see that the energy may be varied by the supposed operation on the boundary.

II. The condition for steady motion of an incompressible inviscid fluid filling a finite fixed portion of space (that is to say motion in which the velocity and direction of motion continue unchanged at every point of the space within which the fluid is placed) is that, with given vorticity, the energy is a thorough maximum, or a thorough minimum, or a minimax. The farther condition of *stability* is secured by the consideration of energy alone for any case of steady motion, for which the energy is a thorough maximum or a thorough minimum; because when the boundary is held fixed the energy is of necessity constant. But the mere consideration of energy does not decide the question of stability for any case of steady motion in which the energy is a minimax.

III. It is clear that, commencing with *any* given motion, the energy may be increased indefinitely by properly-designed operation on the boundary (understood that the primitive boundary is returned to). Hence, with given vorticity, there is no thorough maximum of energy in any case. There may also be *complete annulment* of the energy by operation on the boundary (with return to the primitive boundary), as we see by the following illustrations:—

1. The case of two equal, parallel, and oppositely rotating vortex columns terminated perpendicularly by two fixed parallel planes, which, by proper operation on the boundary, may be so

<sup>1</sup> By Sir William Thomson, British Association, Swansea, Section A, Saturday, August 28.

mixed (like two eggs "whipped" together) that, infinitely near to any portion of either, there shall be some of the other.

2. The case of a single Helmholtz ring, reduced by diminution of its aperture to an infinitely long tube coiled within the inclosure.

3. The case of a single vortex column, with two ends on the boundary, bent till its middle meets the boundary; and farther bent and extended, till it is broken into two equal and opposite vortex columns; and then farther dealt with till these two are whipped together to mutual annihilation.

IV. To avoid for the present the extremely difficult general question illustrated (or suggested) by the consideration of such cases, confine ourselves now to two-dimensional motions in a space bounded by two fixed parallel planes and a closed cylindrical surface perpendicular to them, subjected to changes of figure (but always truly cylindrical and perpendicular to the planes). It is obvious that, with the limitation to two-dimensional motion, the energy cannot be either infinitely small or infinitely great with any given vorticity and given cylindrical figure. Hence, under the given conditions, there certainly are at least two stable steady motions. We shall, however, see further that possibly in every case except cases of a narrow, well-defined character, and certainly in many cases, there is an infinite number of stable steady motions.

V. In the present case, clearly, though there are an infinite number of unstable steady motions, there are only two stable steady motions—those of absolute maximum and of absolute minimum energy.

VI. In every steady motion, when the boundary is circular, the stream lines are concentric circles, and the fluid is distributed in co-axial cylindrical layers of equal vorticity. In the stable motion of maximum energy, the vorticity is greatest at the axis of the cylinder, and is less and less outwards to the circumference. In the stable motion of minimum energy the vorticity is smallest at the axis, and greater and greater outwards to the circumference. To express the conditions symbolically, let  $T$  be the velocity of the fluid at distance  $r$  from the axis (understood that the direction of the motion is perpendicular to the direction of  $r$ ); the vorticity at distance  $r$  is—

$$\frac{1}{2} \left( \frac{T}{r} + \frac{dT}{dr} \right).$$

If the value of this expression diminishes from  $r = 0$  to  $r = a$ , the motion is stable, and of maximum energy. If it increases from  $r = 0$  to  $r = a$  the motion is stable and of minimum energy. If it increases and diminishes, or diminishes and increases, as  $r$  increases continuously, the motion is unstable.

VII. As a simplest subcase, let the vorticity be uniform through a given portion of the whole fluid, and zero through the remainder. In the stable motion of greatest energy, the portion of fluid having vorticity will be in the shape of a circular cylinder rotating like a solid round its own axis, coinciding with the axis of the inclosure; and the remainder of the fluid will revolve irrotationally around it, so as to fulfil the condition of no finite slip at the cylindrical interface between the rotational and irrotational portions of the fluid. The expression for this motion in symbols is:—

$$T = \zeta r \text{ from } r = 0 \text{ to } r = b;$$

$$\text{and } T = \frac{\zeta b^2}{r} \text{ from } r = b \text{ to } r = a.$$

VIII. In the stable motion of minimum energy the rotational portion of the fluid is in the shape of a cylindrical shell, inclosing the irrotational remainder, which in this case is at rest. The symbolical expression for this motion is—

$$T = 0, \text{ when } r < \sqrt{(a^2 - b^2)} \text{ and } T = \zeta \left( r - \frac{a^2 - b^2}{r} \right),$$

$$\text{when } r > \sqrt{(a^2 - b^2)}.$$

IX. Let now the liquid be given in the configuration VII. of greatest energy, and let the cylindrical boundary be a sheet of a real elastic solid, such as sheet-metal with the kind of dereliction from perfectness of elasticity which real elastic solids present; that is to say, let its shape when at rest be a function of the stress applied to it, but let there be a resistance to change of shape depending on the velocity of the change. Let the unstressed shape be truly circular, and let it be capable of slight deformations from the circular figure in cross section, but let it always remain truly cylindrical. Let now the cylindrical boundary be slightly deformed and left to itself, and held so as to prevent it from being carried round by the fluid. The central vortex

column is set into vibration in such a manner that longer and shorter waves travel round it with less and greater angular velocity.<sup>1</sup> These waves cause corresponding waves of corrugation to travel round the cylindrical bounding sheet, by which energy is consumed, and moment of momentum taken out of the fluid. Let this process go on until a certain quantity of moment of momentum has been stopped from the fluid, and now let the canister run round freely in space, and, for simplicity, suppose its material to be devoid of inertia. The whole moment of momentum is initially—

$$\pi \zeta b^2 (a^2 - \frac{1}{2} b^2);$$

It is now

$$\pi \zeta b^2 (a^2 - \frac{1}{2} b^2) - M,$$

and continues constantly of this amount as long as the boundary is left free in space. The consumption of energy still goes on, and the way in which it goes on is this: the waves of shorter length are indefinitely multiplied and exalted till their crests run out into fine laminae of liquid, and those of greater length are abated. Thus a certain portion of the irrotationally revolving water becomes mingled with the central vortex column. The process goes on until what may be called a vortex sponge is formed; a mixture homogeneous on a large scale, but consisting of portions of rotational and irrotational fluid, more and more finely mixed together as time advances. The mixture is, as indicated above, altogether analogous to the mixture of the substances of two eggs whipped together in the well-known culinary operation. Let  $b'$  be the radius of the cylindrical vortex sponge,  $b$  being as before the radius of the original vortex column—

$$\frac{1}{2} b'^2 = \frac{1}{2} b^2 + \frac{M}{\zeta b^2}.$$

X. Once more, hold the cylindrical case from going round in space, and continue holding it until some more moment of momentum is stopped from the fluid. Then leave it to itself again. The vortex sponge will swell by the mingling with it of an additional portion of irrotational liquid. Continue this process until the sponge occupies the whole inclosure.

After that continue the process further, and the result will be that each time the containing canister is allowed to go round freely in space, the fluid will tend to a condition in which a certain portion of the original vortex core gets filtered into a position next to the boundary, and the fluid within it tends to a more and more nearly uniform mixture of vortex with irrotational fluid. This central vortex-sponge, on repetition of the process of preventing the canister from going round, and again leaving it free to go round, becomes more and more nearly irrotational fluid, and the outer belt of pure vortex becomes thicker and thicker. The final condition towards which the whole tends is a belt constituted of the original vortex core now next the boundary; and the fluid which originally revolved irrotationally round it now placed at rest within it, being the condition (VIII. above) of absolute minimum energy. Begin once more with the condition (VII. above) of absolute maximum energy, and leave the fluid to itself, whether with the canister free to go round sometimes, or always held fixed, provided only it is ultimately held from going round in space; the ultimate condition is always the same, viz., the condition (VIII.) of absolute minimum energy.

XI. That there may be an infinite number of configurations

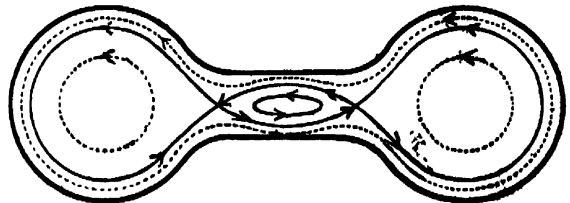

of stable motions, each of them having the energy of a thorough minimum as said in IV. above, we see, by considering the case, in which the cylindrical boundary of the containing canister consists of two wide portions communicating by a narrow passage, as shown in the sketch. If such a canister be completely filled with irrotationally moving fluid of uniform vorticity, the streamlines must be something like those indicated in the sketch.

<sup>1</sup> See *Proceedings of the Royal Society of Edinburgh* for 1880, or *Philosophical Magazine* for 1880; Vibrations of a Columnar Vortex; Wm Thomson.

" Hence if a small proportion of the whole fluid is irrotational, it is clear that there may be a minimum energy, and therefore a stable configuration of motion with the whole of this in one of the wide parts of the canister; or the whole in the other; or any proportion in one and the rest in the other; or a small portion in the elliptic whirl in the connecting canal, and the rest divided in any proportion between the two wide parts of the canister.

### ON THE SPECTRA OF THE COMPOUNDS OF CARBON WITH HYDROGEN AND NITROGEN

MESSRS. LIVEING AND DEWAR have made a long series of observations on this subject, of which the following is a brief abstract<sup>1</sup> by the authors:—

The first experiments were made with a De Meritens dynamo-electric machine, arranged for high tension, giving an alternating current capable of producing an arc between carbon poles in air of from 8 to 10 millims. in length. The carbon poles used had been previously purified by prolonged heating in a current of chlorine.

The arc was taken in different gases inside a small glass globe about 60 millims. in diameter, blown in the middle of a tube. The two ends of the tube were closed with dry corks, through which were passed (1) the carbons inserted through two pieces of narrow glass tubing; (2) two other glass tubes through which currents of the gases experimented with were sent.

The arc taken in a globe of air gave a tolerably bright continuous spectrum, above which the green and blue hydrocarbon bands were seen, also the seven bands in the indigo (wave-lengths 4,600 to 4,502, Watts) as in the flame of cyanogen, and much more brightly the six bands in the violet (wave lengths 4,220 to 4,158, Watts) and five ultra-violet.

Carbonic acid gas, hydrogen, nitrogen, chlorine, carbonic oxide, nitric oxide, and ammonia were then successively substituted for air in the globe, with the result that in carbonic acid, hydrogen, chlorine, and carbonic oxide, the above-mentioned bands in the indigo, violet, and ultra-violet died away, while in nitrogen, nitric oxide, and ammonia, they were always well seen.

These different gases were used in order to eliminate to a large extent the influence of electric conductivity on the character of the spectrum; and the green and blue hydrocarbon bands were seen, more or less, in all of them.

Next observations were made of the spectra of flames of sundry compounds of carbon.

In the flame of cyanogen, prepared from well-dried mercury cyanide, passed over phosphoric anhydride inserted in the same tube, and burnt from a platinum jet fused into the end of the tube, the hydrocarbon bands were almost entirely absent, as Plucker and Hittorf had found; only the brightest green band was seen, and that faintly. The indigo, violet, and ultra-violet bands, on the other hand, were well developed.

These three sets of bands in the indigo, violet, and ultra-violet are in the sequel referred to as the "cyanogen bands," though it is possible that they may be producible by other compounds of carbon with nitrogen.

The flame of hydrocyanic acid burning in air showed very much the same as that of cyanogen.

In the flame of a mixture of purified hydrogen and carbon disulphide no hydrocarbon bands at all could be detected.

Nor could they be detected in the flame of a mixture of carbonic oxide and hydrogen burnt in air.

When a mixture of hydrogen or of carbonic oxide with carbon tetrachloride vapour was burnt, hydrocarbon bands made their appearance, but were weak.

On the other hand, chloroform, when mixed with hydrogen, gave, when burnt in air, the hydrocarbon bands very strongly.

On a review of the whole series of observations, certain points stand out plainly. In the first place, the indigo, violet, and ultra-violet bands, characteristic of the flame of cyanogen, are conspicuous in the arc taken in an atmosphere of nitrogen, air, nitric oxide, or ammonia, and they disappear almost, if not quite, when the arc is taken in a non-nitrogenous atmosphere of hydrogen, carbonic oxide, carbonic acid, or chlorine. These same bands are seen brightly in the flames of cyanogen and ammonia, but are not seen in those of hydrocarbons, carbon disulphide, or carbon disulphide. The conclusion seems to be that they belong to cyanogen; and this conclusion

<sup>1</sup> For fuller details see *Proc. R.S.*, xxx. pp. 252, 494.

does not seem to be at all invalidated by the fact that they are seen weakly, or by flashes, in the arc or spark taken in gases supposed free from nitrogen by reason of the extreme difficulty of removing the last traces of air. They are never, in such a case, the principal or prominent part of the spectrum, and in a continuous experiment they are seen to fade out in proportion as the nitrogen is removed. This conclusion is strengthened by the observations that cyanogen (or hydrocyanic acid) is generated in the arc in atmospheric air in large quantity.

In the next place, the green and blue bands, characteristic of the hydrocarbon flame, seem to be always present in the arc, whatever the atmosphere. This is what we should expect if they be due, as Ångström and Thalén suppose, to acetylene; for the carbon electrodes always contain, even when they have been long heated in chlorine, a notable quantity of hydrogen. In the flames of carbon compounds they by no means always appear; indeed it is only in those of hydrocarbons or their derivatives that they are well seen. Carbonic oxide and carbon disulphide, even when mixed with hydrogen, do not show them; and if seen in the flames of cyanogen, hydrocyanic acid, and carbon tetrachloride mixed with hydrogen, they are faint, and do not form a principal or prominent part of the spectrum. This is all consistent with the supposition of Ångström and Thalén. The fact that the bands are not produced even in the presence of hydrogen, when it is not present in the flame in the form of a compound with carbon, is very significant; for we know that acetylene is present, and can easily be extracted from the flame of any hydrocarbon, and that it is formed as a proximate product of decomposition of hydrocarbon by the electric discharge, but we have no evidence that it is producible as a product of direct combination of carbon with hydrogen at the comparatively low temperature of the flames described.

The hydrocarbon bands are best developed in the blowpipe flame, that is under conditions which appear, at first sight, unfavourable to the existence of acetylene in the flame. However, by the use of a Deville's tube, acetylene may readily be withdrawn from the interior of such a flame, and from that part of it which shows the hydrocarbon bands most brightly.

The question as to whether these bands are due to carbon itself or to a compound of carbon with hydrogen, has been somewhat simplified by the observations of Watts, Salet, and others on the spectrum of carbonic oxide. It can hardly be doubted now that that compound has its own spectrum quite distinct from the hydrocarbon flame spectrum. The mere presence of the latter spectrum feebly developed in the electric discharge in compounds of carbon supposed to contain no hydrogen, weighs very little against the series of observations which connect this spectrum directly with hydrocarbons.

In the next place, it appears conclusively from the experiments, that the development of violet bands of cyanogen, or the less refrangible hydrocarbon bands, is not a matter of temperature only. For the appearance of the hydrogen lines C and F, observed by the authors in the arc taken in hydrogen, indicates a temperature far higher than that of any flame. Yet the violet bands are not seen in hydrogen at that temperature, while the green bands are well developed. The violet bands are, nevertheless, seen equally well at the different temperatures of the flame, arc, and spark, provided cyanogen be the compound under observation in the flame, and nitrogen and carbon are present together at the higher temperatures of the arc and spark.

The accompanying diagram (Fig. 1) shows approximately the relative position of the bands in that part of the spectrum of the flame of cyanogen fed with a jet of oxygen which is more refrangible than the Fraunhofer line F. Only those bands which are less refrangible than the solar line L have been before described, but photographs show two shaded bands slightly less refrangible than the solar line N accompanied by a very broad diffuse band of less intensity on the more refrangible side of N; also a strong shaded band, which appears to be absolutely coincident with the remarkable shaded band in the solar spectrum, which has been designated by the letter P; and near this, on the less refrangible side, a much fainter diffuse band, which also seems to coincide with a part of the solar spectrum sensibly less luminous than the parts on either side of it. This spectrum is remarkably persistent at all temperatures of the flame. Watts found that it did not disappear when the flame was cooled down as much as possible by diluting the cyanogen with carbonic acid; it retains its characters when the cyanogen is burnt in nitric oxide. The flame in the last case must be one



of the hottest known, from the large amount of heat evolved in the decomposition of cyanogen and nitric oxide, namely, 41,000 and 43,300 units respectively. There is in the case of cyanogen, as in the case of so many other substances, a difference in the relative intensities of the different parts of the spectrum of the flame at different temperatures, but no other change of character. In the upper part of the flame where much or all of the cyanogen is oxidised or decomposed the spectrum is continuous, but at the base of the flame where it is issuing from the nozzle the cyanogen bands are always seen both when the cyanogen is burning in oxygen and when it is burning in nitric oxide. This is what we should anticipate, provided intermediate, and not the final, compounds are the active sources of the banded spectrum.

Each of the five sets of bands shown in the diagram is attended on its more refrangible side by a series of rhythmical lines extending to a considerable distance, not shown in the diagram, but easily seen in the photographs.

Coal gas burning in oxygen gives no bands above that near G within the range of the diagram, Fig. 1; but beyond this photographs show a spectrum of a character quite different from that at the less refrangible end, which the authors have traced to be due to water and described elsewhere (*Proc. R. S.*, No. 205).

The authors then describe experiments with carbon tetrachloride, conducted with great care and numerous repetitions because of the prominence given to an experiment with this compound by Mr. Lockyer in a recent "Note on the Spectrum of Carbon," and because their results in every case differ from those which he obtained.

The form of sparking tube employed was similar to that used by Salet. This was attached by thick rubber tubing to a straight glass tube of which one half, about 6 inches long, was filled with phosphoric anhydride, and the other half with small fragments of soda-lime to prevent any chlorine from the decomposition of the tetrachloride by the spark from reaching the Sprengel pump. The tetrachloride used had been fractionated until it had a constant boiling point of 77° C. Sufficient of it was introduced into the sparking tube to fill nearly one quarter of the bulb at the end, and the whole interior of the tube thoroughly wetted with it in order to facilitate the removal of the last traces of air.

When the tube containing the tetrachloride had been so far exhausted that little but condensable vapours were pumped out, the bulb was heated so as to fill the apparatus with vapour of tetrachloride, the pump still going, and this was repeated as long as any incondensable gas was extracted. Sparks were then passed through the tube for a short time, the pump still being kept going. After a short time it was unnecessary to keep the pump going, as all the chlorine produced by decomposition of the tetrachloride was absorbed by the soda-lime. On now examining the spectrum, no trace of any of the cyanogen bands could be detected, either by the eye or by photography, however the spark might be varied. The violet lines of chlorine described by Salet were more or less visible, coming out brightly when a condenser was used. Several tubes were treated in this way, and many photographs taken, but always with the same result; no trace appeared of either the seven blue, the six violet, the five ultra-violet, or of the still more refrangible bands of the cyanogen flame. It is true that all the photographs showed three lines in the ultra-violet, but these do not at all closely resemble the cyanogen bands, they are not shaded like them. The least refrangible of the three is coincident with the middle maximum in the ultra-violet set of five bands, but the other two do not coincide with other of these maxima. When a condenser is used, these three lines come out with much greater intensity, and two other triplets appear on the more refrangible side, as well as other lines.

The general character of the violet part of the spectrum of the spark in carbon tetrachloride taken without a condenser, but not the exact position to scale of wave-lengths of all the lines, is shown in Fig. 2. Fig. 3 shows the brightest of the additional lines which come out with the use of a condenser. Photographs of sparks taken in hydrochloric acid showed a precisely similar group of ultra-violet lines, so that there is no doubt that the three lines which the photographs show near the place of the ultra-violet cyanogen bands are due to chlorine.

Repeated trials in which the arrangements were varied having shown that pure carbon chloride, if free from nitrogen, does not give any of the bands ascribed to compounds of carbon with nitrogen, the next step was to determine whether the addition of nitrogen would bring them out, and if so what quantity of

nitrogen would make them visible. For this purpose the binding of the rubber tube connecting to the pump a sparking tube containing tetrachloride and found to give no cyanogen bands, was loosened, and, after letting in very little air, immediately closed again. On now passing the spark the six violet bands at once and the seven blue bands also were in a short time



After trying some other experiments of a similar kind, which indicated that a very small quantity of nitrogen was sufficient to develop the cyanogen bands in one of these tubes, a minute fragment of bichromate of ammonia, carefully weighed and wrapped in platinum foil, was introduced into the neck of one of the

sparkling tubes containing carbon tetrachloride, the tube connected to the Sprengel pump, and the air removed as before. On examination of the spark with the spectroscope no trace of any cyanogen band could be detected. A pinch-cock was now put on the rubber tube, and the bichromate was heated by a spirit lamp to decomposition (whereby it is resolved into nitrogen, water, and oxide of chromium). On now passing the spark the six violet bands were well seen. There was no change in the condition of the coil or rheotome, so that the spark was of the same character as it had been before when no cyanogen bands were visible, and the change in the spectrum cannot be attributed to any change in the spark. The weight of the bichromate was between .0005 and .0006 grm., and the nitrogen this would evolve would fill just about  $\frac{1}{4}$  of a cubic centimetre at atmospheric pressure. The tube held 30 cub. centims., so that vapour of carbon tetrachloride when mixed with  $\frac{1}{4}$  part of its volume of nitrogen, gives under the action of the electric spark the cyanogen bands distinctly. Other similar experiments confirmed this result.

Similar experiments with carbon bisulphide, benzol, and well-purified naphthaline, gave like results when care was taken to remove air completely.

As Watts laid much stress on the occurrence of the cyanogen bands in the spectrum of the spark taken in carbonic oxide at atmospheric pressure (though they do not appear in carbonic oxide at reduced pressures), as a proof that these bands were due to carbon only, the authors made a series of careful experiments with carbonic oxide at atmospheric pressures.

In the first experiments with this substance the gas was made by the action of sulphuric acid on dried formiate of sodium, and it was found that the cyanogen bands disappeared as air was expelled from the apparatus, reappearing brightly when air, not exceeding  $\frac{1}{10}$  of the whole gas in the apparatus, was admitted.

Carbonic oxide was next generated by heating, in a tube of hard glass in an ordinary combustion furnace, a mixture of pure and dry potassium oxalate with one quarter of its weight of

... to be to capture traces of ammonia. The tube was connected with a Sprengel pump, and the air exhausted before heating the oxalate. The distant end of the tube with the oxalate was then heated, and the whole apparatus filled with carbonic oxide; it was then again exhausted with the pump, refilled by heating more oxalate, and the gas allowed to stream out through the pump for some time. The heat was then lowered, sparks were passed, and the spectrum observed. No trace whatever of the cyanogen bands could be detected, however the spark might be varied. The pump was now set going again, and the pressure of the gas reduced to one inch of mercury, while the spectrum was observed from time to time. Still no trace of the cyanogen bands could be detected. More of the oxalate was next heated, and the observations repeated again and again, always with the same result. The conclusion was that carbonic oxide, if quite free from nitrogen, does not give, at the atmospheric or any less pressure, the cyanogen bands.

From Dr. Watts's account of his experiments, it appeared that he had used carbonic oxide prepared by the action of sulphuric acid on ferrocyanide, and it was probable that it might have been contaminated with nitrogen, or with nitrogenous compounds, from the ferrocyanide. The authors accordingly repeated their experiments with carbonic oxide so prepared, and found that the cyanogen bands were then always distinctly seen.

They have also repeated Ångström and Thalén's experiments with the spark between carbon poles in nitrogen and carbonic acid gas. They observed that in nitrogen the cyanogen bands were plainly visible through a great range of variations of the character of the spark; even the use of a condenser of moderate size did not diminish them. Photographs were taken with and without the use of the condenser, and these showed the violet and ultra-violet cyanogen bands, including those near N and P. The nitrogen was then swept out by a current of carbonic acid gas, and on now passing the spark the cyanogen bands could no longer be detected, and photographs taken as before showed no trace of any of them.

Other experiments showed the sensitiveness of the spectroscopic tests for compounds of carbon with nitrogen, and that all traces of water can hardly be removed from apparatus and reagents which do not admit of being heated red hot.

The first point the authors had before them in these investi-

gations is whether the groups of shaded bands seen in the more refrangible part of the spectrum of a cyanogen flame are due to the vapour of carbon uncombined, or, as they conclude, to a compound of carbon with nitrogen.

Now the evidence that carbon uncombined can take the state of vapour at the temperature of the electric arc is at present very imperfect. Carbon shows at such temperatures only incipient fusion, if so much as that, and that carbon uncombined should be vaporised at the far lower temperature of the flame of cyanogen is so incredible an hypothesis that it ought not to be accepted if the phenomena admit of any other probable explanation. On the other hand it has been shown that cyanogen or hydrocyanic acid is generated in large quantity in the electric arc taken in nitrogen, and Berthelot has shown that hydrocyanic acid is produced by the spark discharge in a mixture of acetylene and nitrogen, so that in the cases in which these bands shine out with the greatest brilliance, namely, the arc in nitrogen and the cyanogen flame, we know that nitrocarbon compounds are present. Further, the authors have shown that these bands fade and disappear in proportion as nitrogen is removed from the arc. Ångström and Thalén had previously shown the same thing with regard to the spark discharge between carbon electrodes; and the conclusion to which they have come would probably have commanded universal assent if it had not been for the fact that these bands had been seen in circumstances where nitrogen was supposed to be absent; but where, in reality, the difficulty of completely eliminating nitrogen, and the extreme insensibility of the spectroscopic test, had been inadequately apprehended.

To clear up the question from this point of view, the experiments last described have been made, and they appear to the authors quite conclusive. Were the evidence less conclusive than it is, it would still be as rash and as illogical to conclude from the appearance of the cyanogen bands in a case where nitrogen was presumed, not proved, to be absent, that they were not due to a compound of carbon with nitrogen, as it would be to deny that the well-known yellow lines were due to sodium, because they had been seen in cases where sodium was supposed to be absent. The argument of the authors is an induction from a very long series of observations which lead up to one conclusion, and hardly admit of any other explanation. But Mr. Lockyer attempts to explain the disappearance of the bands when nitrogen is absent by the statement "that the tension of the current used now brings one set of flutings into prominence, and now another." This is no new observation. It is well known that variations in the discharge produce variations in the relative intensities of different parts of a spectrum. Certain lines of magnesium, cadmium, zinc, and other metals, very brilliant in the spark, are not seen, or are barely seen, at all in the arc. His remark might be applied to the spectra of compounds as well as to those of elements. Variation in the discharge accounts very well for some of the variations of intensity in the bands if they be due to a compound of carbon with nitrogen; it will not, however, account for the fact that the bands, or those of them which have the greatest emissive power, and are best developed by the particular current used, come out on the addition of a minute quantity of nitrogen, when there is every reason to think that no variation of the current occurs.

Much the same may be said with regard to the changes of the spectrum produced by changes of temperature. We cannot infer from any of these changes that the spectrum is not due to a compound. The bands in question are singularly persistent through a great range of temperatures, from the temperature of a cyanogen flame cooled by admixture with carbonic acid gas, as related by Watts (*Phil. Mag.*, 1869, p. 258), to that of the spark of an induction coil with condenser.

But again, Mr. Lockyer attempts to get over the difficulties of his case by the supposition that "the sets of carbon flutings represent different molecular groupings of carbon, in addition to that or those which give us the line spectrum."

Now, until independent evidence that carbon can exist at all in the state of vapour uncombined at the temperature of a cyanogen flame can be adduced, and further independent evidence of the existence of different groupings in such vapour, the hypothesis here enunciated is a gratuitous one, so long as any other hypothesis for which independent evidence can be adduced, as is true of the existence of nitrocarbon compounds in the flame, arc, and spark, will sufficiently explain the facts.

The authors have not expressed any opinion whether or no the cyanogen bands are visible in the solar spectrum. The observa-

tion above recorded that there is in the spectrum of cyanogen a strong shaded band coincident with the very characteristic dark shaded band P, strengthens materially the evidence in favour of the existence of these bands in the solar spectrum; the more so as the series of lines at P has far more of the distinctive character of the cyanogen spectrum than any other series in the ultra-violet part of the solar spectrum.

However that may be, they contend against the hypothesis that if present the bands can be due to any vapour of carbon uncombined in the upper cooler region of the chromosphere. One object of their investigations has been to determine the permanence of compounds of non-metallic elements and the sensitiveness of the spectroscopic test in regard to them. It appeared probable that if such compounds existed in the solar atmosphere their presence would be most distinctly revealed in the more refrangible part of the spectrum, and it seems sufficiently clear that the presence of nitrogen in the solar atmosphere may be recognised through cyanogen when free nitrogen might escape detection.

### UNIVERSITY AND EDUCATIONAL INTELLIGENCE

OXFORD.—The Millard Scholarship in Natural Science lately founded at Trinity College has been awarded for the first time. The successful candidate is Mr. R. Bodey, from the Mining School, Bristol, and from the Royal School of Mines.

At Exeter College the Natural Science Scholarship has been awarded to Mr. B. Spencer, from King's College, London.

According to the report of the Delegates for unattached students, the number of students not attached to any college or hall has increased by twenty during the past year. Seventy unattached students have become members of colleges or halls during the year.

CAMBRIDGE.—The University of Cambridge Commissioners have apparently proposed their final arrangements as regards the University. There are many modifications from the original scheme in the direction of giving more freedom to the University, and on the whole in favour of scientific objects. A general financial board is to manage all University property and expenditure, and to control especially the college contributions. The rating of the colleges for University purposes is modified in the direction of increased fairness. The common University Fund derived from the colleges is to provide for all classes of University teachers, for the salaries of demonstrators, superintendents, and curators, for the erection, maintenance, and furniture of museums, laboratories, libraries, lecture-rooms; and in addition grants of money may be made from it for special work in the way of research, and for investigations in any branch of learning or science connected with the studies of the University. The amount of payments for buildings, and their maintenance, furniture, and apparatus, is not to exceed one-third of the income of the fund in any one year.

Practically speaking, there may be available in each year to the end of 1884, 2,000*l.* a year for these latter purposes and 4,000*l.* for investigators and teachers, and the college payments will rise definitely to 30,000*l.*, of which 10,000*l.* may be used for the purposes of buildings, and 20,000*l.* for teachers of all kinds.

It is no longer sought to force particular professors on particular colleges; the college may, if it prefers, pay the income of a Professorial Fellowship to the common fund. There are to be twenty-nine Professorial Fellowships, not assignable to particular professors, but distributed among the colleges.

The stipends of the Professors, payable by the University, are to have 200*l.* deducted from them if the Professor holds a Professorial Fellowship or a Headship. The stipends of Professors as now proposed are not so unequal as in the first proposed statutes. The payments (subject to the above-mentioned deduction) to the Regius Professor of Physic would be 700*l.*, Professor of Chemistry and the Cavendish Professor of Physics 850*l.* each, Physiology 800*l.*, Pathology 800*l.*, Botany, Zoology, and Woodwardian of Geology 700*l.* each, Anatomy 600*l.* The new Professorships are to be for (1) Physiology, (2) Pathology, (3) Mental Philosophy and Logic. The first two

professions are not to undertake the private practice of medicine; the minimum number of readers is now twenty. The subjects are to be within the control of the University; the readers are to be appointed as soon as funds can be provided conveniently from the common University Fund or from other sources. Readerships may be suppressed or created, according to the needs of study. The stipend is to be 400*l.* The readers are to be appointed by grace of the Senate on the recommendation of the General Board of Studies now to be created; but in each case the special Board of Studies with which the readership is connected must concur in the appointment, or it will lapse to the Council of the Senate.

University Lecturers (the next grade of teachers) may be college lecturers who throw open their lectures to the University, or they may be other persons approved by the Boards of Studies.

The payment to these lecturers from the University must be not less than 50*l.* The University may also appoint lecturers on subjects not immediately connected with any special Board of Studies, for shorter or longer terms. The separation of the Board of Studies in Physics and Chemistry from that of Biology and Geology is maintained. The constitution of the General Board of Studies is carefully and completely defined; but it is to do such work as the Senate commits to it, and in future a general University budget is to be prepared and submitted to the Senate.

The Cambridge Museums and Lecture Rooms Syndicate find the increase of annual grant from the University from 1,500*l.* to 2,000*l.* a year inadequate, owing especially to new outlay on new departments. They now have a balance of 821*l.* against them; and they ask for an additional 1,000*l.* per annum at once, feeling quite unable otherwise to maintain the museums in moderate efficiency with strict economy.

### SCIENTIFIC SERIALS

*Journal of the Franklin Institute*, September.—Experiments on the compression of air by the direct action of water, by J. P. Frizell.—Experiments on the strength of yellow pine, by R. H. Thurston.—The absolute economy of electric lighting, by R. Briggs.—Note on the artificial production of diamonds by the processes of Despretz, by E. J. Houston.

October.—Motion of viscous fluids, by T. Craig.—The steam yacht *Anthracite* and the Perkins system of high pressure steam, by G. Deane.—Coal gas engineering, by R. Briggs.—Holman's new illustration of cell-formation, by J. M. Child.—Joseph Henry, by A. M. Mayer.

*American Naturalist*, October.—S. A. Forbes, the food of the darters.—J. C. Russell, on the former extent of the triassic formation of the Atlantic slates.—C. C. Abbott, notes on stone implements found in New Jersey.—S. Lockwood, some noteworthy birds.—W. K. Higley, on the microscopical crystals contained in plants.—The editor's table.—Biology at the American Association at Boston.—Recent literature.—General notes.—Scientific news.

*Reale Istituto Lombardo di Scienze e Lettere. Rendiconti*, vol. xiii. fasc. xvi., July 29.—On a particular univocal correspondence between elements of space with three dimensions, by F. Aschieri.—Case of unproductivity of corn, by G. Cantoni.—On the thermal and luminous phenomena manifested by the Leyden jar at the moment of its discharge, by E. Villari.—Transformation of aspartic acid into fumaric acid, by G. Korner and A. Menozzi.—First case of repeated peritoneal transfusion, with new and happy success, in an oligocytic insane person, by C. Golgi and A. Raggi.—On the infirmity of Torquato Tasso, by A. Corradi.—Meteorological summary of the year 1879, from meteorological observations at the Brera Observatory, by P. Frisiani.

*Rivista Scientifico-Industriale*, September 15.—Further experiments with a Crookes' tube, by A. Righi.—Histology of the skin of Teleostean fishes, by A. Batelli.

specimens of *Anthocoris nemorum*, an hemipterous insect supposed to be damaging the hops grown near Canterbury, but had then expressed his opinion that the insect was not the true culprit, its habits being probably carnivorous. This year he had received from the same correspondent some small larvae which had been found in the cones, and these he considered were not only the true enemy of the hops, but were also the food of the *Anthocoris*.—Sir Sydney Saunders exhibited a series of apterous females of the new species of *Scleroderma*, adverted to at the previous meeting, and read remarks thereon.—Messrs. Kirby, Fitch, Ralfe, and the Rev. E. N. Gilbert exhibited several varieties of lepidoptera taken in this country and on the Continent, some of which, from the structure of the antennae, were considered "hermaphrodite" forms.—Mr. Hildebrand Ramsden communicated a note on *Pyrrophorus causticus*, a Cuban fire-fly.—Mr. Swinton read two papers entitled Some Experiments on the Variability of Lepidoptera undertaken during the year 1880, and exhibited specimens and figures in illustration.—Mr. Butler communicated a paper entitled Observations on the Lepidopterous Genus *Terias*, with descriptions of hitherto un-named forms from Japan.—Mr. Waterhouse communicated a paper on the Buprestidae from Madagascar.—Messrs. Kirby, Distant, and McLachlan called the attention of the Society to a method of publishing descriptions of new species pursued by M. André in recent parts of his work on European Hymenoptera. These were not only inserted on the cover of his quarterly parts, but even at the end of sheets of advertisements laid loosely between the pages of a part. It was regretted that no other course than that of protest and disapprobation could be applied in the interest of science to such a practice.

## PARIS

Academy of Sciences, October 18.—M. Wurtz in the chair.—M. Faye presented the *Connaissance des Temps* for 1882 (204th volume), and indicated several improvements, viz., tables giving, for all points of the globe where the next Venus transit will be visible, the instants of all phases of the transit, a table for determining the direction of the meridian from the Pole star, the positions of 300 important stars every ten days, and of ten polar stars daily, and empiric corrections of ephemerides of the moon.—Longitude of the coast of Brazil, by M. Mouchez. A scientific mission from the United States under Messrs. Green and Davis has, with the aid of the Transatlantic cable from Europe, fixed the position of the six points, Para, Pernambuco, Bahia, Rio de Janeiro, Montevideo, and Buenos Ayres; and the results show that the author's figures for the same places, obtained in 1860 and following years, by astronomical and chronometric methods, were nearly exact, the greatest error being 2' 34". (The *Connaissance des Temps* had adopted different numbers, which are shown to be in error 27' 45".) The author's errors being all of the same sign, a mere shifting of the Brazil coast about 2 sec. westwards (nearly 1 km.) would make the longitudes exact to a few tenths of a second. He compares the chronometric and astronomical methods, showing that chronometers, in absence of the telegraph, offer the surest and most simple means of determining longitude. The influence of temperature he corrected by means of a simple coefficient.—On the saccharine matters contained in the fruit of the coffee-tree, by M. Boussingault. He analysed some berries (from Brazil) that had been put in alcohol immediately after plucking, also the alcohol. The berry is poor in saccharine pulp compared with cherries and other stone fruit from which alcohol is got (it has 66 per cent. as against 90 for cherries and 95 for pines). The distillation of the berries of coffee would hardly be lucrative or practicable (as Humboldt imagined).—Order of appearance of the first vessels in the inflorescence of *Mibora verna*, by M. Trécul.—On the resistance of animals of bovine species to splenic fever, and on the preservation of these animals by preventive inoculations, by M. Chauveau. He mentions that, contrary to what is observed in France, it is in animals of bovine species that anthracoid diseases are more frequently met with in Algeria. He is inquiring what it is that favours the effects of spontaneous infection in the bovine species, so resistant to provoked infection, and hopes soon to be able to furnish the explanation. The preventive effect of inoculation he has proved in eight subjects of bovine species (four of which were Algerian).—On the photophone of Prof. Bell and Mr. Sumner Tainter, by M. Braguet. A drawing is given of the

strative.—Spectroscopic studies of the sun at Paris Observatory, by M. Thollon. The sun has entered on a period of activity. M. Thollon gives figures of several striking recent protuberances. He frequently observes protuberances 1' in height, and has seen several exceeding 2' and 3', and one about 8'. Some of them may nearly reach the limits of the corona. He indicates his new method of ascertaining the direction of the solar equator.—Principles of an algebraic calculus which contains, as particular species, the calculus of imaginary quantities and of quaternions, by M. Lipschitz.—On algebraic equations, by M. West.—Vibratory forms of circular pellicles of saposaccharic liquid (second note) by M. Decharme. This refers to the relative position of the nodals of each system. One finds identical laws for vibratory forms of any circular liquid surfaces, and for those of soapy pellicles; only the width of the zones is about six times smaller in the case of the former.—On the presence of cerium in the coal-formation of the valley of Saint-Étienne, by M. Mayançon.—On a very perfect reptile found in the Permian formation, by M. Gaudry. M. Roche found it at Igornay, and has presented it to the Paris Museum. M. Gaudry proposes to call it *Stereorachis dominans*. Its vertebrae are in striking contrast with those of other reptiles in the same bed; the centrums are in one piece, which adheres to the neural arc. Another mark of superiority is that its humerus has, in the distal part, a neuro-arterial canal. The *Stereorachis* was a pretty large carnivore. It has affinities with the Ganocephali and Labyrinthodonts, and perhaps still more with some of the animals in Mr. Cope's group of Pelycosaurians, in North America.—On the existence of a reptile of ophiidian type in the *Ostrac columba* strata of the Charentes, by M. Sauvage.

## BERLIN

Geographical Society, October 9.—President Dr. Nachtigal, who congratulated Dr. Bastian on his return from his two years' exploration.—A letter from Dr. Buchner was read, dated September 27 of last year from Kimbundo. Since then, it has been learned, he has not only reached the residence of Muata Janvo, but has carried his exploration much farther. It is probable that he has gone northwards.—News was received from Dr. Lenz, which we refer to in our Geographical Notes. By the last news Herr Flegel had reached the confluence of the Niger and Binué, and his expedition was doing well.—The German expedition to East Africa was, according to the last news, at Muhatta, with Capt. Ramacker's Belgian expedition, on the way to Tabora.—Prof. Credner of Halle read a paper on the glaciation of North Germany during the glacial period.

## CONTENTS

	PAGE
DALFOUR'S "COMPARATIVE EMBRYOLOGY." By Prof. E. RAY LANKESTER, F.R.S.	601
THE SIEVE-TUBES OF DICOTYLEDONOUS PLANTS. By F. OXFENBOWER	602
OUR BOOK SHELF:—	
Taylor's "Elementary Geometry of Conics"	603
LETTERS TO THE EDITOR:—	
Cesarski's New Variable Star.—Prof. EDMUND C. PICKERING;	
GEORGE KNOTT	603
"Solid Ice at High Temperatures."—JOHN LECONTE	603
Wire Torsion.—Professors JOHN PERRY and W. E. AYRTON	604
On the Skin-Furrows of the Hand.—Dr. HENRY FAULDS	605
Metamorphic Rocks, Ireland.—G. H. KINAMAN	606
The Number of Known Species of Hemiptera-Heteroptera.—Dr. F. BUCHANAN WHITE	605
On the Classification of Rivers.—Surgeon H. B. GUPPY	606
Yuccas under Cultivation.—Consul E. L. LAYARD	606
Intellect in Brutes.—Consul E. L. LAYARD; Prof. W. WHITMAN	
BAILEY	607
Atmospheric Phenomenon.—B.	607
Temperature of the Breath.—F. J. M. P.	607
Crossing Rapid Streams.—C.	607
Construction of Telescopes and Microscopes.—P. C.	607
BENJAMIN PRITCH, F.R.S.	607
RECENT CHEMICAL RESEARCH. By M. M. PATTISON MUIR	608
JAPAN, I. (With Illustrations)	610
NOTES	614
OUR ASTRONOMICAL COLUMN:—	
Cesarski's Variable of Short Period	616
The Rotation of Jupiter	617
CHEMICAL NOTES	617
GEOGRAPHICAL NOTES	618
ON MAXIMUM AND MINIMUM ENERGY IN VORTEX MOTION. By SIR WILLIAM THOMSON, F.R.S. (With Diagram)	618
ON THE SPECTRA OF THE COMPOUNDS OF CARBON WITH HYDROGEN AND NITROGEN. By Professors LIVING and DEWAR (With Diagram)	620







