





# Scanned from the collections of The Library of Congress



Packard Campus  
for Audio Visual Conservation  
[www.loc.gov/avconservation](http://www.loc.gov/avconservation)

Motion Picture and Television Reading Room  
[www.loc.gov/rr/mopic](http://www.loc.gov/rr/mopic)

Recorded Sound Reference Center  
[www.loc.gov/rr/record](http://www.loc.gov/rr/record)







# RADIO BROADCAST

VOLUME IV

*NOVEMBER, 1923, to APRIL, 1924*

BETTER RADIO



GARDEN CITY      NEW YORK  
DOUBLEDAY, PAGE & COMPANY

1924

TK-100  
12

*Copyright, 1924, by*  
DOUBLEDAY, PAGE & COMPANY



77c74 July 22, 1915

# INDEX

(\*Illustrated Articles. Editorials in Italics)

	PAGE		PAGE
* <b>A</b> LONE Before Thousands (3 photos with captions).....	245	Supplemental List of Broadcasting Stations in the U. S. from December 15 to January 18 Inclusive.....	435
Amateur and the B. C. L. Get Together, The.....	421	Supplemental List of Broadcasting Stations in the United States, Jan. 19 to Feb. 15.....	519
Amateur Transatlantic Tests Dec. 22 to Jan. 10.....	268	<i>Bureau of Standards Tests Receiving Sets.....</i>	272
*Among Our Authors....86, 172, 266, 356, 444,	538	* <b>C</b> Q D (Alfred M. Caddell).....	449
*Anatomy of the B Battery, The.....	318	<i>Canadian Trading Post Men and Engineers to Have Their Concerts.....</i>	102
*Announcing Some Announcers (5 photos with captions).....	317	*Charles Proteus Steinmetz (J. H. Morecroft)	296
<i>Argentina's New Station.....</i>	471	Choice of a Receiving Tube, The (B. S. Havens).....	287
*Aristocracy of Radio Receivers, The.....	207	<i>Copenhagen-Bornholm Radio Link, The.....</i>	104
<i>Army's Radio Chief Retires, The.....</i>	376	<b>D</b> ATA on Standard Single-Layer Coils.....	273
<b>B</b> ATTING a Dot About.....	278	<i>Demonstrating Radio at the Fairs.....</i>	103
*Behind the Scenes at a Broadcasting Station (Carl Dreher).....	37	<i>Did Radio Fail at Point Arguello?.....</i>	91
Book on Radio, A Good.....	209	*"Dope" on Wavelengths and Kilocycles, The.....	47
<i>British Radio Policy.....</i>	101	<i>Down to the Deeps with Sets.....</i>	472
Broadcasting.....		<b>E</b> NGLAND:	
* <i>Broadcasting and the Library.....</i>	6	<i>British Radio Policy.....</i>	101
*Broadcasting Complete American Programs to All England (W. W. Rodgers).....	359	<i>No Political Broadcasting in England</i>	473
<i>Broadcasting Browning.....</i>	271	* <b>F</b> ACTOR that Limits Long-Distance Reception, The (A. J. Haynes).....	283
<i>Broadcasting of News by the Daily Papers, The.....</i>	99	<i>Fading.....</i>	278
<i>Broadcasting Over Extremely Long Distances.....</i>	373	<i>Federal Trade Commission Investigates the Radio Corporation, The.....</i>	371
*If You Like Them Let Them Know It (Myra May).....	246	<i>Firpo's Admirers Quickly Hear of His Defeat</i>	104
Is the Broadcast Listener At Fault? (Carl Dreher).....	424	*From Binding Post to Varnish (Howard S. Pyle).....	289
* <i>Some Problems in the Broadcasting of Religion.....</i>	11	*Fundamentals of Loud Speaker Construction The (A. Nyman).....	151
*Tricks Used in Staging Invisible Shows (C. H. Huntley).....	24	<b>G</b> ENERAL Electric Company to Invade the Middle West.....	273
*What a College Can Do In Broadcasting (Franklin Clement).....	58	Grid, The:	
What Broadcasting Does for a Newspaper (Winfield Barton).....	344	Adding Audio-Amplification to the R. B. One-Tube Reflex.....	260
*What We Think the Public Wants (E. F. Mc Donald Jr.).....	382	Adding R. F. to Any Receiver.....	436
*When the Prison Band Goes on at WOS (J. M. Witten).....	205	B Battery Trouble.....	410
Who Heard England?.....	341	Bank Winding.....	348
Broadcasting Stations:		Condenser Plates and Capacities.....	534
Supplemental List of Broadcasting Stations in the U. S. from August 8 to August 24 Inclusive.....	79	Crystal Detector and the Grimes Circuit, The.....	168
Revised List of U. S. and Canadian Broadcasting Stations to August 24th Inclusive.....	174	How to Bias a Grid.....	80
Supplemental List of Broadcasting Stations in the United States from August 25, to November 16, Inclusive.....	262	How to Connect Jacks.....	347
Supplemental List of Broadcasting Stations in the United States from November 17 to December 14 Inclusive.....	354	How to Make a Wave-Trap.....	348
		Knock-Out Reflex on 200 Meters, The	534
		Making Reflex Sets Selective.....	536
		Oscillation of an R. F. Amplifier.....	440
		Oscillator Dial Settings on the Haynes "Super".....	536
		R. F. and the Flivver Circuit.....	350
		Regeneration and Squealing.....	532
		Series Parallel Connection for Dry Cells.....	536

## INDEX—Continued

	PAGE		PAGE
Standby Set, A	440	Single Circuit Set and the Sodian Tube, The	404
Super and the Special Transformer, The	534	Sodian Tube and Our "Knock-Out" Reflex, The	489
Tuned R. F. Amplification	82	Spider Webs and the One-Tube Reflex	306
Tuning the Single Circuit Tuner	532	*"Super" Wave-Changer from a Three-Circuit Regenerative Receiver, A	241
Use Grid Bias Only When Necessary	534	Transformers and Reflex Sets	307
Wavelength and Size of Coils	352	Winding the Transformer for Your Battery Charger	165
What the Grid Can and Cannot Do	80	<i>Interesting Court Decision, An</i>	280
<i>Guiding Our Mail Planes</i>	275	Is the Amateur at Fault? (Carl Dreher)	293
*HAMS Across the Sea (6 photos with captions)	422	Is the Broadcast Listener at Fault? (Carl Dreher)	424
How Far Have You Heard? (Announcing R. B.'s 2nd Prize Distance Contest)	420	<i>Is the Radio Corporation a Bad Trust?</i>	470
*How Germans Use Radio at Auto Races	233	<b>J</b> UST to Please the Wife (Harry Irving Shumway)	139
How Loud Shall the Loud Speaker Speak? (R. H. Marriott)	323	<b>K</b> EEPING Close to Employees	472
*How the C. Battery Prevents Distortion (John F. Rider)	298	*"Knock-Out" 3-Tube Set, A	325
*How to Build a Neutrodyne Receiver (Kimball H. Stark)	124	*Knock-Out Two-Tube Set, A (Walter Van B. Roberts)	456
*How to Build a Super-Heterodyne Receiver (George J. Eltz, Jr.)	71	<b>L</b> ET Your Discarded Set Serve Those Who Served You	4
*How to Eliminate Interference with a Home-Made Wave-Trap (A. J. Haynes, Jr.)	65	*Listener's Point of View, The (Jennie Irene Mix)	475
*How to Go About Buying a Set (William H. Cary, Jr.)	520	*Listening-in in Mammoth Cave (Fred G. Harlow)	197
*How to Increase Your Range (Arthur H. Lynch)	380	<i>Long Arm of the Explorer, The</i>	277
*How to Make a One-Tube Set That's a "Knock-Out" (Kenneth Harkness)	13, 496	<b>M</b> AKERS of Neutrodyne Sets Already in a Patent Fight	105
*How to Neutralize the Neutrodyne (Kimball Houten Stark)	222	*Making Radio Attractive to Women (Lewis Wood)	221
*I HAD to Tell It (Willis Kingsley Wing)	333	*Man-Made Static (A. F. Van Dyck)	461
*If You Like Them, Let Them Know It (Myra May)	246	* <i>March of Radio, The (J. H. M.)</i>	3, 91, 271, 371, 468
*In the R. B. Lab.:		<i>More About Short-Wave Transmission</i>	103
Adding R. F. to a Standard Three Circuit Set (Russell Sheehy)	402	Music Dealers: Logical Salesmen of Radio Sets (T. M. Pletcher)	226
Building Your Own Lab.		<i>Music Publishers to Push Their Own Songs at Broadcasting Stations</i>	12
78, 166, 244, 308, 405,	495	*"Must Be Heard to Be Appreciated" (3 Photos)	50
Condenser Sweeper, A	77	<b>N</b> EUTRODYNE:	
Convenient Head-Phone Holder, A	77	*How to Build a Neutrodyne Receiver (Kimball H. Stark)	124
*Daniell Cell as an "A" Battery (Dr. E. Bade)	239	*How to Neutralize the Neutrodyne (K. H. Stark)	222
Hanging Your Antenna to Trees (S. Oliver)	492	<i>Makers of Neutrodyne Sets Already in a Patent Fight</i>	105
How to Use the Super-Heterodyne on 100 Meters	495	*Operating the Neutrodyne Receiver (Kimball Houten Stark)	310
*Improving the One-Tube Reflex Set	236	*New Equipment:	
Latest Reports on the Grimes Circuit, The	303	Acco Battery Carrier	170
Leaves from an Old Timer's Note Book	244, 405	Adaptor for UV-199	264
Loading the Twin Variometer Set (Wm. H. West)	307	Amsco Compensating Condenser	442
Making Transformers for the Super-Heterodyne	493	Bradleyleak	170
Measurement of Radio Frequency Voltage and Testing of Radio Frequency Transformers (W. Van B. Roberts)	493	Brandes Table Talker	442
Neutrodyning the Duplex	305	Carter Jack Switch	442
One-Tube Reflex with a Ballantine Transformer, The	238	Combination Tip-Jack and Binding Post	264
Portable Set and the Automobile, The (C. H. Brown)	492	Crosley Multistat, The	84
Portable Set for an Open Antenna, A	304	Eveready "Skyscraper" B Battery	442
Rebuilding Your Charger	75	Exide Storage Battery	170
"Relay" Soldering Iron for Fine Work, A (H. A. Highstone)	404	Ez-toon Vernier Dial	264
		Federal No. 65 Transformer	84
		Freshman "Fix-o," The	84

## INDEX—Continued

	PAGE		PAGE
Frost Shock-Absorber, Standard Socket.....	264	*Simplified Super-Heterodyne, A (A. J. Haynes).....	210
Globe Multi-Phone Block.....	170	<i>Super-Heterodyne, The Coming</i> .....	96
Handy Charger, The.....	84	*Using What Junk You Have in Making a Super-Heterodyne (George J. Eltz, Jr.).....	143
Horne Verni-Tuner.....	170	Supplemental List of Broadcasting Stations in the U. S. from August 8 to August 24 Inclusive.....	79
"Improved" Battery Switch, The.....	84	Supplemental List of Broadcasting Stations in the United States from August 25 to November 16 Inclusive.....	262
Manhattan Loud Speaker, The.....	84	Supplemental List of Broadcasting Stations in the United States from November 17 to December 14 Inclusive.....	354
Na-Ald Fingertouch Vernier Dial.....	170	Supplemental List of Broadcasting Stations in the U. S. from December 15 to January 18th Inclusive.....	435
Penberthy 4-Pole Phone.....	264	Supplemental List of Broadcasting Stations in the United States January 15 to February 15.....	519
Radio Frequency Amplifier Unit.....	442		
Remler Variometer.....	442		
Rhamstine Victophone.....	170		
Storage Plate Battery, The.....	264		
Turney 3-Coil Mounting for Spiderwebs.....	264		
Valley Radio Battery Charger.....	264		
<i>New Standard for Wavelength Measurements, A</i>	376		
<i>New Standard Wavelength Stations</i> .....	472		
<i>New Threads in the Spider Web</i> .....	12		
*1923 Passes in Review (J. H. Morecroft).....	385		
<i>No Confirmation of Marconi's Sunset Line</i> .....	100		
<i>No Political Broadcasting in England</i> .....	473		
<b>O</b> <i>NCE You Hear Them Speak</i> .....	276		
*Operating the Neutrodyne Receiver (Kimball Houton Stark).....	310		
<b>P</b> <i>WX Reaching Out Farther</i> .....	374		
*Power Company Cuts Out "Static", A (Earl C. Mc Cain).....	466		
*Protecting Our Wealth in Timber.....	9		
<b>Q</b> <i>UALITY First" in Radio Reception</i> .....	92		
<b>R</b> <i>B.'s Coming Transatlantic Tests (Editor)</i>	163		
<i>Radio Corporation a Bad Trust? Is The</i>	470		
<i>Radio Cures Tubercular Patient</i> .....	474		
<i>Radio Hazards and Insurance Rates</i> .....	99		
<i>Radio Maps for New York City &amp; Washington</i>	469		
<i>Radio Replaces Flowers and Fruit at Hospital</i> ..	282		
Radio Sales and Service by the Musical Trade (W. L. Eckhardt).....	51		
*Radio Vagabonding (Peter Taylor).....	129		
<i>Real Information on the Size of Radio Audiences</i>	468		
Revised List of U. S. and Canadian Broadcasting Stations.....	174		
Right Insulator in the Right Place, The (Paul McGinnis).....	331		
*Running the Submarine Gauntlet with a Cargo of "Gas" (Haydn P. Roberts).....	106		
*Rushing Relief to Japan.....	3		
* <b>S</b> <i>HOOTING Trouble in the Super (A. J. Haynes)</i> .....	411		
*Simplified Super-Heterodyne, A (A. J. Haynes).....	210		
<i>Some Excellent Radio Health Talks</i> .....	105		
* <i>Some Problems in the Broadcasting of Religion</i>	11		
<i>Sound: A Matter of Personal Opinion (R. H. Marriott)</i> .....	400		
<i>Spark Interference</i> .....	474		
<i>Standard Wavelength Stations, New</i> .....	472		
*Steinmetz, Charles Proteus (J. H. Morecroft)	296		
<i>Storage Battery Broadcasting Station, A</i> .....	97		
*Stray Capacity: When You Want It and When You Don't (Jesse Marsten).....	34		
Super-Heterodyne:			
*How to Build a Super-Heterodyne Receiver (George J. Eltz, Jr.).....	71		
*Shooting Trouble in the Super (A. J. Haynes).....	411		
		* <b>T</b> <i>AKING Ohms Out of an Antenna (L. M. Hull)</i> .....	406
		*Transatlantic Broadcasting Tests and What They Prove, The.....	183
		Transatlantic Tests, R. B.'s Coming (The Editor).....	163
		*Tricks Used in Staging Invisible Shows (C. H. Huntley).....	24
		*Two-Stage Amplifier for Your Receiver, A" (Carl Goudy).....	250
		* <b>U</b> <i>SING What Junk You Have in Making a Super-Heterodyne (George J. Eltz, Jr.)</i> .....	143
		* <b>V</b> <i>ARIOUS Circuits and What They Mean Pt. I (Zeh Bouck)</i> .....	160
		*Various Circuits and What They Mean Pt. II (Zeh Bouck).....	217
		*Various Circuits and What They Mean, Pt. III (Zeh Bouck).....	313
		*Various Circuits and What They Mean, Pt. IV (Zeh Bouck).....	365
		*Various Circuits and What They Mean Pt. V (Zeh Bouck).....	513
		*Voice from the Banks of the Seine, A (Frederic M. Delano, Jr.).....	62
		<b>W</b> <i>GY and KDKA Recommended as Wavelength Standards</i> .....	275
		<i>WGY Offers \$500 for Prize Radio Drama</i> .....	5
		*Well-Made Place for a Well-Made Set, A...	57
		*What a College Can Do In Broadcasting (Franklin Clement).....	58
		What Broadcasting Does for a Newspaper (Winfield Barton).....	344
		*What Causes Fading? (P. P. Eckersley).....	48
		*What Kind of Receiver Shall I Buy? (Arthur H. Lynch).....	117
		*What Makes the Wheels Go 'Round? (Walter Van B. Roberts).....	426
		<i>What Mr. G. W. Pickard Has Found About Fading</i> .....	374
		*What Our Readers Write Us.....69, 164, 230,	528
		*What Radio Means at a Rocky Mountain Ranch (Ashley C. Dixon).....	194
		*What Radio Means to Me (W. Francis Goodreau).....	234
		*What We Think the Public Wants (E. F. Mc Donald, Jr.).....	382

## INDEX—Continued

	PAGE		PAGE
*What You Should Know About Antennas and Grounds (R. H. G. Mathews).....	201	*Hibben, John Greer.....	273
*When Cowboys Heard Bedtime Stories (Thomas H. McKee).....	338	Hodgekins, Marie.....	25
*When the Prison Band Goes on at WOS (J. M. Witten).....	205	Hoxie, C. A.....	389
<i>Where is the Alternating Current Filament Tube?</i>	101	Hull, Lewis M.....	444
Who Heard England?.....	341	Huntley, C. H.....	86
Who Will Retail Radio?.....	51, 53	Jasperson, R. O.....	356
*Why No Receiver Can Eliminate Spark Interference (L. A. Hazeltine).....	397	*Jenkins, C. Francis.....	97
*Why Radio Waves Travel and How (Walter Van B. Roberts).....	524	*Lang, Anton.....	377
*Why Some Applicants for Operators' Licenses Fail (Howard Pyle).....	507	Leonard, Agnes.....	245
*Why the Electrical Dealer is the Proper Outlet for Radio (George J. Eltz, Jr.).....	53	Lum, Bruce.....	317
*Why You Should Have a Wavemeter (George J. Eltz, Jr.).....	480	Mc Cain, E. C.....	538
<i>With Justice for All</i> .....	273	McDonald, Eugene F. Jr.....	190, 444
*Woman Who Makes Receiving Sets, A (Alfred M. Caddell).....	29	McGinnis, Paul.....	356
World Time Chart.....	180	McLellan, Eleanor.....	476
<b>Y</b> OUNG Heart, The (Robert Oliver).....	320	Manning, Charles T.....	508
		Marconi, Guglielmo.....	189
		Marlowe, Julia.....	246
		Marriott, R. H.....	444
		Martineau, E. J.....	317
		Martz, Earl.....	317
		*Molinari, Bartholomew.....	375
		Moore, Catherine.....	196
		Oliver, Frank.....	25
		Ottersen, Ragna.....	61
		Powell, John.....	478
		Pyle, Howard S.....	356
		Rice, Martin P.....	186
		Roberts, Haydn P.....	172
		*Roberts, Quincy F.....	374
		Roberts, Walter Van B.....	444
		Rodgers, W. W.....	444
		Saltzman, Charles McK.....	358
		Schnell, F. H.....	422
		*Shearer, Augustus H.....	7
		Smith, Edward H.....	25
		Smith, Fred.....	317
		Sothorn E. H.....	246
		Squier, George O.....	358
		Stark, Kimball H.....	172, 312
		Steinmetz, Charles Proteus.....	297
		Vaaler, Ruth.....	60
		Van Dyck, A. F.....	538
		Waldron, C. J.....	229
		Winterbottom, W. A.....	191
		*Yonemura, K.....	4
		Young, Owen D.....	184
		<b>AUTHORS</b>	
		Barton, Winfield.....	344
		Bouck, Zeh.....	160, 217, 313, 365, 513
		Brown, C. H.....	492
		Caddell, Alfred M.....	28, 449
		Cary, William H. Jr.....	520
		Clement, Franklin.....	58
		Delano, Frederic M. Jr.....	62
		Dixon Ashley C.....	192
		Dreher, Carl.....	37, 293, 424
		Eckersley, P. P.....	48
		Eckhardt, W. L.....	51

### PORTRAITS

(\*Portraits in "The March of Radio")

Arden, Cecil.....	248
Bethman, Florence.....	30, 33
Beverage, Harold W.....	393
Binns, Jack.....	451
*Bok, Edward W.....	372
Cary, Jr. W. H.....	538
*Colyer, D. B.....	373
Conrad, Frank.....	361
Coolidge, Pres.....	302
Damrosch, Walter.....	477
Davis, H. P.....	361
*De Forest, Lee.....	92
De Leath, Vaughn.....	50
Deloy, M. Leon.....	423
Dixon, Ashley C.....	266
Eckersley, P. P.....	362
Eckhardt, W. L.....	86
Eltz, George J. Jr.....	86
*Fairchild, Hoxie Neale.....	272
Felland, Gonard.....	60
*Ferrie, Gustave.....	378
Ford, Henry.....	188
*Fulton, H. E.....	278
Gabrilowitsch, Ossip.....	479
George, David Lloyd.....	182
Gish, Dorothy.....	245
Goodreau, W. Francis.....	235
Goudy, Carl.....	266
Groth, Sam.....	61
Harbord, James G.....	90, 187
Harding, Warren G.....	386
Harkness, Kenneth.....	86
Harrington, Edward F.....	317
Haynes, A. J.....	266
Hazeltine, Louis Alan.....	448

INDEX—Continued

	PAGE		PAGE
Eltz, George J. Jr.....	53, 71, 143, 480	Morecroft, J. H.....	296, 385
Goodreau, W. Francis.....	234	Nyman, A.....	151
Goudy, Carl.....	250	Oliver, Robert.....	320
Harkness, Kenneth.....	13, 496	Oliver, S.....	492
Harlow, Fred G.....	197	Pletcher, T. M.....	226
Havens, B. S.....	287	Pyle, Howard S.....	289, 507
Haynes, A. J.....	65, 210, 283, 413	Rider, John F.....	298
Hazeltine, L. A.....	397	Roberts, Haydn P.....	106
Hull, L. M.....	406	Roberts, Walter Van B.....	426, 456, 493, 524
Huntley, C. H.....	24	Rodgers, W. W.....	359
Lynch, Arthur H.....	117, 380	Shumway, Harry Irving.....	139
McCain, Earl C.....	466	Stark, Kimball Houton.....	124 223, 310
McDonald, E. F. Jr.....	382	Taylor, Peter.....	129
McGinnis, Paul.....	331	Van Dyck, A. F.....	461
McKee, Thomas H.....	338	Wing, Willis Kingsley.....	333
Marriott, R. H.....	323, 400	Witten, J. M.....	205
Marsten, Jesse.....	34	Wood, Lewis.....	221
Mathews, R. H. G.....	201		
May, Myra.....	246		
Mix, Jennie Irene.....	475		
M., J. H.....	3, 91, 271, 371, 468		



Behind the Scenes at a Broadcasting Station

# RADIO BROADCAST



7-501  
282  
130  
V. 4 # 1 NOV.

How to Make a Receiving Set That's a "Knock-out"

What Causes Fading?

Eliminating Interference  
with a Home-Made  
Wave-Trap

Who Will Retail  
Radio?

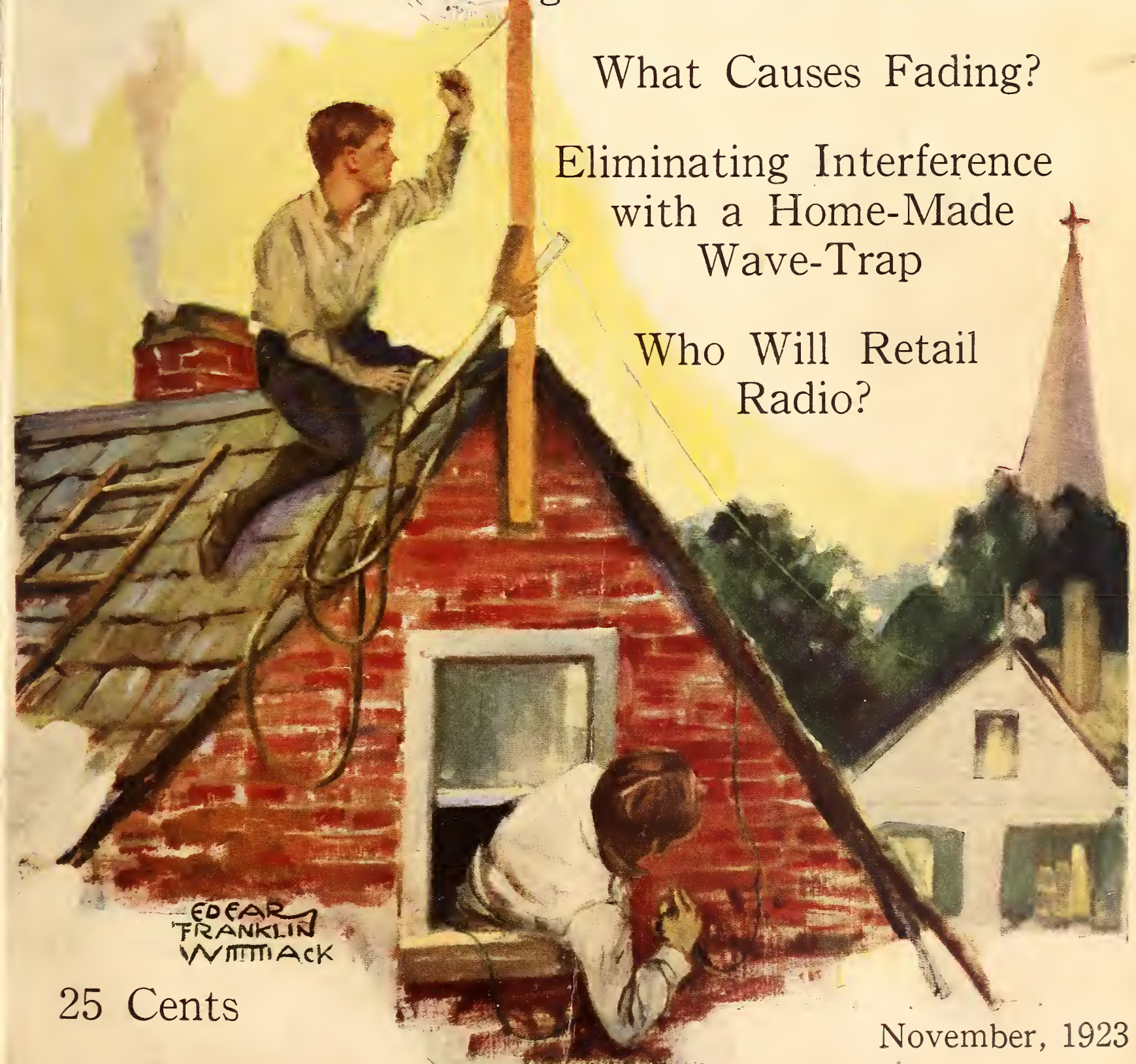

EDGAR  
FRANKLIN  
WITTACK

25 Cents

November, 1923

Published by

DOUBLEDAY, PAGE & CO.

Garden City, N. Y.



★

## It Bridges the Vastness of Space

*A Specially  
Designed Tube  
For Every  
Radio Use*

**Cunningham Radio Tubes**

<b>C-301A</b> —6 Volts ¼ amp. Amplifier . . . . .	<b>*6.50</b>
<b>C-299</b> —3 Volts .06 amp. Dry Battery Det. and Amp. . . . .	<b>6.50</b>
<b>C-300</b> —6 Volts Gas Con- tent Detector . . . . .	<b>5.00</b>
<b>C-11</b> —1.1 Volts .25 amp. Dry Battery Det. and Amp. Special Base. . . . .	<b>6.50</b>
<b>C-12</b> —Similar to C-11 with standard base. . . . .	<b>6.50</b>

**S**INCE Marconi first successfully spanned the Atlantic Ocean, with the wireless telegraph, radio has ever been outstanding as an invention of unlimited importance to humanity.

In 1909 the broadcasting of that now famous distress call, CQD, from the sinking passenger liner, S. S. *Republic*, established in the eyes of the entire world the tremendous importance of radio on the high seas.

In 1912, when that gigantic liner, the S. S. *Titanic*, struck an iceberg far from shore, in the north Atlantic, with thousands of passengers aboard, it was the SOS call of her wireless that brought rescue ships from all parts of the ocean. Here again radio demonstrated to the world its great service in the saving of human life.

During the war communication controlled the destinies of armies. Here radio played an exclusive part in the establishing of communication between ships at sea, from ship to shore, and from aeroplane to ground, where the use of wires was impossible.

In recent years the development of the vacuum tube has not only improved radio for the purpose of marine, commercial and military communications, but through radio telephony and public broadcasting, has established a new and even greater service to humanity.

Cunningham Vacuum Tubes are the product of years of research and experimental work by the Engineers of that great scientific organization, the Research Laboratory of the General Electric Company.

Cunningham Tubes are standard for all makes of receiving sets. Each of the numerous types have been designed to operate with maximum efficiency in one or more of the various applications of vacuum tubes to the radio art.

**Patent Notice:** *Cunningham tubes are covered by patents dated 11-7-05, 1-15-07, 2-18-08, and others issued and pending. Licensed for amateur, experimental and entertainment use in radio communication. Any other use will be an infringement.*



*A. J. Cunningham Inc.*

**Home Office:**  
248 First Street  
San Francisco, Calif.

154 West Lake Street  
Chicago, Illinois

30 Church Street  
New York City, N. Y.

★ Tested and approved by RADIO BROADCAST ★



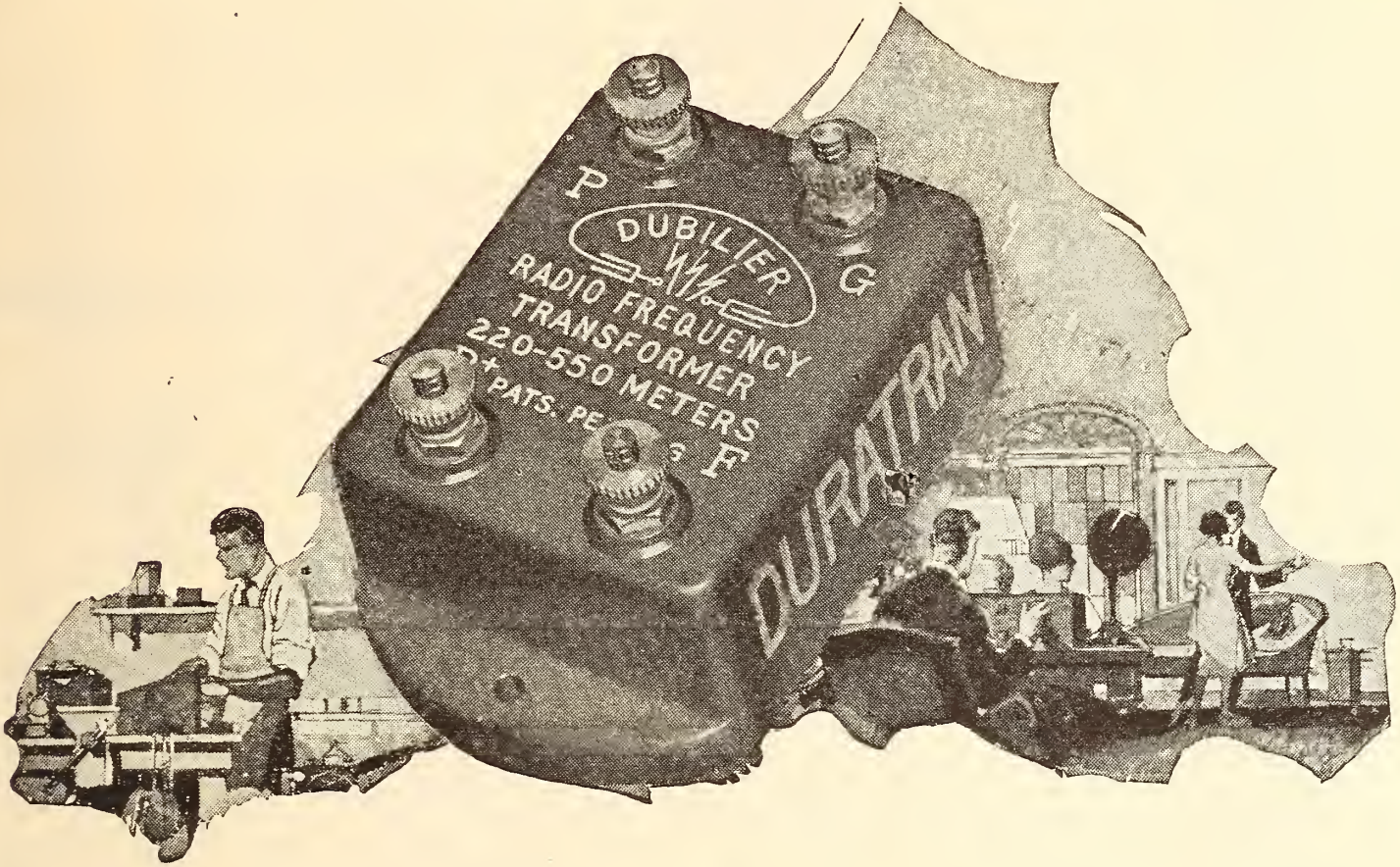

# The DUBILIER Duratran—

*Radio-Frequency Amplification on All Wave-Lengths*

The Dubilier Duratran is the supreme radio-frequency transformer.

It amplifies powerfully and uniformly *over all wave lengths* now used by broadcasting stations.

Price \$5.00. At all good dealers.

**DUBILIER CONDENSER AND RADIO CORP.**

48-50 West Fourth Street, New York City



Dubilier  
Micadons

Dubilier  
Variadon



Dubilier  
Ducon

# DUBILIER DEVICES

# Radio Broadcast

ARTHUR H. LYNCH, EDITOR

NOVEMBER, 1923

THE ZR-1	- - - - -	Frontispiece
THE MARCH OF RADIO	- - - - -	J. H. M. 3
HOW TO MAKE A ONE-TUBE REFLEX SET THAT'S A KNOCK-OUT	Kenneth Harkness	13
TRICKS USED IN STAGING INVISIBLE SHOWS	- - - - -	C. H. Huntley 24
A WOMAN WHO MAKES RECEIVING SETS	- - - - -	Alfred M. Caddell 29
STRAY CAPACITY: WHEN YOU WANT IT AND WHEN YOU DON'T	Jesse Marsten	34
BEHIND THE SCENES AT A BROADCASTING STATION	- - - - -	Carl Dreher 37
Drawings by Thomas E. Monroe		
THE "DOPE" ON WAVELENGTHS AND KILOCYCLES	- - - - -	47
WHAT CAUSES FADING?	- - - - -	Capt. P. P. Eckersley 48
"MUST BE HEARD TO BE APPRECIATED"	- - - - -	50
WHO WILL RETAIL RADIO?		
Radio Sales and Service by the Musical Trade	- - - - -	W. L. Eckhardt 51
Why the Electrical Dealer is the Proper Outlet for Radio	- - - - -	George J. Eltz, Jr. 53
A WELL-MADE PLACE FOR A WELL-MADE SET	- - - - -	57
WHAT A COLLEGE CAN DO IN BROADCASTING	- - - - -	Franklin Clement 58
A VOICE FROM THE BANKS OF THE SEINE	- - - - -	Frederic M. Delano, Jr. 62
HOW TO ELIMINATE INTERFERENCE WITH A HOME-MADE WAVE-TRAP		
	A. J. Haynes, Jr.	65
WHAT OUR READERS WRITE US	- - - - -	69
HOW TO MAKE A SUPER-HETERODYNE RECEIVER	- - - - -	George J. Eltz, Jr. 71
IN THE R. B. LAB	- - - - -	75
ADDITIONAL BROADCASTING STATIONS IN THE U. S.	- - - - -	79
THE GRID—QUESTIONS AND ANSWERS	- - - - -	80
NEW EQUIPMENT	- - - - -	84
AMONG OUR AUTHORS	- - - - -	86

Copyright, 1923, by Doubleday, Page & Co. All rights reserved

TERMS: \$3.00 a year; single copies 25 cents

F. N. DOUBLEDAY, Pres.

ARTHUR W. PAGE, Vice-Pres.

NELSON DOUBLEDAY, Vice-Pres.

RUSSELL DOUBLEDAY, Sec'y.

S. A. EVERITT, Treas.

JOHN J. HESSIAN, Asst. Treas.

DOUBLEDAY, PAGE & CO.

THE WORLD'S WORK    COUNTRY LIFE    THE GARDEN MAGAZINE    SHORT STORIES    EDUCATIONAL REVIEW

CHICAGO: People's Gas Bldg.

GARDEN CITY, N. Y.

NEW YORK: 120 W. 32nd Street

BOSTON: Tremont Bldg.

LOS ANGELES: Van Nuys Bldg.

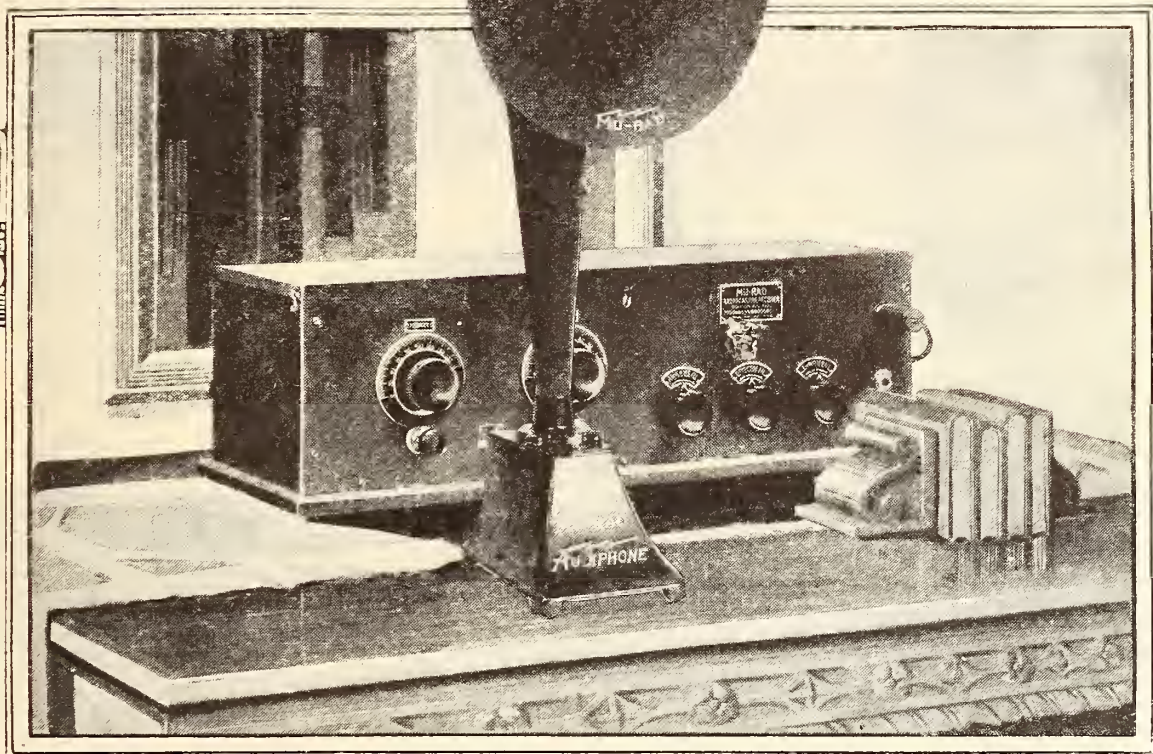

*A New MU-RAD Accomplishment —*  
**The MU-RAD AUDIPHONE**

The super-sensitive mica diaphragm produces sound by the contraction and expansion of an actuating contact, just as the vocal cords produce the voice.

*No Extra Battery Connections*

PRICE  
**\$25**

**T**HE REVOLUTION, wrought in radio reception by the MU-RAD RECEIVER is equalled by this radical improvement of sound amplification. The *MU-RAD AUDIPHONE* aimed for a higher perfection than ever attempted — duplication in electro-mechanical form of the greatest sound producing organ, the human voice. The result of five years' continuous research is a radio reproducer worthy of a finer classification than "loud speaker"; it is *a new radio instrument!*

WRITE FOR LITERATURE AND THE NAME OF THE NEAREST MU-RAD DEALER DEMONSTRATING THE MU-RAD AUDIPHONE

**MU-RAD LABORATORIES, INC.** ★

803 FIFTH AVE. ASBURY PARK, NEW JERSEY

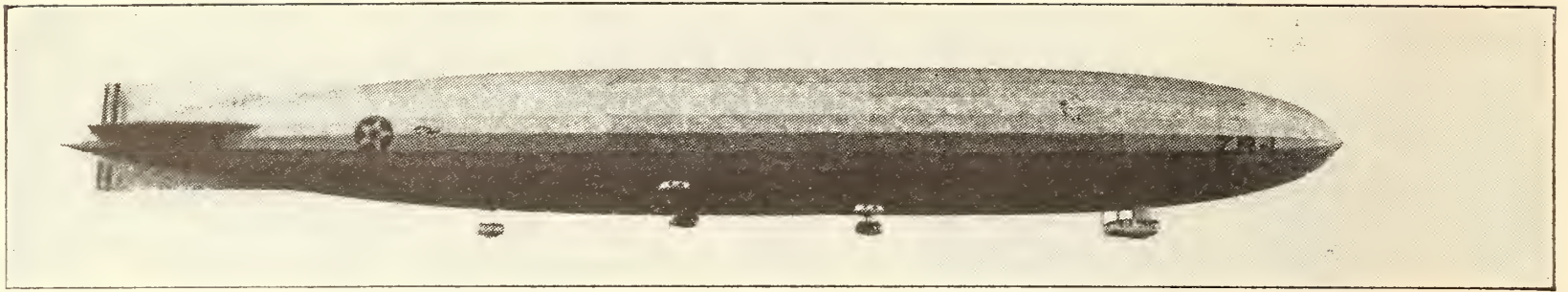

THE ZR-1 AS SHE APPEARED ON HER MAIDEN VOYAGE

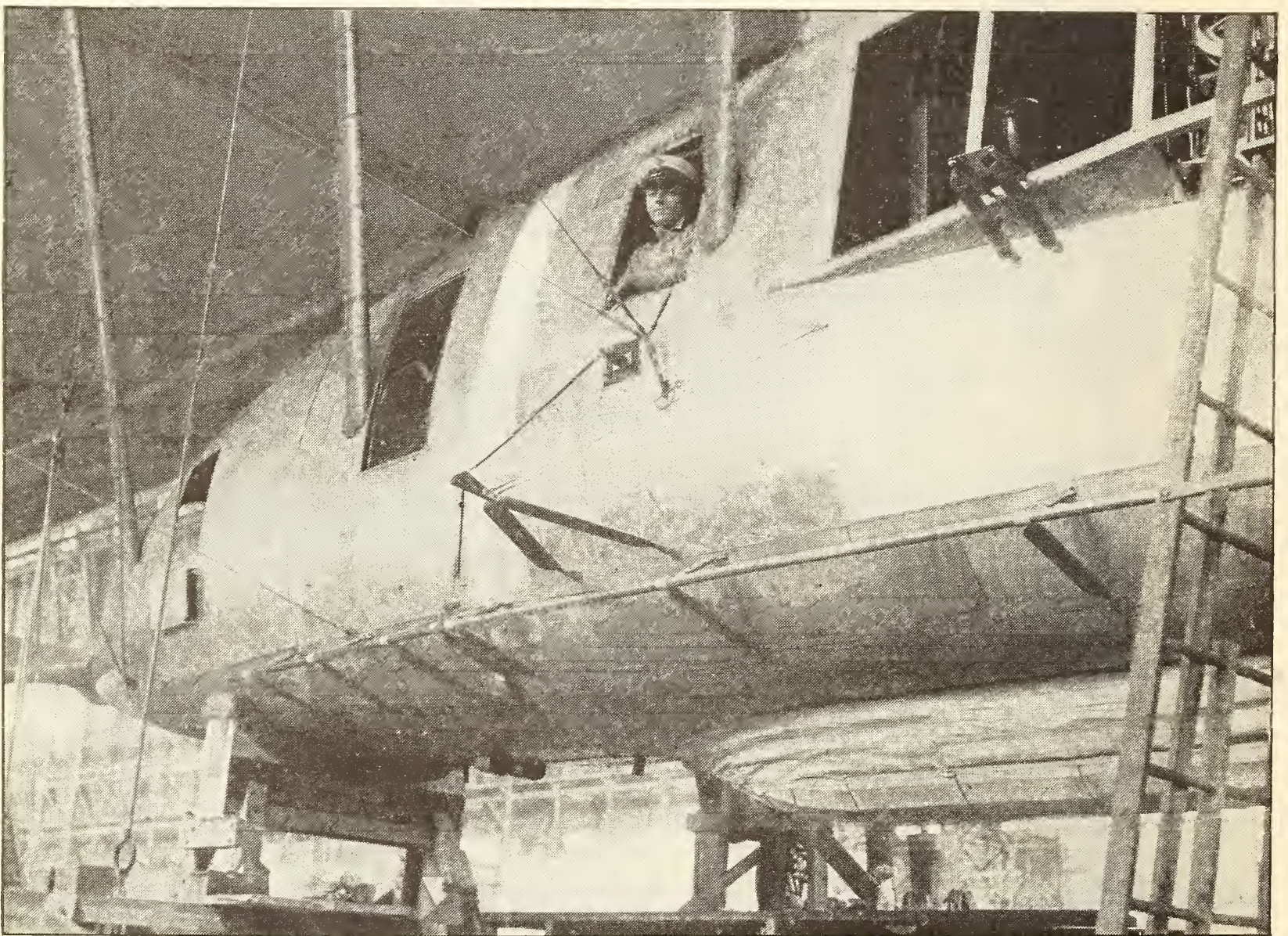

THE RADIO SHACK ABOARD UNCLE SAM'S LARGEST DIRIGIBLE

The ZR-1, recently completed at Lakehurst, N. J., is equipped with a 3-kilowatt continuous-wave transmitter and a Navy type receiver. The aerial consists of about one hundred feet of wire, weighted at the end, which is paid out through the side of the gondola. John T. Robertson, radio operator on the ZR-1, is shown at the window of the operating room. During the first flight, he kept the station at the Lakehurst field in constant touch with the ship's manoeuvres

# RADIO BROADCAST

Vol. 4 No. 1



November, 1923

## The March of Radio

### RUSHING RELIEF TO JAPAN

**I**N ABOUT three minutes at noontime on September first, two of the largest cities in the world, and towns for several hundred miles along the eastern coast of Japan, were transformed from thriving communities into masses of flaming wreckage strewn with dead and injured. Thousands of people who were trapped in buildings crashed to destruction; other thousands were buried beneath the ruins that fell without warning upon them. Some jumped into the canals, where they were killed by falling débris, or drowned. Eyewitnesses reported that they looked "like fishes floating on the surface of a pond."

Communication systems were destroyed. The radio transmitting station at Haranomachi, 155 miles from Tokio, was the first means by which news of the catastrophe and appeals for first aid could be sent to the outside world. For several days the brief dispatches, often conflicting but always horrible in their accounts of the loss of lives and the crying need of relief, contained only the barest outline of the situation. What news there was, had to be delivered by a courier system, hastily established between the stricken area and Tomioka, 187 miles from Tokio, where is located both the remote control apparatus for the 500-KW arc transmitter at Haranomachi, and the trans-Pacific receiving station.

K. Yonemura, superintendent of the Japanese operating staff, sent the first message. It was received by the Radio Corporation station in San Francisco, and read: "Conflagration

subsequent to severe earthquake at Yokohama at noon to-day whole city practically ablaze with numerous casualties all traffic stopped."

This despatch was given immediately to the Associated, International, and United Press; newspapers throughout America had headlines across the tops of their front pages the next morning; President Coolidge appealed to the American people for immediate and liberal contributions to the Relief Fund; and the great Red Cross organization, almost overnight, started its relief ships speeding for Japan from the nearest supply bases and organized country-wide drives for money with which to carry on the work.

During the following days, bits of news, rushed to station JAA at Tomioka, were translated into English by Yonemura and his assistants and sent out across the sea. Transmitting and receiving was carried on without a hitch at top speed. Although many of the land lines in the destroyed area remained intact, the central telegraph buildings were reduced to a mess of ruins and tangled wires, so that no messages could be sent to the radio station through these channels. But while successive shocks were wreaking further havoc in Tokio and Yokohama, while fires were breaking out in fifty different places simultaneously, while landslides were carrying whole thickly populated districts into the sea, and tidal waves were destroying ships and villages, communication between Japan and San Francisco—4,600 miles away—was still maintained.



THE MAN WHO KEPT THE MESSAGES MOVING

K. Yonemura, operating superintendent at the Japanese radio station who maintained communications with the outside world during the period of the earthquake

All of which indicates something of the part played by radio in one of the greatest catastrophes in history. The number of lives which radio has been responsible for saving in stricken Japan can never be closely estimated. If the 660-foot steel-and-concrete tower which supports the transmitting aerials at JAA had been brought down by the earthquake, thousands who have now been saved would surely have perished. As in the case of accidents at sea, it is in the sudden emergency—when seconds mean lives and when there is no other means of communication—that radio performs its finest service.

### Let Your Discarded Set Serve Those Who Served You

ONLY a few short years ago American hearts were thrilled by martial music and the sound of marching feet. We looked with confidence and approbation on the flower of our nation, as in every countryside, town and city, it passed in review prior to its departure for Europe and the great adventure.

War was our business for the time being, and we went into it with a will. Drives for this, that, and the other thing were put over by our relief organizations and our leading citizens. "Give till it hurts!" was our slogan, and as a nation, we responded.

Following the Armistice, our ports were the scenes of much rejoicing. "The boys" were coming home. Upon the arrival of each vessel whistles blew; bells rang; and once again the marching and the music quickened our pulses and stirred our hearts with feelings of mingled joy and sadness, for there were many blank files in the ranks. Of those who returned, many had to be brought on hospital ships—their marching days were over. Warm-hearted, impulsive Americans were eager to entertain these battered returning soldiers or sailors, and the sincerity of their welcome helped not a little to nerve the boys for the business of "carrying on." Thanksgiving Day and Christmas and New Year's were happy days for most of our war-worn veterans. Despite their infirmities, life still held something for them, for here, at home, were tender women and generous men solicitous for their comfort, and Uncle Sam himself was doing his level best to make them happy.

Now, after the passing of several summers and winters, the war, except for the income tax, the prohibition laws, and other occasional reminders, is a thing of the past—is like a great movie film, captivating in its glamor, its tragedy, and its departure from the routine of peace, but finally put aside with other memories. By degrees we have lost contact with our soldier sick, and the visitor in their hospitals to-day is the exception rather than the rule. Many of those heroes who helped break the Hindenburg Line, who faced death under the sea and in the air, are in hospitals to-day—nearly five years after the Armistice. Their diversions are few, and they have plenty of time to think about their ailments, to say nothing of the heart-aches brought home to them by a fickle and forgetful nation.

Radio is one of the means used during the war to aid in bringing about destruction. At present, several of the greatest advances in the art which came with the war have been incorporated in radio telephony—one of the principal sources of entertainment and instruction in our country. Broadcasting is more personal and more powerful, and to many appeals more strongly than the printed word. Through radio, we have an opportunity to show, in a small way, our appreciation of the valor and staunchness of those who gave more than their lives that we might continue the pursuit of happiness. Many a listener-in has purchased a broadcast receiver and then out-

grown it and used a more powerful set. Would it not be worth while to turn over all receivers of this kind to those men who, following the flag, have been temporarily put out of the running?

Why not get in touch with your nearest Veterans' Hospital or American Legion Post and let it know that you have a set available for use in the hospital? Or, if you prefer, just pack your outfit in a substantial box and send it to RADIO BROADCAST. If you have no preference regarding its disposal, we shall be glad to see that it gets into the hands of some veteran, who, with his buddies, will appreciate it.

### WGY Offers \$500 for Prize Radio Drama

**W**GY, at Schenectady, N. Y., is offering a prize of \$500 for the best radio drama submitted in competition during the three months' period beginning September 1.

The prize-winning play will be presented by the WGY Players during the winter months when transmission conditions are at their best

and when the maximum number of people will be listening-in. The audience is expected to be equivalent in size to the attendance at 500 performances of a stage production in a theatre seating 2,000 people. In addition to the \$500 prize, the successful writer will receive an introduction to a public as large as the reader-circulation of a national magazine, and he will have the personal satisfaction of taking a leading part in the development of a new phase of dramatic art. Other plays offered in competition will be put on the air if found suitable, and the author will be remunerated in every case.

One year's production of the radio drama by the WGY Players has convinced Martin P. Rice, director of broadcasting for the General Electric company, that there is a public demand for this type of entertainment and that the peculiar requirements of the radio drama as compared with the stage and the screen production will in time result in a new form of dramatic art. The screen has evolved a distinct type of drama which depends solely on the eye to satisfy the imagination. It is for the purpose of stimulating and encouraging the



TOKIO, IN WHOSE NARROW STREETS AND CROWDED BUILDINGS THOUSANDS PERISHED

Within a few hours after the first quake occurred, ships summoned by radio were speeding with supplies and food to the scene of the catastrophe. Tokio is in area one of the largest cities in the world, covering some  $37\frac{1}{2}$  square miles. A glance at the picture enables one to understand how thousands of terror-stricken people who escaped death or injury from falling buildings were trapped by fires when they tried to flee to safety through smoke and ruins along narrow streets that often ended in blind alleys



#### JAPAN'S ONLY IMMEDIATE MEANS OF COMMUNICATION WITH THE OUTSIDE WORLD

This station, JAA, was erected in 1921. It is hard to appreciate from the photograph the size of the reinforced concrete mast. Its top is 660 feet above the ground, and the diameter of its base is sixty feet. A 500-kilowatt arc set is used, on a wavelength of 14,350 meters. Messages bearing news of the catastrophe and requests for aid were sent from this station via the land lines controlled at the receiving station at Tomioka

development of the radio drama that the General Electric Company inaugurates this prize competition.

The author of the radio drama must place himself in the position of writing for a blind man. The lines of the characters must convey a picture of the scene in which the action takes place. This apparent handicap becomes an aid to action, however, as the writer need not restrict his play to three, four, or five scenes. For example, he can depict an automobile race and carry his audience through its exciting phases by means of the lines. He may take his listener from room to room or floor to floor in a dwelling, if farce or melodrama call for such action. The chase, long a popular feature in the early motion pictures, may be brought into the radio play by means of speech. The radio drama requires no scenery. No careful search need be made for locations. The spoken word builds the scenery.

Dramatic situations may be built up by the speaking voice and through the medium of sound making devices. The writer is encouraged to make use of sound devices, and the engineer will provide a means of producing through the air a counterpart of the prescribed sound. Rain, thunder, surf, the roar of a moving train, a pistol shot, an airplane, telegraph key, or automobile motor may all be reproduced in sound to impart atmosphere and realism.

Those who have written short stories, books

of fiction, scenarios, or plays, successfully or unsuccessfully, may have the germ of a prize-winning radio drama. Those interested may obtain a folder which sets forth the rules of the competition, with an outline of the special requirements of the radio play, by addressing Prize Competition, WGY Broadcasting Station, General Electric Company, Schenectady, N. Y.

#### Broadcasting and the Library

**B**ECAUSE, to a certain extent, the libraries and radio broadcasting have the same aims, it is surprising that they have not coöperated nearly as fully as they might. Much of the radio broadcasting is instructive and entertaining; and so it is with the books on the library shelves. Radio is ever improving the musical and literary tastes of thousands of listeners-in, who, having their interest aroused, may find increased pleasure from music or literature—and the libraries can supply the latter.

One of the most important duties of a librarian, especially in a small town, is telling stories to children. Many of the bed-time stories sent out by broadcasting stations, however, are insipid, lifeless, and "elocuted" rather than told. Would it not be well to have librarians, who have proven themselves past masters at storytelling, do a little broadcasting?

Then, too, in many towns the library is a



community center and it would be possible, under capable advice, to install a receiving set and loud-speaker in order that the townsfolk could listen-in on important speeches or other events broadcasted from cities within range.

Is it because our noses are so close to our own picture that we fail to get the proper perspective of the other fellow's? Surely the library has something to offer us in the matter of stimulating a greater interest in this fascinating science of ours—a science that any of us may enjoy without being scientific, for it is as easy to get results from a modern radio receiver as it is from such a commonplace article as the sewing machine.

Some libraries—usually those in which the librarian has become a "radio bug"—have taken advantage of radio. The recent convention of the New York Library Association, at which a special radio session was held, indicated that there is a great interest on the part of many librarians, who are at a loss to know how best to use the facilities that broadcasting offers. They find a great demand for radio books, but, being unfamiliar with the subject, do not know what to buy or what to recommend. There are many good books about radio, some general, some specific, and some very, very technical. Each radio enthusiast, whether he is experienced or not, usually has a definite idea about the book he wants; and there are few whose ideas entirely coincide. The New York State Library deals this perplexing situation for the librarian a telling blow by explaining that because radio is such a rapidly progressing art, librarians would do well, at present, to rely upon magazines and pamphlets. Excellent pamphlets may be obtained from the Superintendent of Documents, Washington, D. C.

Statistics are likely to be boresome, but we cannot overlook this opportunity to summarize briefly what radio is doing, and it is hoped the subjects will be looked into further by up-and-doing librarians.

There are four main divisions of radio activity: ship communication, broadcasting, international communication, and amateur communication.

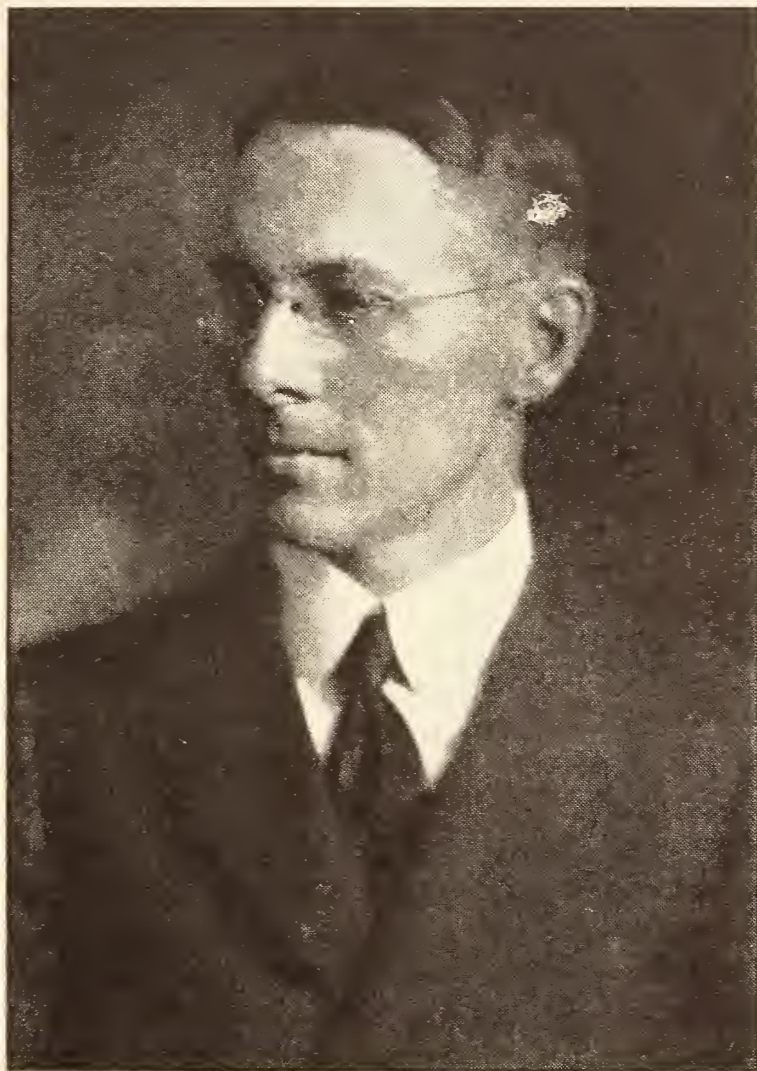

AUGUSTUS H. SHEARER

Past President of the American Library Association, who is keenly interested in the development of radio for the library and the library for radio. (See Mr. Shearer's statement on page 8)

As there is no other method of keeping in touch with vessels at sea, the importance of radio in ship service may be well appreciated. And this means of contact is not confined to the mere exchange of messages; it is an important addition to the mariner's devices for enabling him to navigate properly, whether he is under the sea, on the sea, or in the air. So many descriptions of radio saving life at sea have been published that we feel reiteration is unnecessary.

The newest division of radio is, of course, broadcasting. It is the application of this branch of the science, which in the early days was considered the chief drawback to radio (because secrecy was impossible), that has of itself commanded a position among the greatest industries we boast. Its importance in moulding nationwide opinions on politics, religion, learning, brotherhood, and even international relations is second only to printing. The day is rapidly approaching when most of our homes will be radio-equipped. Bringing the farmer and the sheep herder and the mountaineer into intimate contact with the world's greatest exponents of culture must help to make a more cultured race. Is not such culture one of the dispensations of the ideal library?

The field of international radio communication is not an entirely new one, as is the case



Photo by Courtesy U. S. Forest Service

## WEALTH—

Compare this with the picture on the opposite page. This gives an indication of the vast areas of timber in one section of our Far West—the Columbia National Forest, Washington. Signaling by beacons, flags, heliograph or other visual methods have limitations imposed by conditions of weather, distance, and topography; courier systems are slow, and wire telegraphy impracticable. Radio is the one system by which reliable, rapid communication can be maintained between scouts and fire-fighters

with broadcasting, but it is one that is less spectacular and less intimately associated with our home life and is not accorded the importance it deserves. Few realize that nearly one third of the communication between this country and Europe and nearly half of the traffic across the Pacific is now carried on by radio—incidentally at a rate somewhat below existing cable rates for the same service.

A great network of high-powered stations, now in existence or in process of construction, will link up all the principal countries of the world. The significance of this far-flung system of communication was recently demonstrated before the Institute of Electrical Engineers when a lecturer sent four messages—one each to England, France, Norway, and Germany—and received replies to each in less than five minutes.

To-day, the amateur activity is greater than ever before, although it has been overshadowed to a considerable degree by broadcasting. It is a very worthwhile division of radio, and it is well to remember that many of the inventions that have gone to make radio the industry it is to-day must be credited to amateurs.

The carrying on of communication between individuals by radio has always tended to promote technique in design and operation. In fact, during the World War, many of those

who undertook the task of teaching radio were recruited from the amateur ranks. Amateurs, as a whole, are very much on the job and always willing to lend a hand, and they have a better knowledge of the workings of radio than many of the so-called experts, whose principal stock in trade is a glib tongue. Where the librarian can secure the cooperation of a live amateur there is little doubt about the success of radio in the library.

From the other side of the fence, the librarian has a story to tell, for the library has much to offer the public which most of the public knows little or nothing about. In the words of Mr. Augustus H. Shearer, past President of the American Library Association;

The position of the library with regard to radio must be considered very soon and with great care. Already it has been discussed at the American Library Association and at the New York State meetings. The recent drop in circulation of books may be caused by interest in radio. But the library doubtless has a place in the broadcasting program. This was brought up first by a Western library which broadcasted the main points of new government documents. New books, book-reviews, and children's stories for bedtime have all been proposed as fields for the librarian, and there is no doubt that the librarian expert in various lines, would be glad to serve in these ways. The other side of the relationship,

that is, receiving by the library, is still a question. Where libraries have suitable auditoriums, it is possible that the library's function should be broadened to provide for its clientele the things which the books can not give—the spoken word and music. This is one of the effects that radio may have on existing institutions, and the library must be alive to its possibilities.

### Protecting Our Wealth in Timber

**O**F ALL the waste to which much of our national wealth is subjected, probably the greatest occurs in our timber lands. There is undoubtedly a greater loss each year in this one natural source of wealth than the total capital tied up in all the radio apparatus in the world. Of course the part of this waste which is caused by inefficient lumbering methods is gradually being eliminated as the price of lumber and its by-products continually mounts. But another and greater waste is a result of the tremendous

forest fires which occur generally as the woods dry out in the latter part of the summer, making the underbrush dangerously combustible, and ready for the locomotive's spark or some camper's carelessly tended fire.

Not only is there an enormous direct loss of the timber and the destruction of the young trees without which new forests cannot be created, but, indirectly, due to consequent floods and crop failures, forest fires levy a heavy tax which might be greatly reduced by modern communication methods.

Those who have not been in mountain territories devastated by a recent forest fire may not appreciate to what an extent the ground itself is consumed by the fire. In many forests the earth in which the trees grow is itself nothing but decayed and decaying vegetation—leaves, needles, and rotting tree trunks. When the material is dried out, it burns just like peat, so that many times the country over which a fire has passed is left nothing but bare rock.



Photo by Courtesy U. S. Forest Service

#### —AND POVERTY

The fire which wiped out this area in the Colorado National Forest is shown still smouldering. It might have been checked in its early stages had the radio telephone or telegraph given the fire-fighters immediate information of it. The destroyed timber in a fire such as this is not the only loss. The ground, composed largely of decayed leaves and trees, is dried out and burns like peat, with the result that on mountain-sides or wherever the land is sloping, heavy rains race down into the valleys, causing floods, as there is no longer the spongy earth to hold the water. If crops survive these floods, they are likely to perish in the dry season, none of the year's rainfall having been held in reserve in the timber land



Photo by Courtesy U. S. Forest Service

#### RADIO TELEPHONE APPARATUS READY FOR A TRIP ACROSS THE MOUNTAINS

Portable equipment is used by the forest rangers in the Missoula National Forest, Montana, for communication over short distances which cannot practicably be spanned in any other way

When rain falls in such districts it must immediately run off. The thick layer of humus—which has served for centuries as a sponge to hold the water for long periods, letting it out in the form of springs and rivulets throughout the normally dry season—having been consumed, the water runs off as fast as it falls and so causes the floods with which the forest denuded districts are annually visited. And of course when the dry season follows the rains, the crops generally fail as their normal water supply has been cut off.

These wastes from forest fires are so great that the value of any addition to the present methods of fire fighting and fire preventing, even though comparatively small, must be measured in millions of dollars.

Evidently one necessary adjunct to any scheme of fire fighting is rapid communication between the fire scouts and groups of fire fighters. Evidently, also, the method of communication must be one which permits a rapid transfer of the center of communication from one point to another as the fire races from place to place. The stringing of temporary wires for ordinary telephone connection is difficult if not impossible, and to any one familiar with the operations of the Signal Corps during the recent war the adaptability of radio to the purpose is at once apparent. Communication may be necessary between groups fighting on

opposite sides of the fire, an exigency to which wire communication is hardly suited. The distances to be covered are generally only a few miles, but the groups trying to get in touch with each other often cannot use visible signaling because of smoke or intervening mountains. These considerations point to radio as the means of communication best suited to the circumstances. The small-size Signal Corps radio telephone sets, good for perhaps twenty-five miles under ordinary conditions, and easily transported on a light truck, or even carried by a few men, as some Signal Corps rookies can well testify, are admirably suited to this need, and there are probably thousands of them lying in storage, waiting for just such an opportunity.

As more and more people become acquainted with the possible uses of radio, its use in fighting forest fires will naturally find wider application. From the U. S. Department of Agriculture we learn that only two permanent radio sets are now being used by the Forest Service in its fire control work on the National Forests. One of these is on Medicine Bow Peak, Medicine Bow National Forest, Wyoming, and the other, which is privately owned, is at Laramie, Wyoming. Let us hope that other forest rangers may soon be using portable radio telephone sets as a valuable adjunct to their present apparatus.

## Some Problems in the Broadcasting of Religion

AS WE have seen notice after notice of churches putting in broadcasting apparatus to send out their services to thousands who may be listening on Sunday morning, it has often occurred to us to ask the question: Is this a reasonable and useful rôle for radio to undertake? The first answer is naturally, Yes. What better service than sending the gospel far over the land and sea? The idea is a very attractive and reasonable one, the gospel must go far and wide and there is no method which is so well able to carry out the task as radio.

However, when we come to consider whether or not a broadcasting station should be installed in a certain church, the answer is by no means evident, and the more one hesitates to give the answer the more uncertain does it become. Radio reaches those who want to hear, and those who don't. It becomes apparent that we have not to consider the question, shall radio be utilized for broadcasting religion, but rather, shall radio be used by this particular church for broadcasting the particular form of worship used by this church? Thus put, the question is seen to involve much more than is at first supposed. In any good-sized town there are perhaps ten or twenty

different forms of the Christian religion, sufficiently different so that people pass by one church on their way to another where the form of service appeals to them more strongly.

Now, surely, one form of religion has as much right to the radio channels as has any other; it seems as though the Jew has as much right to his religion by radio if he so wants it as has the Christian; and the Catholic as the Protestant. If the rights of the different forms of religion are going to be preserved for each, it is not at once evident that any one form is entitled to the ether. However, if one church is granted this privilege and the scheme proves so successful that other churches are inclined to put in broadcasting stations, and there are no more available channels on Sunday morning, what is the radio inspector to do? Tell the Roman Catholic and Jew they cannot broadcast as all the facilities are at present taken by the Methodists and Baptists? Evidently such a situation is an impossible one.

How then shall the question be solved? We understand it has been the policy of the Bell system to refuse consistently to sell a radio station for church broadcasting, probably because the above pictured situation was visible to them on the horizon of radio development. The fact that this company, which, in general, has very liberal policies, has been so reticent



A NON-DENOMINATIONAL RELIGIOUS CONFERENCE OPENED TO THE RADIO AUDIENCE THROUGH WEAF  
 Rev. S. Parkes Cadman, D.D. (standing at the left) is shown answering questions submitted by the audience at the Men's Conference of the Bedford Branch Y.M.C.A., Brooklyn, N. Y., and read off to him by Mr. Halsey Hammond, conference chairman. The disseminating of religion in this manner has met with a tremendous response from the listeners-in. Filling the ether with the services of any particular denomination, however, is likely to be less justifiable than the broadcasting of these conferences

about putting broadcasting stations in churches, indicates a real difficulty in the situation.

It is interesting, therefore, to see that, finally, this company, which has the control of broadcasting station installations, has started to broadcast church services, but that it is the services of the New York Federation of churches which are being sent out from WEA. That is, whatever is common to many branches of religion is to be sent over the radio, while those particular ritualistic forms which have an appeal to a comparatively small number, will not be given.

As radio is destined, economically and politically, to bind us together more firmly, can it not accomplish, to some extent at least, unification of the religious ideas of the different creeds and cliques? Will it not do away with the "religious" squabbles which so frequently stir small communities? Is the self-sacrificing and penurious existence of the several ministers in the average small town really necessary? Of course the small town cannot reasonably support the half-dozen ministers which it tries to do, one believing in complete immersion and the other not; one believing dancing should be forbidden and the other holding it a harmless pleasure; one believing in predestination and the other in salvation by belief and deeds. Are these differences, which seem to multiply rather than diminish with passing years, really essential, or rather, have they not been evolved because small groups of people have isolated themselves more and more from other groups and surrounded themselves with a ritual and creed which makes them impervious to outside influences so that a real difference seems to exist where none really is?

It seems to an unbiased observer, viewing these various religious sects from a distance at which details are not visible, that most of the Christian beliefs and creeds are essentially the same. Are there not enough of the essentials, of the real elements of faith, common to all, that a unification might reasonably take place rather than further dissent and separation? Cannot radio perform in this field that knitting together of various peoples which it is sure to do in other fields? Cannot broadcasting supply the essentials of religion so that many fans of nominally different beliefs can listen-in and be benefited? Men with vision believe so, and are working toward that end.

### New Threads in the Spider Web

IN A recent communication, General James G. Harbord, President of the Radio Corporation, tells of the inception of the two new radio services which were predicted some months ago. There are now in operation direct radio channels from Radio Central on Long Island, to Holland and to Italy. These long channels will probably not have 100 per cent. reliability, but will be usable during a comparatively large part of the time.

There are now eight different long-distance radio channels emanating from New York, thus constituting a justification for the station name selected by its builders—Radio Central. It does not require much imagination to conceive of New York as the center of a spider web, from which the world's radio channels lead out, and with which all parts of the world are intimately connected by perhaps one or two relays.

In his letter, General Harbord himself brings out the unifying effect expected from radio mentioned above in these columns.

"Direct communication between the United States and Holland, and between the United States and Italy, has long been the dream of our friends across the sea. The opening of this remarkable service will link in a more perfect bond the business and social friendship of these peoples and will assist in bringing about the stabilization of trade conditions which depends so largely upon swift, reliable, and direct communication. . . ."

### Music Publishers to Push Their Own Songs at Broadcasting Stations

FRED FISHER, INC., New York music publishers, have announced a new department to be known as the Fred Fisher Radio Department. This department will do nothing but push the Fisher songs at the various broadcasting stations throughout the country.

Mr. Ely Dawson and Victor Oliver, the authors of "M. T. Pocket Blues," are connected with this new enterprise, which marks the first definite step made by any music publisher in creating a special department for such activities. This action is considered by the broadcasting stations as a full recognition of the great publicity value of radio by the music dealers.

J. H. M.

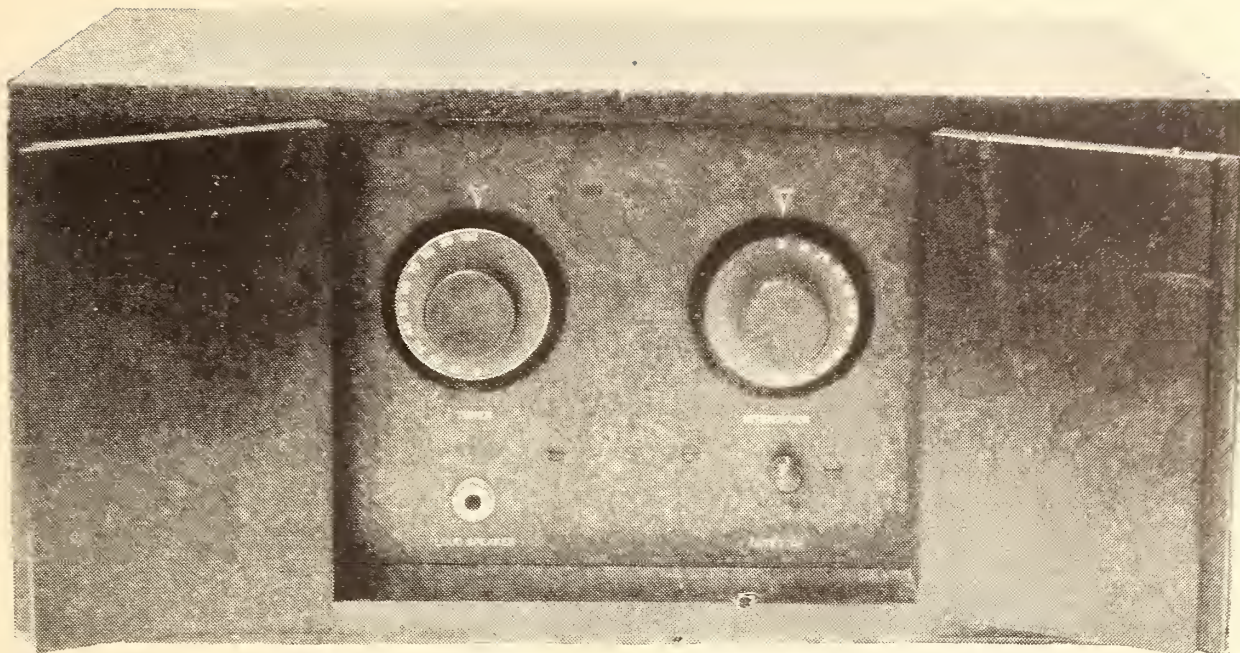

#### THE COMPLETE OUTFIT

Everything including the A and B batteries may be placed in an attractive cabinet. Some idea of the simplicity of operation may be had from a glance at the panel

## How to Make a One-tube Reflex Set That's a "Knock-Out"

Described in a Most Comprehensive Manner, with Complete Instructions for Building and Operating It. It Should Operate a Loud-Speaker over a Crystal Range

By **KENNETH HARKNESS**

Chief Engineer, The Radio Guild, Inc.

For some time we have been watching for a single-tube receiver combining long range and selectivity with ease of adjustment, economical operation, and portability. The receiver described in this article meets all these requirements in a surprising manner. In our tests we have used it with outdoor and lamp-socket antennas, with a ground connection alone (using no antenna), with every type of receiving tube we could lay hands on—and in every case it delivered the goods. Here is a circuit hard to beat and one we recommend for use by those who have been wanting to build a reliable, single-tube set.—THE EDITOR.

**W**E HAVE often heard of one-tube receivers that will actuate a loud speaker, but seldom do we have the experience of listening to such a performance; and in radio—hearing is believing—so we are justly skeptical of these "wonder sets."

Indeed, the super-regenerative "flivver" receiver was the first loud-speaking one-tube set\* we had occasion to witness in actual operation, and although it made a remarkable showing in reproducing local stations, distant reception appeared impossible and some rather

complicated knob and dial juggling was required in the process of tuning.

Immediately after the "super" craze died down, we were deluged with hashed-up versions of revived and rejuvenated but nevertheless ancient reflex circuits; but until recently we were still looking for a demonstration of a one-tube set that would make a loud speaker "percolate."

For this reason we spent many days and nights in an effort to produce such a single-tube receiver. Our work has resulted in an outfit that is simple and inexpensive to build, easy to install and operate as well as being compact and portable. It will function with any kind of receiving tube now on the market and will

\*See "Operating a Loud Speaker on One Tube Without Batteries" in RADIO BROADCAST for June, 1923.

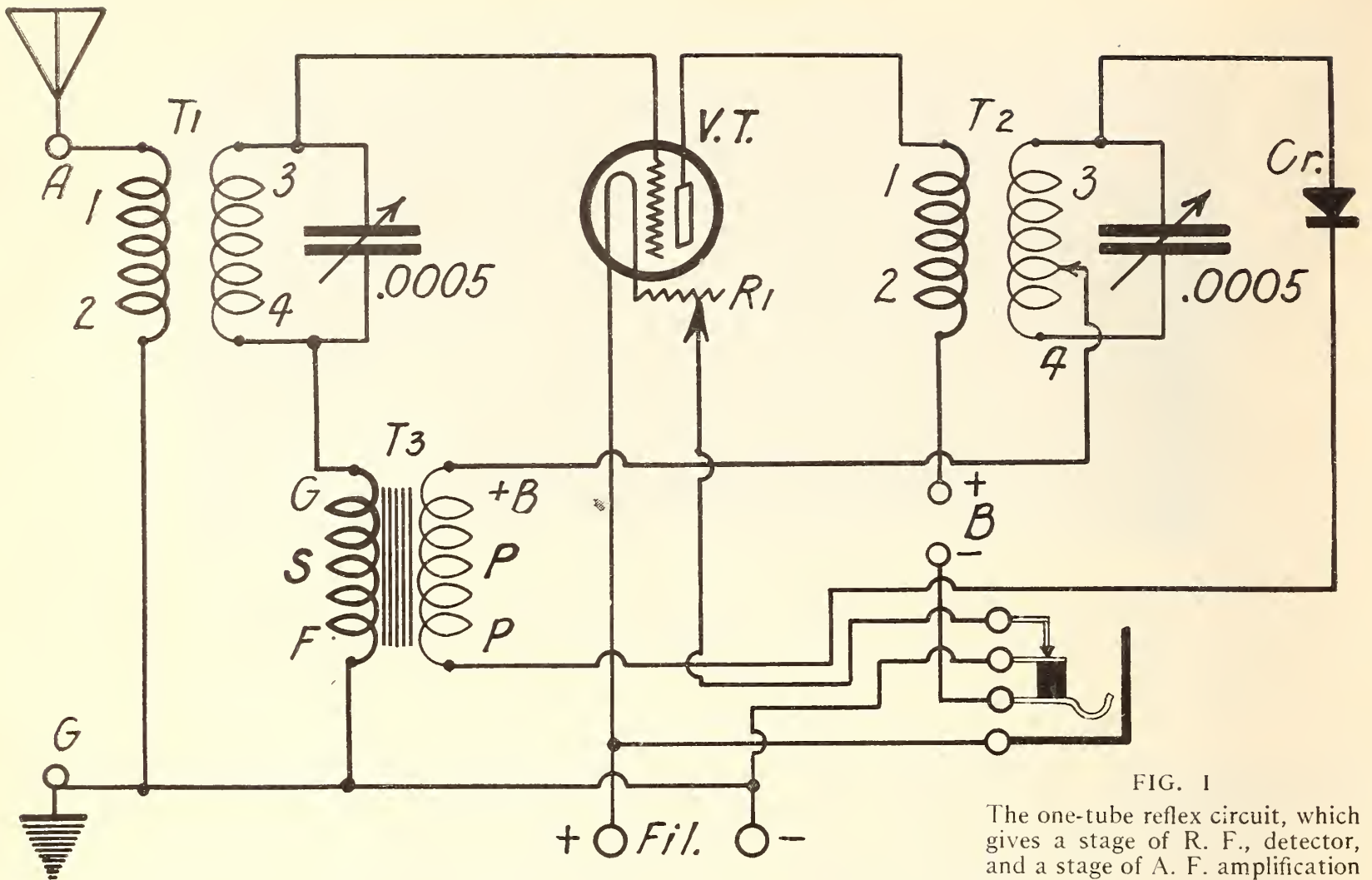

FIG. 1

The one-tube reflex circuit, which gives a stage of R. F., detector, and a stage of A. F. amplification

operate a loud speaker over distances about equal to those it is possible to hear with the telephones on an ordinary crystal receiver. When used with a headset it is capable of very long distance reception, extremely sharp tuning, and exceptionally clear reproduction of speech and music.

The receiver is essentially a one-tube reflex outfit, but involves certain modifications that make for efficiency, sensitivity, volume, clarity, and ease of control. It is:

*Efficient*—because the one tube is made to do double duty and because an improved circuit with correct constants is employed.

*Sensitive*—because a stage of *tuned* radio-frequency amplification is provided before the *tuned* detector circuit.

*Volume*—because a stage of audio-frequency amplification is used to amplify the rectified impulses and because *both* the radio-frequency amplifying and rectifying circuits are *tuned*—giving maximum amplification with corresponding selectivity.

*Clear*—because a crystal is used for rectification: and because, when properly adjusted, the vacuum tube does not oscillate and the howling and squealing so noticeable in regenerative receivers is totally absent.

So far, not so bad, eh?

#### METHOD OF PREVENTING SELF-OSCILLATION

ORDINARILY in a reflex circuit the tendency toward self oscillation is so great that a potentiometer or similar device must be employed to impress a positive charge on the grid so that the resultant grid current will prevent self-oscillation.\* In a plain radio-frequency amplifier this would be quite satisfactory, but when it is desired to use the same tube for audio-frequency amplification it is necessary to operate the grid at a *negative* potential or else the A. F. amplification will be *nil*! It is evident then that reflex systems utilizing a potentiometer stabilizer are out of the question.

We could employ reversed inductive or capacitive feed-back to balance the self-oscillations, but each of these systems has certain disadvantages; especially in a circuit having a variable resistance element such as a mineral rectifier. The adjustment would necessarily be tricky and unstable.

The method of preventing self-oscillation in the receiver to be described is not new, but, to the best of our knowledge, its application and dual functioning are original.

Briefly, if the grid and plate circuits of a

\*See "Radio-Frequency Amplification" by Kenneth Harkness, published by The Radio Guild, New York.



vacuum tube are adjusted to the same frequency, even though they are not in inductive relation, the inter-element capacity of the vacuum tube is large enough to feed back sufficient energy to produce self-oscillation. If a third and independent circuit is closely coupled to either the plate or grid circuit and this independent circuit is tuned, it will cause a reduction in the amplitude of the local oscillations, and if the initial amplitude is *not too great*, the reduction will be effective in preventing self-oscillation. Further, the energy in the independent third circuit may be fed into a rectifying device, the damping effect of which will still further aid in preventing undesirable self-oscillation.

The practical application of this system may be noted in Fig. 1. The primary coil of transformer T2 is in close inductive relation to the tuned secondary circuit—which latter functions in the dual rôle of the *independent third circuit* and the *tuned detector input*.

The rest of the circuit is standard, but every endeavor has been made to reduce the number

of controls without decreasing efficiency. Thus, the antenna circuit is made slightly aperiodic (i.e., requires no tuning over the range covered by the secondary); the filament circuit is "made" or "broken" by the automatic filament control jack, and a ballast resistance is used in place of an adjustable rheostat; the plate winding of T2 is sufficient to allow good transformation without direct tuning of the plate circuit; the grid and detector inductances are fairly widely separated and at right angles to each other so there is a minimum of inductive feed-back.

#### SIMPLE DESIGN AFFORDS EASY CONSTRUCTION

**A**N AMATEUR should have little difficulty in constructing a receiver of this type as the photographs afford constructional details which may be readily understood, even by the newcomer in the radio game.

In the top view, Fig. 2, the disposition of parts is clearly shown. The transformer mounted behind the left hand condenser constitutes, with the condenser, the tuned an-

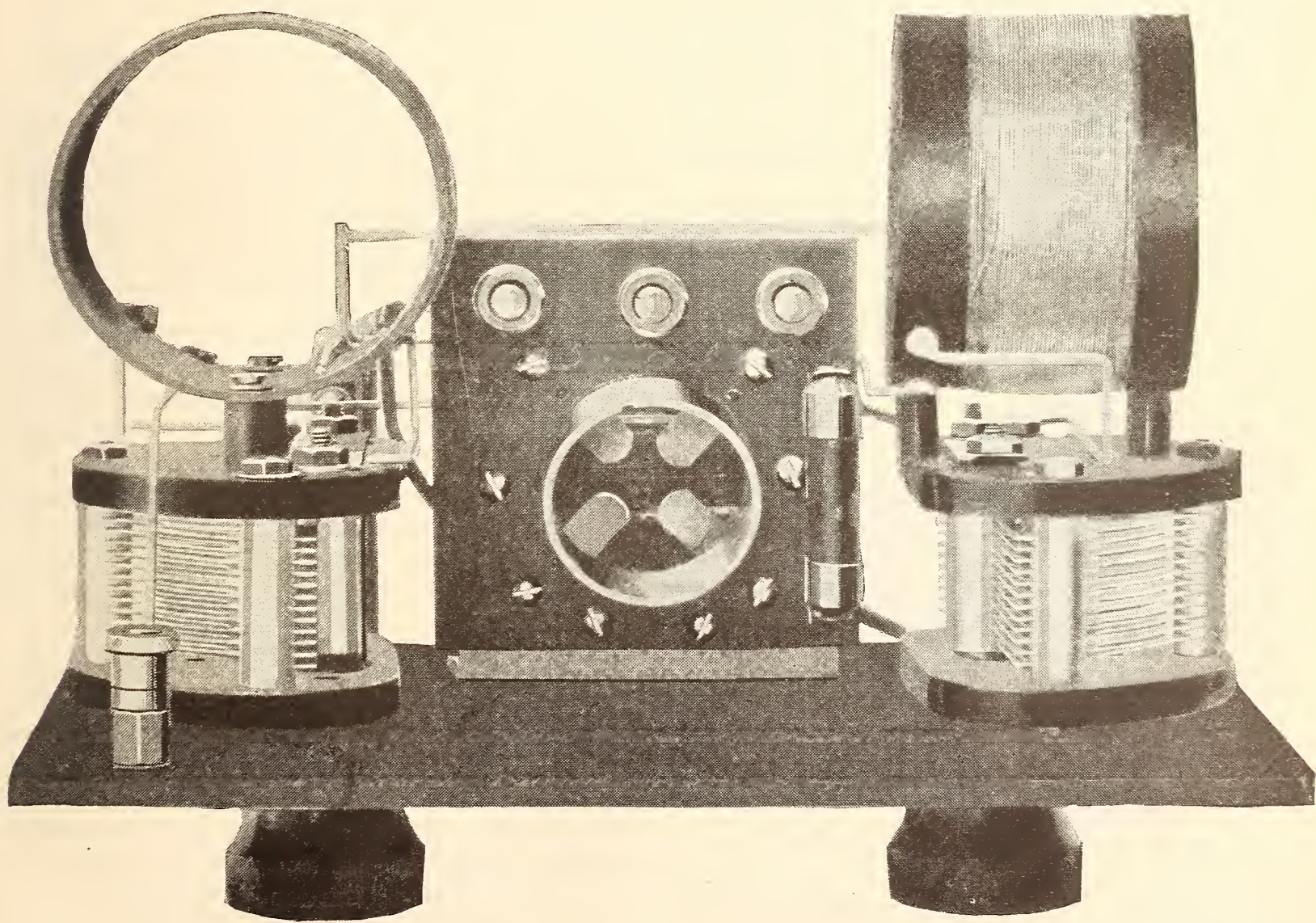

FIG. 2

This is how the receiver looks from above. Note that the two transformers (T1 at the left, T2 at the right) are mounted at right angles to each other

tenna, grid, radio-frequency transformer unit T<sub>1</sub>; at the right hand side is mounted the plate-detector, audio-frequency transformer unit (T<sub>2</sub>).

An "Amperite" or other fixed resistance is mounted at the right side and battery terminals in the rear of the socket strip.

In the front view, on page 13, may be seen the controlling knob of a mechanical crystal detector illustrated in Fig. 3. This detector has proved its excellence as to ease and stability of adjustment, two factors of prime importance which should be looked for in selecting this item; but any good crystal detector may be used.

The entire set is mounted within a special cabinet with provision for separate battery compartments. The top and center panels of the cabinet are hinged to allow access to the tubes and tuning controls. When closed, the instrument is completely protected from dust and injury.

Close study should be given the photograph of the empty cabinet, Fig. 4, which shows the proper measurements. It is advisable to secure all the material necessary before starting the actual assembly of this receiver.

#### LIST OF MATERIALS REQUIRED

- 1 Audio-frequency transformer,  $4\frac{1}{2}$  to 1 ratio
- 1 Panel-mounting crystal detector, mechanical adjustment preferred
- 2 Special tuned radio-frequency transformers, utilizing—
  - 2 .0005 mfd. variable condensers
  - 2  $\frac{1}{16}$ " Formica forms, 2" long and  $2\frac{5}{8}$ " dia.
  - $\frac{1}{8}$  lb. No. 28 cotton and silk insulated wire
  - 2 8" strips of 1" cambric cloth
- 8 Switch points and 8 hexagon brass  $\frac{6}{32}$  nuts for terminals

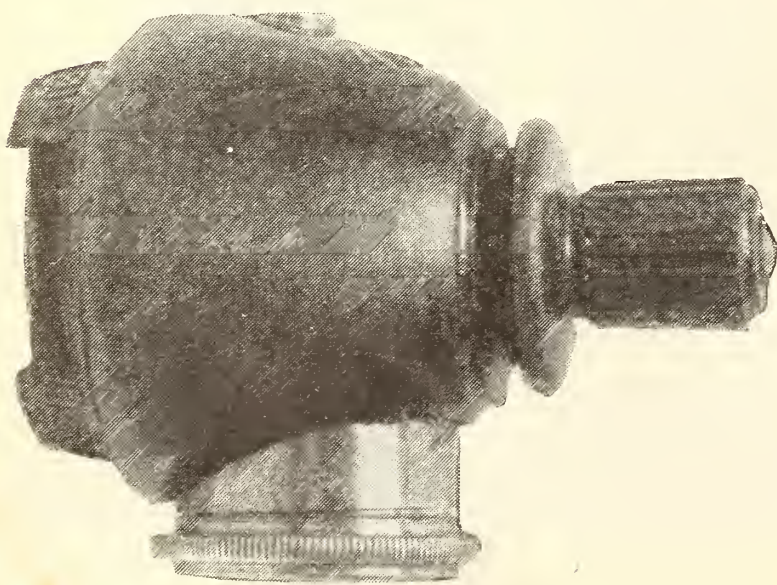

FIG. 3

A small French crystal detector which is gaining popularity in this country. Few are available at present, but they are to be marketed in quantities shortly. The cat-whisker and crystal are completely enclosed. Adjustment is accomplished by rotating the small knob shown at the right

4  $\frac{3}{4}$ " mounting pillars and 4 1"  $\frac{6}{32}$  round head machine screws for attaching the transformers to the condensers

2 dials to fit condenser shafts

1 Front panel  $7\frac{1}{2}$ " high, 9" long and  $\frac{3}{16}$ " thick

1 Sub-panel with spun-in socket  $3\frac{1}{2}$ " x 5" x  $\frac{3}{16}$ "

1 1" Brass angle  $3\frac{1}{2}$ " long,  $\frac{3}{16}$ " stock

1 Automatic filament-control jack. Micarta insulation

5 Binding posts,  $\frac{6}{32}$  screws

2 Spring mountings for Amperite or fixed resistance

4 Feet of bus bar

2 Feet of No. 23 bare copper wire

2 Feet of small flexible cambric tubing

8  $\frac{3}{8}$ "  $\frac{6}{32}$  round head machine screws

8  $\frac{3}{8}$ "  $\frac{6}{32}$  flat head machine screws

1 Vacuum tube, preferably a UV-201-A or C-301-A

1 45- or 90-volt B battery

1 A battery of 6 volts, either storage battery or dry cells

1 Headset or loud speaker

#### ANTENNA EQUIPMENT

Either 1 light-socket antenna attachment or

200 Feet No. 12 rubber-covered copper wire

3 5" glazed porcelain corrugated insulators

1 Lead-in insulator

1 Lightning arrester (not necessary when antenna attachment is used.)

#### CABINET MATERIAL

4 pieces  $7\frac{1}{2}$ " x  $8\frac{1}{2}$ " x  $\frac{1}{2}$ "

1 Base  $9\frac{1}{2}$ " x 18" x  $\frac{1}{2}$ "

1 Top piece  $2\frac{1}{2}$ " x 18" x  $\frac{1}{2}$ "

1 Cover 7" x 18" x  $\frac{1}{2}$ "

2 Doors  $4\frac{1}{2}$ " x  $7\frac{1}{2}$ " x  $\frac{1}{2}$ "

2 Front pieces  $7\frac{1}{2}$ " x  $4\frac{1}{2}$ " x  $\frac{1}{2}$ "

#### THE TUNED R. F. TRANSFORMER UNITS

**S**PECIAL care should be observed in constructing, or purchasing (if you do not care to build them), the tuned radio-frequency transformer units, as successful operation is greatly dependent upon them. For this reason exact specifications are given, and it would be well to employ similar material, follow the same constructional lines, and make all connections in accordance with instructions if duplication of the results mentioned above is expected.

Procure  $\frac{1}{8}$ -lb. of number 28 single cotton (under) and single silk (upper) insulated soft-drawn copper wire and two formica forms  $\frac{1}{16}$  inch thick, 2 inches long and  $2\frac{5}{8}$  inches in diameter.

Number 28, S.C.S.S. wire is chosen because it combines highest efficiency with exceptionally neat appearance. The double covering provides good spacing between the metallic conductors. The white cotton protective layer affords good insulation, while the silk layer is pleasing in appearance and does not allow the shellac to gather and harden between turns. The usual effect of increased distributed capacity resulting from the use of shellac or other dope on ordinary cotton covered wire is thus reduced.

It is interesting to note that when coils, especially cotton covered, are not treated with some form of moisture-resisting material, a relatively great amount of moisture will be absorbed, the insulation between turns is materially reduced, and this fairly low-resistance shunt across the coil is extremely detrimental to sharp tuning.

The particular size wire is chosen because with it a relatively small length of wire is required for any given inductance and in addition the value of capacity between turns and therefore the total value of distributed capacity is lower than would be the case with heavier wire.

#### MAKING TRANSFORMER T1

ONE of the two Formica forms (see list of materials) should be provided with four terminals and two mounting screw holes, made with a No. 27 drill. The terminals are situated  $\frac{3}{4}$ " apart,  $\frac{1}{4}$ " from one edge. The mounting holes are  $\frac{1}{4}$ " from each edge on a line parallel to the axis and between the two center terminals. The terminals may consist of switch points with the heads outside and hexagon brass nuts clamping them to the form inside. The projecting pieces of the screws are cut off and solder flowed over the nut to prevent loosening. Small holes to pass the wire should be drilled near terminals 1 and 3 (Fig. 1).

The secondary coil is wound on the form first; starting at terminal No. 3 to which the wire is soldered, 60 turns are placed evenly and tightly; the end of the wire is brought through the form at a point opposite terminal No. 4 and soldered to that terminal.

A one-inch strip of cambric cloth or other flexible sheet insulating material is wrapped over the secondary and held in place with glue.

The primary, of 15 turns, is wound on the insulating material, spaced in the center and in the same direction as the secondary.

The beginning is soldered to terminal No. 1 and the end of the coil is brought through the

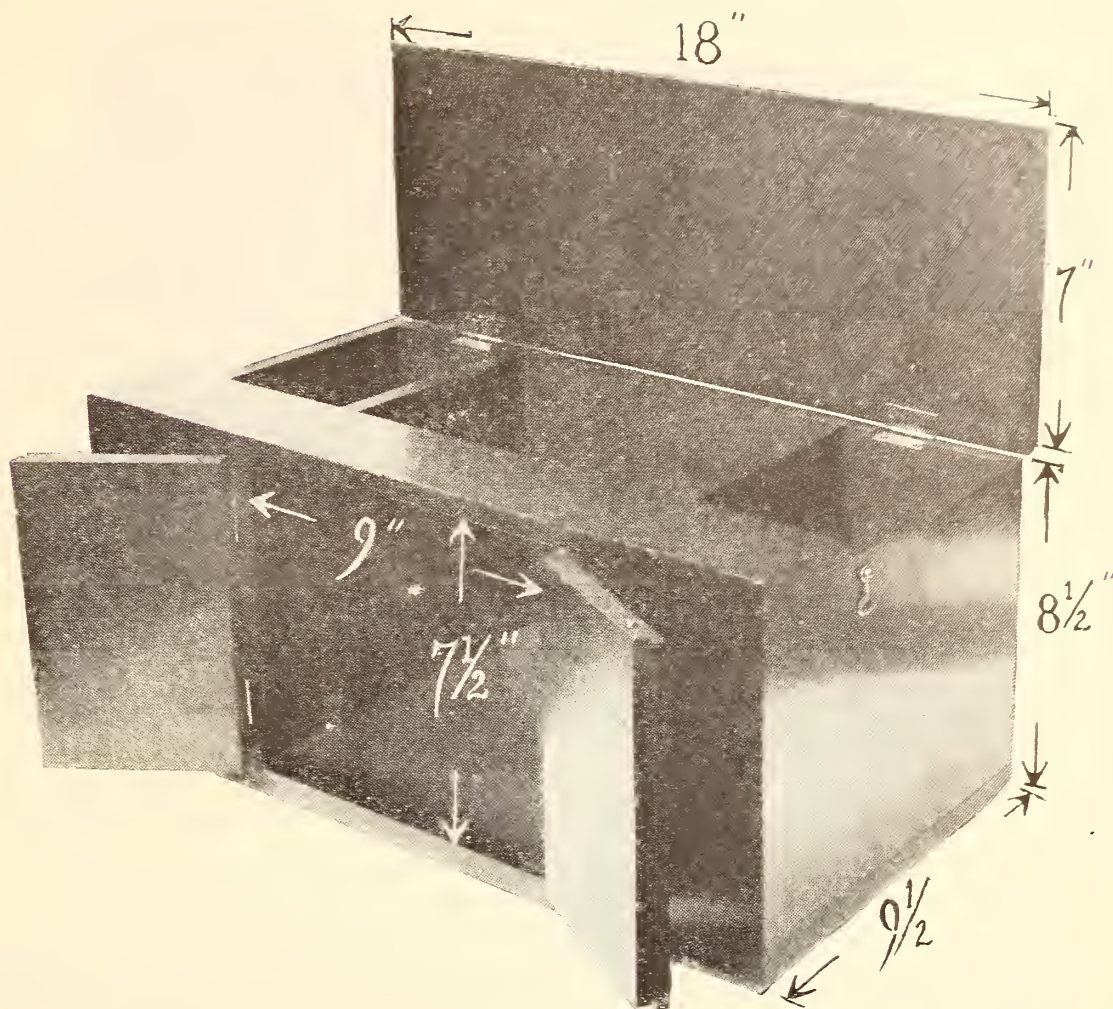

FIG. 4

The receiver slides into the middle compartment, the side sections being provided for the A and B batteries. If the constructor of the set prefers not to make the cabinet, it may be bought for a reasonable sum

form at a point opposite No. 2 and soldered to that terminal.

The entire form may be given a light coat of thin shellac, collodion or airplane "dope," leaving only the terminal heads untouched for soldering. When thoroughly dry the transformer is mounted on its condenser—one method of accomplishing this is shown in Fig. 2. Two holes  $1\frac{1}{2}$ " apart may be drilled and tapped for  $\frac{6}{32}$  thread in the end plate of the variable condenser. Two  $\frac{6}{32}$  machine screws and small brass pillars are used to support the transformer away from the condenser. The arrangement should be similar to the illustration in order to retain short leads.

#### MAKING TRANSFORMER T2

THIS transformer is constructed in a manner similar to T1 with the difference that the primary (top coil) has 35 turns.

Referring to the diagram, Fig. 1, it will be seen that there are five connections to T2; the fifth connection is a center tap on the secondary and should be used only if the receiver is to be operated in the vicinity of an interfering station. Otherwise this tap should *not* be

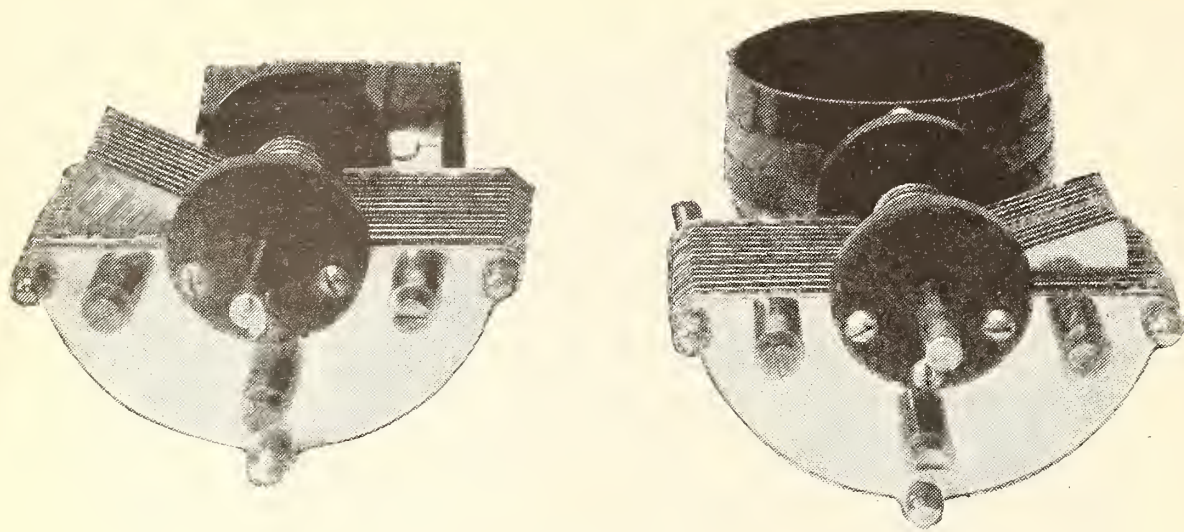

FIG. 5  
The tuning units T2 and T1 (left to right)

provided as it reduces signal strength, although at the same time increasing selectivity because the damping effect of the crystal rectifier is effective over only half the inductance; if a vacuum tube detector were used, the value of this connection would be nil, the grid-filament resistance being so high. Although the volume would be diminished, selectivity would be neither greater nor less.

In most cases the lead from the positive B terminal of the primary of T3 will be connected to terminal No. 4 of T2 rather than to the tap.

Only a very light coat of dope or shellac should be placed on the primary of No. 2 as it is desired to keep the distributed capacity very low.

In mounting, T2 should be placed on its condenser at right angles to that of T1. Fig. 5 shows the correct arrangement which should be followed.

The photographs of the back of the complete receiver (Figs. 2 and 6) indicate that the variable condensers face each other; this is not good practice because the dials must then be of different types, one reading left hand and one right hand. Therefore, in the panel layout, Fig. 7, and in the photograph of T1 and T2 (Fig. 5) corrections have been made so that both condensers are mounted in the same manner and both dials may be of the same type. All stated dimensions have been checked and corrected so that the drawings may be followed with perfect assurance that everything will fit.

These special transformers, both T1 and T2, may be purchased if the constructor wishes to save time and labor. They are priced at about \$6.00 each.

#### THE VACUUM TUBE STRIP

THE vacuum tube socket is "spun" into a sub-panel  $3\frac{1}{2}''$  x  $5''$  x  $\frac{3}{16}''$  on which are located the filament resistance mounting clips, binding posts, audio-frequency transformer and mounting bracket, but single sockets made for panel mounting may be purchased for about \$1.50

and the assembly of the sub-panel will then be up to the ingenuity of the constructor himself. Figs. 10, 11, and 12 will help to show the proper arrangement of parts.

In assembling, care should be taken that the audio-frequency transformer is placed with its grid terminal adjacent to T1; the plate terminal will then be close to T2 so all leads may be made very short.

Four binding posts are located on this sub-panel as indicated in the drawing Fig. 8. This is the correct method in contrast to the photographs which show a receiver with a slightly different wiring system.

Special attention should be given the springs of the tube socket as "dead" tension will in time cause a great deal of difficulty, chiefly characterized by noisy and spasmodic operation.

#### THE FRONT PANEL

THIS should be of Bakelite, Formica, or Radion,  $9''$  long,  $7\frac{1}{2}''$  high and  $\frac{3}{16}''$  to  $\frac{1}{4}''$  thick. Bakelite or Formica should be sanded or grained on both sides, but Radion should retain its original finish. The panel is drilled in accordance with the front panel layout, Fig. 7, but the position of holes may be changed to suit any condensers.

#### ASSEMBLY

AT ABOUT this stage in the manufacture of a home made receiver, the amateur workshop, whether it be a real shop, the kitchen, parlor, or attic has assumed an air of congested indecisiveness that hardly bespeaks the usually tidy habits of the constructor; coils, tools, condensers, dirt, sockets, wire, binding posts, solder, and some more dirt and tools are indiscriminately mixed and thrown

about. When it comes to assembling, some of us do not stop to clean up—we merely shove the cluttered mass to one side and with a clear space of six inches go right ahead.

How much better it would be if we were to stop for a few moments, clear up the dirt, put away unnecessary material, and leave before us only the essential parts for immediate progress. Surely the orderly surroundings would tend to create that orderliness of mind which enables better and more accurate work. Let's try it. We should have before us on an otherwise clear table the following parts:

- 1 T2 transformer unit.
- 1 T1 transformer unit.
- 1 Sub-panel with binding posts, tube socket, A. F. transformer and resistance mounting clip in place.
- 1 Crystal detector.
- 1 Single-circuit automatic filament-control jack.

1 Front panel, drilled and sanded.

Also a screw driver and 8  $\frac{6}{32}$  flat-head machine screws  $\frac{3}{8}$ " long.

The vacuum tube strip is mounted first by threading two screws into the angle bracket (Fig. 9, and at the right in Fig. 10.) The heads should be just flush with the panel. T1 is mounted to the left of the socket strip, T2 to the right (from the front). All screws should be driven with a firm and equal pressure in order to avoid unnecessary strain on the condenser shafts.

The aerial binding post is placed in the upper left-hand corner of the panel—this is arranged so connection is made from the rear, obviating an unsightly lead-in. The crystal detector and jack are mounted last; the frame of the jack should be facing down. As the final step in assembling, the dials are placed upon the condenser shafts and so arranged that the movable plates are all "in" when the indicating

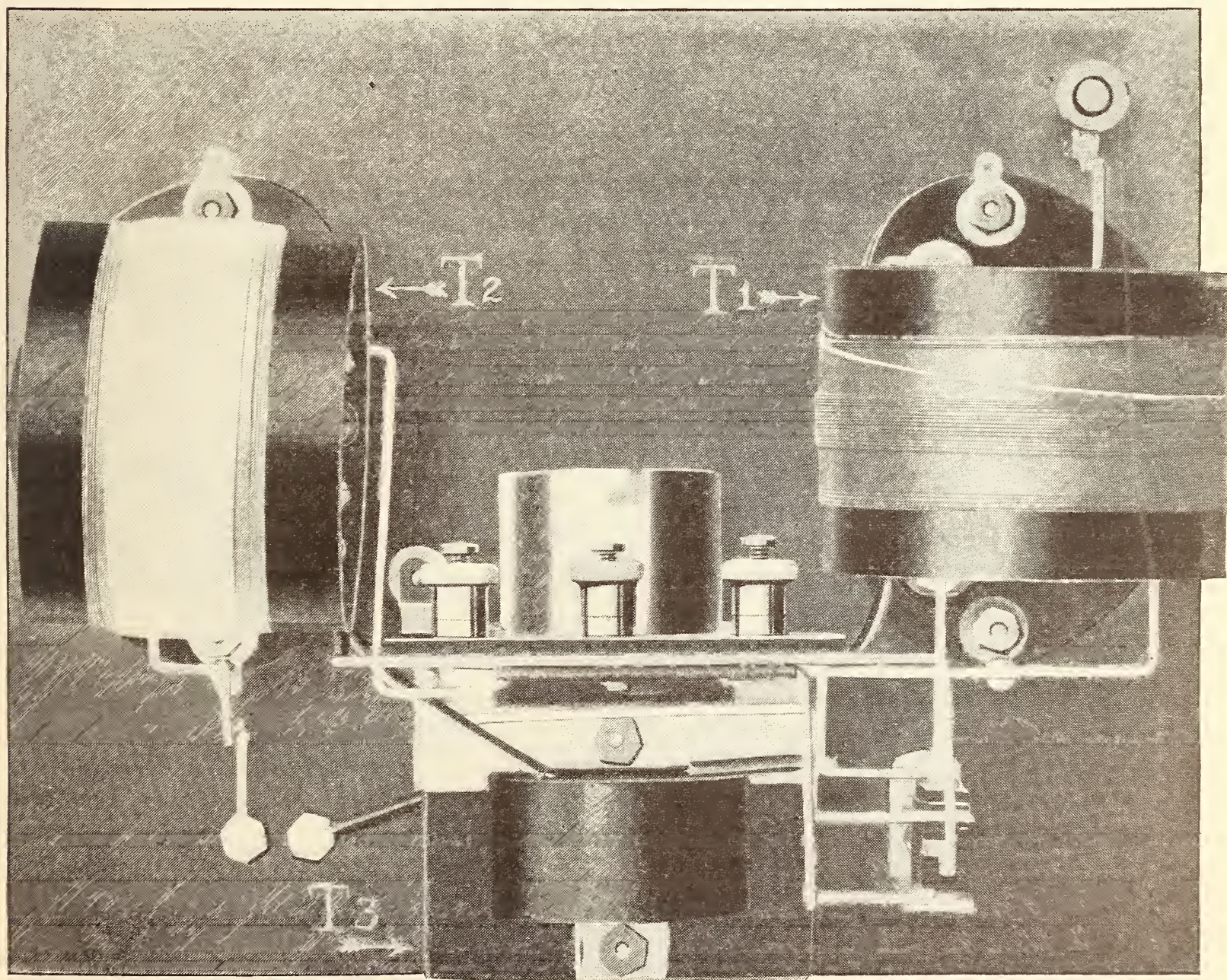

FIG. 6

The receiver as seen from the rear

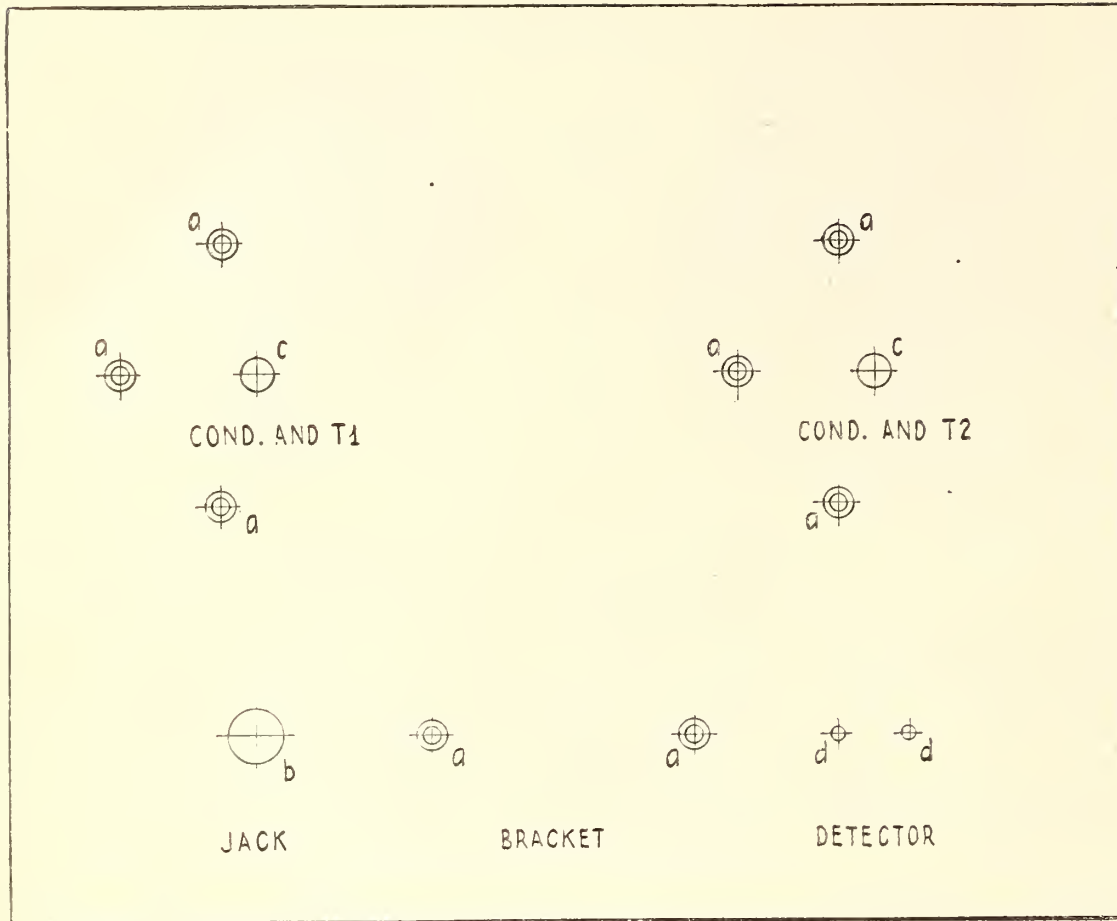

FIG. 7

This plan is  $\frac{1}{3}$  the actual size of the panel. For *a* holes, use No. 27 drill and countersink the holes to fit flat-head screws; for *b*, use No. 27 drill; for *c*, use  $\frac{5}{16}$ " drill; for *d*, use  $\frac{9}{16}$ " drill

mark on the panel is in line with the highest mark on the dial.

#### NOTES ON WIRING

**A** GAIN there is need for a clear space, the proper tools, and, if possible, some experience. As every joint must be soldered, a soldering iron is quite essential. So also is a pair of  $\frac{1}{4}$ " flat nose pliers, a clean rag and bus bar wire. "50-50" bar solder is splendid, and soldering paste may be used if difficulty is experienced with rosin flux, though the excess should be removed with a little alcohol, after the soldering is completed.

Although each of us has his own way of doing things, the generally acknowledged method of wiring may be condensed in the following seven points:

1—Solder all joints. Soldering to a lug and screwing the lug to a terminal does not constitute a soldered joint—the wire should be soldered direct to the terminal.

2—Flow the solder in all joints so they are perfectly smooth when cold. This requires a properly heated and tinned iron with sufficient flux.

3—Do not be too sparing in the use of flux, but immediately after soldering remove all traces of paste—with scrupulous care.

4—Use square tinned bus bar wire wherever possible.

5—Make 90° bends and run stiff connections only vertically and horizontally.

6—Wires more than a few inches in length should be run against the panel or other insulating support—they should not be left unprotected in space.

7—When soldering a wire to a terminal, aim the wire toward the center of the terminal—do not solder it to the side.

Wire the filament circuit first; the positive A battery terminal runs direct to one filament contact while the negative A battery terminal goes through the automatic

filament control jack break and the "Amperite" mounting (R1) to the other filament contact, thus completing this circuit.

The transformers are connected as follows:

T1—No. 1 to the aerial binding post; No. 2 to the negative A battery terminal; No. 3 to the stationary plates of the variable condenser and then to the grid spring of the tube socket; No. 4 to the rotary plates of the variable condenser and to the "G" terminal of the secondary of the audio-frequency transformer, T3.

T2—No. 1 to the plate contact of the tube socket; No. 2 to the positive B battery binding post. No. 3 to the stationary plates of its variable condenser and to either terminal of the crystal detector; No. 4 to the positive B terminal of the primary of T3 and the rotary plates of the condenser.

T3—"F" to negative A battery terminal; P to the other side of crystal detector. Connecting the negative B battery binding post to the long curved spring of the jack completes the circuit and the receiver is finished!

#### RESISTANCE STRIPS FOR DIFFERENT TUBES

**A** MPERITES" or automatic ballast resistances may be purchased in two types; one (PT) for power tubes—that is, tubes drawing 1 ampere; the other (1A) for  $\frac{1}{4}$ -ampere tubes

such as the WD-11, WD-12, all the "C" tubes and UV-201-A. The resistance of both types varies with the current in such a manner that slight fluctuations above and below the normal battery voltage do not produce a corresponding change in filament current. This property of varying resistance is the chief asset and, strange to say, the greatest drawback of this type of ballast resistance. For, when a battery is applied to a circuit containing a fixed resistance (such as the filament of a vacuum tube) and a varying resistance such as an "Amperite" the initial current is governed solely by the sum of the value of the fixed resistance and the Amperite—when "cold." And, unfortunately, the resistance of an Amperite is much lower when "cold" than when heated by passage of current—therefore the initial current is in excess of the proper value and is quite harmful to the filament of a tube.

For this reason and also because ballast resistances are not made for all types of tubes we have for some time been using fixed wire resistance strips which may be slipped into the regular mounting. They are easily made, and

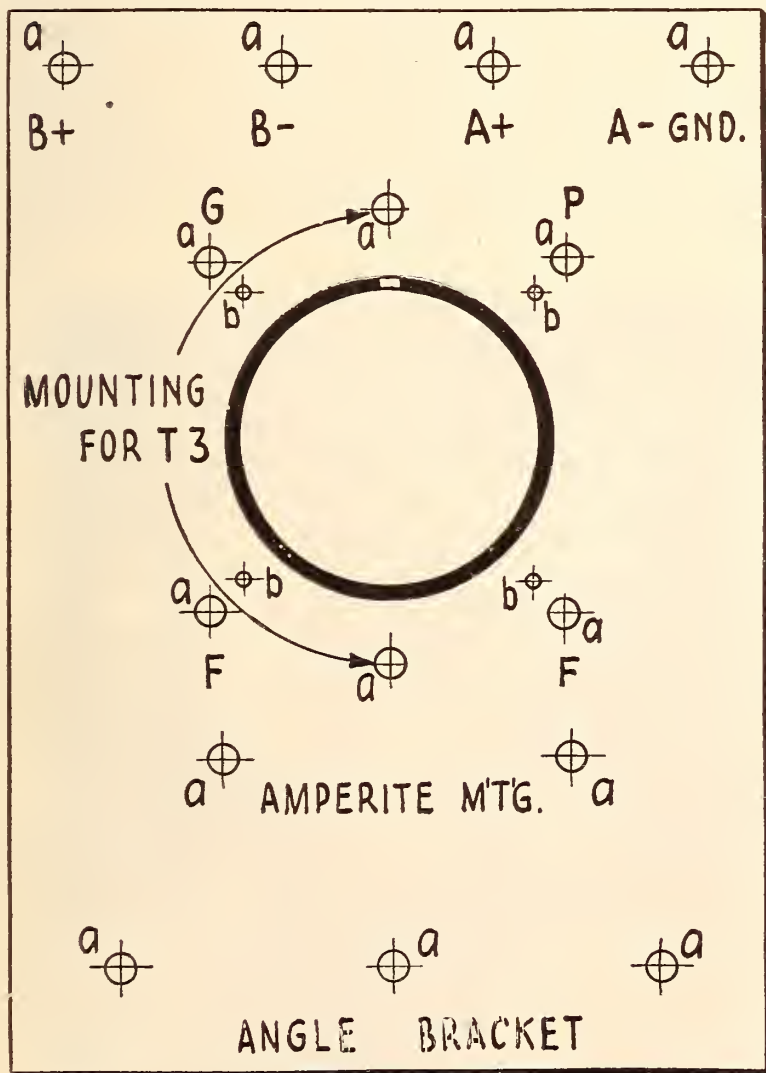

FIG. 8

Plan for the sub-panel. This is in correct proportion, but less than actual size ( $\frac{11}{16}$ ). For *a* holes, use No. 27 drill; for *b* holes, use No. 52 drill

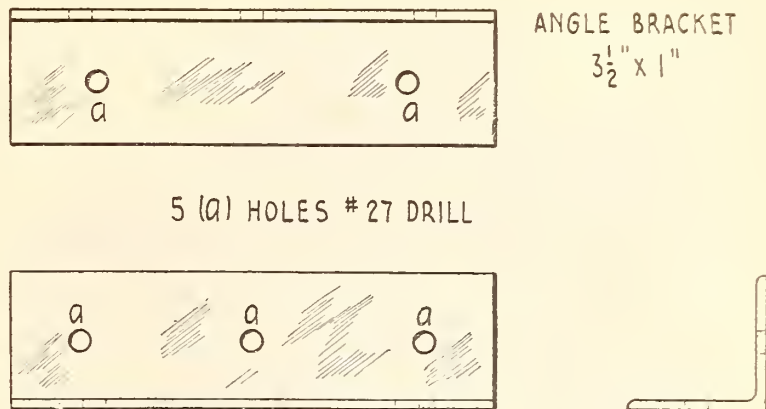

FIG. 9

This is the bracket (half actual size) that fastens the sub-panel to the main panel

with the proper length and size wire may have any value of resistance.

The first few were made from portions of the resistance element of a regular 6-ohm rheostat. Each portion was 2" in length and utilized the resistance wire salvaged from the rheostats.

A much neater job can be made however if  $\frac{3}{8}$ " insulating rod cut into 2" strips is fitted with two metal end pieces and wound with the resistance wire, both ends of which are soldered to the end pieces. The rod should be threaded so the wire will not slip and short circuit adjacent turns. Small thumb tacks or similar devices have been employed as connecting end terminals.

It is necessary to know or determine the resistance per unit length of wire in order that the proper amount may be employed to offer the correct resistance.

The following table shows the value of resistance for use with different A battery potentials on various tubes in order to restrict the current to a point slightly below the normal consumption rate.

TUBE	BATT. VOLTAGE	RESISTANCE	CURRENT
	(Representing 1, 2, and 3 storage cells and 1, 2, 3, and 4 dry cells.)		
UV-201-A	6.0	6.0	.23
UV-201-A	4.5	0.*	.22
UV-201-A	4.0	0.*	.20
WD-12	1.5	2.0	.23
WD-12	2.0	4.1	.23
UV-199	3.0	0.*	.06
UV-199	4.0	18.0	.06
UV-199	4.5	30.0	.06
UV-199	6.0	55.0	.06
UV-201	6.0	1.5	.92

\*Direct short. May be made like other resistance strips, but has only a copper wire joining the end terminals.

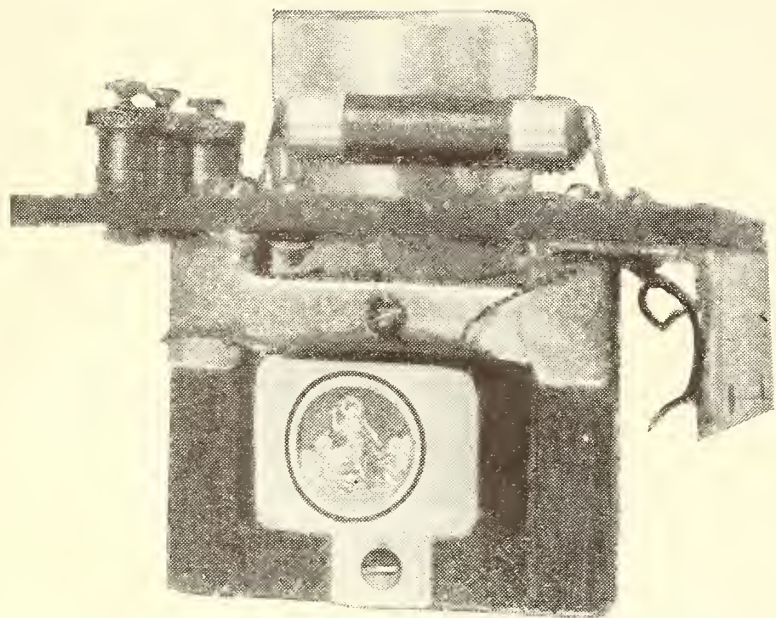

FIG. 10  
The sub-base from the left

Having selected a type of tube and the A battery voltage, reference to the table will enable selection of the proper resistance strip. Thus, if a UV-199 with 4.5 volts "A" are chosen, a strip of 30 ohms should be inserted in the sub-panel clips; a WD-11, WD-12, or W. E. "N" tube with a single dry cell will require a 2-ohm resistance, and so on.

Choice of tubes and batteries rests with the constructor; personally we prefer a UV-201-A with 4 series dry cells or a 6-volt storage battery. However, the UV-199 with 3 series dry cells very nearly equals the UV-201-A and is much more practical for dry cell operation. The WD-11, WD-12 and W.E. "N" tubes are of the single dry cell type; they operate quite well but it has been our experience that they come through very irregularly—some being good and others quite the opposite. The B battery voltage may vary from 45 to 90 although with this receiver as much as 300 volts has been applied to the plate of a UV-201-A; the resultant volume being comparable to the output of a single-tube super-regenerative receiver.

#### THE CABINET

THIS may be readily constructed at home if one is at all handy with wood working tools. Otherwise, it should be purchased.

The left-hand battery compartment is for the filament heating source, and the right-hand compartment for the plate battery. Sufficient room is allowed to accommodate medium size B batteries and full size A dry cells without crowding.

The panel is set back in its compartment 2"

and is held in place with four flat head  $\frac{3}{4}$ " wood screws driven into corner blocks  $\frac{3}{4}$ " square and 2" long.

Finish is optional, but a dull gloss seems to be popular.

#### THE AERIAL

PARTICULAR care should be taken in the design of the aerial as, for best results, the resistance should be low. We advise a single-wire aerial, 100' to 150' in length, at least 20' above surrounding objects. The lead-in may be a continuation of the aerial wire and should be brought away at right angles to the horizontal portion. Glazed porcelain insulators are doubtless best for a small receiving system and should be used at all points of suspension.

In the event that an aerial cannot conveniently be employed, reception may be effected with a ground connection alone. This usually will give equal if not better results than a small aerial. The ground should be connected to the aerial terminal and the receiver tuned in the usual manner. Several grounds should be tried—the best type appears to be one in which a rather long lead runs to a distant ground; this is, in effect, a grounded aerial with the receiver connected to the free end. The lighting system may be employed in a similar manner through use of an "antenna

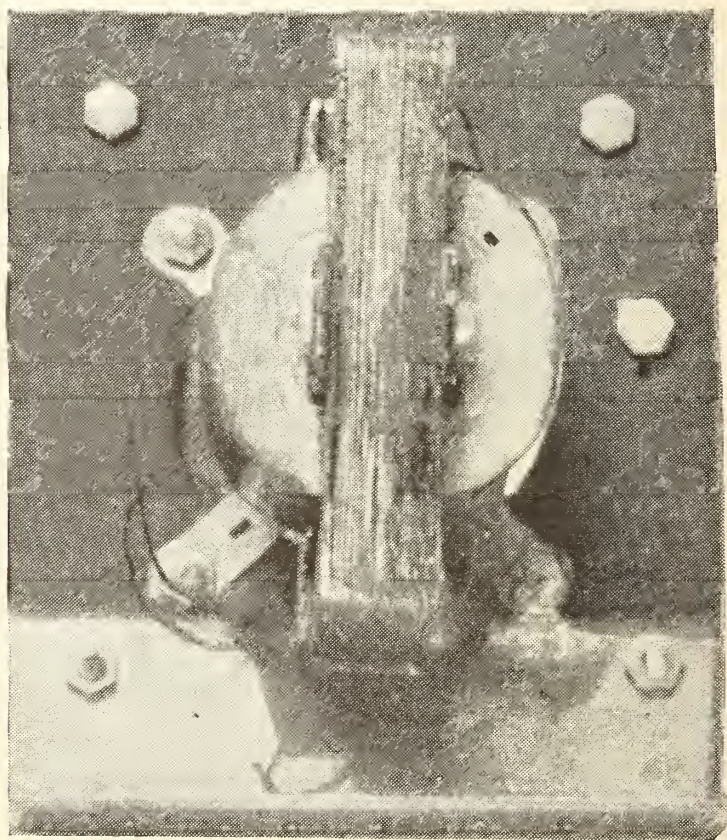

FIG. 11  
The sub-base from below



attachment"—if results are satisfactory the more or less cumbersome aerial may be dispensed with.

#### INSTALLATION

(A) Connect both A and B batteries to their respective binding posts—care being taken to have the polarity correct. Use number 18 or heavier rubber-covered stranded wire and keep all leads short and direct.

(B) Insert the vacuum tube and Amperite in their sockets and ascertain that positive contact is assured; it would be well to bend up the socket springs slightly in order that they may exert considerable force upon the vacuum tube pins.

(C) Connect a suitable ground to the negative A binding post and an aerial such as described above to the aerial binding post.

#### OPERATION

(A) Place the output plug in the jack; the vacuum tube should light instantly.

(B) Set both dials to the same point and adjust the crystal detector until a fairly strong "click" is heard.

(C) Slowly vary both dials between maximum and minimum position, maintaining them in approximately equal relation to each other.

(D) When a station is heard, turn the grid variable condenser and center it for stronger response, following this by adjusting the detector for better results.

(E) Further manipulation of the crystal for the most "sensitive" adjustment will improve both the quantity and quality of reception.

(F) With an average antenna, both dials will nearly coincide for any wavelength. No difficulty will be experienced in tuning both circuits to the same resonant frequency, as clicks (from crystal adjustment) are heard only when the grid and detector circuits are in tune with each other; being loudest when the circuits are exactly in resonance.

(G) When the crystal contact is "off," the receiver may oscillate, especially if headphones are used while tuning. There are a few methods of stopping this but as it is rarely annoying special precautions are not necessary.

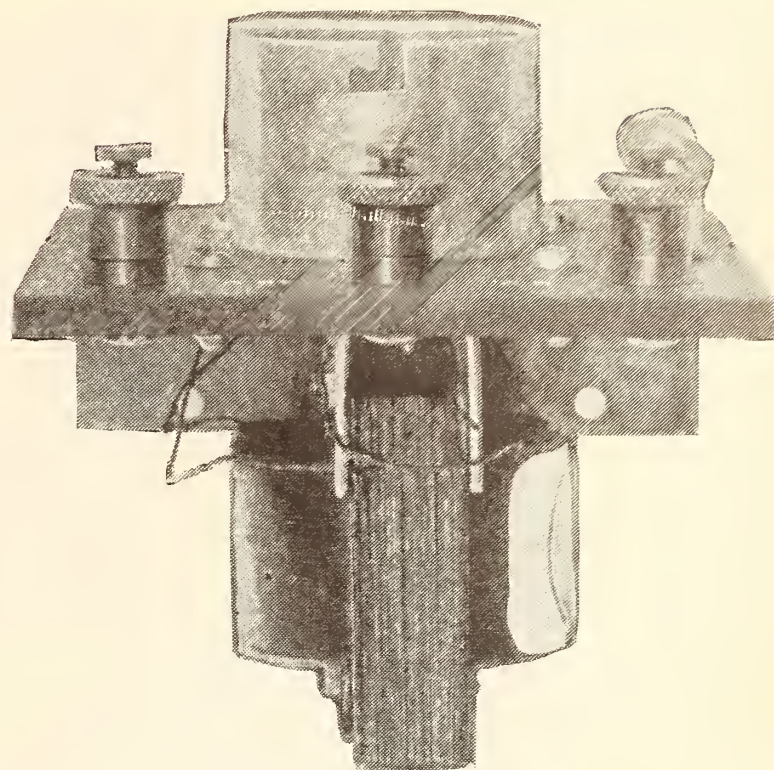

FIG. 12

The sub-base from the rear

(H) On strong signals, the condenser in the crystal detector circuit is not very critical, but it has a well defined maximum resonant peak which may be passed over if this control is varied too rapidly.

(I) It is the *combination* of controls that makes for selectivity, and both are quite critical on weak stations.

(J) The crystal adjustment is important not only for strength and clarity of signals but also for selectivity.

(K) On a stiff piece of manila paper provide three columns to record:

(1) Stations call letters, (2) T<sub>1</sub> dial settings and (3) T<sub>2</sub> dial settings. This record may be permanently placed on the inside of the cover (under transparent celluloid, for example) and referred to when the program of a certain station is to be tuned in.

#### CARE AND UPKEEP

THE filament and plate batteries should be kept at the proper voltage and B batteries which show a drop of more than 25 per cent. should be discarded.

Inspect all connections occasionally and clean wiping contacts, such as in the vacuum tube socket, in order that there will be no loss due to contact resistance.

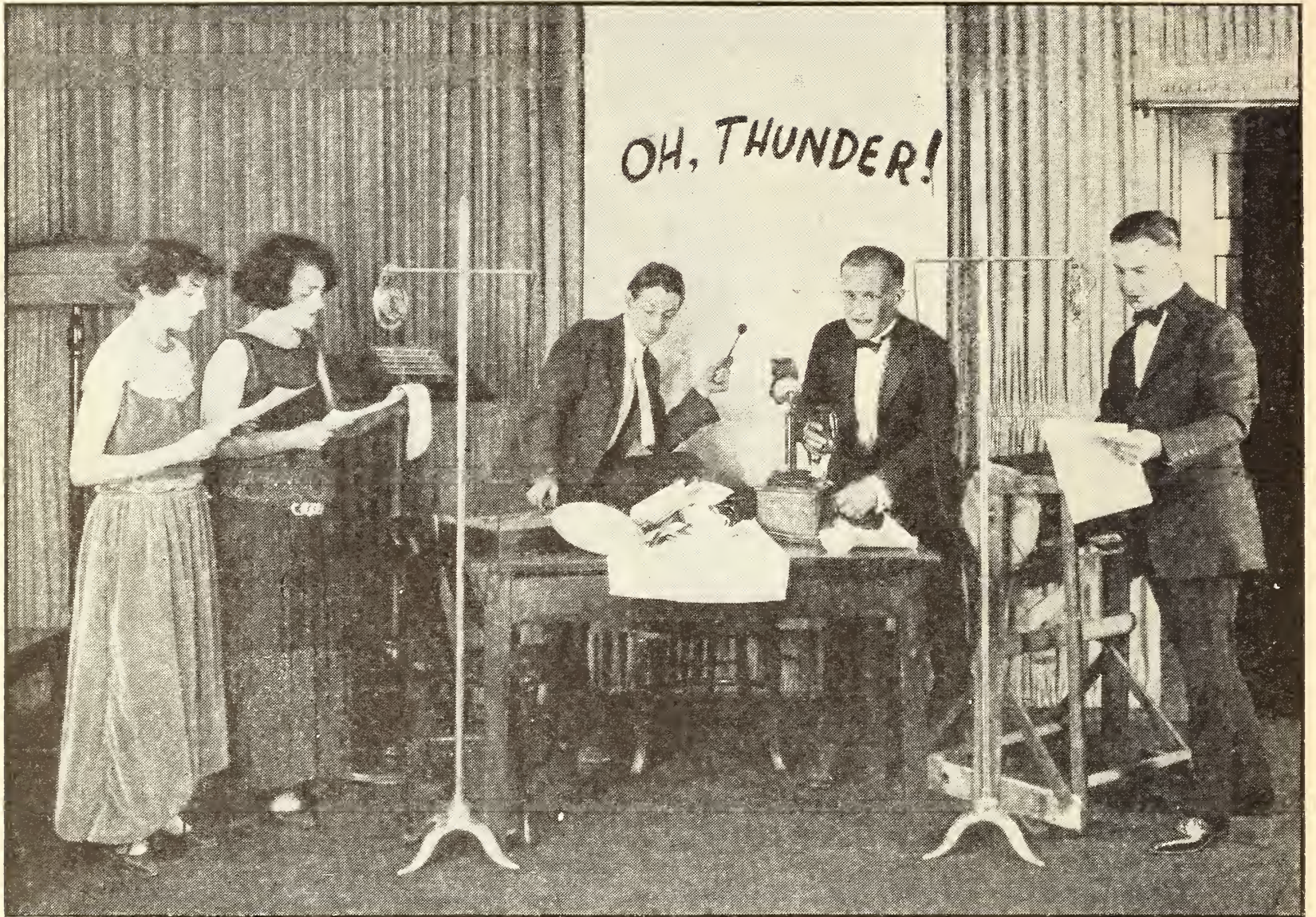

#### WHAT KIND OF NOISE ANNOYS AN OYSTER?

This battery of noise-making devices looks as if it might annoy anybody, but the volume and quality of the sound is arranged so as to seem like the real thing to radio listeners. The players are, from left to right: Lola Sommers, Rose Cohn, Frank Oliver, Edward St. Louis, and Edward Smith. Between Miss Cohn and Mr. Oliver, on a stand, is the bell effect. Mr. Oliver is making it rain cats and dogs with his right hand, and producing the world's most terrifying thunder (on the "thunder-sheet" in background) with his left hand. On the table are dishes for what is picturesquely called "smash effects." Mr. St. Louis is busy with the telephone effect, and Mr. Smith is coaxing the windstorm machine to the limit.

## Tricks Used in Staging Invisible Shows

How WGY Puts Across Scenes Without Scenery, Making Many a Home a Theatre. Queer Noise-Producing Devices that Help to Make the Drama Realistic to the Listener-In

By C. H. HUNTLEY

General Electric Company

**T**HE radio audience is, in effect, an audience of the blind. It is evident that if plays are to be presented by radio, the producer must keep constantly in mind that the appeal to the imagination can be made only through the sense of hearing. Merely putting it in touch with the stage of a theatre, therefore, is not enough.

Until about a year ago, such attempts as had been made to broadcast plays were not particularly successful. Individual scenes from plays had been given occasionally, and "The Perfect Fool" and "Lightning" had been put on the air from the theatre in Chicago where they were presented. (That is to say, microphones were placed on or near the stage and the per-

formances were heard just as given.) But the interludes were tiresome to the radio listeners; and the stage "business," visible to those in the theatre, was utterly lost on those who followed the play by radio.

Edward H. Smith, an actor of professional experience, conceived the idea of adapting a play to meet the specific needs of play broadcasting and to solve the problems it presented. He suggested this to Kolin Hager, studio director of WGY, the General Electric Company's station at Schenectady. The idea appealed to Mr. Hager, who stipulated, however, that the play must not take more than forty minutes, as it was to be only one of several features of the program, and the interest of the radio public in such an effort was problematical.

The play chosen was "The Wolf," by Eugene Walter. In cutting down the three-act drama to a play of forty minutes, the second act was taken as the basis, with parts of the first and third acts blended in. A special finale was written. Mr. Walter had insisted that the play be given with a complete cast, and the actors who had had actual stage experience were selected for it. Viola Karwowska played the part of "Hilda"; Frank Finch was "Jules Beaubien"; James S. B. Mullarkey was "Andrew Mac Tavish"; Henry Miller was "Huntley"; and Mr. Smith doubled as "MacDonald" and "Ba'tiste Le Grand." Three of these



MARIE HODGEKINS

A guest artist at WGY, who made a hit in the play, "Under Cover." It is a pity that the radio audience could not see her as well as hear her

actors had previously appeared in the stage presentation of this play.

After several careful rehearsals, conducted as though on a real stage, the play was given. Then came the response, in the form of two thousand letters from appreciative listeners scattered throughout a territory within five hundred miles of WGY, expressing their thanks and approval. The section covered would doubtless have been greater had the play been given later in the season when the static was not such a handicap. Nevertheless, the screams of "Hilda" were so

realistic in Pittsfield, Mass., as they issued from a loud speaker there, that a policeman patrolling his beat hastened to the house from which the sounds came to find out who was being "battered and assaulted."

This first presentation gave the actors some valuable experience. It taught them that the greater the volume of sound, the farther back from the microphone they had to be. As the play neared the end, the din increased to such an extent that the operators of the station tried to soften it by decreasing the amount of power used. The result was that the close of the play was almost inaudible to some listeners. From then on, as an actor raised his voice, he retired farther and farther from the microphone.

So pronounced was the success of this first presentation that it was decided to make plays



EDWARD H. SMITH (Left)

Director of the WGY Players since September, 1922. He has been Director of The Masque, of Troy, N. Y., and did production work with "When Knighthood was in Flower"

FRANK OLIVER (Right)

Since the age of 9 he has been on the stage, principally in Dublin and Glasgow. In the United States, he appeared first in "Treasure Island." He was a pioneer in Biograph motion pictures under D. W. Griffith, and director and scenic artist of the Newark Theatre Guild. In this last connection, he proved himself a painter of no mean ability





AS IT'S DONE ON THE LEGITIMATE STAGE—

An eating scene, staged by Miss Rose Cohn (seated), Miss Lola Sommers (standing), Frank Oliver (standing), and Edward H. Smith (seated)

a regular feature of the WGY program, and to retain the group of actors who had given the initial performance. It was still considered necessary, however, to have plays brought within a forty-minute compass, made up of four episodes of ten minutes each. This time limit imposed considerable difficulty in some cases. For example, it took six weeks to reduce "The Garden of Allah," which consists of ten scenes and takes two hours for presentation on the stage, to the required length. After eight plays had been given, the popularity of drama by radio was plainly so great that the time limit was removed.

Beginning with "The Garden of Allah," the presentation of a play became a part of the WGY program each week, and the WGY Players became a definite organization. In all, forty-three plays, both dramas and come-

dies, had been given up to the close of June, when the regular players gave way, through the summer, to understudies. They have resumed their work this fall.

As showing the appeal this form of entertainment has made to the public, it is interesting to note that "The Sign of the Cross," Wilson Barret's well-known play, which was given by the WGY Players during Christmas Week, brought 1,500 letters in one day, while the total number received in four days was approximately 6,000. Late in July letters of commendation on the presentation of "The Green Goddess," which was presented on March 8, and which in some ways was the most successful of the plays given, were still being received.

The average theatre-goer has at least some conception of the back-stage apparatus used to help produce illusions—the devices for simu-

lating thunder, the roar of an approaching train, the sound of horses' hoofs, and so on. Probably few of the listeners to drama by radio have given much thought as to how the same effects are produced in broadcasting, where they are relatively much more essential because the success of the presentation depends on the appeal to the ear alone. How important the visual factor in dramatic entertainment is, is clear from the popularity of the "movies."

What seem like odd expedients have become commonplace to the WGY Players. One of the most difficult propositions of this kind was met in preparing for the broadcasting of "The Storm." In this play, a forest fire culminates in the crashing of a burning log through the roof of a cabin. To provide the roar of the conflagration, it was at first planned to build a

fire in the rear of the building containing the studio and bring microphones sufficiently near to catch the sound, but on experimenting, it was found unsatisfactory. Gasoline torches were therefore temporarily installed in an adjoining room and provided a very efficient substitute. The crackling of ignited twigs was simulated by crumpling brittle paper in front of the microphone, and to produce the sound of falling limbs, a heavy table was thumped on the studio floor. The final scene, with the collapse of the roof under the impact of the falling log, was made real to the audience by the simple expedient of having one of the actors jump from a table on to a packing case and crashing in the top. It required four men to work these various effects. The result was that, while not a word had been spoken to indicate what was happening, the illusion of a forest fire was per-

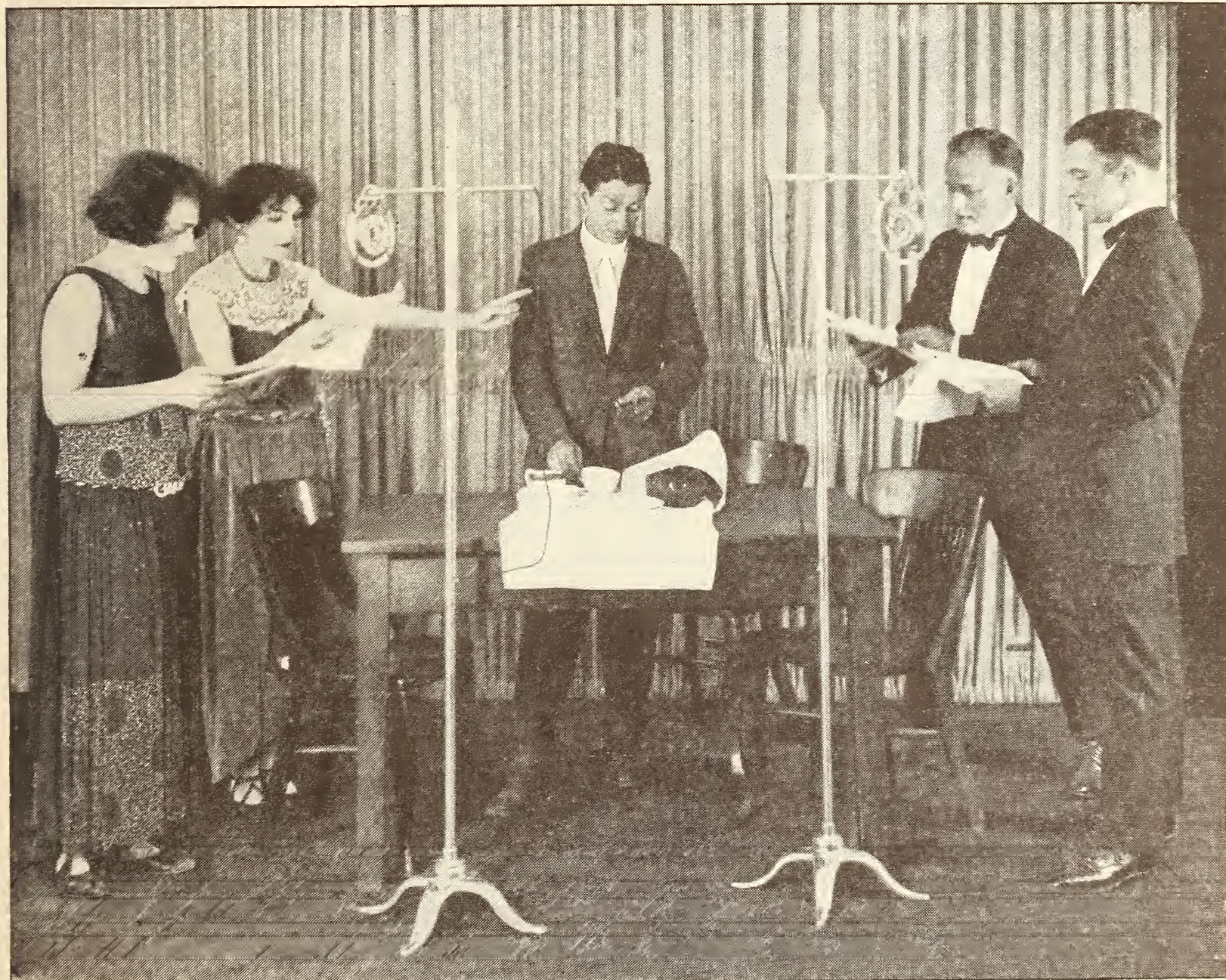

—AND AS IT'S DONE FOR THE RADIO AUDIENCE

The cast is arranged in the same order from left to right as in the picture on the opposite page, with the addition of Edward E. St. Louis (fourth from the left). Mr. St. Louis follows the entire play, the others having individual parts. Mr. Oliver is serving as property man, his job being to produce the rattle of the dishes, silver, etc. necessary to create atmosphere. His part is on the table before him

fect. A man in Nevada wrote that when the tree crashed through the roof, he ducked!

Holding a folded newspaper against the edge of a moving electric fan makes a well-nigh perfect imitation of the droning whirr of an airplane; the rattle of dishes and silver at once conveys the idea of dining; the clink of coins suggests the giving of a tip, and an empty bottle in a pitcher of water at once conjures up visions of ice water. And at the risk of killing the romance for some who have been thrilled by radio dramas, it may be admitted that in the love scenes, the hero plants a kiss not on the lips of the heroine, but on the back of his own hand. Indeed, the hero and the fair lady are often at opposite ends of the room.

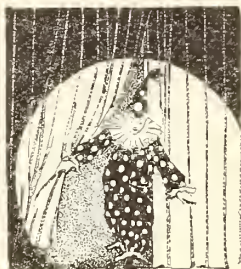

Infinite attention is given this matter of sound. If one of the actors is supposed to be talking while eating, he actually eats a sandwich. Wireless telegraph messages are real messages, sent by a bona fide operator by use of a spark set installed for the purpose. The clicking of a telegraph which the audience hears is that of a real sounder operated in the studio. Regulation thunder-making and other devices familiar to the stage are employed, and entrances and exits are marked by the banging of doors.

The members of the cast do not, of course, appear in costume. They read their parts from manuscript, which is typewritten on paper especially selected for its freedom from crackling sound when the leaves are turned, and each actor is furnished with a complete copy.

Reading the parts instead of committing them to memory obviates any danger of forgetting, and makes the presentation smoother than it could possibly be otherwise. Each play is, however, very carefully rehearsed before it is given. In the case of "Madame X," there were four general rehearsals and numerous others for individual players as well. The care that is exercised is evident from the fact that during rehearsals, the players' director, Mr. Smith, is in another room from the rest of the cast when he is not acting a rôle, and hears the play through a receiving set just as it would sound to the great audience. He issues his directions through a loud speaker.

Two microphones are used in transmission, one for men and one for women, this being necessitated by the difference in the quality of

their voices. Voice quality is of the utmost importance in this work. According to Mr. Smith, the ideal voice for the purpose is of low rather than high pitch. The enunciation must be very clear, and *naturally* clear, as any stilted attempt at precision tends to spoil the effect. The value of pause is something that must be learned. The careful actor in this work shades the pauses to almost a fraction of a second. The volume is usually confined to that of an ordinary conversation. If the scene calls for more, the actor steps back from the microphone.

Nervousness, of course, tends to raise the pitch of the voice, but nervousness is not a factor among the WGY Players. Stage fright, even among the amateurs who sometimes take minor parts to complete a cast, has not been noticeable. The whole atmosphere of the studio when a play is being given is one of congeniality, and a performance takes on, so far as the actors are concerned, something of the nature of a rehearsal, inasmuch as no audience is visible. The realization that thousands are listening does, however, spur the players to their best efforts.

That illusion and atmosphere may be created by sound alone, the presentation of plays by radio has definitely established.

In a letter received at the studio following the presentation of "The Green Goddess," a listener wrote: "I want to add my appreciation of 'The Green Goddess' broadcasted last week. It was superb. Maybe I enjoyed it more because I am familiar with the 'Hill Station' region of the Himalayas. You got the local color splendidly. The palace and social life of the Rajah were very vivid. The English 'resident' was perfect, as were also the Major and his wife. The Doctor was just the kind that appeals to all of us."

The radio drama has an advantage over the movie drama in that it is carried right into the home, whether it be an isolated farm-house or a city apartment. Thus, it is available to those who are unable to go out for their entertainment. It creates a stage in every home equipped with receiving apparatus.

Judging from the favor with which it has been received and the progress it has made in a single year, the radio drama will rapidly develop into a recognized branch of the dramatic art.

# A Woman Who Makes Receiving Sets

How Mrs. Florence Bethman Became Interested in Radio, Makes Sets for Herself and Others, and Finds Benefit and Joy in Her Work

By ALFRED M. CADDELL

**Y**OU have probably heard of the woman who shod her own horse and fixed her own buggy wheel; and the woman who, when she busted her blunderbuss over the head of an Indian, carved out a new stock and fastened it to the barrel. Also, you have probably heard of women making fancy jewel settings, fixing clocks and doing other things in the mechanical line. But come with me to an attractive little apartment in Brooklyn and meet a woman who not only builds her own receiving sets but has built thirty-six others besides—crystal sets, tube sets, and combination sets of her own design. Not only does she build them—she installs them, doing every bit of the work from making the panels to stringing the aerials. At home she fastens a pair of head phones to the Victrola so that she may tune in a good station and then go about her household duties of making good bread and pie.

Realizing the value and interest that radio holds for women I journeyed to Brooklyn to get a few ideas from this most interesting woman. And I obtained them—more than I bargained for. You know yourself when a woman applies herself to any task and makes a hobby out of it, that hobby is going to be done up in first class shape. You know that when a woman sets out to get a thing, whether it is a trimming for her hat or a knowledge of the way to do something, she is going to get it, and small items like engineering curves and technical jargon serve only to cultivate the impulse rather than to cause dismay. And so it was with Mrs. Florence Bethman—she was determined to bring radio receiving down to earth, subdue the much-talked-about wonder and make it her own. As she put it, herself: "Just because the electron tube eliminates nearly half the radio impulses is no reason why the technicalities of radio should eliminate one-half the people who are interested in it—not when that half happens to be the women!"

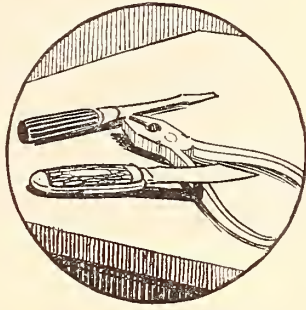

One evening almost a year ago, Mrs. Bethman's husband sauntered into a radio shop like a stranger entering the Hall of Fame. He was on the unfamiliar trail of a radio set. He bought some parts and he took them home—with a complete book of instructions. Mount the panel this way, hook up the A battery to the +A and =A posts, the ground wire to the ground post, and so on.

Fine—he would get at it the following evening. Morning came. He went to work. Evening came, and he hurried home to build the set. But something had been going on at home all day—and supper was a little late. On the gas stove was a soldering iron, while screw-drivers, pliers and "spaghetti" also greeted his eye. Moreover the book of instructions looked as if it had seen a season's wear. What had gone on? Smilingly, his wife from the living room beckoned him: "Come here!"

"The first thing I heard," said Mr. Bethman, reminiscently, "was the good old song, 'Swanee River' coming over as plain as day. I could hardly believe it. I had always considered putting together a tube set a little difficult—and it would have been for me. But my wife got impatient and——"

"No, I was very patient," interposed Mrs. Bethman. "I had to be. It took me more than six hours to get the thing working right, and I had to make a trip to the radio shop at that. Fortunately, the man we dealt with knew something about radio and took the time to advise me right. He had a set completely mounted in his store, and pointed everything out, part for part, wire for wire, on his diagram. That helped me a whole lot, and the visualization of his set did the rest. In fact, practically everything I have learned has been through the sense of visualizing, taking a mental photograph of the hook-up of a set, getting the dimensions and constructing things accordingly."

"Even so," I reflected, "visualization or looking at a thing doesn't build one. You must



MRS. BETHMAN ASSEMBLING A THREE-TUBE RECEIVER

One corner of a room serves as her "shop." While she is putting one set together, music is often coming in from another set, reproduced with the help of the phonograph horn

have had some knowledge and mechanical skill to build it right. And then there's electricity, the understanding of tuning, wavelengths, grid voltage, resistance and the like."

Unwittingly, I was demanding an accounting—which I obtained very quickly, and satisfyingly.

"My mother had the burden of home mechanics on her shoulders," said Mrs. Bethman. "Father was a shoe manufacturer and strictly a business man. But mother had the ability to reason a mechanical thing out and I think I inherited that faculty from her.

"After graduating from business school, I became an investigator for a sewing machine concern, visiting homes of women who had purchased machines on time, and seeing that they were paid for. In making calls at various homes, women would ask me if I couldn't adjust such and such a thing to make the machine work better. I found that I could and it wasn't long before I knew the whole ins and

outs of a sewing machine. Then when I married and went to housekeeping, numerous odd jobs cropped up as the days went along, and I found it a pleasure to attend to them. A new shelf was needed, an extension light over the bed so I could read; the carpet-sweeper rollers became loose, the key broke in the lock or something stopped the clock. Then the vacuum-cleaner contacts became loose and the insulation wore off. Really, I think most of the things happened on purpose just to keep me fixing them up. But I enjoyed it, and I became extremely confident that I could do almost anything along the mechanical line.

"Of course, you're interested in things about radio. Radio is a simple though marvelous proposition to me. I like it. I like to think of it as a superior sort of art. It brings home (what everyone knows) the

fact that there is something more to this world than our five senses can respond to.

And the science of radio holds a peculiar fascination for me; a wonderful education is concealed in it. It has taught me something about music that makes me think of music in its true light. Music is harmonious vibrations, not simply a combination of tones. Music is vibrations in air while electrical or radio impulses are vibrations in a much finer substance or realm. And to think that human beings have learned how to join sound vibrations with electrical vibrations and convey music and speech electrically—that is a wonderful thing to me.

"I think of radio as simply the rules of the game—how to do it. I picture a voice-patterned electrical wave coming through the ether at the speed of light. Now if I am going to hear it, all I have to do is provide a set according to the rules, and enjoy it.

"But I have found that it pays to experiment.



Experiment and experiment and you will strike a hook-up or arrangement that will have all standard combinations beat—you will bring in the broadcasting clearer and do it with less local battery power. And at the same time you will eliminate much of the static and other noise.

"It takes experimenting to tune in sensitively and get rid of the static. For instance, when I first hooked up a Haynes circuit, every time the elevated train would go by a block or two away, I would get nothing but noise. I had the aerial strung in the specified way with one fixed condenser and a condenser for the phones. I reasoned that this condition must be due to the radiation of electromagnetic or induction waves.

"So I concluded to change things around and make my ground an aerial and my aerial the ground. The water-pipe system of this apartment house was the ground but it is now my very efficient aerial. You could hardly credit the difference in receiving that this change brought about. I account for it in this way: the aerial, being more exposed to the static field proved a better circuit connection when used as a ground than when it was called upon to intercept the radio-frequency waves, while on the other hand the cold water pipe system, surrounded by the steel frame of the apartment house, was less sensitive to static. Of course, I might have it figured out wrong, but I think a good ground is more important than a good aerial and the aerial proved a good ground—at least for static.

"Again, I found that adding two condensers where one was specified improved the quality of reception. And I also found that two B batteries on the plate gave better amplification. I use only the one tube and get Chicago in the winter with ear phones. Listen to that coming in now."

While Mrs. Bethman was talking, WEAf was flooding the room with song. Not through an ordinary loud speaker—but through the Victrola, if you please. Mrs. Bethman had clamped a pair of head phones to the phonograph arm that extends out over the record, after having removed the reproducer, and radio music was pouring forth through the tone chamber. As clear as a bell, too—she had the set tuned "razor edge."



"I have also used the gas stove as an aerial and strung wires all around the apartment," she resumed, "and would like to try running a copper cable in a water pipe to see if greater sensitivity could be had. But besides looking for sensitivity in the aerial and ground I find that a good deal depends on the wiring of the set, particularly when it comes to tight connections, insulation and soldering. Soldering is one of the secrets of success. So many

people think that when they drop a lump of solder over a connection and make it stick, they have made a good joint. Nothing is more erroneous. The copper wires should be made as hot as the solder and care taken to see that the solder runs all the way through the space of the connection, so that it is really fused with the copper. When one thinks of the sensitivity required to bring in a radio signal, this point will at once become obvious. I have found it so through experience."

"How long does it take you to put a set together complete?" the writer asked.

"With this set, two hours, because it is arranged logically and simply. But I have worked from four to five hours with other sets all depending on the circuit connections and whether or not there are one or more steps of amplification. Most of my experience however has been with my own type of set—so far I have built thirty-six of them for my friends. I enjoyed the work more than I can tell. The feeling of pride that comes with accomplishment is as good as medicine to me. I remember undertaking to build a set for a friend. It was a little out of the ordinary, with a super-regenerative wiring circuit. I had been stricken ill with influenza, but the moment the parts were brought into the house I could not tolerate staying in bed—I must get up and assemble them. And the result was that I speedily forgot that I was sick—I never got over anything quite as quickly in all my life."

"Judging from your experience in building sets, possibly you may have a suggestion or two to offer as to improvement in design."

"For one thing, I should think an improvement in the phones and loud speakers is something that cannot come too soon. I think combination phones with different resistances and different sizes and kinds of diaphragms might help in bringing in various tones that

cannot otherwise be heard. Of course, such a combination would have to be supplemented with a tone mixer in order to produce the best possible harmony. This of course is theoretical in my mind, but if I had the means of experimenting in this field I'd certainly find pleasure and possibly profit in doing so."

Mrs. Bethman opened a bureau drawer to get a screwdriver, and behold! the whole drawer was full of tools, radio accessories, wire and assembled coils and parts. One odd-looking device was especially noticeable. The writer never saw it in any mechanic's kit of tools. It was a rod standing in an upright base, and on the rod was a sliding piece held by a thumb screw. It might have been a laboratory device, useful in an experimental way. But no! It was a dressmaker's gauge. If you were a woman and were having a waist fitted to a skirt, you'd stand alongside a table, when the proper distance was noted on the skirt a piece of chalk would be inserted in the sliding piece and an encircling line made on your skirt. But just as a flat iron is sometimes used as a hammer, so this device found an odd use in the assembling of a spider-web coil—the sliding member was used to vary the coupling to obtain selectivity in tuning!

But the bureau was not the only place when it came to a handy yet inconspicuous receptacle for tools. No, there was a comfortable looking foot-stool, the top of which was really a good size box. Standing on legs which had been cut from the fancy-work at the foot of an old-fashioned wooden bed, and covered with upholstery and cretonne it made a most artistic piece of living-room furniture. And in this box—well, you might imagine what was in it and not be far wrong.

Certainly, Mrs. Bethman doesn't have to go borrowing when it comes to soldering irons, drills, hammers, and other tools. Indeed, she takes great pride in her little collection of soldering equipment alone.

"Most of these things were given me by the men of the company where my husband works. For besides him, other officials have taken a decided interest in radio. But many of them either did not have the time or did not want to experiment with a radio set. So I had the pleasure of doing it for them, and in appreciation they saw that I had all the various tools that I needed, or could use in an apartment. They certainly get a wonderful lot of good out of radio."

"Besides the pleasure derived from building sets and experimenting, have you obtained much knowledge from what comes over via radio itself?"

"Yes indeed! Would you like to try some health bread that I made from a recipe that came via radio? Besides good health advice, including breathing and dieting, I have heard some splendid travel talks. Personally, I have traveled all over the United States and certainly enjoy it when I hear the scenery of Yosemite Valley and Yellowstone National Park described. With joy, I live all over my travels again. When the guide led me (and other radio fans) through the Grand Canyon of the Colorado I experienced a thrill that I shall never forget, for he described a scene so perfectly that I think he must have overheard me describing it to a friend! Yes, travel is one of the beauties of radio. Only if you happen to be a wife also, be sure that you put plenty of water on the beans or the potatoes before engaging in a travel tour by radio.

"Radio has certainly broadened my interest in a great many things that I scarcely would have been interested in before," she says. "For instance, sports: I like the returns of the various games and races. If any one would have told me two years ago that I would become interested in prize fights I would have promptly denied the allegation. But I have and it's all through listening-in. However, it is not the prize fights that interest me so much as the crowd psychology behind them. And the cheers that are picked up by the microphone! When excitement reflecting this crowd psychology can be made to live, and you feel the intensity of it all—then that to me is a different thing. The other evening about twelve of us listened in on the returns of a fight, half of whom were women, and we enjoyed the excitement as well as the men. It made radio stand out as so much bigger a thing than a newspaper account—real, true and full of life!

"And then the music. I have certainly learned a lot about who wrote various compositions, when they are announced. And I've heard the same selections played in so many different ways! I have a very good ear for music and have been able to reproduce many of the radio selections on my piano. Radio has certainly broadened my repertoire of musical numbers."

"Have you found many women interested in radio?"

"Of late there have been quite a few, but of course from the listening-in standpoint mostly. I do not know of any other woman who builds sets or otherwise tries to learn the secrets of radio. But there aren't so many secrets that one need be afraid of trying to master the combination of good reception, for combination it only is. One part has to work in perfect unison with another, and once this harmony is secured I know of nothing that will bring so much variety and happiness as radio. This set here has not cost me more than \$40 at the outside and the upkeep is practically nothing. Music, speeches, travel talks, lectures, and various topics of the day—where else can you get such a variety of knowledge and entertainment?"

Listen to Mrs. Bethman: "My folks up in a little town on the Hudson wouldn't take \$100 for their set if I couldn't make them another," she said. "Besides entertaining them night after night, it has saved them a lot of money."

"Saved them a lot of money?"

"Yes, everyone has to have some form of entertainment and education, and when they can select anything they want by their radio set they do not care to go to the movies or come to town to the theatre. I have nothing against the movies or the theatre and neither have they, but what they can get via radio and the science of the art itself has been an everlasting attraction to them. They have a pair of phones clamped on to their Victrola too, and mother and dad sit out on the porch until way long after midnight some evenings listening to the broadcastings of this station and that. It's a great treat to them, I tell you."

The technical discussion of radio holds great interest for Mrs. Bethman. Although she cannot at present go deeply into curves and capacities and other engineering pastimes, she has an exceptional grasp of radio affairs, understands the action of the electron tube and knows the whys and wherefores of the various parts of her set. "I am going to get a

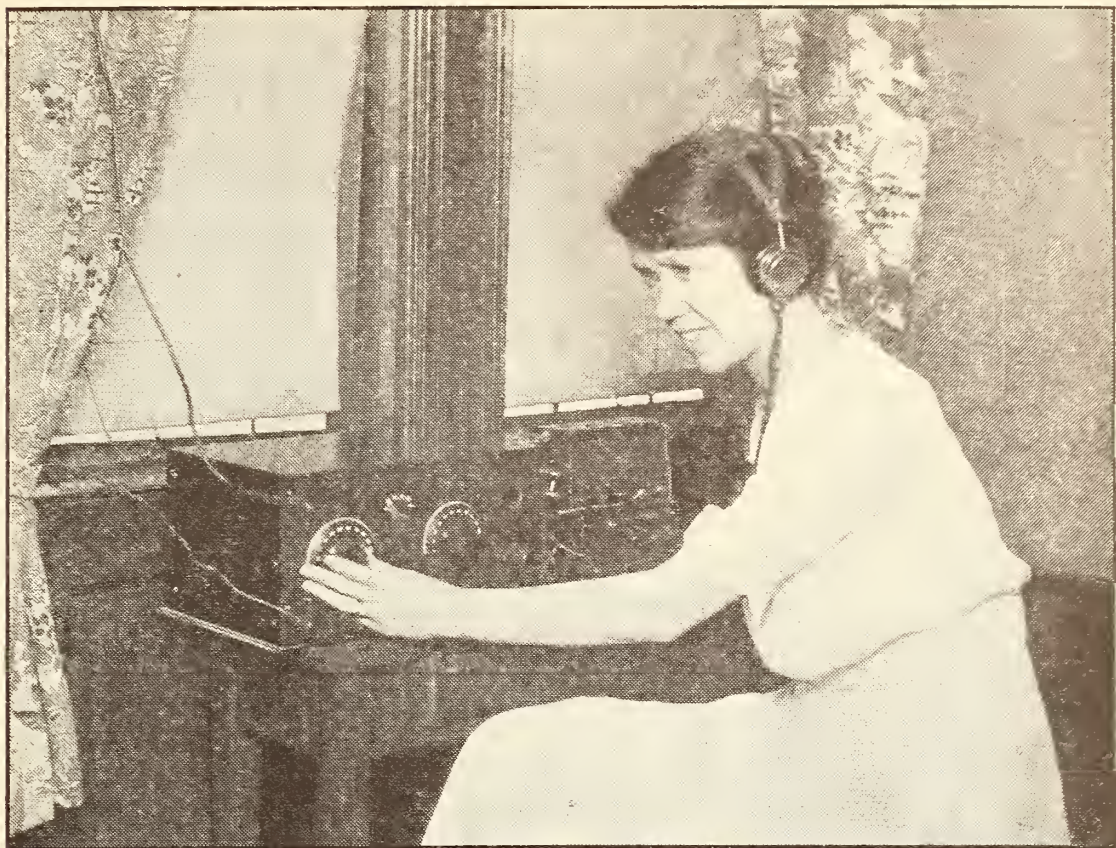

SOMETHING SPECIAL, JUDGING FROM MRS. BETHMAN'S EXPRESSION  
This set is one of the thirty-six which she has made

lot out of this little receiver" she says, "and have already proved that I don't need two steps of amplification in order to hear through the sound box of the phonograph. But I haven't obtained maximum efficiency with it yet."

If radio is a hill of achievement to-day, to-morrow when it becomes of greater interest to women, it will become a mountain. From the women's standpoint, understanding radio seems to be the hardest part. Wiring diagrams scare them. The sudden avalanche of electrical terms does the same. Years ago when carburetor, differential, and similar terms were ushered in with the automobile they had a similar effect. But the popularity of the automobile made these terms familiar to all. Surely it will be the same with radio terms. Moreover, as Mrs. Bethman pointed out, when dealers learn how to sell radio more intelligently themselves, there will come about a better understanding of the art, and with understanding—feminine popularity.

"I don't know what I'd have done if I hadn't received information and advice from a well-informed radio dealer," Mrs. Bethman says. "He took exceptional pains to see to it that I did things right. But it has paid him well—thirty-six sets resulted from our first purchase, and probably many more that I do not know of."

Which speaks very loud for all who have ears to hear.

# Stray Capacity: When You Want It and When You Don't

By JESSE MARSTEN

**A**LTHOUGH the presence of stray or distributed capacity in radio is recognized among the amateur fraternity, its importance is often overlooked or minimized owing to

the fact that the values of these capacities are very low as compared to the lumped capacities used. However, the absolute magnitude is no indication of the importance of distributed capacity, as there are cases where extremely small capacities in the wrong places produce distressing effects. It should be borne in mind that they cannot be controlled and varied at will like lumped capacities and that they often make their appearance in the most unexpected and inaccessible places. It is for these reasons that the subject is of sufficient importance to merit discussion.

Any two conducting bodies which are at different electric potentials will have electric lines of forces between them and may be considered as the two plates of a condenser. Where electric conductors are purposely placed near each other to produce this condenser effect, we have what is called a "lumped" capacity. Where this capacity effect is produced unintentionally, we have what is called "distributed" or stray capacity. Thus in any radio set any two conducting bodies will have capacity between them; and unless proper precautions are taken it may produce harmful results.

Where do stray capacities occur, what effects have they, how may they be used to advantage, and how may they be minimized?

The effects of distributed capacity are greatest in inductance coils, because each turn

is at a different potential from every other turn and therefore forms a miniature condenser with every other turn, the sum total of these miniature capacities making up the total distributed capacity of the coil. This must be taken into account in measurements and designs; otherwise large errors and losses are bound to occur.

Since a coil has distributed capacity, it may be rightly considered as an inductance and capacity connected in parallel, as in Figure 1, where an inductance coil, with its distributed capacities shown in dotted lines, is shown equivalent to a pure inductance with a shunt

capacity  $C$ . An inductance coil will have a natural period of vibration since it constitutes a radio-frequency circuit having inductance and capacity. As a result, if a coil is connected to a circuit in which there is radio-frequency energy at its own natural frequency, the coil will absorb a considerable part of this energy since a condition of resonance is produced. This energy will be wasted unless this condition is purposely brought about. The coil need not be directly connected to the circuit for this to happen: if it is only in the vicinity of the circuit the waste will occur from induction.

## Possibly This is the Reason Your Receiver Doesn't Work

"One often reads an amateur's tale of woe, somewhat like this," says Mr. Marsten, "I built a regenerative receiver, but somehow can't get it to oscillate no matter how tight my feed-back coupling is. What is the trouble?"

"The trouble frequently is that somewhere in his tuner there is a coil whose distributed capacity gives it a natural period of vibration equal to the period at which he is trying to regenerate. But, since this coil is naturally tuned to this frequency, it absorbs so much energy that regeneration is impossible or greatly reduced. This does not mean that there is an unused coil knocking around somewhere inside the receiver cabinet. The principal offender is the unused portion of the primary of the variocoupler."

Perhaps, like many others, you are attempting to use variometers with entirely too much wire on them, or you are attempting to use a receiver over a broad band of wavelengths without taking the precautions against losses which are very likely to occur.—THE EDITOR.

This is one reason for the poor results obtained from many receivers built by amateurs or even marketed commercially to-day. Fig. 2 shows a typical single-circuit receiver widely advertised by manufacturers. A coil BC, having a large number of turns, is tapped and connected as shown. Consider for a moment the broadcasting range of wavelengths. With the average antenna, only a small part of the coil AB is generally required to tune to the required wavelength. It will be observed that there is a portion of the coil not actually used in reception and it often happens that the inductance of the unused portion or even the entire coil with its distributed capacity tunes to the received wavelength. As a result, the incoming energy which strikes the antenna is largely absorbed and wasted by the coil BC and not all of it is passed on to the telephones. This phenomenon is naturally more likely to occur in receivers which attempt to cover a wide range of wavelengths. In these tuners therefore, owing to the large amount of coil

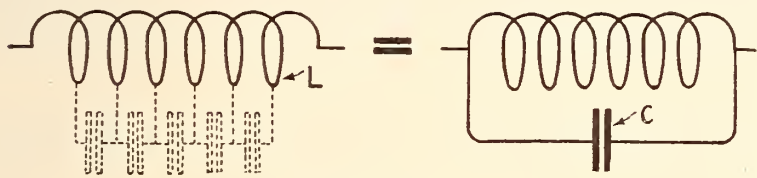

FIG. 1

present but not used, the efficiency is very low unless some means is provided to offset this condition.

Such receivers, or any receivers, for that matter, can be most efficiently designed for a narrow band of wavelengths. A good way to design the single-circuit tuner is as shown in Fig. 3. The circuit is designed to have maximum efficiency on a small band of wavelengths. The entire coil BC is a small coil whose distributed capacity will not give it a natural period equal to any in the range of frequencies covered. At the same time it has enough inductance to reach the highest wavelength desired, which should not be more than 500 to 600 meters, and also has the right amount of inductance for coupling purposes. The coil is tapped as usual, and no matter where point A is, coil BC will not absorb energy since its natural period is under the lowest of the waves received. Finally, by carefully designing coil BC, its construction may be such that its inductance, distributed capacity, and the capacity of the phone circuit will make it resonant to about 380 meters, thus securing

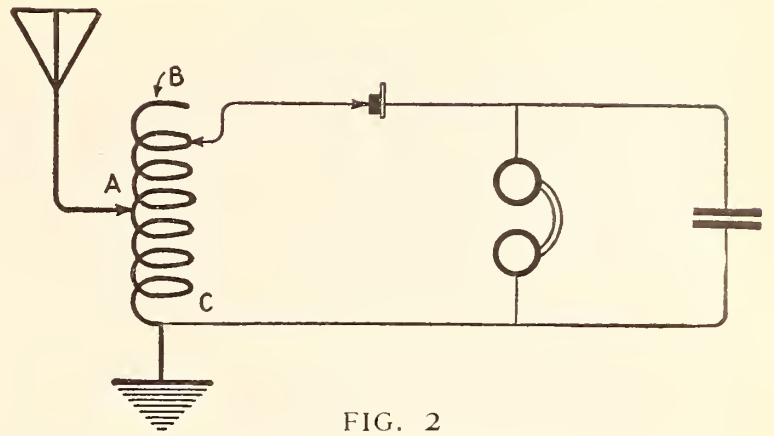

FIG. 2  
A typical single-circuit receiver

maximum transfer of energy from the antenna circuit to the phone circuit and maximum efficiency in the broadcast range.

This effect of absorption and wasting of energy by coils is present in regenerative receivers also. One often reads an amateur's tale of woe, somewhat as follows: "I built a regenerative receiver, but somehow I cannot get it to oscillate no matter how tight my feedback coupling is. What is the trouble?" The trouble frequently is that somewhere in his tuner there is a coil whose distributed capacity gives it a natural period equal to that at which he is trying to regenerate. But since it naturally is tuned to this frequency it absorbs so much of the energy that regeneration is impossible or greatly reduced. A tuned circuit like this is equivalent to placing a very high resistance in the feedback circuit which prevents the current from flowing properly. Too much resistance will, of course, prevent oscillations. In regenerative receivers covering a wide range of wavelengths, it is desirable, in order to avoid such effects, to build the various coils in small sections disconnected from each other, but connected electrically by necessary dead-end switches. Each of these sections should be so designed that the natural wavelength or period of vibration is less than the lowest of the wavelengths at which recep-

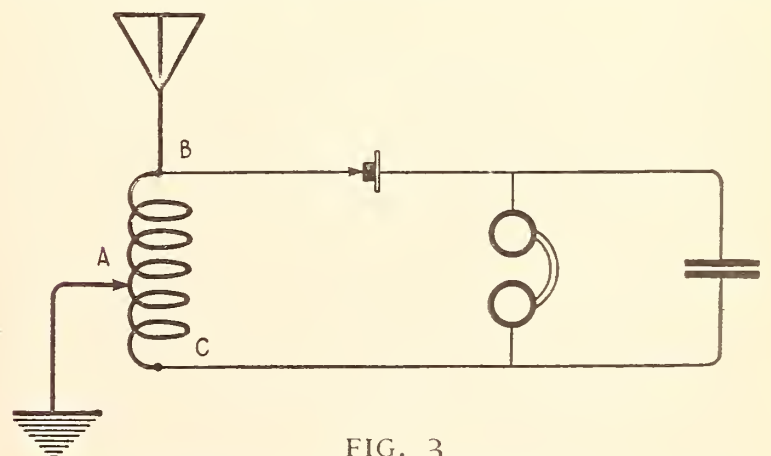

FIG. 3  
An improvement over the arrangement shown in Fig. 2

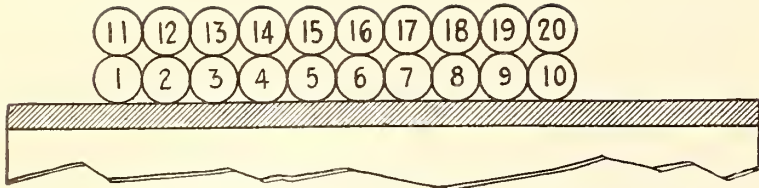

FIG. 4

tion is made. In this way absorption of energy is minimized.

Much of the loss in distributed capacity is due to the dielectric of the distributed capacity being poor. The miniature "condensers" in a coil virtually comprise a large condenser in which a flow of current takes place exactly as in any lumped condenser. This current flows through the dielectric of the condenser which in the case of the distributed capacity of the coil is the shellac, enamel, or other insulating material around the wires. This dielectric is, of course, a very poor one. Although it may possess sufficiently good insulating properties for direct currents, it passes high-frequency currents and much energy is lost in the form of heat in the dielectric. It is therefore desirable to reduce the distributed capacity in coils as much

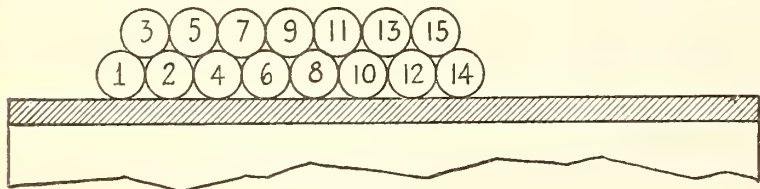

FIG. 5

as possible. Numerous methods of coil winding have been developed for this purpose. The smaller the difference of potential is between contiguous turns the smaller will be the capacity between these turns. A single layer coil will generally have the least distributed capacity since the difference of potential between any two turns is a minimum. However, in any other type of coil the difference of potential is larger. Consider a two-layer coil as in Fig. 4. Here the difference of potential between a wire in the second layer and one directly underneath it is equal to the difference of potential between all the turns between them and is, of course, much greater than that between two turns next to each other in the same layer. This is why most compact multi-layer coils have a high distributed capacity. The principle in the reduction of coil capacity is to wind the turns so that any two contiguous turns will have as small a potential between them as possible. Fig. 5, showing the so-called "banked" winding, illustrates how this

is done. Instead of winding first one complete layer and then the next as in Fig. 4, turns in each of the layers are wound alternately. Fig. 6 shows a three-layer banked winding. By this method, the difference of potential between adjacent turns is always not more than that between a few turns. Thus the distributed capacity is reduced.

The presence of distributed capacity in coils has considerable effect upon the accuracy of

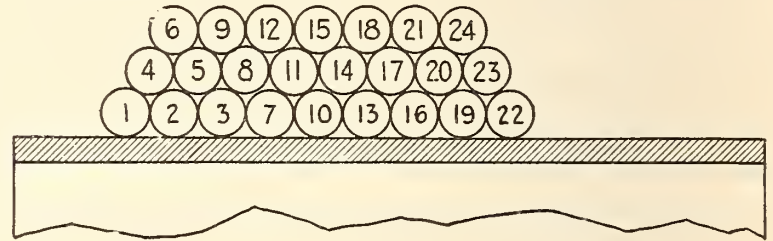

FIG. 6

measurements made with the coil. It will be evident that when large lumped capacities are used in parallel with the coil the effect of the small distributed capacity will be negligible. But when small capacities are used in parallel with the coil, the effect of the distributed capacity becomes greater since its magnitude begins to approach that of the lumped capacity. In other words, distributed capacity exerts its greatest influence at wavelengths which are small and near the fundamental of the coil. It is for this reason that measurements of the inductance of coils will be liable to great errors if taken near the fundamental with small lumped capacities. Measurements should therefore be taken at wavelengths requiring the use of large shunt capacities, because the distributed capacity masks the true inductance of the coil and gives it an apparent inductance higher than its true value. As the wavelength increases, the masking effect becomes smaller and smaller, and the apparent inductance approaches the true inductance.

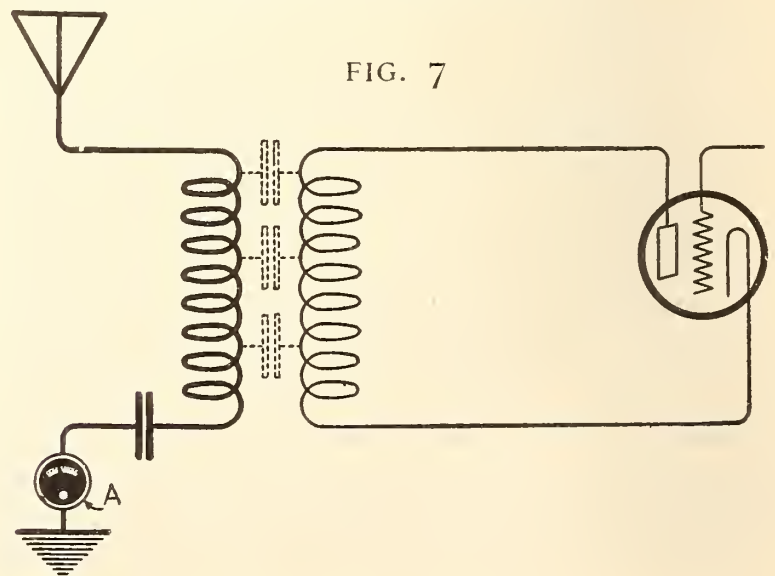

FIG. 7



42ND STREET AND THE THEATRICAL DISTRICT, FROM THE TRANSMITTER HOUSE

This photo happened to be taken when the station was broadcasting music from the Hotel Astor Roof, which is seen brightly illuminated at the right of the picture. The horizontal dots in the background are lights on the Jersey shore

# Behind the Scenes at a Broadcasting Station

By CARL DREHER

There are times when quick decisions and rapid work are demanded of the operating personnel at a broadcasting station. The average listener-in knows little of the complications, and of the incidents both amusing and trying that make up the operator's daily life. Mr. Dreher, who is in charge of the Radio Corporation's New York station, says: "Looking at the apparatus in all its complexity, and revolving in one's mind the number of things that can go wrong, one is surprised that it ever works at all." People, too, cannot always be relied upon to do the things expected of them. How the artists, as well as the apparatus, are handled so as to maintain a smooth and satisfactory program for the broadcast fan, is told in this article.—THE EDITOR.

**A**CERTAIN broadcast listener was disturbed one day by the testing of a couple of amateur phone transmitters in his vicinity. For about half an hour two zealous experimenters recited each other's call letters, the story of Mary and her lamb, and a list of the defects in their modulation, which were many and various. Although the amateurs were on their legal wavelength, this conversation mingled inextricably with the music from a commer-

cial broadcasting station whose program interested the listener. Like the situation in Kipling's ballad when two strong men meet face to face, in radio, when one is close enough, there is neither East nor West, wavelength or frequency or tuning—just QRM. The broadcast listener, vastly and understandably annoyed, did not pause to analyze the facts of the situation. He sat down and wrote to the broadcasting station:

"How do these private talks get into your

amplifying room to be broadcasted, instead of the advertised programs?"

To this inquiry our friend appended many bitter complaints. The notion that the trouble lay in the location or electrical characteristics of his receiving set apparently never occurred to him.

Another gentleman suffered with a receiving system which was capable of picking up signals, but without prejudice as to wavelength; its tolerance was such that it did not differentiate very well between 405 and 455 meters, and consequently there was considerable interference, in this listener's set, between WJY and WJZ. The listener knew that these two stations are located at Æolian Hall in New York, as the halves of a duplex station, but he did not know that the two programs are radiated from separate sets, separate aerials, and separate studios, with inappreciable cross-talk between the two wavelengths. He sought and found a simple physical reason for the interference which he experienced, informed the broadcasting station of his observations, and berated the technical staff soundly with this rhetorical question:

"Why . . . don't you close the doors between the studios?"

Having been a radio man for many years, I have little respect for myself or other members of the fraternity. Still, they have more sense than that; they really have.

Complaints also come in by telephone. The conversation usually begins as follows:

"Something's wrong with your modulation. Are you listening in?"

Informant is assured that three men are listening in, and that it sounds all right at the transmitting end. After a few minutes of conversation it develops that the receiver is howling. The trouble is not usually at the broadcasting station; if it is, the operators are aware of it. When there is something rotten in Denmark, the Danes are apt to know it.

#### THE JOB OF KEEPING A STATION GOING

**N**OT that the broadcaster is never at fault. Looking at the apparatus in all its complexity, and revolving in one's mind the number of things that can go wrong, one feels surprised that it ever works at all! Yet it works



#### NOT TOO MUCH HERE TO OBSTRUCT THE WESTBOUND WAVES

View taken from the base of the Æolian Hall towers, looking toward Hoboken and San Francisco. At the left is the Wurlitzer Building, with Bush Tower behind it, then the Candler Building, Times Building, and the unfinished Times Annex. Beyond flows the beautiful blue Hudson



successfully almost all of the time; after less than two years of commercial existence, metropolitan broadcasting is substantially on the level of operating efficiency of other public utilities. This in spite of the fact that radiotelephony presents problems of unique and inherent difficulty to the engineer. The slight energy of the voice and of musical instruments, in all its complexity of pitch, quality, articulation, inflection, and shading, must be amplified to power level, and this final half-kilowatt of radio power which is flung out from the aerial of the transmitting station must be a faithful reproduction of the original feeble acoustic vibration. To accomplish this, not only in the laboratory, but for a reliable grade of public service, is probably a more difficult job than running an electric railroad, say, for here we start and end on the power level; or manufacturing wrist watches, for in this instance we work with small energy and no great demands in the way of power will ever be made on the system. The object of this article is to give readers some idea of how carefully the various energy transformations are checked in a well regulated broadcasting station, what precautions are taken against interruption of service, and what, in general, goes on during the day's work.

The work may be divided roughly into three parts. First, the picking up with a microphone or other acoustic-electric device of the sounds to be broadcasted. Secondly, amplifying this energy and putting it out on the air. Thirdly, listening to and observing the output, and finding fault with it if possible—for if any faults exist, and the station critics don't find them, outside critics will. Broadcasting is in one way a division of the show business, and the luxury of nursing their weaknesses in private is denied to professional broadcasters, as to politicians, actors, and multi-millionaires. They always have the comforting thought that their mistakes will be heard and noted by the general manager and a squad of directors of their own corporation, besides a few chief engineers and such, besides some score of professional musicians with an ear for what drops out and what is over-emphasized, besides the emissaries and representatives of rival broadcasting stations, besides a few hundred thousands of the general public. Consequently the work of checking the output of the transmitters is not the least important part of the job. The place where this is done—the control room—is

in fact the heart of the station, and while the station is in operation the control operators have supreme direction of what is to be done, and how, and when. G. H. Q. is in the control room.

#### THE ARRANGEMENT OF STUDIO AND APPARATUS AT ÆOLIAN HALL

IN THE description which follows, station WJZ of the Radio Corporation of America, at Æolian Hall in New York City, will be used, that being the station which the writer happens

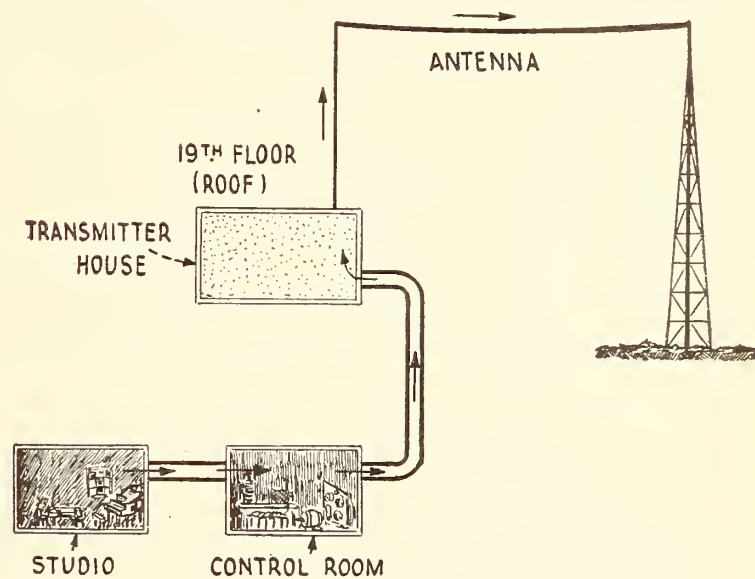

FIG. 1

to know more or less intimately. The layout of this installation is rather unusual. It is shown schematically in Fig. 1. The studios, reception rooms, and control room are located on the sixth floor of an eighteen-story building. The actual sets and all the power equipment—motor-generators, storage batteries, etc., together with the aerials, are on the roof. The necessary connections are made through a mass of pipes or conduits carrying insulated wires, installed according to the best electrical practice. Of course all wireless stations are prolific in the matter of wires, but as one stands in the sixth-floor corridor, near Forty-Second Street, and gazes at the row of black pipes stretching out to Forty-Third Street, thence rising majestically up the freight elevator shaft a few hundred feet, before going half way back to Forty-Second Street to the transmitter house on the roof, and reflects on the number of wires each pipe contains, the name "Conduit Central" springs to one's mind as a fit alternative for the station's official cognomen of "Broadcast Central."

In Fig. 2, a schematic view is given of the control operator's equipment. There are six single-step amplifier units, of which not more

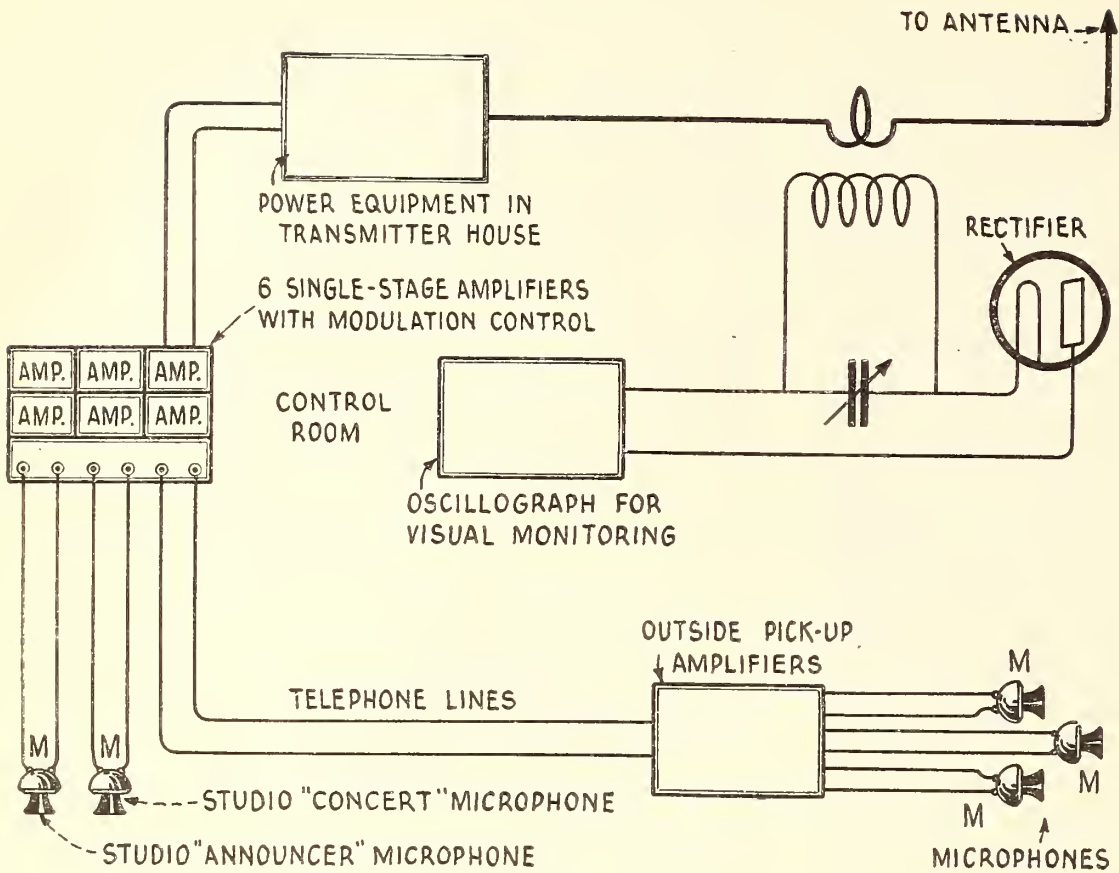

FIG. 2

A schematic diagram of the control operator's equipment

than two are used at any given time, the remainder being spares. Four of these amplifiers are intended for use in connection with the studio; two are for outside work. By means of plugs and jacks similar to those on a telephone switchboard, and a set of knife switches, the control operator can connect either studio microphones or outside lines to his amplifiers and send the output upstairs to be progressively amplified to power level and put out on the air. The plates of all these single-stage units in the control room are connected and all that is necessary is to give the unit input energy and to light the tube. In the transmitter room, coupled to a single turn in the antenna lead, there is an edgewise-wound copper ribbon inductance, which draws a small amount of energy from the aerial to actuate an instrument in the control room, called an oscillograph. This apparatus gives a faithful picture, in the form of a light ray thrown on a revolving mirror, of the sound wave impressed on the radio oscillations sent out from the station. By means of it the control operator can ascertain at a glance what the state of his modulation is, and make any indicated changes. "How much is she modulating?" or, less elegantly, "How much is she kicking?" is one of the most frequent questions asked in any broadcasting station. At many stations the answer is a matter of guesswork, but at WJZ the control

operator can answer: "Forty per cent. average; seventy per cent. peak," or whatever the figures are, just as if he were reading temperatures on a thermometer, or miles on a speedometer.

This matter of per cent. modulation is important enough to warrant an extended description, of which only a brief outline will be given here. It amounts to this: You have a certain amount of radio frequency—say 500 watts—to put out on the air. This energy is not itself audible. All that people can hear is the variations produced in the radio-frequency output by the sound waves impressed on the latter. Modulation is the business of varying

the radio frequency in accordance with these sound waves. If you undermodulate, no one on the outside hears you. The available energy of the station is not being used. It is like investing one's \$500,000 in a project yielding interest at the rate of  $\frac{1}{4}$  per cent. The investment would probably be perfectly safe, but one could not entertain many Follies girls on the income. If you overmodulate, everyone on the outside will hear you, but it would be better if they did not, for what they will hear is like a combination of bricks sliding down a chute, the songs of amorous cats, and the war cry of the noble red-man. This is equivalent to investing one's 500 talents in a bootlegging enterprise, getting caught by the revenue officers, and losing both one's patrimony and one's freedom. There is a happy mean which is at the same time audible and safe. The control operator must find this mean and stick to it, or to-morrow he gets fired. (However, even if the per cent. modulation is well gauged, the control operator has a number of other means of getting fired.)

Fig. 3, in its several divisions, shows what may be seen in the revolving mirror of the oscillograph. There are three straight vertical lines, the left-hand one being the zero line, the right-hand one marking 100 per cent., with a median line indicating 50 per cent. A wavy line formed by the reflection of a beam of light

on the revolving mirror, by the extent to which it fills the space between the two extreme marks, indicates the measure of modulation. In Fig. 3a, the modulation is low—about 10 per cent. corresponding to a pianissimo passage in music. In Fig. 3b, the modulation is 60 per cent.—a good, audible value, with adequate margin for most exigencies. Fig. 3c, illustrates a bad case of over-modulation.

But now, instead of continuing our description in the regulation way, let us proceed from this bare outline of the equipment, and fill in the details by telling the story of a composite day in a control operator's life.

AN AVERAGE DAY IN THE LIFE OF THE CONTROL OPERATOR

WE WILL call him Jim.

Jim wakes up at about ten o'clock in the morning, for he worked the evening before till after eleven, and probably took out his girl, or a

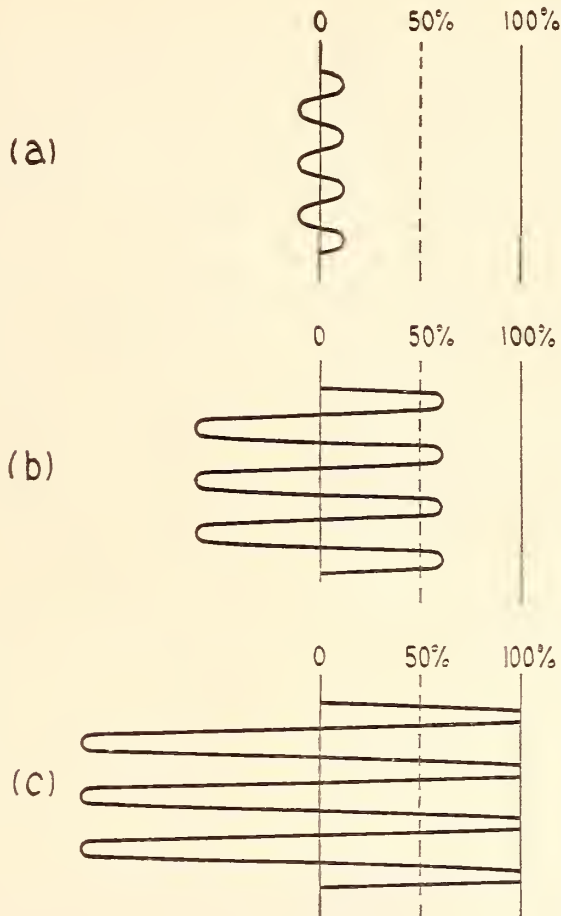

FIG. 3  
Low, good, and too great modulation, as indicated by the oscillograph

plurality of girls, after that. He breakfasts in bed while glancing at the radio programs in the morning papers. However, we are not concerned with Jim's activities until, after two o'clock, his limousine rolls up to the Æolian Building. Ascending in the elevator, he observes a number of musical celebrities, for this building is one of the chief musical centers of New York, and makes a mental note of the latest fashions in flowing scarfs before getting off at the sixth floor and entering the control room. Here some of his own colleagues are already seated, earnestly discussing the rotten modulation at all the other stations in the country, the faults of the announcers, means of making broadcasting pay, and the grave error of

the executives of the company in not immediately doubling the salaries of the whole staff.

At 3.00 P. M. the program is scheduled to



"HIS OWN COLLEAGUES . . . DISCUSSING THE ROTTEN MODULATION AT ALL OTHER STATIONS, The faults of the announcers, means of making broadcasting pay, and the grave error of the executives of the company in not immediately doubling the salaries of the whole staff"

start. Shortly before this time the control operator throws a number of switches, putting current on the microphones and tubes, and, drawing aside a curtain, he glances through a horizontal window into the studio, where the announcer is conferring with the first artist, a red-haired soprano, regarding the numbers she is to sing. At fifteen seconds before three o'clock the control operator lifts the receiver of a small intercommunicating telephone before him, rings the roof, and gives the order, "WJZ on the air." Or he may use the local designation of "Channel B." An instant later a green signal light glows on the amplifier rack in the control room and also in the studio, notifying the announcer and the control-room operator that the transmitter is on the air and ready for the program. As yet, however, nothing but inaudible C. W. is going out. Several other signal lights are put on at this time, but

these have no material part in the working of the station, communication between the several rooms being by interphone.

Observing the green light on his table, the announcer sits down and throws on his microphone by setting a small cam switch at "Announce." This lights a red bulb in the control room and also in the transmitter house, warning all hands that speech is about to go out. The announcer then gives his preliminary speech, introduces the artists, and throws his cam switch to "Concert." The music begins. The control operator, who has paid only casual attention to the announcement, for he is familiar with the announcer's speech and has his apparatus properly set beforehand, is now very much on the alert; he turns a knob rapidly, puts out the room lights in order to observe the oscillograph better, and peers through the window at the scene in the studio. Appar-

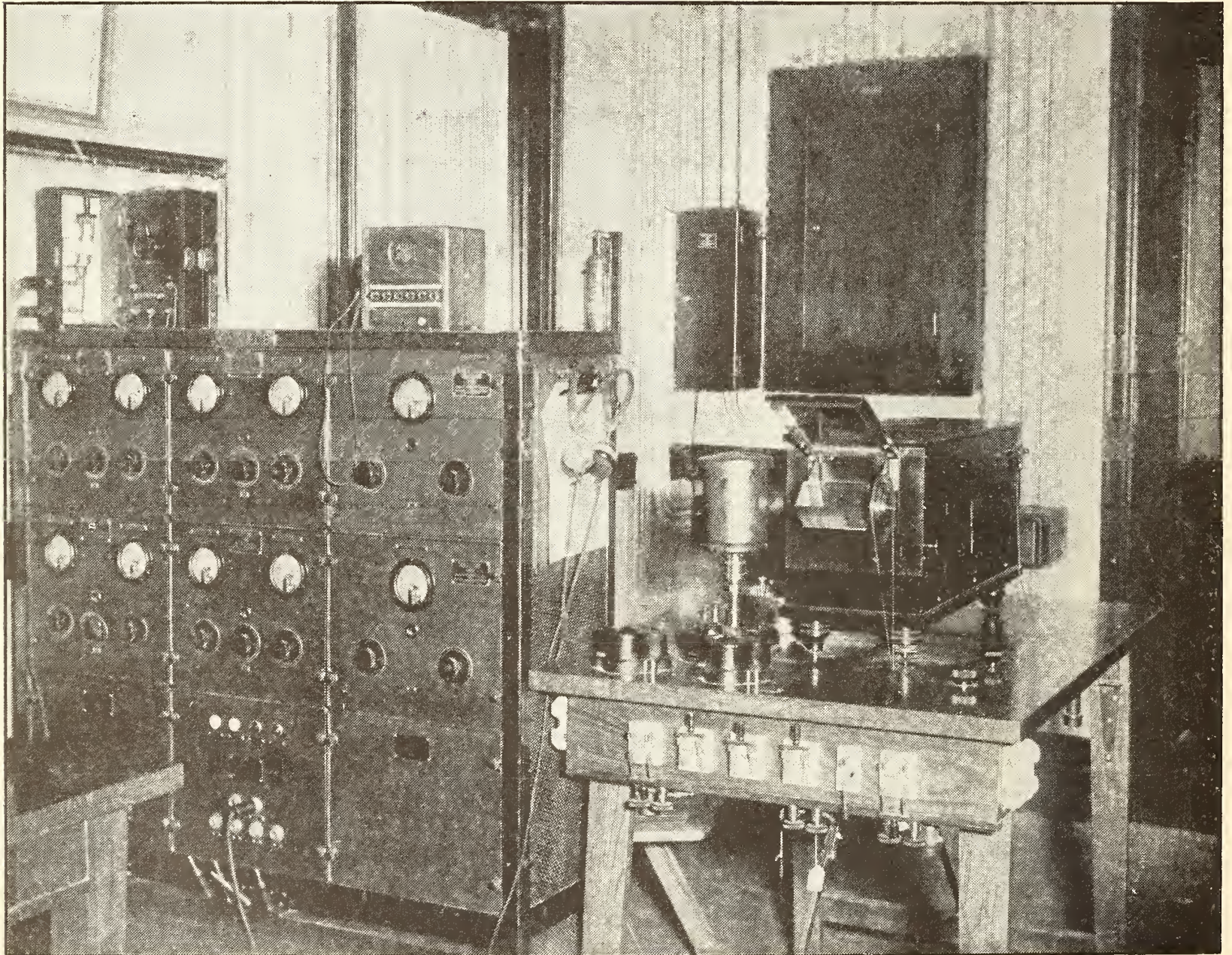

THIS IS WHERE JIM PUTS IN HIS EIGHT HOURS A DAY

A section of the control room at "Broadcast Central," Aeolian Hall. The amplifier rack, with the interphone unit on top of it (for talking with "the roof" and the studio), is seen at the left. At the right is the oscillograph with its four-sided mirror in which the voice pictures appear

ently he is not satisfied, for he holds the telephones tightly to his ears, and even mumbles inarticulate comments to himself while listening. Finally he calls the studio on his interphone and says, "Too much piano; but let it go till the end of the number." This is a matter of judgment. If the microphone is moved during the number a jarring sound goes out on the air, and the artist may be somewhat disturbed in her singing. As the accompaniment is only slightly too loud in proportion to the voice, Jim has decided to defer the change to the end of the first selection. Perhaps he was influenced by the singer's red hair. At the end of the number the announcer gives the usual formula: "The number you have just heard is——" and throws the cam switch to the "Off" position. The red light goes out and the station is momentarily inactive, although the oscillators are still on the air and the green light glows as before. Before continuing with the next number the announcer moves the microphone pedestal so that it will pick up less energy from the strings of the piano and more from the singer's vocal cords. He may do this by asking the singer to stand nearer to the microphone, or by shifting the microphone to a position farther from the piano. A frequent setting for vocal solos is shown in Fig. 4. The change being made, the concert continues.

#### KEEPING IN TOUCH WITH THE ROOF

**A** WORD about the interphone system of calling. The telephones on the roof, in the control room, and in the studios, are equipped with the usual buzzer system of ringing, but in the studios, where silence is imperative, a white light on the telephone unit glows for calling. The announcer answers by lifting the receiver off the hook and listening. The control operator hears the receiver being lifted and makes his request. The announcer acknowledges receipt by tapping his transmitter twice, forming the code letter "1", which passes in radio and wire circles for "Received"; this procedure is inaudible in the studio, but perfectly clear to the control man. In the absence of this signal, the control operator repeats his instructions till they are understood. This system has worked out well in practice. In case of a matter requiring a consultation of any length, the control operator may call the announcer into the adjoining control room.

During the second number of the red-haired soprano's repertoire Jim confines himself to

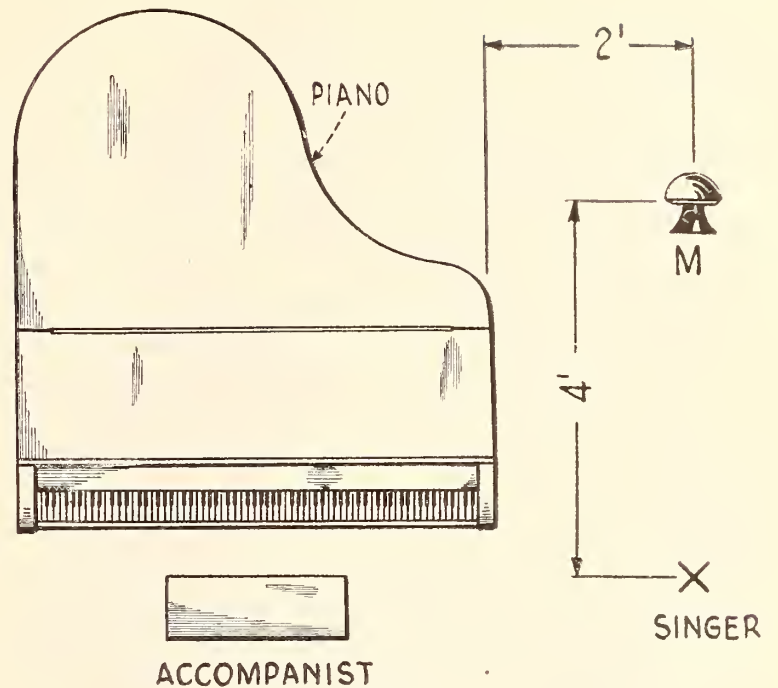

FIG. 4

This arrangement has been found suitable for vocal solos

adjusting modulation, bringing up his "gain control," as it is called, on very pianissimo passages, and "holding her down" to prevent over-modulation on the forte notes. However, he does not attempt to level out the music or to edit it in any way; on the contrary, his business is to put out on the air, as faithfully as possible, the material given him in the studio, making only such adjustments as are required by the nature of the media, physical and electrical, intervening between the artist and the audience. This is easier for some artists than for others. In general, performers with experience in phonograph recording are the best to handle. They realize that they are singing in a room and not in an opera house, and graduate their volume accordingly. The apparatus and the operators are grateful to them and they go out well. Others sing with enormous volume in the hope of reaching New Zealand, but of course they do not get out any louder and there is a tendency to overload the microphone, with the production of a scratching sound, more or less prominent, which detracts from the quality of the voice on the air. However, within considerable limits the operators can compensate for inequalities, and the usual answer to the question, "Shall I play or sing in any special way?" is, "No; perform in your natural manner, and it will get out best."

#### HELPING THE PERFORMER "GET OUT" WELL

**T**HE control operator is aided in his work if he knows most of the songs that are apt to be rendered, and has enough knowledge of musical composition to know a few seconds

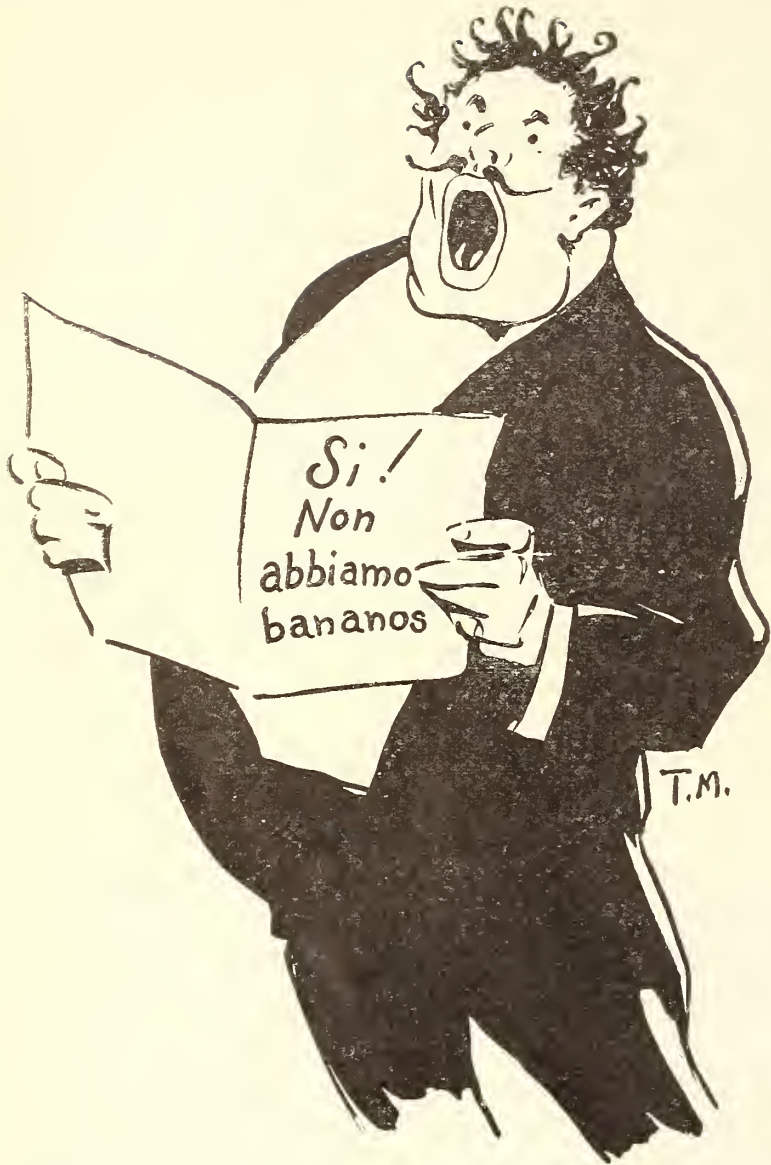

"IN THE HOPE OF REACHING NEW ZEALAND"

ahead when a fortissimo passage is coming. This is in fact one of Jim's qualifications, and it preserves him from ever being caught flat-footed when the artist pulls out the stops and takes it on high—to mix three metaphors—and under these conditions it would take an earthquake to over-modulate when Jim is holding down the channel. To a certain extent, also, he may rely on his judgment of the artist's vocal capacity; but this is apt to be treacherous. The writer remembers one occasion when a very small coloratura, with whom he did not have the honor of any previous acquaintance, started on her first number in the studio. She had a beautiful radio voice, but did not look dangerous in the matter of volume, after some fairly bulky girls who had preceded her. The writer made his settings accordingly. In a few seconds she hit 85 per cent. on a peak. The writer was familiar with the aria and knew there were some fortissimo breakers ahead, but he did not think that the artist could get up any higher. This thought, unfortunately, had no basis in fact, the lady swept up to her high note with astonishing force, modulating

about 150 per cent., and before anything could be done the plate relay on the transmitter tripped and the set shut down with a squawk. The spare set was on the air in five seconds, but the writer felt like a tennis player who gets a soft lob at the net, sets himself to bury it, and slams it into the backstop. Well, accidents will happen when one is dealing with strange coloraturas and judges them by weight.

After Mademoiselle has got through with her program, there is a talk on fashions. This item gives Jim little concern, and when one of the announcers brings in the soprano to look over the control apparatus, Jim is able to tilt one of the phones off his ear and to monitor with the other side while explaining the functions of all the lights and knobs. Of course she wants to know how she went out, and here Jim applies his code. If she was fair, he tells her that she was good. Good he calls wonderful. If she was really wonderful, words fail him. If she was bad, he says he wasn't listening. But even that is not necessarily a discredit to the artist, for occasionally one hears a voice which is good concert material and makes a fine impression in the studio, but does not transmit well, owing to some obscure acoustic factor which does not affect the human ear as much as it does the microphone.

#### WHEN TUBES GO BAD DURING A PROGRAM

TOWARDS the end of the fashion talk, however, Jim notices a slight muffling in the voice, which leads him to call up the transmitter room with the question: "Are your modulator tubes gassing?" The transmitter men have already noticed as much, and they proceed to push a few buttons and start the spare set. A slight click on the air marks the change-over, and the signals clear up at the same instant. While the second set is carrying the load, the defective tubes may be replaced in the first set. If there were not two sets available the trouble could not be rectified without interrupting the program. In a first-class broadcasting station everything is provided in duplicate or better, and kept ready for service at a few seconds' notice.

The next feature on the program is a five-pièce jazz band. Jim already knows the characteristics to expect from this ensemble, and he places the violin close to the microphone, the saxophones somewhat farther back, and the traps and banjo to the rear. After the

first number a few minor adjustments in placing may be necessary.

Jim's real troubles begin when he has an outside event to broadcast. All that the public knows about it is the announcer's request to stand by while the program is switched from the studio to such-and-such a place umpty-ump miles away, a 15-second pause, and the voice of the announcer at the new scene of action. But there is a great deal of action behind the scenes.

In the studio there is a well-known pianist. Owing to slight but cumulative delays in the program, the studio is running five minutes behind its schedule. At 8:30 a symphony orchestra of one hundred pieces is to be broadcasted. The wires have been in for several days, they have been tested a few hours before the beginning of the concert, and since 7:30 Jim has been on the line at intervals, talking to the pick-up men, listening for extraneous noise on the wires, and so on. It is 8:29. The pianist is in the middle of his last selection.

"Say, Jim," comes the voice of the chief pick-up man, "I've got to have the air. They're going to start."

"It's only eight twenty nine and a half," replies Jim, stalling for time. "He's on his last number. Just a second and I'll give it to you."

"I can't wait a second," declares Bill, on the outside. "We've got 8,000 people here. The conductor's glaring at us. For heaven's sake give us the air."

Jim begins to sweat. He looks through the window at the pianist. He looks at the announcer, who lifts his index finger—one minute more. Will the number never end? Of course Jim could take the piano off the air without the performer knowing it, but the audience would know it, and the pianist's relatives who are listening on the outside would tell him before very long. So the plug remains in. The outside men, in the meantime, are making appealing gestures at the conductor. If he should



THE TRANSMITTER HOUSE ON TOP OF AEOLIAN HALL

It is here that the voice currents from the studio and control room, thirteen floors below, are amplified and delivered to the antenna, part of which can be seen in the upper left-hand corner of the picture. The announcer in the studio, the operator in the control room, and the transmitter house personnel keep in constant touch with one another by means of a special telephone system

start, the first number of the symphony program, which will take 15 minutes, will be lost. By running over two minutes at the studio, the station stands to lose thirteen minutes on the air, with nothing to fill in, and the certainty of losing the audience to other stations with attractive programs. At 8:32 the pianist finishes. As the local announcer finishes his say Jim pulls the plug, leaps to his telephone, calls, "You're on the air," and closes the switch which connects the distant microphones to the set on the roof. The voice of the concert announcer is heard, and an instant later the symphony begins. Jim monitors this locally, with the pick-up men making adjustments at their end, and the transmitter men on the job upstairs. There may be as many as five men checking on one channel.

In the intervals the wire is used for conversation regarding the wire line transfer between the control room and the pick-up point. If Jim neglects to pull the switch, this stage business goes out on the air. Occasionally this happens, and the radio audience hears directions like: "Change to 440 loop; this wire's getting noisy," or, "Hey, haven't they got any string instruments in that orchestra?" But this is a rare occurrence.

So the program runs its course—vocal

numbers, instrumental numbers, jazz, opera, talks, recitations, symphonies, time signals, bedtime stories, plays—anything that the program manager has reason to believe will please some considerable fraction of the audience. As closing time approaches Jim has listened to a hundred thousand words about the income tax, international relations, the boll weevil, love and marriage, the preparation of prunes, how to keep one's good looks if one never had any, why the army should be enlarged, and measures to stop the next war. He has heard arias from every opera from

Orpheus to The Girl of the Golden West. He has had six fights with announcers bigger than he is, been challenged to duels by four outside pick-up men, received twelve very insulting telephone calls from listeners who were wrong and three moderately insulting ones from listeners who were right, and ogled twenty pretty girls, all escorted and inaccessible. Promptly at 11:30, with the last syllable of the sign-off, Jim collapses and is dumped into his limousine to be carried home. Let the invisible audience drop a tear for him next time they slip on the "cans."

#### THE MASS OF STEEL AND MASONRY EAST OF AEOLIAN HALL

The aerial towers rise 115 feet above the roof from which this picture was taken, thus clearing all these buildings. The Biltmore Hotel (with flag flying) is seen at the left, the Commodore pushes up against the sky-line in the centre, and the banks and business buildings which cluster around Madison Avenue and 42nd Street form the walls of a "Grand Canyon." The dark patch at the bottom of the "canyon" is the motor-traffic bridge leading around Grand Central Terminal joining the up and down-town sides of Park Avenue. A bit of the East River and some power houses on the Brooklyn shore may be seen in the background. This is the kind of territory over which the radio waves must travel and into which they must penetrate





# The "Dope" on Wavelengths and Kilocycles

If you are not familiar with the relation between wavelengths and kilocycles, here is the opportunity to get it into your head in a few minutes. The information is likely to come in handy from time to time.

**T**HE current radiated from the aerial of a broadcasting station is *alternating* in character: that is, instead of having always the same potential and the same polarity (like the current from a dry cell, for instance), it is constantly changing in these respects, building up from zero potential to a maximum, or "peak," of positive polarity, and then "collapsing" to zero and building up to a similar peak of negative polarity. Such a current is represented in the accompanying diagram. It alternates very rapidly—at radio frequency, as it is called. A *cycle* is a complete reversal of alternating current from a positive peak down through zero to the negative peak and up through zero again to the next positive peak.

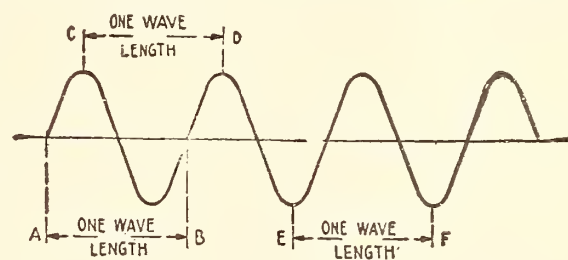

The number of *cycles per second* is called the *frequency*.

The physical distance between two successive peaks of the same polarity is called the *wavelength*, generally measured in meters. These waves travel through space at the speed of light—186,000 miles a second or 300,000,000 meters a second. Now, if a wave makes 1,000,000 complete reversals a second (that is, has a frequency of 1,000,000 cycles, or, 1,000 kilocycles), it will make *one* complete reversal in  $\frac{1}{1,000,000}$  of a second; and in  $\frac{1}{1,000,000}$  of a second, any given peak (being part of a wave always traveling at the rate of 300,000,000 meters a second) will move through space a distance of exactly 300 meters.

A station transmitting with this 1,000-kilocycle wave, then, is said to be sending "on 300 meters."

Here is the equation for changing wavelength to kilocycles and vice versa:

$$\text{no. of kilocycles} \times 1,000 = \frac{300,000,000}{\text{wavelength in meters}}$$

For example, if a certain wavelength is 400 meters,

$$\text{no. of kilocycles} \times 1,000 = \frac{300,000,000}{400} = 750,000, \text{ or}$$

$$\text{no. of kilocycles} = \frac{750,000}{1,000}, \text{ that is, } 750. \text{ (See table below).}$$

The following tables give the frequency in kilocycles for various wavelengths:

FREQUENCY IN KILOCYCLES	WAVELENGTH IN METERS	FREQUENCY IN KILOCYCLES	WAVELENGTH IN METERS
1,500	200	333	900
1,000	300	300	1,000
750	400	200	1,500
600	500	150	2,000
500	600	100	3,000
429	700	75	4,000
375	800	60	5,000
		30	10,000

To check up a certain wavelength with its corresponding frequency, multiply the frequency (kilocycles x 1000, because one kilocycle equals 1000 cycles) by the wavelength. The result should be 300,000,000.

# What Causes Fading?

By CAPT. P. P. ECKERSLEY

Chief Engineer, British Broadcasting Co.

THE phenomenon of "fading" has been known to wireless engineers for some time, but the advent of broadcasting has brought the subject into great prominence.

There may be those, fortunately situated in relation to one of the broadcasting stations, who have never experienced fading; so, at the risk of redundancy, I will try to explain first what I mean by the term.

You are listening to a station 150 miles away when all at once the signals go dead, or weak. You fly to the regenerative control, but everything you do has no effect, when suddenly without warning the sound bursts out again. The number of people who have conscientiously soldered, tightened and tuned, and scratched their bewildered heads, must be legion, as the number who write in, having satisfied themselves that *their* end is all right, and complain of the variability of the transmissions, is certainly considerable.

As a matter of fact, the transmissions by the British Broadcasting Co., are *not* variable, and except where light and shade are desirable in musical items, radiation and modulation are maintained sensibly constant.

The cause of the variability lies, therefore, between the transmitting station and the receiving station.

The question is, then, what is there to influence the attenuation of the waves so markedly and so variably? Why in certain places does London fade while other stations do not? Why is fading noticeable only at night, and why should night time signals be stronger than day time signals in certain places and not in other places? Why should 2 LO be audible only a quarter of an hour after sunset in Salamanca, Spain, and why

should the Shetlands get us pretty uniformly, while people in the Victoria district (no! London, not B. C.) experience fading effects which are never noticed, say, in Hampstead? The answer is easy as far as I am concerned, and it simply is, *I don't know!*

But a general theory exists which I will give you, and which probably forms a basis on which to build the explanations of minor variabilities.

First of all, wireless waves travel through the ether, which is the assumed medium for the transmission of all electro-magnetic waves. This medium is not in any sense of the word matter, inasmuch as matter is ponderable and can be analyzed, weighed,

felt, and experienced by the human senses as it were. The ether is perfectly non-conducting to electricity, and to our senses it is nothing. But floating about in the ether are minute particles which in various permutations and combinations form matter—air, water, earth, and so on. Now, if matter is conductive to electricity, it impedes the progress of electromagnetic waves traveling through the ether which holds matter. Thus, if the air which is suspended in the all-pervading ether is conductive, it impedes wireless waves. It may come as a surprise to many to know that air can be conductive; it is not usually necessary to suspend the filament terminals of your set in a vacuum, but air *can* become quite conductive, and especially does it become so under the influence of sunlight. What happens is that the little particles called molecules in the air are made lively by the sunlight and split up into electrified units, which make possible the conduction of electricity.

Thus, in the accompanying diagram I have drawn a rough sketch of the world, with the

The phenomenon of "fading" becomes more noticeable as the cold weather, with its long-range reception, approaches. Broadcasting from a given station may be remarkably loud one minute and almost inaudible the next. Adjustment of the receiver will not overcome this trouble and it is very naturally the subject of much discussion and conjecture. In this short article, reprinted from *The Wireless World and Radio Review*, London, the author explains in simple language one of the generally accepted theories.—THE EDITOR.

THE EARTH

Showing the action of the sun's rays in producing an electrified layer

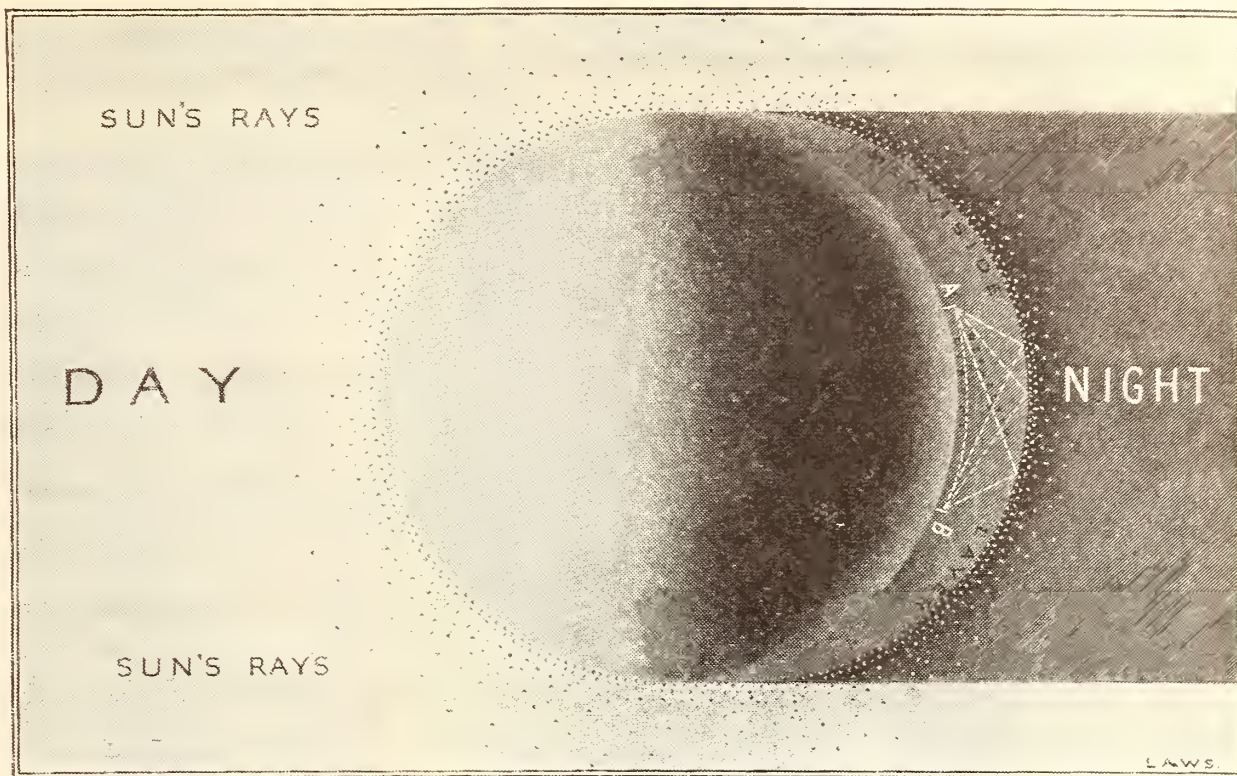

sun shining full on one side, leaving the other in shadow. On the sunny side, what apparently is a swarm of flies is meant to represent elec-

trified particles. On the dark or night side these particles have recombined near the earth, while many others have risen up to a height and are all huddled up together to form a sort of electrified layer, some 20 or 30 miles above the earth's surface. Daylight diffuses the layer which at night time forms above the earth. The layer was first assumed to exist by Heaviside, and is often known as the "Heaviside Layer."

Near the sunrise or sunset region the diffusion is very great, owing to the sunlight being oblique to the air, and gradually toward the night side the air is cleared of particles, while toward the light side uniform diffusion sets in.

Now see what happens between two stations A and B on the night side. Some of the waves go direct, but many of the waves from A to B hit the layer and are reflected from it. The reflected waves are added to the direct rays, and therefore, as the reflective qualities of the layer vary, so the strength of the signal at B varies. It is as though the layer were a great mirror, and that, as it turns and changes and moves uneasily in its sleep, so the signal is reflected more or less, and so fading occurs.

If this theory is true, certain things could be proved experimentally as follows:—

(1) *There should be no fading in the day time, but the signal should be uniformly weaker.*

This is generally true.

(2) *There should be evidence of rays considerably inclined to the vertical.*

In direction-finding work, the general princi-

ple of determining the direction of the incident waves, is to use a frame, the angle of the vertical plane of which can be varied. When the frame is at right angles to the on-coming waves no signals are heard, but this can only be so if the waves are arriving horizontally; any vertical component will affect the frame equally in any position, and no minimum will be found. This actually happens because a simple frame at night gives no reliable bearings due to the presence of the vertical component.

(3) *Using a frame which combines so largely the direct and the vertical ray, distortion should occur with speech.* This is noticeable more with a frame than with a vertical aerial.

(4) *Fading should be more noticeable at great distances from the transmitter than near it.* (Obvious from the diagram). This is noticed.

(5) *Fading should be more noticeable over land than over sea, owing to the greater attenuation of the direct ray.* This has been noticed.

Further than this it is impossible to go, because obviously the whole phenomenon depends so largely upon casual happenings. Undoubtedly, though many of the freak ranges are influenced by casual electrifications forming giant reflectors just in front of the sunset, the extraordinary difference between the power required to drive a signal across the sunset or sunrise band, to that required when this electrified band is removed, is evidence of the justness of the theory, and many of the problems of East and West transmissions are bound up with the same idea.

# “Must Be Heard to Be Appreciated”



VAUGHN DE LEATH AS PROGRAM MANAGER

“The Original Radio Girl,” now in charge of the broadcasting programs at WDT, New York, is a composer of songs, a recording artist for the phonograph, possessor of a contralto voice of three-octave range, a pianist, director of an orchestra of sixty pieces, and a recitalist. Hers was one of the first women’s voices to bridge the Atlantic. All who have heard her over the radio will agree that she certainly knows how to put over a song



BILLY JONES AND ERNEST HARE

Two of the most popular fun-makers who ever faced the microphone at WEA. This popular pair had a big ovation at the Tel. & Tel. station in New York at their first appearance, last July, when they caroled about the scarcity of a certain tropical fruit. Considerable experience in recording for the phonograph has taught them how to put over their acts most clearly and effectively for the radio audience



THE SNAPPY UNIVERSITY OF CALIFORNIA ORCHESTRA AT KPO

This sextet has provided, for those tuned in on the Hale Bros. station in Frisco, much sparkling jazz

# Who Will Retail Radio?

Is the Phonograph Dealer or the Electrical Dealer Going to Prove Best Qualified to Provide Sales and Service for Broadcast Listeners?

*"Is it electrical, Mister Eckhardt?"*

*No, it's musical, Mister Eltz!"*

You have probably heard, and possibly taken part in, discussions relative to the proper agency for distributing radio apparatus to the public. Do you believe that electrical experts will be needed to sell intelligently, and to keep in repair, the sets we shall be using a few years from now? Or do you consider that the broadcast receiver will be primarily a "musical instrument," and therefore best sold by organizations developed for the handling of musical instruments? At any rate, you will be interested to know what a representative of each of these trades has to say on the question.—THE EDITOR.

## Radio Sales and Service by the Musical Trade

By W. L. ECKHARDT

President, General Radio Corporation

**R**ADIO as a business is destined to compare favorably with the largest commercial enterprises of all time as soon as experienced business men realize the tremendous possibilities in applying the same principles and policies to the radio business that have been paramount in the development of the automobile and phonograph trades.

### RECEIVING SETS CLASSED AS MUSICAL INSTRUMENTS

**T**HE time is rapidly approaching when no home will be considered complete without its radio receiving set, loud speaker and all that goes for satisfactory reception of the broadcasted programs—the important topics of the day, speeches of our great statesmen, and other worth-while features. Therefore, a thing of so great importance in our daily lives requires to be properly merchandised, and should be attended during its original installation by a thorough servicing. It is, therefore, only reasonable to assume that the merchandising of receiving sets will be very readily adopted by that line of trade to which it is akin; and in reviewing the situation carefully it will undoubtedly be appreciated that, first of all, *radio must be classed as a musical instrument.* I do not mean by this that it will take the place of some other musical instrument, but rather that it occupies a position entirely its own, properly located in the musical instrument field, and fortunately so, because in the writer's

opinion no other agency is quite so well qualified to undertake the job as is the music dealer.

### PRESENT SITUATION SIMILAR TO EARLY PHONOGRAPH DAYS

**I**T WAS a long time before the piano and musical trade realized the important part to be played in their businesses that was to come through the medium of the phonograph. In the early days of the phonograph many of the principal musical houses of the country hesitated to take it up, feeling that the phonograph would detract from their piano sales. Back in the late 90's and the days from 1900 to 1905, many of to-day's largest phonograph merchandisers were only luke warm to the possibilities of the phonograph. These same houses have followed somewhat their early impressions in this respect, with reference to the radio receiving set, but on all sides we are now learning of new additions to the radio business in the phonograph and musical trades. These firms are adequately equipped, with suitable show-rooms, demonstration booths, sales organizations and service departments, to install and service the merchandise after installation properly. They make it their business to follow up every sale for a definite period to insure perfect satisfaction on the part of the purchaser.

Prior to 1900, just as to-day in the radio business, it was quite an exception for a talking machine to be sold on the instalment plan; but by 1904 it was generally accepted by all leading merchants that the sale of phono-

graphs would be substantially increased by offering them on time payments, or on a club plan. This is bound to follow at a very early date in the radio business; as a matter of fact, it is being done at the present time to a modest extent by a number of enterprising merchants.

Of course it is needless to state that just as the phonograph business was not confined exclusively to the phonograph and the musical trades, but was merchandised frequently through the sporting goods shop, the hardware shop, gas and electrical companies, jewelers and the like, so radio will be handled by a miscellaneous line of trades; but in the course of a very short time I am of the opinion that we shall see the bulk of the radio trade, that is with reference especially to the completed sets, handled through the phonograph and musical trades.

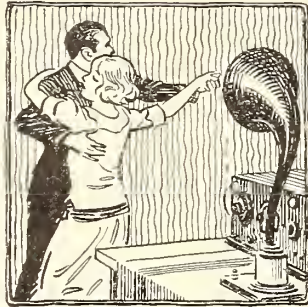

cult for many interested buyers to locate a responsible merchant through whom they could secure guaranteed radio apparatus, although a great number of little merchants profess to be radio dealers and in the majority of cases confined their efforts and display to an assortment of miscellaneous parts for the "build-your-own" customers. This was undoubtedly prompted by the shortage of completed sets during the early days, and by the great interest of the younger generation, who were educated to build their own because of the extraordinary emphasis laid upon the great difference between the cost of the completed set and the cost of the parts required to make a similar set at home. This feature of the radio business, however, is rapidly passing, in the writer's opinion, and I do

not under any circumstances recommend this class of merchandising for the musical industries. It is distinctly a separate business and may be handled by such wide variety of merchants, embracing everything from the junk dealer, hardware store, electrical store, electrical contractor, to the department store, but in no case does this feature of the business belong in the musical trade.

That the radio business will come into its own, and be embraced principally by the musical and phonograph trade during the coming winter, I am firmly convinced, although a number of the better electrical firms which have all the elements required to merchandize and service radio properly, will also secure their share of the trade. In our organization we have developed a complete service training school, in charge of competent engineers, and we recommend to all merchants that they send their salesmen and service department men into our laboratory, without cost, to secure the necessary training for the proper exploitation, sale and service of radio receiving sets.

#### SELLING OF RADIO NOT YET WELL DEVELOPED

IT IS only natural that in view of a quarter of a century of experience in the phonograph and musical trades, I am partial to this particular field. But I am certain that an unbiased observer acquainted with the situation would be convinced that as soon as experienced merchandisers take the time to survey the radio business it will require more than the fullest capacity of all radio manufacturers in the country to cope with the demand and requirements. I truly do not feel that the radio business has been seriously taken into hand up to the present time. There are very few firms who are in a position to do it full justice; and if other lines of trade had been conducted in the way that the radio business has been conducted during its early days, they would never have had the success of such trades as the automobile, motion-picture, and phonograph industries.

During the past season it has been diffi-

---

## What Would You Like to Have in RADIO BROADCAST?

*The editors would be pleased to hear from readers of the magazine on the following (or other) topics:*

1. *The kind of article, or diagram, or explanation, or improvement you would like to see in RADIO BROADCAST.*
2. *What has interested you most, and what least, in the numbers you have read so far*

# Why the Electrical Dealer is the Proper Outlet for Radio

By GEORGE J. ELTZ, JR.

Radio Sales Manager, Manhattan Electrical Supply Co., Inc.

**S**INCE the introduction of radio broadcasting in 1921, radio material has been sold on a number of different merchandising plans through a great many different sources. Some of the plans followed and some of the outlets through which radio material was sold, have been quite satisfactory; but in general the most satisfactory outlet from a standpoint of both the manufacturer and the public, has been that which was used prior to broadcasting—namely, the electrical dealer.

## HOW SETS ARE NOW SOLD AND WHY

**T**HE radio business of to-day may be quite clearly divided into two parts:

1. Business on complete sets which are:
  - (a) Sold complete with all the necessary equipment to the customer who does the installation work himself.
  - (b) Radio sets which are installed complete in every detail in the home of the customer by the party making the sale.
2. Parts business:
  - (a) Sale of complete sets of parts to a customer, with detailed instructions by the party making the sale, on the manner in which they are to be connected.
  - (b) Sale of parts to customers who are familiar with the manner in which they are to be used.

The radio business of the United States is now one of the big industries of the country, from the point of view of volume as well as of public interest. Strange as it may seem, of all the other large industries in the United States, radio is probably the only industry which is conducted along the lines outlined above. There are a number of good reasons why this should be the case. Radio as an art has been familiar to a small number of people for the past twenty years. Previous to radio broadcasting there were approximately 150,000 amateurs in the United States who were intensely interested in radio. It is safe to say that every one of these amateurs had at some time or other manufactured a radio set. There were several reasons for this:

1. The amateur could not always procure a receiving set completely assembled which suited his own particular needs.
2. It was practically impossible for the amateur to purchase a complete transmitting set, a side of the radio industry in which he was intensely interested.
3. The prices of both the receiving and transmitting sets were exceedingly high and the average amateur could not afford them.
4. The patent situation controlling the manufacture of both transmitting and receiving sets was as involved then as it is at present and complete transmitting and receiving sets, even when purchased, frequently lacked one or two essential characteristics which it was necessary for the amateur to add in order to obtain best operation.

Due to the above causes, the amateur became familiar with the construction of radio apparatus. Manufacturers were quick to realize this, and produced a complete assortment of parts which permitted the easy construction of the complete sets used by the amateur.

## WHY "BUILDING YOUR OWN" IS SO POPULAR

**W**HEN broadcasting was started, there was, consequently, a more or less complete assortment of radio parts available, and what is more important there were these 150,000 amateurs, all familiar with radio construction and all more or less prejudiced in favor of the purchase of parts in the construction of radio sets instead of the purchase of complete instruments. That these amateurs have been a decided factor in the present division of the radio industry cannot be denied. The propaganda in favor of the construction of sets from parts spread by these amateurs and the fact that a great shortage of complete receiving sets existed when radio broadcasting first started, unquestionably accounts in a large measure for the great use of parts by the general public. That this use of parts will continue for some time (and, in fact, that it may always continue) is borne out by the ratio of parts sales to complete set sales, and the immediate interest of the public in any new part which is placed on the market.

## THERE ARE NO PHONOGRAPH "AMATEURS"

THAT the great volume of parts sold is a peculiar condition of the radio industry is evident from a consideration of a more or less parallel line, the talking-machine business. Of all the thousands of talking machines in use, probably less than a fraction of 1 per cent. have been constructed by the users. This is in spite of the fact that talking machine parts are available in almost as great profusion as are radio parts. Complete talking machines can be constructed for considerably less money than complete radio sets and with a much greater certainty of satisfactory operation. As far as can be learned, there has never been a class of amateur phonograph constructors, and in their absence information regarding the construction of phonographs was not general. As a result there was never the demand for parts which exists in the radio industry and the sales of phonographs were confined almost exclusively to complete instruments.

A consideration of the above facts is necessary in order to obtain a true picture of the radio situation of to-day and in all probability of the radio situation of the future. Unquestionably from the angle of the public, manufacturer and dealer, it would be far better to have radio sales confined entirely to complete sets. There are two good reasons for this:

1. If the demand was confined to complete sets, the production of complete sets would increase, with a consequent decrease in manufacturing cost and cost to the consumer.
2. The public would be assured of obtaining a receiving set which would give satisfaction—which is not always the case when the unskilled amateur attempts to construct his own set from parts.

Be that as it may, the facts of the case are that radio material will always be purchased in two clearly defined ways—as complete sets, and as parts for assembly.

## DIFFERENCES BETWEEN THE RECEIVING SET AND THE PHONOGRAPH

WITH these facts before us, let us see what is the best method by which the apparatus can be placed before the public. No matter from what angle radio is viewed, whether it be complete sets or parts, radio apparatus is apparatus of a *technical* nature. There are so many different factors entering

into the operation of a radio set, that to compare it with a phonograph would be foolish. A phonograph is a purely mechanical device which has been simplified so that it contains but few parts. It can be easily set into operation, and once operating will give practically no trouble. The phonograph will operate equally well regardless of location. You know what you can expect of it, anywhere, anytime. The sale of a phonograph is consequently a pure selling job, where the appeal can be made purely on a price or quality basis and positive assurance given the customer that the machine will operate properly. The sale of a radio set is essentially different.



1. The customer has to be sold the idea of radio, its advantages, and why he should supplement his phonograph with a radio set.
2. The customer cannot be positively assured that the radio set will work perfectly in the location in which he desires to have it installed. The installation of the set is frequently requested by the customer, and a great many times the sale cannot be made unless installation can be undertaken by the dealer.
3. The installation of a radio set, while it has been considerably simplified since the advent of radio broadcasting, still is infinitely more complicated than the installation of a phonograph. To a person familiar with the installation it is a comparatively simple problem; but to be successful a dealer requires a more or less trained personnel.
4. Radio sets require a certain amount of maintenance which the purchaser naturally looks for through the source from which he purchases the radio set. This service, it is true, may be charged for; but again this requires trained workers.

With these facts in mind, let us consider which class of merchant serving the public at the present time is best fitted to carry on the sale of radio material. It has been clearly demonstrated that the accepted method of distribution, by means of distributors and jobbers, may be successfully applied to radio material. The following channels through which purchases may be made by the user are available:

1. Hardware Dealers
2. Department Stores
3. Phonograph Dealers
4. Electrical Dealers
5. Special Radio Stores

Consider separately the five different sales channels listed above:



1. *Hardware Dealers*

Hardware Dealers have never taken very keenly to the sale of electrical equipment. The merchandise they sell and the class of trade which their establishments attract, are concerned more with mechanical than electrical contrivances, although some of the larger hardware dealers have established electrical departments and have been extremely successful in the sale of electrical equipment.

2. *Department Stores*

Department stores can profitably handle radio material in a large volume if they have already established an electrical department in charge of a trained personnel. In this particular regard, they are more or less similar to hardware dealers who establish a special electrical department.

3. *Phonograph Dealers*

Phonograph dealers, it would appear on first thought, should be a good outlet for radio apparatus. If, however, the problem is a little further analyzed, the facts will not bear out this contention. Speaking of the average phonograph store—not the large establishment, where the installation of a special radio department would be possible and probably practical—the personnel employed by phonograph dealers is not trained in the particular way necessary for the sale of radio equipment. This is true even if the sale of radio equipment is confined entirely to complete sets. The average phonograph dealer or phonograph salesman is in every sense of the word a salesman. He is quick to answer questions which may be put to him on the operation of the phonograph; but generally he is not in a position to discuss the technical phases of even the phonograph's construction and operation. If a phonograph dealer is to sell radio equipment, even complete sets, it will be necessary for him to secure the services of a more or less trained selling force who are capable of answering fairly technical questions; and it will be necessary for him to establish a department to install properly the radio sets which are sold, and to maintain radio sets which have been placed in operation. In selling complete sets the problem is of course much simpler than when selling parts. The sale of parts requires the service of a man who is fully familiar in every particular with radio circuits and radio construction work. Such a man, as a general rule will not be of particular service in the sale of phonograph equipment. The result is that the phonograph dealer must establish a complete radio department. This is an additional expense which will naturally reflect itself either in an increased price of material to customers or in decreased profit.

4-5. *Electrical Dealers and Special Radio Stores*

Electrical dealers and special radio stores at the

present stage of the radio industry cannot perhaps be properly grouped together when due regard is taken of all the facts. It will only be a question of a short while, however, before the special radio store will handle, in addition to radio equipment, other profitable lines of electrical merchandise. Practically everyone is a user of electrical equipment to some extent. It is but natural for the public to attempt to purchase some of this electrical equipment at the same place where they obtain their radio supplies and equipment. The progressive owner of a special radio store is bound to recognize this demand and will unquestionably, as has been the case in a great many instances, install a special department in which the more profitable lines of electrical merchandise, other than radio, are sold. It is, therefore, correct to class electrical dealers and special radio stores in the same category. The statements which apply to the electrical dealer, then, apply equally well to the special radio stores.



Let us consider what qualifications the electrical dealer has which would permit him to sell radio equipment readily:

1. *Personnel*

The salesman in the average electrical dealer's store has been trained to think along electrical lines and to explain to the public the operation of electrical devices. By familiarizing himself with radio, therefore, he can talk in a manner which the public understands. The sale of radio material by an electrical dealer does not require the installation of special salesmen, merely the training of those already employed.

2. *Installation and Maintenance Factors*

The electrical dealer has been accustomed to maintaining and installing electrical apparatus in the homes of his customers. The same personnel which is necessary for this work is in a position to undertake readily the installation and maintenance of radio equipment.

For the sale of parts the electrical dealer is much better qualified than any of the other merchants listed above. The arrangement of his electrical stock is quite similar to the arrangement which will be necessary to make when radio parts are handled. He is familiar with the sale of small items from past experience and is accustomed to carrying in stock a varied assortment of parts. The personnel in the electrical dealer's store through their own knowledge of electrical devices can more easily adapt themselves to the problems presented by radio, if, indeed, they are not already familiar with them.

Of prime importance, and the greatest ar-



#### THE RADIO DEPARTMENT OF A LARGE ELECTRICAL SUPPLY HOUSE

Here the experimenter and broadcast fan can obtain about anything they want from complete sets to binding posts

gument in favor of the electrical dealer handling radio equipment is that outside of the investment required for a stock of radio equipment, the electrical dealer is required to go to almost no additional expense. The investment in radio stock for establishments of the same size will be approximately the same for any of the merchants enumerated above. In the case of all of them with the exception of the electrical dealer, a separate department must be installed, or if it is already installed must be slightly modified and a special arrangement made to carry out the installation and maintenance work properly. An increase in operating expense, whether it be brought about through the addition of new personnel or through the addition of a special department must reflect itself directly in the profits of the dealer. This increase in operating expense will eventually reflect itself in the list price of the apparatus sold. If the profits of the dealer are not sufficient to make radio a paying line he will compel the manufacturer to increase his profits to him. The manufacturer in turn will have to forego

some of his profit or else increase the price to the consumer. The price of radio apparatus at the present time is high. A further increase in list price would certainly cause a decrease in the volume of sales. That channel of distribution which places the apparatus in the hands of the consumer at the lowest list price with a fair profit to all parties concerned in the transaction is the best channel through which to merchandise radio.

Thus, unquestionably, at the present time the electrical dealer is the best fitted to handle radio material, and through this channel practically all the radio equipment which has been sold over the past two years has been distributed. The progressive radio dealer has in the radio line a potential business which is greater than any other line in the electrical industry. Radio dealers have been quick to realize this and although other methods of distribution will unquestionably be attempted, the electrical dealer has taken foremost rank in the distribution of radio material and bids fair to hold his place.

# A Well-Made Place for a Well-Made Set

For Those Who Can Spare One of Their Book-Case Sections, This Manner of Installing the Receiving Set Is Worth Considering



NOW YOU SEE IT AND NOW YOU DON'T

The fan who begins with a neat set each evening and ends with a set *plus* wire, parts, junk, tools, etc. is advised against this scheme

**A**N UNUSUAL feature of the receiving outfit constructed by Mr. John Showalter, of Wabash, Indiana, is the place in which it is kept. Only one shelf in the center section of a three-section bookcase had to be removed in order to install the complete three-tube receiver, storage battery, charger, and B batteries. The simplicity of the arrangement is what will appeal to many enthusiasts. You merely close up the desk board, draw across the curtain, and you have a library again instead of a radio corner.

Mr. Showalter has heard over 130 different broadcasting stations with the three-circuit honeycomb coil outfit shown in the accompanying illustration. In the winter, he has often been able to pick up KHJ, Los Angeles, 1800 miles from his home.

His is not the apparatus of a broadcast fan, however; for he says that he "hates to see the amateur telegrapher fade into oblivion as the so-called broadcasting craze springs into more and more prominence."



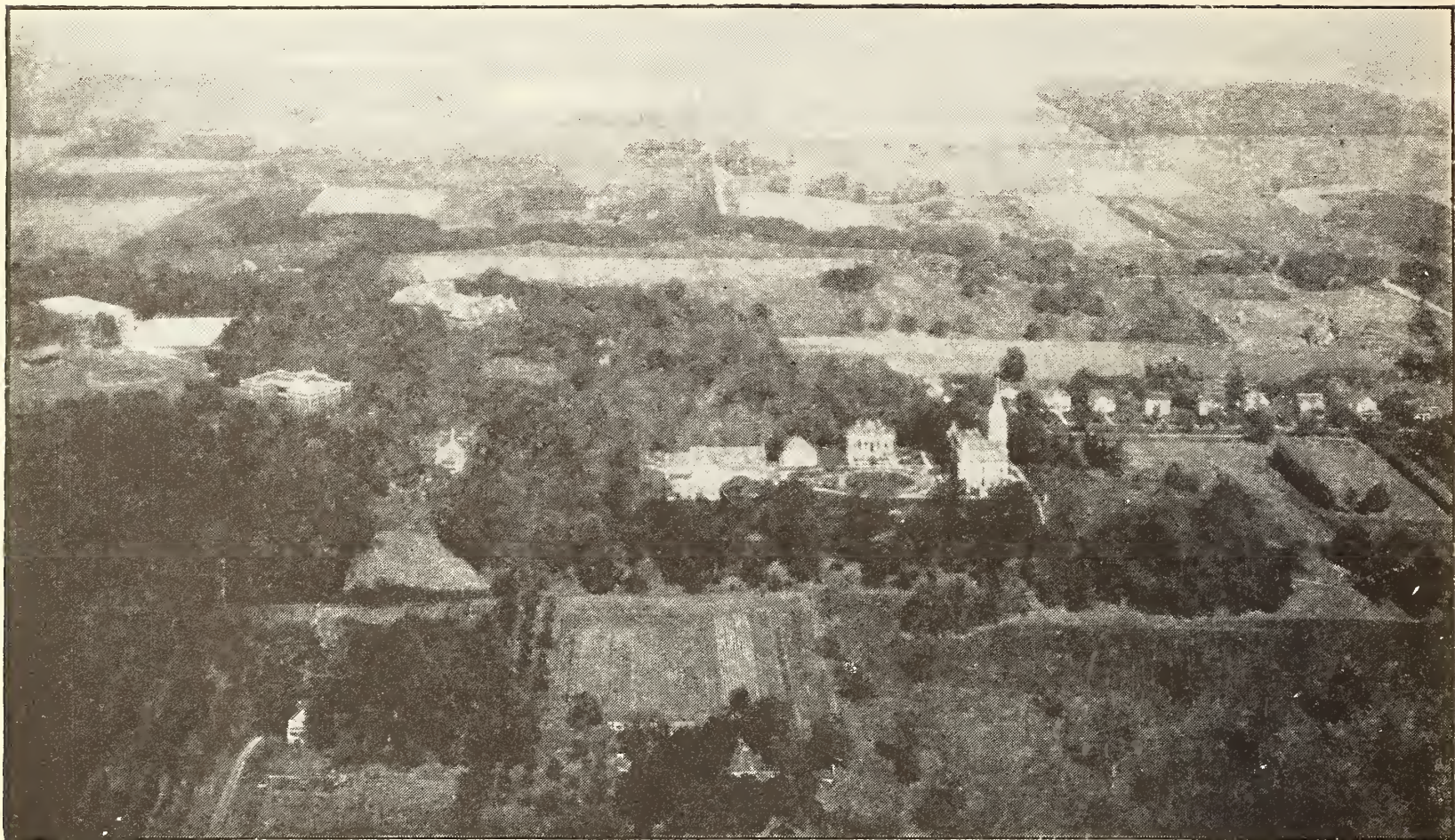

AIRPLANE VIEW OF ST. OLAF COLLEGE, NORTHFIELD, MINN.

From the point at which the picture was taken, the ground of course seems flattened out; but the college is located on Manitou Heights, a considerable rise above the surrounding country

## What a College Can Do in Broadcasting

The Achievements of St. Olaf College with Station WCAL, Northfield, Minnesota. Talent and Friends, the Two Natural Advantages Which Any College Has in Operating a Broadcasting Station

By FRANKLIN CLEMENT

**O**CCASIONALLY a radio station, like some persons, is born with a silver spoon in its mouth, and is able to weather successfully vicissitudes that have destroyed other stations less fortunately situated. A table in RADIO BROADCAST for March, 1923, showed that at that time broadcasting stations operated by educational institutions led the field in apparent permanence. Perhaps the spoon has helped.

WCAL, operated by the department of physics at St. Olaf College, Northfield, Minnesota, was one of the earliest stations in Minnesota, and is now the oldest continuously operated

station in the state. St. Olaf is a standard liberal arts college that had during the past year an attendance of 948 students. It is owned and controlled by a synod of the Lutheran faith, the Norwegian Lutheran Church of America. Its students come for the most part from Minnesota and adjoining states: Wisconsin, Iowa, and the Dakotas, but there are not a few from more distant states and countries, including representatives from Maine, Washington, California, Texas, and several provinces of Canada.

The St. Olaf College station, and every college station, has at least two distinct advantages over those operated for more commercial

purposes: an unfailling program supply, and an established clientele.

#### PLENTY OF MUSICAL TALENT

EVERY standard college has in its students and faculty a wealth of musical, dramatic, forensic, and athletic talent, by the very nature of college requirements and conditions. St. Olaf is particularly fortunate in having at the head of its school of music Dr. F. Melius Christiansen, who has produced under his direction the St. Olaf Lutheran Choir, an organization with an international reputation for choral singing. When the choir, long recognized in Minnesota as of an unusual character, first invaded the East in 1920, it received such extravagant praise as to make the tour a complete triumph, and gained from the best of the nation's critics the title, "the world's supreme choir." Coming into prominence almost simultaneously with the popular *Main Street* of Sinclair Lewis, it was hailed as "the vindicator of Main Street," and a Brooklyn critic wrote that the choir had "proved that Gopher Prairie and its environs are dispensers, not despisers of culture." The reputation thus founded has been more securely established in succeeding years.

Naturally, then, St. Olaf College is the gathering-place for a large number of capable student musicians, and from the membership of the choir numerous artists are selected for the programs broadcasted from WCAL. To the

thousands of persons throughout the country who have heard the choir, the radio programs are of peculiar pleasure even aside from their merit, because they have seen and heard the singers in person.

But things musical at the college are not limited to the choir. There is an excellent concert band of forty pieces, developed by Dr. Christiansen, and now under the direction of J. Arndt Bergh. The band has undertaken extensive tours, including one to the Pacific coast last spring, and has been enthusiastically received. Its members have contributed often to the success of WCAL concerts. There is also a college orchestra as well as numerous smaller orchestras, quartets, and other groups of entertainers, composed and managed by students.

At a college of liberal arts, with music one of the arts, a high standard is to be expected. Then, also, there is in all college programs an appealing youthfulness which is one of their greatest charms. It is the amateur instead of the professional. While the same perfection of production may be present, there is added the ingenuous enthusiasm of youth in its own performance.

But music forms only a part of the programs any college station is in position to offer. Other forms of entertainment are equally welcome. Within the short space of three years the English department at St. Olaf has built an innovation into a tradition, and now



THE 1922-23 ST. OLAF LUTHERAN CHOIR

This organization, developed by Dr. F. Melius Christiansen, has excited the admiration of the nation's best critics. It has given many recitals at WCAL

the annual production of a Shakespearean play is of such moment that visitors are attracted from all over the state. In November, 1922, the WCAL officials decided to try what was at that time an experiment, the broadcasting of a play, and the resulting radio production of Shakespeare's "As You Like It" was one of the first broadcasts of a play in history. The experiment was successful, enormously so, and a repetition was demanded. The resulting letters showed how genuinely appreciative the radio listeners were. High school teachers of English who could not hope to show their pupils a stage presentation of a Shakespearean drama told how the evening had helped them in their work; excited high school pupils wrote of their own pleasure, and Shakespearean admirers throughout the United States and Canada expressed their thanks.

Colleges can also provide speakers. Informative lectures on popular subjects of politics or economics were early introduced in WCAL programs, and during the past year radio extension courses were offered in the departments of biology, chemistry, economics, education, and philosophy, by department heads. Responses indicated that the lectures were welcomed in innumerable homes.

Sermons, too, have been a part of the college radio programs. College chapel services, broadcasted direct from Hoyme Memorial Chapel at St. Olaf, have been of special interest to the homes represented by sons or daughters or friends at the institution. Occasional speakers

visiting the college have found their audience greatly increased by the marvelous development of broadcasting. Such a one was Dr. Paul Harrison of Arabia, a medical missionary with wide experience, who, when visiting St. Olaf was privileged for the first time to address unseen radio listeners. Of interest also to these listeners, judging by reports, was a radio debate on the question, "Resolved, that the United States should enter the League of Nations," when the two St. Olaf teams which had represented their college victoriously in six intercollegiate contests, were so well matched that the decision of the listeners who took the trouble to mail their votes was an exact tie!

And athletics? Minnesota fans follow with eager interest the major sports of the eight colleges composing the Minnesota Intercollegiate Athletic Conference: Carleton, Concordia, Gustavus Adolphus, Hamline, Macalester, St. John's, St. Olaf, and St. Thomas. Whenever a contest is held in Northfield—and both Carleton and St. Olaf are in Northfield—WCAL broadcasts the result of the contest, and has frequently sent out, direct from the floor or the field, a play-by-play account of a basketball game or gridiron conflict. This was made possible by the construction of a small portable studio which could be set up on the sidelines. The athletic news and news of other activities finds favor with many listeners not otherwise given to the habit of head-phones.

That is one of the tremendous advantages a college has in broadcasting—the ability to pre-



#### PLAYERS IN "AS YOU LIKE IT"

Miss Ruth Vaaler, of Fosston, Minn., and Gonard Felland of Stoughton, Wis., as Rosalind and Jacques in the production of Shakespeare's comedy, which was sent out by radio from the St. Olaf station

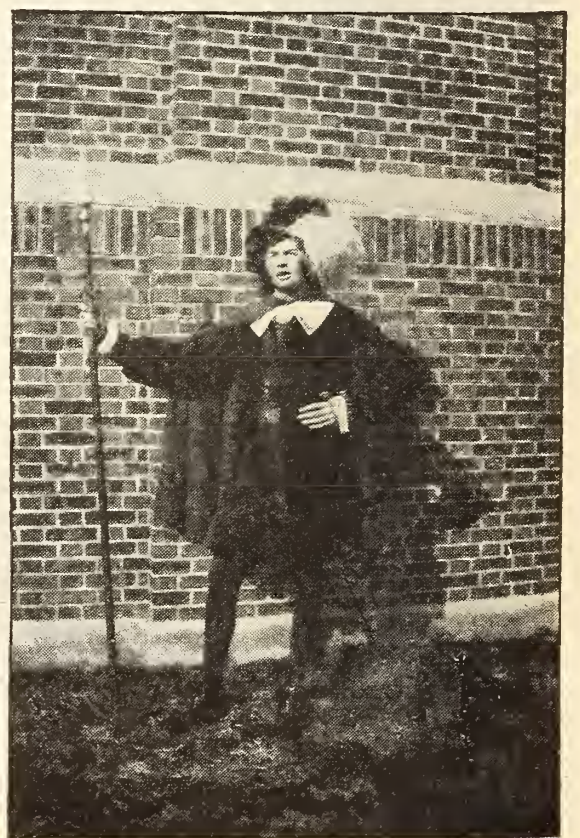

sent from its own talent attractively varied programs of music or lectures, readings or news accounts. It has in its own house the material which many a metropolitan station must beg, borrow, or buy.

A NATURAL ADVANTAGE OF A COLLEGE STATION

COLLEGE stations have listeners. So has any station, of course. But the college station *begins* with a long list of loyal supporters, and has that list to build upon. The list is made up of alumni and former students, of parents and friends of students, and of friends of these friends. The name of the institution is a magic word which, like a gracious introduction, puts host and guest at ease. The station's programs at least enter these homes auspiciously, and if the programs are good they will be ever welcome.

St. Olaf College has a normally large circle of such friends. Because of its nature, an institution supported by a church body with nearly 300,000 adult members, it can count all these church members as persons actively interested in the college

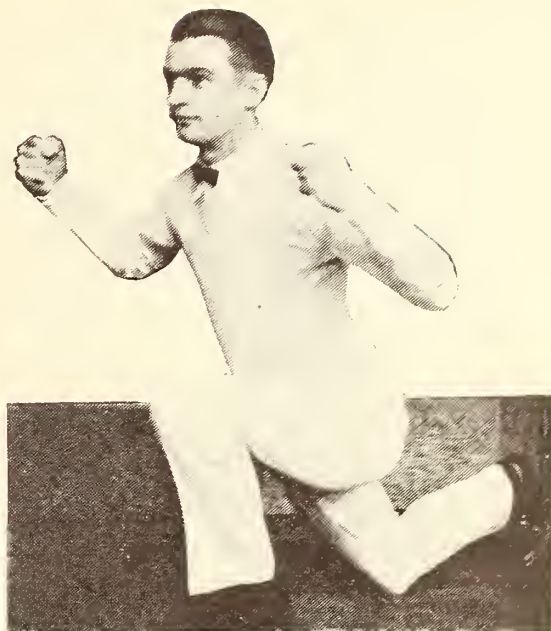

CHEERS BY RADIO

Sam Groth, St. Olaf cheer leader, under whose direction college cheers have been relayed by WCAL



MISS RAGNA OTTERSEN

Whose beautiful soprano voice has given pleasure to thousands of WCAL's listeners. Miss Ottersen was a senior at St. Olaf College during the past year and a member of the Lutheran Choir there

and in its work. It has, too, its hundreds of alumni and former students, whose interest and friendliness is maintained by this modern marvel.

Long after radio broadcasting became established and even commonplace, the newspapers continued to print human-interest items telling how a mother in Louisville heard her daughter singing in Atlanta, of how a girl in Minneapolis spoke by radiophone to her invalid father in Kansas, and so on. At a college station such items could not be made news, for they are not news. They happen daily. Hardly a program but represents a half dozen communities in nearly as many states, each listening eagerly to the voice of its distant citizen. Each week the letters go home: "I am to sing by radio Thursday evening," or "I'll be playing a cornet solo Saturday night," and the telegrams come back: "We heard you singing to-night" and "It sounded as if you were here."

Perhaps this article has failed to discover the real reason for the permanence of college stations—it may lie in the possibilities for research and experiment which a college offers, or it may lie elsewhere. But at any rate it seems fairly certain that these two advantages the college station has: it can furnish a variety of entertainment and instruction, and it is born with friends. Possibly before long, wealthy persons will endow college radio stations as memorials, just as wealthy persons have established memorial halls and memorial scholarships. For the service they render, college broadcasting stations receive nothing in tangible revenue; but they seek nothing. Theirs is distinguished service.

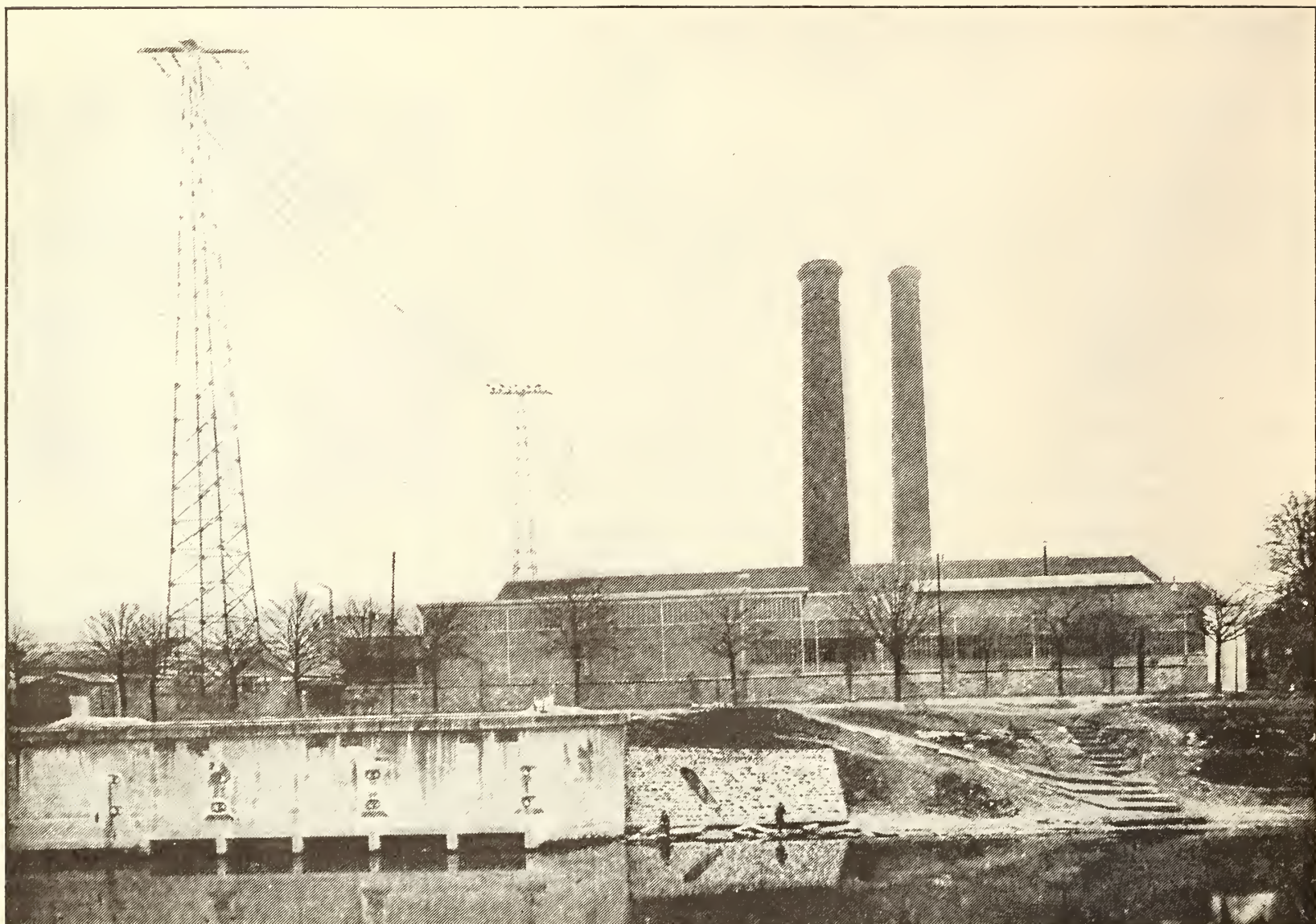

VIEW OF THE "RADIOLA" AERIAL, TAKEN FROM ACROSS THE SEINE  
Showing the factory of the Société Française Radioélectrique

## A Voice from the Banks of the Seine

A Description of Station "Radiola" in Paris, One of the Largest of the Continental Broadcasting Stations

By FREDERIC M. DELANO, JR.

**O**N THE banks of the Seine River, in the suburbs of Levallois-Perret well outside the walls of Paris, is a modern plant, whose engineers work long and hard to develop better methods of radio communication, and whose nightly broadcasts bring pleasure to thousands in France, England, Spain, Italy, Belgium, and perhaps even desolate Russia.

In 1922, when the radio craze was gathering momentum in the United States, and there were more than 400 broadcasting stations in operation, there was not a single broadcasting

plant worthy of the name in France. It is true that as early as November 26, 1921, a popular radio concert was given on the occasion of the Ampere Centenary. A similar affair was staged in June 1921, at a meeting of the Society of Civil Engineers, and another one at the Théâtre des Champs Élysées, in December of the same year. But, it wasn't until the 6th of November, 1922, that radio concerts were sent out on a regular schedule.

The first attempt at radio broadcasting on a daily schedule was made by the Société Française Radioélectrique, and came at a time when



the big broadcasting stations throughout the United States were known by name and call letters to thousands of radio fans. From that time on, the "Radiola" concerts have been exceedingly popular with the newly initiated French radio enthusiasts. In France, you do not refer to broadcasting stations by their calls. They have names, such as "Radiola." Besides, there are only a handful of them, so there is not much trouble in telling them apart—and not much interference! The first transmissions took place on a wavelength of 1850 meters, but owing to interference with the military authorities, this wavelength was later reduced to 1760 meters. It has an advantage over the broadcasting on the lower wavelengths which takes place in the United States, in that there is little or no interference from commercial or amateur sources. Whether this wavelength will be permanent or not is a matter of speculation, for broadcasting is not as yet established on a solid basis in France.

The "Radiola" broadcasting station is even yet a decidedly experimental one, according to the statements made by the men in charge, who

are not willing to give out much information about it until it shall have been proven a permanent installation. The first set with which they worked stands on one side of the room, neatly caged in, to be used only as an emergency or substitute set, in case the second and newer one, on the other side of the room, should get out of order. A third transmitter is being constructed, destined primarily for experimental work, but which may eventually be the permanent one. Furthermore, as soon as possible the whole broadcasting station is to be moved to another and more open location away from the handicap which they are at present experiencing in the many steel and iron structures surrounding them.

The station arrangement is more or less on the same order as many of the American stations: the studio is in the heart of Paris (79, Boulevard Haussmann), far away from the rest of the transmitting apparatus. The singers, musicians, and speakers in the studio therefore talk through the microphone to the Levallois plant over a wire circuit.

The studio director, M. Charpentier, himself

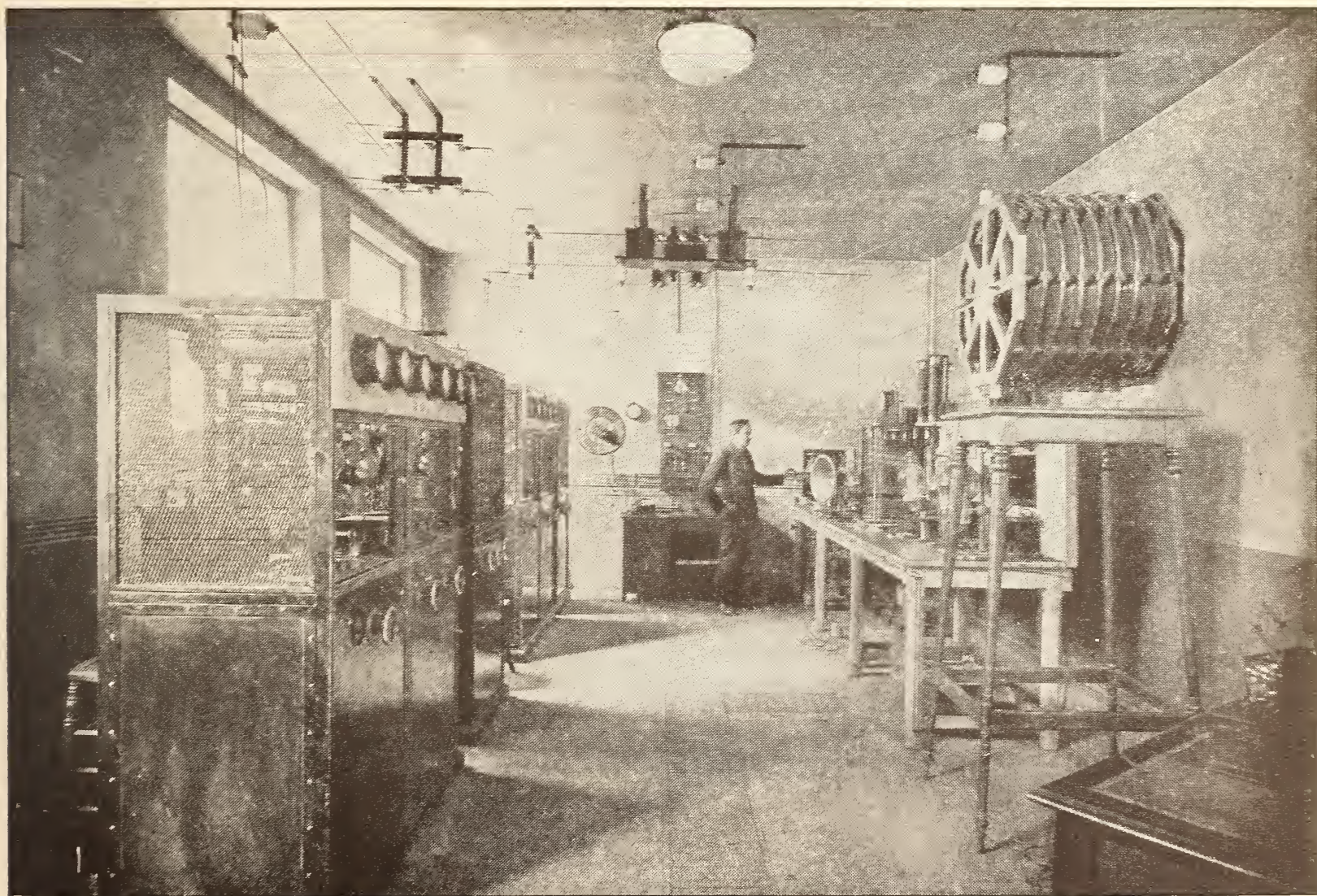

THE BROADCASTING STATION AT LEVALLOIS-PERRET

The set used at present is seen at the right; on the left is the secondary, or emergency apparatus



HIS HIGHNESS, THE MAHARAJAH OF KAPURTHALA  
At the "Radiola" studio, 79 Boulevard Haussmann, Paris

a well-known composer and musician, takes particular interest in devising novel and interesting programs for his invisible audience. He often gets prominent persons to deliver short lectures before his microphone, and shows his guests an autograph book which bears the signatures of Mlle. Suzanne Lenglen, the tennis champion; General Garibaldi, the Italian; Cecile Sorel, the famous French actress who recently visited the United States; the Serbian Ambassador, and many others. The only trouble with the studio, according to Monsieur Charpentier, is that the ceiling is slightly low for the best sound effects. This, however, would be difficult to rectify in the present location as it is situated in the basement of an office building.

Each of the two stations out in Levallois-Perret can be cut in on the concert from the city by means of a switch at one end of the room, whence the music goes to the broadcasting apparatus and leaps out from the antenna to the ears of all who care to adjust their sets and listen-in.

A GROUP OF FRENCH CONCERT ARTISTS AT THE "AUDITORIUM RADIOLA"

This station has not been restricted to French or even Continental talent. People of international prominence from all parts of the globe have from time to time contributed to its programs



# How to Eliminate Interference with a Home-Made Wave-Trap

Complete Instructions for Building an Inductive Wave-Trap and Using It with Your Present Receiver to Cut Out Stations that Ordinarily Cause You Interference

By A. J. HAYNES, Jr.

Vice-President, Haynes-Griffin Radio Service, Inc.

**T**HE increase in the number of broadcasting stations within the last year has created a condition of interference in many of the larger centers, such as New York and Chicago, which is becoming increasingly more troublesome. Owners of radio sets which are generally regarded as extremely selective are finding that near-by or very powerful stations are exercising a blanketing effect upon their receiving apparatus, so that it is next to impossible to hear other stations clearly and distinctly.

Nothing is more irritating to the DX fan who may live within a few city blocks of a powerful broadcasting station than to spend several minutes trying to bring up a very weak station to the point of proper audibility, only to have his powerful neighbor break in and completely blanket his tuning adjustments. As a certain gentleman of color, who was attempting reception under such conditions, once declared, "Intuhference is de one thing we ain't got nothin' else but!"

The radio enthusiast who is fortunate enough to live 100 or so miles from the nearest broadcasting station is not much troubled by interference. At this distance, the natural selectivity of his receiving set is sufficient in itself to separate the various broadcasting stations, and his opportunity of making a selection for several stations is very much better than that of his less fortunate brother who may live in the same city with some powerful station. His opportunity for long distance reception is also considerably better

than is that of the man located close to the broadcasting station, because he does not first have the problem of eliminating the local station, which, because of its proximity, comes in with such power as to preclude the possibility of critical tuning.

Hence this article is written primarily for the radio user who is located close to one or more broadcasting stations. The fan who lives at a good distance from any station at all will not be interested particularly in securing an adjunct to his present receiving set that will help to eliminate interference. If the latter is unable to obtain fair selectivity, he should give thought to the improvement of his receiver itself, or if necessary, replace it with a better one.

## THE NEED FOR A WAVE-TRAP

**P**ROBABLY nowhere in the world is the interference between broadcasting stations so acute as in New York City. At the present time, there are eight active broadcasting sta-

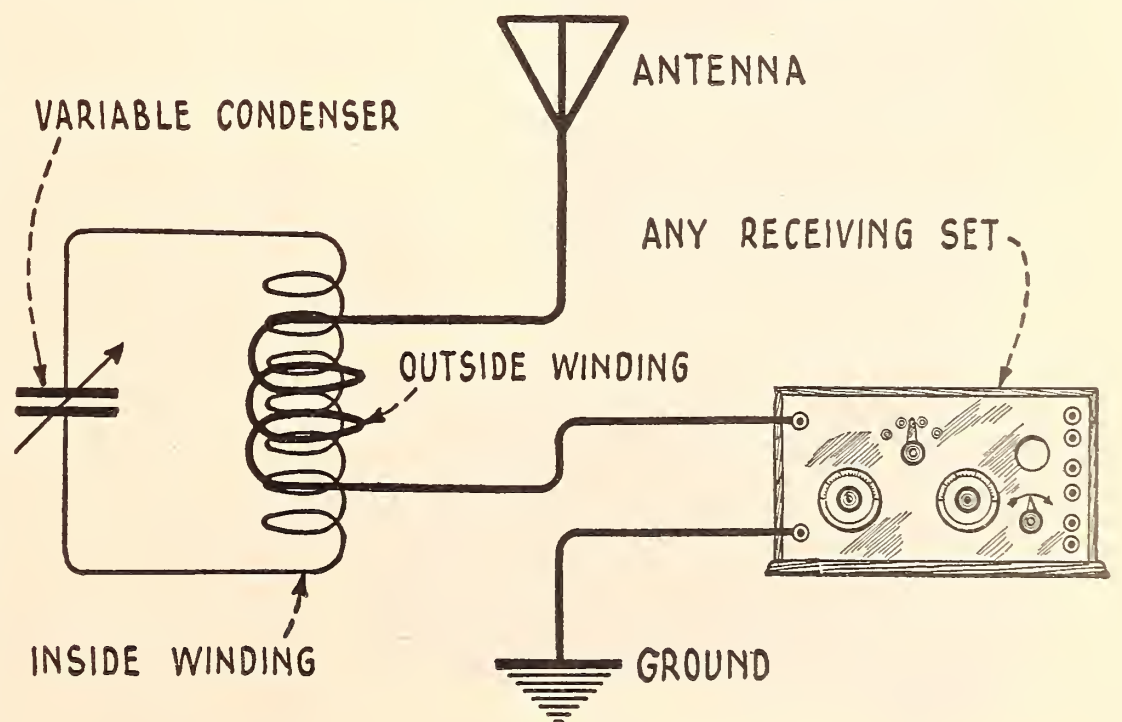

FIG. 1

Schematic diagram of the inductive wave-trap in circuit with the receiving set

tions within the Metropolitan area, with promises of even more in the near future. In the spring of this year, when the new schedule of wavelengths was established, and some of the more important stations were relocated, radio engineers were importuned on every hand for some means by which these various stations could be better separated. "Distance fans" wanted to be able to cut out the local stations entirely so as to reach out to programs from stations in the West and South. This had become an impossibility for those located in the center of the City, very near to stations WJZ and WEA. In fact, in many instances it was found, depending somewhat upon the location of the receiving set, that whenever these powerful stations started to operate, it was practically impossible to eliminate either one or both of them and hear any other station at all clearly.

I had been conducting experiments for some time upon the inductive wave-trap described in this article as offering the most practical solution to the problem; and the acuteness of the situation made it imperative that something be done at once.

#### SOME INTERFERENCE CANNOT BE ELIMINATED

**I**N CONSIDERING interference between broadcasting stations, it is very necessary to know that which can properly be eliminated, and that for which there is, to date, no known remedy. The most common form of inter-

ference which cannot be effectually eliminated is that caused by two stations which are operating on identically the same wavelength bands. This will produce a steady heterodyne note, or whistle, in the headphones whenever this particular wavelength is tuned in. This type of interference can be distinguished by the fact that it can be heard without the receiving set oscillating (contrary to the usual heterodyne beat note), and does not change pitch as the receiver is adjusted. This interference is, of course, the fault of the transmitting stations, and they should be notified of the fact that they are on each other's wavelengths.

#### ADVANTAGES OF THE INDUCTIVE WAVE-TRAP

**W**AVE-TRAPS have been used more or less successfully for years, generally by commercial operators on telegraph signals and later by broadcast listeners. The wave-trap which was in use until somewhat recently, however, was not altogether efficient. It filled the main purpose of trapping out the interfering signal, but at the same time, frequently reduced the signal strength of the station which the operator wished to hear so seriously as to make the remedy of little practical use.

The inductive wave-trap which we are considering is a great improvement over its predecessor, which, in more cases than not, consisted simply of a single coil and variable condenser in series with the antenna. The idea itself is not a new one, although it has never had any great commercial application to radio-telephone reception. Well-built inductive wave-traps overcome the defect which I have mentioned and operate with much greater efficiency on the broadcasting wavelengths than the old style wave-trap. In fact, in many cases where the interfering station is a powerful one, the weak station received through it will be materially strengthened when the wave-trap is set to cut out the former.

#### HOW TO BUILD YOUR OWN WAVE-TRAP

**T**HE inductive type of wave-trap is particularly useful when used as a rejector circuit—that is, in series with the antenna between the lead-in and the set. It consists of a coil of approximately 45 turns of medium-size copper wire, generally wound on a cylindrical form about  $3\frac{1}{2}$  inches in diameter, with a variable condenser of about .0005 mfd. capacity connected across it, the combination forming an oscillating circuit. A second coil of about 10 turns is wound on top of the first winding so

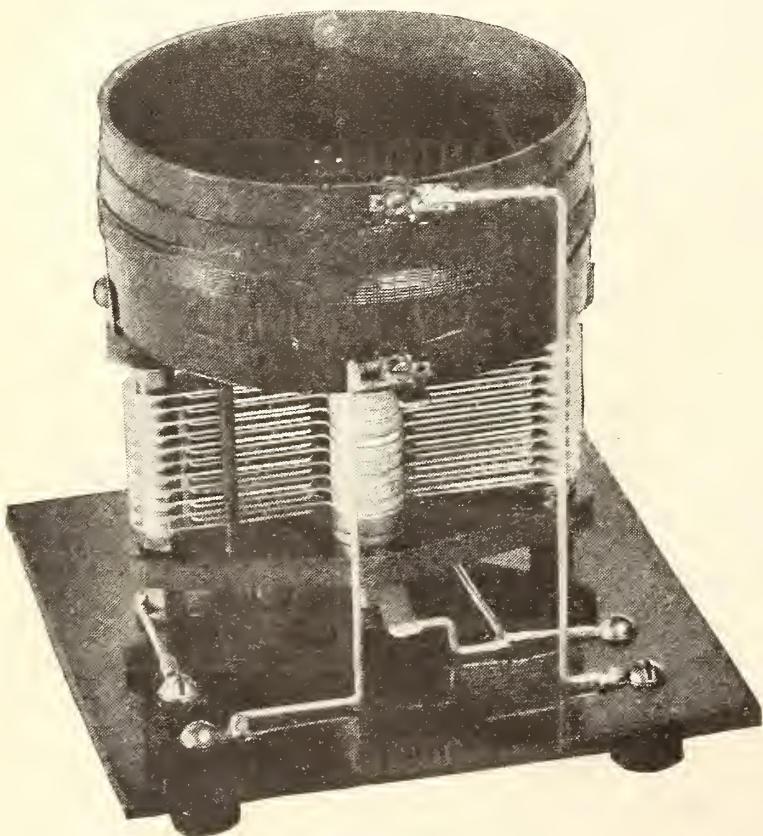

FIG. 2

How the unit looks when assembled

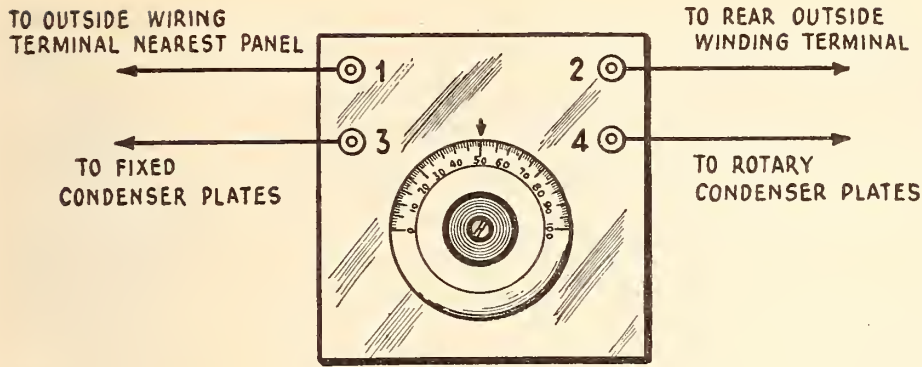

FIG. 3

Showing the panel of the wave-trap and connections that are made to the four binding posts from the wave-trap itself. These four connections are also shown on back of the panel in Fig. 2

as to be in inductive relation to it, but insulated from it. The two circuits are not physically connected in any way. In the usual hook-up for the trap, the outside coil is connected between the antenna lead-in and the receiving set, as in Fig. 1.

With the specifications given, no difficulty should be found in constructing this wave-trap after reference is made to the diagrams. Fig. 2 shows the wave-trap completely assembled before it is mounted in a cabinet, while Fig. 4 is a diagrammatic drawing of the wiring plan and Fig. 3 shows the front panel arrangement.

It will be noted that the wave-trap is designed with four binding posts which allow it to be used in many different ways in various circuits and combinations. The most common and useful hook-up makes use of only binding posts Nos. 1 and 2, either one of these being connected to the antenna lead-in while the other connects to the aerial binding post on the receiving set.

OPERATION

**A**FTER the wave-trap has been constructed, its operation is comparatively simple.

The receiving set should first be tuned approximately to the interfering station which it is desired to eliminate. Then the wave-trap dial should be varied slowly until the signal from the interfering station disappears or is reduced to minimum strength. The dial is then left in this position and the receiving set is retuned to

whatever station it is desired to receive. Unless interfering stations are very close or other unusual conditions obtain, it will generally be found that an interfering station cannot again be found on the tuning dials of the receiving set until the trap has again been adjusted to receive it.

A unit of this kind will usually eliminate but one interfering station at a time. If there is more than one station creating interference, two or more traps may be used in series. By eliminating all local stations successively in this manner, it becomes possible to work through to long distance without local interference of any kind.

AN EMERGENCY AERIAL OR GROUND

**A**NOTHER interesting and often very useful hook-up is as follows:

Connect binding post No. 1 on the trap to aerial binding post on receiving set. Binding post No. 2 is left open or unconnected, binding post No. 3 should be connected to the ground binding post on the receiving set, and the ground wire should be connected to binding post No. 4.

Tuning operations are then done with both the trap and the receiving set. The signal strength when using this hook-up is not as great as is obtained with an ordinary aerial, but in many cases fairly long distance reception can be accomplished. Moreover, static interference is considerably less than when a large aerial is used.

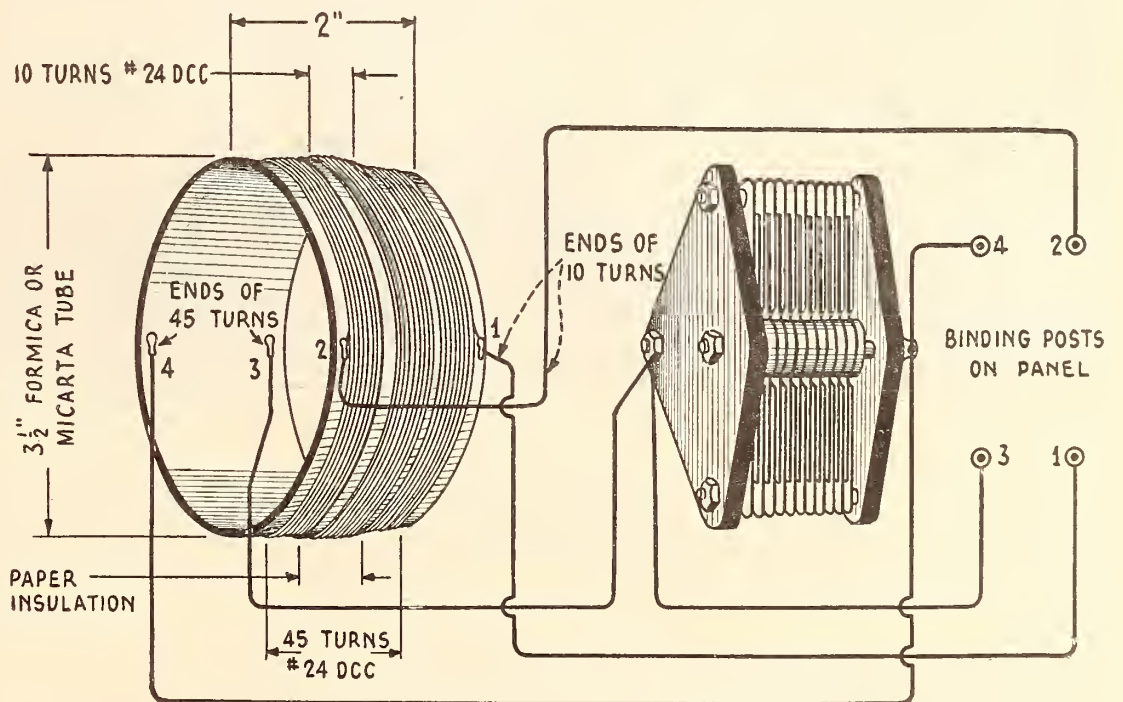

FIG. 4

Wiring plan of the wave-trap

If there is an aerial but no ground available, this same hook-up may be utilized in place of a ground connection by merely connecting the aerial lead-in instead of the ground connection to post No. 4.

#### HINTS TO THE EXPERIMENTER

I WOULD suggest that the coils be wound on a thin bakelite or impregnated cardboard tube. The two windings may be separated by a thin piece of writing paper or empire cloth and a thin coat of shellac may be applied to each winding as it is finished, to hold it in place and to exclude moisture. After each coil is shellacked, it is a good plan to touch a match to

it and let the alcohol burn out. This bakes the shellac into the winding, driving out all of the moisture, and does not burn the insulation. If it is desired, either the finished coil or condenser may be purchased ready to use.

After the condenser and filter coil have been mounted on the panel and the unit completely assembled, it can be fastened in a cabinet by means of small wood screws.

In congested localities, where interference prevails, the wave-trap is certainly an indispensable accessory for perfect reception. It is not only the solution of the interference between local stations, but adds immeasurably to the opportunity for long distance reception.



#### AN EYEFUL GETTING AN EARFUL

When Johnny Hines, having "slipped the cans on," listens enraptured through a phone-cord made of clothes-line, nothing short of Hope Hampton, co-star in "Classics of the Screen," can wrench the observer's fascinated eye away from him



# What Our Readers Write Us



*Wanted: "A Small and Pretty Works"*

SEVERAL months before the earthquake took place in Japan, an incipient radio fan in Tokio sent the following letter to the Atlantic-Pacific Sales Company. Mr. Raymond Travers of that company wrote us: "Not only because he mentions RADIO BROADCAST, but believing this will perhaps give you a smile in a busy day, I am sending it on to you."

SIR:

According to RADIO BROADCAST magazine I have known that wireless telephony have been sold by your store, because I have written to ask about wireless telephony at once. Send radio catalogue and wireless telephony to me as soon as possible if you please. It is usefull works, is it not? I want about \$8 to 20\$, & I should like to know next,

"How miles can we hear, speech with it,

Is there a small & pretty works.

How \$ will it use to send it from your place to here.

Does it sensitive by every a little waves."

Send catalogue to as soon as possible if you please. Then good-bye.

*So Say We All of Us*

PROBABLY most of the broadcast fans who read the following letter will agree with Mr. Barteau's colorful protest against the spark interference that makes many a listener-in sit back from his receiver and think ungentle thoughts. We have long felt the injustice done by the operation of commercial stations on wavelengths near those used for broadcasting, and have published our own protests from time to time, in the hope that the commercial companies would see the advisability of changing the particular length (and breadth) of the waves used by their stations.

MR. ARTHUR H. LYNCH  
Editor, RADIO BROADCAST,  
Garden City, L. I.

MY DEAR MR. LYNCH:

Can you tell me if there is likely to be any relief from this code, now or ever? I can't understand

why such a hullabaloo was made about broadcasting interference when it was of the utmost insignificance compared to the inferno and pandemonium that is caused by the wireless telegraph! There are dozens of 'em hammering away every evening all the time—anything you don't want, from the peep of a sick chicken to the wind whistling through a handful of seaweed; screeching, rasping, gurgling and roaring all combined. Oh, it's wonderful!

Then the fellow that holds the key down indefinitely—he should be murdered in cold blood. A lad did this the other day for 32 minutes. How much longer I don't know, for I gave up to him then. About 90 per cent. of this ship-shore stuff is nothing but "gush"—"Wish you was here, lovely" and such stuff—that could just as well be held up till the morning.

It seems a shame that radio reception must be almost utterly spoiled in this manner, when there is really no need of it. The Army and Navy could move up and make room for these fellows above the broadcasting wavelengths, or the ship-shore stations could keep off for an hour or two in the evening.

I am an old commercial tel. opr., but I didn't make a noise like sandpapering a brick, causing good church-going Christians to spend hours cussing me.

Yours very sincerely,

E. M. BARTEAU

Brookhaven, N. Y.

*An Appreciation of Mr. Seager's Article*

MR. SEAGER, mentioned in the following letter from a Cuban enthusiast who built a set according to his description in the March, 1923, issue, won second place in our "How Far Have You Heard on One Tube?" contest. When you think of it, it is not easy to tell a non-technical reader all that is necessary to enable him to build a comparatively complicated and delicate piece of apparatus, and we are glad to receive letters like this one—as we have on many occasions—indicating plainly the practical benefit of the articles that appear between these covers.

(And let us add here, while on the subject, that we wish everyone who has had either success or failure with apparatus made according to instructions published in RADIO BROADCAST,

would drop us a line and tell us the what, the why, and the how of it.)

MR. ARTHUR H. LYNCH, *Editor*,  
RADIO BROADCAST,  
Doubleday, Page & Co.,  
Garden City, N. Y., U.S.A.

DEAR SIR:

I want to congratulate Mr. E. V. Seager on the explanation he gives, in the March issue, of his inimitable set; and I also want to thank RADIO BROADCAST for its splendid diagrams and circuits upon which anybody can depend entirely.

I have been reading RADIO BROADCAST for the past three months and enjoy its explanations on constructing sets made with the least effort and most efficiency, but Mr. Seager's explanation of how to make and operate a Practical Long-Range, Single-Tube Receiver is wonderfully complete and clear and easy, because after one reads it, one can have no doubt whatever; there is no question to be asked; there is no detail omitted.

I have made a receiver exactly as he described and last Sunday night at about ten o'clock, Havana time, we heard Memphis Electric Company, Memphis, Tenn., but it soon died out and I could never locate it again. Friday night, we heard WGY, Schenectady, N. Y. very clearly; we got in on the end of the program, heard three or four numbers, and heard them signing off at 11:55 Schenectady time, as the announcer said (10:25 Havana Time.)

Assuring you that I think RADIO BROADCAST is filling a splendid mission, I remain,

Very truly yours,

JOSE MANUEL PONCE DE LEON.

Calle Concordia 30, altos  
Havana, Cuba.

*We Have the Most—Let's Have the Best*

*Editor*, RADIO BROADCAST,  
Doubleday, Page & Co.,  
Garden City, Long Island.

DEAR SIR:

No one who listens-in consistently can fail to realize the enormous force that broadcasting will one day become. I can see in it the vision of the greatest institution of learning that can be conceived, the eventual broadcasting of definite courses of education that must inevitably supersede the hodge-podge of lectures and talks now being given. Even to-day the air carries knowledge and information—which is education—that is being injected into countless minds in the guise of entertainment, as for instance the description of musical works given by the announcer during the more important concerts. It is probable that at the beginning of broadcasting the majority of listeners did not know the difference between a sonata and a fugue; but by now they cannot

help but have acquired some appreciation of music and understanding of many musical terms.

The possibilities are vast, and it is to be hoped that there will be little delay in their realization. One of the advantages of seeing the climax of a movement while it is yet young is that stumbling blocks can be recognized and cleared away; it seems to me, therefore, that any one who has a vision of the possibilities of broadcasting, and an idea for its improvement and development, should come out with it, that it may be estimated and discussed. May I suggest that you create such a symposium?

I should like to call attention to a detail; a minor one, it is true, but one with a psychological bearing that gives it importance. This is the need for selecting educated minds for the announcers, who are listened to with close attention. If broadcasting is to be educational, an announcer should use cultivated language; his pronunciation and grammar should be correct, the tones of his voice those of education and culture. At the present, this is far from being the case, and in consequence, untold numbers of listeners are being led astray in matters of pronunciation, grammar, and the correct use of our language. No one, I think, questions the impression that is made by a cultured voice; its very tones are an indication of a background of education and refinement. Such is the voice that should be most frequently heard by the radio audiences, for it would be a continual example of an ideal toward which the average man and woman might well strive. Do not let them hear a slip in grammar, a fault in diction, or a mispronunciation, be it of an English word or the name of a foreign composer. Unquestionably, the announcer is a teacher. Let him teach correctly.

For understandable broadcasting, the timbre and quality of the voice is of an importance that we all appreciate. Clarity is in part distinct enunciation, of course, but the voice quality is an element that seems to me to merit particular attention. Some voices carry, and are easily understandable, while others are just the reverse. It would be interesting to have one of the broadcasting stations make a test of a number of speaking voices of various qualities to determine by the reports of the listeners which had the best reception. This would lead to a recognition of the desirable qualities, and to their cultivation.

For another point, I think that there should be no interval in a program, even that of the customary "One minute, please," when the station is silent. I recommend that each station adopt a distinctive low-toned sound maker, be it a series of bells, plucked harp strings, or any pleasing sound, that would be switched on to bridge an interval, as an indication to the listener that he "had" the station. This would assure a continuity that at present is lacking, and that is likely to be disconcerting.

All of which is submitted for your consideration.

JAMES OLIVER.



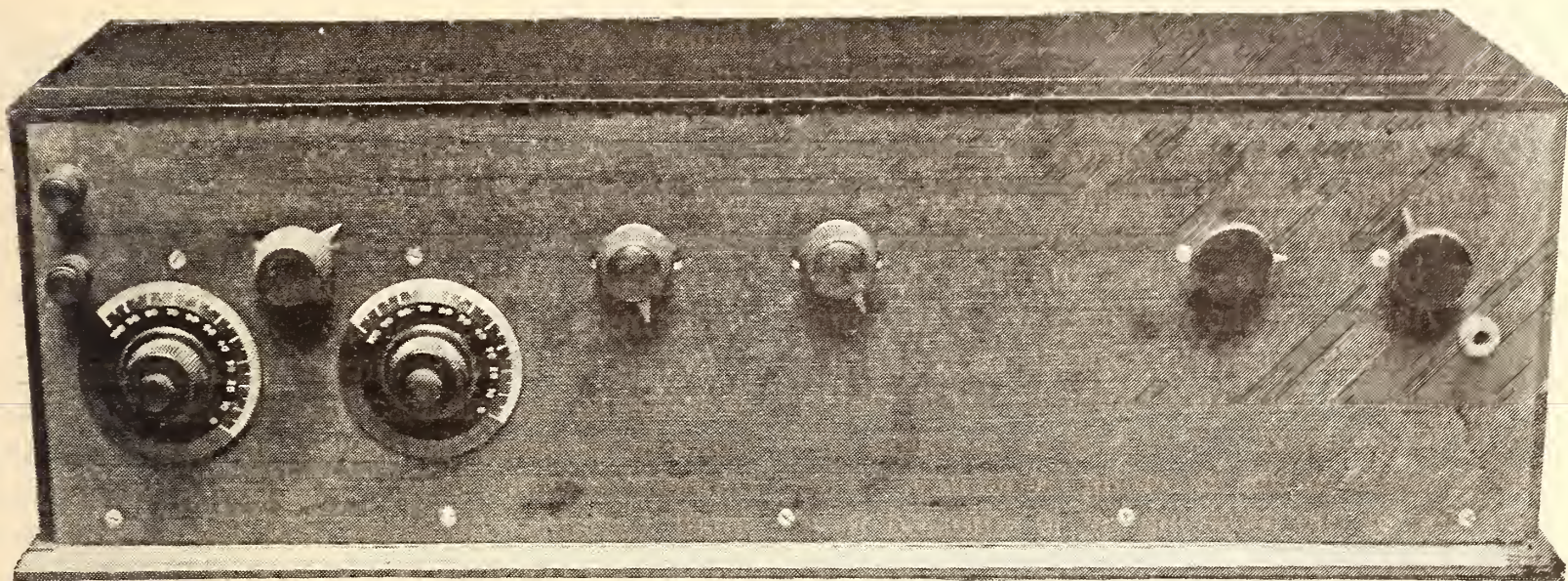

MR. ELTZ'S SEVEN-TUBE SUPER-HETERODYNE

It has but two tuning controls. The simplicity of operation of a set of this type is sure to make it increasingly popular

# How to Build a Super-Heterodyne Receiver\*



By GEORGE J. ELTZ, Jr.



The value of the super-heterodyne receiver has been better appreciated by the Radio Club of America than in most other circles. One reason for this may be that Edwin H. Armstrong, inventor of the super-heterodyne, is a member of the Club. Mr. Eltz has been an enthusiastic supporter of this wonder circuit since Armstrong introduced it, and in this paper he describes a receiver incorporating several recent improvements.—THE EDITOR.

**T**HE super-heterodyne, or double-detector receiver, is now a practical piece of apparatus for use by the radio amateur and broadcast listener. To date there has been developed no other circuit which is either as selective or as sensitive. The chief drawback in the operation of this circuit has been that vacuum tubes as manufactured in the past required filament currents of about one ampere each. This high filament current necessitated the use of large batteries, making the operation of the super-heterodyne too expensive a luxury for many fans. But the new vacuum tubes, with low filament consumption, bring this type of receiver within the reach of many more of us.

A super-heterodyne may be constructed with practically any type of vacuum tube on

the market to-day. Best results can probably be obtained by using the UV-201-A (C-301-A). Good results, however, can be had with the UV-199, WD-11 and WD-12 tubes.

Before going into the actual construction of the super-heterodyne, it will, perhaps, be well to consider just what happens in the circuit. It was developed by Major E. H. Armstrong, at a time when high-frequency, radio-frequency transformers were unknown. Practically the only method of radio-frequency amplification in successful use at that time was amplification by means of resistance coupling between the stages. The amplification obtained per tube by this method at high frequencies was extremely low, a voltage amplification of three or four per tube being exceptionally good. At low frequencies, however, that is, in the order of 50,000 cycles or a wavelength of 6,000 meters, amplification of a considerably higher value, perhaps as high as 6 or 7, could be obtained.

In brief, its action is as follows: the fre-

\* For other articles dealing with the super-heterodyne, see "A Super-Sensitive Long-Range Receiver," by Paul F. Godley in RADIO BROADCAST for February, 1923, and "A Practical Super-Heterodyne with 199's," by Walter Van B. Roberts in RADIO BROADCAST for August, 1923.

quency which enters the loop or antenna as the case may be, is, we will say, of the order of 1,000,000 cycles, equivalent to 300 meters. This frequency is modulated by the radio transmitting station, whether telephone or telegraph, and is detected at the receiving station by the tube called the first detector tube. As part of the receiving set, a vacuum-tube oscillator is set up capable of producing frequencies of the same order as those which are to be received. The loop or antenna circuit is tuned to the incoming frequency. The oscillator in the receiving set is adjusted to a point 50,000 cycles above or below the incoming frequency. The result is a beat-note, between the incoming frequency and the frequency in the set, of 50,000 cycles. This beat-note is modulated in exact accordance with the incoming frequencies. All this action occurs in the first detector tube.

The output of the plate circuit of the first detector tube is then fed into the primary of a radio-frequency transformer designed for best operation at frequencies of about 50,000 cycles or 6,000 meters. The voltage amplification obtained at this frequency by means of transformers is high, perhaps as high as 12 or 14. After running through a number of radio-frequency transformers of this character, and their vacuum tubes, the frequency is then impressed on a circuit tuned sharply for 50,000 cycles. In this circuit, the higher frequencies which may have passed the amplifying trans-

formers are eliminated and a coil connected with the tuned circuit impresses on the grid of the second detector tube, nothing but the 50,000-cycle modulated beat-note. This beat-note is detected by a second detector tube, the plate circuit of which supplies the power for operating a telephone headset, loud speaker, or audio-frequency amplifier.

In Fig. 1 is shown a circuit which corresponds in action to the one described above. Here the super-heterodyne is shown in operation in connection with a loop. The loop is tuned by a small variable condenser and the output impressed on the grid of the first detector tube. The transformers used for the amplification of 50,000 cycles, or as it is commonly called the intermediate-frequency amplifier, are the familiar Radio Corporation UV-1716 transformers. They are extremely efficient at a frequency of 47,500 cycles, which is the frequency used in the circuit shown in Fig. 1. Three of these transformers are used before the second detector. The "special transformer" consists of an air-core transformer, having a primary consisting of 200 turns of No. 29 double silk-covered wire, wound on a 1" wood or bakelite core and a secondary wound immediately on top of the primary of 1500 turns of No. 36 double silk-covered wire. The length of the core is  $\frac{1}{4}$ ", the outside diameter of the combination being approximately 3". No particular care need be taken in winding this transformer. It is important, however, that approximately

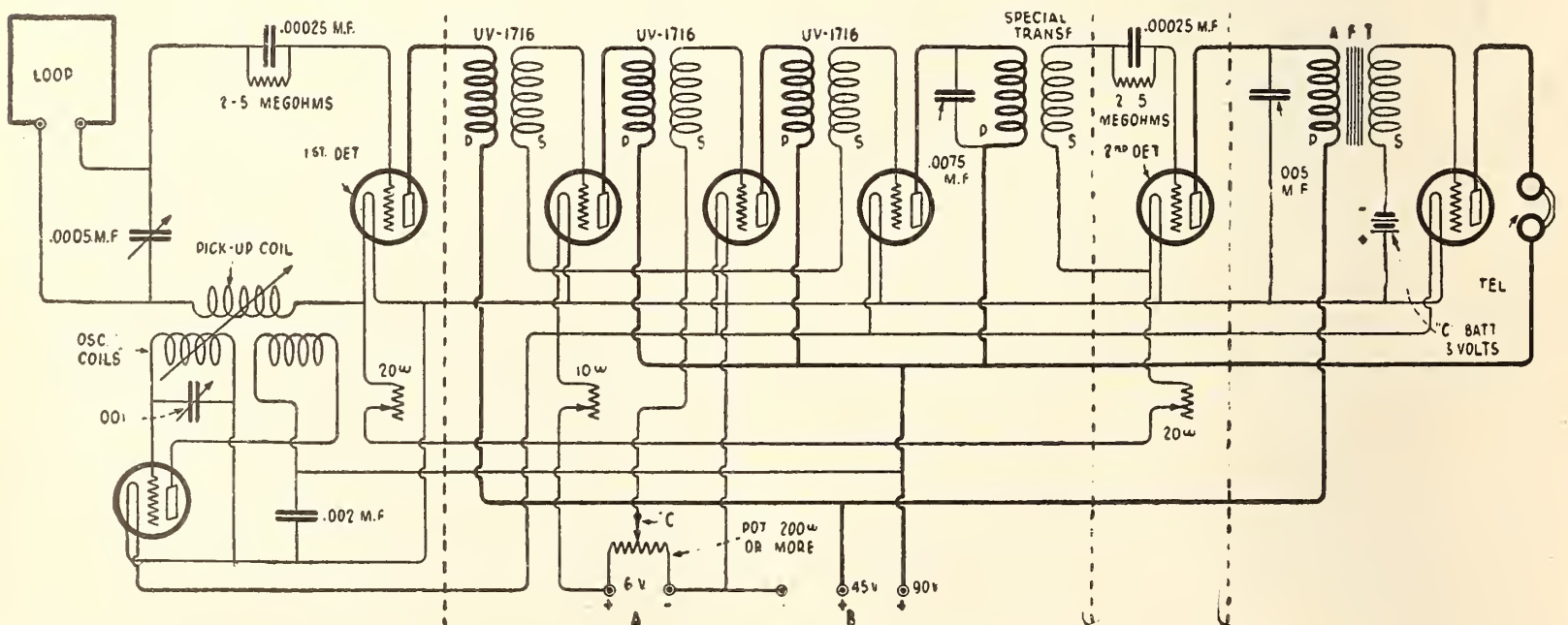

FIG. 1

The dotted lines indicate the four sections into which we may divide this super-heterodyne circuit to make it more easily understandable. In the first section (from the left) we have the wave-changing unit, then the intermediate-frequency amplifier, then the detector and finally the A. F. amplifier. For experimental purposes, it may be found advisable to arrange the super-heterodyne in separate cabinets provided with binding posts for connecting them together. By this arrangement, various combinations may be tried with very little difficulty

the correct number of turns be used. Across the primary of this transformer is placed a fixed mica condenser of .0075 mfd. capacity. This condenser, in combination with the primary and secondary, fixes the frequency at 47,000 cycles, which is a particularly efficient point for amplification with the UV-1716 transformers. Between the plate of the second detector tube and the negative side of the filament, is connected a small condenser of .005 mfd. capacity, which acts as a by-pass condenser, preventing the leakage of any of the 50,000-cycle current into the audio-frequency amplifier.

#### BUILDING THE OSCILLATOR

THE oscillator shown at the lower left-hand corner of the diagram may be constructed of two honeycomb coils, a 35-turn coil being used in the grid circuit and a 25-turn coil in the plate circuit, or it may consist of the same number of turns wound on a Bakelite tube 3" in outside diameter. The small coil shown coupled to the grid coil of the oscillator marked "pick-up coil" should consist of 30 turns of No. 36 double silk-covered wire wound on a form 1" in diameter,  $1\frac{1}{4}$ " long. This coil should be capable of rotation to vary the coupling with the grid coil. Once set, this adjustment need not be changed except when vacuum tubes are changed. Only three rheostats are necessary, and if desired the number may be reduced to one, although when this is done the detector tubes cannot be operated quite as effectively. In the set shown in the photographs, four rheostats are used, one of which controls the filament current of the oscillator. This is not absolutely necessary since the amount of pick-up voltage can be readily controlled by means of the pick-up coil.

#### THE COMPLETED CIRCUIT

THE circuit given in Fig. 1 is one which has proved to be simple to operate, extremely selective, and very sensitive. The sensitivity of a super-heterodyne circuit of this type is far ahead of any other receiver even though the same number of tubes are used. The selectivity is not approached by any other receiver. With a receiver of this type it is possible to receive distant stations while local stations no matter of what power are operating. This high degree of selectivity is obtained due to the fact that not only is the inherent selectivity of the loop part of the super-heterodyne,

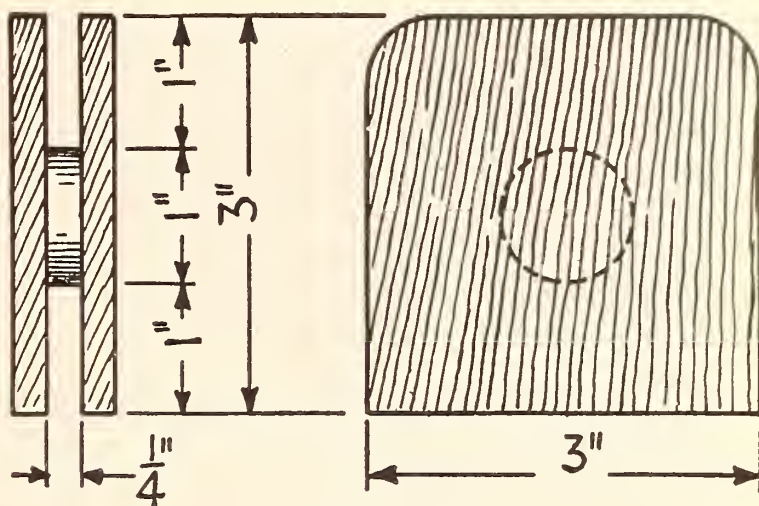

FIG. 2

This special transformer is used to couple the last R. F. tube to Detector Tube No. 2 in Fig. 1, and provides a sharp resonant point for the radio-frequency circuit. The walls of this transformer may be made of bakelite or hard rubber. The primary is wound with 200 turns of No. 29 D. S. C. and is separated from the secondary, which has 1500 turns of No. 36 D. S. C., by several layers of empire cloth

but also because the beat-note between the incoming frequency and the local oscillator must be exactly obtained or it will not pass the transformers and the tuned circuit before the second detector. In order to insure high selectivity, one precaution must be taken. Unlike other radio amplifier circuits no regeneration is obtained in the loop circuit. This being the case, the resistance of the loop circuit must be made as low as possible. Loops wound with Litzendraht wire, and condensers of very low resistance, must be used. Regeneration to a certain extent will be obtained in the intermediate circuit amplifier, although if much regeneration is present some distortion is apt to occur.

#### SHIELDING

FOR a set of this character to operate properly it must be carefully shielded. This precaution must particularly be taken with the intermediate-frequency amplifier, because the amplification obtained per stage is extremely high, and the intermediate-frequency amplifier is apt to oscillate unless properly shielded. If oscillation occurs, of course, no amplification is possible. If the receiver is built with the circuit of Fig. 1, it should be possible to make the grid of the intermediate-frequency amplifier tubes at least  $4\frac{1}{2}$  volts negative without oscillation occurring. If this condition can be obtained, the amplifier is working properly. A small C battery should be inserted at the point marked "C", if the potentiometer does not supply sufficient negative C voltage to

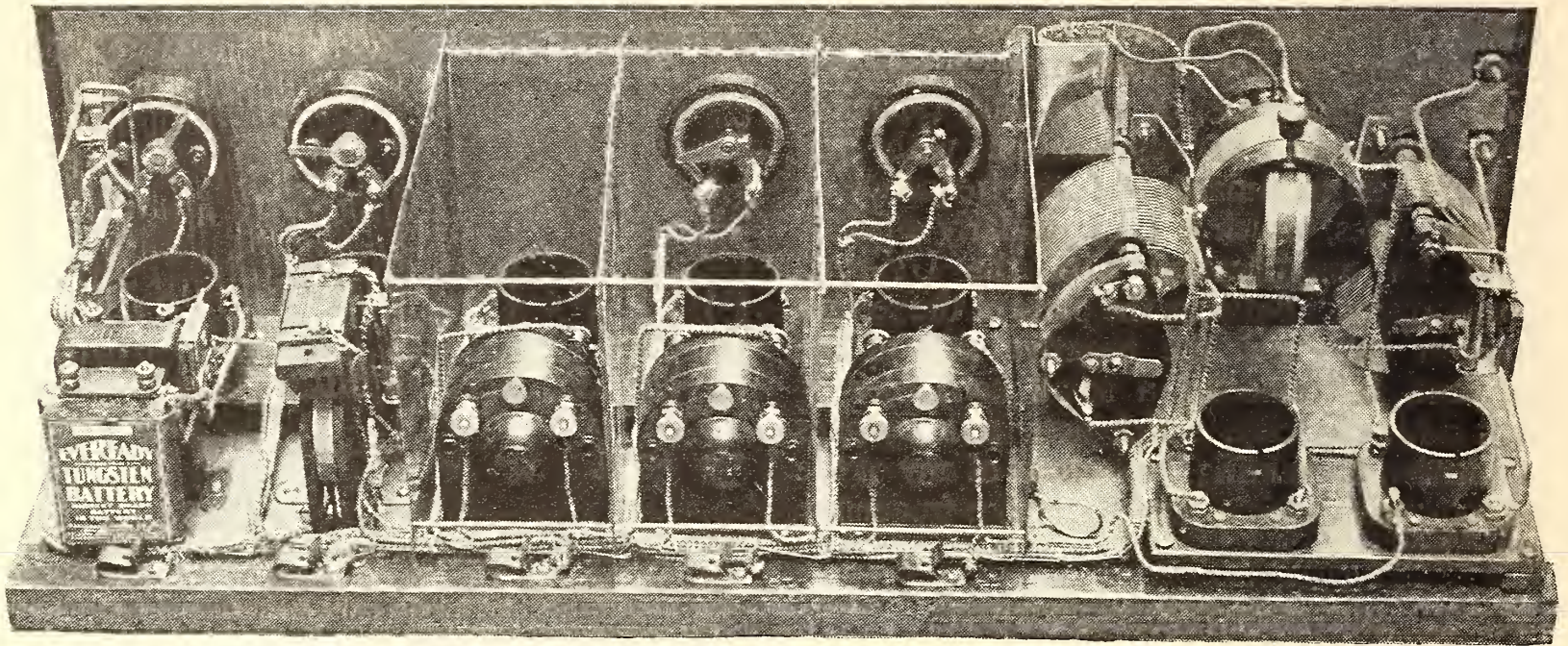

REAR VIEW, SHOWING METAL SHIELDING ENCLOSING THE INTERMEDIATE-FREQUENCY STAGES

The layout may seem a bit complex, but none of the four parts which it comprises—wave-changer, I. F. amplifier, detector, A. F. amplifier—is particularly difficult to build. The circuit diagram, Fig. 1, shows clearly this division into parts

approach a point of oscillation. The values of A and B battery will, of course, depend on the vacuum tubes used. Fig. 1 gives the value for UV-201-A tubes.

#### WHAT THE RECEIVER WILL DO

WITH a super-heterodyne of this character it should be possible to obtain loud speaker operation on any good broadcasting station over a distance of at least 1500 miles under any condition. Under good conditions the Pacific Coast stations have been heard in New York City on a loop 21 inches square. Signals were of sufficient intensity to operate a loud speaker with enough volume to be heard over a room of moderate size. If desired, another UV-1716 transformer may be added to the intermediate-frequency amplifier. If this is done, additional care should be taken to see that the intermediate-frequency amplifier is most carefully shielded, otherwise the added amplification will be lost due to the feed-back through the wires of the set.

#### METHOD OF WIRING

IN THE photograph above, the wires used for connecting the filaments and the wires bringing the B battery voltage to the transformers, detectors, oscillator, etc., are shown combined in a single cable laced together and shellacked. This method of wiring is simple, neat, and introduces no losses into the circuit.

It is particularly convenient when shielding is used as it eliminates a great deal of the cutting and drilling of the shields which would be necessary if bus-bar wiring were used. The wires leading from the grid and plate of the vacuum tubes to the transformers should not be placed in the cable. These wires must be run separately, or a considerable loss will result. The UV-1716 transformers should be connected with the terminals marked 3 on both the primary and secondary to the plate and grid circuits of the tubes in question. The terminal marked 1 is nearest the core. The terminal marked 3 is the outside terminal of both the primary and secondary winding and has the highest induced voltage. The wires leading to and from the grid and plate of the oscillator and oscillating coils should not be cabled. The small .002 mfd. condenser used in connection with the oscillator is for the purpose of grounding any oscillator frequency which may tend to go back through the cabled wires.

The tuning of the super-heterodyne is at first more or less difficult, particularly when it is desired to pick up stations whose wavelengths are not exactly known. Both condensers should be operated at the same time, with the dial readings approximately the same, the object being to keep a uniform space of 50,000 cycles between the two condensers. With a little care and experience this can be readily learned and the great advantage of selectivity obtained.

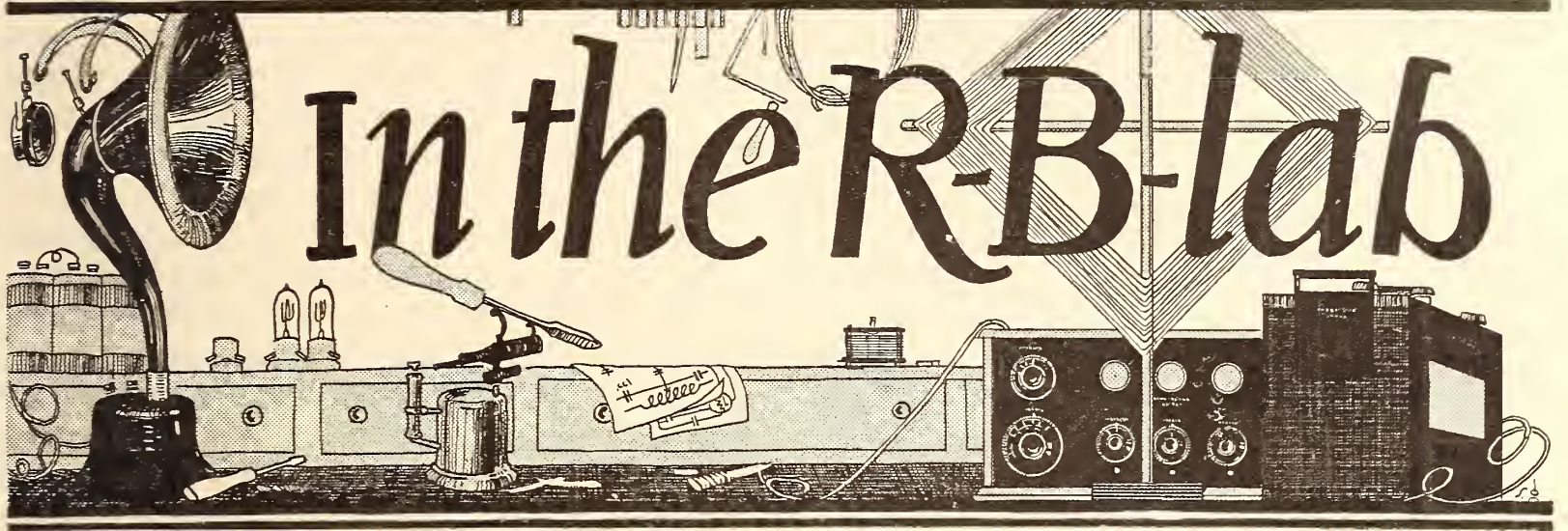

The "Lab" department has been inaugurated by RADIO BROADCAST in order that its readers may benefit from the many experiments which are necessarily carried on by the makers of this magazine in their endeavors to publish only "fact articles" backed by their personal observations.

Under this heading will be published practical pointers, brief write-ups of interesting experiments, additions to and improvements on previously published circuits—in short, anything of genuine value and interest to the reader, which, due to the brevity with which it can be covered, does not justify a special article.

RADIO BROADCAST will be pleased to buy from its readers, at prices from three to five dollars, commensurate with the value of the data, kinks, devices, original ideas, etc., with photographs if possible, which the Editor may consider eligible for this department.

Address all communications to the R. B. Lab Editor.

## REBUILDING YOUR CHARGER

(Suggested by HENRY G. MULLER, Radio 2BH)

**I**NEFFICIENCY, noise, and a low charging rate are among the defects inseparable from some of the commercial bulb rectifiers used for the home charging of batteries. A satisfactory rectifier should eliminate all avoidable losses, be silent, and deliver a current in the neighborhood of nine amperes. Practice indicates that the average tube and battery are not injured by so high a charge, and as this secondary current can be secured from the conventional charger without increasing the input (by increasing efficiency, i. e., eliminating losses) the result is a quicker, more satisfactory charge at less cost.

The principal object in re-mounting is to eliminate the iron box and frame in which

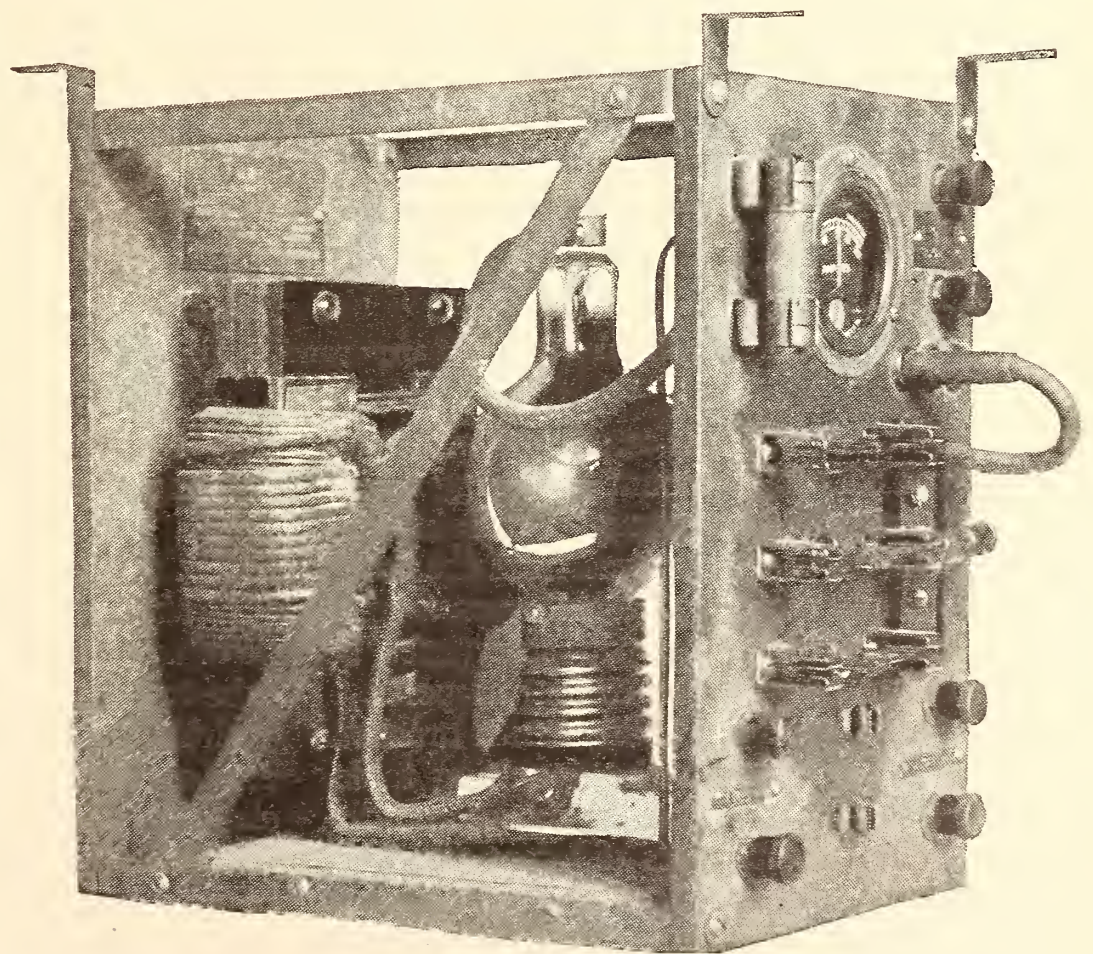

FIG. 1

The rebuilt charger, furnished with brackets for mounting it out of the way beneath the operating table

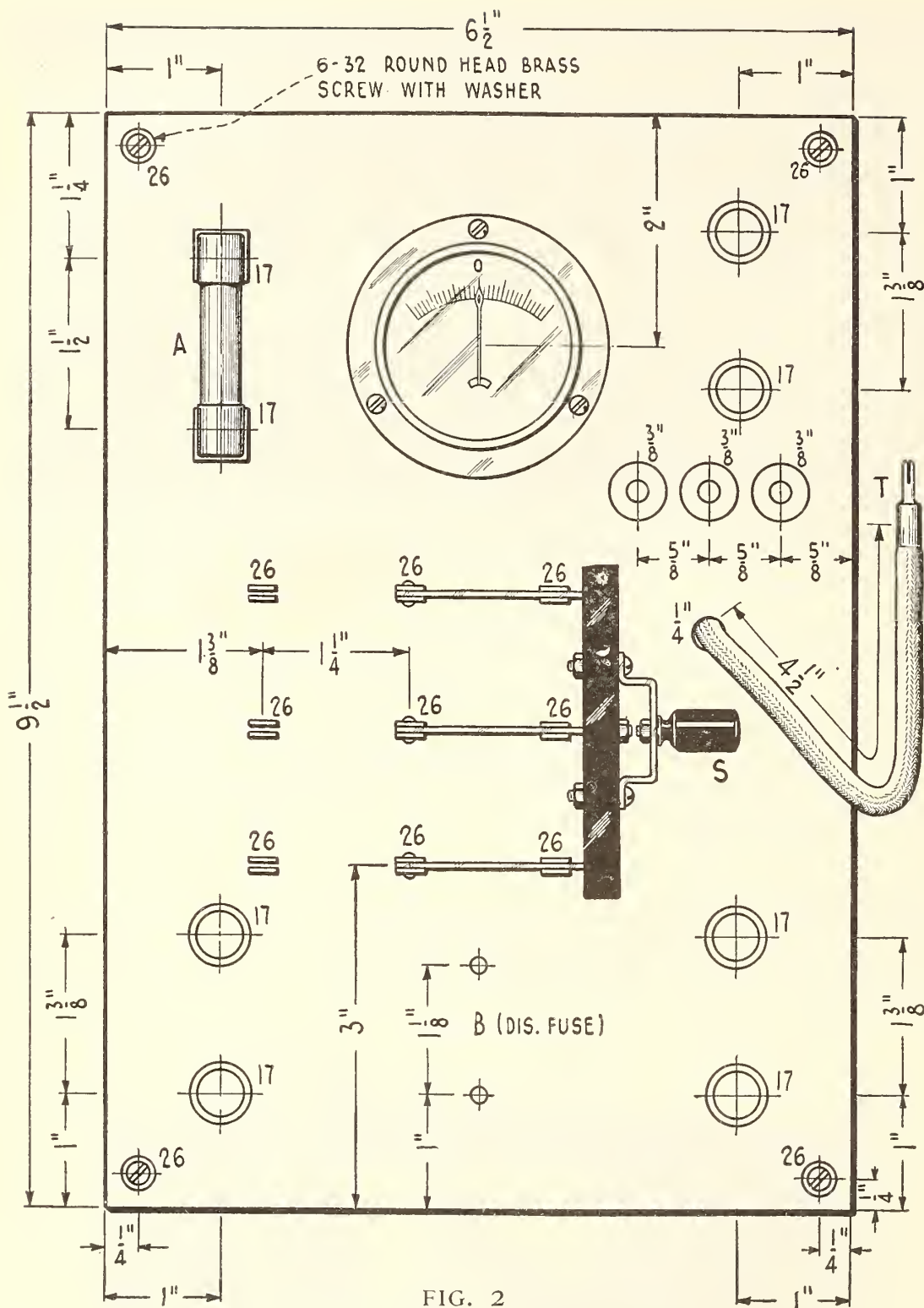

FIG. 2  
A working drawing for the charger panel

the commercial rectifier is cased, and which absorbs a considerable amount of energy which would otherwise be spent as useful charging current. If the parts are removed from the metal box, and simply connected together on a baseboard, the charging rate will sometimes be found to have jumped two to four amperes.

Fig. 1 shows a rebuilt charger with brackets for mounting it beneath the operating table. Separate fuses are provided for charge and discharge. The plug permits different charging rates, and the functioning of the apparatus is controlled by the triple-pole-double-throw switch, one side connecting the battery for discharge through the tubes, and the other starting the charger and throwing the battery

in the rectifier circuit. The meter reads both charge and discharge up to fifteen amperes, and is the type mounted on automobile instrument boards.

Mr. Muller, owner of amateur station 2BH, in order to obtain an adjustable charging rate has tapped the primary (or rather that part of the single coil acting as primary) of the auto-transformer with which his rectifier was equipped, at thirty and sixty turns on the thin wire side, bringing leads from these taps and from the upper end of the winding to the home-made jacks on the right of the panel. The jacks were made from  $\frac{3}{8}$ " round-head machine screws about  $1\frac{1}{2}$ " long. The heads were turned straight, leaving a flange, and drilled with a number eleven drill. These jacks take the plug T (Fig. 2) which was made from a De Forest honeycomb plug. An ordinary switch lever with conventional contact points may be substituted for the plug and jack arrangement; however, as the adjustable winding is not necessary (in some cases it is even undesirable), the switch or plug

may be dispensed with, and the transformer winding connected directly across the 110-volt line.

Fig. 2 is a working drawing for the panel of Mr. Muller's charger. The panel itself may be of any convenient material such as bakelite, asbestos, slate, or wood—the last being the least desirable. The switch, fuses, clips, mountings, etc., may all be purchased from a well stocked electrical supply house. The numerals near the indicated holes designate the size drills to be used in boring them. A three-pole-double-throw switch on a porcelain base should be procured and demounted, the base being used as a template for marking the required holes on the panel.

Fig. 3 shows the rear of panel connections for a rectifier of the Tungar type. X leads to the large wire end of the winding, and jacks 1, 2, and 3 to the taps. Throwing the switch to the left places the battery on charge, and to the right, on discharge. Fuse A (charge) should blow at ten amperes, and B (discharge) at five amperes.

The rear connections for all types of transformers will not be the same, and the circuit should be carefully traced, and the panel diagram (Fig. 3) altered if necessary, before the set is demounted from its original container and base.

The transformer is mounted on the rear panel, which is the same size as the switchboard, by bolts passing through the core and the panel. The bolts should be about four inches long so that by means of three nuts the transformer may be held away from the panel. The front and rear panels are separated by eight inches of angle brass (eliminate iron as far as possible from the

construction) with one diagonal brace on each side. The constructional details are suggested in Fig. 1, which also shows the socket with bulb mounted on a wooden base. Nothing smaller than No. 10 wire should be used in making the secondary connections of the charger, and No. 8 is advisable in wiring the socket.

The R. B. LAB will be pleased to adapt any circuit, which may puzzle our readers, to the panel in Fig. 2, and this department plans, for next month, an easily wound transformer, and hook-up designed especially for this panel, enabling the experimenter to build a complete and superior charging unit for much less than the cost of the standard instrument.

### A CONDENSER SWEEPER

(Suggested by KARL R. LESH)

**D**UST (as well as pieces of solder and stray bits of insulation, etc.) accumulates very quickly between the plates of variable condensers, and aside from the annoyance which the knowledge of its existence gives, it has several undesirable electrical effects. It increases the dielectric loss, reducing the efficiency of the apparatus, and under certain meteorological conditions the tiny particles accumulate static charges, which, in discharging, add to the sounds caused by the prevailing atmospheric disturbances. In low-power bulb transmitters, where receiving variable condensers are often shunted across high potentials, an accumulation of dust often leads to the breakdown of the condenser.

But enough! The dust is there; it and other accumulations can be swept away by a pipe cleaner (the kind sold in cigar stores at five cents a package) inserted between the plates.

### A CONVENIENT HEAD-PHONE HOLDER

By EDWARD T. JONES

**W**HENEVER there are more persons present than head-sets, making it necessary for someone in the crowd to wait his turn to listen-in to the concerts, someone

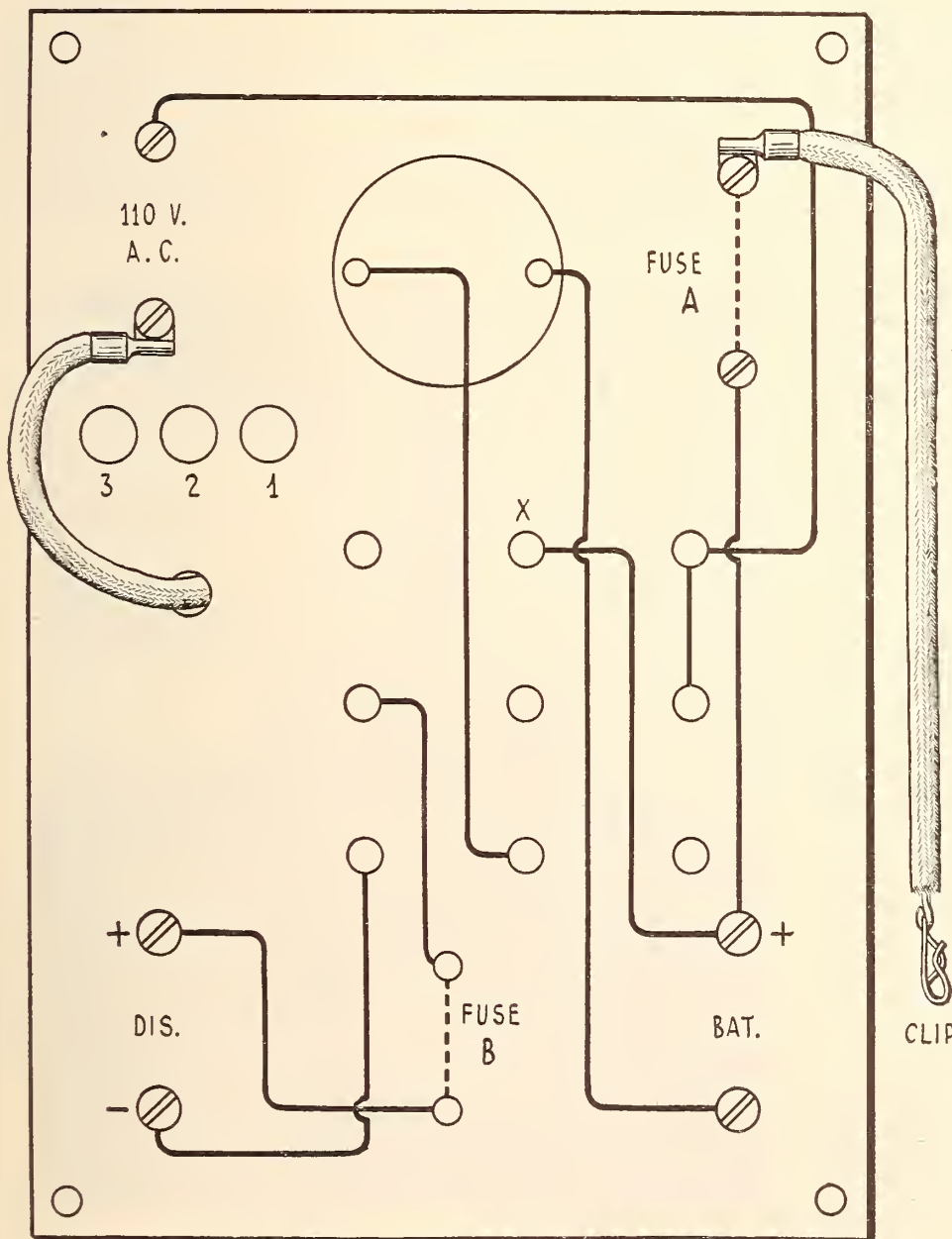

FIG. 3  
Rear view of the panel

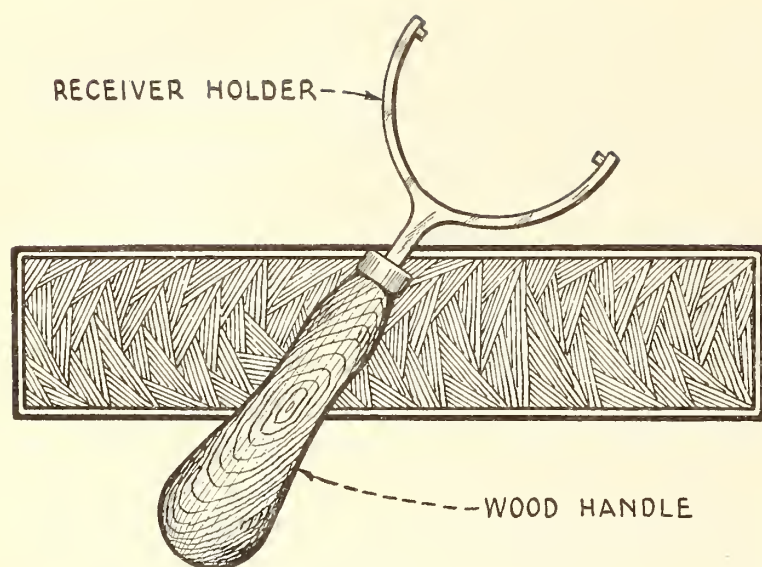

FIG. 4

will remove a receiver from his head-band and lend it to his neighbor.

This arrangement is satisfactory as far as it goes. However, if the set is of the regenerative type, and no amplifier is being employed, the set will be put out of operation by detuning as soon as the listener touches the metal backs or tips of the receivers.

It is also very tedious to hold the single receiver to the ear, grasping it in the awkward hold which its shape imposes.

Taking the above into consideration, I was prompted to devise a holder for the receiver, and evolved the device shown in Fig. 4. The wooden handle was purchased at a five and ten cent store, and the piece which clamps the receiver was taken from an old Baldwin head-band.

It is easily constructed, and costs but a few cents.

### BUILDING THE LABORATORY

THE LAB'S suggestion for this month's acquisition to the budding laboratory is a hydrometer and a crystal detector. The former will cost from seventy-five cents to a dollar, and its most convenient form is that shown in Fig. 5. This consists of a large, syringe-like glass tube and bulb, with a few inches of rubber pipe for drawing up a quantity of the electrolyte from the storage battery. Within the large tube is a small graduated glass float.

A hydrometer is used for determining the state of charge and discharge of a lead-plate-and-acid storage battery from the specific gravity of the electrolyte or fluid within the cells.\*

\*See "The Storage Battery in Radio Service," in RADIO BROADCAST for August, 1922.

The specific gravity of any liquid is a comparison of its weight to the weight of the same quantity of water. Sulphuric acid is heavier than water. A tube, such as the hydrometer float, weighted so as just to float in sulphuric acid will sink in a glass of water. Thus the battery's electrolyte, which is a mixture of sulphuric acid and water, is heavier than water. But in the process of discharge, sulphuric acid is absorbed into the plates of the battery, leaving the remaining solution much weaker, or lighter in weight. As the battery is recharged, the acid is forced from the plates back into the solution, which, on full charge, regains its original acidity. Thus the measuring of an electrolyte's specific gravity will indicate the amount of acid absorbed by the plates, i. e., the state of charge!

In testing the battery with the hydrometer, the vent caps are removed (and left off during charge) and enough electrolyte withdrawn from the cell being tested to float the graduated scale (Fig. 5), each cell being tested separately. A fully charged battery should read 1280, half charge about 1215, and it should be placed on charge at 1150 or sooner. The battery should never be left for any time at this lower reading.

If the battery refuses, on a continued charge,

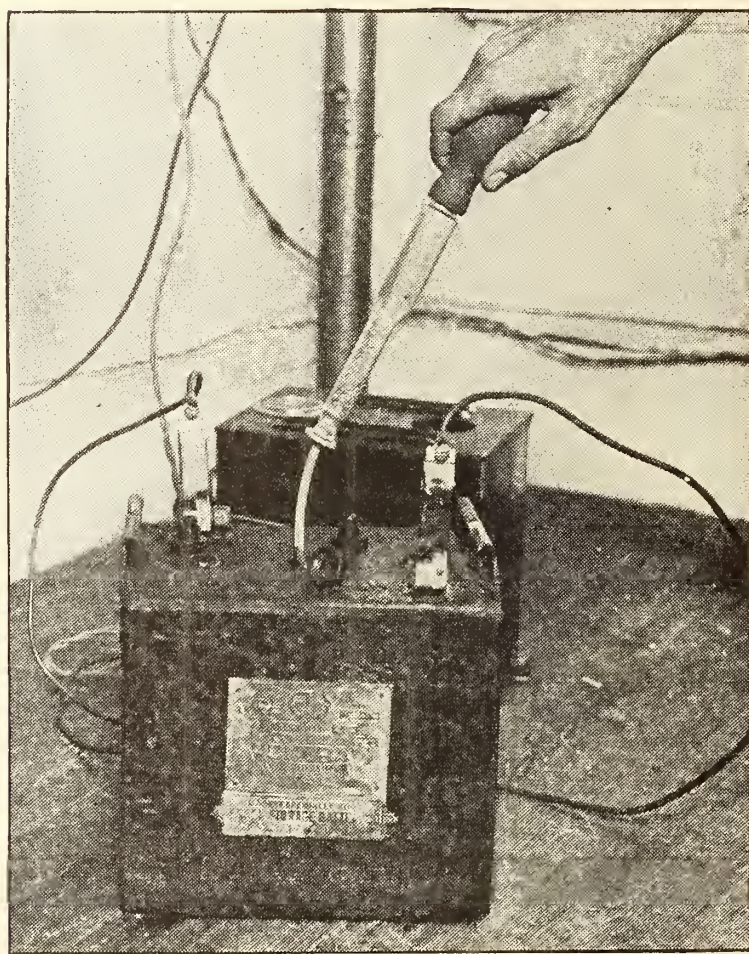

FIG. 5

Determining the state of charge of a battery with a hydrometer



to come up to the required specific gravity, but gases freely, and otherwise exhibits indications of a full charge, there is probably insufficient acid in the electrolyte. A *small* quantity should be added to the deficient cells until the desired reading is obtained. Add acid only to fully charged batteries. This job, however, is best done by an expert.

The intelligent use of a hydrometer in the care of a storage battery will add years to its life.

THE CRYSTAL DETECTOR

A *good* crystal detector is an important addition to a radio laboratory (In many cases, it is the beginning of one.) It is most useful as a stand-by for the throwing together of an auxiliary set\*; it is almost indispensable for certain wavemeter experiments, and the advent of reflex possibilities (many such circuits recognizing the crystal as the best available detector) has given to this ancient form of detection a new importance.

The crystal detector rectifies the alternating currents induced in the antenna system by the passing radio waves, through its inherent property of unilateral conductivity, viz., passing a current in only one direction. One half of

\*See "Crystal Receivers are Well Worth While," in the August, 1923, number.

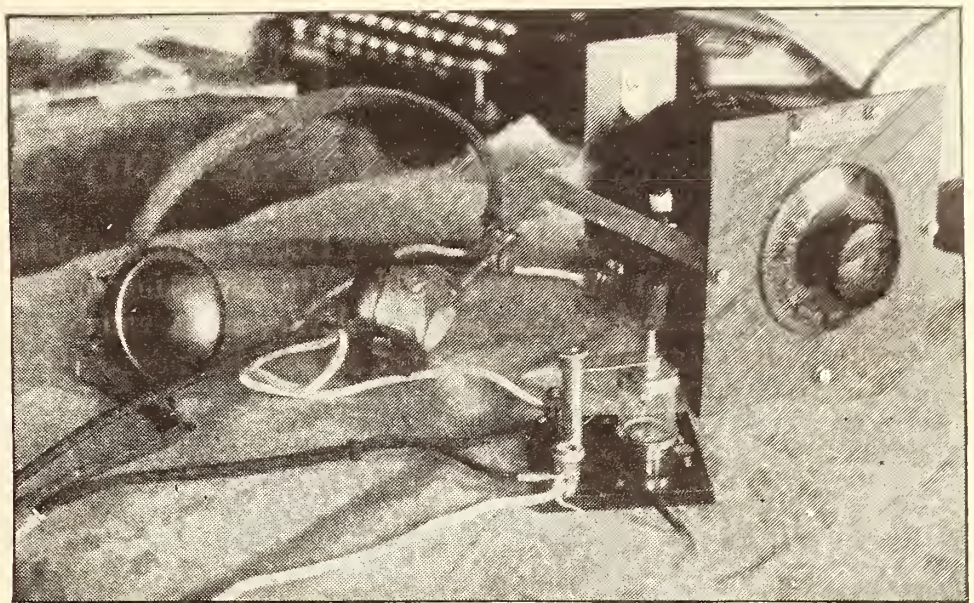

FIG. 6

Phones, crystal, and variometer—a complete receiving set

the alternations are discarded and the other half passed on as rapidly pulsating D. C. (direct current).

Galena is deservedly the most popular crystal, and Fig. 6 shows such a crystal in a well designed mounting (cost \$2.00), hooked to a rapidly thrown together auxiliary set. The "set" consists merely of antenna, variometer, detector and ground in series, with the phones connected across the detector.

This type of detector is very easily adjusted, but with a particularly obdurate crystal, the buzzer test described on page 321 of the August, 1923, issue may be used.



Supplemental List of Broadcasting Stations in the United States

LICENSED FROM AUGUST 8 TO AUGUST 24 INCLUSIVE

(Next month—revised list of all U. S. and Canadian broadcasting stations)

CALL SIGNAL	STATION	FREQUENCY (Kilocycles)	WAVE-LENGTH	POWER WATTS
KFJM	University of North Dakota, Grand Forks, N. D.	1310	229	100
KFJQ	Electric Construction Co., Grand Forks, N. D.	1190	252	5
KFJR	Dixon, Ashley C., & Son, Stevensville, Mont.	1160	258	50
KGB	Tacoma <i>Daily Ledger</i> , Tacoma, Wash.	1190	252	50
WTAH	Ferro, Carmen, Belvidere, Ill.	1270	236	10
WTAJ	The Radio Shop, Portland, Maine	1270	236	50

DELETIONS FROM AUGUST 1 TO AUGUST 31

KFIJ	Platte, S. D.	WJAK	Stockdale, Ohio
KGB	Tacoma, Wash.	WJAP	Duluth, Minn.
KGO	Altadena, Calif.	WLAY	Fairbanks, Alaska
WEAD	Atwood, Kansas	WRP	Camden, N. J.
WGM	Atlanta, Ga.	WSAQ	Dartmouth, Mass.

# The Grid

## QUESTIONS AND ANSWERS

The Grid is a Question and Answer Department maintained especially for the radio amateurs. Full answers will be given wherever possible. In answering questions, those of a like nature will be grouped together and answered by one article. Every effort will be made to keep the answers simple and direct, yet fully self-explanatory. Questions should be addressed to Editor, "The Grid," RADIO BROADCAST, Garden City, N. Y.

### WHAT THE GRID CAN AND CANNOT DO

WITH a view to making this department more efficient, and more valuable to our readers, we request that all those who write in to The GRID, consider their queries in the following light before submitting them to this department:

1. Is my question put clearly, concisely, and without ambiguity?

2. Have I stated every possible fact regarding my installation, or the set which I intend building, which may assist the editor in furnishing me with the information I desire?

3. Am I sure that the question which I am asking is not answered in the article to which it has reference? (Many questions are received which are covered fully somewhere in the articles that have prompted them.)

4. Has this question been answered in either The GRID or in a complete article in a recent issue of RADIO BROADCAST? (The majority of replies furnished by this department are references to late issues of this magazine in which the correspondent's question has been answered in every detail.)

RADIO BROADCAST cannot answer such questions as "What is the best set I can build?"; "What kind of an aerial shall I put up?"; "What is wrong with my receiver?"

The type of set you construct depends much more on your own ability and resources than upon the advice of any radio periodical. However, if you will state your mechanical facilities, the purpose for which you desire the set, DX, loop reception, etc., your radio experience, and the amount of money you care to invest, we can invariably give you helpful advice concerning the best set for you.

Likewise the antenna which you erect depends on many things. We may describe an ideal antenna which, due to geographical, financial, or other reasons would be impossible for the particular reader whom we were answering to construct. But if you will describe your present or contemplated antenna system, we shall be pleased to tell you if it is a good one, and suggest changes for bettering it if that is possible.

We have written to a great many readers that we cannot advise them what is wrong with their receiving sets. To diagnose radio difficulties, one must personally examine the faulty apparatus, put it through innumerable tests, and even then an expert is often balked for a time. To accomplish this by mail, on the scanty description of symptoms with which we are generally furnished, is, we regret, next to impossible. However, if the correspondent will describe to us in detail the manner in which the set acts or fails to act, i. e., the symptoms: the set itself (the parts, tubes, condensers, rheostats, jacks, transformers etc.); his past difficulties with it; the various attempts

which he has made to locate the trouble and the results of such tests, we shall be able to render him assistance in the majority of cases.

Questions dealing with little special points on construction peculiar to a set described in RADIO BROADCAST, but not covered in the article, should be addressed to the author of the story, care of this magazine. Any general questions will, of course, be answered through this department.

Your considerate attention to these details will expedite our handling of queries, and insure yourself against possible disappointment. There is an art in asking a question, and it is a genuine pleasure to answer one well put!

### HOW TO BIAS A GRID

*In reference to reflex sets and different amplifying apparatus, I have found mention of "biasing the grids" under certain conditions, without any further description of just what this "bias" means. I, and probably many other readers, are unfamiliar with this process, its cause and effect. I should appreciate any light you can throw on the subject.*

A. A. M., Troy, N. Y.

**B**IASING the grid is the act of placing upon it a potential (voltage) other than that at which it would operate were it connected to the circuit through an uninterrupted, direct wire.

The functioning of the bias is more or less that of a brake; it stabilizes and limits (slows down) the action of the tube. The operation of a vacuum tube depends on and exists by the virtue of the electron stream passing

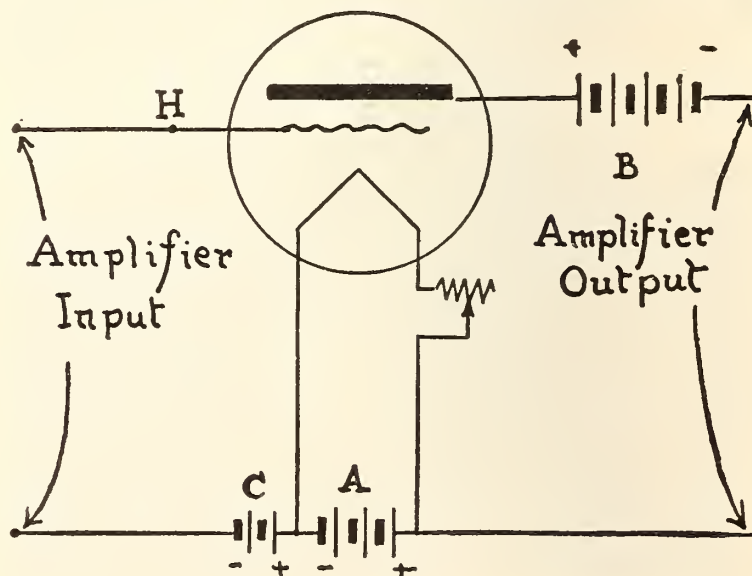

FIG. I

Showing the position of the C biasing battery used to prevent distortion in the amplifying circuit



## Ask any radio expert

**T**HE first duty of a radio panel is to give satisfactory insulation, as any radio expert will tell you. The wise fan selects his panel with special care and insists on having one that supplies the proper insulation resistance.

Celoron Radio Panels provide satisfactory insulation under all conditions. They have high dielectric strength and great surface and volume resistivity, and do not warp or crack when exposed to moisture.

### *Cut in standard sizes*

For your convenience, Celoron Radio Panels come ready cut in eight standard sizes. Your dealer will hand you the size you want, and you can begin to build your set at once.

Celoron panels are easy to saw, mill, and tap, and will engrave evenly without feathering. Each panel is

wrapped separately in glassine paper.

Select from the following standard sizes the panel that suits your needs:

1—6 x 7 x $\frac{1}{8}$	5—7 x 18 x $\frac{3}{16}$
2—7 x 9 x $\frac{1}{8}$	6—7 x 21 x $\frac{3}{16}$
3—7 x 12 x $\frac{1}{8}$	7—7 x 24 x $\frac{3}{16}$
4—7 x 14 x $\frac{3}{16}$	8—12 x 18 x $\frac{3}{16}$

If your dealer cannot supply you, ask him to order, or write direct to us. Indicate by number the size you need. We also furnish Celoron in full-sized sheets and in tubes, and can cut panels in special sizes if desired.

### *This booklet free*

Write for a copy of our booklet, "Tuning in on a New World," which contains a list of the leading broadcasting stations in the United States and Canada, an explanation of symbols used in radio diagrams, and several efficient radio hook-ups. It will be sent to you free on request.

*To radio dealers: Send for special dealer price list showing standard assortments*

## Diamond State Fibre Company

BRIDGEPORT

(near Philadelphia)

PENNSYLVANIA

BRANCH FACTORIES AND WAREHOUSES

BOSTON

CHICAGO

SAN FRANCISCO

Offices in Principal Cities

In Canada: Diamond State Fibre Company of Canada, Limited, 245 Carlaw Ave., Toronto

CONDENSITE  
**CELORON** ★  
STANDARD RADIO PANEL

from the heated filament, through the grid, to the plate. For the various operations, detecting, amplifying, and oscillating at greatest efficiency, the strength of this stream must be varied. In other words, for the most sensitive detection, the highest amplification, and the most powerful oscillations, the plate current must be regulated, and in such a manner as can only be accomplished by biasing the grid, i. e., placing an external charge upon it. A positive charge will increase the flow of negative electrons (unlike charges attract each other, while like charges repel) and a negative charge will lessen it. Where small plate currents are passed, this grid adjustment is easily secured by a condenser and grid leak. With higher currents more drastic means must be resorted to, and a battery is placed in series with the grid, imposing the charge which will regulate the current as is desired.

The abnormal condition which indicates the desirability or necessity of a bias, is evidenced by distorted amplification and howling. Fig. 1 shows how this may be overcome by biasing, "C" being the bias battery, which is referred to as the C battery. The bias should be adjusted, generally between  $1\frac{1}{2}$  and  $4\frac{1}{2}$  volts, until the most satisfactory point is secured.

A bias should never be necessary on a correctly designed two-stage audio amplifier if good tubes are used and the plate voltage (B battery) is not over sixty. If the set howls, the amplifying tubes should be reversed, the first step bulb being placed in the second stage, and vice versa. If this has no effect on the squeal, make sure that the connections have been made correctly, particularly in bringing down the grid through the transformer secondaries to the *negative* of the filaments. Also ascertain if you have conformed with the arbitrary rule of connecting the outside leads of the transformer windings to the grids and plates of their respective tubes. As a last resort, before biasing, look for an open (break) in the windings.

#### TUNED R. F. AMPLIFICATION

*Please show a hook-up of one stage tuned plate radio frequency, detector, and two stages of audio, using UV-199's, honeycomb and a .0005 variable condenser for the radio frequency. Please tell me what ratio transformers to use in the audio amplifier.*

S. M. La Salle, III.

In reply to our correspondent, we publish in Fig. 2 the circuit which he desires. However, operation is not confined to the UV-199, but will be quite satisfactory with any convenient combination of tubes, using detector and amplifiers, of course, in their respective circuits.

L<sub>1</sub> is a double slide or double tapped tuning coil (or it may be the secondary of a variocoupler, if the builder prefers) of one hundred turns of wire, tapped every ten turns, wound on a  $3\frac{1}{2}$ -inch tube. C<sub>1</sub> is a 23- or 43-plate variable condenser. L<sub>2</sub> is the 40-turn honeycomb mentioned by our correspondent, but if desired, it may be wound with 50 turns of wire on a 3-inch tube. C<sub>2</sub> is the .0005 condenser.

R is a potentiometer approximating 400 ohms resistance. C<sub>3</sub> is the usual phone condenser of about .0015 mfd.

The four tubes, running from the antenna to the right, are the R. F. tube, the detector and two audio amplifiers. The transformers T and T are of standard design, and may be of the same ratio, that is, about four to one. On some occasions it is possible to obtain greater amplification by using a higher ratio on the first-step transformer, some engineers advising as high as twelve to one. This is immediately dropped, however, to four or three to one in the succeeding stages. The GRID has always obtained excellent amplification using transformers of the same comparatively low ratio throughout.

J<sub>1</sub> and J<sub>2</sub> are double-circuit jacks, while J<sub>3</sub> (which, if desired may be the same) has been indicated as a single-circuit jack.

If UV-199's are used, the B battery should not exceed 60 volts unless the tubes are biased.<sup>1</sup>

The "A" battery sockets and rheostats will, of course, depend upon the tube used.<sup>2</sup>

The experimenter will probably find the radio frequency very difficult to tune, but the knack of it will soon be acquired with practice, and the results justify the trouble

<sup>1</sup>See "the Best Battery Connection for the Tubes You Use," in RADIO BROADCAST for June, 1923.

<sup>2</sup>See "Rheostats for the Tubes You Use," in RADIO BROADCAST for October, 1923.

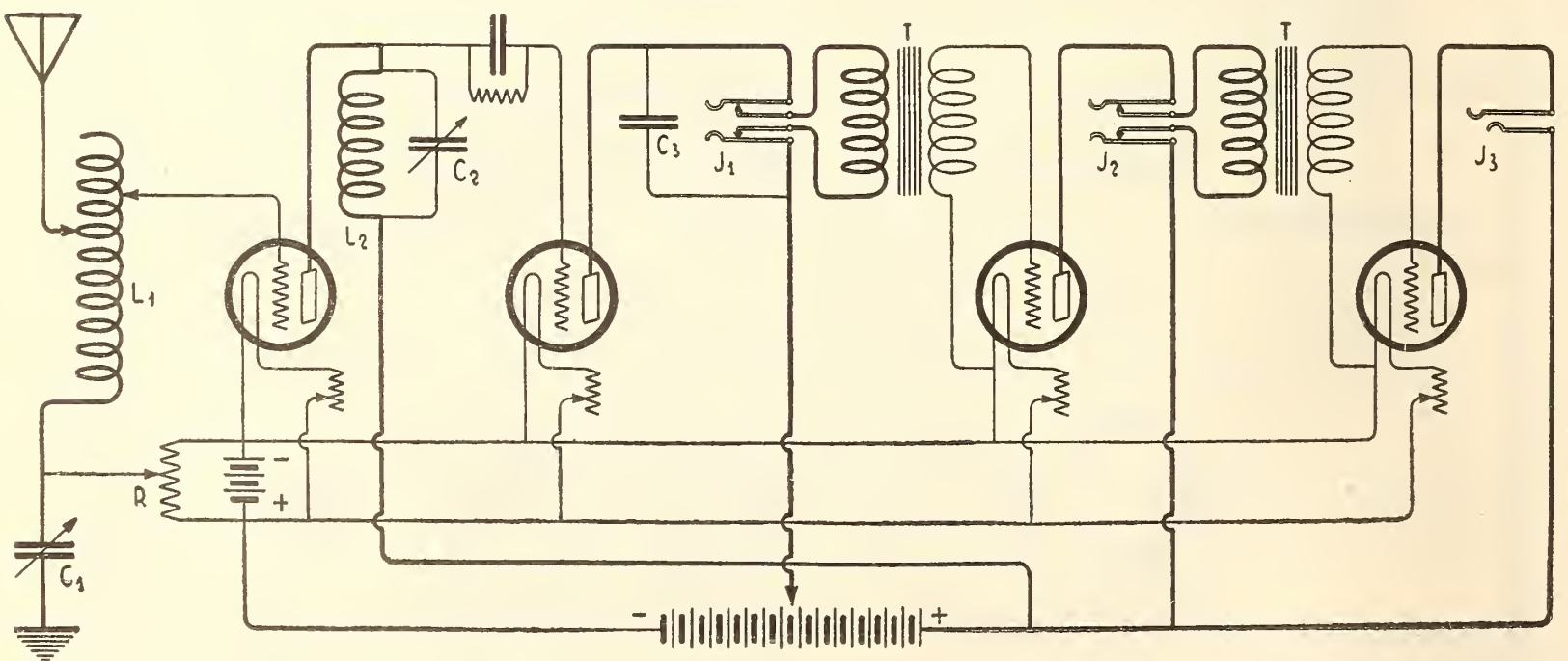
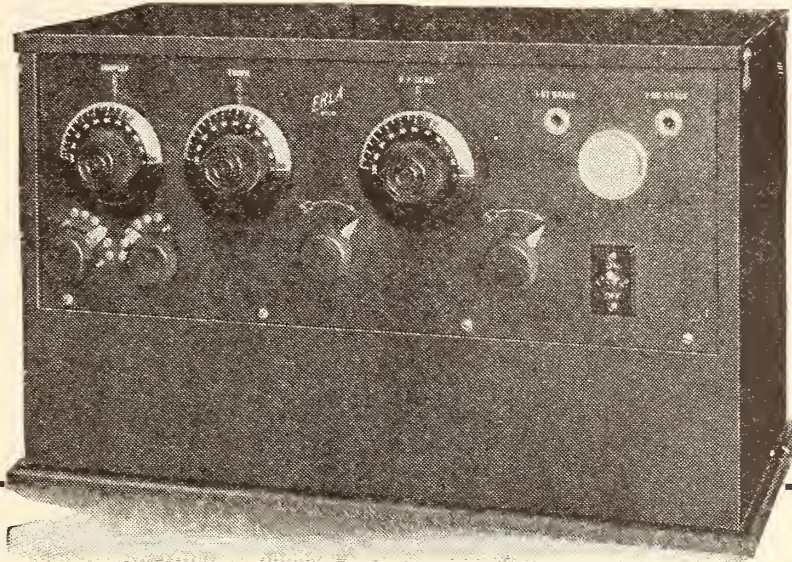

FIG. 2

# Build This Transcontinental Receiver At Half the Usual Cost!



Ordinarily You  
Would Pay From  
\$125<sup>00</sup> to \$250<sup>00</sup>

This Way You  
Pay Only \$65<sup>00</sup>



Erla synchronizing radio frequency reflex transformers provide unequalled magnification without distortion. Types, reflex 1, 2. List, \$5



Providing utmost sensitiveness with perfect stability, the Erla fixed crystal rectifier is uniquely adapted for reflex work. List, \$1

**Dealers and Jobbers**—No day passes that Erla does not increase your opportunities for sales and profits. Write for sample Erla Triplex receiving sets, in beautifully finished solid mahogany cabinets, at manufacturer's cost, for demonstration to your trade

So simple and inexpensive to build is the Erla transcontinental Triplex receiver that every home can now enjoy the infinite pleasure and variety of nation-wide loud speaker reception.

Erla parts, complete even to the cabinet and panel, and Erla solderless connectors, make child's play of the work of assembly. Accurate, easily understood drawings guide every step.

Materials are reduced to a minimum through the employment of Erla synchronizing transformers, enabling vacuum tubes to do triple duty. Only three tubes are used, yet costliest multi-stage amplifiers are surpassed in range and volume.

Choice of broadcasting programs is exercised at will, so sharp and selective is the tuning. Yet controls are so few and simple as to be operated by any child. Especially remarkable is the purity and fidelity of reproduction, exceeding the finest phonograph.

For further information regarding Erla Triplex, as well as perfected Erla one and two-tube receivers, consult Erla Bulletin No. 14, obtainable gratis from leading radio dealers. Or write us direct, giving your dealer's name.

**Electrical Research Laboratories**  
Dept B 2515 Michigan Avenue, Chicago

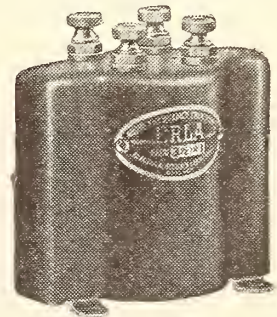

The unique ability of Erla synchronizing audio transformers to reflex properly enables vacuum tubes to do triple duty. List \$5

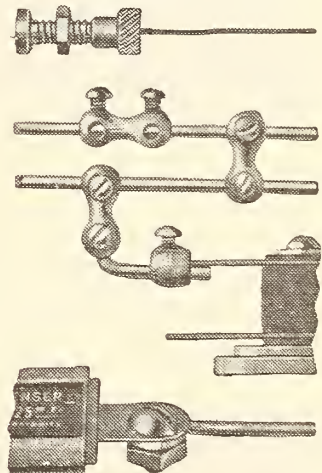

Difficult, dangerous use of soldering irons is eliminated by Erla solderless connectors, saving time, temper and money. List, 5c ea.



## Rudyard Kipling's Verse

Inclusive Edition: 1885-1918

Cloth, \$5.00

Leather, \$7.50

Doubleday, Page & Co.

# A Social Secretary for Life!



## What to Say—

If you have ever been tongue-tied at a party you know how embarrassing it can be not to be able to converse with the other guests, to sit silent, uncomfortable, alone. One of the greatest values of the Book of Etiquette is that it tells you exactly what to say on every occasion—how to become a pleasant and interesting conversationalist.



## What to Do—

It is rather late and she does not know whether she should invite him into the house or not. He does not know whether he should ask permission to call, or wait until he is invited. The Book of Etiquette would have told them both exactly what is expected of them. Throughout life this famous work acts as a guide, a silent "social secretary."

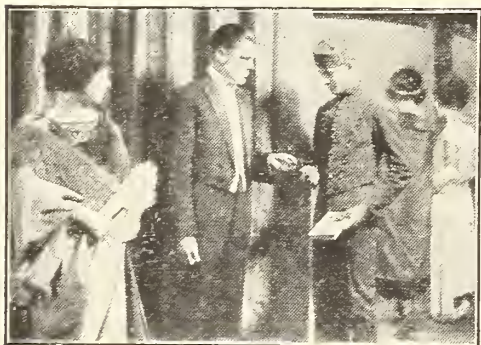

## What to Wear—

They are attending the opera for the first time. With what trepidation they enter—fearful that they may have made some error in dress! The Book of Etiquette would have told them exactly what is correct—just as it tells what is correct to wear on all other occasions. A social secretary for life! Be sure to grasp the rare opportunity explained on this page.

## The Famous Book of Etiquette

Half a Million Sold for \$3.50

Rare Short-Time Offer—Only

**\$1.98**  
While the  
Edition Lasts

AS a special inducement Nelson Doubleday, Inc. makes the amazing offer to send you the complete original Book of Etiquette at approximately half the usual publisher's price!

The same highly fascinating and extremely useful Book of Etiquette for which 500,000 people have paid \$3.50. The same original and authentic work which is to-day solving social problems in half a million homes. Not a word omitted, not a phrase changed. But now, if you act at once, only \$1.98.

A rare opportunity. You'll grasp it. Thousands will. But only a limited number of the Book of Etiquette will be sold at this special price, and you are therefore urged to act at once.

The famous Book of Etiquette is unquestionably the most authoritative, complete, and helpful work of its kind ever published. It covers every phase of wedding etiquette, street, dinner, dance, and theatre etiquette. It contains highly valuable information for the self-conscious and timid; for the bachelor; for the business woman; for the country hostess.

Don't miss this extraordinary opportunity to secure *your* set at so great a reduction.

**Solves Every Social Problem—  
Prevents Embarrassing Blunders—  
Gives Poise, Ease, Confidence!**

With the book of Etiquette as your "social secretary" you need never hesitate to accept an invitation, no matter how formal. You need never fear the embarrassment of conspicuous mistakes. With this famous work to refer to, you will always know just exactly what to do, what to say, what to write, what to wear—on every occasion and under all circumstances.

It is really remarkable what poise and ease the Book of Etiquette gives to those who have been timid and self-

conscious. It instantly banishes all doubt—makes you *sure* of yourself. And you find yourself assuming a wonderful new ease of manner, a new confidence in yourself, new dignity, and self-possession!

## Little Blunders That Take Us Off Our Guard

There are so many problems of conduct constantly arising. How should asparagus be eaten? How should the finger-bowl be used, the napkin, the knife, and fork? Whose name should be mentioned first when making an introduction? How should invitations be worded? How should the home be decorated for a wedding? What clothes should be taken on a trip to the South?

In public, at the theatre, at the dance, on the train—wherever we go and with whom ever we happen to be, we encounter problems that make it necessary for us to hold ourselves well in hand, to be prepared, to know *exactly what to do and say*.

With the Book of Etiquette as your guide, nothing will take you off your guard. You will not be subject to sudden embarrassments. Instead of being hesitant, embarrassed, ill at ease—you will be calm, well-poised. Instead of feeling “out of place” at parties or social functions, you will feel entirely “at home.” You will find yourself becoming a better mixer, a more welcome guest. And instead of

being “tongue-tied” among strangers, you will find yourself conversing smoothly, naturally, with ease, and self-possession!

## Complete and Exhaustive

The Book of Etiquette covers every phase of conduct that could possibly interest you. Indeed, it is recognized as one of the most complete, exhaustive, and authoritative works of its kind ever published. There are chapters on etiquette at the dance, the wedding, the dinner, the tea, the week-end party, the theatre. There is some valuable information intended for the timid and self-conscious; paragraphs that the bachelor will find useful; information for the business woman and country hostess.

How about it? May we send you *your copy* of the Book of Etiquette? It is quite possible that this may be your last opportunity to secure this famous \$3.50 work for \$1.98. Why not send off the coupon NOW, while you are thinking of it?

## SEND NO MONEY The Coupon Brings It To You

This is your chance to take advantage of a tremendous bargain. Half a million people have paid \$3.50 for the Book of Etiquette. Here's your chance to secure the same Book of Etiquette for only \$1.98.

We know you won't overlook this unusual chance. Mail the coupon to-day. No money is necessary. But be sure you get the coupon off at once. The Book of Etiquette will be sent to you in a plain carton, with no identifying marks, Nelson Doubleday, Inc., Dept. 1010, Garden City, New York.

### USE THIS SPECIAL COUPON

Nelson Doubleday, Inc.,  
Dept. 20112, Garden City, New York

I am glad to know of the special bargain offer on the Book of Etiquette. You may send me in plain carton these two volumes without any money in advance. When they arrive I will give the postman only \$1.98 (plus a few cents postage) in full payment—instead of the regular price of \$3.50. I am to have the privilege of returning the Book of Etiquette any time within 5 days if I am not delighted with it.

Name.....

Address.....

Check this square if you want these books with the beautiful full-leather binding at \$2.98 with same return privilege.

(Orders from outside the U. S. are payable \$2.44 cash with order. Leather binding outside U. S. \$3.44, cash with order.)

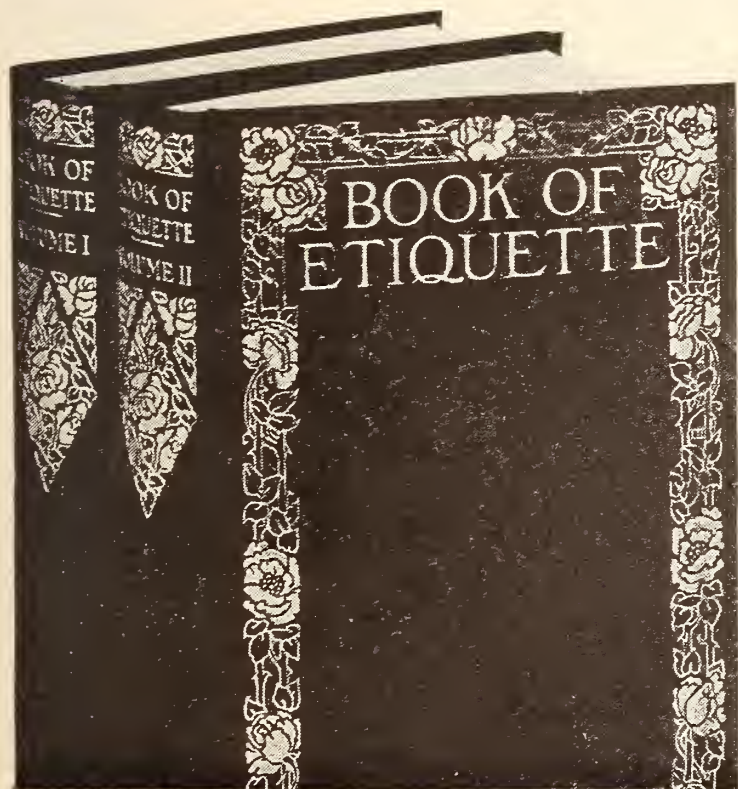

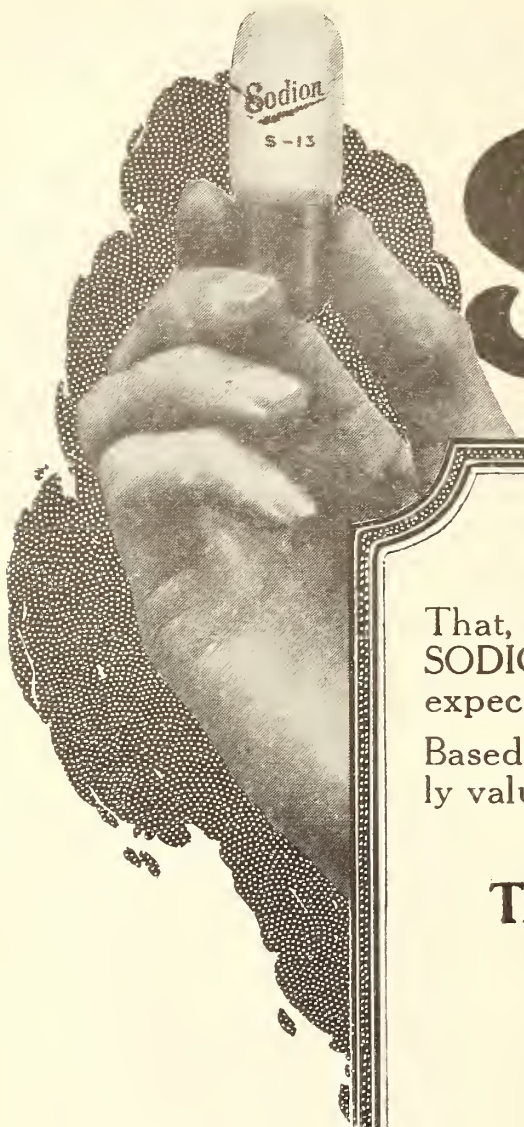

# Sodion

## A New Era in Radio

That, in the fullest sense of the word, is what the SODION TUBE means to everybody who owns or expects to own a receiving set.

Based on an entirely new principle—utilizing the highly valuable and peculiar properties of the sodium ion.

## The Sodion Tube

(Sodium - Ion)

is many times more sensitive and produces far stronger signals than any detector yet developed.

Due to the fact that it cannot be made to oscillate, it not only eliminates any semblance of whistles or beat-note howls in your own reception, *but does not interfere with the reception of others.*

At a meeting of the Institute of Radio Engineers where this tube was being demonstrated, a prominent Scientist and Radio Engineer, in contrasting this with the action of the ordinary detector, dubbed it

### “THE GOLDEN RULE TUBE”

Stable and uniform in operation. Runs for hours without adjustment. Has no grid. No grid leak or grid condenser are required. Crystal tone reception. Unusually sensitive to weak signals. Operates on dry cells or storage battery.

*Bulletin A-100 describing this tube upon request.*

**CONNECTICUT TELEPHONE & ELECTRIC COMPANY**  
MERIDEN Radio Division CONNECTICUT



What Receiver Shall I Buy?

25  
Cents

7.4 4.2  
December,  
1923

# RADIO BROADCAST

Radio Broadcast's Coming Transatlantic Tests

How to Build a Neutrodyne Receiver

Revised List of U. S. and Canadian Broadcasting Stations

Using What Junk  
You Have  
In Building a  
Super-Heterodyne

Running the Sub-  
marine Gauntlet  
with a  
Cargo of "Gas"



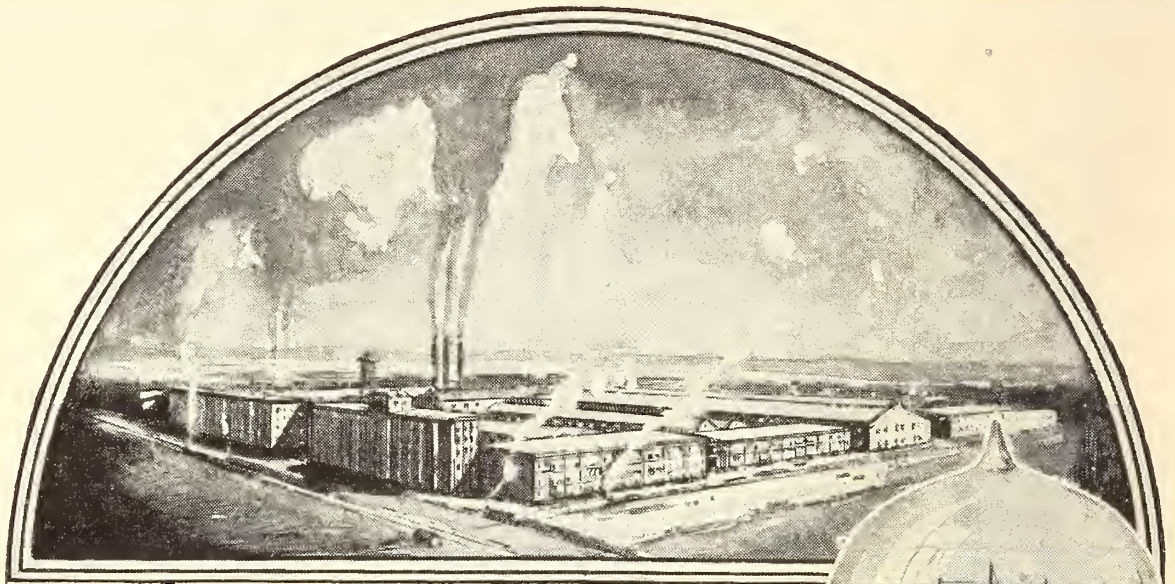

# Cunningham tubes



## A MONUMENT TO SCIENTIFIC RESEARCH

CUNNINGHAM VACUUM TUBES, built by one of the world's largest manufacturers with unlimited resources, are the product of years of research and development work by that great scientific organization, the Research Laboratory of the General Electric Company.

The development of the special filament used in the two new *Cunningham Tubes*, type C-301-A and C-299, is truly a monument to the scientific skill of that organization and the ability of its engineers.

The outstanding feature of this filament is its property of high electron emission at a low temperature. This results in a Vacuum Tube having a greatly increased output, with only a fraction of the filament power consumed by previous types.

$\frac{1}{4}$  Ampere Filament  
Current.  
Mutual Conductance  
700 Micromhos.



**Patent Notice:** *Cunningham tubes are covered by patents dated 11-7-05, 1-15-07, 2-18-08, and others issued and pending. Licensed for amateur, experimental and entertainment use in radio communication. Any other use will be an infringement.*

### Cunningham Radio Tubes

C-301A—6 Volts $\frac{1}{4}$ amp. Amplifier .....	\$6.50
C-299—3 Volts .06 amp. Dry Battery Det. and Amp. ....	6.50
C-300—6 Volts Gas Con- tent Detector .....	5.00
C-11—1.1 Volts .25 amp. Dry Battery Det. and Amp. Special Base...	6.50
12—Similar to C-11 with standard base...	6.50

*E. J. Cunningham Inc.*

154 West Lake Street  
Chicago, Illinois

Home Office:  
182 Second Street  
San Francisco, Cal.

30 Church Street  
New York City, N. Y.



*Natural*  
*Re-PRODUCTION*

**Atlas**  
**AMPLITONE**  
**LOUD SPEAKER**

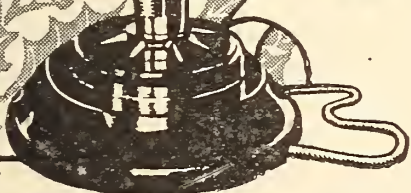

TRADE MARK

**Letters**  
**from Users**  
**Requested**

The remarkable re-PRODUCTIONS of *Atlas Loud Speakers* make every owner enthusiastic. "Musical experts," writes a man in St. Paul, "have pronounced it the clearest reproduction they have ever heard." What results have you accomplished with your *Atlas Loud Speaker*? Write us about them —TO-DAY.



FOR Christmas give the radio enthusiast his fondest expectation—a perfect radio re-PRODUCER, the *Atlas Loud Speaker*. Natural re-PRODUCTION, identical with the original in the broadcasting studio! The patented "double diaphragm," responds uniformly to the full range of sound intensities. Adjustable to each individual set and receiving conditions. The *Atlas Loud Speaker* is a gift to an entire home.

Hear the *Atlas Loud Speaker* at your dealer's.

List price

**\$25**

WARNING! Be sure you get the *genuine Atlas Loud Speaker* with our red tag factory guarantee.

*Write for Booklet A*  
*Containing Helpful Information*

**Sole Canadian Distributors**

THE MARCONI WIRELESS TELEGRAPH Co.,  
OF CANADA, LIMITED, MONTREAL, CANADA

MANUFACTURED BY

**Multiple Electric Products Co. Inc.**

ORANGE ST.

RADIO  
DIVISION

NEWARK, N. J.

# Radio Broadcast

ARTHUR H. LYNCH, EDITOR

DECEMBER, 1923

THE R. C. A.'S CHIEF THINKS OF OTHER DAYS - - - - -	<i>Frontispiece</i>
THE MARCH OF RADIO - - - - -	<i>J. H. M.</i> 91
RUNNING THE SUBMARINE GAUNTLET WITH A CARGO OF "GAS" <i>Haydn P. Roberts</i>	106
WHAT KIND OF RECEIVER SHALL I BUY? - - - - -	<i>Arthur H. Lynch</i> 117
HOW TO BUILD A NEUTRODYNE RECEIVER - - - - -	<i>Kimball Houton Stark</i> 124
RADIO VAGABONDING - - - - -	<i>Peter Taylor</i> 129
JUST TO PLEASE THE WIFE - - - - - Drawings by Thomas E. Monroe	<i>Harry Irving Shumway</i> 139
USING WHAT JUNK YOU HAVE IN MAKING A SUPER-HETERODYNE <i>George J. Eltz, Jr.</i>	143
THE FUNDAMENTALS OF LOUD SPEAKER CONSTRUCTION - - -	<i>A. Nyman</i> 151
VARIOUS CIRCUITS AND WHAT THEY MEAN Part I. The Analysis of a Circuit - - - - -	<i>Zeh Bouck</i> 160
R. B.'S COMING TRANSATLANTIC TESTS - - - - -	<i>The Editor</i> 163
WHAT OUR READERS WRITE US - - - - -	164
IN THE R. B. LAB. - - - - -	165
THE GRID—QUESTIONS AND ANSWERS - - - - -	168
NEW EQUIPMENT- - - - -	170
AMONG OUR AUTHORS - - - - -	172
COMPLETE REVISED LIST OF U. S. AND CANADIAN BROADCASTING STATIONS -	174

Copyright, 1923, by Doubleday, Page & Co. All rights reserved

TERMS: \$3.00 a year; single copies 25 cents

F. N. DOUBLEDAY, Pres.

ARTHUR W. PAGE, Vice-Pres.

NELSON DOUBLEDAY, Vice-Pres.

RUSSELL DOUBLEDAY, Sec'y.

S. A. EVERITT, Treas.

JOHN J. HESSIAN, Asst. Treas.

DOUBLEDAY, PAGE & CO.

THE WORLD'S WORK

COUNTRY LIFE

THE GARDEN MAGAZINE

SHORT STORIES

EDUCATIONAL REVIEW

CHICAGO: People's Gas Bldg.

GARDEN CITY, N. Y.

NEW YORK: 120 W. 32nd Street

BOSTON: Tremont Bldg.

LOS ANGELES: Van Nuys Bldg.

# How Lively Is Your "B" Battery?

THIS IS NUMBER THREE OF A SERIES

Some people buy Eveready "B" Batteries oftener than other people. This is because each fan has different tastes and desires in radio receiving. Those that demand maximum volume—and to get it use many tubes, forcing them to the limit with high voltages on the plates—are eager and frequent buyers of these batteries.

Others renew them less often. They are the ones that are content with smaller volume and employ fewer tubes at lower plate voltages.

Furthermore, every radio fan, regardless of the tubes he uses, has his own ideas as to when it is time to strengthen the signals with fresh "B" Batteries. Some will long enjoy concerts that others would not consider loud enough. Just what is "too weak" is purely a matter of personal opinion.

These, then, are the things that determine how long you use your "B" Batteries—

1. *The number and kind of tubes.* The more tubes you use and the greater their power, the more current flows from the "B" Battery and the shorter is its life.
2. *The "B" Battery voltage.* The higher it is, the more current flows from the battery.
3. *The amount of negative grid bias ("C" Battery voltage) on amplifiers.* The greater the bias, the smaller the "B" Battery current.
4. *The life put into the battery in the first place by the manufacturer, and the freshness of the battery when you buy it.*
5. *The signal strength you wish.* The smaller the volume of sound you can enjoy, the longer you can use your "B" Batteries.

The life of any "B" Battery you can buy is affected by the above factors. Subsequent advertisements will set forth each factor in detail.



Eveready "B" Batteries predominate. There is more life in them—they last longer! Blocks of large cells, packed with energy, made especially for radio use, delivered fresh to your dealer, give you the most power for your money—power you can use loudly and swiftly, or softly and slowly, as you wish—Eveready for Everybody.

## "the life of your radio"



The Metal Case Eveready "B" Battery, No. 766. The popular 22½-volt Eveready Battery in a new handsome, durable, waterproof metal case. At all dealers, \$3.00.

Eveready "B" Battery No. 767. Contains 30 large size cells, as used in the popular No. 766. Voltage, 45. Made especially for sets using detector and one or more stage of amplification. The most economical "B" Battery where 45 volts are required. At all dealers, \$5.50.

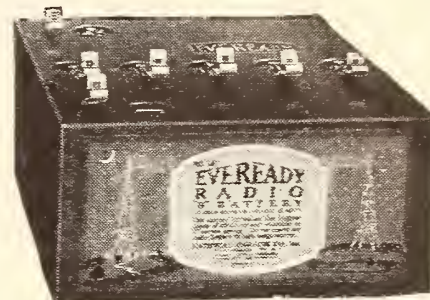

Eveready Radio Battery No. 771. The Eveready "Three." The ideal "C" Battery. Voltage, 4½—three terminals permitting the use of 1½, 3, or 4½ volts. The correct use of this battery greatly prolongs the life of the "B" Battery. At all dealers, 70 cents.

Manufactured and guaranteed by

**NATIONAL CARBON COMPANY, Inc.**

Long Island City, N. Y.

★

# EVEREADY

## Radio Batteries

—they last longer

*Note: This is Number 3 of a series of informative advertisements, printed to enable users to know how to get the most out of their receivers and batteries. If you have any battery problem, write to G. C. Furness, Manager Radio Division, National Carbon Company, Inc., 126 Thompson Avenue, Long Island City, N. Y. Write for special booklets on "A," "B," and "C" Batteries.*



THE R. C. A.'S CHIEF THINKS OF OTHER DAYS

Major-General James G. Harbord, President of the Radio Corporation of America, was much interested in the German transmitter, exhibited at the recent New York Radio Show, which was captured in the territory where, six years ago, he commanded the marines of our Second Division

# RADIO BROADCAST

Vol. 4 No. 2



December, 1923

## The March of Radio

### DID RADIO FAIL AT POINT ARGUELLO?

**T**HE disastrous accident to our destroyer fleet off the Pacific coast at Santa Barbara is apparently to be closely connected with the radio bearings sent out by the compass station at Point Arguello. It seems that there had been another accident in the same vicinity shortly before the destroyers went aground, and that the air was full of radio inquiries regarding the bearings of fog-bound ships. It would appear from the testimony so far elicited that the radio compass bearings given to the destroyer fleet were correct, but did not seem to be to the navigating officer and that he therefore used his own judgment as to when to change the course of the fleet, instead of relying implicitly on the radio bearings.

Perhaps, in the long run, it would be better if this were the true story of the disaster; for if it should prove that the radio compass bearings as given out by the Point Arguello station were incorrect, our faith would be shaken in the reliability of one of the most important contributions of radio to navigation. Ships without number are daily shaping their courses by radio bearings when they approach port in a fog, or when for other reasons the normal aids to navigation seem not sufficient, and it would indeed be serious should it develop that the bearings given by this service should suddenly become unreliable, especially without the suspicion of the operator in charge.

Radio compass stations do not directly give the correct bearings, as is well known; each station, after it is installed, and periodically thereafter, must be calibrated; that is, its errors in the different directions must be measured and kept on record in front of the operator. On getting the ship's apparent bearing, the operator must immediately consult his chart of corrections before sending back to the ship its true bearing.

These corrections to the apparent bearing depend upon the direction of the coast line, presence of inland water, disposition of the transmitting antenna, etc., and may be expected to change whenever any of the large electrical conducting bodies in the vicinity of the radio compass are moved. It appears that some alteration was made in the transmitting station the day the accident occurred, and, while it is not at all likely, it is still possible that the calibration of the station was actually at fault when the destroyers were wrecked. Fortunately it will be easily possible to find this out by measuring the errors of the station with and without the changes in the transmitting antenna, to which some have ascribed the trouble. At all events, the radio compass itself must emerge from the inquiry with its reliability absolutely unquestioned.





BACK FROM FRANCE

Dr. Lee de Forest recently returned to this country with Mrs. de Forest and their young daughter. He is reported to have brought with him some important developments in the field of radio

### "Quality First" In Radio Reception

THE fact that many people spend a great deal of time arguing about, and striving after, what they really won't want when they get it, is a generally acknowledged but scarcely appreciated trait of human character. As a matter of fact, what many of us seem to want is determined largely by the practices of the uninspired majority, and by the fear that a departure from the prevailing fashion would leave us uncomfortably spot-lighted before that harsh censor, Public Opinion. The trouble is, that having once expressed not what we think but what has been thought for us, these expressions create habits which are exercised repeatedly in response to certain stimuli from without.

Take this matter of radio receiving, for example. We all know broadcast listeners who will tell us, in answer to our inquiry as to the health of their receiving set, "Oh, it's working fine. With two stages of audio and a loud speaker, you can hear it way out on the street." Then, if they ask us whether our own apparatus can create a disturbance of equal volume, and we mildly reply that we are not out for a long-distance record on sound waves but that we do pull in stations as clear as a bell, so that it's a real treat to sit down and. . . . "Well,"

they break in, "You'll have to go some to get any more kick out of three tubes than I do. . . ."

"Kick" is the word; but the horseshoe that comes with the hoof is likely to fly off and hit the neighbors.

It may be more frank than wise to state that, of the scores of occasions when we have listened-in at the homes of our acquaintances, on only five or ten per cent. of them have we heard music of an intelligent quantity and intelligible quality—such as to make us glad to listen to it *as music*, not as something *comparatively* good for a radio set.

In some cases, to be sure, the receiver or loud speaker is at fault, but often it is not: the owner is merely

suffering from a maximum-loudness complex, or else he hasn't had enough practice in clearing up the signals to be expert at it.

We are aware that this departure from the ways of complacent satisfaction may raise a storm of protest among many good citizens. Each indignant one will declare that *his* results are exceptional. Perhaps; but let him secure a real musician, who knows nothing about radio, plant him in front of his loud speaker, and see how long he will be satisfied to listen to the music, as he would for several hours at a time at a concert or an opera. Another test for our above-mentioned indignant one (in case he gets a defective musician): let him go forth unto the music hall and hear a good instrumental or vocal concert; let him shut his eyes and think of the clearness and the quality of the music in comparison with what pours out of his loud speaker at home. His broadcast listener's pride may say, "I get music almost as clearly as that on my own set"; but the still small voice within him is likely to come back, "Yes, you do—not!"

It seems to us that an injustice is done when sets are "forced" for greater volume than is necessary, or when the operator does not bother to learn a few of the fine (though not difficult) points of good tuning. He is being satisfied with a low standard in a high art; he



is blaming the announcers and artists for the harsh quality of their voices when a slight turn of a rheostat and readjustment of the tuning dials would "clear up the signal" wonderfully. "Why do they let people with such awful voices sing and talk over the radio?" asks the non-radio guest. Sometimes the voices are pretty bad; but often they are made so at the receiving end. Isn't it absurd—and unfair—to distort the music of fine artists?

The tendency toward "quantity first" hits at the whole radio game. If you ask any one not in the radio fraternity why he (or she) doesn't own a radio receiver, he (or she) is likely to assume a "The-very-idea!" expression and reply, "Pay so-and-so dollars to hear what comes out of the funnel down at Rackett's Electrical Store? Not much! If that's radio, . . . etc., etc." And, if we reassure this non-believer that everyone acknowledges Rackett's output to be terrible, and that anyone who had read the article, "Shall We Have

Music or Noise?" in the September, 1922, number of RADIO BROADCAST could have nothing but shudders of disgust for such sounds, the come-back may chant this familiar strain:

"Well, I'm going to wait until this radio thing settles down, until they get it so you can turn just one little gadget and be sure of hearing any station you want. . . ."

Some day, surely, this agreeable condition will come to pass. But think of the fun that thousands of watchful waiters are missing in the meantime! Yes, *fun*. Yes, *missing*; because, with a good (not necessarily expensive) outfit, and a little practice in fine tuning, the novice can bring into his home the varied programs of speech and music with a clearness and quality gratifying to even the most finicky. He will then be automatically elected to the S. Q. F. R. R.—the Society for Quality First in Radio Reception—where the privileges of membership are many, and the dues are figured not in dollars, but in sense.



A TREAT FOR FRENCH BROADCAST LISTENERS

Mme. Georgette Leblanc, former wife of the Belgian author, Maurice Maeterlinck, giving a talk on the American moving picture, at station "Radiola" in Paris. Left to right: Jacques Catelain, Mme. Leblanc, Robert Tabius (Secretary-General of the Société Française Radioélectrique), and Marcel L'Herbier, film director of Mme. Leblanc



THE AMERICAN RADIO RELAY LEAGUE BANQUET—  
Every radio district in the U. S. was represented. There were delegates from Canada, and one from France. The convention was



—AT THE SECOND NATIONAL CONVENTION, IN CHICAGO  
a great success and indicated a very keen interest in the brass-pounding,  
night-owl type of radio—a veritable tribute to Hamdom. Were you there?

### The Coming Super-Heterodyne

**M**OST experimenters have been much disappointed with the behavior of the super-regenerative sets they have built or heard. They undoubtedly do produce undreamed-of amplification, but they are generally so noisy and the quality is so poor, that no great enthusiasm for them exists to-day. We do not believe this achievement of Armstrong's is in the same class with the two other schemes for which he was responsible—the straight regenerative set and the super-heterodyne.

When once asked by some of his amateur friends how he regarded the relative merits of his two "super" schemes the inventor expressed the idea that the super-heterodyne was the Rolls-Royce receiver, whereas the super-regenerative set might be likened to the flivver—a lot for your money. Now although we might prefer Rolls-Royce cars to the creations of Henry Ford, most of us are probably doomed to fliv through life, if we don't walk. If all

of us could become wealthy, or the cost of the best cars could be decreased 90 per cent., then Fords would be in danger of going out of style. It seems that the price of the "Rolls-Royce receiver" is bound to fall. At least two factors are at work to cut down its cost and maintenance, and still another development, mentioned below, will make the super-heterodyne more popular, as this type of receiver will be necessary to get satisfactory results; we refer to short-wave transmission.

The super-heterodyne, it will be remembered, has one high-frequency circuit, tuned to the signal frequency, at the input end. Supplied also to this input circuit is the power from a local oscillator which combined with the signal frequency, gives a beat frequency of about 50,000 cycles. On this 50,000-cycle current is superimposed the voice frequency which was originally on the signal frequency. This 50,000 cycle, voice-modulated current is then sent through about four amplifier tubes, which in the early receivers were resistance coupled,

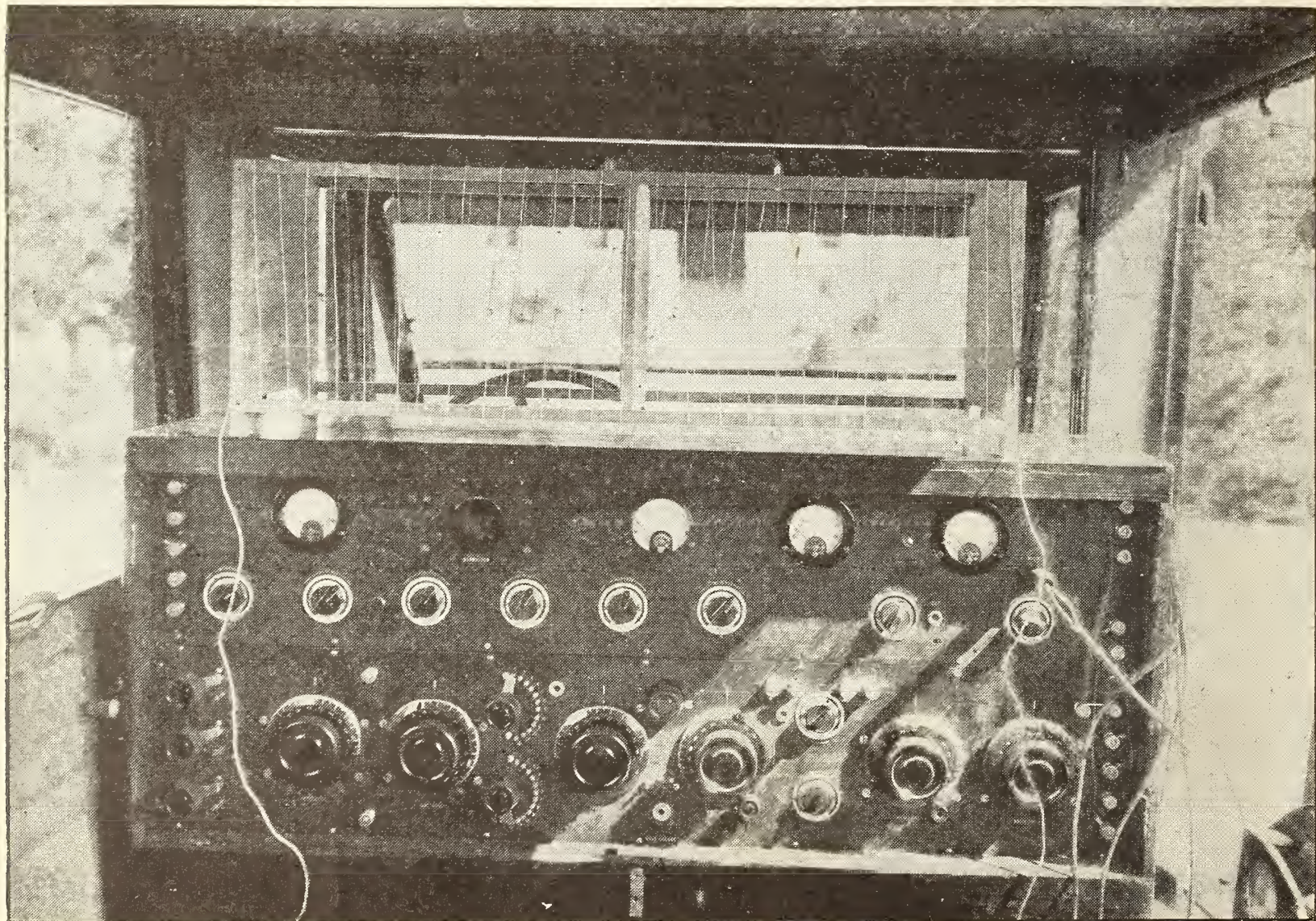

A SUPER IN AN AUTO

It has been successfully employed by Mr. Tuhill of Garden City, Long Island. The machine is of experimental character, hence the many controls. A super-heterodyne with but two tuning controls was illustrated and described in RADIO BROADCAST last month

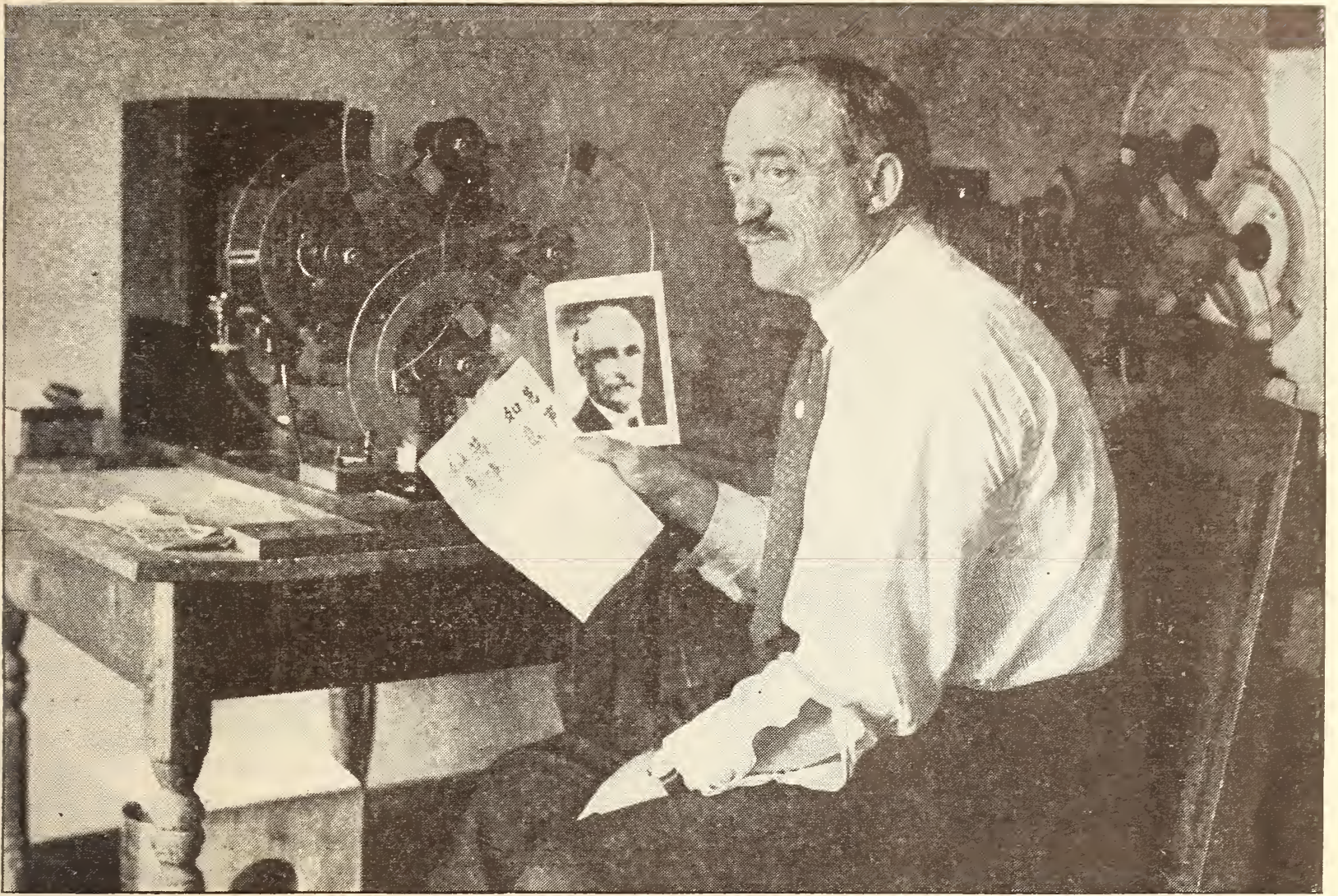

#### HIS INVENTION SENDS SYMBOLS THROUGH THE AIR

C. Francis Jenkins, Washington inventor, has developed apparatus which government experts have declared should revolutionize wire and wireless telegraphy in the Orient. It photographs the original message, transmits it, and reproduces an exact duplicate of it at the receiving end

instead of transformer coupled as might be expected. The 50,000 cycle current is then sent into a detector, from which voice-frequency current comes out, to be increased perhaps with one stage of audio-frequency amplification. Evidently the scheme requires quite an outlay of tubes, generally from six to eight.

Now resistance coupling has two drawbacks, as compared to transformer coupling; it does not give much amplification per stage and it amplifies all frequencies very nearly alike. As we gradually learn more about high-frequency currents, we are able to design and build better radio apparatus, and this is true of 50,000 cycle transformers. By using transformers, instead of resistance, for coupling in the intermediate-frequency tubes, we do away with at least one of the required amplifier tubes and possibly two. Moreover, pulses and noises have much of their energy at other than 50,000 cycles, and as the transformer coupling may be quite selective, the amplification with transformers should have less interference than when resistance coupling is used.

Another factor which favors the development of the super-heterodyne is the unipotential cathode tube, mentioned above. The battery expense, which is high for the ordinary "super," is done away with altogether if such alternating current filament tubes are used. And if short-wave transmission comes into more general use, as seems quite likely, then still more does the super-heterodyne take on the appearance of the future universal favorite.

#### A Storage Battery Broadcasting Station

**H**OW many new things applied science actually forces us to learn! Developments which, ten years ago, were absorbing the interest and efforts of perhaps a dozen experts or research men, are now the subjects of conversation by the layman, forced on his attention because they continually intrude upon his daily round of work and pleasure. How many people we find to-day who are vitally interested in the proper mixture of air and gasoline vapor to get the maximum

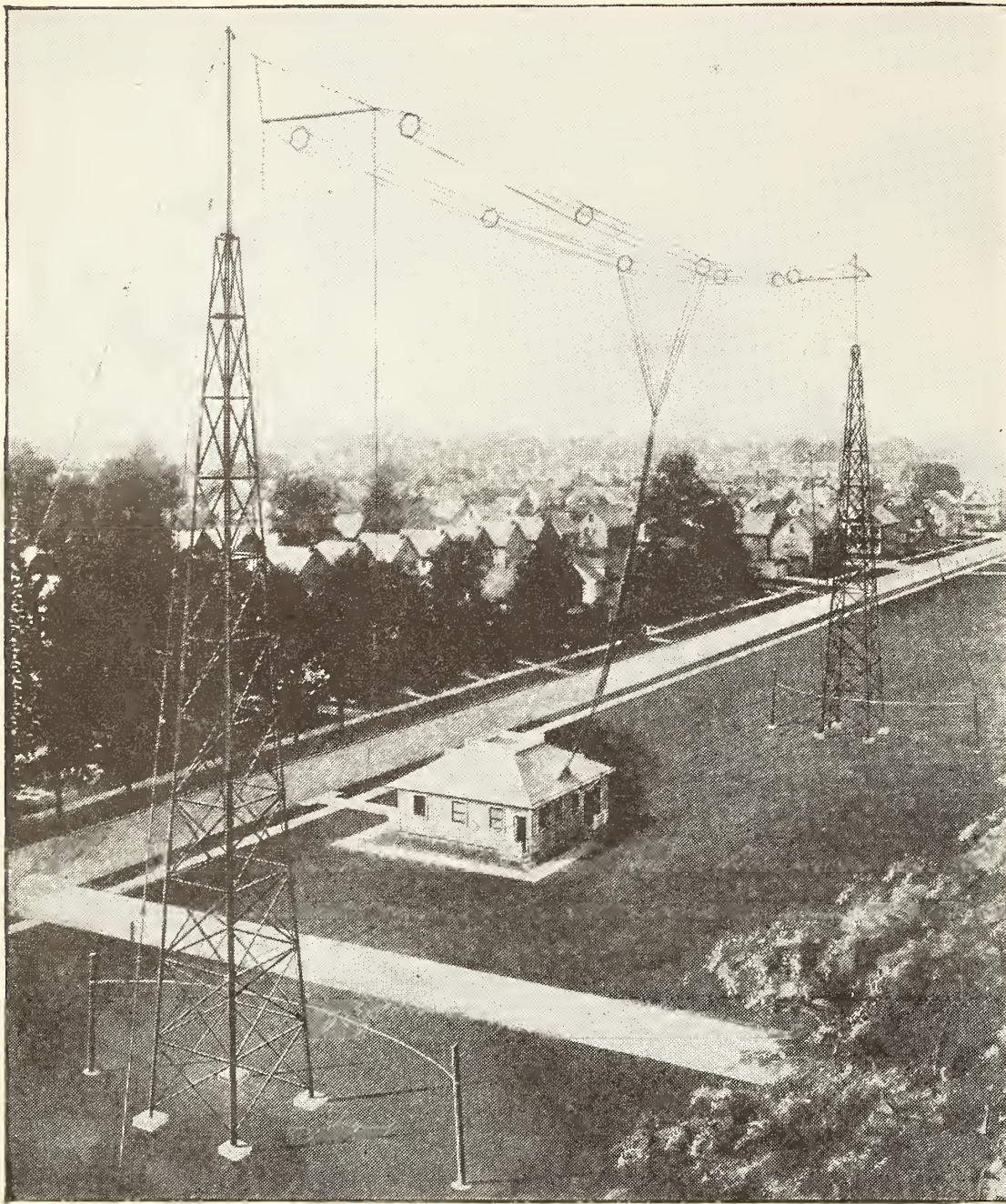

#### WTAM, RUN FROM STORAGE BATTERIES

This 1,000-watt broadcasting station, built and operated by the Willard Storage Battery Company, has recently opened up in Cleveland, Ohio. It sends on a wavelength of 390 meters

power from the explosion! How many people have had their concepts of the boundary of the earth's atmosphere clarified and put into quite definite form by the newspaper items to the effect that "Macready had reached the ceiling," that the air was so thin and cold at the height of seven miles that a gasoline engine could not properly function! We learn applied science of this sort nowadays without effort; or rather, it is absorbed, not learned.

Not many years ago, the idea that the current which the ordinary continuous-current generator delivers is not exactly uniform, or "smooth," was of interest only to a few telephone experts who were trying to make their long-distance lines more quiet. The very term "commutator hum" meant nothing at all, even to most technically trained men. Yet

to-day the twelve-year-old boy, tuning in on some broadcasting station before the program has commenced, announces—"Yep, I've got 'em, 'cause that's their commutator hum."

And his idea is right. As the commutator, with its hundreds of segments, revolves at high speed, a slight disturbance is set up every time a segment breaks its connection with the brush which serves to carry the current to its load—vacuum tubes or what not. In the ordinary generator there are set up each second about one thousand of these disturbances which travel out into the wires connected to the generator; these disturbances communicate themselves to the modulator tubes of the broadcasting set and so the characteristic commutator hum is heard even before the modulator is excited at all by its microphone circuit. Very little experience is necessary to recognize some of the broadcasting stations by the quality of this hum; in fact it is even possible for the engineer

familiar with the behavior of electrical machinery to tell by this hum whether or not the operator of the station is giving his generators proper care.

In a well designed modulator circuit this commutator hum is largely suppressed by suitable "filters"—combinations of coils, resistances, and condensers. It is reduced to such a low limit that it is inaudible during the program, except in the pianissimo passages.

A new station has just been granted a license, and put into operation, in the radiation of which the commutator hum will be entirely absent—for the very good reason that there is no commutator in the station. The Willard Storage Battery Company has started broadcasting from its station WTAM, where all power requirements for oscillators, modula-

tors, amplifiers, etc., are furnished by their well known storage batteries. About 1,400 full-size storage cells, all connected in series, are required to give the high voltage power for the plate circuits of the oscillators and modulators, and other batteries are used for the filaments, control circuits, etc. The station is at a good distance from other disturbing factors, such as trolley systems, so that when the microphone of the modulating system is short-circuited the transmission should be completely quiet. The only way to hear the station when its oscillators are putting current into the antenna and the modulators are silent will be to set up oscillations in the receiving circuit so as to get the beat note.

From the description of the station it should prove a real addition to the list of high class broadcasters.

### Radio Hazards and Insurance Rates

**W**E HAVE at hand a very interesting report on the hazards of radio, the report having been compiled by a committee organized for the purpose of investigating them by the National Safety Council, an organization serving the insurance companies of the country.

Considering the great number of receiving sets which have been put into operation during the last year or two, the report says, "the number of accidents has been very small." The principal hazards of radio are then enumerated. It turns out that they have very little to do with radio itself. "Collapse of antenna masts, due to insufficient guying" (the same thing happens to clothes poles), accidents due to "climbing in unfamiliar places" (small boys have always done that before the days of radio), "gasses from storage batteries", and "putting nails instead of fuses in the lighting wires," are among the risks noted. Evidently the use of the modern receiving set does not necessitate any of these risks.

A year or so ago we went on record as saying that the installation of the ordinary small, low, antenna used for receiving would add but little to the risk of fire from lightning, especially if a proper arrester was put in. Such now seems to be the accepted fact, as the report continues:

"Generally speaking, fire insurance companies will not be affected adversely by the installation of radio receiving sets, even with an outdoor antenna. It is suggested, however, that those who wish to make certain of this point, call up their insurance broker, who will either give a verbal consent to the addition or will issue a radio permit endorsement for the fire insurance policy *without extra charges or change of rate.*"

If there is no change of rate in the fire insurance we may rest assured that there is mighty small risk incurred by the installation of our receiving sets!

### The Broadcasting of News by the Daily Papers

**T**HE few newspapers which have installed broadcasting stations have not, up to the present time, used them in a way which we believe will become customary a few years hence.

It would be worth while for the wide-awake

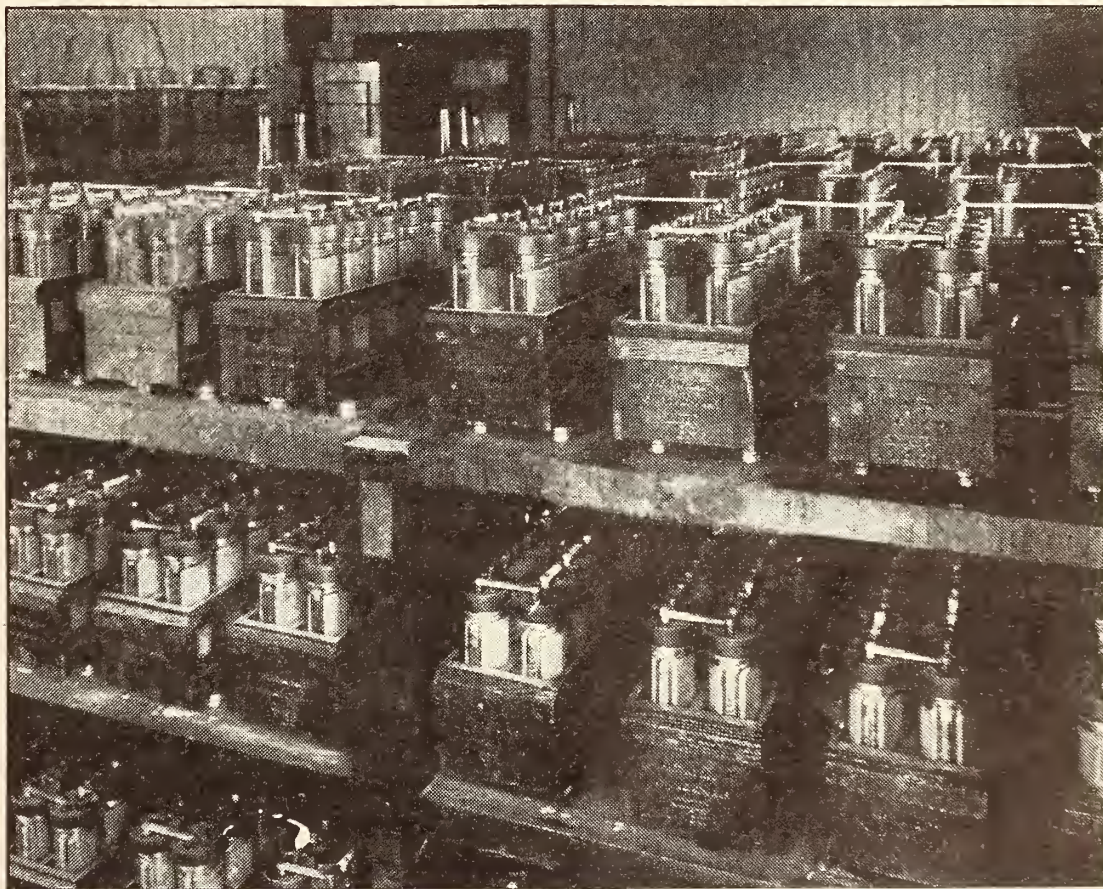

A FEW OF THE 1,400 BATTERIES THAT SUPPLY THE JUICE FOR WTAM Station of the Willard Storage Battery Company in Cleveland, Ohio

program manager to notice how many men, on their way to or from work, read their daily papers; they scan the headlines hurriedly and note whatever topics are interesting to them. They do not then throw away the paper, but keep it for further perusal when more leisure is available, and the items which are then first read are those which were headlined in such a way as to attract attention during the first cursory examination. That is, a man does not use the headlines primarily to get the news from the paper, but to determine what columns are worth reading. The front page is what sells the newspaper, and the headlines are the selling agents.

Now, if this is so, why should not an enterprising newspaper take ten minutes a day in the evening when most people are at home, to put the important news items of the day on the air. They don't because, so the skeptics say, if the people already have the news via radio they won't bother to read a paper. This is certainly not so; if the radio news items are properly worded, they will convey not only news but also the impression that it is well worth while to buy the paper to get the rest of the facts.

This use of radio, putting real news on the air, is as yet practically untouched, although it is probably one of radio's most promising fields. The possibilities of the service were apparent in New York City recently when practically every paper had to suspend publication because of an unexpected strike in the press rooms. Had the radio news service been developed, the principal news items of the day would have been disseminated almost as well as if the pressmen had not walked out. And we are perfectly sure that this radio news service, instead of cutting down the circulation of the newspaper carrying it on, would rather augment it—that is, if the items selected comprised the really worthwhile news of the day, the kind of items used for the headlines of the successful paper.

#### No Confirmation of Marconi's Sunset Line

**M**ARCONI'S early attempts to depict signal strength were, of course, very crude and unreliable. The only measuring instrument he had was the ear, and this is probably the most deceptive organ for making measurements that we have. In the laboratory

we frequently test students to find out what, if any, conception of signal strength the average man has. It is remarkable how divergent the opinions are. We make a certain signal, of certain strength, and ask the student to record, in his memory, how strong the signal is. Then we increase the signal to perhaps five times its former strength and ask the question—How strong is this signal compared to the previous one? Man has never used his ear to estimate strengths of sounds as he has trained his eye to measure distances, so no wonder the opinions are so divergent. A given class will report strengths ranging from perhaps 25 per cent. stronger to 100 times as loud, for the signal actually five times as loud. It is astonishing how infantile in ability the ear is in this special task, to which it has never been trained.

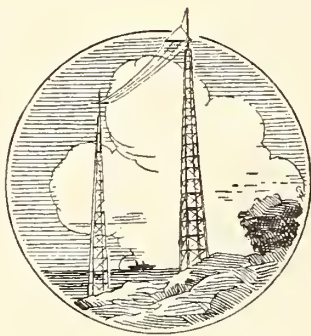

It is no wonder then that Marconi's results, in which he showed a definite decrease in signal strength whenever the sunset line, or sunrise line, was between the communicating stations, were frequently questioned. During

the last year or two, remarkable progress has been made in the technique of testing the strength of radio signals. At the Naval Research Laboratory, Doctor Austin has been making measurements of signal strengths from transatlantic stations over long periods of time, and his results show definitely the great difference between winter and summer transmission of radio waves. When the recent successful attempt was made to telephone across the Atlantic, through the combined facilities of the Radio Corporation and the Western Electric Company, it was at once evident that here was a good opportunity to get much needed information on the variation of signal strength.

With accurate measuring apparatus, signal strength measurements were made every hour over long periods of time. The great difference between day time and night time signals, with which every radio listener is acquainted, was measured day after day. The average of many readings gives a night time signal eighteen times as loud as the day time signal. The loud signals are obtained only when darkness exists over the whole path the waves have to travel; this is a small fraction of the day during the long summer days, as compared with about eight hours of good transmission in the winter months.

The results show a regular decrease in



strength lasting about four hours, the time taken for the sunrise line to sweep across the Atlantic from east to west, and a corresponding rise in strength as the sunset line follows it, about 12 hours later. When the sunset or sunrise lines are between the two stations, however, there is no excessive drop in signal such as Marconi found. The decrease in strength seems to be directly proportional to the amount of daylight between the two stations. Throughout the day the signal strength is very uniform, and low, lower than when the sunset or sunrise line is between the stations. For the wavelengths used in these tests, then, Marconi's two dead periods do not exist. However, this is not conclusive evidence that Marconi was wrong, because these same tests showed no appreciable fading, whereas every one of us is convinced that such a phenomenon does actually occur, and to a marked degree. It will be necessary to get much more data on radio wave transmission before we can begin to formulate the laws in accordance with which our radio signals travel.

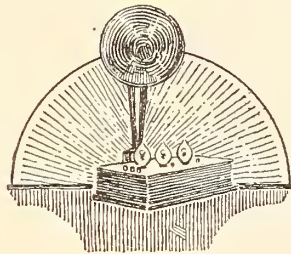

### British Radio Policy

IT WAS a foregone conclusion that any solution of the radio problem in England must be one which would link together all the high-powered stations, not only in the United Kingdom, but in all the colonies and dominions across the seas. It seemed at first that the Marconi Company and the Government would proceed separately, with possibly also other interests operating in the radio field, but a despatch from our London Consul indicates that private and government interests have been pooled. An agreement has been reached between the Post Office Department and the Marconi Company, and tentatively with the Eastern Telegraph Company, to operate their stations as a single system. This will obviate the necessity of duplication of stations and will unquestionably result in less interference than would otherwise occur. According to an announcement of the Department of Commerce, it is the opinion in England that:

"The agreement reached by the Post Office with the Marconi Company is believed to be unique in the history of telegraph operation. The telegraph services of the empire are to be conducted by the wireless pool, consisting at

present of the Marconi Company and the Post Office, although it seems certain that the Eastern Telegraph Company will be taken in at a later date should its plans for stations in India and China meet with success. The wireless stations necessary for the proposed imperial service will be furnished in certain agreed proportions by the two parties to the contract, the company furnishing two stations in the first instance and the Government one. The position of the Government in the communication field is greatly strengthened by the consummation of this agreement and it is probable that the approaching coördination of land telegraph, international radio, and submarine cables will form a world wide system of communications for the British Empire that will result in very effective government control of the whole field."

### Where is the Alternating Current Filament Tube?

ABOUT eight years ago, one of the well known writers on radio matters pointed out some of the advantages to be gained by completely changing the design of vacuum tubes. Instead of getting the electrons from a hot filament they were to be obtained from a thimble, which itself was to be heated by a tungsten filament inside the thimble. The detecting efficiency and amplifying power were much better, and other advantages, not so evident at the time, were to be gained by introducing this change in tube construction. Alternating-current power might be used for heating the filament and still the sixty-cycle hum would not be bothersome, as it is to a prohibitive extent with the ordinary form of tube when operated on the ordinary house wiring system.

Of course, it is generally easier to suggest an improved tube and make laboratory models than to get such a tube into successful commercial production; the placing of any device on the market must necessarily lag appreciably behind the first experimental models. In this case it was about six years before the new type of tube could be manufactured in a satisfactory manner, even though a great research laboratory had been working on the task. About a year ago, Doctor Hull, one of the best known research men of the General Electric Company, read an interesting paper before the Institute



#### A TRULY PORTABLE RECEIVER

Exhibited at the 2nd annual Radio Exposition held in New York in October. This five-tube receiver is an example of excellent wiring and design. It was entered in the amateur contest by Mr. Sidney Kasindorf

of Radio Engineers, telling of his work in this field, which had culminated in the production of a satisfactory alternating-current filament tube, or uni-potential cathode tube, as they were first called. The newly developed thoriated tungsten which his laboratory had developed was just what was needed to build the thimble for this new tube.

The early experimenters had been obliged to use tungsten itself for the thimble, and this construction required such a high temperature for the heating filament that after a few hours' use (sometimes after a few minutes only) the filament was burned out and a new one had to be inserted and the tube re-evacuated. The XL metal (thoriated tungsten) gives off electrons freely at low enough temperatures so that the heating element, the enclosed tungsten filament, need not be operated at such destructive temperatures as was necessary at first.

In Doctor Hull's paper the characteristics of the new tube were unreservedly praised; it seemed to be the most remarkable advance

in tube construction since the grid was first introduced by De Forest. As the author of the paper stated at the time—it made at once possible a receiving set which employed no batteries at all: radio-frequency amplifier, detector, and audio-frequency amplifier could all be run from the electric power wires with which practically every house is equipped. The alternating-current power could be used for the plate circuit as well as for the filaments. It seemed that, from the standpoint of its power supply, the perfect receiving set was at hand.

We have waited over a year now for these new uni-potential cathode tubes. Because of patent agreements they can be put out only through the Radio Corporation, so our gentle inquiries are herewith directed to the home of World Wide Radio.

#### Canadian Trading Post Men and Engineers To Have Their Concerts

THERE are many trading posts in the northern part of Canada which are completely cut off from the rest of humanity during the long Arctic winter. The Hudson Bay Company, it seems, intends to try to reduce the monotony of its factors' lonely existence by installing receiving sets, hoping that radio entertainment will be tuned in from Southern Canada and the United States. Two of the Company's trading ships, we are informed, are carrying Westinghouse receiving sets far above the Arctic Circle, to try out the scheme this winter. If radio broadcasts can be received satisfactorily so far north, probably all the Hudson Bay Company's posts will be fitted with sets for next winter. The ships steaming north have reported so far that New England stations are received very well; but as the ships will soon be ice-bound we shall not hear of the performance of the Arctic sets until they return to civilization next spring.

We learn also that the engineers mapping northwest Canada are now using radio to keep in touch with their bases and for entertainment. These engineers, whose object it is to lessen the number and area of the blank white spaces on the government's maps, have previously been completely out of touch with the world for months at a time. The only news they received was by Indians and trappers who passed the news along by word of mouth. With the modern compact field sets, however,

the engineers keep in touch with home although they are often half a summer's journey away. In these two cases radio is proving a most important and useful contribution of applied science, to those who have needed it badly.

### Demonstrating Radio at the Fairs

THE national Chamber of Commerce, of whose activities we have made frequent mention, has recently been urging on the radio manufacturers the great possibilities of the county fair as the medium through which they could get in touch with prospective customers from the farming districts. It is an indisputable fact that the farmers of the country can profitably absorb a great number of radio receivers; and the fairs are the proper place to demonstrate the "profitably" part of the above statement, as one is generally in the mood to be shown when at a fair.

The manufacturer of good radio apparatus can well afford to send their representatives to these fairs to demonstrate the possibilities of radio as a source of useful information. Surely the market reports and weather predictions must be of importance to the farmers of the country, or the Government would not be sending them out.

We hope, however, that the demonstrators do not try to outdo the vendors of tin horns, squawkers, and unlubricated farm machinery, as must have been the case last month with a radio dealer we know quite well. To his summer camp he took his radio and loud speaker, partly for his own amusement and partly to boom business among those who might be summering in his neighborhood. One of our neighbors had a camp close to that of the dealer, and he came back this fall with sentiments that could not be called friendly to radio. When will some of our dealers understand the prospective buyer's reaction to such performances and profit by the knowledge?

### More About Short-wave Transmission

THE more we think of short waves for radio transmission, the more the idea appeals. The work of Franklin and Marconi in England, and of the Westinghouse Company and the Bureau of Standards in this country, prove beyond doubt the feasibility of employing a range of frequencies at present used by no one. The amateur is apparently of the opinion that 3,000 kilocycles (100 meters) and higher is not a useful range for him, but actual experiments show this range to be perfectly workable, and it must therefore soon be used by some one or other. The experiments of the Westinghouse Company in using 3,000 kilocycles for re-broadcasting, is, according to report, proving very successful.

Suppose we grant that for the time being it is not practical to use waves of less than 50 meters, except for rather short distances. The Bureau of Standards has shown this to be far from the truth, but as the range is undoubtedly not large, we will consider only the range between 50 meters and 100 meters, that is a frequency range from 3,000 kc to 6,000 kc. If we allow a frequency band of 20,000 cycles between adjacent channels, this unused high-frequency band will permit the non-interfering operation of 150 channels. *This is six times as many channels as are to-day available for all our broadcasting*, if we allow the same separation of channels. Just think of it, these 150

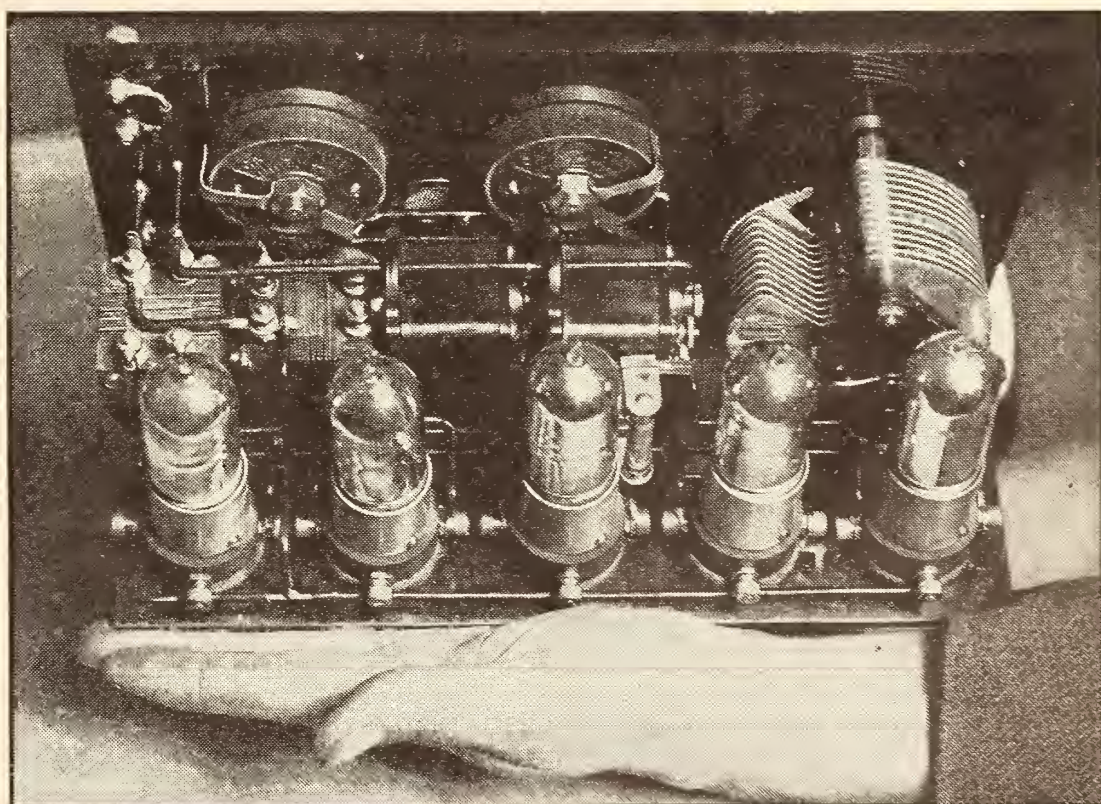

THE INTERIOR OF MR. KASINDORF'S SET

channels would be so far apart that the beat note between the two stations closest together in the series would be inaudible!

What is the draw-back? Well, it is not possible to send a great deal of power at these high frequencies, but the question at once arises, Is it necessary to send a deal of power? And the answer is: It depends upon the kind of receiving set used. A radio-frequency amplifier for a 6,000 kc current would be difficult, if not impossible to build; but here the super-heterodyne comes to the rescue. It seems that 50 watts, at 50 meters, with a good super-heterodyne receiver, might well be better than 5,000 watts at 500 meters with the ordinary receiver. We think the future of broadcasting will be the brighter in proportion as more work is done toward the development of short-wave transmission.

### The Copenhagen-Bornholm Radio Link

**F**OLLOWING the example of the Ameri-

can Telephone & Telegraph Company in its installation of the radio telephone link to Catalina Island, Denmark has just started to use the radio equipment which puts Copenhagen in touch with Denmark's island, Bornholm, about 100 miles out in the Baltic Sea. The radio link is arranged for two-way communication and is installed in the regular duplex fashion: at each end of the channel is a transmitting station and a few miles away from this is the receiving station.

We are led to believe that Poulsen arcs are used for generating the high-frequency power. If this is so, it would seem that the station is far behind modern practice, for water-

cooled triodes are now generally used for installations of this kind. While we have in America several Poulsen arcs operating satisfactorily in transatlantic stations or for spans of a thousands miles or more, an arc would hardly be considered as suitable as a tube outfit for the few kilowatts needed in the Denmark radio link.

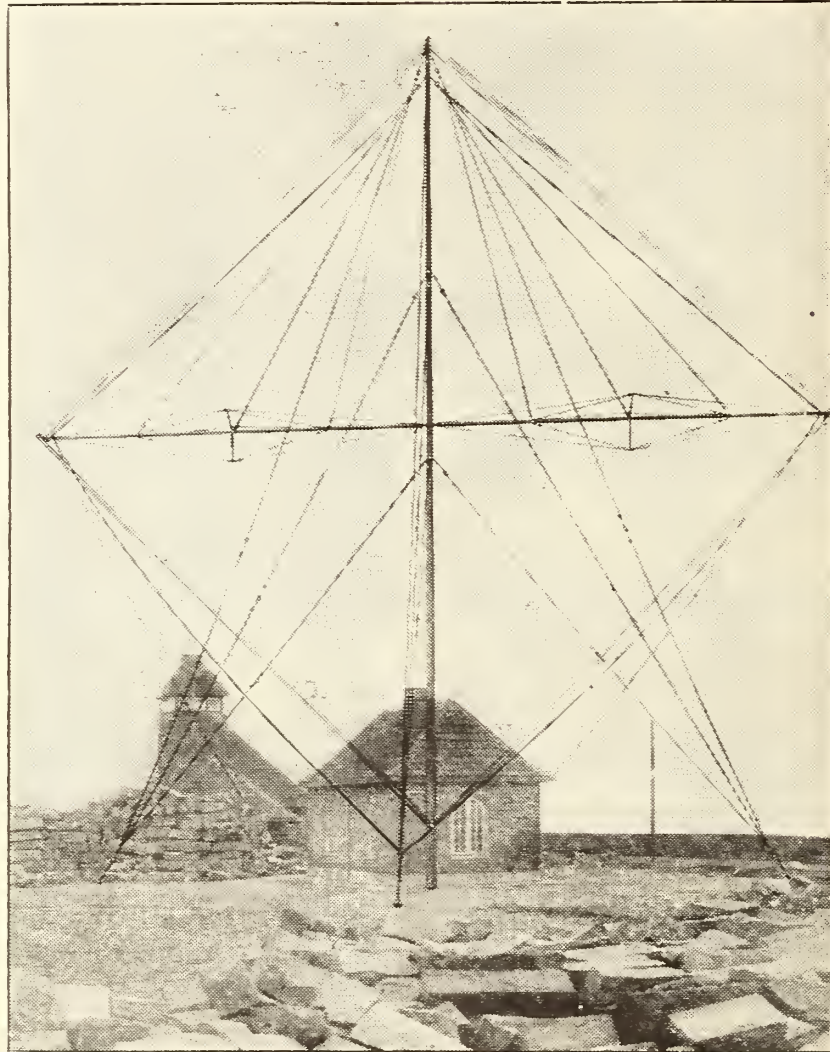

THE RECEIVING STATION AT BORNHOLM

Employs this monster loop held in place by a tall mast and many guy wires. It is part of a radio link something like the one we have been operating between Catalina Island and the mainland

It is anticipated that the Copenhagen station will soon be in telephone communication with Berlin, as tests have already indicated that the transmitting apparatus is sufficiently powerful to operate such a channel.

### Firpo's Admirers Quickly Hear of His Defeat

**T**HE excitement-loving South Americans who hoped their Pampas bull would bring back to them the world's approbation as its hardest and most accurate hitter naturally wanted to hear of Firpo's progress toward the championship as quickly as possible. The Radio

Corporation's channel to Argentine was given the task of carrying the message, and we are informed by the corporation, that a word description of the battle was broadcasted in South America with only fifteen seconds lag. Fifteen seconds after Firpo had Dempsey hanging through the ropes, the fight fans of his native country had the news, and were probably much more excited over it than was Firpo himself.

The natural question which occurs to one is: What were the radio waves doing during that fifteen seconds? Their 6,000 mile journey to the southern hemisphere should take only one thirtieth of a second. And that is all the radio

waves did take. The rest of the time was spent in translating words into telegraphic code and then back into words again. We are not equipped to carry on telephone conversation with South America as yet, but there is a reliable telegraph channel in operation, which was used on this occasion. The description of the fight was sent by telephone to a despatcher in the receiving room of Radio Central; here it was immediately changed to telegraphic code and punched on a tape; the tape was at once put into the automatic key which actuates the huge Alexanderson alternators and so the code was flashed to Argentine. Here the code was changed to words by an operator, who at once sent it out through a local broadcasting station.

Of course that is not quite as satisfactory as if the Buenos Aires friends of Firpo could have heard the punches and the cheers, as we did, but still, to get the news of the fight, 6,000 miles away, only fifteen seconds after the event, shows that we are making progress in communication.

### Makers of Neutrodyne Sets Already in a Patent Fight

**W**E MENTIONED in these columns some time ago the ingenious circuit developed by Professor Hazeltine, employing a principle which had not hitherto been put to practical use in receiving sets. It is not a simple matter to build a good radio-frequency amplifier, and the Hazeltine method for neutralizing the capacity coupling in the tubes permitted increased stability and reliability. The Independent Radio Manufacturers, an organization of the better known radio manufacturers not connected with the Radio Corporation, have been building and marketing these neutrodyne sets and have apparently found a good market for them.

It now appears that the Radio Corporation, through its associated company, the General Electric Company, had in its archives a patent which it believes covers the ideas involved in Hazeltine's patent, and the Corporation naturally started suit to stop the manufacture and sale of the neutrodyne sets.

Although the suit is brought against the F. A. D. Andrea Company, it will be defended by the Independent Manufacturers Association, which has been informed by their eminent counsel, Penny, Davis, Marvin and Edwards

that there is a valid defense against the Radio Corporation's suit. We sincerely hope that such is the fact, because it would be extremely unfortunate for the progress of radio if the Radio Corporation should acquire too monopolistic a control over its development. Healthy competition is absolutely necessary if the public is to be properly served in the radio field.

### Some Excellent Radio Health Talks

**T**HE American Red Cross goes about its work of human service, and leaves the shouting to others. The organization's Boston Metropolitan Chapter has just published the 38 five- to ten-minute practical talks on health, written by Mr. Henry Copley Greene with the coöperation of many eminent medical men and women of Massachusetts, and broadcasted by Mr. Greene from WGI, the "Amrad" Station at Medford Hillside, Mass. In an introductory note to the book, which is called "Listen In," Dr. Richard C. Cabot, of the Harvard Medical School, says:

The outstanding merit of Mr. Greene's book is that it is never dull, yet never sensational. Most health books are very unhealthy and very dull. They paint countless "dangers" which the average man runs with impunity every day, because they are not dangerous. . . . But this book is interesting, and so far as I know, most of it is true. If you begin it, you will probably read it through, and remember much of it. There are extraordinarily few exploded theories in it; and there is a great deal of sensible advice—even exhilarating advice here and there. This. . . . is a remarkable achievement.

Among the topics which were broadcasted are: "When to Call the Doctor," "A Fair Chance for Mothers and Babies," "Keep a Good Heart," "Fresh Air and How to Get it," "That Tired Feeling," "Medical Bunk," "Steer Clear of Tuberculosis," and "Cleanliness." Although these talks have been heard by WGI's large audience, they deserve to be known more widely. We are glad to express our own appreciation of this fine service of the Red Cross, and to announce that those who wish copies of "Listen In" can obtain them at twenty-five cents each, post paid, from the Department of Health Service, American Red Cross, 73 Newbury St., Boston 17, Mass.

J. H. M.

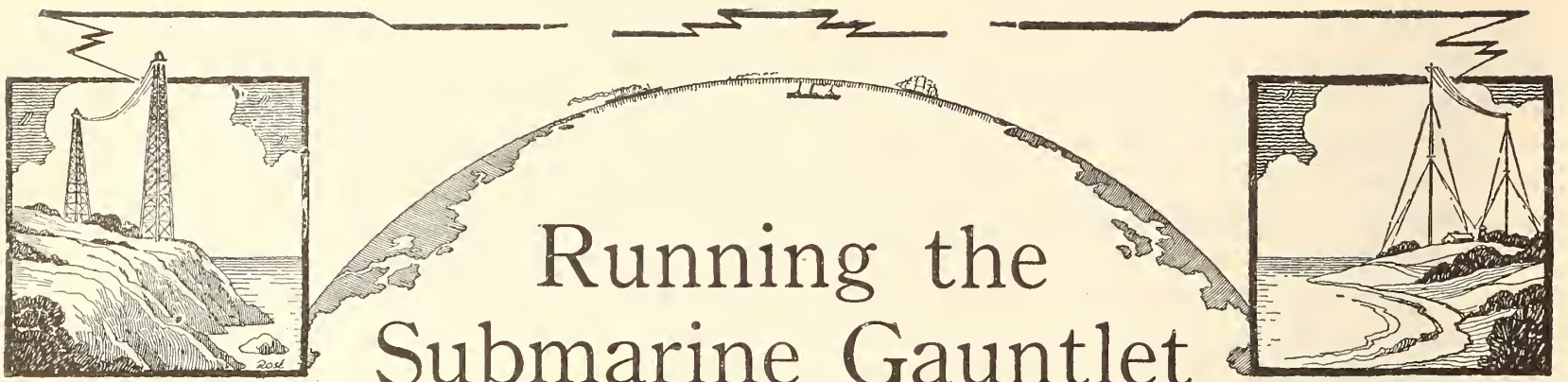

# Running the Submarine Gauntlet With a Cargo of "Gas"

The War-time Experiences of a Radio Operator on the Ill-fated Tanker, *Joseph Cudahy*. Incidents, Humorous and Otherwise, Touching on German Tactics, Getting Out an SOS Under Difficulties, and Three Days in an Open Boat

By HAYDN P. ROBERTS, EX.-U. S. N.

**B**OOM Z-Z-Z-Z-Z-Z-Z-Z— POP!  
SUBMARINE! GENERAL  
QUARTERS!"

The ship seemed to become suddenly alive. Bells clanged, orders were shouted, and the gunner's mates rushed from all directions to the guns. To those of the crew who had been to sea before, the clanging of the warning bell generally meant that "Some fool had sighted a floating spar or the like," but the sound of a gun added a touch of reality that made even the "old boys" stop and take a look.

As I was not on duty in the radio room, I had been basking in the sun on deck with the ship's doctor, playing jazz records on a small but seaworthy phonograph.

About a quarter of a mile ahead of us was a Greek ship which had lost the convoy on account of her inferior speed, and although she was faster than we, decided to keep us company on the trip over, for she liked the looks of our "3-inchers," in comparison with her "1-pounders" (known to the gobs as "Pea-Shooters"). We called her the "Wop" and it was from the "Wop" that the "BOOM! Z-Z-Z-Z-Z-Z-Z— POP!" came.

At first we thought it was target practice, but when we saw her stacks begin to belch black smoke and saw her change her course ninety degrees and make off at top speed (nine knots per), we realized that she had seen something. Our guns were by this time all manned, but we had not sighted anything to shoot at.

"BOOM! Z-Z-Z-Z-Z-Z-Z-Z— POP!"

Again the "Wop's" pea-shooter flung its charge of shrapnel, which even if it had reached its mark, would have been as dangerous as rain-drops on a window-pane. This time the aim was good, and after the shell had exploded and the black smoke had lifted, we were able to sight an enemy sub's periscope, which rapidly rose above the surface, the gunners getting into action while the decks were still awash. The "Wop" left us to do the fighting and seemed in a hurry as she steamed away from the scene. By this time the sub had sighted us, and since we looked like bigger game, opened fire. My

curiosity kept me out on deck until two shots had been fired. Then, upon the arrival of a messenger from the Captain with orders for a distress signal, I went into the wireless coop and relieved the operator on duty.

My dreams were at last realized: I was actually in charge of the radio on a steamer while in action with the enemy. I had for eight years been hitting a radio key, waiting for this chance. It was much more interesting than merely being shipwrecked or disabled.

We were about 350 miles southeast of Newfoundland, and carried a cargo of 96-test gasoline destined for aeroplanes in France. Three and a half million gallons of it, and a quarter-kilowatt radio set to try to call for help with. It was not especially comforting to think that if a single German shell found its mark we would stir up quite a little commotion for Father Neptune.

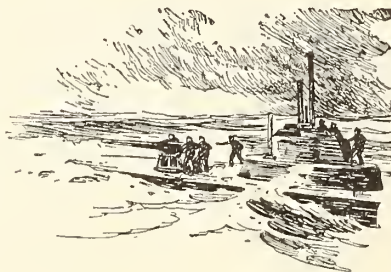

Closed up in a four-by-six radio shack, sending SOS as fast as my "fist" would permit, and ducking every time I heard a shot, was the way I spent the next five minutes. One radio man had thoughtfully brought me a life-preserver, but I hastily told him that in this case a life-preserver to be of real use would have to be a balloon. No radio man was ever so exasperated as I was at that time, when the signals from St. Johns, Newfoundland, came roaring into my phones and the land station could not hear even a squeak from our little quarter-kilowatt.



THE SEAWORTHY PHONOGRAPH FURNISHING JAZZ

From a photo taken at Hoboken, N. J. just before "Smoky Joe" sailed on her last voyage

However, in the midst of all this, I noticed that the shelling had ceased. This did not comfort me, for on a previous occasion a sub had quit shelling in order to get into position for torpedoing. I had made up my mind that this was the case, and was awaiting the crash which would mean that a torpedo had found its mark, when one of the gunners joyously informed me that we had hit the sub on the ninth shot and had either disabled or destroyed her, for she had submerged following an exploding shell. This was almost too good to believe, but the fact remains that we saw no more of Heinie and whether the sub sank or just submerged worried us very little.

After a few remarks on what *might* have happened, the crew returned to their duties, or to their card games or phonograph, and thus ended the first chapter of our trip.

We had left Hoboken, New Jersey, four hours after the convoy, having been delayed in getting water, and when clear of the harbor all that we saw of our convoy was some smoke on the horizon. In fact, this was all we ever saw of it, for it was a  $9\frac{1}{2}$ -knotter, and we—the U.S.A.C.T. *Joseph Cudaby*, otherwise known as "The Pride of the Atlantic" and also as "Smoky Joe"—could make eight whole knots when we hung weights on the safety valve and all the firemen worked overtime. We were bound for La Pallice, France, with a cargo worth three times as much as the ship in figures and twenty times as much as the ship in our opinion. She was a typical old "tanker," with

a flat bottom and no bilge keels. When she hit a sea, she sailed farther sideways than forward. She carried a tall, lanky, ugly smokestack far aft, and her lines were far from beautiful. She was manned by forty-four civilians and twenty-two navy men (including gun crew and radio crew). It was a rare and motley bunch: there were hoboes, land-lubbers, old sailors, new sailors ("hard-boiled" and "soft-cracked"), doctors, lawyers, editors, and college graduates. They were out for an experience. Believe me, they got it.

The different types of men on board presented a wonderful opportunity for the study of human nature, and it was interesting to note how each man acted while under fire for the first time. There was, for instance, Clark, known as "Sparks" one of the radio operators, a typical cowpuncher from Arizona. At the first warning of danger his face gleamed with a smile from ear to ear, and he came prancing down the deck hollering, "Gee Chief, ain't this great!" Then there was the assistant engineer, who always delighted in telling us of his little farm and family and how this would be his last trip across, whose dream of coming home again seemed to have been shattered when the general alarm signal sounded. His expression became tense, and with a ghostly look he watched everything that happened with concern.

There was the Captain, a big, burly Dane, who had weathered the fiercest storms and had been to sea all his life. There was the Chief

Gunner's Mate, who immediately took upon himself the full responsibility of "getting" the sub, calmly directing the action of the navy gun crew as though it were target practice.

There were the seamen, a crew of hardened men used to all sorts of dangers, watching everything that took place with intense interest. The most interesting of these, however, were the gunners' mates on the gun platform, pushing shells into the guns as quickly as possible, getting the range, and firing with a determination—"One, two, check, fire," etc., until they finally reached their mark on the ninth shot. Then there were a number of others who ran about the deck wrapped in life preservers, ready for the call to the life boats and in everyone's way.

Soon rumors of trickery on the part of the submarine captain started about the ship, to the effect that the sub had submerged only to



follow us and get us in the dark. Although none of the gun crew would believe such a thing possible, a sharp lookout was kept aft until dusk that evening, and the glasses were turned upon any conceivable object until it had

faded out of sight. However, the night passed quietly, and dawn the next morning found us steaming ahead at our eight knots per, on our way to France.

As the days passed, the signals from American stations became weaker, and many died out altogether, until only the old faithful government station at Arlington, Va. (NAA) could be heard. We then began to pick up weak signals from European stations, and succeeded in getting our weather reports and time signals from Eiffel Tower, France, before we lost Arlington's signals, thus having continuous weather and time service all the way across. As soon as signals from Spain, France, and the Azores began to come in, we got dozens of submarine warnings. We nailed up on the radio room wall a large map of the Bay of Biscay, and began to put crosses on all positions where submarines or mines were reported. The map soon was a mass of crosses. The Captain at first tried to take a course which would avoid these points of danger, but they came in so

thick and fast that he was unable to do so. After dotting up his map all over the Bay of Biscay, he decided to head straight for our destination, for one course looked just as safe or just as dangerous as another.

As we approached the coast of Spain we had our next bit of excitement. One night, about midnight, the general alarm signal sounded, and everyone was up and out on deck immediately.

Dead ahead of our ship was sighted a large steam schooner, directly in our path. We instantly changed our course to avoid a collision, and at the same time, smoke belched out of her stacks, and she started to steam away at top speed. It was evident that she had not been in motion until she had sighted us. She had stayed in her position for a few moments before moving, to hide a submarine which was trying to submerge quickly under cover of the large ship. Our guns were immediately trained on the submarine before she had completely submerged, however, and we covered her without the least trouble, being probably not more than two hundred yards from her.

In maneuvering to avoid a collision she had to expose the submarine before it had actually submerged. The gunners' fingers were itching to fire, for they could have destroyed the sub with one shot, but the innocent-looking "sail-boat" without doubt had large guns concealed and could have put us under without the least effort. For this reason, the Chief Gunner's Mate told the gunners not to fire as long as we were not fired upon. The commander of that large mysterious ship must have had the same line of reasoning that we did. He was satisfied to let us alone as long as we let her alone. We thought that just as soon as the sub had fully submerged we might be followed and destroyed, but the enemy undoubtedly knew that at her first shot our wireless would have shrieked out a call for help, and three or four speedy destroyers would be on their way to comb the bay for this raider. However, we kept a double lookout the rest of the night, and very few of us got any more sleep.

The next morning we received a radiogram from a Portuguese station, which warned us





that there were two subs operating in our vicinity, and that we were also approaching the dreaded mine fields north of Spain. We had been "zig-zagging" now for two days and nights, for we were in the "war zone" which Germany had marked off as forbidden territory for neutral ships. Our chart of sub and mine warnings was pretty well covered up. I regret that I was not able to save it and reproduce it here. We were now going through a most hazardous part of our journey, with the chances of encountering both mines and subs. A mine is the worst engine of destruction, so we tried to keep as far as possible out of this district even to the extent of taking more chances with the subs. A mine gives you no warning, no opportunity to fight or maneuver; it's just there, and when you hit it, goodbye. For two solid days and nights six men kept their eyes glued to the water in front of them, reporting every conceivable object. The shining glare of the water made many of them sick with headaches. The ship would be instantly turned out of her course for a log or stick or any floating object whatsoever. The crew whose quarters were to the extreme forward part of the ship slept on cots back in the fantail these nights, although even this would have been little protection to them had we hit a mine with the cargo we carried.

We were greatly relieved when we had passed the north coast of Spain and were practically out of the mine territory. We were now approaching La Pallice, France. The day before we sighted the French shore there came another sub warning which showed us that a sub was operating right at the mouth of this harbor, but this didn't worry us much, for we felt sure that by the time we reached that point we would have some form of protection, such as a destroyer or patrol boat. We finally sighted shore about nine in the morning, but as yet had seen no signs of a patrol. A message was sent to the commander of the port, asking that a pilot be sent to meet us immediately. The message was received and acknowledged

by the station at Nantes, and we steamed along at half speed for hours waiting for a pilot, right in the location which was reported to us as being dangerous. In addition we flew our pilot signals at the mast-head. Soon we sighted an observation balloon, which surely must have sighted us and reported, but still we saw no escort. The balloon was equipped with radio, and we expected that we would now get our pilot. Three hours later the Captain decided not to stop the ship in dangerous waters, and proceeded to find the harbor with the aid of his chart. We took frequent soundings, but knew nothing about the channels. At any rate, it was comforting to know that if anything did happen now we could easily swim ashore. Sighting a row of piers ahead, we picked out a likely looking one and started for it. In the distance were two American and French destroyers at anchor and numerous other ships. While proceeding slowly, we finally saw a tiny French patrol boat approaching us at full speed. The commander was standing out on the forward deck waving his arms frantically and hollering something un-



A FEW ROUNDS FOR EXERCISE

This gives some idea of the *Joseph Cudaby's* handsome appearance

intelligible at us. I finally heard him cry in his best English, "Stop, stop, stop!" I reported this to the Captain on the bridge, and we reversed our engines probably just in time to prevent our running right into a mined net, and possibly being blown up by a mine of one of our allies.

It all happened so quickly that none of us

realized how close we came to being destroyed. The little Frenchman finally guided us around the nets and inside the safety zone. His boat then came alongside and we had quite a chat with the crew, for our ship's doctor was an able student of French. We found that the latest news at that time was that the Americans were rapidly advancing their battle line toward Berlin. We rested uneasily that night for none of us could get ashore, and in the morning we found that we would have to wait two weeks to get a chance to unload, so we were given orders to proceed to Pauillac, a little town on the Gironde River about thirty miles from Bordeaux.

We weighed anchor, and steamed out of the harbor and down along the coast toward Bordeaux. The scenery along the French coast was wonderful, for it was in the month of July, and we all enjoyed sailing within sight of land. When we arrived at the mouth of the Gironde River we were met by a pilot, who told us that twelve hours previous to our arrival a transport had been torpedoed right off the mouth of this river, and many soldiers had perished. Our pilot guided us up the river to a little hamlet about three miles beyond Pauillac, where there were about a dozen houses and a large tank, where we were to unload our gasoline. We dropped anchor, and within twenty minutes practically the entire naval crew were ashore.

It is with difficulty that I omit a description of many interesting experiences on shore. But there were some lively times in store for us on the high seas, and these are what I am getting at.

I was anxious to receive our sailing orders, for our set had been sealed by the French authorities when entering the river. It was amusing to notice how they sealed our apparatus. The antenna switch was sealed half way between the sending and receiving positions, and if we had desired it would have been an easy matter to run two wires across the switch!

Off to the starboard we could see through the glasses a large amusement resort with many bathers in the water, but as we were at anchor and also "broke" we were anxious to get started for home. Finally one morning, six destroyers, two airplanes, a blimp, and a few "skeeter" chasers arrived, and we set off in a convoy of about thirty ships. We had hardly got started when submarine warnings began to come in again thick and fast. Being the slowest ship in the convoy, we soon took our place at the rear—where the subs could get an easier shot at us. Once in a while one of the destroyers would come back and give us the once-over, wondering whether or not we were moving. So did we, but the indicator showed "Full Speed Ahead."

Just before the airplanes left us they dived back and forth between our masts, or as near as the radio antenna would permit them. This was their playful way of saying, "Good-bye, you poor nuts, why don't you get a safe job like ours?" The destroyers, with their speedy lines and low rakish appearance, seemed impatient to slip away, and at dusk the "skeeters" turned, one by one, and headed back to France, after tooting a good-bye. That evening I received war news from Nantes, Lyons, and Eiffel Tower, and was glad to report to the

## SURVIVORS OF JOSEPH CUDAHY REACH AMERICA

British And Greek Steamers  
Land 38 Members Of Crew  
At Atlantic Port

VESSEL TORPEDOED  
WITHOUT WARNING

Sixty-two Persons On Steamer  
Shee Unaccounted For  
—Second Steward Lost

An Atlantic Port, Aug. 31.—A British steamer arrived here today bringing fifteen men, said to be survivors of the American steamer Joseph Cudahy, sunk by a submarine August 17, seven hundred miles off the British coast. The men report a Greek steamer also picked up other members of their crew and they also were brought here today. Authorities here decline to deny or affirm that the men are from the Cudahy. The number of men picked up by the Greek ship could not be ascertained.

The men brought here said their ship was torpedoed without warning. Two torpedoes were fired, the first putting the wireless outfit out of order and making it impossible to send out an SOS call.

### Captain Questioned

The steamer listed heavily and filled rapidly. The crew were ordered to the boats. As the men pulled away the submarine rose to the surface and ~~the~~ ~~steamer,~~

### WHAT THE PUBLIC KNEW OF IT

A clipping from a New York daily paper of August 31, 1918

Captain and crew that our battle line had materially advanced since the last news. The crew were interested in these reports to the extent that they kept in touch with our progress with a large map, running a red cord through a series of pins, showing the battle line, and every morning they would gather around outside the radio room, and we would move that red line a little closer to Berlin.

The following day we received a distress call from two United Fruit boats which were torpedoed within a few hundred yards of each other. They were about sixty miles dead ahead of us, directly on our course, and sailing east. They alternated, sending first in English and then in French. We watched to see what our destroyers would do. Soon a message was sent from the flagship in code, and three destroyers slipped away and over the horizon ahead of us at express-train speed. Eight hours later we passed the two ships at a distance of not more than two hundred yards. They had been torpedoed within a couple of minutes of each other, which must have been fast work for one submarine. They both were listing heavily to the port side. The lifeboats were all in the water, but most of the crew had already been picked up by the destroyers. There was at least one submarine in the vicinity and the destroyers were making things hot for it by dropping depth bombs all around.

The next day we heard, in wireless spurts, a thrilling and rather sickening tale. The signals were very weak—just readable. The first report told of sighting a submarine, and a little later an SOS told us that the ship was shelled. The screeching spark would stop, and then start, and each time the signals were heard there came another chapter of the episode. Then we got the report that the sub had found its mark, and the shells were taking effect. The next two reports I remember well. They were, "Sub gaining on us ship now afire

have been hit returning the fire SOS SOS SOS." Then the position was given. I could picture vividly the whole battle in my mind: the ship, with stern ablaze, surpassed in speed and guns by the enemy, desperately firing her stern gun, while some of the crew worked feverishly to extinguish the blaze. I could picture that radio operator, in a two-by-four room,

calling for help, and reporting the progress of the battle, not knowing at what minute he might be blown into "kingdom come." After six minutes' silence we heard the next report, "Sub submerging for torpedo attack." Then I could imagine the battle of wits, with the zig-zagging to the limit and the submarine running submerged at a greater speed under water, with no opportunity for destruction by shell fire. For the next ten



THE NAVY GUN-CREW AND OTHERS

They sank the first German sub encountered; the third sank them (but they were finally rescued)

minutes I know I was just as concerned as the radio man on that ship. I strained to get the next radiogram. It came all too soon. "SOS SOS SOS torpille, torpille, torpedoed," then giving the position. One of our destroyers sent the SOS broadcast, but did not leave us; and I have never been able to learn whether that unfortunate crew were ever saved or not, for after this message all I heard was a few struggling signals from the ship's auxiliary set which soon died out.

From then until late in the night submarine warnings came in thick and fast. About nine o'clock in the evening several code messages were exchanged between the destroyers which then turned and left us to our fate. It seemed like a great lack of judgment to me to leave us so soon, for we were positive of two, if not more, submarines within a radius of not more than a hundred miles. After testing the generator and spark, as well as the receiving apparatus, I decided to get some sleep, and called my relief at about 1 A.M.

The next thing I remember after "hitting the hay" was lying on the deck in my room in a half stupor, and stunned.

I pulled on a pair of trousers and a shirt and ran out on deck and into the radio room. The ship had almost immediately listed heavily to starboard, and the engines had stopped. We still had juice, however, and I quickly relieved the operator on duty, who had been knocked almost senseless. The radio room was a wreck. Condenser jars were broken, the receiving set had been ripped completely from its moorings, and all the connections had been broken off. The motor generator was the only thing that held its position, but its connections were broken. A pipe from the steam heating equipment had broken in the room, and the radio apparatus was hardly visible on account of the steam.

"Sparks," the cow-punching radio man, arrived at this time and was intensely interested and pleased by the excitement. He said, "Well, Chief, this looks like the real thing!" To which I replied, "It sure does; let's get this thing working again." I replaced the broken apparatus with spare parts, and got the connections all in place once more. On pressing the key, I was pleasantly surprised at hearing a weak spark in the transmitter. "Sparks"



then informed me that the antenna was lying on the steel deck, the forward mast having been broken in the middle by the force of the explosion, and carrying the antenna down, spread the wires in a hopeless mess all over the deck. I remember how glad I felt that I did not give a radio inspector in Bordeaux a spare coil of antenna wire which he tried so hard to acquire

while we were in France. "Sparks" and the other radio man got out this coil and proceeded to put up an emergency one-wire antenna from the stub of the broken mast to the pilot house. One man climbed the forward mast and started fastening the wire through an insulator to the mast. The other man went to climb the midship mast, to make another connection. We had worked feverishly to repair the apparatus and to get our distress call off, and had not noticed until that time that the lifeboats had all been lowered and there was only one man aboard the ship besides ourselves that we could see.

Just then I noticed old "Pegleg," the ship's steward, a man of about fifty-five years, with a withered left leg, crawling along the deck on all fours. He had been in his room below, and probably had been injured by the torpedo. He crawled to the ship's rail and slid over. I presumed that he had jumped into the water, where the lifeboats were, but later when we took a count of the men in the boats old "Pegleg" was missing, and no one saw him after he had jumped into the water. The other man we saw on deck was running around, looking for a good place to jump to the boats. We had little time to look after his welfare, however, and went on with our work. We knew that the sub would soon appear and probably shell the ship, for she was not sinking fast.

I returned to the radio room, made the antenna connection, and began walking backward unrolling the coil of wire, and was approaching the midship mast where I was going to make the final connection when another crash occurred, blowing the stern of the ship to bits. It was a second torpedo, and hit its mark in the place it was meant for—the engine room, directly below the radio room, and also broke the bulkhead into the oil tank. For about half a minute we had a steady shower of thick heavy brown fuel oil over everything and everybody. One lifeboat had been lowered on the port side, and had not yet reached the water. It was a remarkable escape for those in it, for the torpedo passed probably not more than ten or fifteen feet directly under them, and into the ship. This lifeboat was swamped by the oil, which filled it completely, but it did not sink, and the men worked fast, and were able to bail out enough of the oil to keep her afloat. Just a few seconds before the torpedo hit, I was standing, or rather walking, directly over the spot on the deck where an eight-foot hole was blown through by the force of the explosion, but I was twenty or thirty feet from this point when it actually occurred, and was knocked down on the deck, while pieces of flying metal landed all around.

The radio man who was up the forward mast was knocked practically unconscious by the explosion, and was only saved from falling to the steel deck below by the shrouds, in which he became entangled. In less than two minutes the whole aft end of the ship had sunk, and only the empty tanks forward kept the ship from going under altogether. All the lifeboats by this time were clear of the ship. The

only thing left on the deck was a life raft, but we remembered that we had tried to float the raft for swimming purposes when in the Gironde River, and it would have been down at the bottom of that river now if it hadn't been tied to the ship with a rope that held it from sinking. The electric light in the radio room had gone out, and we knew that the generators were under water and out of commission. There was nothing left that we could do, since there was no auxiliary set, and besides, at that time, the submarine came to the surface some distance away, and began training her guns on the ship, so we slid over the side and swam to the nearest lifeboat, which was not far off, on account of having been swamped when leaving.

The sub began to pour a rain of shells into the forward part of the sinking ship, some of them coming uncomfortably close to the lifeboats. They didn't seem to care whether they hit us or not, but since they hit the ship every shot, after getting the range, we concluded that they were not trying to fire at the boats. After putting about twenty-five shells into the ship, the ship rose high in the air forward, as if in protest at the kind of treatment she was getting, and then slid down stern first under the water. "Smoky Joe, the Pride of the Atlantic," was no more.

I sat in the lifeboat and listened to the peculiar sound effects as the ship was being shelled. The first warning of the sub's firing was the flash at the mouth of the gun; then the black puff of smoke; then the metallic sound as the shell struck the ship; then the explosion of the shell, and after all this we then heard the dull boom of the sub's gun, which did not reach us until after the shell had exploded. It was quite an interesting study of the time it takes sound to travel.

It was not until the ship had completely disappeared below the water that the sub approached the lifeboats, for she did not trust the forward gun which was sticking up in the bow until the last minute, and was taking no chances on there being a man hidden aboard to operate it, should she come close enough to make a good target. Very cautiously the sub commander manoeuvred around us with his gun trained on us all the time. Standing in the conning tower, he watched every move we made through glasses, and finally headed straight for us. There was much excitement in the lifeboats, for we thought the undersea boat would

ram us. There was other talk about taking us prisoners, and some talk of shelling us. However, just as it got within about ten yards of us it swerved around broadside alongside the Captain's boat, after passing a few yards from our boat. How he knew which boat the Captain was in was a mystery to me, for none of us had our uniforms on. After tying the Captain's boat alongside, the Hun commander began to question him in the best of English. There was hardly a bit of German accent in his voice, and he talked as though he had spent some part of his life in an English-speaking country. His voice was gruff and authoritative. His questions as near as I can remember them were as follows:

"Where is your captain?"

Capt. (After some deliberation): "Here."

"Where is your chief gunner?"

One of the crew: "Killed by the torpedo."

(At that time the Chief Gunner's Mate was in another boat.)

"Where is the radio officer?"

Mate: "He is missing."

(At that time I slid down into the bottom of the lifeboat, and was mostly under water.)

"What is the name of your ship?"

Capt.: "The *Joseph Cudahy*."

"An American ship?"

"Yes."

"Where bound?"

"Brooklyn, New York."

"From what port?"

"La Pallice, France."

"What was your cargo?"

"Gasoline, we were light, coming back."

"You are lighter now." (At which some of the crew grinned.) "What tonnage?"

"Thirty-two fifty."

"Speed?"

"Eight knots."

"That will do."

"Our wireless was disabled. Will you send a message for help with your set?"

(At this the commander and a few men of his crew laughed heartily.)

"Would you give us a tow part of the way toward land?"

"We are not out here to tow lifeboats, but to sink ships." He then pulled the signal gong

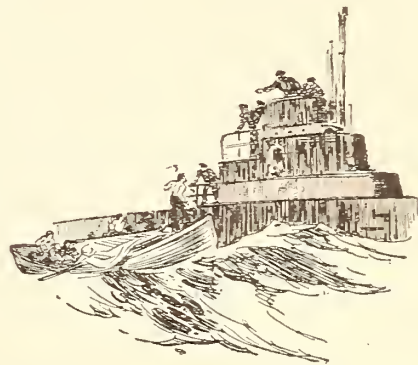

for "full speed ahead" and as the sub motored off using the gasoline engines, on the surface, he hollered, "It is about 700 miles to the Azores, due south, go to it." At this one of our crew hollered, "Yes, and it's only 400 miles to Berlin for the Yanks, too." Luckily the Hun commander did not hear this last remark, and the fellow who made it was promptly muzzled.

One boat then put up its sail and was soon lost to us over the horizon, while the three other boats stayed together. We were all in good spirits, and sang songs and told stories. We decided to attempt to row and sail to the coast of Spain. The mate and myself knew our position, and we figured it was about 600 miles to Spain, although we told the crew it was much less. We sailed as long as there was any wind, and also took turns at the oars. At dusk we decided to have our first "meal." We had a box of crackers about the size of soda crackers, which was soldered up airtight, and a small keg of water strapped to the bottom of the boat with metal straps, the faucet being so close to the bottom that it was immersed in oil, and it was impossible to get water out. We finally found a tin box full of face powder, and we poured this on our hands so that we could get a better grip on the oars and then used the tin for drinking purposes. This worked all right until some salt water came over the side and into the fresh water and then it was useless. The salt water didn't hurt the crackers much, for there was no salt on them originally, and they tasted better,

but those that were wet were not eaten freely on account of the thirst they created.

The mate was the "chef" and we ordered our meals with all the style and elegance of a Broadway

habitué. The orders came in thick and heavy, and varied from "Ham and—" to "Tenderloin steak with mushrooms," and each in turn received three crackers and a talcum powder can full of water for his order. I still have a portion of one of their crackers which I saved in the pocket of my life preserver, oil soaked and greasy, but the only souvenir.

The night was extremely cold, and as we had left our bunks in a hurry when leaving the ship,

not one of us was properly clothed except "Mike," a sort of half-witted fellow who used to sleep in his clothes, and was fully dressed. He even had an overcoat. We all envied Mike, but he wouldn't part with a particle of his apparel, and could not be bribed. Money, of course, was nothing out there: you couldn't have bought a cigarette for a thousand dollars.

A man of about sixty summers sat squeezed in next to me. It was hard to tell whether he was merely shivering or crying, and further investigation showed that it was both. When he shivered, I would shiver, and the man next to me would shiver, and so it passed all around the boat soon after dark, until the whole boat seemed to be vibrating.

I shook so much that night that my muscles were stiff and sore in the morning. The oil that covered our faces and bodies became hard and sticky. Our mate had a little compass which was all we had to tell our direction by, and it was not any too accurate. As best we could we laid a course to the Spanish coast. It was out of the question to try to row near the steamship lane, because during the War it did not exist. The sea was high, but luckily there were long rolling swells with very few whitecaps. We continuously were bailing water out of the boat as it kept coming in over the side. There was about six inches freeboard, with the seventeen of us in the boat, and it took very little to throw in a pail of water.

Some of the men were injured and suffered greatly during the night from their hurts and from the cold. I am not enough of a writer to attempt to describe all that took place in the lifeboat, and some of the agony endured by certain members of the boat's crew could not be written about. It was a scene that I hope never to have to witness again.

"Mike" would "come to" about every half hour and ask me in all seriousness whether or not our ship had sunk yet, and if the Boche had taken us prisoner yet. I would tell him the truth, and he'd say, "Oh, alright, Chief, thanks." In about five minutes he would again call me, and say, "Did you get off an SOS yet?" I would inform him for about the fiftieth time that we were now in the lifeboat, and that the radio had been destroyed and no SOS had been sent, to which he would reply, "Oh, alright, Chief, thanks." The old gentleman at my right, who cried almost all night as a child would do, would then open up with his story about the little home he had just bought,

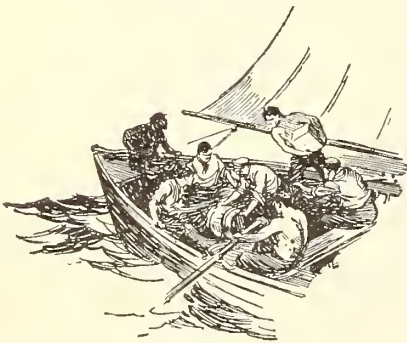

and his wife and children, and that this was to have been his last trip, because he could now pay off the mortgage and settle down. I heard this tale quite frequently during the night.

When the gray dawn appeared we discovered that we had lost another lifeboat, that of the first mate, which had drifted away from us during the night. As the sun rose, our spirits did likewise, and soon the warmth of the sun "thawed us out" and the oil softened and thinned, and although we became "well lubricated" it was a relief and a pleasure in contrast to the hard caky effect during the night. That day we all scanned the horizon for the sight of anything alive but didn't see a thing.

That evening and night I was spared the knowledge of what went on, on account of an injury I had received which relieved me of consciousness.

The third day we had all become quite accustomed to our predicament and seemed to feel better, although there was no reason for the feeling. Our water had become salty from the spray and brine which came over the side and contaminated it, and was about useless, but we still had somehardtack left. The mate, who had nerves of iron, continued to try to keep us in good spirits, and succeeded fairly well. A peculiar incident occurred that afternoon in the other lifeboat, which was full of navy men. Although practically out of food and water, they were sitting there supposedly quite contented, smoking cigars and drinking champagne! This seems rather ridiculous, but was the truth. In leaving the ship one of the men had taken with him a box or two of cigars out of the canteen and three or four bottles of champagne, which had been purchased in France.

That night we tied the two lifeboats together, to avoid losing one another during the night. This night was even worse than the others, for a rather strong wind had blown up, and the sea was beginning to act up in an uneasy way. Most of us were completely soaked with water in those few parts where the oil had not made us waterproof. We continued to row and sail when the wind would allow, and the knowledge of moving—just moving, regardless of where to—made us feel considerably better than lying still. Meanwhile, we had completely run out of smokes. It was smoking that kept up our spirits as much as anything, and we were out completely.

While engaged in making and smoking some cigarettes made out of old "butts" which we gathered from the bottom of the boat and dried, there was observed to be a lot of excitement over in the other lifeboat some distance away. They were shouting and waving their arms frantically to the extent of nearly capsizing their boat. We looked out on the horizon, and there was smoke. Real honest smoke which could have come from no other source than a real honest ship. It was a sight which we had hardly hoped for. "Mike's" handkerchief was raised in the air and waved frantically, even though a ship was not in sight. Nothing but plain smoke, and miles away. The mate brought us to our senses when he informed us that we were not yet rescued, and to cut out the noise and get to work on the oars. The idea was to head off anything that might come our way, and to this end the other boat went one way, and we another, as hard as we could row. It was with the greatest delight that we saw the top masts of a ship appear over the horizon, for we then knew that she was coming our way and not just crossing the horizon. We felt wonderfully relieved but still worried lest at this critical point we should still lose out. We continued waving, but it was evident that the ship hadn't sighted us yet, for only the tops of her masts were visible, and we were so small. As she approached, we could see more and more of her masts, and finally her pilot house.



At this point she suddenly seemed to turn directly at right angles and make off in a direction away from us. The mate swallowed hard, but kept the oars going just the same, with a determination to do all that was humanly possible. It was at this time that a rocket was suggested, but it would have hardly been seen in the daylight, and the mate thought best not to take any chance of being taken for a Boche "sub."

It was most peculiar to me that out of a clear sky at this time arose a mist that thickened into a quite heavy fog, and hid the entire horizon. The day was clear, although the sun was not actually shining, but it seemed the height of misfortune that such a fog should

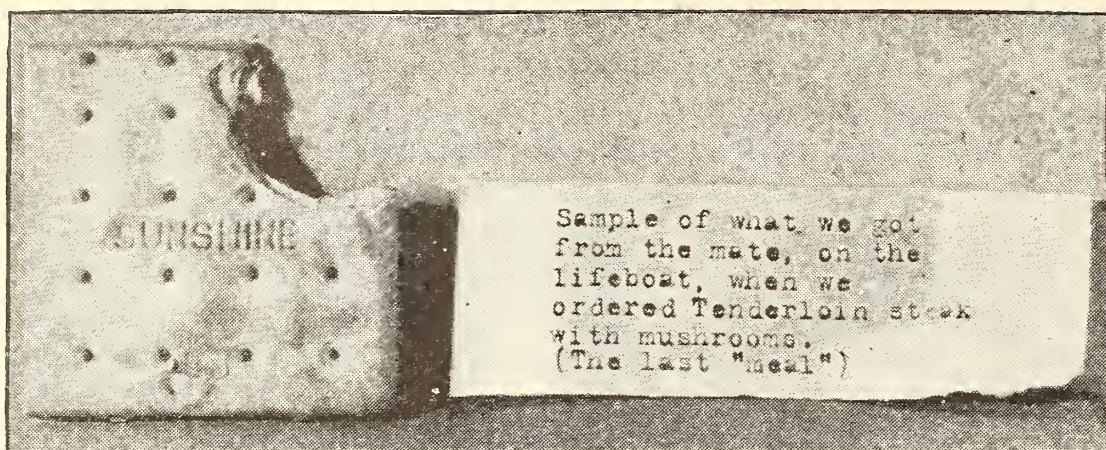

THE AUTHOR FOUND THIS IN THE POCKET OF HIS LIFE-PRESERVER,  
"AFTER IT WAS ALL OVER"

occur at this time. We continued rowing, hoping against hope that the fog would lift. We had lost sight of the other lifeboat by this time and we held our course as best we could. After about twenty minutes or a half hour of this, straining our eyes in an effort to pierce the fog, directly in front of us out of the fog appeared a tremendously large ship, traveling at slow speed, for she was gently cutting the water. She sighted us immediately, and slowed down. The ship was camouflaged heavily; and we did not know nor did we care what nationality she was. A line was thrown over, and as one of the crew grabbed it and held on, it nearly overturned us, on account of our inertia and the superior speed at which it was traveling. The mate yelled, "Let loose on that line, you damned fool, what in hell is wrong with you?" After a bit of maneuvering, we finally got alongside, and heard her Captain say, "'Urry along there, we cawnt stop 'ere long." Of course we knew that our rescuers were English, and the Captain later informed us that looking down from the bridge, seeing a huddled crowd of men, who to all appearances were black or dark brown, he never dreamed what nationality we were until the mate let loose with the above profanity, after which, he said, he knew we were Yanks.

The last man to leave the boat pulled out the bottom plug and let her sink, and there was none of us who could not climb the long ladder to the deck of the ship. However, upon stepping on board very few of us were able to walk, and we fell in a heap on the deck. It will be remembered that all the time we were in the boats we were in a sitting position, and had not been able to stretch out, and for this reason our knees refused to hold us. So we rested for some time on the big concrete deck

of H. M. S. *Poleric*. In the meantime, the other lifeboat had been picked up by a Greek ship which accompanied the *Poleric*. The *Poleric* was bound for Norfolk, and arrived there safely about ten days later.

When the *Poleric* pulled into Norfolk I stole aboard a little motor boat that had come out to the ship anchored in the river, got

myself smuggled safely ashore, and made arrangements for a boat to go out and take off the crew.

Upon reaching the Navy building I could not realize why a sentry wanted to stop me from interviewing the Commanding Officer until I remembered that I had on a huge long coat, baggy trousers, and a green muffler borrowed from the steward, so that I looked like anything but a naval officer. After much persuasion I finally was admitted to his sanctum, and explained matters. Upon his asking me what proof I had that I was in the Navy, I realized that I had none, and a telegram was sent to Brooklyn to verify the fact. The men of our boat were clad, many of them, in English overalls and nothing else. Yet on account of red tape and the absence of proof of our identity, and absence of our pay cards, nothing could be done for us. No clothes, money, or cigarettes were obtainable except by begging them. In this regalia, after three days' waiting, we were put aboard a passenger ship and sent to Brooklyn, where we finally got necessities. The other members of the crew who were picked up by the Greek ship landed in New York a few days later; the third ship, that of the mate, had already arrived at New York, having been picked up the second day out. The fourth boat, that of the Captain, was picked up, after being out nearly a week, by a ship going to France, which landed that crew safely back in France. The casualties were: one dead, nine wounded, and one mentally deranged.

The last I saw of "Mike" was when we arrived at Brooklyn. He said, "Did the ship go down yet, Chief?" "Yes, Mike," I answered, "but you are now safe at home. Don't worry about the ship." And he answered, "Oh, alright, Chief, thanks."





#### TRYING TO DECIDE WHAT TO GET

In a well-run radio store such as this one in New York, the novice is helped to buy discriminatingly. Many stores do nothing more than put their apparatus out for sale without bothering or knowing how to help the broadcast listener get the best value for his money. Some knowledge of the types of sets discussed below will help the B.C.L. to buy with his eyes open

## What Kind of Receiver Shall I Buy?

What Results You May Expect from Various Types of Receivers. The Accessories Needed, and Some Idea of the Entire Cost

By ARTHUR H. LYNCH

**T**O HAVE or not to have: that *was* the question. People have now pretty generally decided, however, that they would like to own—eventually, if not immediately—some kind of apparatus which will bring broadcasting into their homes. Their question becomes: “How good a set can I get for the amount I am willing to spend?” When you approach a counter where radio is sold, and ask: “How much is a good radio?” you are likely to be taken aback if you are a newcomer to this radio game, by the volume of technical verbiage which the

apparently simple question excites. The answer is a difficult one and is unknown to many sales people.

Without intending to be insolent, the clerk must answer the first question with several others, such as: “Do you wish a crystal set or a tube set?” “Do you wish to use an aerial or a loop?” “Do you wish to receive with headphones or a loud speaker?” And then, that all-important question: “Just how much do you care to spend?” By the time he has finished, you realize that you have let yourself in for a great deal more than you bargained for, and

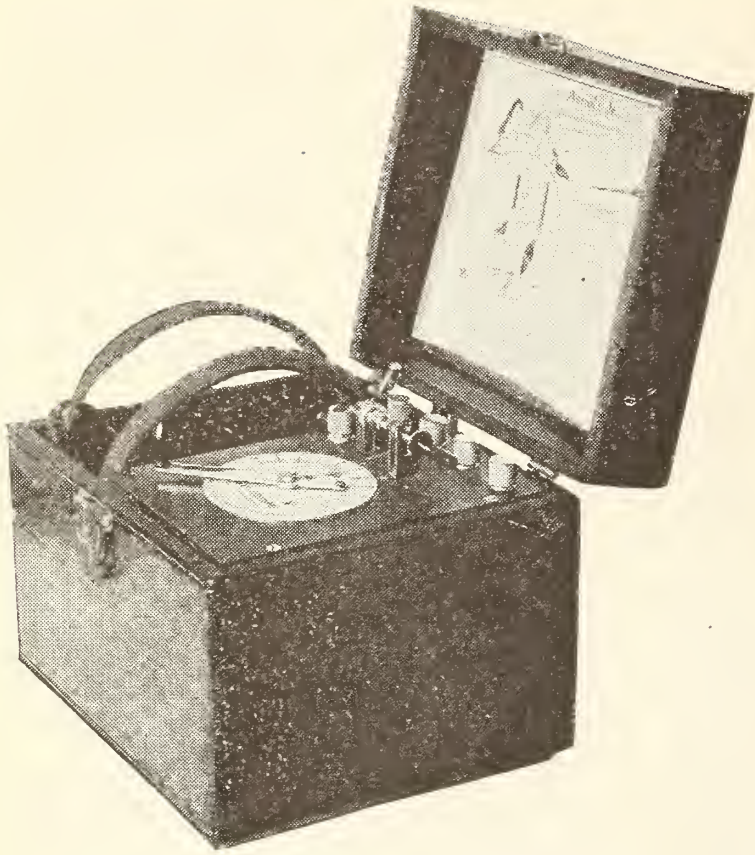

A CRYSTAL RECEIVER  
One of the first to be made  
specially for broadcast reception

feel desperately alone in a rudderless ship in a stormy sea. Perhaps the following outline may assist you and incidentally lighten the burden for the salesman.

To begin with, let us understand each other properly: You have thought of buying a radio receiving set, "a radio," to use the common term, and we want to help you to get the best for your money. We have not the time or space to tell you of the wonder machines that may be had for fifteen dollars that bring in stations fifteen hundred miles away on a loud speaker that may be heard fifteen hundred feet away. The radio millennium has not arrived, but there is plenty of pleasure to be had at a reasonable outlay. Let us proceed, then, on a dollars-and-cents basis.

#### WHAT THE CHEAPEST SET WILL BRING YOU

THE cheapest of receiving sets is the crystal outfit, so-called because a mineral or crystal is used as part of the receiving system. The price of a crystal broadcast receiver, complete, ranges from less than \$10 to about \$35. No batteries of any kind are necessary with it, and there is, therefore, no up-keep expense. With a good outside aerial, made of a single copper wire, a crystal receiver will operate with headphones on stations from

fifteen to twenty-five miles away under average conditions.

If your crystal receiver is to be within less than five miles of two or more powerful broadcasting stations, it is quite likely that you will experience interference when both stations operate simultaneously: in other words, you may not be able to hear one without the other—the receiver is not "selective."

The quality of music and speech picked up with a crystal receiver from stations well within its range is usually very good, though the volume is not very great. A crystal receiver alone will *not* operate a loud speaker. Over distances in excess of one mile it will *not* work with a loop. It may be used in conjunction with a loud speaker if an amplifier is used, but the cost of an amplifier in proportion to the cost of the crystal receiver itself is so great and the results obtained so unsatisfactory that such an arrangement is not advisable.

#### THE LAMP-SOCKET ANTENNA

ONE great radio achievement, not appreciated by most people in search of a receiver, is a little device known as an antenna attachment. It screws into an ordinary lamp socket or plugs into a base outlet. It permits the use of the electric light wires in the house as an antenna, *without using any of the electric lighting current.*

Antenna attachments of this kind may be used with nearly all makes of receivers. They make the use of an outdoor antenna unnecessary, and eliminate the necessity for the safety device required when the outdoor antenna is used. The results obtained compare very favorably with those obtained with an outside



AN ANTENNA ATTACHMENT

It is screwed into the ordinary electric light socket, permitting the use of the lighting wires as a receiving antenna

reception is obtained in one socket than in another. The price of such attachments runs from 75 cents to \$1.50. We mention this device here because it may be used with a crystal receiver.

wire. Sometimes the reception is greatly improved. The radio receiver may be moved to any part of the house where there is an electric socket and put in operation in a few minutes. It may be found in using these devices that better

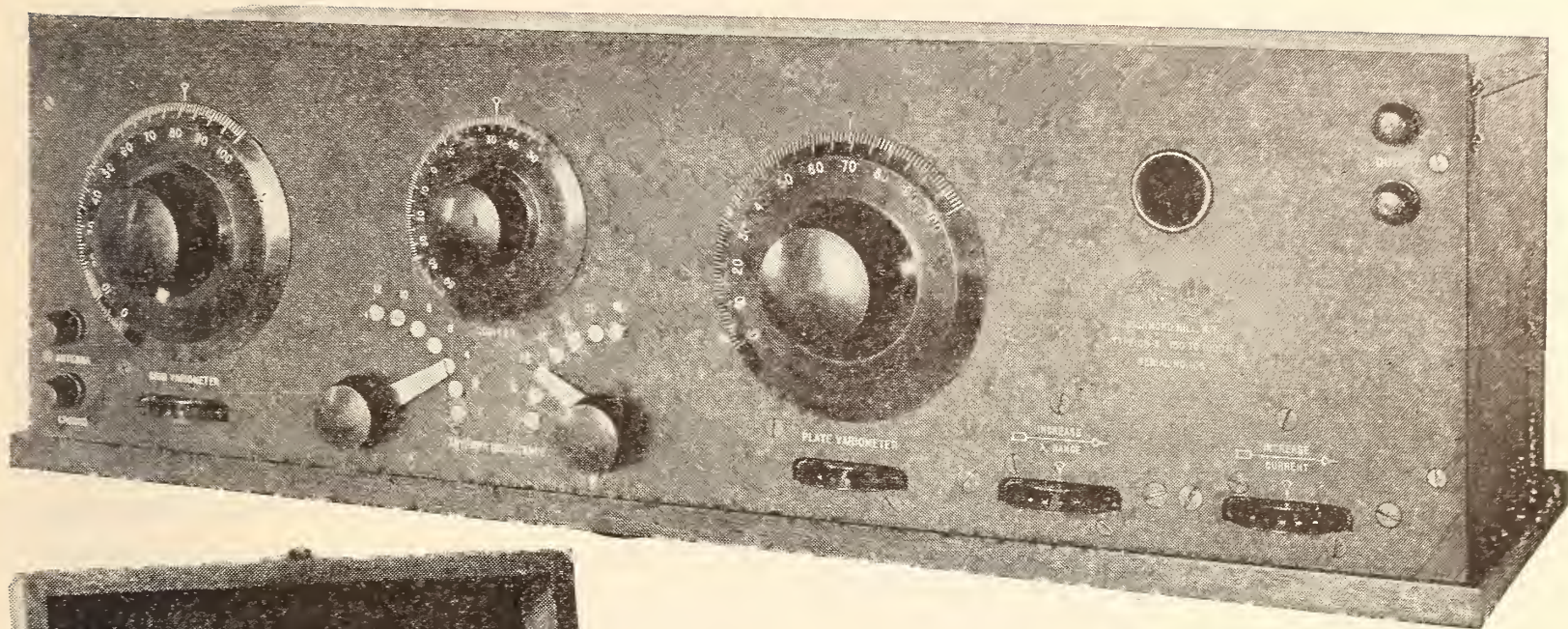

TWO SINGLE-TUBE RECEIVERS

Above is a three-circuit regenerative outfit, which permits of fine tuning; at the left is a simply-controlled single-circuit regenerative set, designed for use with a dry-cell tube

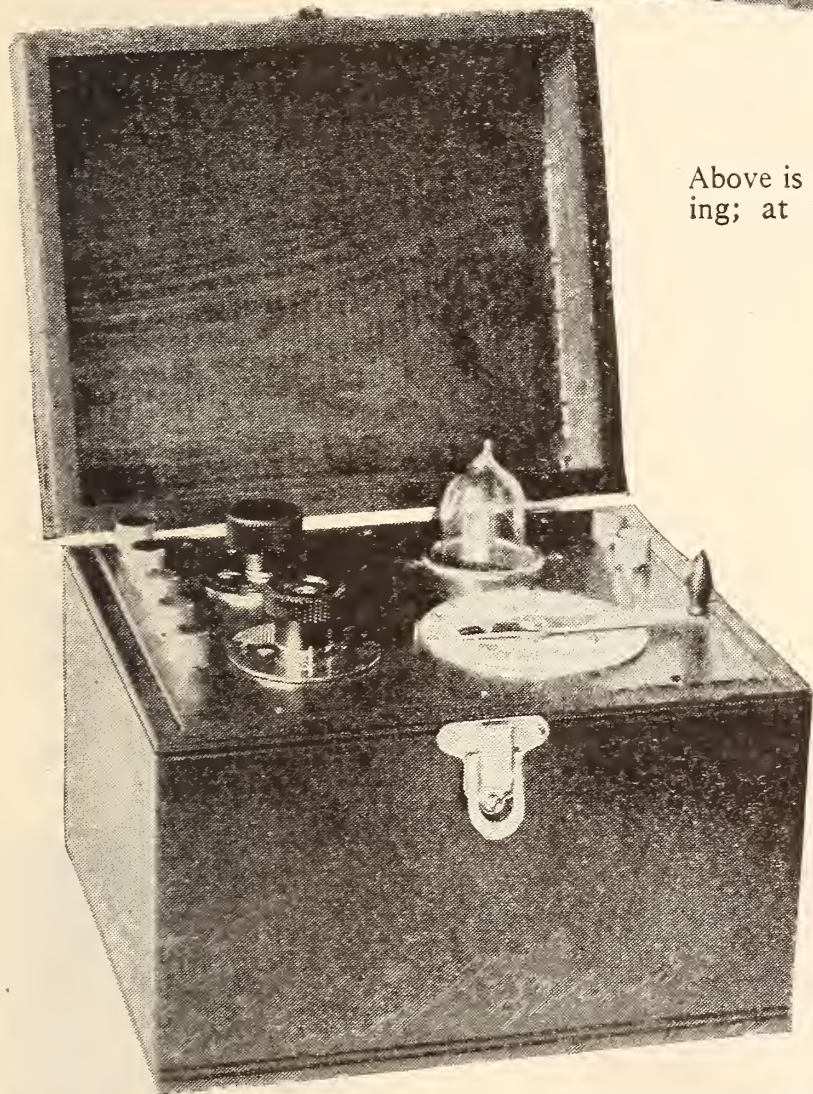

WHAT A SINGLE-TUBE SET WILL BRING YOU

THERE are many kinds of receivers employing a single tube, and most of them may be relied upon to perform in a satisfactory manner. There is little need for the prospective buyer going into a technical discussion of the relative merits of different circuits used in single-tube receivers, with one exception, and that is the so-called single-circuit regenerative receiver.

A receiver of this type in the hands of an inexperienced operator and in the hands of many an experienced operator is likely to act as a transmitter, causing howls of a most disagreeable character to be heard by other receivers in the neighborhood. If you are out in the country with no one within a mile or two of you, the single-circuit receiver may serve you

(RIGHT)

A ONE-TUBE "REFLEX" SET

It has a crystal detector, and the single tube is made to do double duty, giving one stage of radio-frequency and one stage of audio-frequency amplification

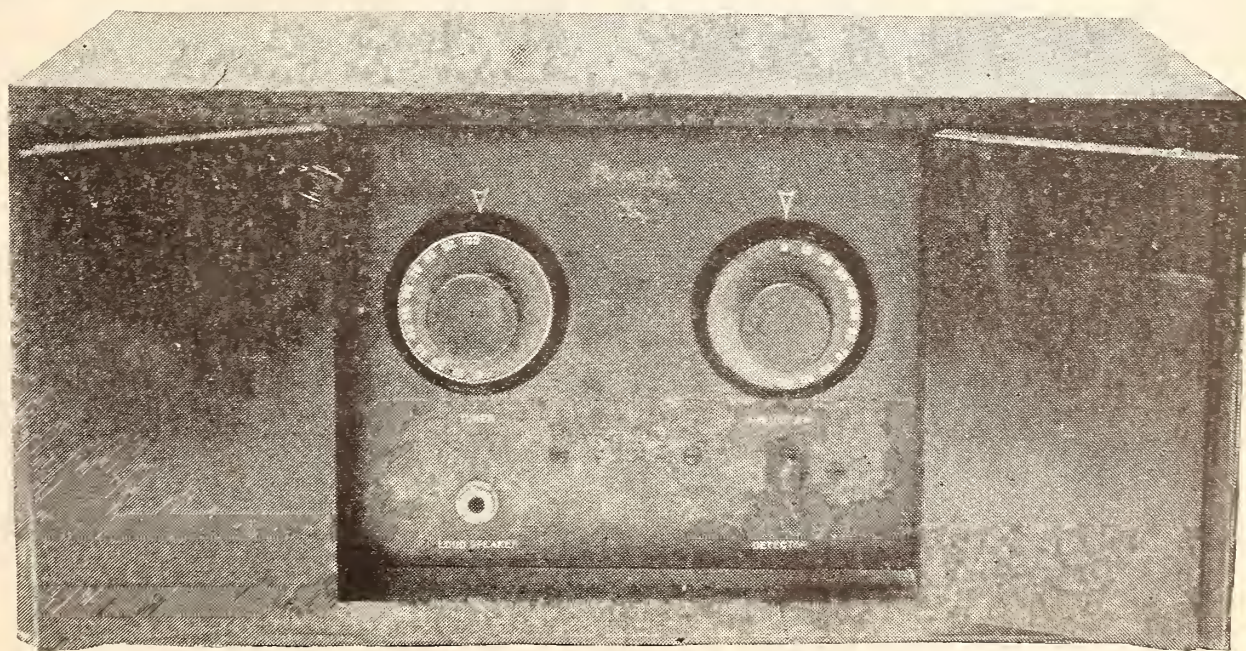

fairly well, without causing unpleasant relations with your neighbors; but if you are in the city, you will do well to procure some other outfit.

Most single-tube receivers are designed for operation with ear phones, though amplifiers may be added so as to permit the use of a loud speaker. A single-tube receiver, operated on the tuned "reflex" principle described in last month's RADIO BROADCAST will, however, operate a loud speaker over a distance of approximately twenty-five miles.

The three-circuit regenerative receiver is another satisfactory type. It is made by several reliable manufacturers and varies in price from about \$100 to \$225, complete with batteries, tube, phones, antenna equipment, etc. It is a great deal more selective than the single-circuit regenerative outfit but somewhat harder to tune than the reflex receiver mentioned above.

Loops are not satisfactory with these receivers, as a rule, but the antenna attachment may generally be used.

Special attention should be given the matter of accessories, especially where an amplifier is to be added later, for operating a loud speaker. A receiver with a dry-cell tube will be satisfactory for head-phone operation but

where a loud speaker is to be used, it is better to figure on 6-volt tubes and a storage battery.

Single-tube receivers for dry-cell operation may be had complete for from \$50 to \$125. They will operate over distances up to several hundred miles under favorable conditions.

#### WHAT TWO TUBES WILL DO FOR YOU

THE addition of a second tube is of value when you are within a short distance of a broadcasting station, because it will permit the use of a loud speaker. There are several two-tube outfits on the market, some of them being of the portable type.

The additional tube is used in one of two ways: either as a radio-frequency or audio-frequency amplifier. The difference lies in the fact that radio frequency (R.F.) amplification increases the range of the set but adds little to the volume, while audio-frequency (A.F.) amplification adds volume but does not increase the range. You have your choice. Under most conditions the addition of the A.F. amplification is preferable.

#### THEN THERE ARE THREE TUBES

THE number of receivers employing three tubes is rapidly increasing and they are becoming popular because a loud speaker may be used with them.

And this matter of loud speakers leads us to

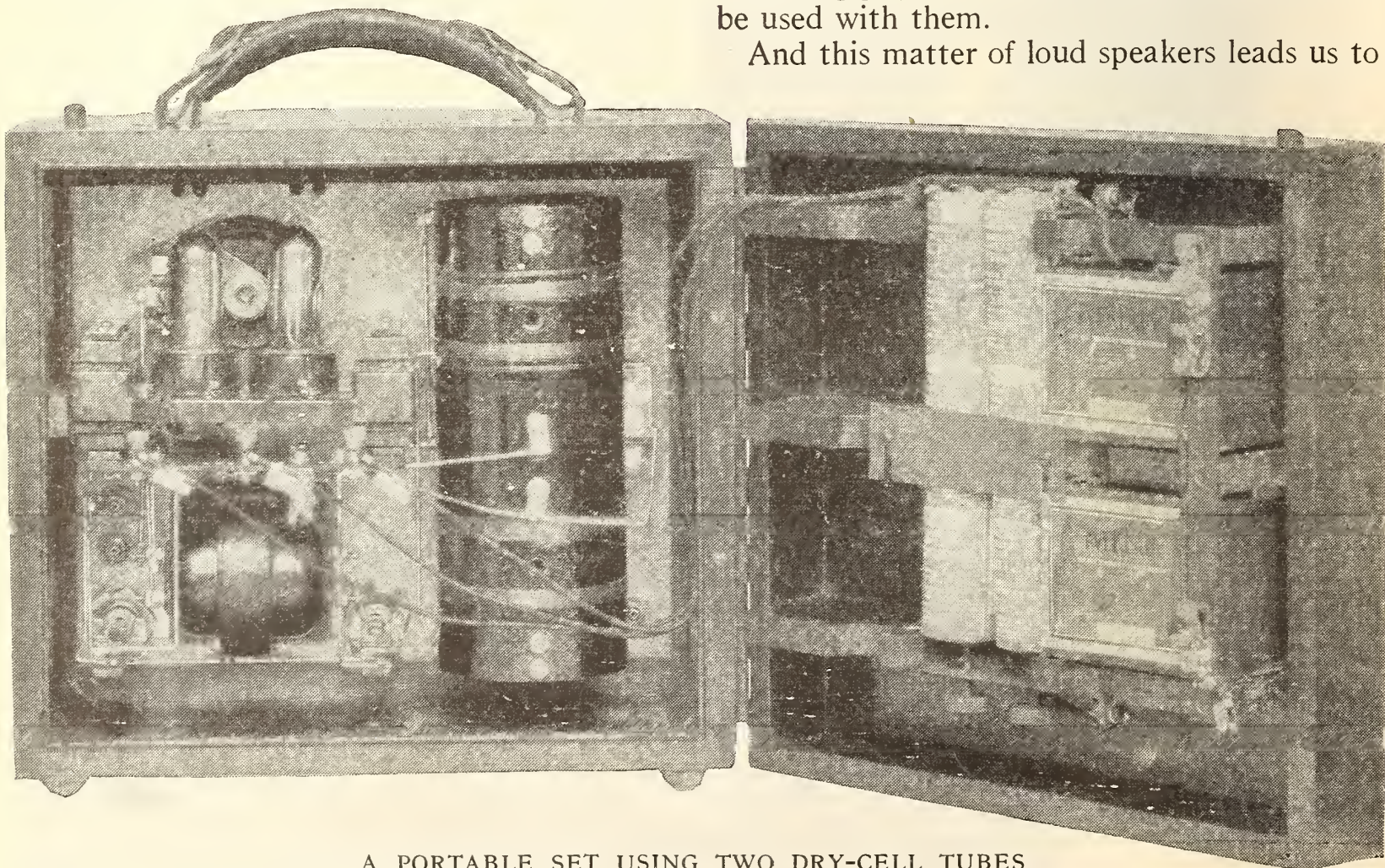

A PORTABLE SET USING TWO DRY-CELL TUBES

All batteries are inside the cabinet. Outside connections are necessary for antenna, ground, and head-phones

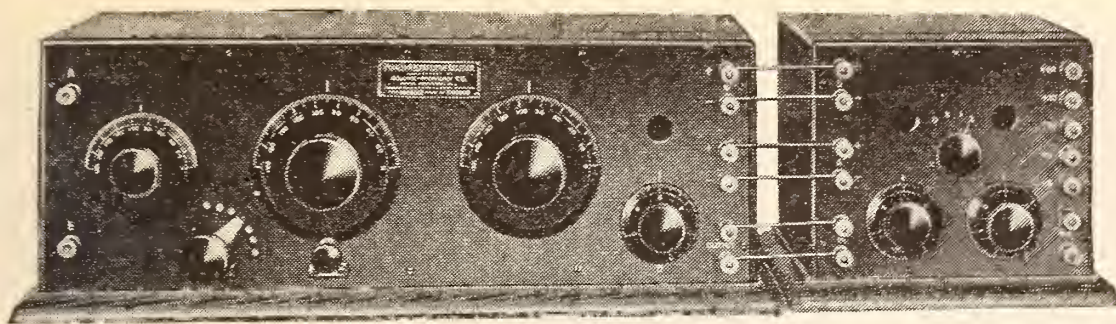

A THREE-CIRCUIT RECEIVER AND TWO-STEP AMPLIFIER

With an outdoor antenna, it will operate a loud speaker over considerable distances

a discussion of the distance over which loud-speaker operation is practicable. That distance is materially shorter than most of the glowing accounts of radio would have you believe. There are a great many exceptions to the rule, but the rule is that few stations may be heard *clearly* on a loud speaker with a three-tube set over distances in excess of one hundred miles. Most people who find interest in distant reception would rather hear a few squawks from a 1,500-mile-distant station than a complete program from one near by.

There are some three-tube receivers made for use with an outdoor aerial that have all the accessories in a single cabinet. As a rule they operate on dry cells and sell for about \$300 complete.

Less pretentious receivers may be had more cheaply but the average three-tube set for dry-cell and outside-antenna operation will cost from \$85 to \$150, without tubes or accessories.

There are three-tube receivers designed for operation with a loop aerial. They will operate a loud speaker over distances up to thirty or forty miles with dry cell tubes and somewhat longer distances when storage battery tubes are used. These receivers, for dry-cell operation, with all the accessories including

loss of selectivity. This type of receiver has the advantage of being easy to adjust. With

three tubes and an outdoor antenna, one may feel sure of very good loud-speaker reception over fairly long distances and similar operation with a loop receiver over somewhat shorter distances.

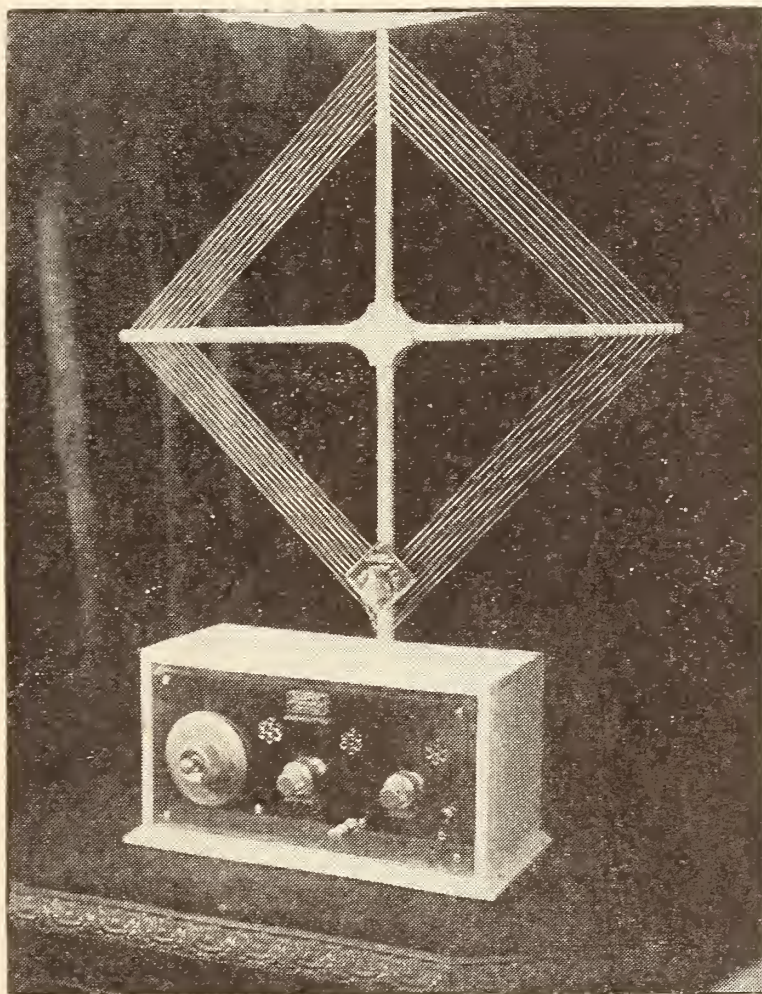

A THREE-TUBE LOOP SET

The diamond shaped loop antenna, used in place of outdoor antenna and ground, makes for selective receiving. The Grimes "Inverse Duplex" system, giving two stages of R. F., detector, and two stages of A. F. amplification, is employed. This particular gold and ivory model, built for Marguerite Clark, the screen star, was exhibited at the New York Radio Show recently

distances of several hundred miles. They are

two pairs of ear-phones and a good loud speaker, cost approximately \$200. For storage-battery operation, the cost is about \$15 more.

The range and volume of these receivers may be improved by the addition of a regular antenna and ground but this improvement is usually accompanied by a

WHAT YOU CAN GET WITH FOUR TUBES

ONE of the most popular receivers employing four tubes is built on what is called the neutrodyne principle. Such receivers are now being produced by several reliable manufacturers. The results they are producing for people who have known nothing about radio receivers heretofore seem to predict a wave of popularity for them. They have been designed for outdoor-antenna and storage-battery operation and may be used for loud-speaker operation over

A FOUR-TUBE RECEIVER

Containing all batteries in the cabinet. It uses a 20-foot antenna

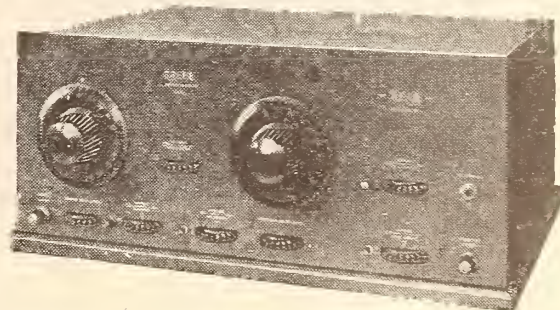

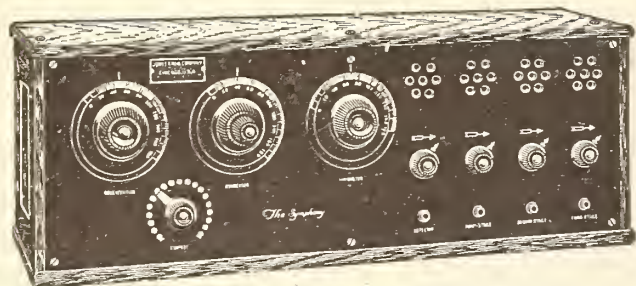

“DETECTOR AND THREE AUDIO”

easy to manipulate and produce very fine tone quality. They may be had complete for about \$220.

The four-tube loop receivers are extremely popular and have been so since their appearance on the market about this time last year. For operating a loud speaker on an automobile trip with dry-cell tubes they are hard to beat, and for home use they will produce ample volume for dancing, from stations comparatively far away. For dry-cell operation, the price is in the neighborhood of \$225, and for storage-battery working, it is about \$15 more.

Other receivers employing four tubes are usually made to include one stage of R.F. amplification which is used for increasing the range. Such receivers are very satisfactory and are less expensive than either the neutrodyne or loop outfits. As a rule, storage batteries are recommended, but they will operate with dry cells also. The price, complete, with all the accessories, two pairs of headphones and a loud speaker, for dry-cell operation, ranges from \$130 to \$275.

FIVE-TUBE RECEIVERS

THE addition of the fifth tube is generally for the purpose of securing reception of the best quality, rather than increasing the range, and it is successful in this respect.

SIX TUBES

BECAUSE of the improvement in vacuum tubes it is now possible to operate the filaments of six of the new tubes with less current than two of the old-style vacuum tubes would have consumed. For this reason, multi-tube receivers are making a good showing from a sales standpoint. Six-tube ones will operate over approximately the same distance with a loop antenna as any good three-tube receiver will operate with an outdoor wire or a lamp-socket antenna attachment. Because

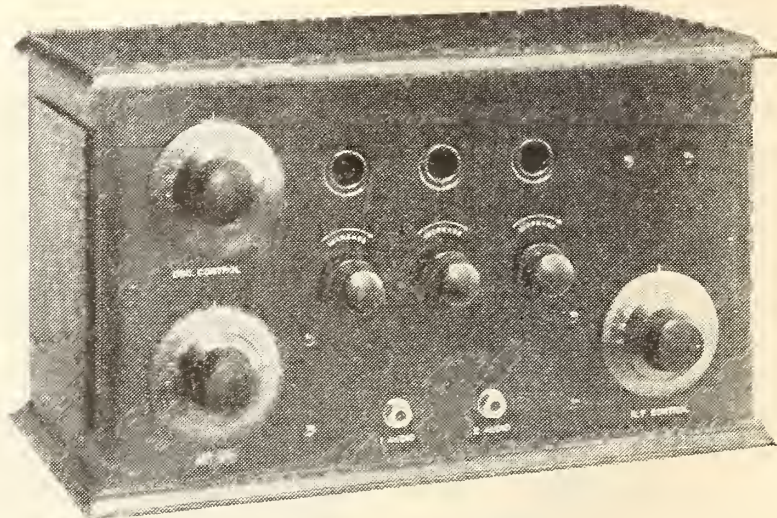

“ONE RADIO, DETECTOR AND TWO AUDIO”

the loop aerial has the property of being directional—that is, of receiving best from points in the direction in which its edge points, it reduces interference from undesired stations. It is not necessary to have all six of the tubes operating to give maximum volume. If they are not “overloaded,” or “forced,” the result is likely to be a receiver capable of long-range reception with a minimum of interference and adjustment. Loop receivers of this kind are

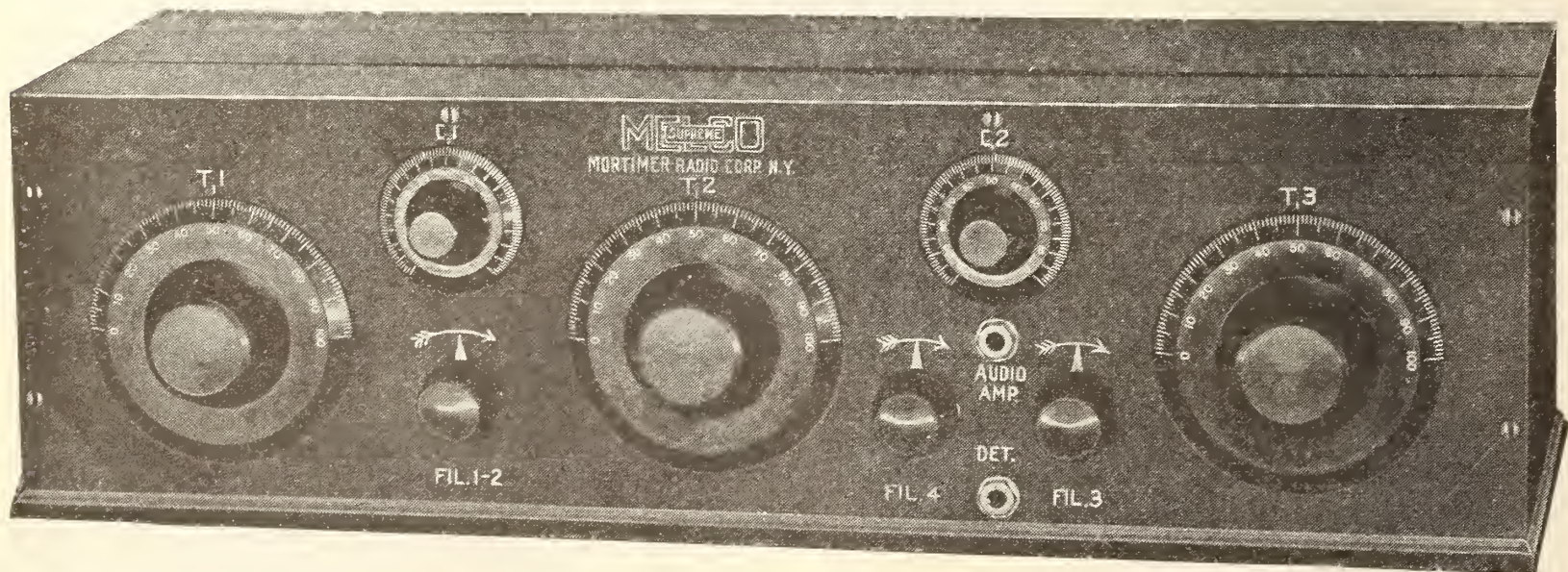

STILL ANOTHER FOUR-TUBE RECEIVER  
Combining “two radio, detector, and one audio”

not cheap but they are certainly very worth while

THE ACCESSORIES

WITH most receivers now on sale it is necessary to procure your accessories at a price not figured in the price of the receiver. The prices for this material are about as follows:

Material for outdoor Antenna \$3.50 to \$7.50

(As a rule this figure may be reduced by using an antenna attachment in place of the antenna material)

	.75 to	1.50 each
Dry cells	.35 to	.50 each
B batteries (22.5 volts)	1.75 to	3.00 each
Head-phones	3.75 to	12.00 a pair
Loud speaker	10.00 to	55.00
Vacuum tubes	5.00 to	6.50
Storage battery (6-volt, 80 ampere-hour)	15.00 to	26.00

IN CONCLUSION

We have tried to be conservative in telling you what you can get a receiver for, and what



FOUR-TUBE NEUTRODYNE SET

you may expect it to do for you. Our outline considers average results. Familiarity with your receiver will enable you to exceed this average. In making your selection it is well to beware of the man who makes wild claims for his goods, and before buying it is advisable to hear several sets in operation.

Make up your mind how much you want to spend, and look at five or six different makes of receivers within your price limit; then make your selection. If you patronize a reliable shop where standard merchandise is sold, rather than a cut-price shop, you will, as a rule, be sure of satisfaction or given your money back and very few instances have been brought to our attention where the latter has been necessary.

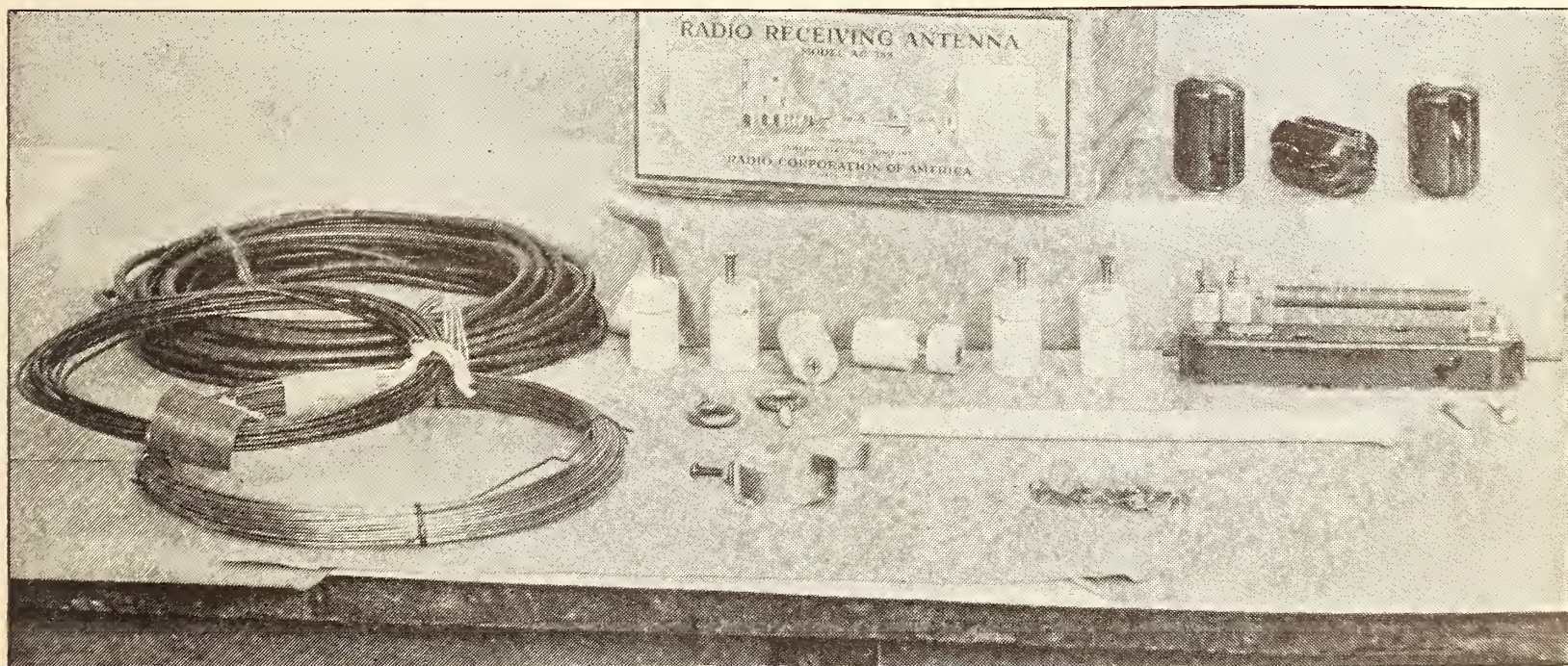

ANTENNA AND GROUND EQUIPMENT

This assortment consists of heavy insulated copper wire for the ground connection, lighter insulated wire for the "lead-in," bare stranded-copper or phosphor-bronze wire for the antenna, screw-eyes, a ground clamp, insulated double-pointed tacks, a porcelain lead-in tube, a lighting arrester, and various other glazed porcelain insulators

# How to Build a Neutrodyne Receiver

With a Complete List of Parts Necessary, Their Approximate Cost, Working Drawings, and Wiring Diagrams—by a Man Who has Directed the Building of these Receivers in Great Quantities

By KIMBALL HOUTON STARK

Chief Engineer, F. A. D. Andrea, Inc.

In the last two or three years, since radio became popular, probably several million radio receivers have seen the light of day. In this article, complete information is given for building a tuned radio-frequency receiver using Professor Hazeltine's now famous neutrodyne circuit. In the second article in this series the author will give detailed instructions for neutralizing the inherent vacuum-tube and stray circuit capacities. The third article will deal with practical pointers on operating the receiver, including data on loop antennas, dry-cell tube operation, etc.—THE EDITOR.

**B**REATHES there a man with soul so dead that he has not enthusiastically told his neighbors with ready speech and beaming eye, of his marvelous DX records the night before?

A rather funny statement was made to me the other day. The thought was presented that radio is certainly making us a nation of liars. A couple of rabid radio hounds meet at any radio store and immediately begin the discussion, infinite in detail and yet always ending with that universal topic of "How far did you get last night?" One man hears signals 1,500 miles on a two-tube super; another chap gets Los Angeles on a one-tube set; somebody else

happens to think of the old days when someone told him about hearing a commercial ship station three thousand miles west of San Francisco, from New York City, using a crystal detector—and so it goes.

It seems to me the craze for distance will never die out. I don't want it to. Of all the romance, mystery, and myths that we encounter in this life and that we are told about, where can we get romance that will compare with listening-in to concerts and music and speeches from stations hundreds of miles away, from invisible cities, as it were—from an invisible empire, an empire not of radio receivers or equipment, not of listeners or radio fans or experimenters, but a vast empire of pleasure and entertainment, of music and of all the good things that this world has in store for us.

There are thousands and thousands of radio fans that struggle along with their one-tube sets or their two-tube sets who are just wishing night and day that they could add a third tube or a fourth tube in order to hear that station a few hundred miles beyond the limit of their receivers today. Some of these radio fans can afford to buy complete receivers, but the ma-

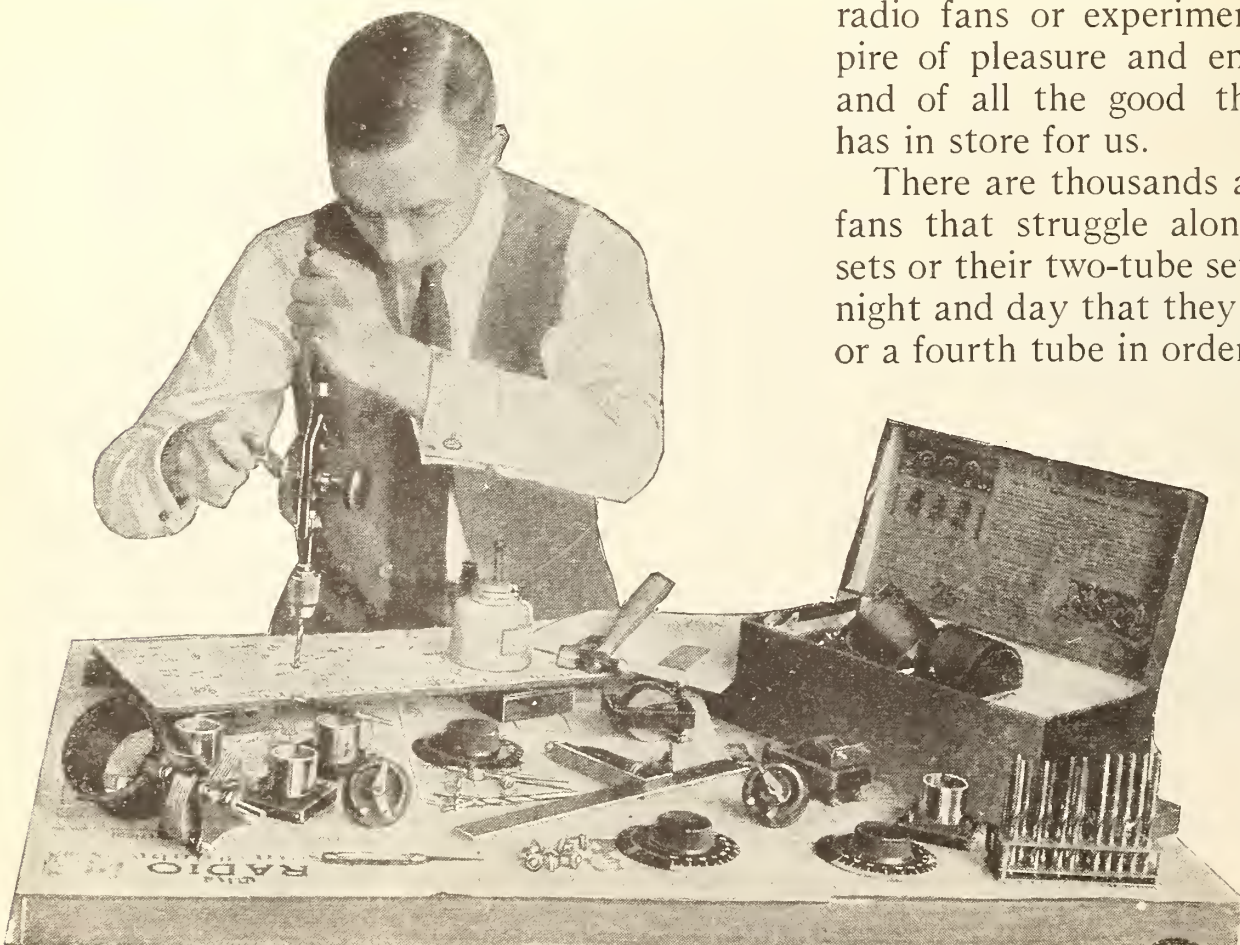

THE SET UNDER WAY  
Mr. Stark is shown drilling the panel, preparatory to assembling a receiver such as he describes in this article



majority must build, or would rather build, their own.

In past years, before radio came into people's homes, a man would build a mission table, a sled for the kiddies, or possibly a model engine; and, after planning for days, what a thrill he would get when the thing was actually finished and made to "work" or serve some useful purpose! Where in the world is there anything that can compare, in giving to such people more thrills and pleasures, with the everyday use of a radio receiver, built by their own hands, that works?

To give radio experimenters dependable, authorized constructional information concerning the neutrodyne circuit receiver is the purpose of this article.

In March of this year, Professor Hazeltine revealed his developed work and introduced the neutrodyne circuit radio receiver. About July of this year, a limited number of companies licensed under Professor Hazeltine's patents were building completed receivers, utilizing the neutrodyne principle and in addition were supplying complete sets of parts suitable for neutrodyne-receiver construction.

Being in intimate touch with many people who have built neutrodyne-circuit receivers using such parts, I can assure you that to build such a receiver calls for reasonable care in construction in order to obtain maximum broadcast signal reception, but for thousands who would be painstaking, the results in the end certainly justify the expense and the pains necessary.

LIST OF MATERIALS NECESSARY TO CONSTRUCT A FIVE-TUBE NEUTRODYNE-CIRCUIT RECEIVER

THE five-tube neutrodyne-circuit receiver to be described gives two stages of tuned radio-frequency amplification, a vacuum-tube detector and two stages of audio-frequency amplification. Such a receiver will cost approximately \$65.00 for parts, and if one purchases all the additional equipment, the total cost will be approximately \$150.00, including the five vacuum tubes, storage battery, B battery, phones, and antenna material.

The following list of materials must be acquired:

	APPROXIMATE PRICES
1 Panel, bakelite, 26" x 7" x $\frac{3}{16}$ ", drilled, machined, and engraved	\$ 8.00
1 Base board, oak, 26" x 6" x $\frac{3}{4}$ "	1.00

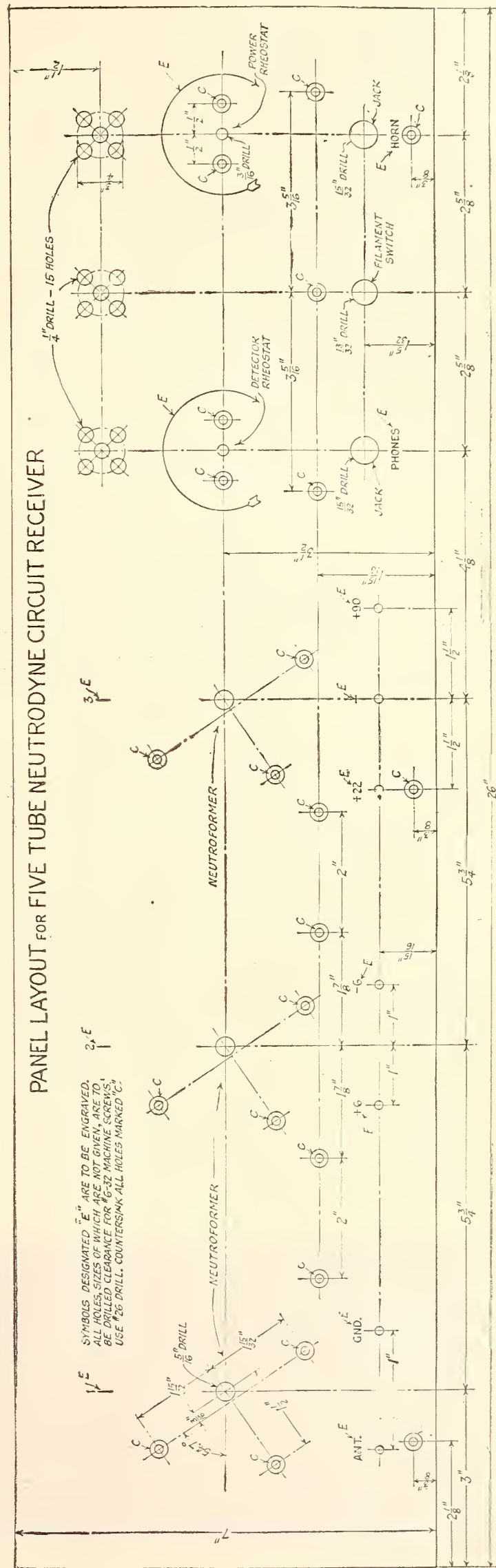

FIG. 1

1	Triple socket	2.70
2	Single Sockets	2.00
3	Neutroformers (tuned secondary R. F. transformers)	22.50
2	Neutrodons (neutralizing condensers)	2.50
2	Audio transformers	12.00
1	A battery switch	.75
3	Dials (verniers are unnecessary)	3.60
1	Power rheostat (2 ohms)	1.20
1	Detector tube rheostat (6 ohms)	1.25
7	Binding posts	.84
1	Radio jack, closed circuit	.75
1	Radio jack, three-spring, automatic	1.00
27ft.	Insulated tubing	2.26
27ft.	Wire No. 14, tinned copper	.25
2	Condensers, .006 mfd.	1.50
1	Grid leak, 2 megohms	.75
1	Grid leak condenser .00025 mfd.	.65
	Screws, nuts, terminals, etc.	.10
	<b>Total</b>	<b>\$65.60</b>

Great care should be taken in purchasing these parts and one should obtain only the special neutrodyne parts made by authorized licensees under Professor Hazeltine's patents.

#### DRILLING YOUR PANEL

FOR the panel, either bakelite, formica, condensite, or radion may be used. A detailed panel drilling layout is shown in Fig. 1, all dimensions being given.

If you do not purchase the complete set of parts but only the necessary special neutrodyne parts, you will need to lay out your own panel for drilling. In doing this it will be found convenient to use dividers and a combination square in order to get all dimensions, etc., accurately. It is suggested that you purchase the complete set of parts [which includes the panel with all holes drilled and the proper engraving done. By using such a finished panel in constructing your receiver it presents a mighty good appearance when finished. How-

ever, if you do drill your own panel, very great care must be taken in laying out the position of the Neutroformer mounting holes as the relationship of the Neutroformers to one another is very exact.

As shown on the drawing, Fig. 1, the Neutroformers are mounted at an angle of  $54.7^\circ$  from the horizontal and should this vary even one or two degrees, trouble will be experienced in properly balancing out the receiver. On the diagram, the marking is also shown for the binding posts and telephone jacks. All holes not marked with special dimensions are to be drilled clearance for 6-32 machine screws. This requires the use of a No. 26 drill.

#### ASSEMBLING THE PARTS ON THE PANEL

WITH our panel drilled and engraved, the next step is to assemble the various units on the panel. The rear view of the completed five-tube neutrodyne receiver is shown in Fig. 2, and from this picture one can get an idea of the general arrangement of the parts on the panel.

It will be noted that two of the sockets are placed between the Neutroformers, and that the triple-tube socket is placed on the left-hand end of the panel looking from the back. The rheostat at the extreme left end is a power rheostat controlling the filament current of the amplifier tubes and the rheostat closest to the left-hand Neutroformer controls the filament current of the detector tube. In the hole on the panel drilling layout marked "phones" is mounted a two-spring closed-circuit telephone jack. This is directly under the knob of the vernier rheostat. In the other or "horn" jack is mounted a three-spring automatic filament-control jack. The filament switch, binding posts and sockets are easily assembled in their proper position. The Neutroformers should be very securely screwed to

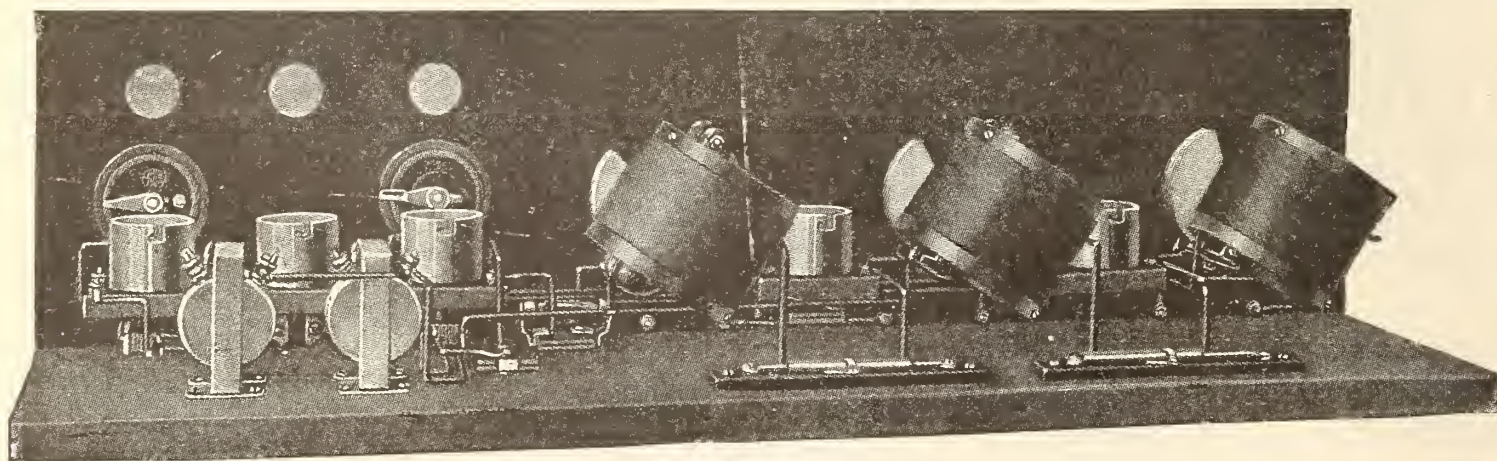

FIG. 2

**SCHEMATIC WIRING DIAGRAM  
OF FIVE TUBE  
NEUTRODYNE CIRCUIT RECEIVER**

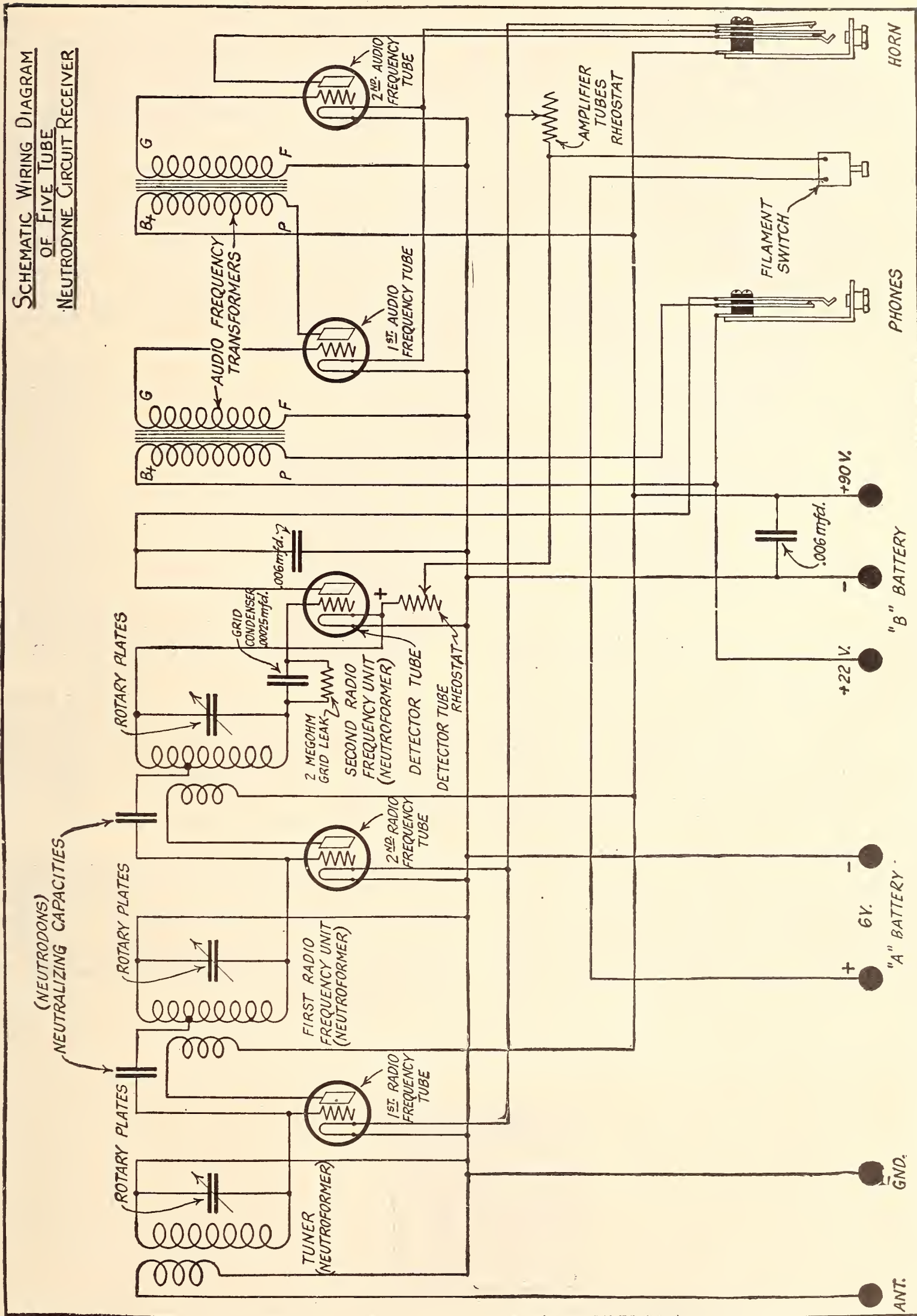

FIG. 3

the panel in their proper position as the operation of the set would be affected if they were even slightly moved out of position during assembly and wiring.

#### WIRING UP THE FIVE-TUBE NEUTRODYNE SET

THE wiring of a receiver is usually the stumbling block for most of the experimenters. I have seen some of the most horrible looking jobs on neutrodyne receivers, yet when the job was properly balanced out, it worked O. K. This should not be taken as a criterion, however, and the experimenter is advised to take particular pains in wiring up his set.

Study the wiring diagram in Fig. 3 very carefully. Note in particular the polarity of the Neutroformer windings, audio-frequency transformers, and especially the connections of the Neutrodons and telephone jacks. All high-potential plate and grid leads should be kept as widely separated as possible and all wiring separated at least one half inch with as few leads running parallel to one another as possible.

In assembling the receiver, it is usually best to fasten the base board to the panel, and to fasten the audio-frequency transformers and Neutrodons to the base board. Before wiring up the receiver, however, one should unfasten the base board from the panel, as this makes it much easier to wire all the parts mounted on the panel. Then fasten the base board with its Neutrodons and audio-frequency transformers again into place to complete the wiring of these units.

It is usually best to begin wiring by connecting all the negative vacuum-tube socket terminals and then extending this same wire to the ground binding posts. In like manner, the

positive filament connections can be made and the wiring of the detector tube rheostat, power rheostat, battery switch, and battery binding posts completed.

Connections to the Neutroformers come next. It will be noted that all the Neutroformer secondary windings have a small loop or tap. On the wiring diagram no connection is made to the tap of the first or left hand Neutroformer looking from the panel front. A lead is connected, however, from the tap of the second and third Neutroformers going directly to one terminal respectively of the second and third Neutrodon condenser.

The fixed condensers with capacities as shown on the wiring diagram are wired into position and need not be fastened either to the panel or base board, as the stiff No. 14 copper wire will hold them in position. After you have completed wiring up your receiver or preferably step by step as you fasten each wire in position check off with a heavy pencil on the wiring diagram the connection that you have just made. When the wiring is completed, all wires will have been checked and in addition by doing the job this way, you are doubly checking yourself for mistakes.

On the wiring diagram, no wire is shown jumping another one with a loop symbol. The plan shows each wire passing across the others and only connecting to cross wires when represented by a solid black dot. Check this carefully with your own wiring.

In the next article of this series, detailed instructions will be given for balancing out the inherent capacity of the vacuum tubes as well as the stray-circuit capacities, thereby eliminating parasitic and distorting oscillations and regeneration.

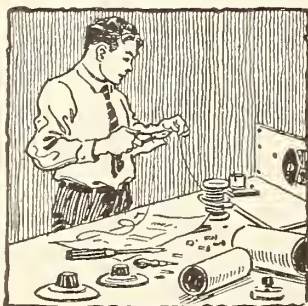

# RADIO VAGABONDING..



The Part that a Broadcasting Receiver Played During the First Leg of a Motor Trip Around the World\*

By PETER TAYLOR

**O**N THE running board of our car is a rectangular box, riding underneath its muddy rough-looking waterproof cover. A passer-by might think it a supply or tool box such as any tourist might carry. However, when I remove the cover in an auto camp or in some city street, and let the front side drop to form a narrow desk, a black panel with dials is disclosed, which leads the way to music and to speech—a trip from camp far out into space. Adjoining the panel in a second compartment is a square, screen-covered opening—a loud speaker. A top lid lifts, under which are tubes and brown bakelite variometers on the rear of the panel. Sponge rubber carefully cradles the apparatus

attached to the panel which is held in place at either end by rubber-covered grips. In a compartment around the throat of the horn are packed extra bulbs, a set of head-phones and a small flexible coil of antenna wire. Shelved on the end in the third section rides the 90-volt B battery, also protected by sponge rubber cushions.

It takes only a moment to put the equipment in operation: a small plug, hanging on a nicked chain at the end of the panel, is pushed into a jack, lighting the tubes from the storage battery of the car and connecting the loud speaker to the set. The end of a wire running around three sides of the top, underneath the padding, is dropped and connected to the antenna post on the panel, or a twenty-foot wire is stretched up arm's-length to a nearby tree or other object. Now one has merely to turn the dials. The ground connection needs no attention ordinarily, since the frame of the

\*The writer of this article, with his sister, Mildred Taylor, also a writer, and Blanding Sloan, friend and artist, left New York on April 26, 1923. (Their departure is shown in the photograph on page 229, RADIO BROADCAST for July.)

car, being connected to the storage battery, acts as a counterpoise or series capacity to earth.

This set has never failed to please me. Always it seems that the running board of a car is a very unusual place for a radio. I like the equipment not only for its beautiful construction, but because it has given me more than six thousand miles of perfect service on our zig-zag trail across the United States. It has satisfied a great many personal "radio desires."

The first tests and first impressions seem a long time ago. I smile to think how carefully I drove away from the factory after the set had been installed the day before we headed west. Every little eighth-inch bump drew my foot to the brake! Later the same evening we drove uptown in New York to find a store where I might get a leather coat. On the return along Riverside Drive my fingers itched to turn the dials of the new receiving set. Last moment preparations had left no time for previous tests. We pulled up by the curb, opened the case, and in a moment, we had music rolling out clear and loud. I thought, "All this and with so little effort!" It had seemed useless to try the outfit when driving, because of ignition interference. However, I felt sure that the motor spark could not affect such strong signals, so I started the motor to make the test. One had to stand very close to the loud speaker

to hear the click, click, click of the motor spark. Nothing could have pleased me more. It meant a radio ride now and then, provided that the lighted filaments would stand the vibration. We continued down Broadway and serenaded the folks crowding from the theatres and cafes. There was not the slightest irregularity due to changes in tuning or tube vibration. This first radio ride is an experience that I shall not soon forget.

We left New York rather hurriedly the next afternoon. There was no time for system. Typewriters, camp stove, tent, suit cases, blankets, brief-cases, artists' materials and all sorts of necessary equipment were loaded in the quickest possible way. A motorcycle police escort piloted us at thirty miles an hour through the thick of traffic to the city limits, from the City Hall where Mayor Hylan had presented us with a sheepskin scroll—a letter of greeting to "fellow mayors around the world." When finally we reached the city line, the cops asked how the radio was riding. I opened the set, and finding everything all right (rather to my surprise) gave them a little concert in appreciation of the swift and thrilling ride. As we drove on, I wondered how long it would be before something broke inside the little black case.

On the way up the Hudson, I was anticipating a first night test in camp. High over the river, across from Poughkeepsie, we drove in the shiny new stakes and erected a brand new

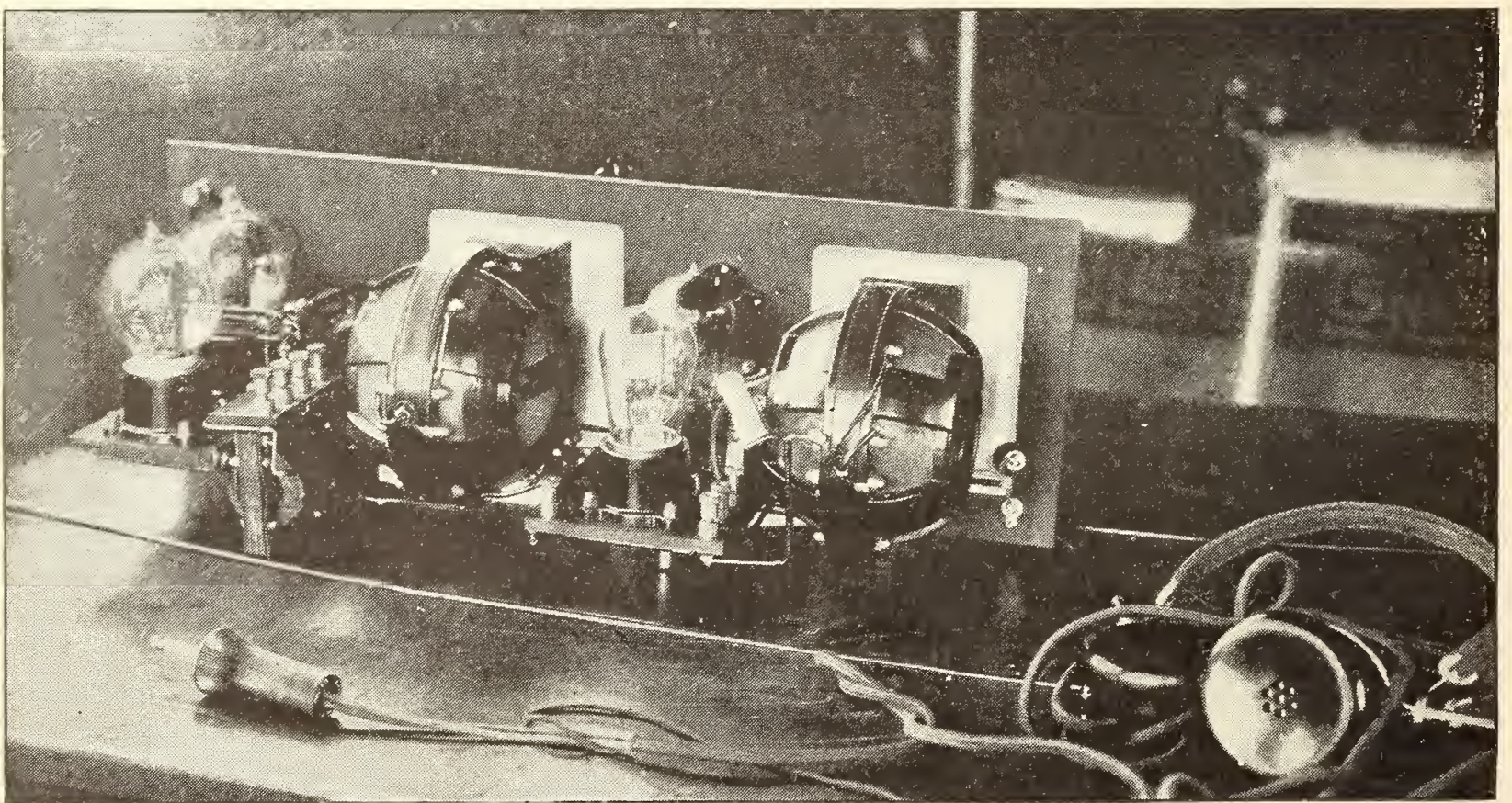

"THE WORKS" FROM WITHIN

out-of-door house—our balloon-silk tent. It was difficult to stick to the task of camp-making with my mind on radio. I thought of the noisy New York "L" which only a few nights before was interrupting my DX work. What a contrast to this "miles from nowhere" stillness! I took my time when opening and connecting the set. Every move was a pleasure, from unlocking the outer box to lighting the tubes. I clipped a wire on the tent rod, driven two feet into the earth. An antenna wire attached to a nearby limb brought in Schenectady immediately. I raised the volume with a little turning of the dials. It was astonishingly strong. Immediately I wondered how far I could hear it. Up the river along the high bank I went. Every announcement was still coming clear after I had been walking for five minutes or more.



The small loud speaker did not look equal to such volume, but it was handling it splendidly. Later, many Western and Southern broadcasting stations and messages of enthusiastic, far-away amateurs vibrated the surrounding atmosphere.

We set our watches to WJZ and then turned in. As I was falling asleep, something seemed to say. "You're really appreciating radio for the first time." Incidentally, my sister and Blanding Sloan and I became so absorbed in this new radio experience that we forgot our fire, which burned up a buffalo robe. But what's a buffalo robe between programs!

Next morning, when I paid a visit to an adjoining estate to get some water, the people told me that they had opened their windows and listened-in—five hundred feet away. Until I told them of our radio, they had thought the concert was coming from across the river at Poughkeepsie.

I had a few fears regarding the tubes. Would they hold up in the sockets, or become noisy or break? Could the set stand the continuous vibration and heavy jolts of the car on bad roads? Would some one crash into us and wreck the outfit? But at Buffalo I began to have real confidence in the equipment. Nothing of an ill nature had happened, except a little trouble from the storage battery which had been frequently low due to our lengthy stops along the road at various places. This, I remedied by installing an extra battery in parallel with the one on the car. No doubt the average tourist would not require this pro-

vision. Not having had any trouble with the equipment thus far, I began to wonder what to do with a newly purchased soldering iron. I had just left a laboratory and, after all, did really want to fix something—sometime.

During stops along the road to Buffalo, I had always thrown out an antenna wire, so that the set would not be limited. The antenna in the car top seemed valuable only for local work and for use while driving. When I did actually give the car antenna a try out, it proved to be a good competitor of the regular short line off the car. At Buffalo we listened to Schenectady while driving through the streets. The volume was excellent. Although this car antenna is a sort of modified loop, it is non-directional, due to the fact that it lies in a horizontal plane.

The Automobile Club of Buffalo, stationed far out in the country at Clarence, invited us to have dinner and to spend an evening in their big chairs before their huge log fires. Spring air was still chilly; in fact a day or so before, we had lifted our heads in the early morning to find the tent and everything else covered with snow. Steak before the open grate sounded very good. Members of the Buffalo Launch Club were holding their annual dinner there that day. We undid the wing nuts that held the radio set on the running board, pulled the plug from the electric light socket behind the case, and carried the set and the spare battery inside the club house. Schenectady gave us a good dance program, on a wire between balconies.

At Cleveland, a local station and also one from Detroit could be heard while driving up every street and boulevard. It was interesting to watch the surprised folks in trolleys, passing autos and on the street. On these rides, bridges and viaducts showed what they do with radio waves. As we passed through a viaduct, signals stopped. Bridges had a similar effect. Our camp was on the lake at Edgewater Beach. The music from Detroit and from the local station was as perfect as I have ever heard by radio. When one stood far away from the set, the Hawaiian singers with their guitars seemed to come from some pleasure boat far out in the lake rather than by radio from Detroit.

I left this camp one night for a radio ride on a boulevard running along the lake. Just as

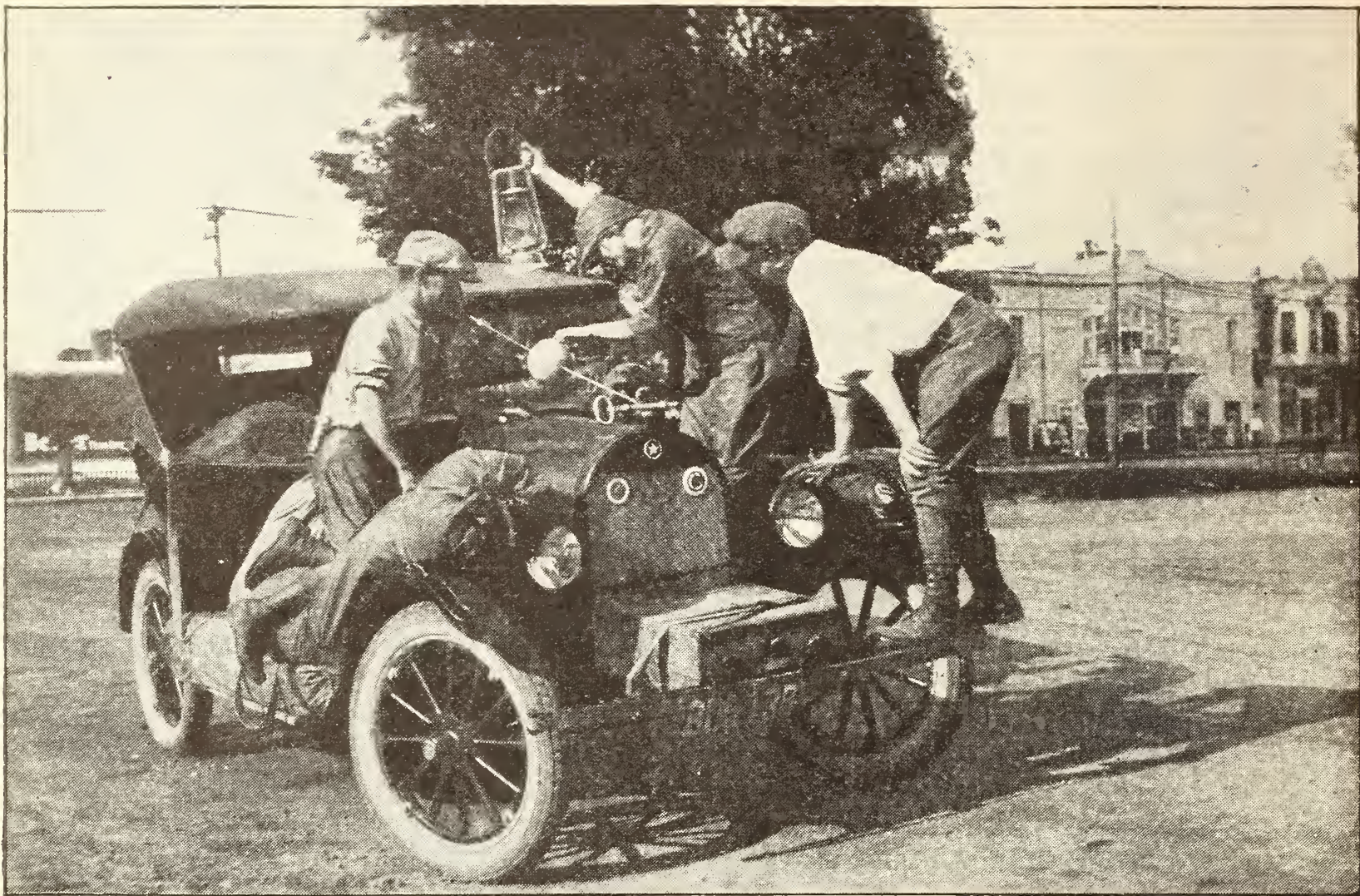

THE TAYLOR-SLOAN PARTY AND THEIR MUCH-DECORATED CAR

The old-fashioned lantern and the globe were presented to the travelers "as a precaution against driving past China"

I made a sharp left turn to pull up on the street, the music stopped suddenly. Apparently it was a clear open space. I drove back and forth, turned around, and soon found that there were no directional effects. There was a circle of ten feet or more where signals were extremely weak. A guy wire from a pole a dozen feet away caught my eye. This was the cause of the distortion. I thought, then, of the many carelessly erected antennas that may be wholly or partially strung in just such pockets, unknown to the radio fan.

The effects of buildings, trees and mountains began to interest me, much more than when I had read of them in books. It is contrary to natural belief, but I have driven many times from densely wooded parks to open spaces and found little change in signals. However, a turn into a narrow alley may make a considerable cut in the energy received, even with only a one-story building intervening.

In drives about Cleveland where the streets were only fairly wide, there was no noticeable change in signals, although we drove for an hour in widely separated parts of the city. This selfsame experience in other cities indi-

cates that there is scarcely an appreciable variation in energy over a fairly wide area surrounding the broadcasting station. When one is a dozen or so miles away from the source of transmission there is a gradual and easily noticeable reduction in signal strength as the distance increases.

One elderly lady in Cleveland came up and told the story of her runaway son. She went home greatly cheered when we told her we had heard by radio the news that Alexander's lost boy had been found by the owner of a radio set.

In Chicago, we camped for two weeks at Jackson Park. Groups of people from the artists' colony came each night for concerts and radio rides. They were somewhat mystified at first by the short antenna and the excellent quality of the music. Most of them seemed to have thought that radio sets at best are nerve racking boxes of noise. Before we had broken camp, many of them were preparing to make sets of their own.

A reporter from the *Tribune* came to see us while there. He seemed greatly interested in radio, and I decided to have a little fun. At



my request he held the bare end of a six-foot antenna wire to his ear. I tuned in a local station. He took the wire away and then touched it to his ear again. The concert stopped and started correspondingly. "Say boy," he said, "I think I would make a better antenna than a newspaper reporter."

Another night I tuned in Davenport for the artists. The sun was just going down. I was using a very short wire, and the signals were only fair. As the sun dropped below the horizon the volume of the incoming concert seemed to treble in a quarter of an hour. This was much more rapid than I had thought possible.

When we were driving along the lake one night at Jackson Park, the radio concert dropped in volume, then became noisy and irregular. At first it seemed that the tubes were breaking down. The trouble proved to be a loose wire, making and breaking contact with the antenna post behind the panel. As

a temporary repair I slipped the wire under the post. Later I soldered it in place, the only time that I have used that "poor investment" iron.

While waiting for the brakes of the car to be adjusted, I tried the radio in the second story of a Chicago garage. Men were busy on all sides. The steel beams looked impregnable as far as radio was concerned. I clipped on the car antenna; and market reports from a local station came in with tremendous volume, temporarily putting an end to the work of every mechanic in the place. Some one asked how radio came through steel buildings. One of the mechanics pointed to an open window. The serious expression on the questioner's face brought a laugh from every one.

My sister gave a talk by radio at the request of one of the Chicago stations—a story of our trip by auto around the world. I remained outside and heard it from the car. It surely



THE THREE "VAGABONDS" AT WORK IN THE CHICAGO ARTISTS' COLONY

Blanding Sloan is wielding the brush, and Peter Taylor is making tests on the set to the tune of Miss Taylor's portable typewriter

did seem weird to hear one's own sister talking from the black case, and later to see her walk from the station. This is, of course, all very ordinary, but the element of wonder in it never diminishes with me.

We stopped to see Uncle Joe Cannon at his Danville Home in Illinois. Sloan made a hurried charcoal sketch of him while he talked. Over in the corner was a radio set. It struck me that radio corners are rapidly becoming one of the country's most popular, and best, institutions.

At St. Louis the tourist camp was nothing less than a small city. Every one was waiting patiently for the roads ahead to clear, there having been daily rainfall for weeks past. One night the *Post Dispatch* broadcasted the opera "Wang." The little tourist city soon gathered around our radio, enjoying the entertainment. A strange thing about the incident is that the tourist camp and the open air theatre, where the opera was produced, were only a few hundred yards apart, in the same park. If one had stood halfway between he could have heard the concert from two directions.

It would seem that the country in the region of the Mississippi has considerable effect upon radio transmission. As we approached

St. Louis, everything to the east coast came in with heavy volume, slightly decreasing as we neared the river. With each following evening that we went farther west, Eastern stations gradually came in stronger, for more than a week, after which time they diminished again. I could think of nothing but the valley to account for it. What else? Weather conditions apparently were the same.

It seemed good to approach Kansas City and be through for a little while with days of mud and rain and constant ruts. On the last lap in Missouri we stopped in a little village cafe to get something to eat, and to rest for a time from the weary road. I looked at the car through the restaurant window and wondered how we were ever going to get three or four days of mud off the caravan. It was everywhere—splashed on the hood and thrown on the top. It was even piled inside, having dropped from our high boots after we had jumped out many times either to tow a fellow tourist from a mud hole or to dig a trench to guide us from a rut when passing other cars. The radio had its share of mud, too, for it is the stepping stone when one opens the car door to leave or to enter. I continued to look through the cafe window at the car, and at the

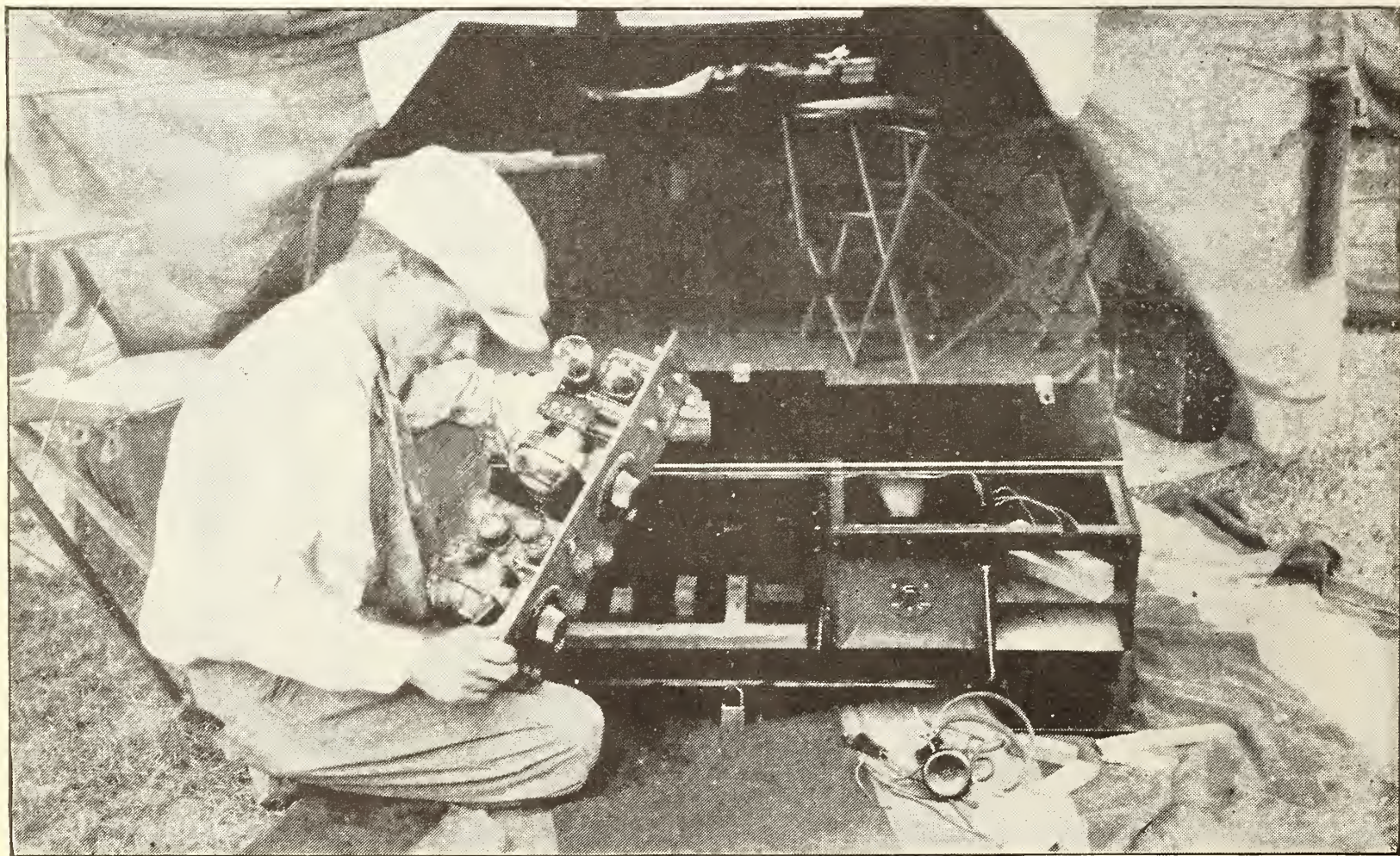

AN INSPECTION

Which revealed no indication of the set's rough journey from New York to the Kansas City camp

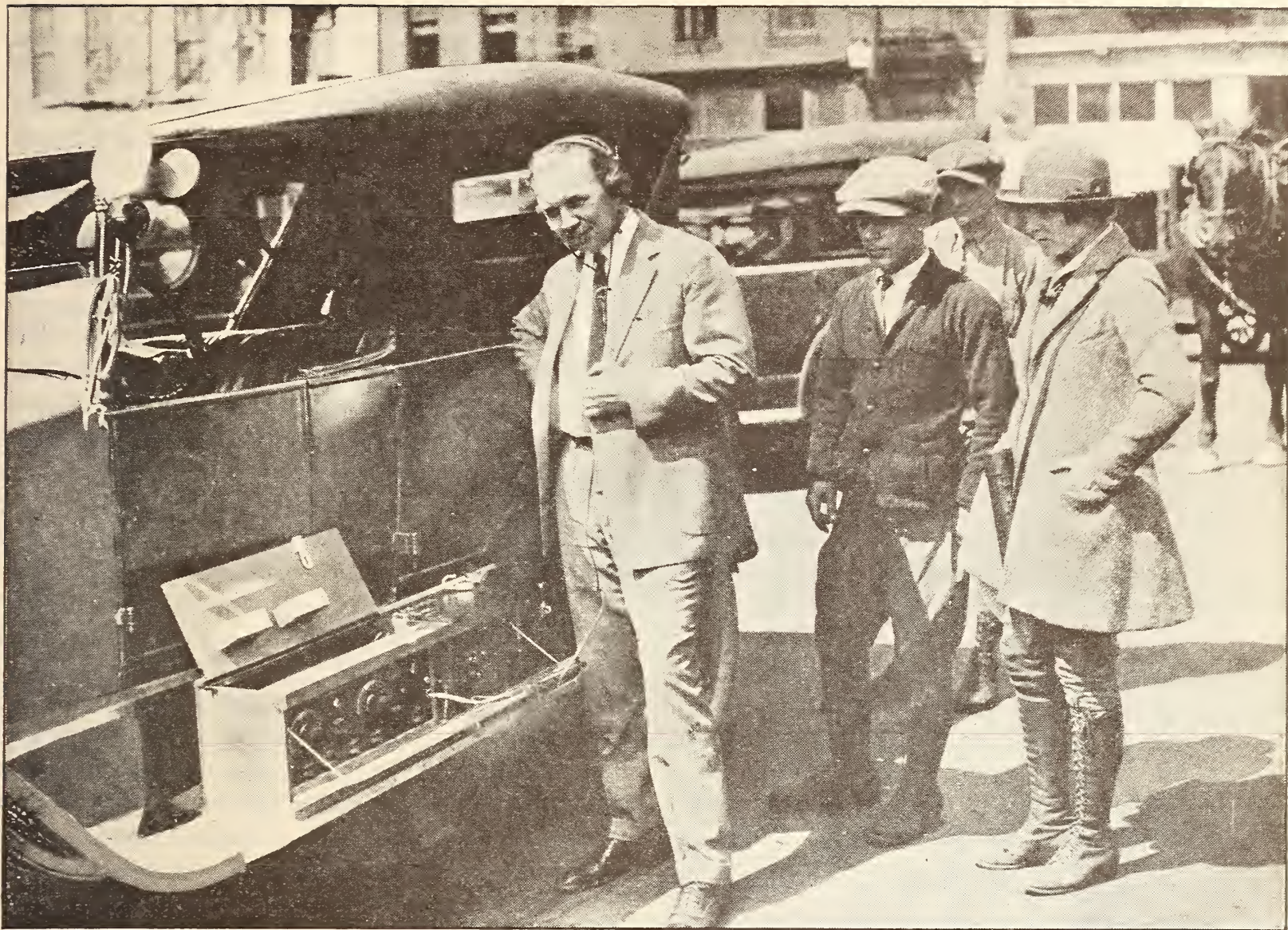

THE MAYOR OF KANSAS CITY LISTENS-IN ON PETER TAYLOR'S OUTFIT

Frank H. Cromwell is the first mayor to broadcast police court sessions and other municipal activities, as a means of civic education. (His story is told in August RADIO BROADCAST—"Selling' the Public on Better City Government.") Peter Taylor, his sister, Mildred Taylor, and Blanding Sloan (in background) invited the Mayor to try out the receiving set which they are carrying on their round-the-world auto trip. At the time the picture was taken, the car had done 3000 miles without breaking a tube in the set, which is mounted in sponge rubber

farmers in blue overalls, walking past. What would they think of a concert from this automobile? I hurried out, turned on an orchestra from Kansas City and came back to listen, to watch, and to finish my dessert. I watched them crowd around the car, each one trying to get nearer. They looked at one another with expressions of surprise. We sought the road again after the concert ended. All of them seemed disappointed that the radio had stopped, even though it had been going for a long time.

That night we had to set up camp and cook supper in the rain. No one seemed to be interested in anything but sleep; but music is always good for tired bones. I draped a poncho over the open set, tuned in a flute-piano-violin concert, tied a long string to the filament plug and rolled up in a blanket, still keeping hold on the end of the string. It was surely real comfort, lying there listening to the music and

the pouring rain, knowing at the same time that I did not have to get up to shut off the set. Later on, when I was nearly asleep, the concert stopped. I pulled on the string, the lights went out—and so did I.

Although I had never seen the Kansas City broadcasting stations, I had drawn layouts of their antenna systems, etc. These stations had served us faithfully, too, all the way from New York. It gives one a peculiar feeling first to hear a station when hundreds of miles away, then slowly by auto to cover the intervening gap which the radio spans in a moment. Each day the space grows less, till finally one finds himself rapping on the studio door.

From our Kansas City camp we received daily reports of road conditions by radio—an excellent service for tourists. When the report came that our route was passable, we moved on. Meantime I had taken down the equipment, and cleaned and inspected every part.

There were no loose units, wires, bolts, or anything to indicate that it had been having a rough ride on an automobile.

In our Kansas City radio drives, energy-vs.-distance results corresponded to those in Cleveland. Anywhere in the city signals were of the same volume whether the car was directly under the antenna or a few miles distant.

One night, while pleasure riding on the high bluffs in the northeastern part of the city, a car drove alongside us, and the folks inside smiled as they watched the lighted tubes and listened to the piano selections. Then others drove closer, soon making a rather large moving audience. We were using what one might call a folded antenna: the car top was down with the antenna inside it!

When we left Kansas City, buildings were taking on decorations for the arrival of the late President Harding on his Western tour. In the newspapers I read an article explaining the preparations for broadcasting his speech from Convention Hall through the radio station of



TAKING THE FROSTING OFF

the *Kansas City Star*. We reached Lawrence at midday. The afternoon paper announced that the President would be heard at eight o'clock in Central Park from the radio on our car. I had no hesitancy in telling the reporter that the speech would be audible for two blocks. Other work delayed us; it was after seven before we drove into the park to make a test. I did not expect that many people would come, due to the late announcement. I was uneasy as we drove in, for there were pop and ice cream stands erected in a haphazard manner, apparently awaiting some great event. It looked as though we had made a mistake on the park location which the Mayor had granted us. It came as a shock when a man in charge of one of the stands said that President Harding was going to be heard on a radio at eight o'clock. We threw up a thirty-foot line to a nearby bandstand. In a moment the Sweeney School at Kansas City came in with power to spare. It was then seven-thirty, and we had not yet eaten. We hurried to a restaurant, satisfied with our hasty test. At five minutes to eight we were back in the park again. A huge crowd of people stood there, and dozens were coming from all sides as we drove in. It was just one big unit wondering whether anything was going to happen, and if so, where the source of it was. Then it dawned on me that I was a poor sort of person not to have allowed any factor of safety on such an occasion. Up till the last moment we had driven recklessly over bumps in our haste. Suppose something had broken. Somehow I knew that it had not. The one loose wire at Chicago had not shaken my confidence in the equipment. If serious troubles were to develop, they would have done so before this, especially in Missouri, where springs broke and backbones suffered as we plowed through the muddy zig-zag ruts. We slipped the line under the antenna post. Sloan went off about a hundred feet to motion up or down on the volume. I did not want people to get too close, so I warned them that the talk would be so loud that if any one stood too near, his ears might be affected or he might be knocked down. They remained back and the volume from the loud speaker, only a foot or so above ground, was not shut off by a human screen. Finally the shouts of the audience at Convention Hall, Kansas City, died away. Our listeners gradually settled down on the grass. At first it was difficult for them to get over the unusualness of the situation: shortly

before, a car had driven in, and in a moment it was sending forth the voice of the President. Soon the faces indicated that every one was listening to the speaker himself, and not to a radio set. There was great applause many times as our hearers shared the feelings of the other audience in Kansas City. When all was over, many came to see the set and expressed great surprise at the good volume and quality. I tuned in a few selections from Omaha, then drew in the wire and drove away. Since there was no road it was necessary to drop off a high curb stone. I wondered what they thought of radio as we hit the street, purposely at no slow rate.

When approaching Denver where the Rockies rise up in the distance, I wondered what these huge ranges might do with radio waves. We camped in the city at Elitch's Gardens, gave the B batteries a test and found them ready for the grave. New batteries restored the proper tuning conditions. Los Angeles came in with remarkable clearness, considering the time of year and that we were using the car top antenna. We drove high up into the mountains above Boulder on one of the following nights. A range of the Rockies, a jagged vertical wall only a few hundred feet away, rises to the sky between the camper and the west. After dinner, my sister said, "This is one of the places where I enjoy radio best." I looked at the range running to the north and to the south and tried to see the top. Things looked dubious, but I connected the car antenna, and soon we had our choice of two stations in California, equally clear. The volume on the loud speaker was the same as at Denver, thirty miles to the east in fairly open country! Even with an antenna wire only three feet long, the stations were still audible on the loud speaker. As we approached these mountains, later, stations from the East fell off very rapidly. The volume was not even half that of West Coast stations which were a shorter distance away.

One afternoon at Elitch's Gardens we parked the car in a large circle of trees and staked a rope around them as an enclosure for the car. The newspapers read, "Dempsey-Gibbons at three." A number of people had listened to our concerts previously and had inquired about radio returns of the fight. Many fans were on hand at the appointed hour, and by the time the returns began to come in, there was a large

crowd. Some sat in the dirt, consideration for clothes being a minor detail. A director of a nearby theatre copied the returns and hurried them to the stage during the matinee. The scene was much like a real prize fight arena—the ropes, the crowd, perfect in every detail, except for missing towels and fighters. In this way, on another evening, we received the Willard-Firpo returns, for an enthusiastic crowd. There were many women in the audience, too, listening eagerly and cheering with the others. I wondered how many of them would have attended a real fight.



Denver, a veritable city of auto campers, gave me the impression that all America is touring. It seems we have taken on the gypsy's best heritage. Nearly every city, likewise, between New York and the West Coast

has provided a public camping ground for its guests. Municipalities apparently compete with one another to see which shall leave the best impression with the traveler. Many provide shower baths, running water, cooking facilities, grocery shops, laundry facilities, swimming pools, and garage service, most of which is free or available at cost price. In my experience in all these cities of American nomads, I have been surprised to find that almost all of the travelers are radio fans when at home, but that it just had not occurred to them to take the set along, or it seemed impractical to do so. Radio is such a great pleasure while touring, I am surprised not to have found one set on the road.

There is a pretty place west of Denver called Inspiration Point, where people go at sunset to look at the blinking lights of Denver down below, and to gaze west into the mountains at the setting sun. Many times we drove up there and turned on the radio in the late evening. Folks opened the doors of their closed cars and listened. One could hear by radio the orchestra that was playing at an amusement park far below beneath the blinking lights. Some people came near and looked into the set. From the light of the tubes surprised faces stood out in the darkness as first one, then another, looked into the mysterious half-lighted cabinet. It was a real pleasure to sit there in the dark looking into the dim mountains to the west and listening to the radio—first an orchestra, and then a few Southern songs or a violin concert. One man asked me if there

were a needle and record inside the case, and even after an explanation of radio he failed to understand.

At the time of this writing, our camp is on an Indian reservation at the foot of the mountains north of Taos, N. M. A cold, clear mountain stream, the Star River, flows by, almost underneath our tent door. An Indian village is only a little walk away. It seems an unusual kindness for them to have broken for the first time an age-old rule, in allowing us "white men" to camp here. We visited the Governor of the Pueblo when we arrived, and showed him the parchment scroll. He called a council, interpreted the writing, and wrote his name with those of other mayors of the country. The Indians were afraid of the paper, at first, for they feared that they might be signing away what little land they had left. They said we might camp there. However,

we chose to spend our first night in a colorfully furnished adobe house at the request of one of the Indians. The following evening the same Indian took us up a trail, which leads into the mountains where these people go to hunt, and gave us a place to camp—the best that he could find. I like it here. Every day the Indians come and visit us. A few know Spanish well, others speak good English. We converse with them as best we can in each language.

One Indian told me that he had picked up a piece of paper one day and read of radio for the first time. He said that he knew his thoughts would sometime bring a radio to his village. He told me he knew it was this which had brought us here. Then I understood why he had come through the crowd the first night we gave a concert in the Pueblo, and had shaken my hand in great enthusiasm, saying it was the first time he had heard radio. One night at our camp when we were listening to a Western station, he said, "California—thousand miles away," then looked first at the small wire then the set. After a while he said, "I wish I could go there, sing for my people in my Pueblo by your white man's radio." These nights remind me of similar ones in Cuba, recalling experiences when we journeyed to outlying sugar plantations and gave concerts to the people who live in straw huts.

Some of the Indians say that the white man's inventions are bad. They like them very much, but they know that with them and our ways, their colorful dances, their moonlight songs from the adobe house tops, songs for rain to grow their crops, and all their traditions, will gradually be lost. As they pass our door, some of them leading burros loaded with wood, others riding horseback to the mountains for game, they smile and call out "Bueno!" Often they stop to talk and to have a little coffee or a cigarette. I wonder at their calling us "Amigos" so few generations after the white man encroached upon their land.

Los Angeles and San Francisco are now only a few days' drive. As I look back, the country we have traveled through impresses me as one big playground for radio tourists. I regret that we are coming to the end, temporarily, of our radio rides. We shall nevertheless still have concerts from the States on our ship to Japan, at least until some Oriental station—in Peking or Calcutta—turns our dials to unaccustomed marks.



INDIAN CHILDREN LISTENING-IN  
Quite as curious as their white neighbors

# Just to Please the Wife

By HARRY IRVING SHUMWAY

Drawings by THOMAS E. MONROE

**W**HAT starts the thing is the Wife says to me one fair sweet morning she wants to hear some sort of a Largo by a bird named Handel and that I can do no better than trickle in town and buy one of these radios. All the neighbors have them. In fact, the first intimation a lot of the same have that their houses have chimneys on them is that they need something to hang the wires on. And so, says the Wife, if the neighbors have radios we've got to have one.

I remember the patent washing machine and the vacuum sucker and 8 or 9 water filters none of which was ever known to work, so I don't fall with a sickening thud for this latest idea.

"You are always knocking a proposition when you first see it," says the Wife. "You wouldn't ride on a trolley car when they first came out. I hate to say it, but as a cold water thrower you have Niagara Falls looking like a medicine dropper. For heaven's sake come out of the Tut Dynasty and realize the world is finding out something new every now and then. Why only yesterday, Mrs. Thumscrew-Jones told me she heard Troy, New York."

"That's no recommendation," says I. "You remember we drove through that place last summer and broke a rear spring on what they call their highway. Believe me, I don't want to hear from that place unless they send me a new spring."

"You have no poetry in your soul, no love of music," says the Wife. "With these radios we can tune in all sorts of concerts, lectures, and everything. Besides, it won't do you any good to argue because I'm going to have one anyway." The way she looks at me means plainly, "And don't you come home to-night unless you bring it with you."

Well, when they put it up to you gently like that, there's nothing you can do but do. Consequently, an hour or so later finds me looking in a store window full of things with names on them which Greek would be easy compared with. There seems to be a lot of excitement going on inside, so thinking it might be a fight

or something, in I go. I get wedged into a corner with another fellow, who has lost his hat, and who is breathing like a horse that has been down the home stretch too many times.

"Where are you hurt?" I says.

"Hurt?" he asks. "I'm the luckiest guy in the world. I got one."

"Got what?" says I, wishing to humor him. Evidently he is a member of the Coo Coo League.



"NOW I CAN GET DETROIT!"

"I got a QV 1234 tube," he gleams (or figures that sound like that.) "Now I can get Detroit!"

I choke off a good reply that occurs to me and inquire mildly, "Does this radio do that to you?"

"You bet," he says. "I've been after one of these tubes for weeks. Now I can get——"

"Yes, I know. You can hear Troy or some place. What's all the fight about here?"

"There's no fight," he says. "It's always like this. Just people buying radio stuff. Haven't you got a set?"

"No, but I gotta get one that'll play Handel's Largo, or there'll be the devil to pay."

"Then take my advice, friend," he says. "Take my advice and get a regenerative two-step frequenter with a Whiffenpoof hook-up."

I bust away from this maniac whose talk has me dizzy than riding the giraffe on the merry-go-round. I elbow my way up to a counter and a young lad with a tired face stands at attention.

"Without hard names or technique," I says, "let me meet something simple in a radio set—and something cheap."

He shifts his feet and leans against the counter. "You might get a tuning coil or fix up a loose-coupler set. Then later on you could——"

"Hold on," says I. "Let's stick to the present tense. Show me this loose-coupler."

He reaches into the case and brings out an apparatus which could be part of a sewing machine, perhaps. There are a couple of spools, one with copper wire wrapped around so it couldn't come apart, and another with cloth-covered wire the shade of a pool table. Some brass rods run through it and hitch into a small post. The whole is stuck onto a board.

"All you need with this is a crystal detector and a phone block. Wire them up, hitch on your ground wire and antenna lead and you can listen to the music."

"Can I hear Troy and Detroit and Chicago?" I ask.

"Sure—if you take the machine to within twenty-five miles of those places. This outfit only sucks in the signals at a 25-mile range. Do you live near here?"

"Yes."

"Then there's a couple of good broadcasting stations you can get without going anywhere. Later on you can make this into a regenerative tube set by adding——"

"Let's stay in low speed for now," I says. "We can graduate to something more fancy in the future. Show me how to wire this thing up and gimme the parts."

"You know about the antenna?" he asks.

"You mean how to tie a couple of chimneys together with wire?"

"Yes, you take a——"

"Wait! Draw me a picture of it and I'll follow your plan."

He gives me a book of instructions and makes a lot of diagrams on the back of an envelope and says it is so simple a child can hook it up. I think we over-estimate what our children can do. When they tell me anything is so simple a child can do it, I always know there is some darned hard technique to it or they'd never bother to hand out the child-can-do-it stuff.

Well, anyway, I take the thing home, unwrap the bundle, and step back waiting for the applause from the Wife. She stares at it with a cold eye. You would have thought I was the neighbor's old cat laying a dead mackerel on the table.

"What do you call *that* thing?" she asks.

"That," says I, "is a loose-coupler."

"It looks to me like an egg-beater—for ostrich eggs. What is its function?"

"Why, you said to get one. It's a radio. All we have to do is wire up a few things and presto—we have a radio."

She registers exasperation and takes in air. "You have been deceived as always," she says. "All the radios I have seen have had ambition enough to sit up. This thing is playing dead. Mrs. Thumbscrew-Jones's machine has a nice black board with dials and door bells, etc., all over it."

"Sure. That's the second stage. You get that way—I mean, that kind when the symptoms are violent. This baby I have brought home is a sort of rudimentary radio. Now let's lay off the argument and you help me spread the aerial in the breeze. Here's the sketch of it."

I lay the salesman's drawing on the table. As we live in the suburbs, the dope seems to favor a one-piece antenna about a hundred feet long.

"What's the highest place on the house which I can dig my feet into without a fall?"

"Try the sleeping porch," she says, pouring over the drawing. "This thing is simple. What's this other wire marked 'L'?"

"That's the lead-in wire. You wrap that onto the antenna and run it to the binding post on the machine."

"Simple. Now the other end of the long wire we can tie to Charlie Harding's cherry tree."

"It's an electrical wire and you can't graft currents on a cherry tree," says I, facetiously. (This was a feeble one, but you never can avoid getting them off your chest once they pop into your head.)



She pays little or no attention to me. "Get the wire ready and we'll go out."

Putting up the outside trimmings to a radio no longer excites any interest among the neighbors. Nowadays when you see a full grown prominent citizen in a Prince Albert coat and a new hat climbing a tree you don't think his mind's on a holiday or he's after reckless pub-



#### HE'S NOT CONSPICUOUS

Any more than if he's hanging out the washing; in fact, less

licity. You know he's putting up the family radio and he's not conspicuous any more than if he was hanging out the washing; in fact, less.

It's been many a year since I climbed anybody's cherry tree. I guess this is the first time I've ever done so without choosing my exit first. Outside of barking an old shin in a new place, no casualties result. The first end of the old antenna is up.

Next I make the sleeping porch and drop a rope down for the other end of the long wire. I hook her in place, attach the lead-in wire and run downstairs. By this time the old pulse is beating fast and I am getting as excited as a kid.

But it's no time to get excited. The more you study into radio the more you find out

that calmness and deliberation are your best assets. Like, for instance, the moment when I got the axe from the cellar and was going to smash the whole business—it was wrong, and you can't tame this new science so it will eat out of your hand by such 5,000 B. C. stuff as that. But I am getting ahead of my story.

The bird who sold me the loose-coupler drew a diagram which showed how I should wire up the crystal detector, which isn't like any crystal in my acquaintances but is a glass tube with a chunk of coal or something at one end and what the guy said was a cat's whisker at the other. We owe a lot to the cat. We use his whisker to play on a radio, and on the violin we use another part of him; which I will not mention as this is an article on radio and not violins. Then this crystal gadget has to be joined to what they call a phone block. Well, what with diagrams and arguments and a half hour or so, we actually get it done. Finally I stick the phone terminals into the block and attach one end of the ground wire to the machine, while the Wife runs the other end to a faucet which we have concealed in the kitchen sink.

It is a pretty auspicious occasion, as after dinner orators say, when we slide our ears into the phones. With one hand on the throttle of the cat's whisker and the other on the slide trombone of the apparatus, I start to tune up.

The point is, you have to tickle the crystal in a sore spot with the cat's whisker, and right away you get music—in dots and dashes, which isn't music to anybody but a parent with a new-born radio.

The crystal in the present instance is the most callous one you would find in a day's walk. Finally, after a few minutes, I find the cat's whisker is becoming exhausted and we aren't getting anywhere, let alone, Troy.

The Wife says, "You let me try that and you go rehearse these wires and things."

But no—not a mew out of the cat's whisker. Finally I have an idea that the ground may not be all that should be expected. I go into the kitchen and find that the Wife has wrapped the wire onto the faucet all right, but onto the *porcelain* part of it. Even I know this isn't quite *à la carte*, and besides it makes it hard to turn on the water if you should ever want to. So I give her a yank (the wire, that is) and hook her around the metal pipe. Great Cats! The Wife lets out a shriek you could hear a block away and I think I have electrocuted her.

"What's the matter?" I yell, running to the scene of the accident.

"There's a band playing," she says, as pleased as Christmas. "Shhh! It must be in Los Angeles, because I can just barely hear it."

I grab the other ear phones and sure enough there's a band going fine—keeping time and everything. It's clear, but faint. So I begin to manipulate the coil.

Yes, you've guessed it. I sour the whole machine. The band disappears. I wish I could too, because the Wife takes off her phone so she can tell me a few things.

"You never *will* let well enough alone," she exclaims. "You did the same thing to the carbureter on the car. You tried to cut it lean and it took a couple of garage hounds a day to get the car breathing again. This band maybe was in London for all we know and here you've gone and got us disconnected."

Well, we fuss over that machine for the next hour without getting a single message. The cat's whisker could just as well be a feather duster.

Finally, one of the members of our family which has any sense thinks of looking in the newspaper at the broadcasting news. No wonder we aren't getting an earful! The program is scheduled to stop just about the time I knock the cat's whisker for a goal from the field!

We make a fresh start in the evening and find everything is OK. The strength isn't all

that could be hoped for, but the quality is good. The next night we do better, probably the antenna gets loosened up, like a car after the first few hundred miles. I will say, it tickles me the way I can wipe a long-winded speaker right out of existence with two fingers. This is a mean but enjoyable advantage. You take an old man eighty years of age who gets his ears into a broadcast which is a bed-time story for little folks: well, you can't expect a boy of this age to curl up in glee over fairy tales. So what does he do? Why, he just tunes his way out of it and tries for the sound of some careless saxophone in another place. On the other hand, a kid seven years old may happen to get a report on market prices in the West. It's not often that a seven-year-old plays with that stuff as a hobby; so he just fools with a knob for a minute till he has tuned in the funny rabbits in the cabbage patch.

The Wife has always been a great traveler. She wants to tune in to Troy and Schenectady and other distant places. (The Los Angeles or London station, by the way, we found out is a store in the next town to us.) However, I'll admit I'm beginning to think, myself, of adding something to this set, so as to stretch it out—like making a three-bagger out of a scratch single. As I tell the Wife, if we had enough more junk to boost up the noise, we might hear PWX (Pretty Wild Xcitement) loud enough to smell the smoke from real Havana cigars.

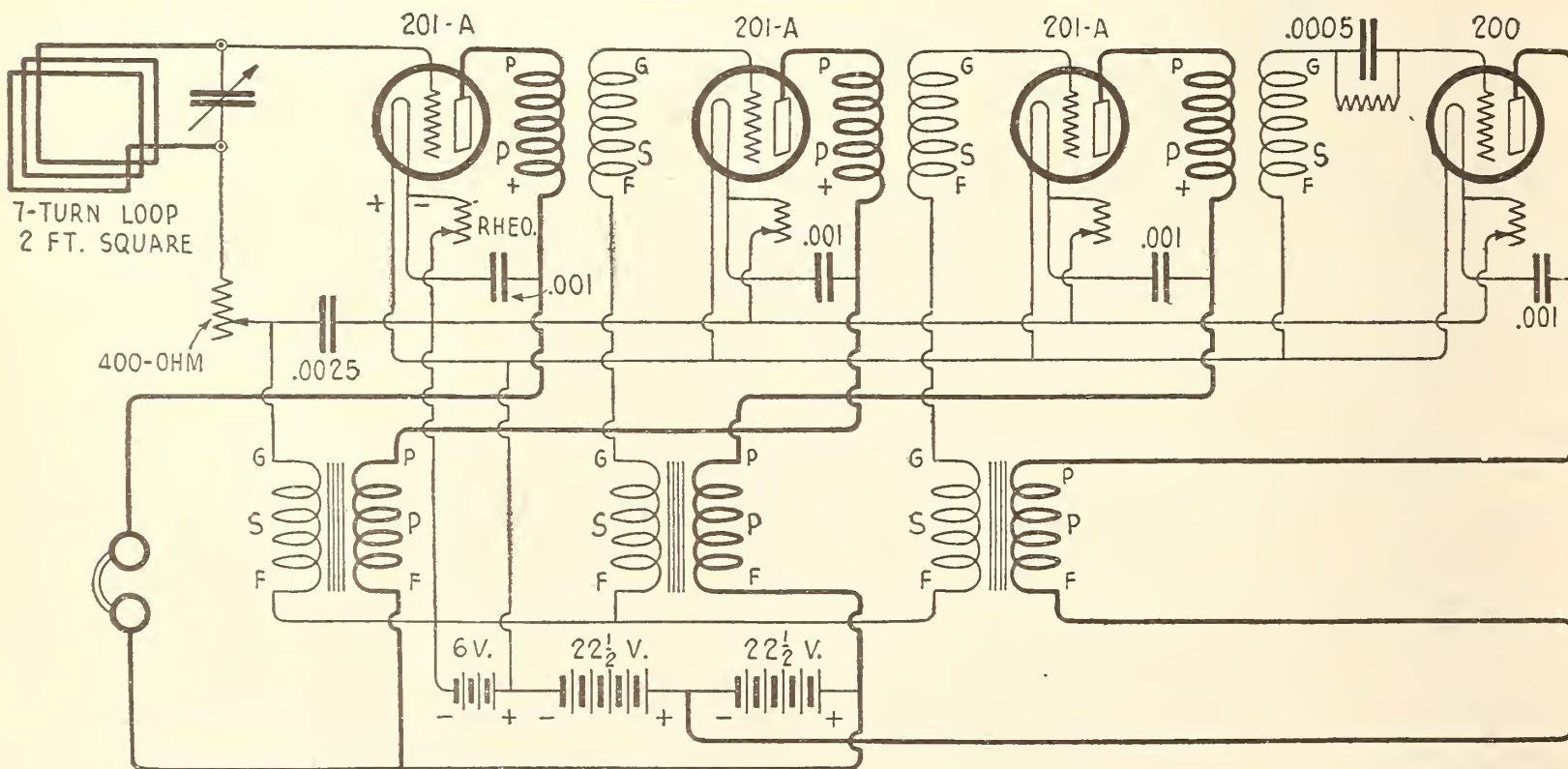

THE IMPROVED SHALKHAUSER CIRCUIT

The circuit shown here is an improvement over the one published in our August number (page 417). It is sometimes advisable to use .001 fixed condensers across the secondaries of the audio-frequency transformers in addition to those shown here

# Using What Junk You Have in Making a Super-Heterodyne

By GEORGE J. ELTZ, Jr.

Few radio enthusiasts appreciate that most of the equipment they are now using, or have on hand, may be used in building a super-heterodyne. As a rule, the only additional material necessary is a few tubes and three or four long-wave, radio-frequency transformers.

We have been making an effort to bring this receiver within the reach of those of moderate means, and have had the coöperation of a number of the foremost radio men in America. We are trying to reduce the number of tubes needed to the absolute minimum and are experimenting with various reflex arrangements. By combining the best ideas of the men who have done most with this type of receiver, we are able to pass many improvements along to our readers.

This article is a valuable addition to the information on the super-heterodyne which has already been published in RADIO BROADCAST, set forth by such authorities as Paul F. Godley, Walter Van B. Roberts and the author of this article.—THE EDITOR.

**T**HE super-heterodyne receiver, several descriptions of which have appeared in this magazine, is coming more and more into general use, and for several good reasons, the first and most important, perhaps, being the increased selectivity which is obtained and the greater distance over which it will receive.

The construction of a super-heterodyne is not difficult, although a certain amount of care and experimenting is necessary if good results are to be obtained. This is particularly true when the "super" is to be used with a loop antenna. To some, the expense of constructing this receiver has appeared to be excessive. Unquestionably, due to the number of tubes and other accessories required, it will always cost more than many other types of sets; but when a set is to be made or bought which uses more than three tubes, the expense for the extra tubes and parts for a super-heterodyne is more than justified.

Its wavelength range is unlimited. The amplification obtained at wavelengths of 10 meters will be exactly the same as the amplification obtained at wavelengths of 10,000 meters. This is a property not possessed by any other type of receiving set and one which makes the super-heterodyne very valuable for the reception of short wavelengths.

A super-heterodyne receiver constructed in accordance with any of the diagrams shown here and used with an aerial of moderate size should give reliable reception under any but the worst conditions over distances of at least

2,000 miles. A receiver of this type used under good conditions should have an effective range of about 4,000 miles. When used with a loop antenna, the range will vary depending on the location. Loud speaker operation on a good broadcasting station should be possible over



FOR USE INSTEAD OF HONEYCOMBS

This is an ordinary variocoupler with the primary winding split to make the two oscillator coils. The secondary is used as the antenna pick-up coil

distances of at least 1,500 miles. Loop antennas, however, depend for their operation to a great extent on their position and location with reference to surrounding objects, and it is impossible to predict exactly what results will be obtained. Instances are recorded where a loop antenna has worked equally as well as a large outdoor antenna. And just as many instances can be cited to prove the opposite. In general, a small wire, either outdoors or indoors, will give better reception than the loop antenna. As each location must be treated separately, the only way to determine which type of antenna or pick-up system to use, is by experiment.

For those who are not familiar with the action of the circuit, it may be briefly stated that by its use the amplification of the incoming signal occurs at a frequency of approximately 50,000 cycles, a point at which much greater amplification per stage is obtained than if the incoming signal was amplified at the ordinary frequency. The change in frequency is accomplished by means of an independent oscillator which is part of the receiving set. This oscillator sets up a frequency differing by 50,000 cycles from the incoming signal frequency. The result is a beat-note of 50,000 cycles, and it is this beat-note which is amplified. The variations in the amplitude of the beat-note are in exact accordance with the variations in the amplitude of the original signal. Reception, consequently, is free from distortion. No regeneration is required, a fact which further insures clear reception. After the beat-note has been amplified in what is known as the intermediate-frequency amplifier, it is detected by a second detector tube, the output of which operates the telephone receivers, audio-frequency amplifier or loud speaker. Unquestionably, many more super-heterodynes would be in use to-day if it were generally known that parts of receiving sets already in use may be used in making them. With this object in mind, we shall describe several popu-

lar circuits, which, by the addition of an intermediate-frequency amplifier, will permit the conversion of the receiving set already in use into a super-heterodyne.

An ingenious amateur can modify the super-heterodyne circuit in a number of ways. Once a good intermediate-frequency amplifier is constructed, the detector may consist of either a single- or three-circuit tuner. Practically any receiving set on the market may be used for this purpose. It is recommended, however, that a three-circuit tuner be used whenever possible, since the use of a single circuit tuner will reduce to a great extent the increase in selectivity which the super-heterodyne makes possible.

#### THE INTERMEDIATE-FREQUENCY AMPLIFIER

**T**HE most important part of the circuit is, as can be expected, the intermediate-frequency amplifier. On the operation

of this particular piece of apparatus, the success of the instrument depends. It may be constructed in several ways. The most efficient and by far the most sensitive amplifier uses radio-frequency transformers having a resonance point at about 50,000 cycles. Those manufactured by the Radio Corporation, UV-1716, are particularly efficient at 47,500 cycles, and are now being used in many super-heterodyne receivers with great success. In Fig. 1, to the left, is shown an intermediate-frequency amplifier made with these transformers. The apparatus to the right is a detector and two-stage amplifier such as is used with any ordinary receiving set.

The intermediate-frequency amplifier shown in Fig. 1 is made with a tuned input circuit, made up of two 600-turn Duo-Lateral inductances in a two-coil mounting, so that the coupling may be varied; or in some other suitable fashion which will accomplish the same purpose.

Shunted across these coils as shown in Fig. 1, are two variable condensers, each of .001 mfd. capacity. These, in combination with the 600-

#### How Much of This Have You on Hand?

- |   |                                   |    |   |
|---|-----------------------------------|----|---|
| 1 | 3-coil mounting                   | or | 1 short-wave variocoupler to be used in place of the coils and mounting |
| 2 | 50-turn coils                     |    |   |
| 1 | 35-turn coil                      |    |   |
| 1 | 2-coil mounting                   |    |   |
| 2 | 600-turn coils                    |    |   |
| 4 | .001 mfd variable condensers      |    |   |
| 1 | detector and 2-stage audio outfit |    |   |
| 4 | additional tube sockets           |    |   |
| 4 | additional tubes                  |    |   |

Provided with the above, you need procure only the long-wave transformers to make a "super" of your present set.

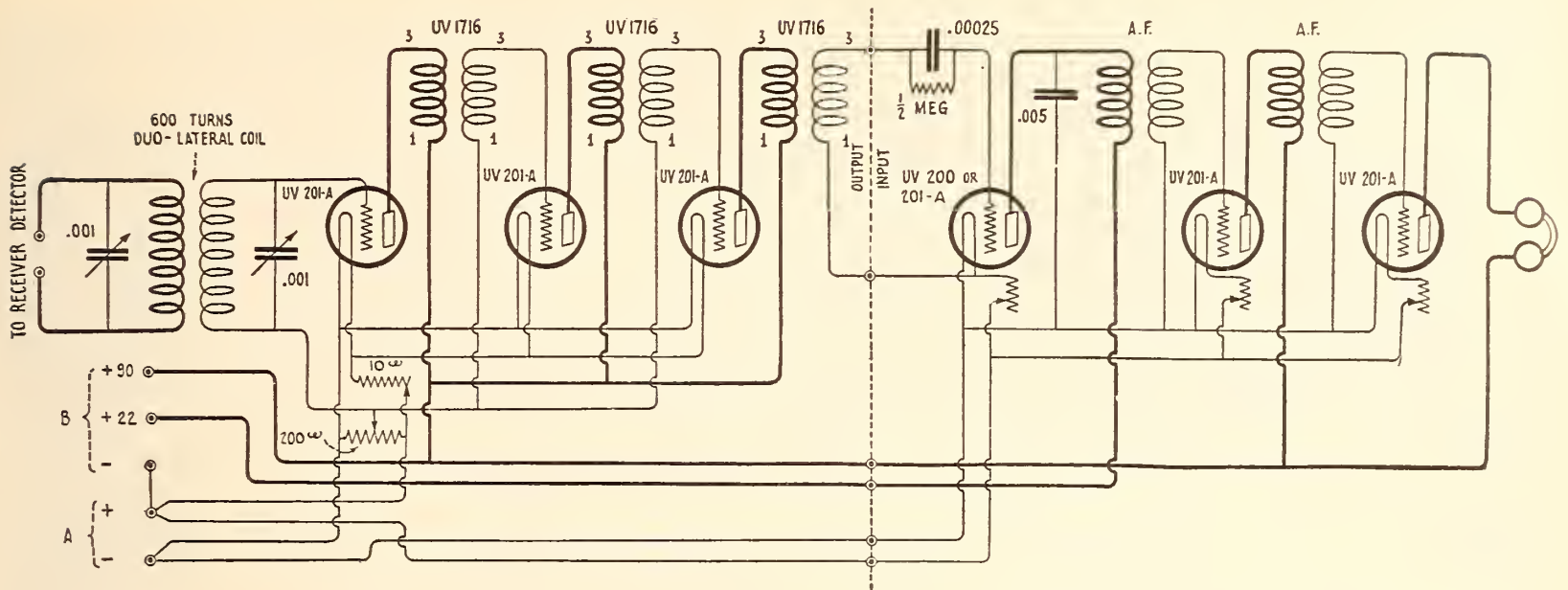

FIG. 1

Additional material required for the construction of the intermediate amplifier of the super-heterodyne is shown to the left of the dotted line. Material to the right of the dotted line is the conventional detector and two-stage audio-frequency amplifier, details of which have appeared in past issues of RADIO BROADCAST. This type of intermediate amplifier is tuned at the *input* to the amplifier by the 600-turn DL coils, shunted by .001 mfd. variable condensers

turn coils, give a frequency of about 50,000 cycles at one-half scale on the condenser. In this circuit the beat-note is tuned to resonance and amplified by the three tubes which follow. The output of the last amplifier tube is fed into the primary of the UV-1716 transformer, the secondary of which is connected to the terminals on the detector and two-stage amplifier marked grid and filament. *In making this connection it is important that the terminal marked "3" on the secondary of the UV-1716 transformer be connected to the terminal marked "grid" on the detector and two-stage amplifier. It is also important in the intermediate-frequency amplifier that the terminal on the primary of the transformer marked "3" be connected to the plate, and the terminal on the secondary marked "3" be connected to the grid.* The small condenser marked .005 mfd., shown in the plate circuit of the detector tube in the detector and two-stage amplifier, if not already present, should be connected in the position shown. The purpose of this condenser is to ground the 50,000-cycle frequency, preventing it from passing through the audio-frequency amplifier into the telephone receivers and causing oscillation of the entire amplifier.

The intermediate-frequency amplifier can be constructed without shielding, if the tubes are placed approximately 5" apart with the transformers immediately behind the tubes. If the tubes are placed with a shorter distance than 5" between their centers, the amplifier will in all probability oscillate and consequently refuse to operate properly. *If tickler terminals are*

*provided on the detector and two-stage amplifier, the tickler terminals should be short-circuited.*

#### TESTING THE I. F. AMPLIFIER

THE intermediate-frequency amplifier can be tested for operation by connecting an antenna and ground to the two terminals marked "to receiver detector." By varying the condensers across both coils and making the amplifier regenerate by manipulating the potentiometer, long-wave stations will be heard. If interference is obtained from long-wave stations, shielding the two coils and condensers connected to the first tube of the amplifier will eliminate this trouble.

#### CONVERTING A STANDARD THREE-CIRCUIT RECEIVER

FIG. 2 shows the manner in which a regenerative receiver using two variometers and a variocoupler must be altered to be used in connection with a super-heterodyne. In Fig. 2 the receiver is shown without external oscillator. The beat note must be obtained by causing oscillation to occur in the regenerative receiver. On short waves this is readily accomplished, but on wavelengths of 500 meters or above, this method is not so good as the one shown in Fig. 3. This diagram shows the same three-circuit regenerative receiver, provided with an external oscillator. The external oscillator is coupled by means of a three-coil Honeycomb mounting to the regenerative receiver proper. Coupling is accomplished by means of the 15-turn Duo-Lateral coil, shown

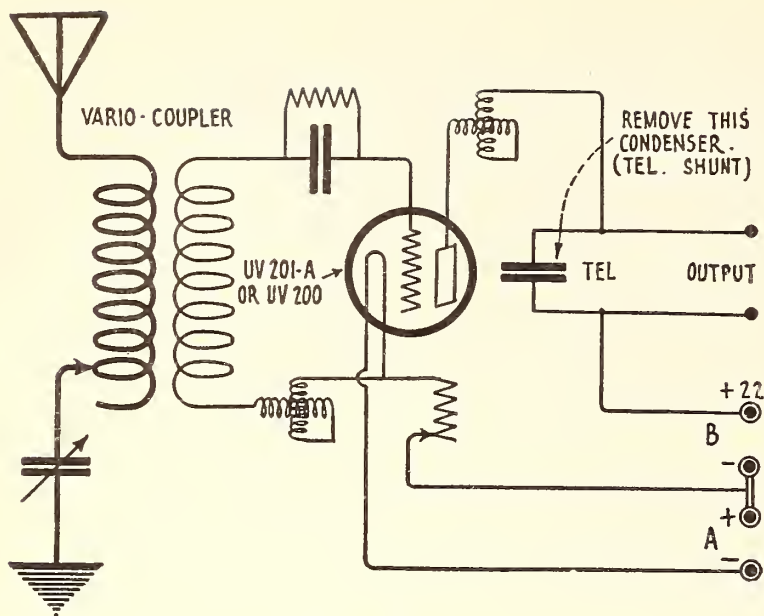

FIG. 2

Three-circuit regenerative receiver operated in conjunction with intermediate amplifier shown in Fig. 1. No oscillator tube is used, as the detector in the regenerative set operates as both oscillator and detector

in the lower left hand corner of the circuit diagram. The oscillator consists of two coils, one being a 35-turn Duo-Lateral, shunted with a variable condenser of .001 mfd. capacity in the grid circuit and a tickler coil of 25 turns in the plate circuit. Both these coils, when once set, need not be adjusted. The coupling of the 15-turn coil to the 25-turn coil must be varied. The same A and B battery may be used on all tubes in the set.

The circuit shown in Fig. 3 uses regeneration on the first detector tube. If this is used carefully, excellent results will be obtained. If the detector tube is made to regenerate too strongly, the customary amount of distortion present in a regenerative receiver will occur.

CONTINUOUS WAVE RECEPTION

C. W. may be heard with this receiver by causing the regenerative circuit to oscillate slightly, thus setting up a beat note between the incoming frequency and the frequency of the oscillator itself. This

is of advantage for amateur relay work. It is rather difficult to obtain this setting. In constructing the oscillator, care should be taken to see that no long lead wires are used between the various coils and condensers making up the circuit. The condenser marked .005 mfd connected to the plate circuit of the oscillator, should be right next to the coil, as shown. The purpose of this condenser is to prevent the high-frequency from the oscillator leaking back through the wires coming from the B battery and thus acting directly on the intermediate-frequency amplifier.

Most signals on the shorter wavelengths come from amateur stations, and the almost universal use of C. W. makes it necessary that a receiving set be suitable for this type of reception.

USING AN OSCILLATOR FOR C. W.

IN FIG. 4 is shown a method of heterodyning by means of which reception of C. W. is simplified. In this circuit an extra tube is used, which, in combination with the coils shown in the diagram, forms an oscillator differ-

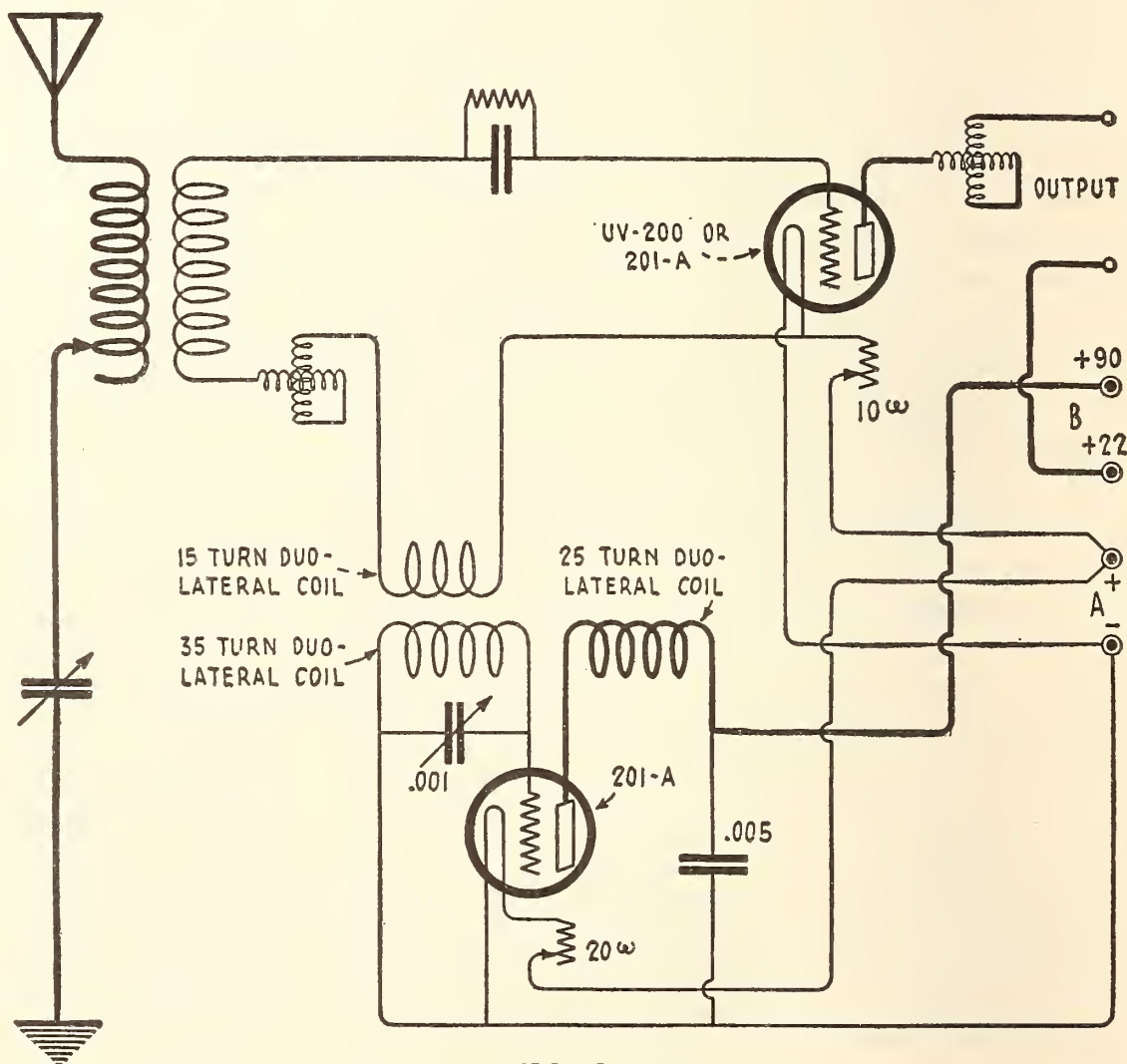

FIG. 3

Three-circuit regenerative tuner with oscillator. The first detector tube is regenerative, the oscillator tube uses the same A and B batteries as the intermediate amplifier. If regeneration is not desired, the variometer in the plate circuit may be taken out or shorted. This precaution is advisable in learning to operate the receiver

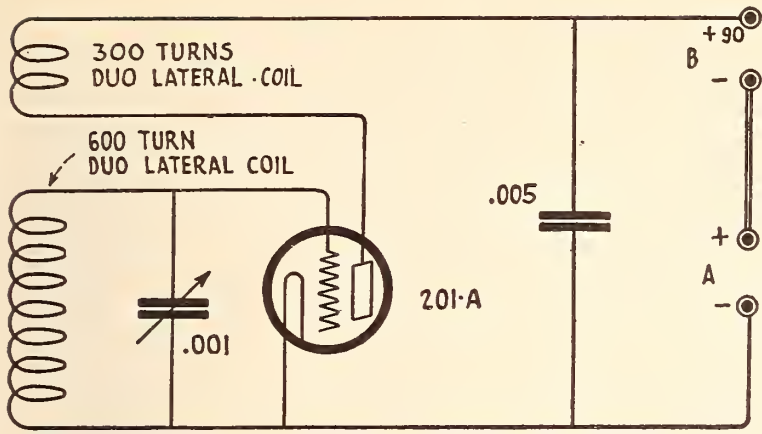

FIG. 4

Extra oscillator for simplifying the reception of C. W. This oscillator is adjusted to give a beat note of proper frequency with the incoming signal. It is placed near the intermediate oscillator, and need not be closely coupled. The same batteries may be used to operate it, however. It may be made very compact by using a UV-199 tube and flashlight cells

ing in frequency from the tuner of the intermediate-frequency amplifier by 1,000 or 2,000 cycles. This oscillator, in combination with the intermediate-frequency amplifier, sets up a beat-note which is unvarying in tone whenever C. W. passes through the intermediate-frequency amplifier. This method of reception does away with the trouble of setting the beat note frequency necessary with regenerative receivers and still retains all the advantage of the super-heterodyne. In Fig. 5 is shown another method of accomplishing the same result. This method is not quite so satisfactory as that just described. Of course, C. W. may also be received by causing the intermediate frequency amplifier to oscillate. The oscillation of the intermediate-frequency amplifier can generally be obtained by the manipulation of the potentiometer. The sensitivity of the re-

ceiver will be impaired to a certain extent, however, if this method is used.

AN I. F. AMPLIFIER OF IMPROVED TYPE

THE type of intermediate-frequency amplifier just described uses standard parts, and as far as efficiency is concerned is satisfactory. It may be improved, however, to some extent. One of the chief drawbacks of this type of intermediate-frequency amplifier is the fact that tube noises and B battery noises are amplified and passed on by each stage of amplification. In addition, it is al-

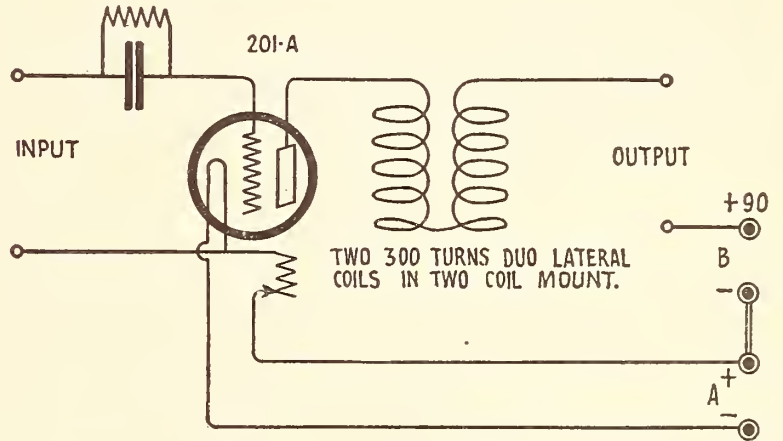

FIG. 5

Connection to second detector of amplifier shown in Fig. 4, to permit reception of C. W. The two coils shown act as a variometer to tune the plate circuit of the second detector

most always necessary to shield the two large coils used on the input. In Fig. 6 is shown an intermediate-frequency amplifier constructed along the same general lines as the amplifier shown in Fig. 1, but with the tuned circuit on the output side of the amplifier. The tuned circuit used in this amplifier may be the same as that used on the input of the amplifier,

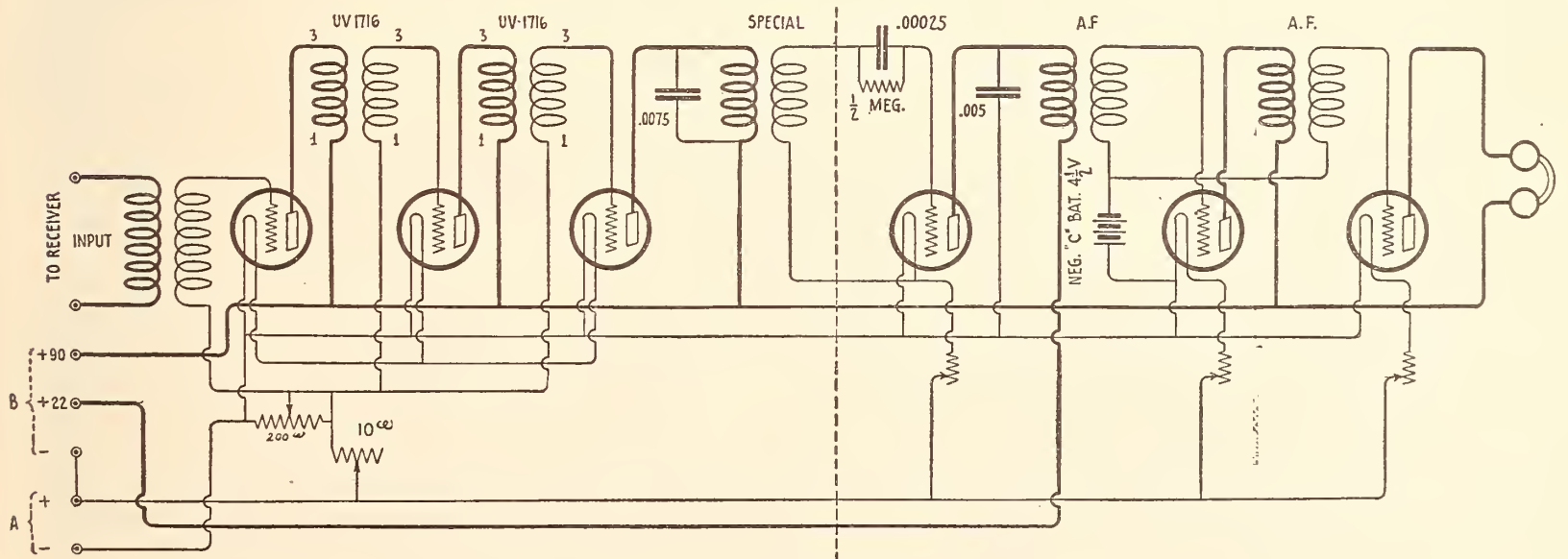

FIG. 6

Intermediate-frequency amplifier with tuned output circuit. Material to the left of the dotted line is extra equipment necessary. Material on the right of the dotted line is the regular detector and two-stage audio-frequency amplifier

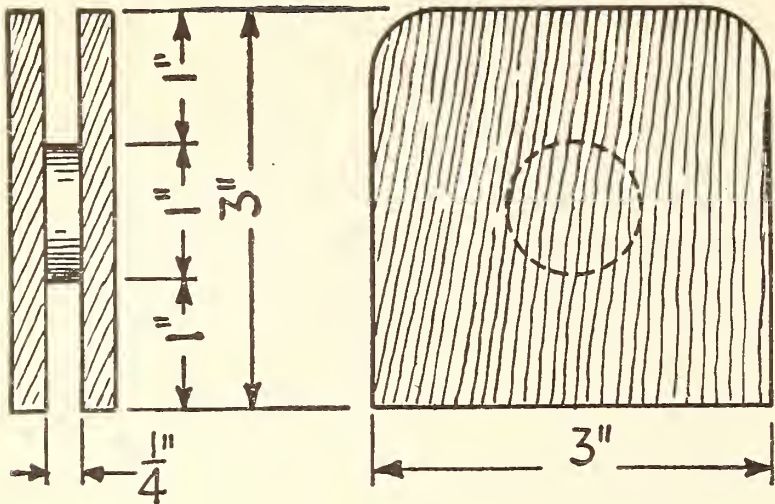

FIG. 7

This special transformer is used as indicated in Fig. 6 (marked "special"). The walls of this transformer may be made of bakelite or hard rubber. The primary is wound with 200 turns of No. 29 S. C. C. and is separated from the secondary, which has 1500 turns of No. 36 D. S. C., by several layers of empire cloth

shown in Fig. 1. Preferably it should consist of a special transformer, an illustration of which is given in Fig. 7. This transformer accomplishes the same purpose as the two coils and condensers used in Fig. 1 and when used properly overcomes the difficulties mentioned above. Although the transformer must be constructed specially, the added simplicity and saving in cost is well worth the trouble. The same care in shielding must be taken with this amplifier as with the amplifier shown in Fig. 1. A conventional detector and two-stage amplifier may be used, a small condenser being inserted in the position shown. For good quality, a negative C battery, if not already present in the audio-frequency amplifier should be inserted.

The amplifier shown in Fig. 6 can be used interchangeably with the amplifier shown in Fig. 1. When used with a regenerative receiver, a small fixed condenser of .00025 mfd. should be placed across the primary of the UV-1716 transformer on the input side of the amplifier. This small condenser acts as a by-pass for

the regenerative action of the receiver. In Fig. 8 is shown the connection which should be followed in hooking-up the amplifier of Fig. 6 to a regenerative receiver consisting of three honeycomb coils. Two three-coil mountings will be required for this purpose. The oscillator in Fig. 8 is the same as the one used in Fig. 3. The same A and B batteries are used throughout. In case only one three-coil mounting is available, the coils used in the oscillator may be wound on an insulated tube approximately 3 inches in diameter. The coupling between the 15-turn coil and the 35-turn coil should be variable in any case.

#### OPERATING ON A LOOP

FIG 9 shows the connection to be followed when using the super-heterodyne with a loop antenna. Here the first detector circuit is not made regenerative. This eliminates one adjustment and the possibility of introducing distortion by means of regeneration in the first detector. Of course, the signals obtained by the use of a loop antenna will not be so strong as they would if an antenna were used, but

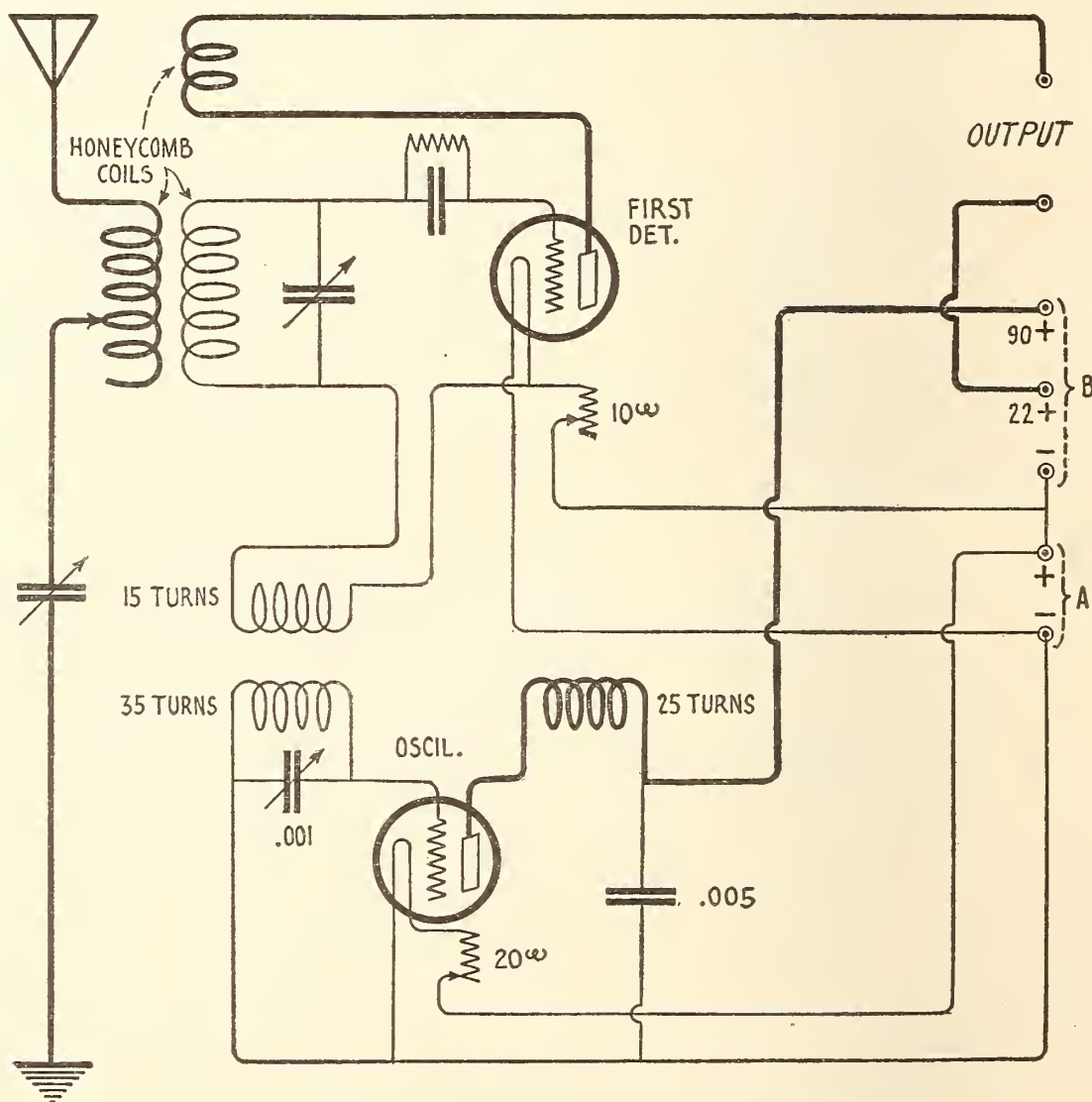

FIG. 8

Feed-back circuit regenerative receiver with extra oscillator. This may be used with either type of intermediate amplifier



less interference is likely to be experienced. Either of the intermediate-frequency amplifiers shown may be used, although preference should be given to the amplifier shown in Fig. 4.

#### USING AN ANTENNA

THE super-heterodyne receiver, while it has been generally used with a loop antenna, can be satisfactorily used with an outdoor antenna or a small indoor aerial. It is extremely selective; but when used with an outdoor antenna it is generally necessary to operate the receiving set connected with the antenna, with extremely loose coupling. If the coupling between the receiving set and antenna is too close, the selectivity of the first detector tube will naturally be destroyed and most of the tuning will have to be done by means of the oscillator. Even when this is the case, the selectivity of the receiver will be considerably greater than the selectivity of the ordinary receiving set. For this reason, it is not generally advisable to use a single-circuit receiving set as a means of coupling to the antenna and it is an easy matter to provide the set with binding posts to allow either method to be employed. If a small antenna is used, such as a short indoor wire, the single-circuit receiver will operate satisfactorily. No changes need be made in the grid circuit of the single-circuit receiver, the plate circuit being treated exactly as shown in the diagram for the two-circuit receivers illustrated in Figs. 2, 3, and 7.

Although most of the diagrams given show regeneration in the first detector circuit, this is not absolutely necessary. Regeneration does, it is true, improve the sensitivity of the receiver to a considerable extent but the introduction of distortion which is bound to occur when regeneration is present, argues against it. If the super-heterodyne receiver is used with a loop antenna, regeneration may readily be obtained by placing a variometer in the plate circuit of the first detector. Practically any variometer

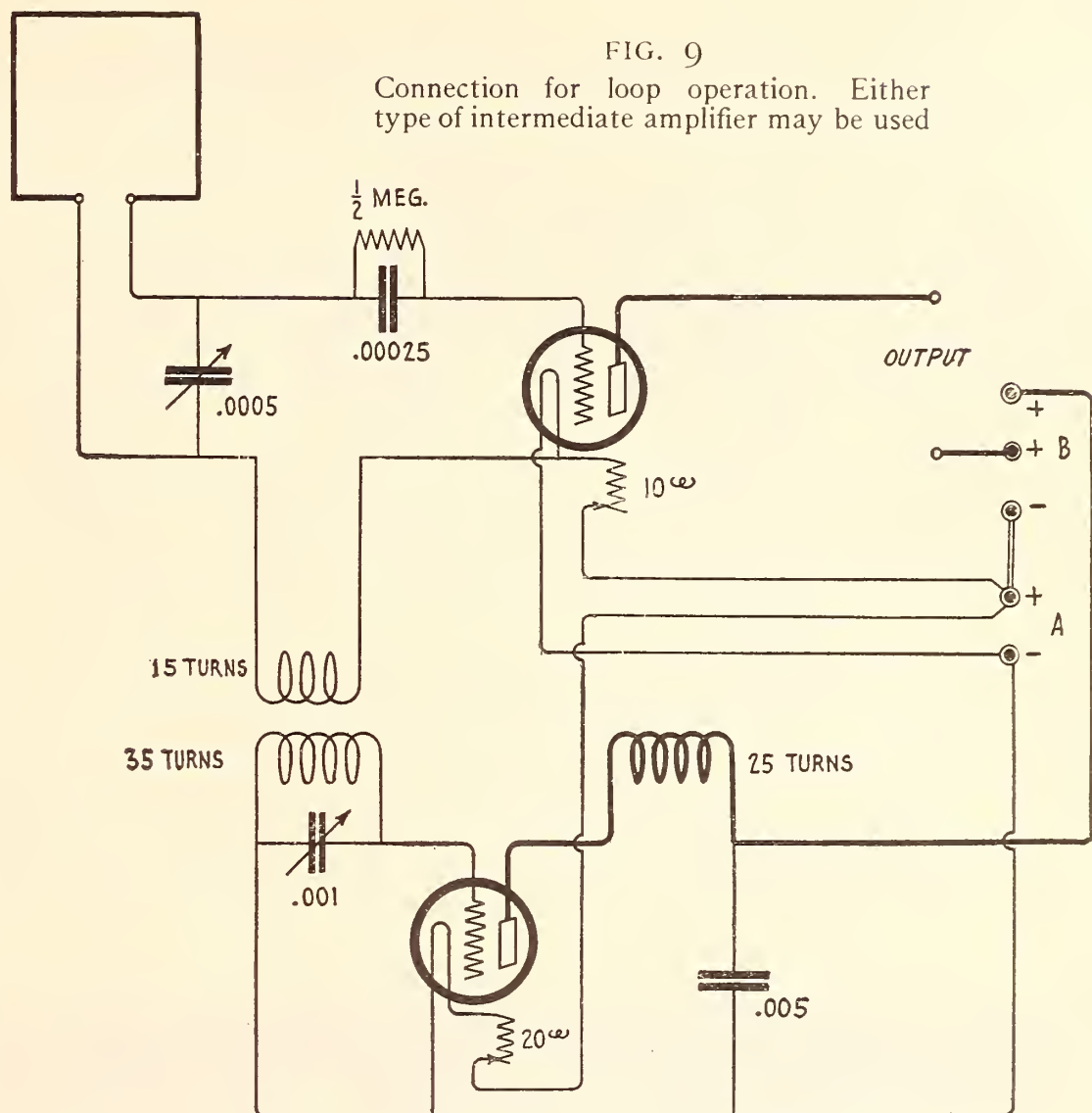

of standard manufacture will be suitable for this purpose.

A great many modifications of the super-heterodyne will probably occur to the ingenious amateur. The first detector tube may be replaced by a crystal detector when the receiver is used in connection with an antenna. (When used with a loop antenna, the first detector must be a vacuum tube.) Whether used with an antenna or loop, the second detector may be replaced by a crystal detector and good results obtained. In using a crystal detector as a second detector, be sure to pick out a crystal which will stand a considerable amount of energy without burning out. The amount of signal obtained from the three stages preceding, is sufficiently great to cause most detectors to burn out, necessitating constant adjustment.

Fig. 10 shows another modification of the super-heterodyne which works satisfactorily, although the number of controls is increased. This circuit shows one stage of radio frequency amplification before the first detector. Due to the characteristics of the radio frequency transformer employed, the sensitivity of the receiver will vary at different wave-

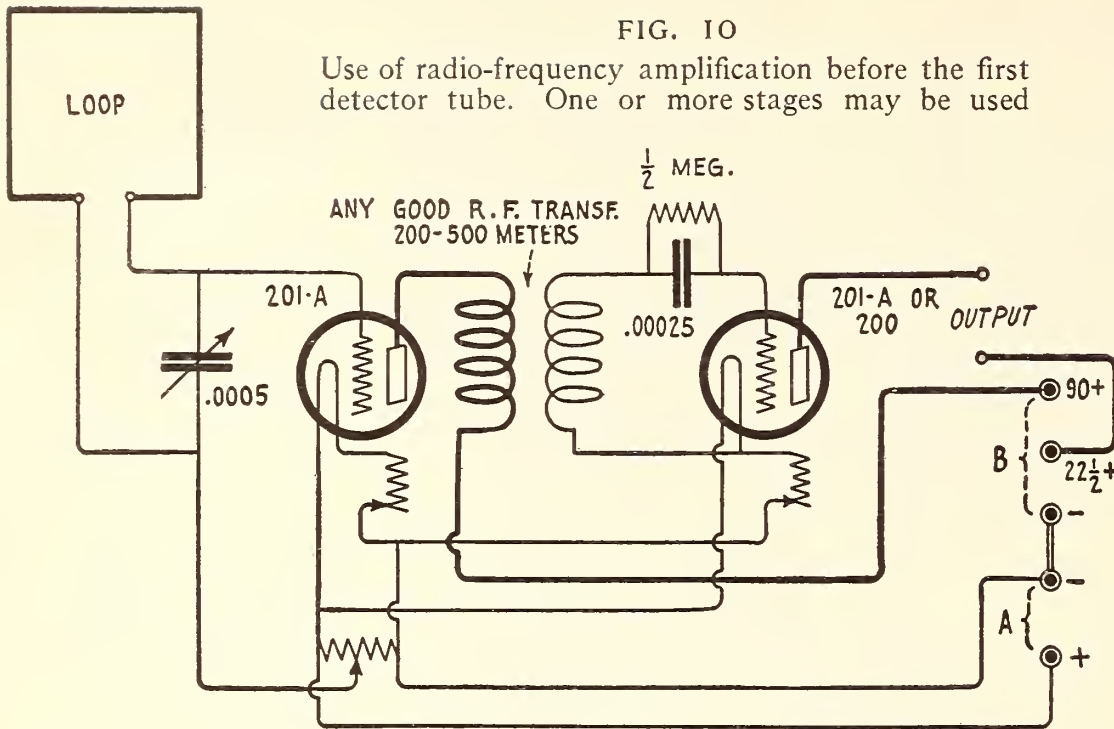

lengths. If, however, a narrow band of wavelengths is to be received, this method will prove to be quite satisfactory. The new Balantine tuned transformers cover the range of 200 to 600 meters quite well. Of course,

one or more stages of radio frequency may be used, but as a general rule two are all that will be of advantage. The circuits shown indicate the use of UV-201-A or C-301-A vacuum tubes. Practically any good vacuum tube may be used satisfactorily. Bear in mind, however, that when using dry-battery tubes it is necessary to insert sufficient negative C battery to bring the grids of the tubes to the right potential. In general, 3 to  $4\frac{1}{2}$  volts will be required. The value of B battery and A battery will depend to a large extent on the tubes used. It should not be necessary to exceed B battery voltages of 90, with a  $22\frac{1}{2}$ - or 45-volt tap for the detector tubes.



“‘CASEY’ STENGEL IS NOW AT BAT”

Mr. W. O. McGeehan broadcasting one of the World's Series games for WEA

# The Fundamentals of Loud Speaker Construction



A Technical Discussion of the Factors Which Must Be Considered in Converting Electric Current into Sound Waves



By A. NYMAN

Recent years have seen a very rapid development in loud speakers for use with radio receiving sets. In this paper, which was read at a meeting of the Radio Club of America on September 28, 1923, the writer outlines the essential features of a successful loud speaker and also some of the experimental results obtained during an investigation leading to the development of one commercially successful type of instrument.

IT HAS been found that music reproduction requires the presence of notes ranging in frequency from 25 cycles per second to 5,000 cycles per second. The quality of reproduction is affected to a large extent by the loudness of individual frequencies; hence, the necessity of bringing in each frequency at a value proportional to the original volume. It can readily be seen that the quality of the pick-up instrument or microphone, as well as the design of the transmitting and receiving systems, is of the utmost importance.

Apart from the pick-up and transmission, the following qualities are required in the loud speaker itself:

(1) Uniform intensity of sound at all frequencies from 25 cycles to 5,000 cycles.

(2) Absence of resonance points capable of responding at a frequency different from that applied or giving an excessive volume of sound when their own fundamental frequency is applied.

(3) The ability to reproduce a combination of frequencies with a volume of each frequency proportional to the input.

(4) Absence of distorting harmonics at any individual frequency applied.

(1), Uniform intensity of sound at all frequencies is particularly important in reproducing every kind of sound. For example: A weak or missing range of frequency is noticeable even to an untrained ear. However, if it is near either end of the total range, i. e., below 400 or above 3,000 cycles, an untrained ear may sometimes fail to detect this defect. Similarly, an individual missing frequency can be occasionally overlooked. A loud range distorts the quality to a considerable extent, and a loud individual note has a very unpleasant blasting effect.

(2), if overlooked, is particularly liable to

give blasting or an unnatural ring to certain notes. The fundamental may be suppressed and a harmonic of an altogether different pitch come through, possibly considerably louder than the applied note.

(3), dealing with combinations of frequencies, is particularly noticeable in speech reproduction. Normal vowel sounds consist of a fundamental of rather small volume and harmonics often much larger than the fundamental. Unless the proportionality is maintained, the sound of the voice will change, giving the impression of a changed pitch; a tenor voice may sound like a bass; a soprano like a contralto, or vice versa. The higher harmonics again determine the individual characteristics of the voice. Thus, in order to recognize a person's voice, the higher harmonics up to the 20th or 30th must be included and kept at their proportional value. What is true of the voice is true of most musical instruments.

Regarding (4)—the absence of distorting harmonics at any individual frequency—certain materials have qualities which give them

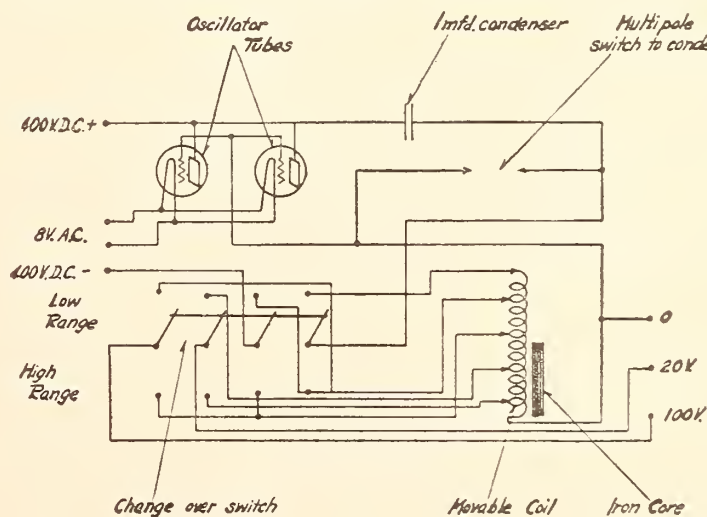

FIG. I

Oscillator designed to cover a range from 150 to 10,000 cycles

peculiar forms of vibration. Thus, the vibrations of brass are usually different from those of aluminum, wood, or micarta. This is generally due to a number of harmonics, each modifying the original note. In a loud speaker the pleasing quality and the naturalness of reproduction are dependent to a very great extent on the choice of materials, particularly of the material carrying a large amount of energy of sound.

#### METHODS OF TESTING LOUD SPEAKERS

THE four essential features of the loud speaker have been investigated by different test methods, partly dynamical and partly physiological; i. e., depending on aural observation.

Fig. 1 shows a diagram of an oscillator designed to cover a range from 150 to 10,000 cycles. A number of steps of condenser capacity raise the frequency about 50 to 100 per cent., while for each step the movement of an inductive coil on and off an iron core gives gradual variations of frequency. Each step of condenser is calibrated for frequency at different coil settings which are indicated on a graduated scale. The coil acts as an inductance and also as a transformer. Operating the set at 20 watts, the amount of power drawn to the loud speaker is small, giving good voltage and frequency regulation on load. In order to make the loud speaker circuit equivalent to a tube circuit, a resistance equal to the tube impedance is included in series with the loud speaker. Although the voltage on the oscillator remains fairly constant throughout the

whole range, for quantitative measurements the voltage can be checked at each reading.

Fig. 2 shows the pick-up arrangement for measuring the sound from a loud speaker. A condenser transmitter pick-up is considered very close to the ideal sound-receiving instrument and has been used by many investigators as a sound standard. The pick-up of this transmitter is amplified through a resistance amplifier, precluding distortion, and the resultant current measured on a milliammeter. The last stage, containing a step-down transformer, is also used for checking the voltage at each frequency. Hence, any possibility of reduction of received current at low frequencies is balanced by a corresponding reduction of the measured value of voltage.

Sound volume tests were conducted as follows:

The oscillator was operated through the complete range at fairly constant voltage, while measurements of sound by condenser transmitter were recorded and corrected by the value of voltage measured at each frequency. This arrangement gives a complete cycle from current to current and is evidently equivalent to the cycle from sound to sound. In addition, a point is obtained at 60 cycles to determine the loudness of very low notes.

The above test gives valuable data for investigation of the uniformity of sound and of the absence of resonance points. Listening to the sound, while performing this test, makes it possible to detect any foreign noise, rattle, or sound at a different frequency from that applied.

The ability to reproduce accurately any kind of musical sound or speech can be tested best by actual music and speech reproduction. Again a condenser transmitter has been used for the pick-up of sound. A number of stages of amplification (resistance coupled) bring the current to the loud speaker, while an audibility meter is so arranged that the volume can be cut down to any suitable loudness. Repeating each note on the piano several times is one of the best means of detecting any disturbing harmonics. Each note should

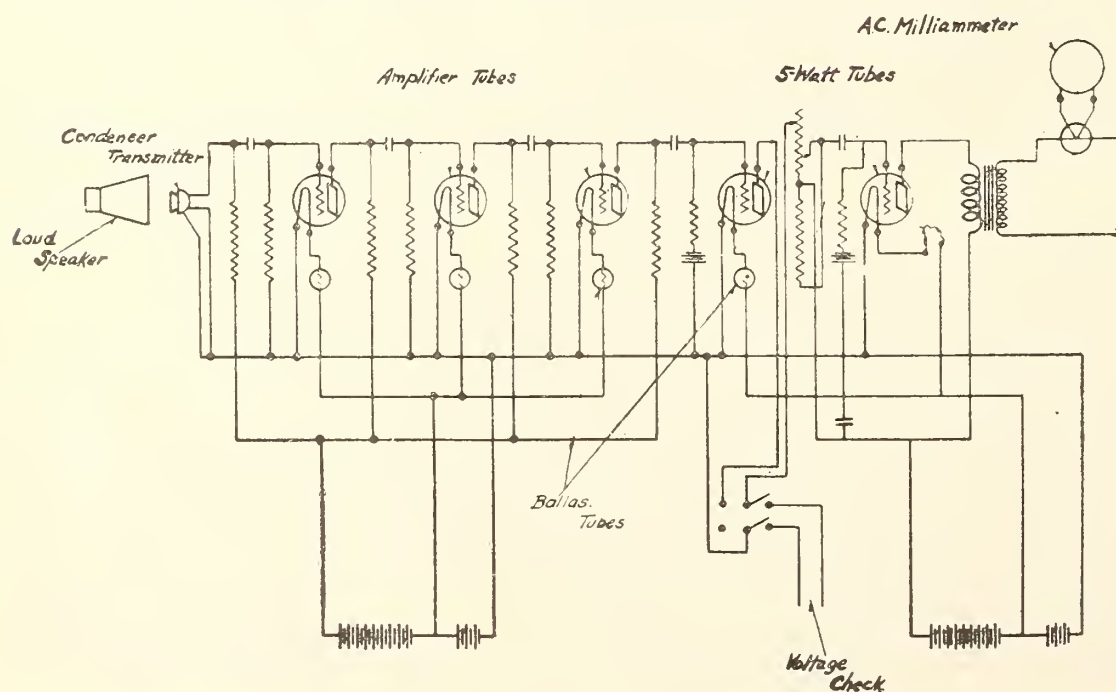

FIG. 2

Apparatus for measuring the sound from a loud speaker

come through clearly and should correspond exactly to the original piano note. Low notes in particular should be checked for the presence of the fundamental tone. Some designs of loud speakers, while giving a loud note at these pitches, are found to be completely devoid of the fundamental—the note is just the sum of all overtones.

Speech transmission over the same circuit gives a splendid test for quality and recognizability of reproduction. For proper speech reproduction the volume should be adjusted to equal, approximately, the loudness of the original speech. Of course, in a loud speaker designed for a large audience, with a special view to great volume, the speech must sound normal at the volume desired. The same loud speaker would not necessarily give natural reproduction at a lower volume.

An additional test for actual music reproduction is essential. Thus, a piano selection, a baritone solo, and a soprano solo are particularly good for detecting any faults in quality. In addition, a violin or a flute solo can be used to advantage to determine the ability of the loud speaker to reproduce the high notes naturally. The table below shows the list of tests and results that can be learned from each:

#### TESTS OF LOUD SPEAKERS

1. Measurement of volume (60 to 5,000 cycles)	Uniformity of volume, absence of resonance points and foreign sounds
2. Musical scales on piano	Accurate reproduction of quality on each note, particularly the low notes
3. Speech	Clearness of articulation. Individuality of voice
4. Piano selection	Clearness and naturalness on abrupt tones
5. Baritone and soprano singing	Clearness and naturalness of sustained notes
6. Flute or violin	Reproduction of high notes
7. Speech and music	Naturalness of superimposed sounds

The last test, the combination of music and speech, is very desirable. Each possesses individual characteristics, and the ideal loud speaker would maintain them. Very often, however, the presence of music will distort the speech, and vice versa. Of course, in this latter case we could not expect the loud speaker to reproduce correctly a number of musical instruments simultaneously, although the dis-

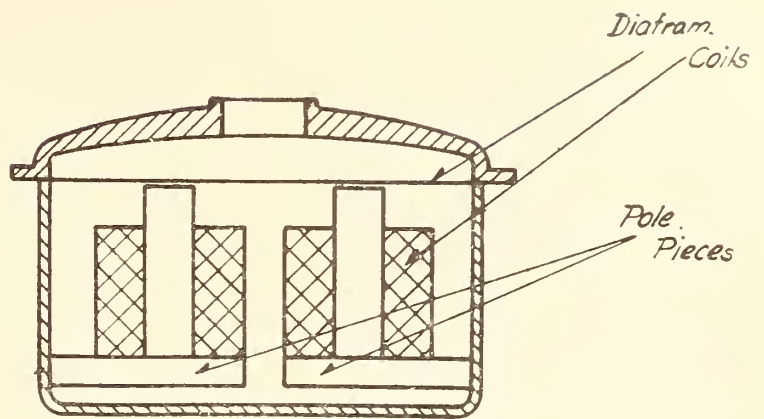

FIG. 3

Loud speaker unit operated on the same principle as the ordinary telephone receiver

torting effect might not be as noticeable as in the case of speech and music.

#### THE STRUCTURE OF LOUD SPEAKERS

IN A COMPLETE loud speaker the following mechanical parts can be segregated and investigated separately:

- (1) The electromagnetic structure
- (2) The sound-producing element
- (3) The sound-amplifying and distributing element

Figs. 3, 4, 5, and 7 show four distinct types of electromagnetic structures.

Fig. 3 shows a loud speaker operating on the same principle as an ordinary telephone receiver. It has a thin iron diaphragm held at a small distance from two magnetic pole pieces which are energized by a permanent magnet and also by two coils, one on each pole piece. The volume that can be obtained from this type of loud speaker is somewhat limited on account of the close spacing between the diaphragm and the pole pieces. Moreover, certain notes are accentuated, due to the resonance of the diaphragm. This, however, is not necessarily a defect. It is possible to overcome the resonance feature by means of a proper sound-amplifying device. The magnet in this type is often made adjustable. This permits a very close magnetic balancing of the diaphragm and a consequent improvement in quality.

Fig. 4 shows a moving-coil type of loud speaker. A circular coil is located in a round air-gap, with an iron core in the center. This air-gap is traversed by a strong magnetic field, excited by an inner coil which carries direct current, while the circular coil mentioned above carries sound-producing alternating current and is attached to the center of a dia-

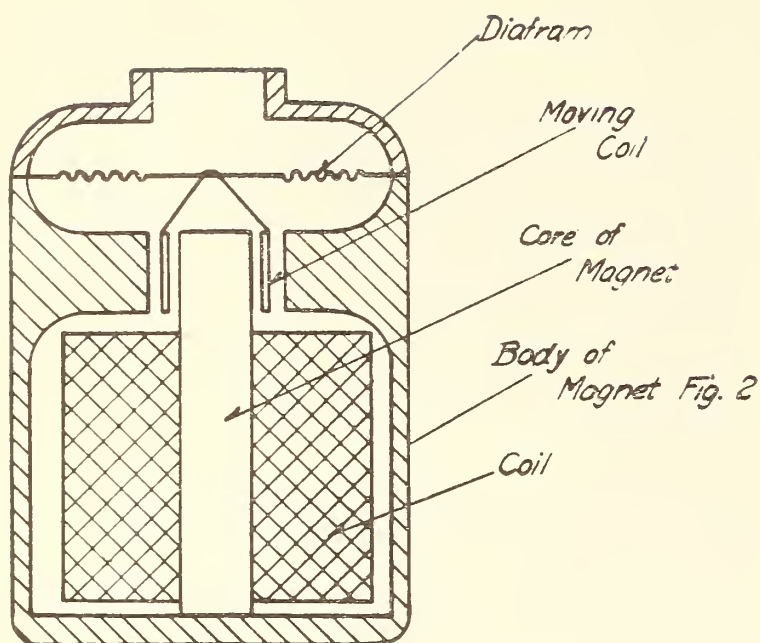

FIG. 4  
The moving coil type of loud speaker

phragm. Very satisfactory results can be obtained with this type of loud speaker.

Fig. 5 shows what may be termed the enclosed-armature type. A small iron armature is located in the center of a coil and suspended by two thin piano wires. The coil is surrounded by two U-shaped pole pieces, forming two air-gaps. A permanent magnet produces magnetic flux in these air-gaps. The current in the coil causes diametrically opposite pole pieces to be energized simultaneously, which causes the armature to rock. This rocking is communicated through a thin connecting rod to the center of the diaphragm.

Fig. 6 shows the sound distribution for a loud speaker constructed on this principle. The loudness is fairly uniform over the range. The graph shows the frequency from 100 cycles to 10,000 cycles on the horizontal axis, and loudness along the vertical axis.

Fig. 7 shows the "relay type" loud speaker recently developed. Its construction is similar to that of a polarized telegraph relay. A thin iron armature is located between four pole pieces, each carrying a coil. These pole pieces are magnetized by an L-shaped magnet and the coils are connected in such a manner that diametrically opposite pole pieces exert simultaneous attraction. The armature operates through a rod on a diaphragm.

Fig. 8 gives a representative curve of this loud speaker. The range is fairly wide, while no part of it is exaggerated in volume.

In all the above structures the sound-producing element is a diaphragm. Considerable variation is possible in the design of this

diaphragm. Of course, the first type requires an iron or steel diaphragm, or at least an iron center. The other types have a free choice of material. Aluminum and micarta have both been used successfully. It has been found that the quality of the loud speaker is considerably improved by proper corrugation of the diaphragm.

Figs. 9, 10, and 11 show, respectively, the variation of sound intensity with frequency for three different types of diaphragm.

Fig. 9 shows the resonance points with a very stiff small diaphragm. The lowest resonant point is at 1,500 cycles. The harmonics are at 2,900, 5,000, and 6,000 cycles, i. e., approximately in proportional 1:2:3:4. These resonance points may have been modified by the presence of the horn. The resonance points below 1,500 cycles are due to the horn.

Fig. 10 is the same relation for a fairly thin flat aluminum diaphragm. The resonance points are still very pronounced.

Fig. 11 shows the relation for a corrugated aluminum diaphragm of the same dimensions as the one used in the case of Fig. 6. Up to 3,000 cycles, the resonance points are not prominent.

Fig. 12 shows some of the types of diaphragm that have been tried. (b) and (c) have been found to give the most satisfactory results. The one marked (c) is the diaphragm whose performance is represented by the curve in Fig. 11. It has the corrugations spaced at radii bearing a ratio to each other corresponding to prime numbers. This diaphragm is based on mathematical considerations worked out by Dr. Philip Thomas.

Diaphragms (g) and (h) have the property

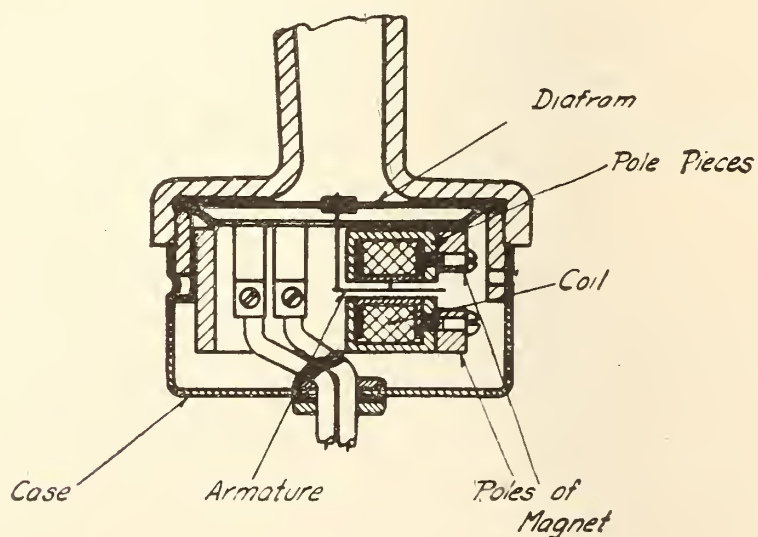

FIG. 5  
The enclosed-armature type

of having the same depression from either side. Diaphragm (i) has, in addition, an identical pattern from either side, and, consequently, is less liable to buckle either one way or the other. This quality is important, as demonstrated in a succeeding paragraph.

So far only two types of sound amplifier and distributor have come into practice; namely, a horn and a large conical diaphragm. Considerable controversy ranges about the type of horn which would give the most satisfactory results. It is difficult to record the effect of horns with the method outlined above.

Speech and music are both modified considerably, depending upon the length and shape of the horn, and on the volume of the sound. A horn longer than one quarter the wave-

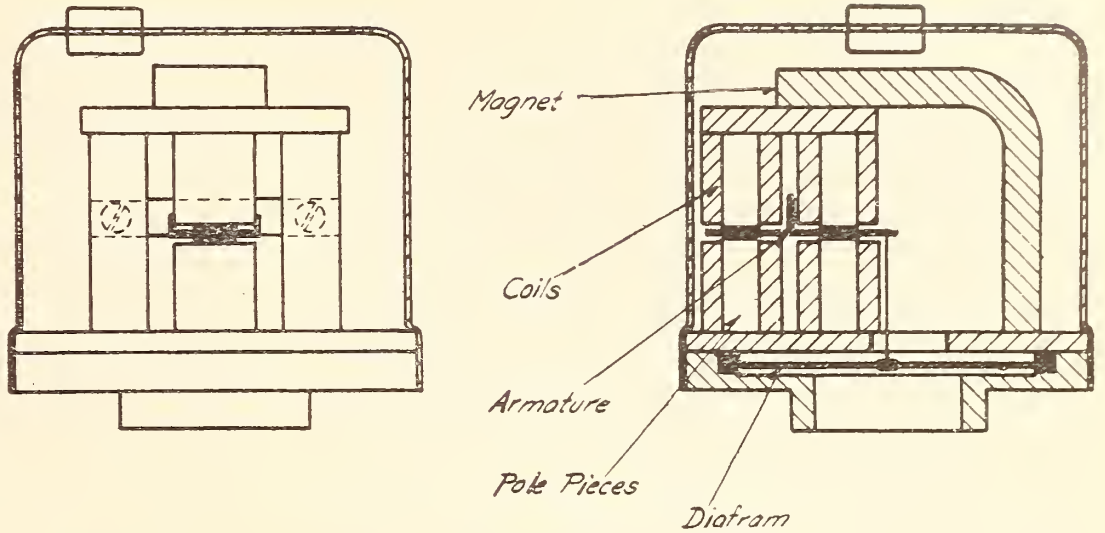

FIG. 7

Diagram of a recently developed loud speaker constructed after the fashion of the polarized telegraph relay

length of the lowest pitch available gives the best reproduction. However, in practice, the length of the horn seldom exceeds three feet, approximately one fourth of the wavelength of 90 cycles, the fundamental of the horn. If the horn is shorter than one foot (270 cycles fundamental), the bass and baritone voices are likely to be distorted, since their fundamental, which is below 270 cycles, would be reduced. It has been found that a loud speaker with a magnetic balance and a horn about two feet long is capable of very good reproduction of even very low frequencies.

Careful study has been made of materials to be used in the horn, in so far as they affect the quality of reproduction. A wood horn, or horn made of some "dead" material like hard rubber, is least likely to introduce a strange quality.

Horns of large volume carry considerable energy at resonance, which is dissipated only gradually unless the design is correct. Slow dissipation of energy would mean that some notes would be dragged out after this note had been silenced at the sending end. Aural observations give the most accurate information on horns. Experience points to the use of horns as large as possible, but designed with sufficient divergence and wide enough mouth to dissipate the energy.

Large conical diaphragms made of parchment or stiff paper have been used successfully. As a rule, it is difficult to reproduce the low range and the high range on this type of diaphragm. However, this type of sound amplifier is inherently free from resonance characteristics and therefore carries the greatest promise of future utility.

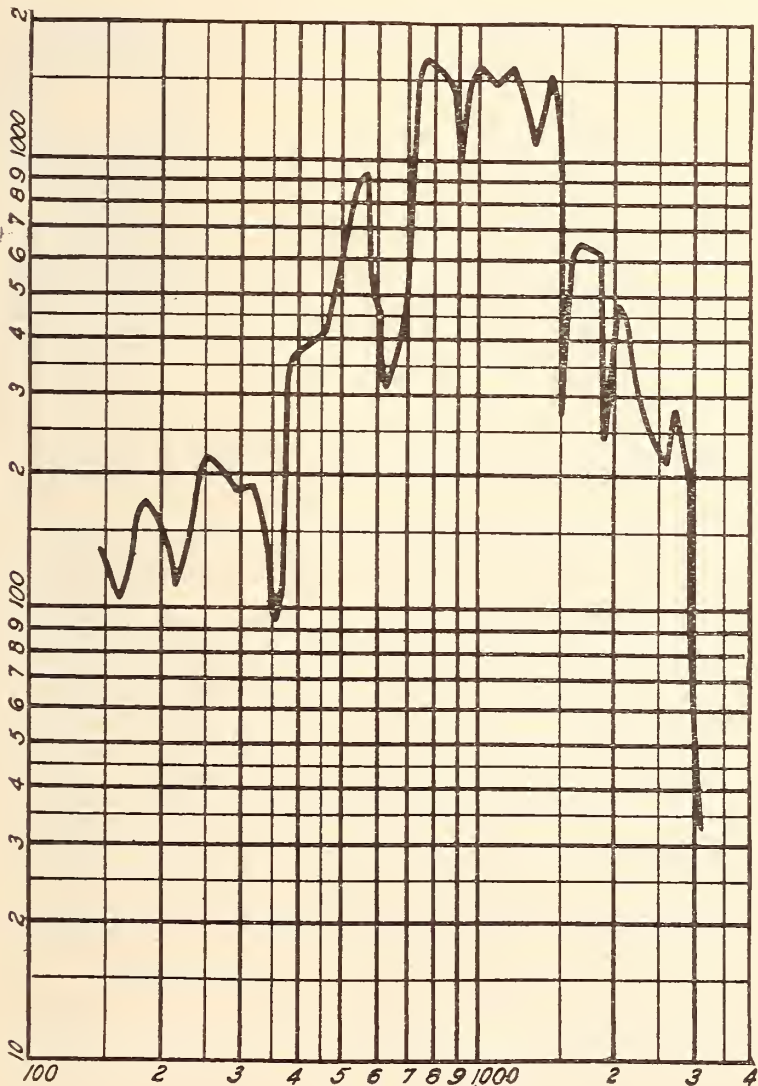

FIG. 6

Showing the sound distribution for a loud speaker of the enclosed-armature type. The horizontal axis represents the frequency, from 100 to 10,000 cycles, and the vertical axis represents loudness

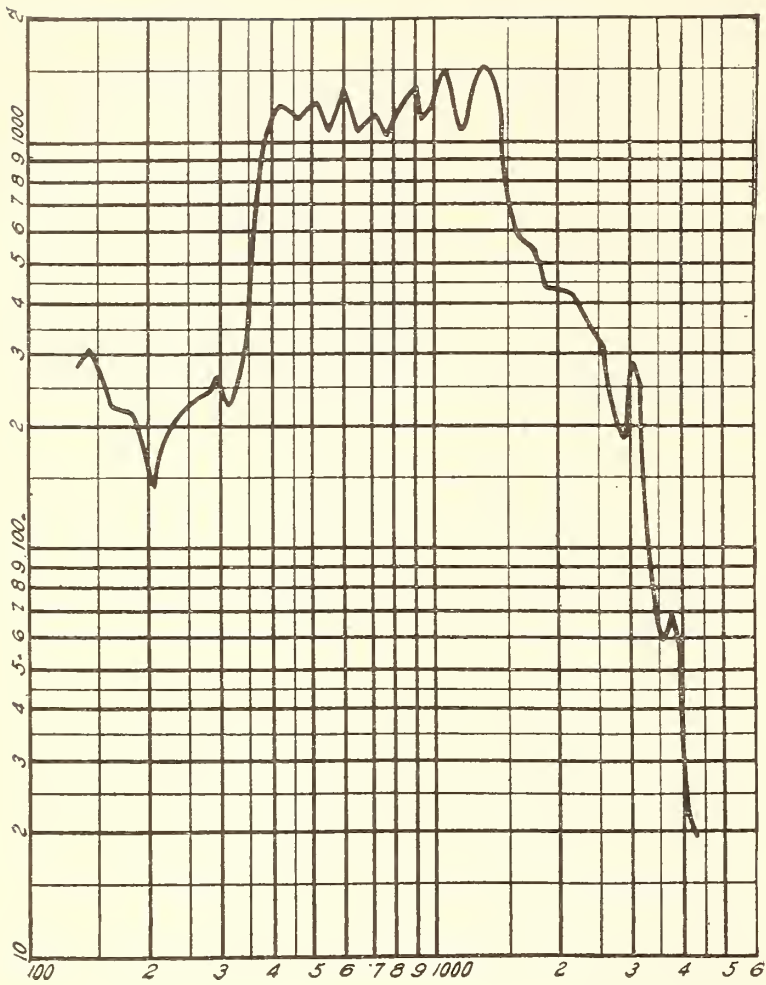

FIG. 8

The representative curve of the "relay type" loud speaker. Loudness is plotted against cycles (see Fig. 6)

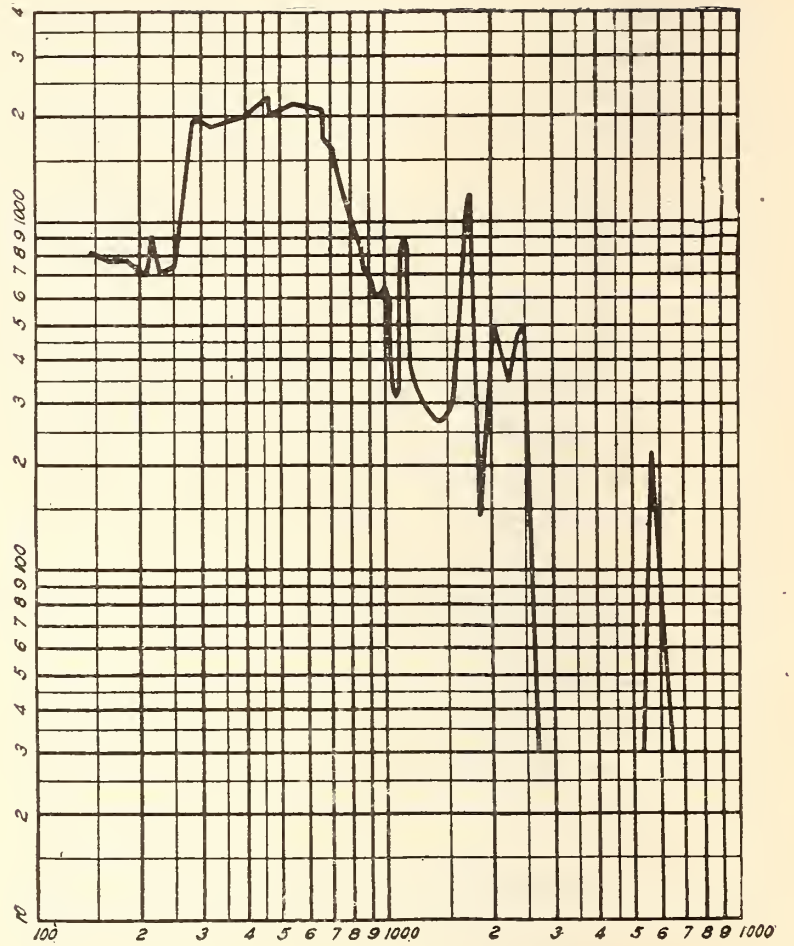

FIG. 9

Showing the variation of sound intensity (vertical axis) with frequency (horizontal axis) when a small stiff diaphragm is used

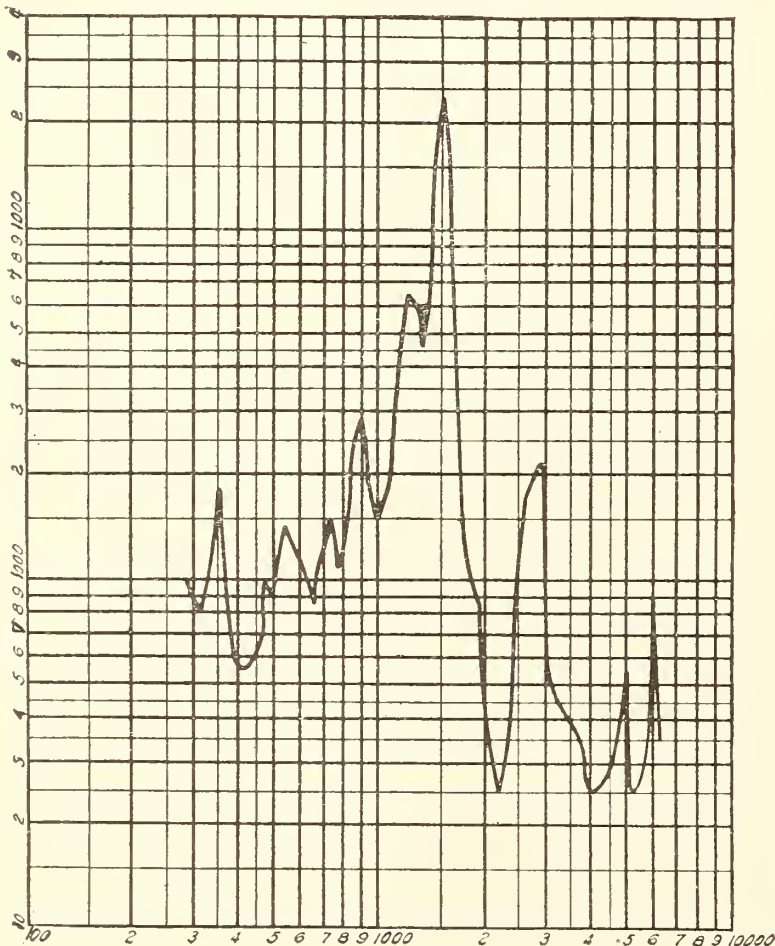

FIG. 10

Showing the same relation as in Fig. 9, but with a fairly thin, flat diaphragm

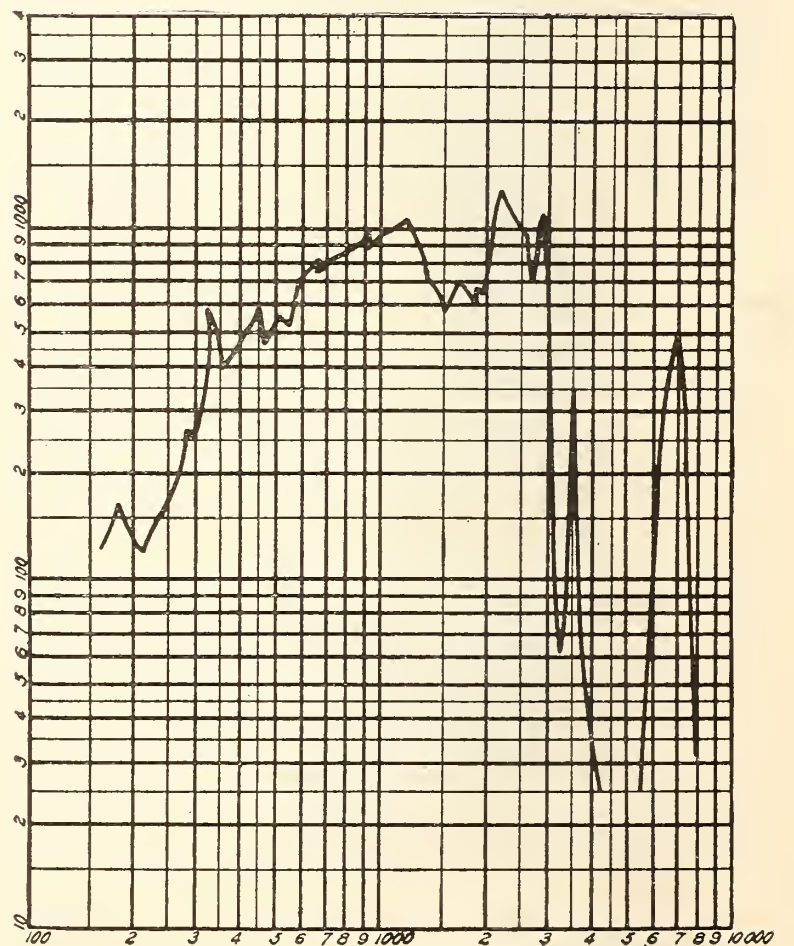

FIG. 11

Same as Fig. 9, but with corrugated aluminum diaphragm



RESONATING SYSTEMS

CONSIDERED from a mechanical standpoint, a loud speaker is invariably a complicated resonance system. Certain subdivisions of resonance, however, are possible.

1. *The Mechanism as a Whole*

The force of a magnetic field is in all types, except the moving coil type, counteracted by a strain in the diaphragm. In a loud speaker of the type shown in Fig. 3, that is, the telephone receiver type, this action is automatic. The diaphragm pulls down until its

that, with the magnet, the diaphragm requires distinctly smaller force for the same movement.

In this way the strength of the magnet and the tension of the diaphragm determine the force for certain movements and, consequently, the resonant frequency of the whole mechanism. By adjusting the magnetism in a way to get a very close balance, this resonant frequency may be placed very low. As a rule, the damping at these low frequencies is high enough to conceal the resonance; however, the whole of the low range will be found raised. This is demonstrated in Fig. 14, showing two curves for one loud speaker, one with a .015-

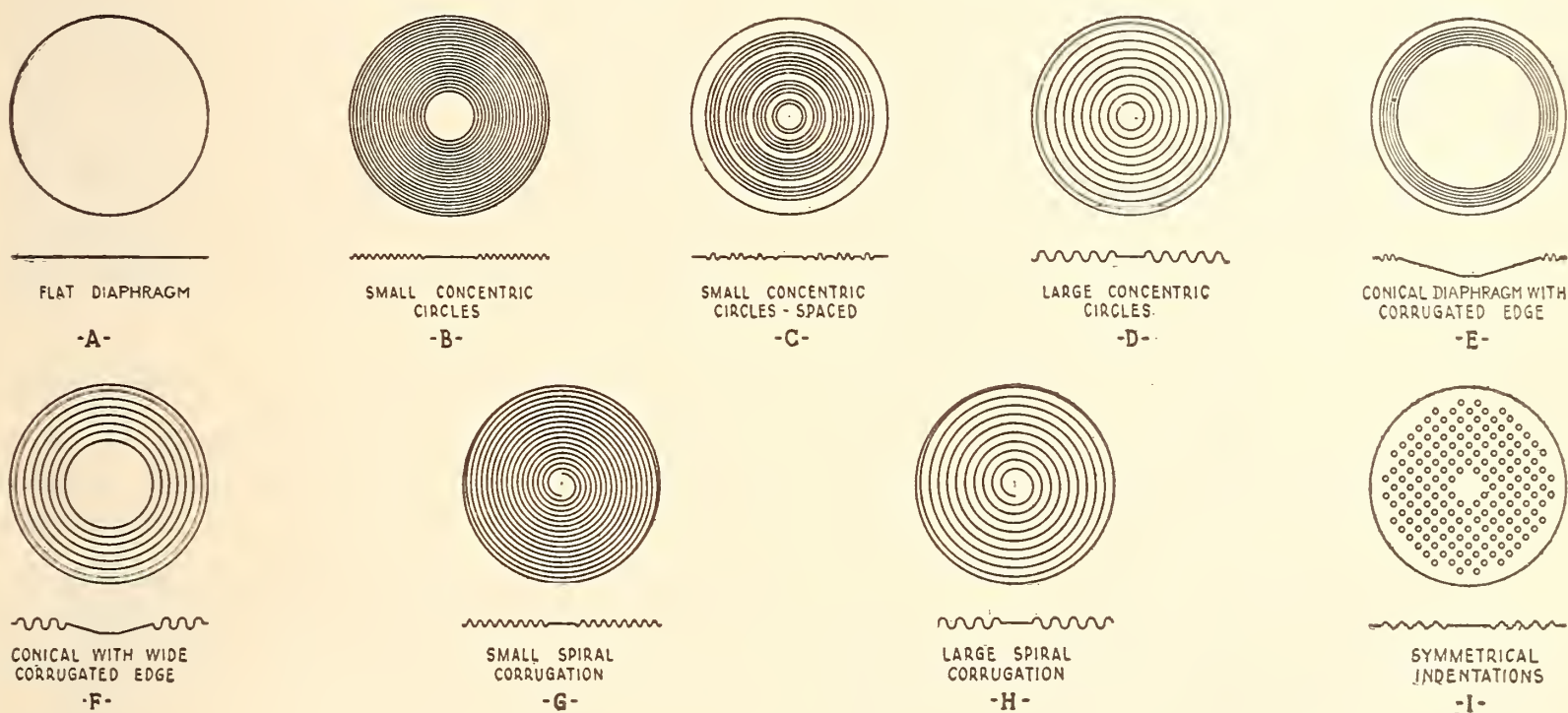

FIG. 12

Various types of loud speaker diaphragms

tension is equal to the pull of magnetic field. In the type shown in Figs. 4, 5, and 7, the normal position of the armature is such that the magnetic pull is zero. Actually, however, it is very difficult to keep the armature in this position. Generally there is a little pull one way or another, balanced by the strain in the diaphragm.

For a movement of the diaphragm, the magnetic field begins to exert a force helping this movement. If the magnetism is increased by using a stronger magnet, the force of the magnet may be made so large that it pulls the diaphragm over. Normally, a balanced condition may be obtained where very little force is required to produce a certain movement. Fig. 13 illustrates this fact. The two curves show the variation of force on the diaphragm with movement of the diaphragm, and show

inch gap, and the other with a .010-inch gap. The latter had a close magnetic balance; hence, all notes and the low notes in particular are increased. These curves were taken on the relay type loud speaker. It is evident that similar adjustment is possible on all types except the moving-coil type, in which the resonance point is determined entirely by mechanical strain and the mass of moving parts.

Fig. 13 shows a bend in the curve when the magnet is in place, i. e., there is an equality in pull for the two directions of movement. This is caused by a lack of symmetry in the diaphragm equivalent to a slight dish in one direction. A diaphragm free from this dish would give a straight line characteristic. Hence the importance of the development of a diaphragm of some such type as (g), (h), or (i) of Fig. 12.

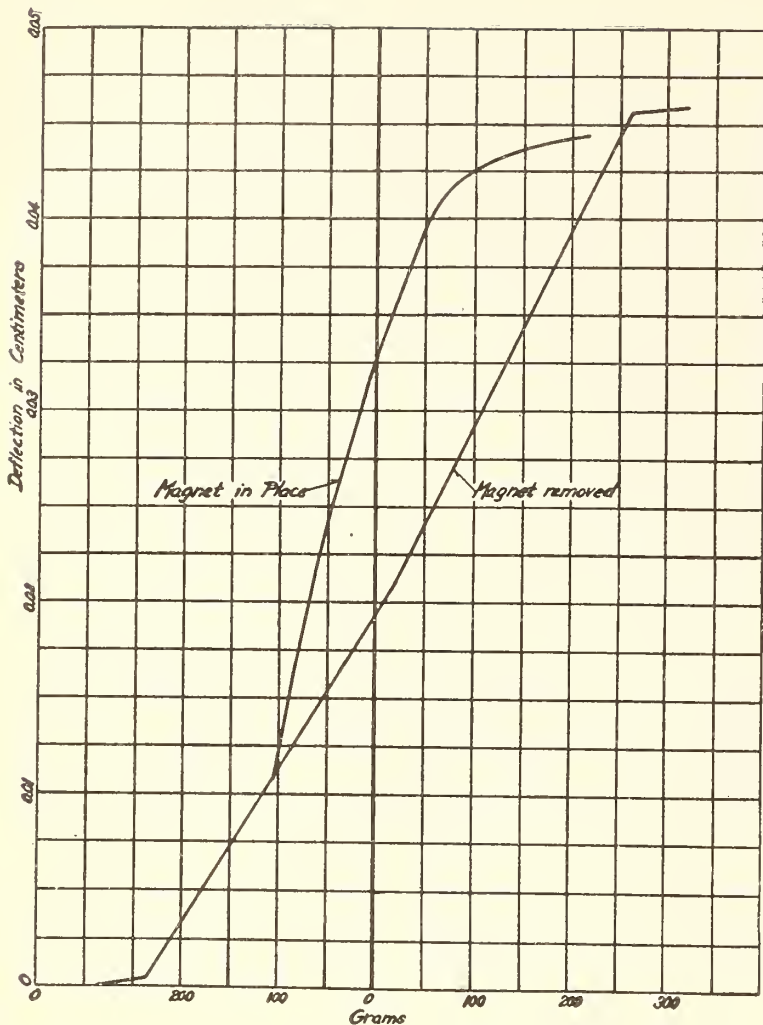

FIG. 13

Showing the effect of a permanent magnet on the movement of a diaphragm

## 2. The Diaphragm and Horn

In a foregoing paragraph the resonance points of diaphragm and horn were discussed. It must be remembered that the horn constitutes a load on the loud speaker. If it is possible to construct a load that remains constant at all frequencies, and large for a small movement of diaphragm, then the resonance of the diaphragm will be unimportant. This is one of the chief reasons of the success of large horns.

If the load due to the horn is small between its resonance points, and a resonance point of the diaphragm should occur at one of these points, the vibration may be excessive, with a resulting rattle and noise. The longer horn favors a more uniform load at different frequencies.

## 3. The Armature

The armature of a loud speaker of enclosed-armature or relay type is a strip of steel very short and stiff, but nevertheless possessing a resonance point within the audible range. It has been found that frequencies above this resonance point are difficult to reproduce.

Thus, Fig. 15, made using a loud speaker with a very small stiff armature, shows a range on higher notes extending to 5,000 cycles.

Another effect of resonance of armature is the introduction of foreign notes. An example is seen in Fig. 16, showing a reduction in volume at 800 cycles. At this frequency it was observed that the note had a strange high-pitched harmonic; however, damping the armature by a piece of rubber cleared this note and brought up the volume of its fundamental. The trouble was eventually overcome by using a much stiffer armature.

## 4. The Strip

The strip supporting the armature has a resonance note, but the forces acting in it are generally very small compared with the forces in the rest of the system. Hence the effect of the strip is negligible. The only exception is in attaching the strip to supports. It seems that any looseness at this point will result in a rattle.

## 5. The Connecting Rod

The connecting rod is subject to a complicated torsional and longitudinal strain. Unless this rod is sufficiently stiff, vibrations

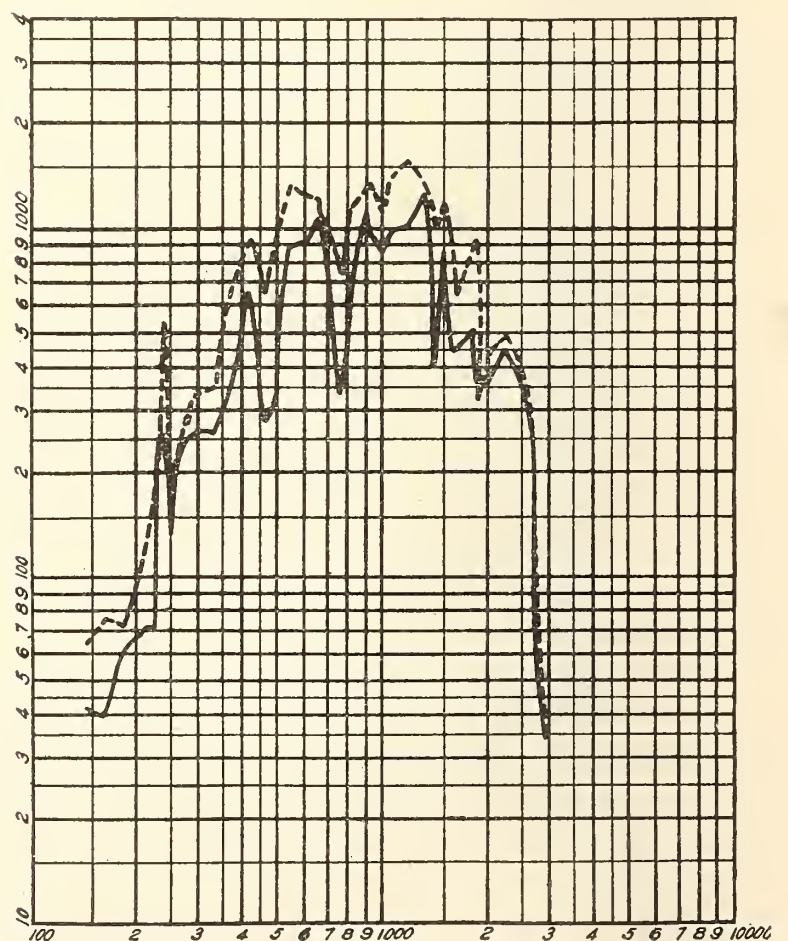

FIG. 14

Two curves taken with the same relay-type loud speaker; in one case, the gap was .015 in. (solid line), and in the other, the gap was .010 in. (dotted line)

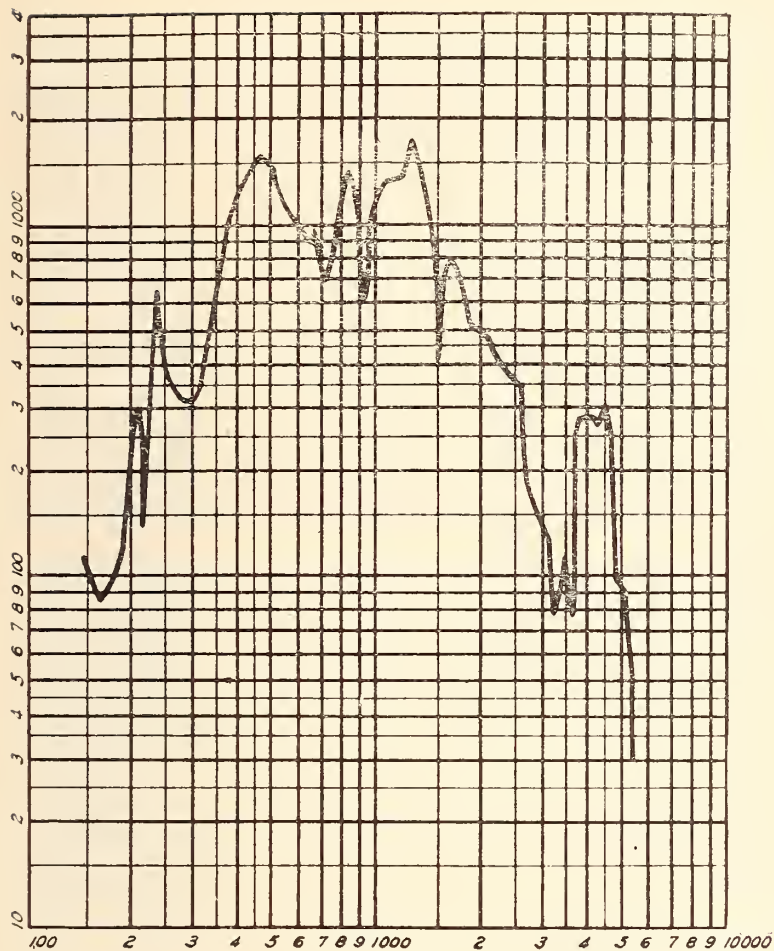

FIG. 15

Characteristic curve made with a loud speaker having a very small stiff armature. Vertical axis indicates loudness, horizontal axis indicates frequency in cycles

may be set up which introduce a foreign note at the lower frequencies and limit the sound at the higher frequencies.

CONCLUSION

IN CONCLUSION, a brief summary will be given, covering the outstanding points. The function of loud speakers is considered as that of a device for converting electric current, of frequencies ranging from 25 cycles to 5,000 cycles, into sound waves.

The essentials of this conversion are as follows:

- (1) Uniform volume at all frequencies.
- (2) Absence of strange sounds.
- (3) The ability to reproduce a combination of frequencies correctly.

Four fundamental types of loud speakers are discussed:

- (1) Receiver type.
- (2) Moving-coil type.
- (3) Enclosed-armature type.
- (4) Relay type.

Test methods are outlined for:

- (1) Measuring the volume of sound.
- (2) Testing the quality of reproduction.

The effect of various parts of a loud speaker on its operation are considered, namely:

- (1) The magnetic structure.
- (2) The diaphragm.
- (3) The horn.
- (4) The details.

The art of designing a loud speaker is extremely new. The empirical work for ascertaining the effect of various factors is only in its embryo stage.

Eventually, we may expect to design a horn or a vibrating structure with the same facility as an electric motor, because a loud speaker is really an electric motor though its load is less tangible than the load of most motors.

The design of a loud speaker must be based on a scientific analysis of this load and of its reaction on the motor. This involves considerable acoustic research work, mechanical research on vibrating structures, and electrical work on the effects of vibrating parts in an electromagnetic structure.

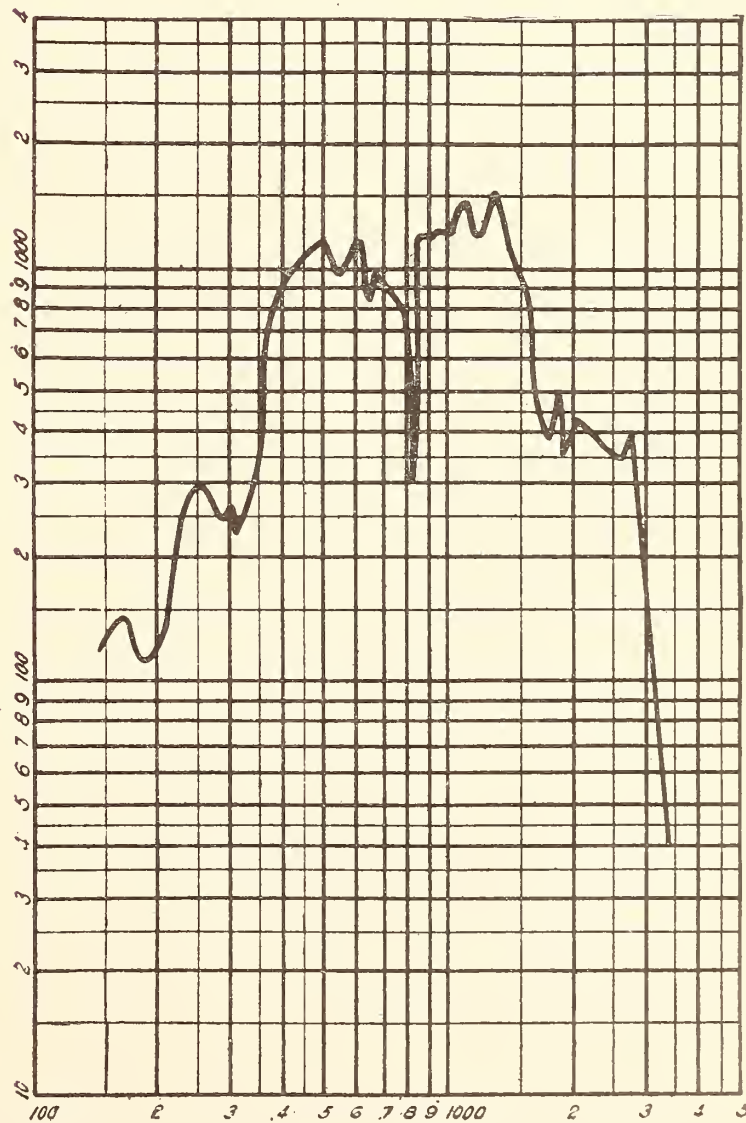

FIG. 16

In this case the armature was not stiff enough and the sound showed a reduction in volume at 800 cycles

# Various Circuits and What They Mean

## PART I

### The Analysis of a Circuit

By ZEH BOUCK

**T**O UNDERSTAND thoroughly and derive the fullest benefit from any article describing a radio installation, it is essential that the reader be perfectly familiar with the symbols to which the author must necessarily resort in his description of a circuit. The interpretation of a diagram should be almost instantaneous. A cursory examination of almost any well-drawn, but unlettered and unannotated diagram, furnishes the experienced experimenter with the following information:

1. The instruments required. It should never be necessary to write to a magazine requesting a list of parts for such-and-such a circuit diagram; the parts are indicated quite plainly on the diagram.
2. The functioning of each instrument, i.e., the whys and wherefores of each coil, condenser, etc.
3. The functioning of the circuit as a whole. That is: is it regenerative? If so, by what system? Capacity feed-back? . . . Inductive feed-back? Through what agency? Tuned plate? . . . Ultra audion? . . . Etc. An understanding of these details furnishes a comprehensive idea as to the possibilities of the receiver, with regard to:
  - A. DX (long-distance) reception
  - B. Wavelength range
  - C. Selectivity
  - D. Loop or open antenna
  - E. Re-radiation

All diagrams to which the writer will have occasion to refer will be briefly analyzed in this fashion, in order that the reader may become accustomed to summing up the total signi-

ficance of a circuit, making the most out of the diagrams he will encounter in the future. *A radio diagram in the majority of cases is a concise but complete article describing a particular transmitting or receiving arrangement, covering constructional details (the theoretical best spacing and relation of parts, with necessary limitations on mounting, etc.) a description of the required parts, how to operate the finished article, what the set will and will not do!*

#### LEARN THE VALUES AND FUNCTIONS OF SYMBOLS

**T**HE knowledge that symbol no. 1 in the accompanying chart means a coil of wire or an inductance, and that symbol no. 2 indicates a variable condenser, is of little use to the broadcast listener when he possesses not the slightest idea of how many turns

of wire the coil should consist nor of the capacity of the condenser. And in many cases these little points of information, vital to the uninformed reader, are omitted, sometimes through ignorance on the part of the writer, but more often because the value is conventional and the writer assumes it to be understood. The chart shows the symbols which the experimenter will most often encounter. First among those to which more or less arbitrary values may be assigned is the fixed condenser. The fixed condenser consists of metallic foil, with the "plates" separated by a non-conductor or dielectric of waxed paper or mica. It is "fixed" because the plates are permanently bound, and the capacity is therefore practically

#### Have You Ever been Stumped by a Diagram?

Many new and interesting circuit diagrams find their way into print. They are the engineer's way of telling you what is necessary for the building of certain apparatus which he has found satisfactory. He is constantly using the symbols shown on the opposite page, and is familiar with what each signifies in any diagram he may come across. It does not take long for any one to learn what instruments each of the symbols represents, and such knowledge is necessary in making clear the function and construction of many radio circuits.

This article is the first of a series by an author who has been actively in the radio game for many years.—THE EDITOR.

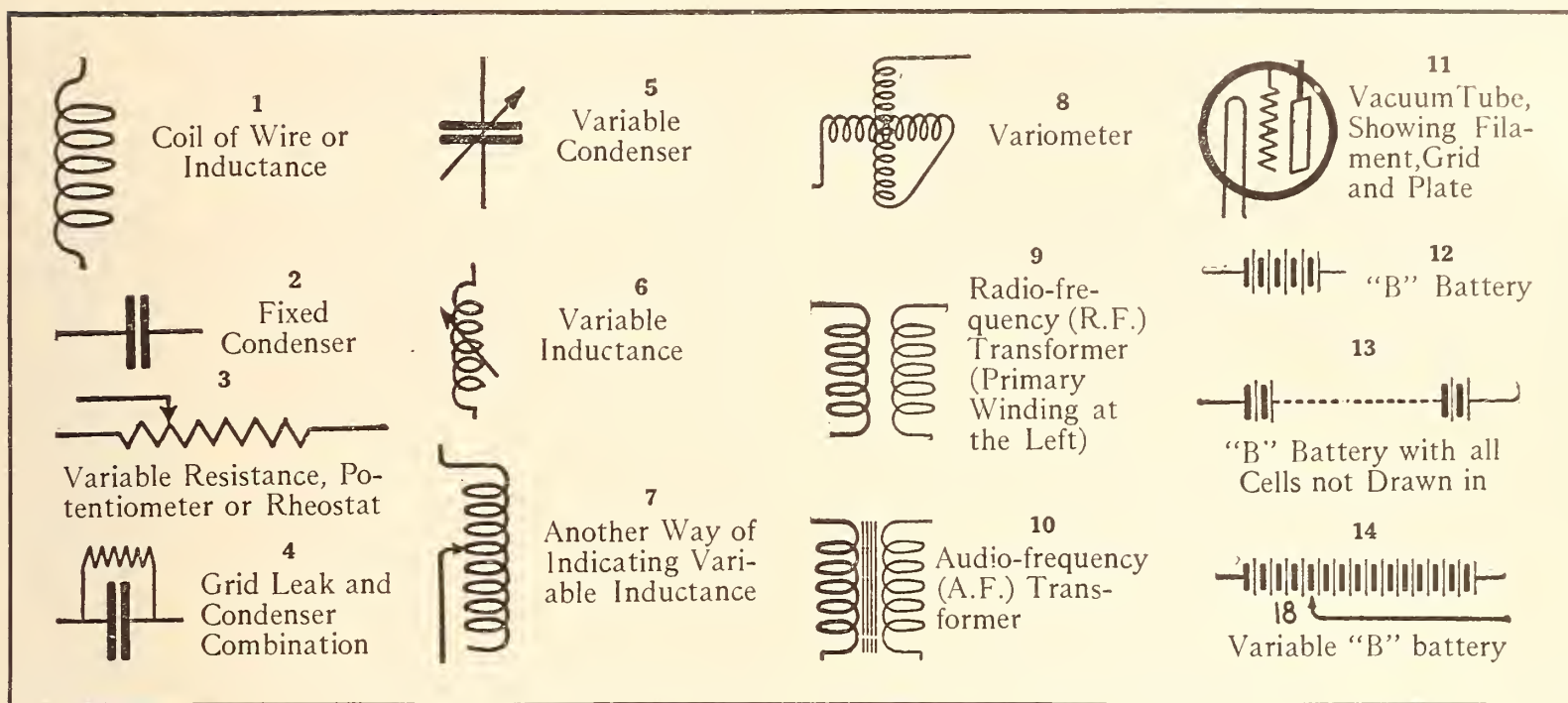

constant. The most common use in radio for a condenser of this type is in series with the grid lead of a detector tube, in which position it is known as the grid condenser, and its capacity is .0005 mfd. *This value, as well as other values indicated in the course of the articles, may be taken as standard and may be used in all circuits excepting those calling for special values which will always be specified.*

In most cases the grid condenser is shunted (connected across) by a resistance (symbol 3 shows a variable resistance) of 2 megohms (2,000,000 ohms) and the combination is known as the grid-leak (symbol 4). (Cf. article, "Making Your Grid-leaks" in the October "R. B. Lab.") The combined function of the leak and condenser is to regulate the charge on the grid, so that the tube is operated at its highest efficiency as a detector.

Fixed condensers are also very often used as "by-pass" or bridging capacities, in which case their function is to pass a radio-frequency current which, without their assistance, would be impeded by various highly inductive coils, such as telephone receivers and the windings of amplifying transformers. These condensers, which average .002 mfd. capacity (the value need only be approximate—.001 to .0025 mfd.), are commonly known as telephone shunt condensers from the manner in which they are most frequently used. They will be found across the primary of the first stage in almost all audio-frequency amplifiers, and they are used extensively in the Grimes and other reflex circuits. While these condensers are easily made, they are very inexpensive and the labor is hardly justified by the saving.

All instruments with which a variation of their values is possible, may be indicated as variable on a diagram in either of two ways: by the addition of an arrow across the ordinary symbol (see symbols 4 and 5 on the chart); or, secondly, by indicating a slider or taps (see symbols 3 and 7). Variability as indicated by the arrow generally represents a continuously variable instrument (not in jumps, by taps or turns) such as a variable condenser or a variometer.

Variable condensers are made in three popular capacities, .00025 (11 plates), .0005 (23 plates) and .001 mfd: (43 plates). The smallest condenser is used wherever a slight additional capacity may be needed, but is principally designed to be used across the primary and secondary windings of radio-frequency amplifying transformers, where the slight tuning which it allows adds greatly to the efficiency of the amplifier. The two larger capacities are used as conventional tuning condensers, in series with the antenna, and in shunt with (i. e., across) the variocoupler primary and secondary. The largest condenser permits greater latitude in tuning, covering a greater wavelength range, but unless it is provided with a vernier adjustment, it is rather critical. Whenever there is doubt concerning the size of a required variable, the medium capacity, .0005 mfd., may be used in almost any designated place or circuit.

Tuning inductances for the transfer of energy from the antenna to the detecting circuit are either single-circuit (auto) or double-circuit transformers. The single-circuit transformer is the common tuning coil, generally with two taps or sliders, though often with one (symbol

7), and it may be any form of inductance—straight coil, lattice-wound, or spider-web. 100 turns of wire on a 3-inch tube will tune up to approximately 700 meters. The enthusiast should bear in mind that, as the lattice-wound and spider-web are more efficient inductances, the number of turns on such coils necessary to reach a wave specified for a straight single-layer coil, will be about four-fifths that required for the single-layer coil. If the experimenter acquires cardboard or hard rubber tubes to use as winding forms, these single inductance can be readily wound in his workshop.

Likewise, inductively coupled tuning may be accomplished through either straight windings (variocoupler), lattice-wound coils or spider-web coils. If the diagram calls for a variocoupler, and you possess a honeycomb mounting and have no coupler handy, use the former; forget the variocoupler and plug in an L35 and an L50 in primary and secondary respectively for broadcast reception. A good variocoupler is quite a proposition to construct and is best purchased.

The tickler coil is an inductance similar to a primary or secondary, and is indicated by the same symbol (symbol 1 in chart). It is placed in series with the phones and B battery, i.e., in the detecting plate circuit, and in inductive relation (close to) the secondary, or tuning coil. It feeds back energy from the plate to the grid circuit, causing regeneration. On broadcast wavelengths, the tickler coil should contain from one quarter to one third more turns of wire than the secondary—the coil to which it feeds back.

The variometer (8) is a variable inductance, and it has been well standardized by several reputable manufacturers. When used in the grid circuit (usually in series with the secondary of a variocoupler) it is merely for the purpose of tuning, a substitute for tapping a larger secondary, or using a shunt variable condenser. When employed to tune the plate circuit (connected in the same place as the tickler coil) it causes and governs regeneration. A set with a variometer thus placed is regenerative. The variometer for a permanent set should be purchased.

Amplifying transformers, both radio-frequency (9) and audio-frequency (10), like variometers, are quite standardized, and any one of the numerous reliable makes will give satisfaction. For audio-frequency amplification, the same type may be used throughout all stages, a change in ratio having, as a rule, little

or no effect. Between three and four turns of wire to one is the usual ratio in audio-frequency transformers. For dependable and satisfactory results, this instrument should generally be purchased.

The vacuum tube is indicated by symbol 11. Sometimes there is no circle around it. The socket is, of course, understood.

A battery is indicated by symbol 12, the polarity generally being shown by plus and minus signs. The short thick lines are conventionally the positive poles (representing the carbon element in the dry cell), and the long, thin lines the negatives (the zinc). In designating a series of high voltages, very often only the terminals are drawn, a dotted line (13) indicating that many cells have been omitted. The voltages of the various, A, B and C batteries are determined by the tube and the purpose (detector, amplifier, or oscillator) for which it is to be used. Filament or A voltages on receiving tubes vary from  $1\frac{1}{2}$  up to 8—from the dry-cell tube to certain power amplifiers. B batteries occasionally exceed one hundred volts, 60 volts being the average for amplifiers, with a tap somewhere between 18 and 22 volts for the detector plate, indicated by a small arrow (14). The positive terminal is connected to the lead from the amplifying plates. The C battery is a potential more frequently omitted than used, and is rarely more than  $4\frac{1}{2}$  volts. It is placed in series with amplifying grids in order to reduce distortion or eliminate howling. The C battery is connected with the *negative* terminal to the *grid*.

The rheostat is simply a variable resistance (see 3). Like the battery, its size is determined by the tube, but excepting the UV-199 (which on a  $4\frac{1}{2}$ -volt battery requires a 30-ohm resistance), the standard 6-ohm rheostat, on the recommended battery, will permit the desired adjustment.

The reader is advised not to memorize the symbols and their accompanying values and functions as he would a name. Things learned without associations are of little practical value, and are difficult to apply. Instead of acquiring these details parrot-like, examine the various hook-ups appearing in this issue of RADIO BROADCAST, analyzing them to the best of your ability according to the manner suggested in our opening paragraphs. Look over your own set, noting how it checks up in practice with its theoretical operation as implied in its circuit diagram.

# R. B.'s Coming Transatlantic Tests

By THE EDITOR

**B**Y COÖPERATING with the best radio stations in England it is hoped that the campaign inaugurated by RADIO BROADCAST to establish radio-telephone communication with England during National Radio Week (Nov. 25th to Dec. 1st) will be successful. Amateur transmission across the Atlantic is a fact, and broadcasting stations here have been heard in England as have English stations been heard here, but two-way phone communication has not been achieved heretofore.

## HOW THE PLAN ORIGINATED

**M**R. F. N. Doubleday, President of Doubleday, Page & Company, is an ardent radio fan and is deeply interested in anything that will stimulate friendship between America and England. He is of the belief that Americans are interested in what Englishmen have to say about international affairs and that the English will find interest in the remarks of representative Americans. With this thought in mind he asked the editor of RADIO BROADCAST if such a thing as international radio-telephony tests could be arranged.

## WHAT IS TO GO ON IN ENGLAND

**T**HROUGH the good offices of Mr. Hugh S. Pocock, Editor of *Wireless World and Radio Review* (England) it was possible to arrange with the British Broadcasting Company to have the tests made. A few important paragraphs from the letter from this company are very illuminating:

You may be aware that in England this company has, through the authority of the Postmaster General, sole control over broadcasting and it is fairly safe to assume that arrangements left in our hands will be carried out.

By November 25th we shall have eight main stations and the following particulars may be pertinent:

Location	Wavelength	Power to aerial	Call Sign	Location	Wavelength	Power to aerial	Call Sign
London	370	1 KW	2 LO	Glasgow	415	1 KW	5 SC
Birmingham	425	$\frac{1}{2}$ KW	5 IT	Aberdeen		1 KW	
Manchester	385	1 KW	2 ZY	Bournemouth		1 KW	
Newcastle	400	1 KW	5 NO	Cardiff	353	1 KW	5 WA

We have means whereby all these can be energized from one microphone in London, and if we were to put in hand tests, I should suggest that in a preliminary test every station should transmit simultaneously for say an hour in order that you on your side should pick up the easiest station. In order that this station should be selected, it is suggested that after the hour is over, each station should transmit in turn giving call sign and location. We on our side, would attempt to receive your signals on alternate days and it might be possible to get two-way working.

From the above list it will be seen that the British stations are well within our receiving range from a standpoint of wavelength. In order to make it easy to pick them up, it will be well for us to listen-in on American stations of approximately the same wavelengths, make a list of dial settings for each station and have some definite plan of action to follow when the tests are made.

## HOW THE TESTS ARE TO BE MADE

**O**UR good friends on the other side of the Atlantic are going to wait up until the small hours of the morning in order that we may hear them. The first transmission will be from England on the night of November 25th at 3 A.M. London time (10 P.M. U. S. Eastern Standard Time.)

On November 26th the transmitting will be done from this end by a group of stations selected by RADIO BROADCAST and the National Association of Broadcasters. Stations in the Eastern, Central, and Western part of the country are to be represented. Transmitting will begin at 10 P.M., Eastern Standard Time, and continue for one hour.

On alternate nights, thereafter, the sending will be done by English and American stations, until the last night—December 1st—when an attempt to establish two-way communication will be made. The details of the last night's program will be announced through the stations in England and America, in order to lend all assistance possible to listeners-in and to allow time enough for the broadcasters themselves to get everything ship-shape.

## AMERICAN STATIONS WHICH WILL TAKE PART

**T**HROUGH the National Association of Broadcasters, we are sure of having stations in Chicago, Davenport, Cincinnati, Boston and Minneapolis. Arrangements with additional stations will be completed in a few days, but too late to include in this announcement. Listen for the announcements over the air. England and America are joining forces in putting these tests across. The coöperation of every amateur and broadcast fan is wanted to help make a success of them. Will you listen-in?



# What Our Readers Write Us



EDITOR,  
RADIO BROADCAST,  
DEAR SIR:

The stunt of making ear cushions out of  $1\frac{3}{4}$ " of old Ford inner tube folded back on itself as per illustration, has given me such genuine satisfaction and

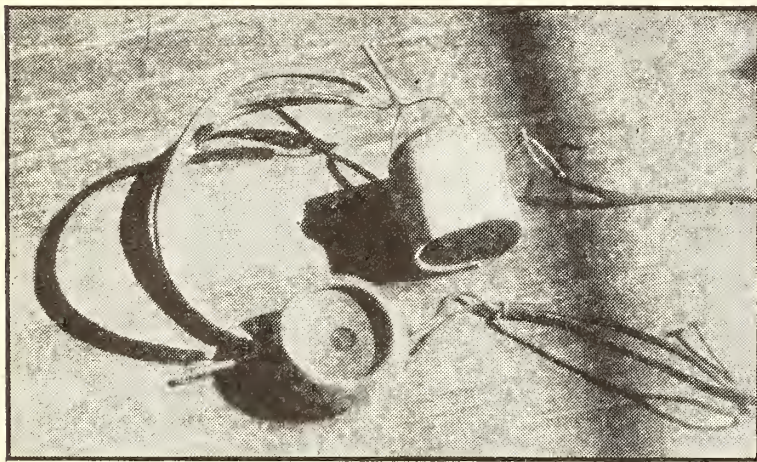

comfort that I thought perhaps you would be interested in publishing the enclosed picture. You are welcome to it.

Very truly yours,  
WM. L. DABNEY,  
A satisfied subscriber.

DEAR EDITOR:

You are aware of the controversy which is rife in the radio world in general, and among our readers in particular, concerning the *polarity* implied by the two composite parts of the symbol designating a battery in radio circuit diagrams. The argument briefly summed up, is as follows:

We are all familiar with the symbol, which consists of long thin lines separated about an eighth of an inch, between which are placed shorter and thicker lines. One short and one long line indicates one cell of a battery, i. e., originally, the two plates or electrodes of one cell. Probably the majority (though it will be difficult to prove this, I think) of printed diagrams in publications, etc., indicate the short lines as negative and the long lines as positive. In many diagrams, however, the reverse is true, the short, thick line being positive and the longer line negative. The question is, which custom is correct? My attention was first called to this matter through my writing an article for RADIO BROADCAST, treating on the symbols, in which I stated that the short line was positive, being unaware of the fact that RADIO BROADCAST has been using the symbols the other way around!

Apparently we are thrown back on our own logic and other resources to determine the arbitrary sign, for the recent report of the committee on the standardization of symbols of the I. R. E., while accepting the usual battery symbol, neither implies nor states definitely which line is plus (positive) and which is minus (negative).

I suggest that RADIO BROADCAST adopt the method advocated by me and as submitted in the original MS of the article mentioned above, i. e., *the short line for positive and the long line for negative*.

In the first place, through association, it is the more easily remembered, the short dark line representing the thick black carbon rod (positive) of a dry cell, and the thin line, the long thin sheet of zinc (negative)! I am convinced that this consideration is what prompted the symbol. Used in this manner, the battery symbol is also more consistent with what a symbol really is, viz; a simplified drawing of a part or instrument, *representing the instrument in question as well as possible!* Thus in the symbol for a vacuum tube, that part of it which most resembles the plate, stands for the plate; that part looking the most like the grid, stands for the grid; and that part most resembling the filament, indicates the filament! A person altogether unfamiliar with radio, having once inspected a tube, and who is then shown the symbol for a vacuum tube, would in most cases be able to identify the parts suggested in the drawing. Then why not follow out the corresponding similitude for the battery or cell?

The immediate suggestion of the dark line for carbon (positive) and the thin line for the sheet of zinc is the reason that most of us receive a first and quite lasting impression that the symbol should be thus interpreted.

The only argument, if such it is, for the other side, is that the long line positive is possibly used by more magazines than the short line positive—a pretty poor argument as far as RADIO BROADCAST is concerned. Would it not be better for RADIO BROADCAST to set the precedent for other publications, rather than to follow theirs merely because their ideas are in the majority?

However, we already have the precedent. Doctor Goldsmith in his "Radio Telephony," uses the short line positive, as does Ballantine in his recent and excellent book, "Radio Telephony for Amateurs."

I know it isn't radio to be consistent and logical but the exception proves the rule—so why not try it?



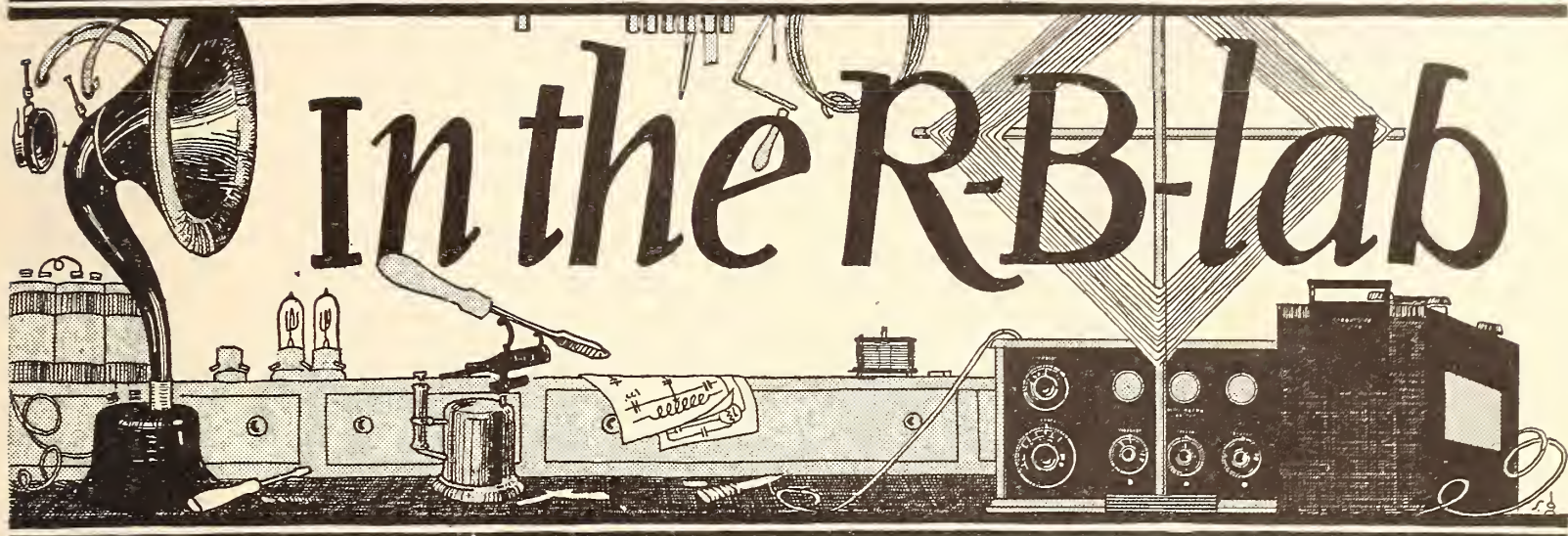

The "Lab" department has been inaugurated by RADIO BROADCAST in order that its readers may benefit from the many experiments which are necessarily carried on by the makers of this magazine in their endeavors to publish only "fact articles" backed by their personal observations.

RADIO BROADCAST will be pleased to buy from its readers, at prices from three to five dollars, any kinks, devices, original ideas, etc., with photographs if possible, which the Editor may consider eligible for this department.

Address all communications to the R. B. Lab Editor.

## WINDING THE TRANSFORMER FOR YOUR BATTERY CHARGER

**I**N THIS department last month the construction of a panel arrangement was described for the remounting of the commercial type of bulb rectifier used for battery charging. The advantages gained by such rebuilding of the manufactured article were higher efficiency (greater charging rate at the same cost), and a neater, more businesslike instrument. For the benefit of those readers who have not commercial chargers, such as the Tungar, which can be rebuilt, the Lab has this month considered the home winding of a suitable transformer for mounting, with tube, socket, and other accessories, on the switchboard described in detail in the preceding issue.

The core is the first consideration in building the transformer, for on the quality of the steel or iron, and the area of its cross section, depends the number of turns of wire. The directions which will follow are for a core constructed of the average grade sheet iron obtainable from a dealer in such metals, cut to such a size, and built up to a thickness that will make a core with a cross section of three square inches. Of course, the best and most convenient plan is to use a core demounted from a discarded transformer. If the reader desiring to construct this rectifier does not possess one, or cannot, for any reason, comply with the directions as we give them, we shall be pleased to

design special windings for his case, if he will communicate with this department, describing the core available (its dimensions and where procured).

Fig. 1 shows how the core selected by the R. B. Lab is built up of an equal number of strips  $7\frac{1}{4}$  by  $1\frac{3}{4}$  inches and  $5\frac{1}{2}$  by  $1\frac{3}{4}$  inches. The core is built up "log cabin fashion," each additional strip being lapped over the joint of the preceding ones, until the core is  $1\frac{3}{4}$  inches high. This will give the specified cross section area, viz.:  $1\frac{3}{4}'' \times 1\frac{3}{4}'' = 3.0625$  square inches.

When the transformer core is built up, the four legs should be taped and the core knocked apart into four bundles of iron. Two opposite legs are given an extra wrapping of tape and selected, one for the primary winding, and one for the two secondaries. Large fiber or pasteboard washers are placed on the sections thus chosen as guides for the wire, making large spindles of the bundles of iron. (If desired, and if the experimenter possesses the facilities, he may wind the primaries and secondaries on forms, slipping the finished windings over the core. This is really the preferred, though more difficult procedure.) Fig. 1 also indicates the placing of the windings.

The primary consists of 495 turns of No. 16 double cotton covered wire, all of which is wound on one leg of the core. The low voltage

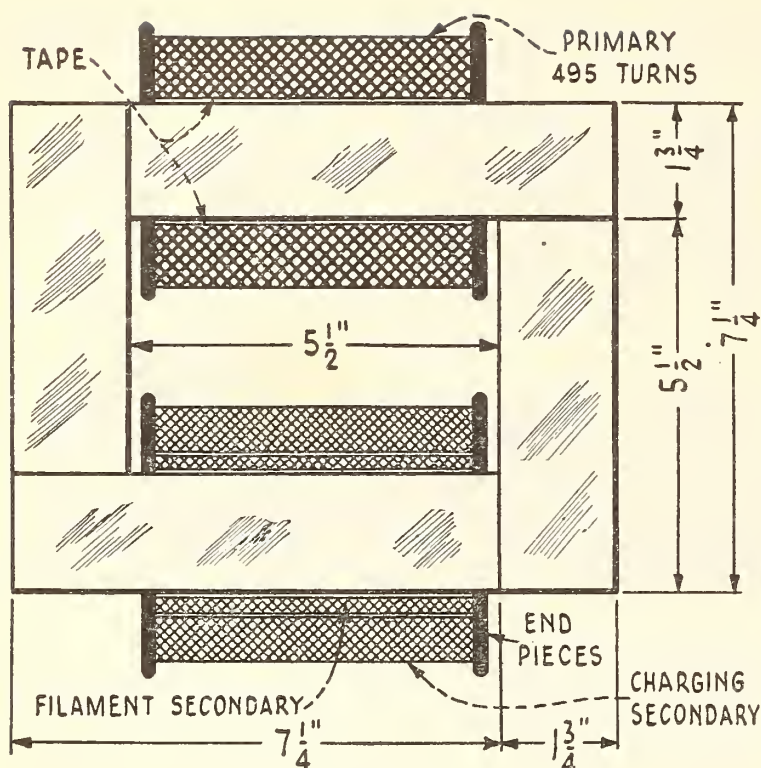

FIG. 1

Showing how the core is built up of iron strips and how the two windings are placed. The primary and secondary windings are shown cut away on the side nearest the observer, so as to show the iron core over which the turns of wire are actually made

or filament lighting secondary is wound on the opposite leg, and consists of 9 turns of number 8 or 9 double cotton covered wire. The high voltage secondary is wound over this (with several layers of taped insulation between) with 180 turns of number 12 double cotton covered wire, tapping at the 146th and the 112th turn. A layer of tape should be placed after every other layer of wire on the primary and high

voltage secondary windings, in order to provide a smooth winding surface for the two following layers. Wind the transformer slowly and neatly.

When the windings are completed, the transformer is fitted together, a rather tedious task but accomplished with perseverance. The intersecting ends are started, and then tapped gently into place with hammer or mallet.

The requirements for this transformer are as follows:

- Core..... 5 lbs. of best core iron obtainable
- Primary: 495 turns No. 16 D. C. C. (3lbs of wire)
- Secondary (filament): 9 turns No. 9 D. C. C. (1/2 lb. wire)
- Secondary (high-voltage): 180 turns No. 12 D. C. C. (3 lbs. of wire)
- tap 146th turn
- tap 112th turn

This transformer is to be mounted as suggested in the rectifier described last month, and the connections for that particular panel are shown in the circuit diagram on this page, Fig. 2. The Tungar bulb with the other instruments indicated in the diagram may be purchased from any well stocked radio supply house.

### BUILDING YOUR OWN LAB

TOOLS are an essential and probably the most important part of the laboratory. Good electrical instruments cannot be constructed or modified without the intelligent use of good tools and implements. A great many (perhaps the majority) of amateur layouts depend altogether too much on the utility of the overburdened jack-knife. RADIO BROADCAST's suggestion for this month's additions to the budding laboratory considers this prevailing deficiency. A set of taps and dies, with wrench and holder (Fig. 3) for working with  $\frac{6}{32}$  and  $\frac{8}{32}$  threads is recommended. The tap-wrench and die-holder (the first is the more important of the two if finances necessitate a choice), along with two taps and two dies, a  $\frac{6}{32}$  (six thirty-two) and  $\frac{8}{32}$  (eight thirty-two) in each, cost about \$2.75, a price that is repaid with interest on almost the first occasion (and it will be an early one!) that the experimenter has to employ them.

The sizes as determined by the numerals 6-32 or 8-32 refer to two things, the first number indicating the diameter of the rod according to the Brown and Sharpe screw gauge (not

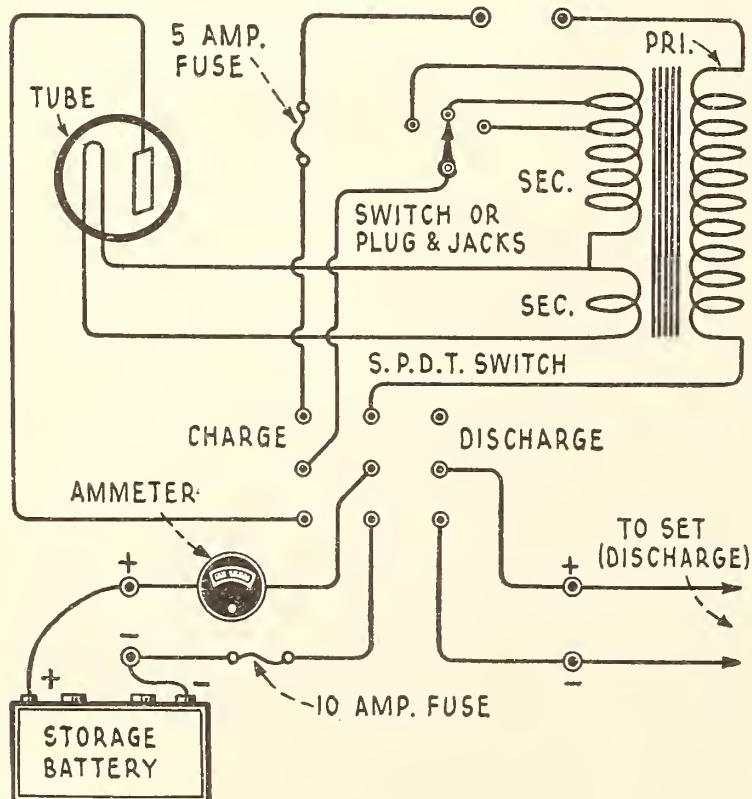

FIG. 2

Diagram showing how to connect the transformer to the bulb and panel apparatus shown in last month's Lab

wire gauge), and the second numeral the number of threads to the inch. Thus a 6-32 is a number six screw with 32 threads to the inch, and an 8-32 is a number eight screw with 32 threads per inch. The smaller the first number (occasionally indicated as the numerator of a fraction, thus  $\frac{6}{32}$ ) the smaller is the diameter of the screw. The  $\frac{6}{32}$  is used mostly for comparatively small work, such as on vacuum tubes sockets, small binding posts, on rheostats, lamp socket connections, etc. The 8-32 is used on larger work, and such screws are found on battery binding-posts, large (and some small) panel binding-posts, and wherever more massive construction is employed.

The taps and tap wrench which holds them are used for threading holes so that they will take a machine screw of the correct size. This eliminates nuts in the thousand and one places where they are either undesirable, unsightly, or next to impossible to place. Holes in panels may be threaded, making it unnecessary to drill all the way through (thus not marring the front), and in any other hard substance into which it is desired to tighten a machine screw. In tapping, the tap should be inserted in the hole gently but firmly, and given a slow but forcible twist until the threads bite, after which it may be turned with less care, but with the same gentle pressure.

Fig. 3 shows the die-holder (resting on the knife) with a die clamped in place. Dies are used for threading rods or bolts to a smaller diameter thread. A long brass rod, completely threaded, makes very convenient shafting for variometers, variocouplers, etc., the rotors of which may be bolted with four nuts to any position on the shaft. A rod (number 20) with an  $\frac{8}{32}$  thread is suggested for this. In threading a rod of a particularly hard material, it is often a good idea to start the rod by filing it to a slight taper at the end offered to the die.

In combination with taps and dies, the following drill sizes should be used in the hand drill described in the October Lab:

No. 18 drill passes an  $\frac{8}{32}$  tap (permits it to go through the hole easily but not loosely). No. 27 passes a  $\frac{6}{32}$ . No. 28 is used for tapping with an  $\frac{8}{32}$  tap. No. 32 is used for tapping with a  $\frac{6}{32}$  tap. A No. 20 rod should be used for threading to an  $\frac{8}{32}$ , and a No. 29 rod for threading to a  $\frac{6}{32}$ . A  $\frac{6}{32}$  nut is easily tapped to an  $\frac{8}{32}$ , and an  $\frac{8}{32}$  rod is easily run through a  $\frac{6}{32}$  die.

The intelligent use of these sizes of taps and dies greatly facilitates the assembling of apparatus and gives a professional finish to the work back of the panel.

FIG. 3

Tap and die tools. A tap is being placed in the tap wrench, with a die-holder and die lying alongside

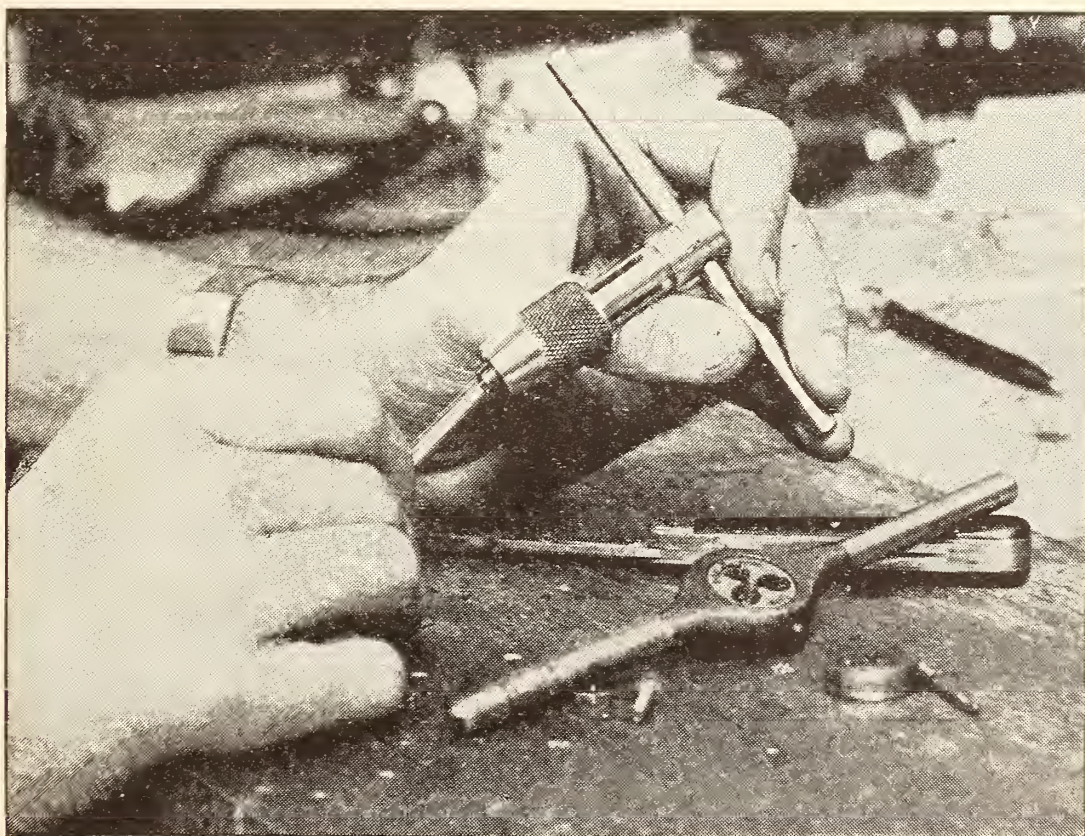

# The Grid

## QUESTIONS AND ANSWERS

### THE CRYSTAL DETECTOR AND THE GRIMES CIRCUIT

Can the Grimes circuit be used with a crystal detector after the manner of a well known commercial reflex set? If so, I should like to see the circuit for the same.

A. J. N., New York City.

Any radio-frequency energy (a definition which includes the current oscillating in a radio receiver before detection) may be detected by means of a crystal, audion or another of the numerous forms of detection. It is only necessary

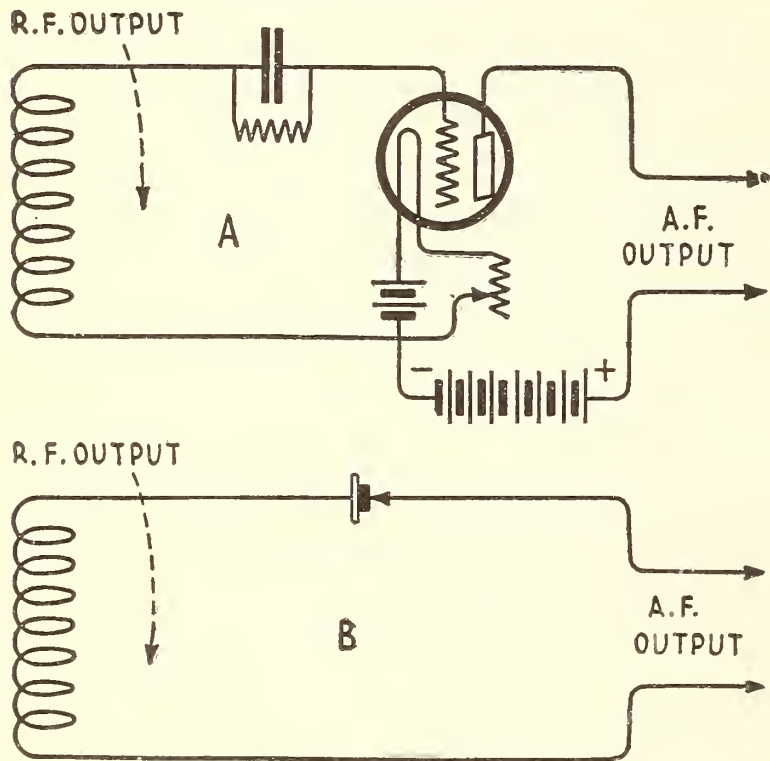

FIG. 1

The fundamental circuits for bulb and crystal detection

to become familiar with the fundamental circuits, or the principles involved, and crystal or audion detection, about the only forms encountered in our present day radio, may be applied to any tuning system with which you may be experimenting.

Fig. 1 indicates, in A and B respectively, the fundamental circuits for bulb and crystal detection. The coil of wire is the immediate source of radio frequency energy which is supplied to the detectors through the leads which are designated as the radio frequency output. This coil may be a simple tuning coil, the secondary of a variocoupler or the secondary of a radio frequency amplifying transformer. The audio frequency output, is the output of the detecting circuit—the result of detection.

Detection is accomplished in the bulb circuit by connecting one side of the R. F. output to the grid of the tube through a grid condenser and leak, and the other side to the filament. The audio frequency output may be taken from any place in the plate circuit, generally between the B battery and the plate.

In the case of the crystal detector, detection is achieved by connecting the crystal in series with the coil, the audio output being taken anywhere along the connection.

It is generally a good idea to place a .001 mfd. fixed condenser across the output of the detector circuit.

These two circuits, A and B, accomplish the same thing (the bulb perhaps in a more satisfactory manner, according to circumstances), and they are, therefore, quite interchangeable. Fig. 2 shows the Grimes circuit with a crystal substituted for the third or detecting tube.

The crystal is capable of distance reception in the reflex circuit due to the radio-frequency amplification which compensates for the lack of sensitivity in the crystal. It is also free from the complications which attend bulb detection in this circuit, and which result in lack of stability and in howling.

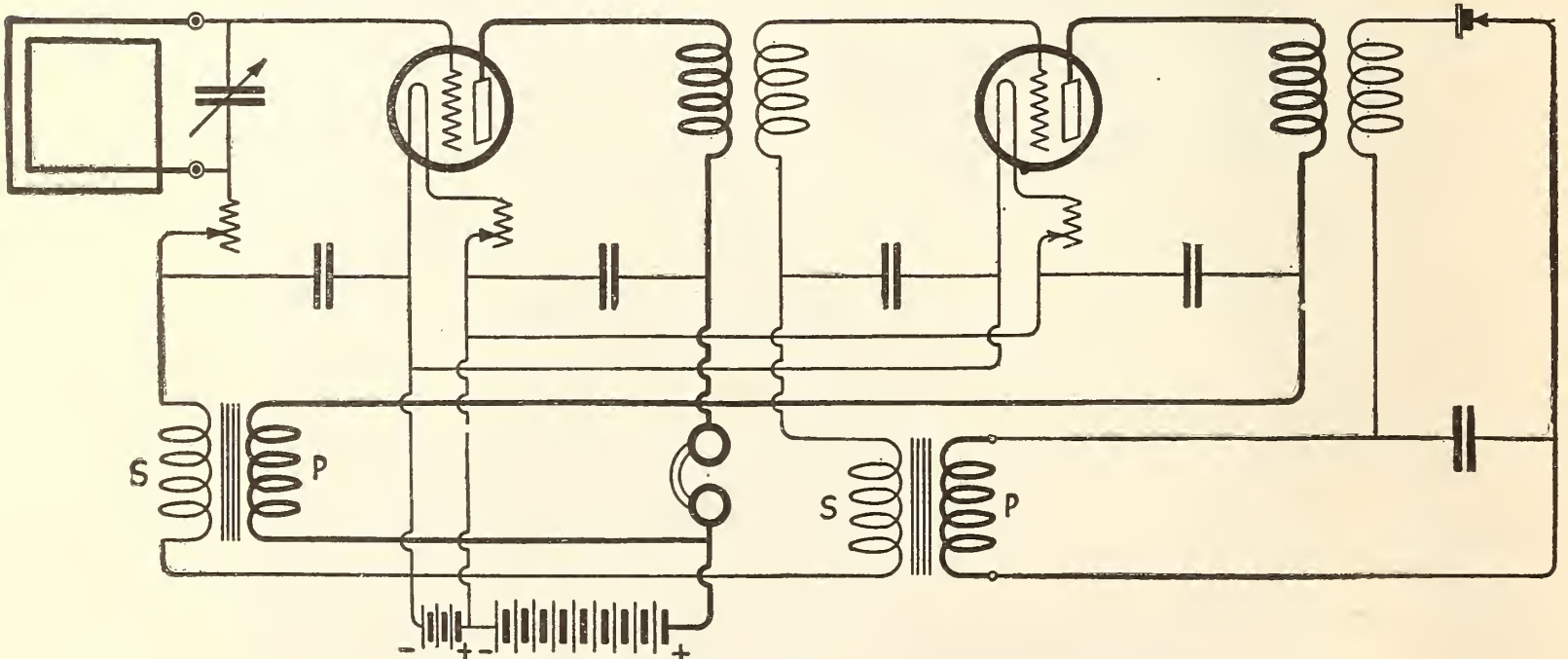

FIG. 2

The Grimes circuit with crystal detector. (For original Grimes circuit see RADIO BROADCAST for April, 1923; pp. 476)

# Will your battery stay for the concert?

**T**HERE is nothing more exasperating than a battery that "signs off" just when you are enjoying a splendid radio concert.

A good A battery should supply uniform filament current during a long period of discharge. Frequent recharging and replacements take all the fun out of radio receiving.

When you hook up your set to an Exide A Battery you'll appreciate what ungrudging battery service means. You'll be impressed time and again with the value of its ample capacity-rating and the smooth, unvarying flow of current that it delivers to your tubes.

## Features you will appreciate

From its heavy, well-made plates to its convenient terminal binding posts, every detail of the Exide's construction is designed to help you get better reception. Vent plugs that may be inserted or removed by a single twist of the wrist

make it an easy matter to add water or test the battery. A deep sediment space in the bottom of each cell eliminates danger of internal short circuits or reduced life. Wood separators of the same fine quality that are

found in the Exide automobile batteries insulate the plates from one another and also contribute to the battery's long life. A stout detachable handle across the top of the battery makes it extremely easy to carry.

Two low-voltage A batteries

The Exide line has been extended to include

**THE ELECTRIC STORAGE BATTERY COMPANY, PHILADELPHIA**

Oldest and largest manufacturers in the world of storage batteries for every purpose

Service Stations Everywhere

two low-voltage A batteries, consisting of one and two cells. They are designed specifically for WD-11 and UV-199 vacuum tubes, and are right in line with recent developments in radio receiving.

The two-volt Exide A Battery will heat the filament of a quarter-ampere tube for approximately 96 hours. The

four-volt Exide A Battery will heat the filament of a 60 milli-ampere tube for 200 hours.

## Exide B Battery

Current from the new Exide B Battery is full-powered and noiseless. It is free from fluctuations that cause hissing and crackling sounds in your phones. When you tune in distant stations you know that your satisfaction will not be marred by imitation static that sounds as though a heavy electrical storm were in progress.

You don't have to put up with a battery that discharges quickly. Go to any radio dealer or Exide Service Station and ask for Exide A and B Batteries.

If your dealer cannot supply you with free booklets describing the complete Exide line of radio batteries, write to us.

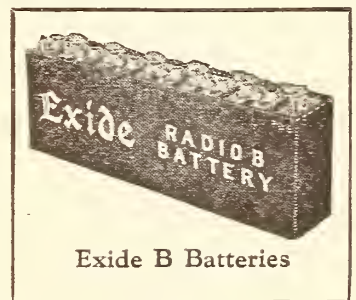
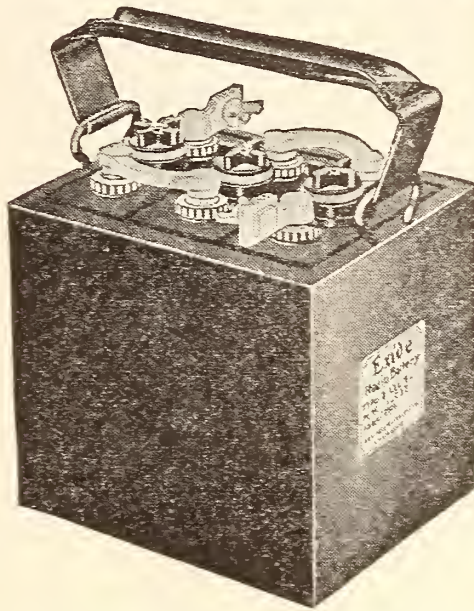

Exide B Batteries

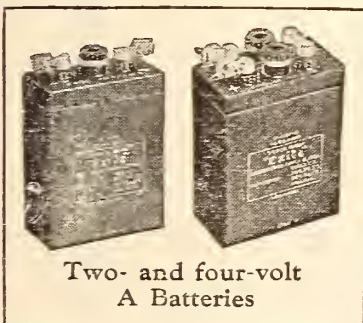

Two- and four-volt A Batteries

# Exide

## RADIO BATTERIES

CALL LETTERS	LOCATION	(KILO-CYCLES)	WAVE LENGTH	POWER (WATTS)	CALL LETTERS	LOCATION	(KILO-CYCLES)	WAVE LENGTH	POWER (WATTS)
KQI	Berkeley, Calif.	833	360	500	WDAP	Chicago, Ill.	833	360	500
KQP	Hood River, Oreg.	833	360	10	WDAR	Philadelphia, Pa.	760	395	500
KQV	Pittsburgh, Pa.	833	360	500	WDAS	Worcester, Mass.	833	360	5
KQW	San Jose, Calif.	833	360	50	WDAU	New Bedford, Mass.	833	360	100
KRE	Berkeley, Calif.	1080	278	50	WDAX	Centerville, Iowa	833	360	100
KSD	St. Louis, Mo.	550	546	500	WDAY	Fargo, N. Dak.	1230	244	50
KSS	Long Beach, Calif.	833	360	20	WDBC	Lancaster, Pa.	1160	258	50
KTW	Seattle, Wash.	833	360	250	WDBF	Youngstown, Ohio	1150	261	50
KUO	San Francisco, Calif.	833	360	150	WDM	Washington, D. C.	833	360	50
KUS	Los Angeles, Calif.	833	360	100	WDT	Stapleton, N. Y.	740	405	500
KUY	El Monte, Calif.	833	360	50	WDZ	Tuscola, Ill.	1080	278	350
KWG	Stockton, Calif.	833	360	100	WEAA	Flint, Mich.	1070	280	150
KWH	Los Angeles, Calif.	833	360	500	WEAB	Fort Dodge, Iowa	833	360	100
KXD	Modesto, Calif.	833	360	5	WEAF	New York, N. Y.	610	492	500
KYQ	Honolulu, Hawaii	833	360	40	WEAG	Edgewood, R. I.	1300	231	10
KYW	Chicago, Ill.	870	345	500	WEAH	Wichita, Kans.	833	360	100
KZM	Oakland, Calif.	833	360	50	WEAI	Ithaca, N. Y.	1050	286	500
KZN	Salt Lake City, Utah	833	360	500	WEAJ	Vermilion, S. Dak.	833	360	200
KZV	Wenatchee, Wash.	833	360	50	WEAK	St. Joseph, Mo.	833	360	15
WAAB	New Orleans, La.	1120	268	100	WEAM	North Plainfield, N. J.	1190	250	100
WAAC	New Orleans, La.	833	360	400	WEAN	Providence, R. I.	1100	273	15
WAAD	Cincinnati, Ohio	833	360	25	WEAO	Columbus, Ohio	833	360	500
WAAF	Chicago, Ill.	833	360	200	WEAP	Mobile, Ala.	833	360	100
WAAH	St. Paul, Minn.	833	360	100	WEAR	Baltimore, Md.	833	360	50
WAAK	Milwaukee, Wis.	1070	280	100	WEAS	Washington, D. C.	833	360	100
WAAM	Newark, N. J.	1140	263	250	WEAU	Sioux City, Iowa	833	360	100
WAAN	Columbia, Mo.	1180	254	50	WEAY	Houston, Tex.	833	360	1000
WAAP	Wichita, Kans.	833	360	150	WEB	St. Louis, Mo.	833	360	500
WAAW	Omaha, Nebr.	833	360	200	WEV	Houston, Tex.	833	360	250
WAAZ	Emporia, Kans.	833	360	100	WEW	St. Louis, Mo.	1150	261	100
WABB	Harrisburg, Pa.	1130	266	10	WFAA	Dallas, Tex.	630	476	500
WABC	Anderson, Ind.	1310	229	10	WFAB	Syracuse, N. Y.	1280	234	200
WABD	Dayton, Ohio	1060	283	10	WFAF	Poughkeepsie, N. Y.	833	360	20
WABE	Washington, D. C.	1060	283	50	WFAH	Port Arthur, Tex.	833	360	150
WABF	Mount Vernon, Ill.	1280	234	250	WFAJ	Asheville, N. C.	833	360	100
WABG	Jacksonville, Fla.	1210	248	10	WFAM	St. Cloud, Minn.	833	360	20
WABH	Sandusky, Ohio	1250	240	100	WFAN	Hutchinson, Minn.	833	360	100
WABI	Bangor, Me.	1250	240	50	WFAQ	Cameron, Mo.	833	360	10
WABJ	South Bend, Ind.	1250	240	10	WFAT	Sioux Falls, S. Dak.	833	360	100
WABK	Worcester, Mass.	1190	252	10	WFAV	Lincoln, Nebr.	833	360	100
WABL	Storrs, Conn.	1060	283	100	WFI	Philadelphia, Pa.	760	395	500
WABM	Saginaw, Mich.	1180	254	100	WFGAL	Lancaster, Pa.	1210	248	10
WABN	La Crosse, Wis.	1280	234	100	WGAN	Pensacola, Fla.	833	360	50
WABO	Rochester, N. Y.	1190	252	20	WGAQ	Shreveport, La.	833	360	150
WBAA	West Lafayette, Ind.	833	360	250	WGAR	Fort Smith, Ark.	833	360	20
WBAD	Minneapolis, Minn.	833	360	100	WGAU	Wooster, Ohio	1330	226	20
WBAF	Moorestown, N. J.	833	360	100	WGAW	Altoona, Pa.	1150	261	100
WBAH	Minneapolis, Minn.	833	360	500	WGAY	Madison, Wis.	833	360	100
WBAN	Paterson, N. J.	1230	244	100	WGAZ	South Bend, Ind.	833	360	100
WBAO	Decatur, Ill.	833	360	50	WGF	Des Moines, Iowa	833	360	250
WBAP	Fort Worth, Tex.	630	476	500	WGI	Medford Hillside, Mass.	833	360	500
WBAU	Hamilton, Ohio	1160	258	50	WGL	Philadelphia, Pa.	833	360	250
WBAV	Columbus, Ohio	770	390	500	WGR	Buffalo, N. Y.	833	360	250
WBAW	Marietta, Ohio	1220	246	100	WGV	New Orleans, La.	833	360	100
WBAZ	Wilkes-Barre, Pa.	833	360	20	WGY	Schenectady, N. Y.	790	380	1000
WBAY	New York, N. Y.	610	492	500	WHA	Madison, Wis.	833	360	800
WBBA	Newark, Ohio	1250	240	20	WHAA	Iowa City, Iowa	1060	283	100
WBBC	Sterling, Ill.	1310	229	50	WHAB	Galveston, Tex.	833	360	200
WBBD	Reading, Pa.	1280	234	50	WHAC	Waterloo, Iowa	833	360	20
WBL	Anthony, Kans.	1150	261	100	WHAD	Milwaukee, Wis.	1070	280	100
WBS	Newark, N. J.	833	360	20	WHAG	Cincinnati, Ohio	1350	222	100
WBT	Charlotte, N. C.	833	360	500	WHAH	Joplin, Mo.	833	360	550
WBU	Chicago, Ill.	1050	286	500	WHAI	Davenport, Iowa	833	360	50
WBZ	Springfield, Mass.	890	337	750	WHAK	Clarksburg, W. Va.	833	360	15
WCAD	Canton, N. Y.	1070	280	50	WHAL	Lansing, Mich.	1210	248	20
WCAE	Pittsburgh, Pa.	650	462	500	WHAM	Rochester, N. Y.	833	360	100
WCAG	New Orleans, La.	1120	268	50	WHAO	Savannah, Ga.	833	360	100
WCAH	Columbus, Ohio	1050	286	250	WHAP	Decatur, Ill.	833	360	10
WCAJ	University Place, Nebr.	833	360	500	WHAQ	Washington, D. C.	833	360	10
WCAK	Houston, Tex.	833	360	50	WHAR	Atlantic City, N. J.	1300	231	15
WCAL	Northfield, Minn.	833	360	250	WHAS	Louisville, Ky.	750	400	500
WCAM	Villanova, Pa.	833	360	150	WHAV	Wilmington, Del.	833	360	50
WCAO	Baltimore, Md.	833	360	50	WHAY	Huntington, Ind.	833	360	10
WCAP	Washington, D. C.	640	469	500	WHAZ	Troy, N. Y.	790	380	500
WCAR	San Antonio, Tex.	833	360	100	WHB	Kansas City, Mo.	730	411	500
WCAS	Minneapolis, Minn.	833	360	100	WHD	Morgantown, W. Va.	833	360	250
WCAT	Rapid City, S. Dak.	1250	240	100	WHK	Cleveland, Ohio	833	360	100
WCAU	Philadelphia, Pa.	1050	286	100	WHN	Ridgewood, N. Y.	833	360	100
WCAV	Little Rock, Ark.	833	360	20	WIAB	Rockford, Ill.	190	252	50
WCAX	Burlington, Vt.	833	360	50	WIAC	Galveston, Tex.	833	360	100
WCAY	Milwaukee, Wis.	1150	261	500	WIAD	Ocean City, N. J.	1180	254	10
WCBA	Allentown, Pa.	1070	280	5	WIAF	New Orleans, La.	1280	234	10
WCBB	Greenville, Ohio	1250	240	100	WIAH	Newton, Iowa	833	360	5
WCBD	Zion, Ill.	870	345	500	WIAI	Springfield, Mo.	833	360	20
WCE	Minneapolis, Minn.	833	360	250	WIAJ	Neenah, Wis.	1340	224	20
WCK	St. Louis, Mo.	833	360	100	WIAK	Omaha, Nebr.	1080	278	200
WCM	Austin, Tex.	833	360	500	WIAO	Milwaukee, Wis.	833	360	100
WCN	Worcester, Mass.	833	360	600	WIAQ	Marion, Ind.	833	360	10
WCX	Detroit, Mich.	580	517	500	WIAR	Paducah, Ky.	833	360	100
WDAD	Lindsborg, Kans.	833	360	10	WIAS	Burlington, Iowa	833	360	100
WDAE	Tampa, Fla.	833	360	250	WIAT	Tarkio, Mo.	833	360	15
WDAF	Kansas City, Mo.	730	411	500	WIAU	Le Mars, Iowa	833	360	20
WDAG	Amarillo, Tex.	833	360	100	WIAY	Washington, D. C.	833	360	100
WDAH	El Paso, Tex.	833	360	200	WIK	McKeesport, Pa.	833	360	250
WDAI	Syracuse, N. Y.	1220	246	100	WIL	Washington, D. C.	833	360	10
WDAJ	College Park, Ga.	833	360	500	WIP	Philadelphia, Pa.	590	509	500
WDAK	Hartford, Conn.	1150	261	100	WJAB	Lincoln, Nebr.	833	360	500
WDAL	Jacksonville, Fla.	833	360	100	WJAD	Waco, Tex.	833	360	150
WDAO	Dallas, Tex.	833	360	50	WJAF	Muncie, Ind.	833	360	10



## SIGNALING

CONSIDER the vast difference between the methods of the savage and the marvellous broadcasting of to-day. This difference can be stated in one word—instruments.

Modern broadcasting employs delicate instruments to transform messages into electricity. Satisfactory reception requires equally fine apparatus to translate this current into the original music or spoken word.

Upon your loud speaker or head phones falls the task of transforming the electric current that flows through your set into sound. Poorly designed or carelessly constructed instruments cannot do this with satisfaction to you.

Holtzer-Cabot Phones and Loud Speakers are the perfect results of 25 years' specialization in the manufacture of sensitive electric apparatus.

<b>Holtzer-Cabot Loud Speaker,</b>	<b>\$25.00</b>
<b>No. 2 Universal Head Phones,</b>	<b>9.50</b>
<b>No. 4 National Head Phones,</b>	<b>6.00</b>

*Write for booklets "What you should know about Radio Reception" and "A better Loud Speaker."*

**THE HOLTZER-CABOT ELECTRIC CO.**

125 Amory Street, **Boston, Mass.**  
6161-65 South State Street, **Chicago, Ill.**  
Department A

*Holtzer-Cabot*  
BUSINESS ESTABLISHED 1875

**HEAD SETS**



★ Tested and approved by RADIO BROADCAST ★

CALL LETTERS	LOCATION	(KILO-CYCLES)	WAVE LENGTH	POWER (WATTS)	CALL LETTERS	LOCATION	(KILO-CYCLES)	WAVE LENGTH	POWER (WATTS)
WJAG	Norfolk, Nebr.	833	360	100	WOAX	Trenton, N. J.	1250	240	200
WJAM	Cedar Rapids, Iowa	833	360	20	WOAZ	Stamford, Tex.	833	360	100
WJAN	Peoria, Ill.	1070	280	100	WOC	Davenport, Iowa	620	484	500
WJAR	Topeka, Kans.	833	360	50	WOE	Akron, Ohio	833	360	40
WJAS	Providence, R. I.	833	360	50	WOI	Ames, Iowa	833	360	100
WJAT	Pittsburgh, Pa.	833	360	500	WOK	Pine Bluff, Ark.	833	360	500
WJAX	Marshall, Mo.	833	360	20	WOO	Philadelphia, Pa.	590	509	500
WJAZ	Cleveland, Ohio	770	390	500	WOQ	Kansas City, Mo.	833	360	500
WJD	Chicago, Ill.	670	448	20	WOR	Newark, N. J.	740	405	500
WJH	Granville, Ohio	1310	229	50	WOS	Jefferson, City, Mo.	833	360	500
WJX	Washington, D. C.	1140	263	50	WPAB	State College, Pa.	833	360	500
WJY	New York, N. Y.	833	360	500	WPAC	Okmulgee, Okla.	833	360	200
WJZ	New York, N. Y.	740	405	500	WPAD	Chicago, Ill.	833	360	500
WKAA	New York, N. Y.	660	455	500	WPAF	Council Bluffs, Iowa	833	360	10
WKAC	Cedar Rapids, Iowa	833	360	100	WPAH	Waupaca, Wis.	833	360	250
WKAD	Lincoln, Nebr.	1090	275	100	WPAJ	New Haven, Conn.	1120	268	30
WKAF	East Providence, R. I.	833	360	10	WPAK	Agricultural College, N. Dak.	833	360	250
WKAN	Wichita Falls, Tex.	833	360	100	WPAL	Columbus, Ohio	1050	286	100
WKAP	Montgomery, Ala.	1330	226	20	WPAM	Topeka, Kans.	833	360	100
WKAQ	Cranston, R. I.	833	360	200	WPAP	Winchester, Ky.	833	360	35
WKAR	San Juan, P. R.	833	360	100	WPAQ	Frostburg, Md.	833	360	10
WKAS	East Lansing, Mich.	1070	280	100	WPAR	Beloit, Kans.	833	360	10
WKAU	Springfield, Mo.	833	360	10	WPAT	El Paso, Tex.	833	360	20
WKAZ	Laconia, N. H.	833	360	50	WPAU	Moorhead, Minn.	833	360	20
WKAW	Beloit, Wis.	1240	242	10	WPAW	Wilmington, Del.	833	360	10
WKAX	Bridgeport, Conn.	1300	231	15	WPAY	Bangor, Me.	833	360	20
WKAY	Gainesville, Ga.	833	360	20	WPAZ	Charleston, W. Va.	1100	273	20
WKD	Baltimore, Md.	833	360	20	WPG	New Lebanon, Ohio	833	360	30
WKDZ	Oklahoma, Okla.	833	360	100	WQAA	Parkersburg, Pa.	833	360	500
WKE	Raleigh, N. C.	833	360	750	WQAB	Springfield, Mo.	1270	236	10
WKEB	Minneapolis, Minn.	720	417	500	WQAC	Amarillo, Tex.	833	360	100
WKEC	Syracuse, N. Y.	1280	234	250	WQAD	Waterbury, Conn.	1240	242	50
WKEF	Waco, Tex.	833	360	50	WQAE	Springfield, Vt.	1090	275	150
WKEG	Bellows Falls, Vt.	833	360	500	WQAF	Sandusky, Ohio	1250	240	5
WKEH	Tulsa, Okla.	833	360	100	WQAH	Lexington, Ky.	1180	254	10
WKEI	Houlton, Me.	833	360	100	WQAL	Mattoon, Ill.	1160	258	20
WKEJ	Louisville, Ky.	833	360	15	WQAM	Miami, Fla.	833	360	100
WKEK	Kalamazoo, Mich.	833	360	20	WQAN	Scranton, Pa.	1070	280	250
WKEP	Burlington, Iowa	833	360	10	WQAO	New York, N. Y.	833	360	100
WKEQ	Pensacola, Fla.	833	360	20	WQAQ	Abilene, Tex.	833	360	100
WKEW	New York, N. Y.	833	360	500	WQAS	Lowell, Mass.	1130	266	10
WKEZ	Greencastle, Ind.	1300	231	5	WQAV	Greenville, S. C.	1160	258	15
WKFA	Warren, Ohio	1210	248	20	WQAW	Washington, D. C.	1270	236	5
WKFB	Minneapolis, Minn.	833	360	100	WQAX	Peoria, Ill.	833	360	20
WKFC	Cincinnati, Ohio	970	309	500	WQAY	Hastings, Nebr.	833	360	20
WKFD	Oklahoma, Okla.	833	360	100	WQAZ	Greensboro, N. C.	833	360	30
WKFE	Cazenovia, N. Y.	1150	261	100	WRAA	Houston, Tex.	833	360	200
WKFG	Dartmouth, Mass.	833	360	500	WRAB	Savannah, Ga.	833	360	100
WKFH	Lincoln, Nebr.	1180	254	15	WRAD	Marion, Kans.	833	360	10
WKFI	Kansas City, Mo.	1090	275	250	WRAP	Laporte, Ind.	1340	224	10
WKFL	Lockport, N. Y.	833	360	500	WRAS	Providence, R. I.	833	360	10
WKFM	Trenton, N. J.	1170	256	15	WRAU	St. Croix Falls, Wis.	1210	248	100
WKFN	Beaumont, Tex.	833	360	100	WRAV	St. Louis, Mo.	833	360	20
WKFO	Columbus, Ohio	1050	286	20	WRAW	Winter Park, Fla.	833	360	20
WKFP	Easton, Pa.	1220	246	250	WRAX	David City, Nebr.	1330	226	20
WKFQ	Chicago, Ill.	670	448	500	WRAY	McLeansboro, Ill.	833	360	10
WKFR	Duluth, Minn.	1130	266	250	WRB	Amarillo, Tex.	833	360	10
WKFS	Auburn, Ala.	1200	250	250	WRB	Yellow Springs, Ohio	833	360	100
WKFT	St. Louis, Mo.	833	360	100	WRB	Reading, Pa.	1260	238	10
WKFA	Macon, Ga.	1120	268	50	WRB	Gloucester, City, N. J.	1120	268	50
WKFB	Memphis, Tenn.	600	500	500	WRB	Scranton, Pa.	833	360	50
WKFC	Cincinnati, Ohio	1210	248	10	WRB	Newark, N. J.	1290	233	50
WKFD	Washington, D. C.	1150	261	100	WRB	Washington, D. C.	640	469	50
WKFE	Boston, Mass.	833	360	100	WRB	Hamilton, Ohio	833	360	50
WKFG	Norman, Okla.	833	360	100	WRB	Schenectady, N. Y.	833	360	500
WKFH	Omaha, Nebr.	833	360	50	WRB	Urbana, Ill.	833	360	500
WKFI	Evansville, Ind.	833	360	500	WRB	Dallas, Tex.	833	360	20
WKFL	Syracuse, N. Y.	1050	286	100	WRB	Tarrytown, N. Y.	1100	273	150
WKFM	Springfield, Ohio	833	360	100	WRB	Cape Girardeau, Mo.	833	360	100
WKFN	Charleston, S. C.	833	360	20	WRB	Clemson College, S. C.	833	360	500
WKFO	Butler, Mo.	833	360	10	WRB	Providence, R. I.	1150	261	50
WKFP	Austin, Tex.	833	360	100	WRB	St. Petersburg, Fla.	1230	244	10
WKFQ	Philadelphia, Pa.	833	360	250	WRB	Chicago, Ill.	1210	248	500
WKFR	Knoxville, Tenn.	833	360	500	WRB	Cincinnati, Ohio	970	309	500
WKFS	Fort Monroe, Va.	833	360	5	WRB	Grove City, Pa.	833	360	100
WKFT	Yankton, S. Dak.	1230	244	50	WRB	Middleport, Ohio	1160	258	70
WKFU	Baltimore, Md.	833	360	10	WRB	Brookville, Ind.	1220	246	20
WKFV	Baltimore, Md.	833	360	10	WRB	Allentown, Pa.	1310	229	10
WKFY	Albany, N. Y.	833	360	55	WRB	New York, N. Y.	833	360	250
WKFZ	Ardmore, Okla.	833	360	20	WRB	Fall River, Mass.	1180	254	10
WKGA	Grand Forks, N. Dak.	833	360	5	WRB	Plainview, Tex.	1120	268	20
WKGB	Lima, Ohio	1130	266	100	WRB	Chesham, N. H.	1310	229	10
WKGC	Sigourney, Iowa	833	360	10	WRB	Canandaigua, N. Y.	1090	275	100
WKGD	Fremont, Nebr.	833	360	20	WRB	Atlanta, Ga.	700	429	500
WKGE	Tyler, Tex.	833	360	100	WRB	Utica, N. Y.	1100	273	100
WKGF	Belvidere, Ill.	1340	224	20	WRB	Birmingham, Ala.	833	360	500
WKGH	Charleston, S. C.	833	360	100	WRB	Fall River, Mass.	1210	248	10
WKGI	San Antonio, Tex.	780	385	500	WRB	Johnstown, Pa.	833	360	150
WKGJ	Parsons, Kans.	1160	258	15	WRB	New Orleans, La.	1240	242	20
WKGK	Frankfort, Ky.	1250	240	20	WRB	Providence, R. I.	1160	258	10
WKGL	Webster Groves, Mo.	833	360	500	WRB	Belvidere, Ill.	1270	236	10
WKGM	Lawrenceburg, Tenn.	833	360	150	WRB	Portland, Me.	1270	236	50
WKGN	Mishawaka, Ind.	833	360	50	WRB	Steubenville, Ohio	1130	266	20
WKGO	Kalamazoo, Mich.	833	360	50	WRB	Elgin, Ill.	1090	275	500
WKGP	Portsmouth, Va.	833	360	15	WRB	Tecumseh, Nebr.	833	360	10
WKGQ	Kenosha, Wis.	833	360	50	WRB	College Station, Tex.	1180	254	50
WKGR	Middletown, Conn.	833	360	50	WRB	Manhattan, Kans.	618	485	1000
WKGS	Middletown, Conn.	833	360	50					
WKGT	Wilmington, Del.	833	360	50					
WKGU	Erie, Pa.	1240	242	200					
WKGV	Omaha, Nebr.	570	526	500					



# Pacent Plug and Jack Devices for ★ Every Radio Requirement

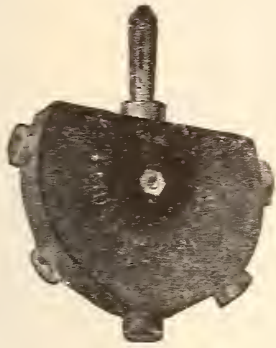









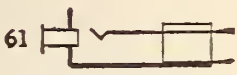

## PACENT MULTIADAPTER

Provides one to five plug connections. Catalogue No. 54. Price \$1.50



## PACENT JACKS

*A Quality Jack for Every Circuit.*

- 61  Single Open Circuit Jack. Price 60c
- 62  Single Closed Circuit Jack. Price 70c
- 63  Double Circuit Jack. Price 80c
- 64  Heavy duty (Loop) Jack. Price \$1.00
- 65  Three Spring Automatic Jack. Price 85c
- 66  Five Spring Automatic Jack. Price \$1.00
- 67  Seven Spring Automatic Jack. Price \$1.00
- 68  Four Spring Automatic Triple Circuit Jack. Price \$1.00
- 69  Five Spring Special Automatic Jack. Price \$1.00
- 70  Six Spring Automatic Jack. Price \$1.00

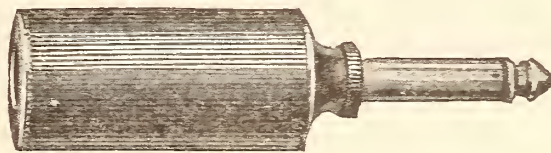

## PACENT DUOPLUG

A quality plug for most particular radio users. Accommodates two pairs of phones. Special toggle feature insures positive contact. All types terminals. No tools required. Catalogue No. 100. Price \$1.00

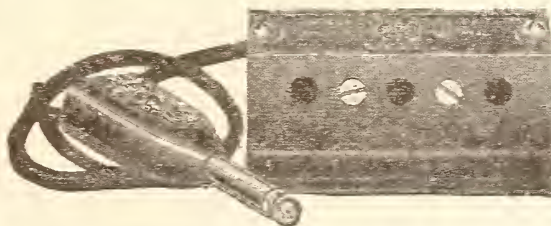

## PACENT JACKSET

A deluxe accessory for making multiple connections. Catalogue No. 5240. Price \$1.75



## PACENT MULTIJACK

Three Jacks in one moulded unit. Catalogue No. 52. Price \$1.00

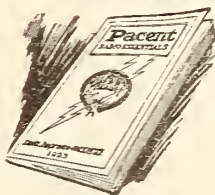

Write for new Pacent Catalogue No. B-12  
*Pacent Radio Essentials.*

## Pacent Electric Co., Inc.

22 Park Place New York  
Sales Offices: Chicago Philadelphia  
St. Louis San Francisco Minneapolis  
Washington Jacksonville

# Pacent RADIO ESSENTIALS



## PACENT UNIVERSAL PLUG

A perfect plug for every radio requirement. Catalogue No. 40. Price 50c

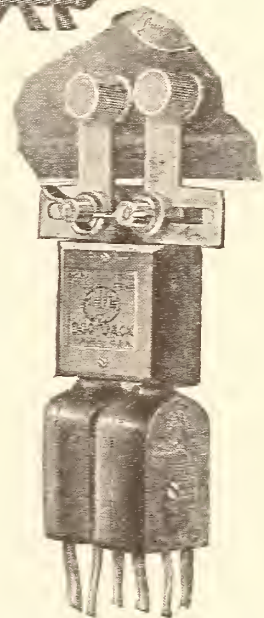

## PACENT DUOJACK

A Two Jack unit attachable to binding posts. Catalogue No. 53. Price \$1.00

## PACENT TWIN-ADAPTER

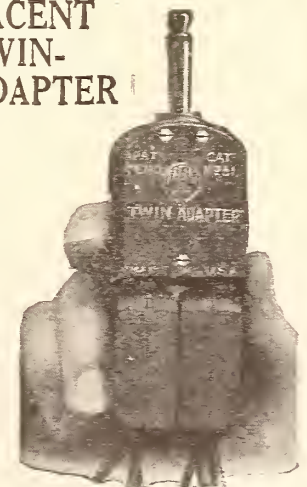

Permits two plug connections to single jack. Catalogue No. 51. Price \$1.00

CALL LETTERS	LOCATION	(KILO-CYCLES)	WAVE LENGTH	POWER (WATTS)	CALL LETTERS	LOCATION	(KILO-CYCLES)	WAVE LENGTH	POWER (WATTS)
WWAC	Waco, Tex.	833	360	50	WWI	Dearborn, Mich.	1100	273	50
WWAD	Philadelphia, Pa.	833	360	50	WWJ	Detroit, Mich.	580	517	500
WWAX	Laredo, Tex.	833	360	50	WWL	New Orleans, La.	833	360	100
WWB	Canton, Ohio	1120	268	100	WWZ	New York, N. Y.	833	360	100

CANADIAN BROADCASTING STATIONS

CALL LETTERS	LOCATION	(KILO-CYCLES)	WAVE LENGTH	CALL LETTERS	LOCATION	(KILO-CYCLES)	WAVE LENGTH
CFAC	Calgary, Alberta	698	430	CHCL	Vancouver, British Columbia	682	440
CFCA	Toronto, Ontario	750	400	CHYC	Montreal, Quebec	732	410
CFCF	Montreal, Quebec	682	440	CJCA	Edmonton, Alberta	667	450
CFCH	Iroquois Falls, Ontario	750	400	CJCD	Toronto, Ontario	732	410
CFCI	Vancouver, British Columbia	667	450	CJCE	Vancouver, British Columbia	714	420
CFCJ	Quebec, Quebec	732	410	CJCI	St. John, New Brunswick	750	400
CFCK	Edmonton, Alberta	732	410	CJCN	Toronto, Ontario	732	410
CFCL	Victoria, British Columbia	750	400	CJCX	Olds, Alberta	750	400
CFCN	Calgary, Alberta	682	440	CJGC	London, Ontario	698	430
CFCO	Bellevue, Quebec	667	450	CJSC	Toronto, Ontario	698	430
CFCW	London, Ontario	714	420	CKAC	Montreal, Quebec	698	430
CFQC	Saskatoon, Saskatchewan	750	400	CKCD	Vancouver, British Columbia	732	410
CFUC	Montreal, Quebec	750	400	CKCE	Toronto, Ontario	667	450
CHBC	Calgary, Alberta	732	410	CKCK	Regina, Saskatchewan	714	420
CHCD	Quebec, Quebec	732	410	CKOC	Hamilton, Ontario	732	410
CHCE	Victoria, British Columbia	750	400	CKY	Winnipeg, Manitoba	667	450

WORLD TIME CHART

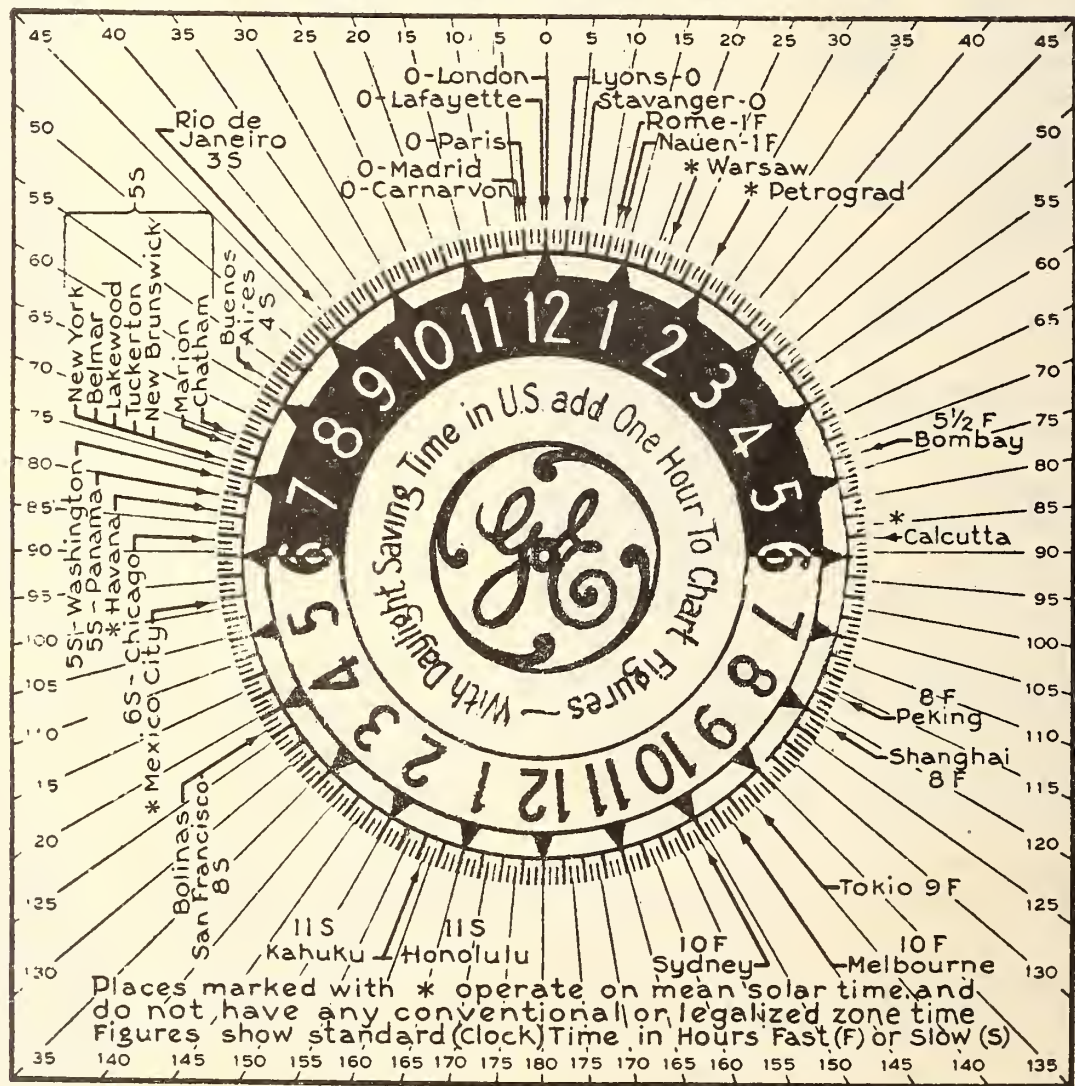

W Longitude E

Courtesy of General Electric Co.

If you mount this chart on a piece of cardboard and cut around the outside circle with a sharp knife and run a pin through the center to form an axle, you can tell the hour in any of the places indicated for a given hour in any other place. (For instance, when we [in America] transmit to England at 10 P. M. Eastern Standard Time, the time in England will be found by placing "10" opposite "New York" and reading the figure opposite "London," i. e., 3 A. M.)

More About the One-Tube Reflex

**RADIO**  
**BROADCAST**  
JANUARY 1924

*Full Account of the Transatlantic Tests*

A Two-Stage Amplifier  
For Your Receiver

“If You Like Them, Let  
Them Know It”

What You Should Know About  
Antennas and Grounds

A Simplified  
Super-Heterodyne



25 Cents



*Cunningham*

## RADIO TUBES

### *The Heart of Your Receiving Set*

IN the case of all living things the heart is the most vital organ. Weaken, injure or destroy the heart and life is accordingly weakened, endangered or destroyed.

In a radio receiving set the tube is analogous to the heart. Remove it entirely and the set will cease to function. Use an inferior tube and the results will be inefficient and generally not pleasing to listen to.

In living things a perfect heart does not always insure a healthy body, but on the other hand it is indispensable. The same is true of the radio receiving set. It may be perfect in every detail but unless the best tubes are used the results will not be perfect.

Cunningham Radio Tubes were developed in the great Research Laboratories of the General Elec-

tric Co., and are now being made in that company's modern and mammoth factories under the supervision of highly skilled engineers.

Better tubes are not attainable. There is a model specially adapted to every set, every circuit and every socket used to-day. Every radio dealer can supply you with Cunningham tubes. Buy them for replacements. Insist that they be included when purchasing a new set—and you will know that your receiving set has a perfect heart.

*The care and operation of each model of Receiving Tube is fully explained in our new 40-page "Radio Tube Data Book." Copies may be obtained by sending ten cents to our San Francisco office.*

**Patent Notice:** *Cunningham tubes are covered by patents dated 11-7-05, 1-15-07, 2-18-08, and others issued and pending. Licensed for amateur, experimental and entertainment use in radio communication. Any other use will be an infringement.*

#### Cunningham Radio Tubes

C-301A—6 Volts ¼ amp. Amplifier . . . . .	\$6.50
C-299—3 Volts .06 amp. Dry Battery Det. and Amp. . . . .	6.50
C-300—6 Volts Gas Content Detector . . . . .	5.00
C-11—1.1 Volts .25 amp. Dry Battery Det. and Amp. Special Base . . .	6.50
C-12—Similar to C-11 with standard base . . .	6.50

*E. J. Cunningham Inc.*

Home Office:  
182 Second Street  
San Francisco, Cal.

154 West Lake Street  
Chicago, Illinois

30 Church Street  
New York City, N. Y.

★ Tested and approved by RADIO BROADCAST ★

# SOLID COMFORT Comes With The Use Of The

TRADE MARK  
**AUDIOPHONE**

REG. U. S. PAT. OFFICE

because nothing is lost from the original broadcasting.

Not only is it easily possible to distinguish the words of the speaker, but also the minute gradations in pitch, timbre and quality of overtones which distinguish individual voices.

The Audiophone is complete and self-contained—needs no separate battery or other accessories—goes to you ready for use on connecting to your receiving set. It will prove a source of lasting pride and pleasure.

**Audiophone Sr., Price \$32.50**  
**Audiophone Jr., Price 22.50**



## BRISTOL ONE STAGE POWER AMPLIFIER

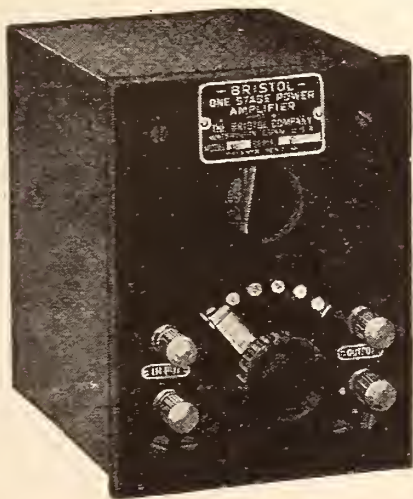

If greater volume is desired, over what you already obtain, use the Bristol One Stage Power Amplifier. No C Battery required. . . . . **Price \$25.00**

Write for Bulletin and address of the nearest dealer handling our instruments.

**THE BRISTOL COMPANY**  
**Waterbury Conn.**

# Radio Broadcast

ARTHUR H. LYNCH, EDITOR

## JANUARY, 1924

DAVID LLOYD GEORGE MAKING HIS FAREWELL SPEECH BY RADIO	- -	<i>Frontispiece</i>	
THE MARCH OF RADIO	- - - - -		183
WHAT RADIO MEANS AT A ROCKY MOUNTAIN RANCH	- - - -	<i>Ashley C. Dixon</i>	192
THE CHOICE OF A RECEIVING TUBE	- - - - -	<i>B. S. Havens</i>	195
LISTENING-IN IN MAMMOTH CAVE	- - - - -	<i>Fred G. Harlow</i>	197
WHAT YOU SHOULD KNOW ABOUT ANTENNAS AND GROUNDS		<i>R. H. G. Mathews</i>	201
WHEN THE PRISON BAND GOES ON AT WOS	- - - - -	<i>J. M. Witten</i>	205
THE ARISTOCRACY OF RADIO RECEIVERS	- - - - -		207
A SIMPLIFIED SUPER-HETERODYNE	- - - - -	<i>A. J. Haynes</i>	210
VARIOUS CIRCUITS AND WHAT THEY MEAN			
Part II. What Inductance Is and How It's Used	- - - -	<i>Zeb Bouck</i>	217
MAKING RADIO ATTRACTIVE TO WOMEN	- - - - -	<i>Lewis Wood</i>	221
HOW TO NEUTRALIZE THE NEUTRODYNE	- - - - -	<i>Kimball Houton Stark</i>	223
MUSIC DEALERS: LOGICAL SALESMEN OF RADIO SETS	- - - - -	<i>T. M. Pletcher</i>	226
WHAT OUR READERS WRITE US	- - - - -		230
HOW GERMANS USE RADIO AT AUTO RACES	- - - - -		233
WHAT RADIO MEANS TO ME	- - - - -	<i>W. Francis Goodreau</i>	234
IN THE R. B. LAB	- - - - -		236
Improving the One-Tube Reflex Set		The Daniell Cell as an A Battery	
The One-Tube Reflex with a Ballantine Variotransformer		Building Your Own Laboratory	
A "Super" Wave-Changer from a Three-Circuit Regenerative Receiver			
ALONE AMONG THOUSANDS	- - - - -		245
IF YOU LIKE THEM, LET THEM KNOW IT	- - - - -	<i>Myra May</i>	246
A TWO-STAGE AMPLIFIER FOR YOUR RECEIVER	- - - - -	<i>Carl Goudy</i>	250
THE GRID	- - - - -		260
Adding Audio Amplification to the One-Tube Reflex			
ADDITIONAL BROADCASTING STATIONS IN THE UNITED STATES	- - - - -		262
NEW EQUIPMENT	- - - - -		264
AMONG OUR AUTHORS	- - - - -		266

Copyright, 1923, by Doubleday, Page & Co. All rights reserved

TERMS: \$3.00 a year; single copies 25 cents

F. N. DOUBLEDAY, Pres.

ARTHUR W. PAGE, Vice-Pres.

NELSON DOUBLEDAY, Vice-Pres.

RUSSELL DOUBLEDAY, Sec'y.

S. A. EVERITT, Treas.

JOHN J. HESSIAN, Asst. Treas.

### DOUBLEDAY, PAGE & CO.

THE WORLD'S WORK    COUNTRY LIFE    THE GARDEN MAGAZINE    SHORT STORIES    EDUCATIONAL REVIEW  
 CHICAGO: People's Gas Bldg.    GARDEN CITY, N. Y.    NEW YORK: 120 W. 32nd Street  
 BOSTON: Tremont Bldg.    LOS ANGELES: Van Nuys Bldg.

# Clear as Your Headphones

**C**ALL in the crowd, now. Everyone can listen in with as much joy as one man at the headphones. Here is a loudspeaker with a reproducing range so wide that it gets all the tones—the high notes—and the low ones—with all their overtones and partials—full and rich. With a horn so perfect that it causes no distortion—adds no vibration of its own. And a one-finger adjustment that controls the volume, at your pleasure. Everything—music, speech, sports news—*clear for the crowd!* No more one-man radio sets. Everybody gets it—all!



This symbol of quality is your protection.

Radiola Loudspeaker  
Model U. Z.—1320  
Price \$36.50



Radio Corporation of America

Sales Offices: Dept. 31

233 Broadway, New York

10 So. La Salle St., Chicago, Ill.

433 California St., San Francisco, Cal.

# Radiola

## LOUDSPEAKER



“THOSE WHO MAKE WAR, WHETHER THEY ARE INDIVIDUALS OR NATIONS, CANNOT ESCAPE RESPONSIBILITY FOR THE PEACE. . . .

“But if you here, this mighty people, if our people throughout the British Empire, resolutely, firmly, courageously, without flinching, carry out the message, then I have no fear but that humanity will climb to higher altitudes of nobility, of security, of happiness, than it has ever yet known.”

—*DAVID LLOYD GEORGE,*

In his last address to the American people on Friday evening, November 2nd at the Metropolitan Opera House, New York. Hundreds of thousands heard the speech, broadcasted through WEAF's faithful microphone



# The Transatlantic Broadcasting Tests and What They Prove

How the Tests Originated, How They Progressed, and What Went on at RADIO BROADCAST'S Receiving Station in Garden City

EXCERPT FROM MR. OWEN D. YOUNG'S SPEECH, TRANSMITTED THROUGH WGY, WHICH OPENED THE AMERICAN TRANSATLANTIC TESTS

Friends and neighbors of Europe and America, I greet you from station WGY in behalf of the radio enthusiasts of America and in the name of RADIO BROADCAST, under whose inspiration and direction these transatlantic tests are being carried out.

First, let me send to the engineers of the world the congratulations of the technical concerns of America. Your efforts have made possible these first steps in international communication, which, in the end, will make all the world one neighborhood. We shall have understanding in place of misunderstanding. We shall have relationship of neighbors in place of the relationship of strangers. Men who talk with each other daily, with the object of better understanding, do not fight. Let these international conversations go on. Let the work of the engineers go on.

Next, let me say a word about the radio amateurs of the world, for they are engineers in the making. The greatest asset of any new art is to have the youth of the world interested in its development and confident of its future. The greatest inventions have been made by men under thirty. Hundreds of thousands of young men in this country are interested in and at work on radio. Future inventive genius of the world is preparing to add its great contributions. Radio is to-day the debtor of many young men, once amateurs, now great inventors. The amateurs of to-day will be the inventors and engineers of to-morrow; not only from the great research laboratories, but from that little spare room in the attic and that old work bench in the cellar will come new and great discoveries. Let the work of the amateurs go on.

Peace can come through voluntary disarmament only when, and to the extent that, we substitute instruments of international communication for instruments of international destruction. Engineers develop instrumentalities. They are not responsible for their use. Whether instruments shall be used for peace or war depends not upon the engineer, but upon the public opinion of the peoples of the world, and informed public opinion rests upon adequate communication.

The coöperation of the scientists and engineers of all nations to render a service to all peoples sets an example for the politicians and diplomatists of the world. Will the politicians follow that example?

ON SUNDAY night, November 25th, a stage was set such as the world had never known before.

This stage was built of rock and earth and ocean, with the moon and stars as spot-light and border-lights, and with a good part of the entire English-speaking world as audience.

For the first time in history, the man-in-the-street in England and his brother layman in the United States were enabled to listen to each other's voices.

And when the clocks of the Eastern and Middle-Western sections of this country struck ten, and farther west, nine, thousands of receiving sets were tuned

to the wavelengths of the eight stations of the British Broadcasting Company which transmitted to American listeners as the first step in the seven-day international broadcasting tests arranged by RADIO BROADCAST, in conjunction with the *Wireless World* and *Radio Review* (London). Aiding these two publications were the resources of the

<b>RADIOGRAM</b>	
WORLD WIDE WIRELESS	
CONTINENT TO CONTINENT	SHORE TO SHIP
Via RCA	Via RCA
RADIO CORPORATION OF AMERICA	
FORM NO. 112	192
RECEIVED AT 64 BROAD STREET, NEW YORK, AT _____	M. DATE _____
MPMUU R535	1923 NOV 27 PM 12 39
LONDON 31	11 878
RADIO BROADCAST	
DOUBLEPAGE NYK	
AMERICAN BROADCASTING HEARD THROUGHOUT COUNTRY BEST WGY NATIONAL ANTHEM SPEECHES LYNCH YOUNG ALSO WHAZ KDKA WMAF KSD WOR WGR	
WBAH WDAK FULL REPORTS EXPECTED TOMORROW	
RADIONIC. -	CONFIRMATION COPY
TELEPHONE: BROAD 5100	To secure prompt action on inquiries, this original RADIOGRAM should be presented at the office of the Radio Corporation. In telephone inquiries quote the number preceding the place of origin.

SHOWING HOW WELL ENGLAND HEARD US

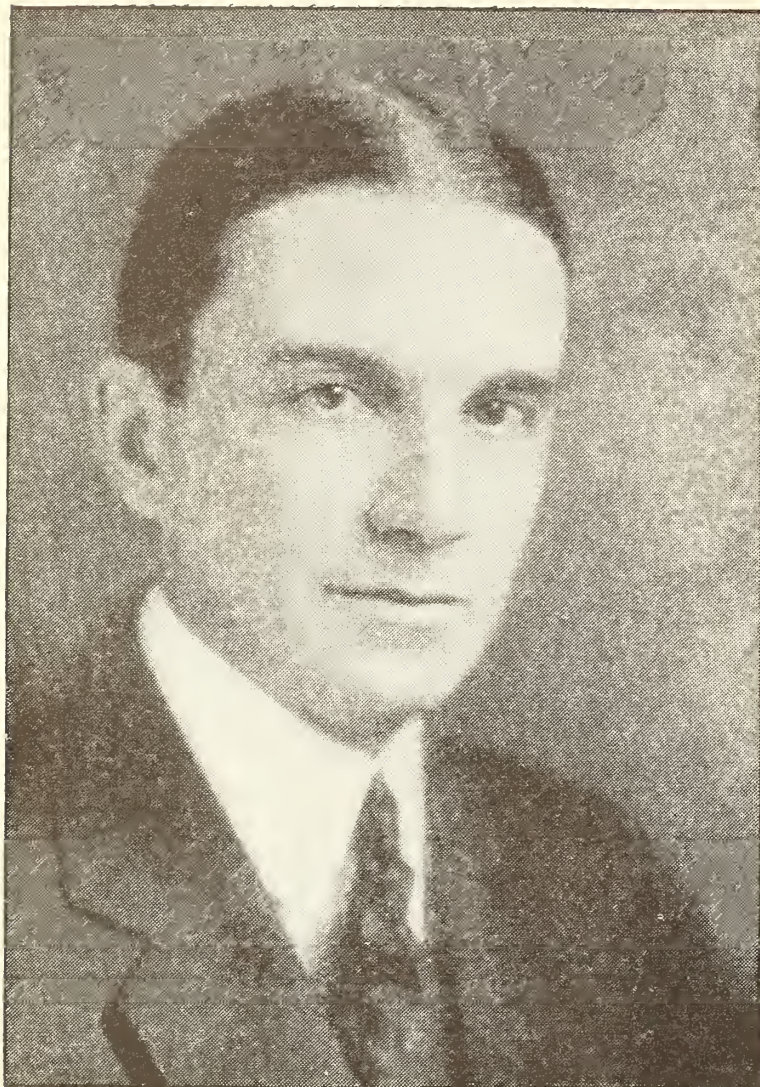

OWEN D. YOUNG

Chairman of the Boards of Directors of the General Electric Company and the Radio Corporation of America. Mr. Young opened the transatlantic broadcasting from this side

British Broadcasting Company and of our National Association of Broadcasters, besides the many American stations which signified by telegram to RADIO BROADCAST their eagerness to cooperate in these great scientific tests. International broadcasting on a large scale had never before been tried, and broadcast listeners throughout America were at the highest pitch of excitement to know whether or not *their* sets could pick up the faint signals from abroad.

The English listeners were no less enthusiastic, although the difference in time brought the beginning of their tests literally to "Three O'Clock in the Morning." Small wonder then, that this familiar music-hall piece found a significant place on many of the British programs.

#### HOW THE TESTS ORIGINATED

UPON his return from a trip to England a few months ago, during which he made a detailed study of radio broadcasting there, Mr. F. N. Doubleday, President of Doubleday, Page & Company, made the suggestion at one

of the weekly meetings of the editors of his magazines that it would be extremely interesting, and stimulating both to the progress of radio and to international friendship, were it possible for RADIO BROADCAST to arrange a program of broadcasting from this country to England.

After a rather extended discussion, the suggestion was made that two-way broadcasting, instead of one-way tests, be attempted. A working plan was outlined by this magazine and submitted to Hugh S. Pocock, Editor of the *Wireless World and Radio Review* of London. Mr. Pocock brought the proposal to the attention of the British Broadcasting Company and an agreement was made between that company's chief engineer, Captain E. P. Eckersley, and the two radio magazines, to carry out the plan.

Mr. Pocock and Captain Eckersley arranged all the details in England and immediate steps were taken to secure the cooperation of those interested in radio in this country. Inasmuch as National Radio Week would come at a time when atmospheric conditions would be favorable, it was decided to hold the tests as a feature of the National Radio Week program.

Newspapers all over the country were quick to appreciate the importance of this international program and were most generous with their space. In New York, for instance, the Associated Press, the United Press, and the International News Service spread abroad over their wire lines daily stories relating the details as they developed.

#### WHO WAS TO SPEAK FOR AMERICA?

NATURALLY, when it came to inviting speakers to broadcast messages to England from this country, our first thought was of the President. And we visited the White House in an effort to have Mr. Coolidge address the people of America and England simultaneously. Mark Sullivan, of Washington, the internationally known writer on politics, acted as RADIO BROADCAST's representative at the Capitol. Unfortunately, there was not time enough to arrange the diplomatic details necessary for an arrangement, entirely unprecedented, of this kind.

Similar diplomatic obstacles prevented the Prince of Wales and Prime Minister Baldwin of Great Britain from speaking. As the most influential single man in the radio field in the United States, we looked to Owen D. Young,

Chairman of the Boards of Directors of the General Electric Company and the Radio Corporation of America, to open the international program for America. Through Mr. Stuart Crocker, assistant to Mr. Young, we learned that Mr. Young would be glad to aid our program in any way he could.

When we brought our plans to Major-General James G. Harbord, President of the Radio Corporation, he, too, was quick to lend his generous aid.

The romance of this attempt at international communication appealed very strongly to Mr. Henry Ford. Every American knows that Mr. Ford is credited with making the impossible possible in the automobile industry, and he was so much in sympathy with this first attempt at linking nations by voice that he agreed to address the people of England and America through his own station at Dearborn, Michigan—WWI. In securing Mr. Henry Ford's cooperation, we were greatly aided by Mr. Samuel Crowther, Mr. Ford's biographer.

One of the most important addresses made during these tests was that of Charles Evans Hughes, Secretary of State, on Friday night, November 30th, in Philadelphia, before the American Academy of Political and Social Science, and broadcasted by WDAR in that city.

Although we have held our presses until the last minute in order to give our readers as detailed a report as possible, the programs from the English broadcasters have not come through in full. Each American broadcaster had full charge of arranging his own transatlantic program.

However, Governor Hyde of Missouri spoke for fifteen minutes from KSD in St. Louis, and British Vice-Consul Hyde and Mr. Frank Conrad, Chief Engineer of the Westinghouse Electric and Manufacturing Company, made addresses from the Pittsburgh *Post* studio which were put on the air by KDKA.

On the nights of the American transmission, the most powerful broadcasting stations on this



"THE FIRST NIGHT"

SCENE: RADIO BROADCAST laboratory, Garden City, L. I., where two super-heterodynes and a six-stage tuned radio-frequency receiver occupied the attention of (left to right): George J. Eltz, Jr., George Toohill, A. J. Haynes, Paul F. Godley, C. L. Farrand, and the editor of this magazine

side of the Atlantic were invited to send special programs from ten to ten thirty, Eastern Standard time. And every broadcast listener knows how many of these stations prepared excellent programs and put them on the air.

The day following each of the American transmissions, the British Broadcasting Company and the *Wireless World* advised RADIO BROADCAST by radiogram of the American stations which were heard best in England.

Shortly before the final two-way test, we chose the American stations to send the final program to England from these reports of good reception in England.

The list of American broadcasters sending on the first three American test nights would be excessively long. But the stations selected for the two-way communication on the last night were: WGY, WOR, KSD, WGR, WTAM, WOC, WSAI, WHAZ, WJAZ, and WGI.

In concluding the American participation in these international tests, Major-General James G. Harbord, President of the Radio Corporation of America, spoke to the people of England for five minutes over a special telephone wire from New York city through WGY in Schenectady.

Burton J. Hendrick, Associate Editor of *The World's Work* and biographer of the late Walter Hines Page, addressed the people of the British Isles through WOR in Newark.

#### COÖPERATION BY AMATEURS, COMMERCIAL STATIONS AND BROADCASTERS

WITHOUT the help of amateur and ship and shore operator, broadcaster, and radio executive, the tests would have failed utterly. And what help they gave! RADIO BROADCAST has always maintained that the radio amateur is ever willing to assist in any activity contributing to the development of the art. Of this, no greater proof could be had than the fact that

during the entire week not a single complaint against amateur interference was made.

Because the wavelengths of some of the broadcasting stations are very close to those used for ship-to-shore commercial traffic, interference with radio programs is sometimes experienced. Unfortunately, this is at present a matter quite beyond the control of either ship or shore stations. Five minutes before the first transmission from England began,

we communicated with the Marine Superintendent of the Radio Corporation and requested that he send a service message to his ships asking them to remain silent for the half-hour period of the tests, except in case of an emergency. Our request was complied with and interference from this source during the week was practically negligible. A similar request, made to Mr. C. J. Pannill, President of the Independent Wireless Telegraph Company, received the same courteous attention.

Our most serious

problem was to secure the coöperation of the broadcasters themselves. With approximately six hundred broadcasting stations in the country, this seemed an almost hopeless task.

Mr. Eugene F. McDonald, Jr., President of the National Association of Broadcasters, and Mr. Paul B. Klugh, the Association's executive chairman, were apprised of the campaign and their help was enlisted. The National Association took it upon itself to secure the coöperation of all the broadcasters numbered among its members. Almost before the sun went down on the day the Association decided to coöperate, the announcers of some of the best broadcasting stations in the country were telling their radio listeners of the great experiment to come.

Our attempts to keep the American broadcasters silent on the first two nights of the



MARTIN P. RICE

Director of Broadcasting of the General Electric Company, whose whole-hearted coöperation went a long way toward making the tests successful

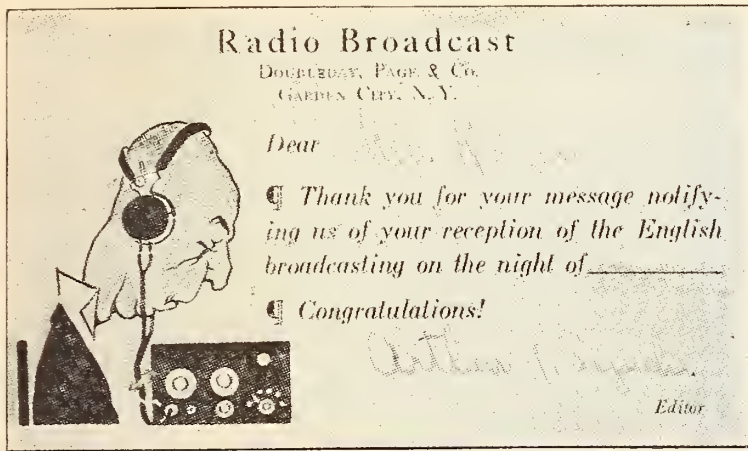

CARDS LIKE THIS WENT TO ALL WHO REPORTED HEARING ENGLAND

English transmission were only partially successful. We appealed to the President of the National Association of Broadcasters to communicate with all his member stations by telegraph. He advised them to broadcast an announcement requesting listeners-in to communicate with other stations in their vicinity asking them to remain silent during these eventful half-hours. That night, at our own laboratory, we heard this message flung out over the country. The result was almost absolute silence on the last and most important night of the tests. Could a more convincing demonstration be had of the effectiveness of radio broadcasting in reaching every section of the country?

Having to act on such short notice was a great hardship on most of the directors of the broadcasting stations. Most of them had complete programs arranged, many of which had already been published in the newspapers. Thanksgiving night was a particularly difficult one to handle. Many special features had been arranged. But these men sacrificed the interest of their individual stations for the greater interest. They deserve the highest praise for their coöperation and resourcefulness in making these eleventh-hour shifts in their programs.

In order that both sides of the broad Atlantic might know exactly how the tests were faring at all times, it was necessary to have a rapid means of inter-communi-

cation. The voice tests were pure experiment. But transocean radio telegraphy was not. So the well-established radio telegraph came to help out the infant radio telephone. General Harbord put the transatlantic service at our command and a direct wire was installed between the Broad Street Radio Central office in New York and RADIO BROADCAST laboratory at Garden City. The British Broadcasting Company and Marconi House, London, were connected by a similar wire so that not an unnecessary second was lost in communication between the two countries. As an instance of the effectiveness of this circuit, during the tests from England on the first night, we were receiving speech which we believed was from London but which we could not understand. A request that a piano be played was winged over the radio telegraph circuit across the Atlantic. Just three minutes later a pianist in London was playing, and we were listening to the music in Garden City in common with hundreds of others whose reports have reached us by telegraph and mail from as far west as Davenport, Iowa.

Any visitor to the RADIO BROADCAST offices during the test week would have been as deeply impressed as were the editors with the phenomenal interest shown by listeners-in in every corner of the nation. Telegrams, letters, post cards and a host of local and long distance telephone calls, poured into the office night and day, each with their story of English reception.

MAJOR-GENERAL HARBORD  
President of the Radio Corporation  
of America, who, with his great  
organization, helped to make the  
tests possible

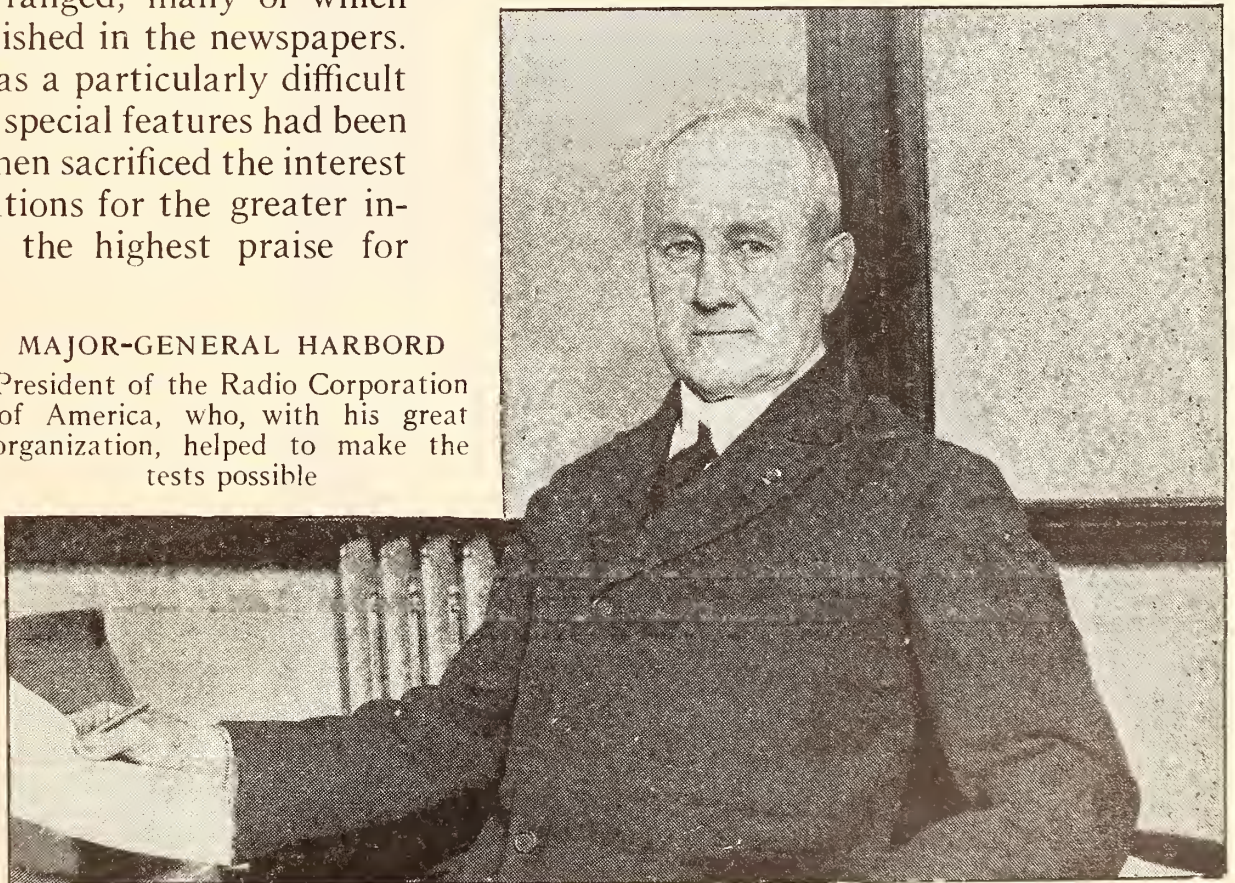

The broadcast listener was alert, capable, and extremely willing to do his bit, even to the extent of considerable expenditure for telegrams and long distance phone calls. For instance, one youth in Connecticut had a telegram in our office ten minutes after a British program had finished, reporting his reception of it.

In order to facilitate communication of this character, Commercial Vice-President C. A. Comstock of the Postal Telegraph-Cable company agreed to use every facility of his company, through careful instructions to his district office managers, to hasten the delivery of messages from listeners-in in various sections of the country to the Garden City laboratory.

#### SPECIAL RECEIVING STATIONS

**A**LTHOUGH every effort was made to have the receiving station in RADIO BROADCAST laboratory the finest possible, we wished to enlist the best radio aid in this

section of the country in receiving England. On the first night of the test, in RADIO BROADCAST'S Laboratory, Paul F. Godley (best known to American fans through his successful reception of American amateur signals, in Scotland, in November, 1921) and C. L. Farrand (Mr. Godley's associate), operated a specially constructed tuned radio-frequency amplifier receiver employing a three-foot loop antenna. George J. Eltz, Jr., manager of the radio department of the Manhattan Electric Supply Company, used a nine-tube super-heterodyne which he constructed especially for the test. A. J. Haynes, Vice-President of the Haynes-Griffin Radio Service, Inc., operated a seven-tube super-heterodyne, which was also constructed for these tests. All of these receivers picked up English signals.

On the last night of the tests, Frank M. Squire, Chief Engineer of the De Forest Radio Telegraph and Telephone Company, picked up England on a six-tube reflex receiver.

Located outside of New York and communicating with our laboratory, were Dr. Walter van B. Roberts, of the Palmer Physical Laboratory, Princeton University, with a super-heterodyne of his own design. Dr. L. M. Hull of the Radio Frequency Laboratories at Boonton, N. J., operated a six-stage tuned radio-frequency receiver. Engineers of the General Electric Company moved a receiving station from Schenectady to a point outside the city in order to get better signals. Besides these, Mr. Frank Conrad, Chief Engineer of the Westinghouse Electric and Manufacturing Company, listened-in at Pittsburgh, Pa. Several of the students at Rensselaer Polytechnic Institute at Troy, N. Y., used a 12-tube super-heterodyne of the resistance-coupled type.

Operators at most of the broadcasting stations kept us advised of the results they obtained. At Station CFAC, Calgary, Alberta, operators used a ten-tube super-heterodyne. Operators at WOC, Davenport, Iowa, WOR, Newark, N. J., and KSD, St. Louis, also advised us of their success.

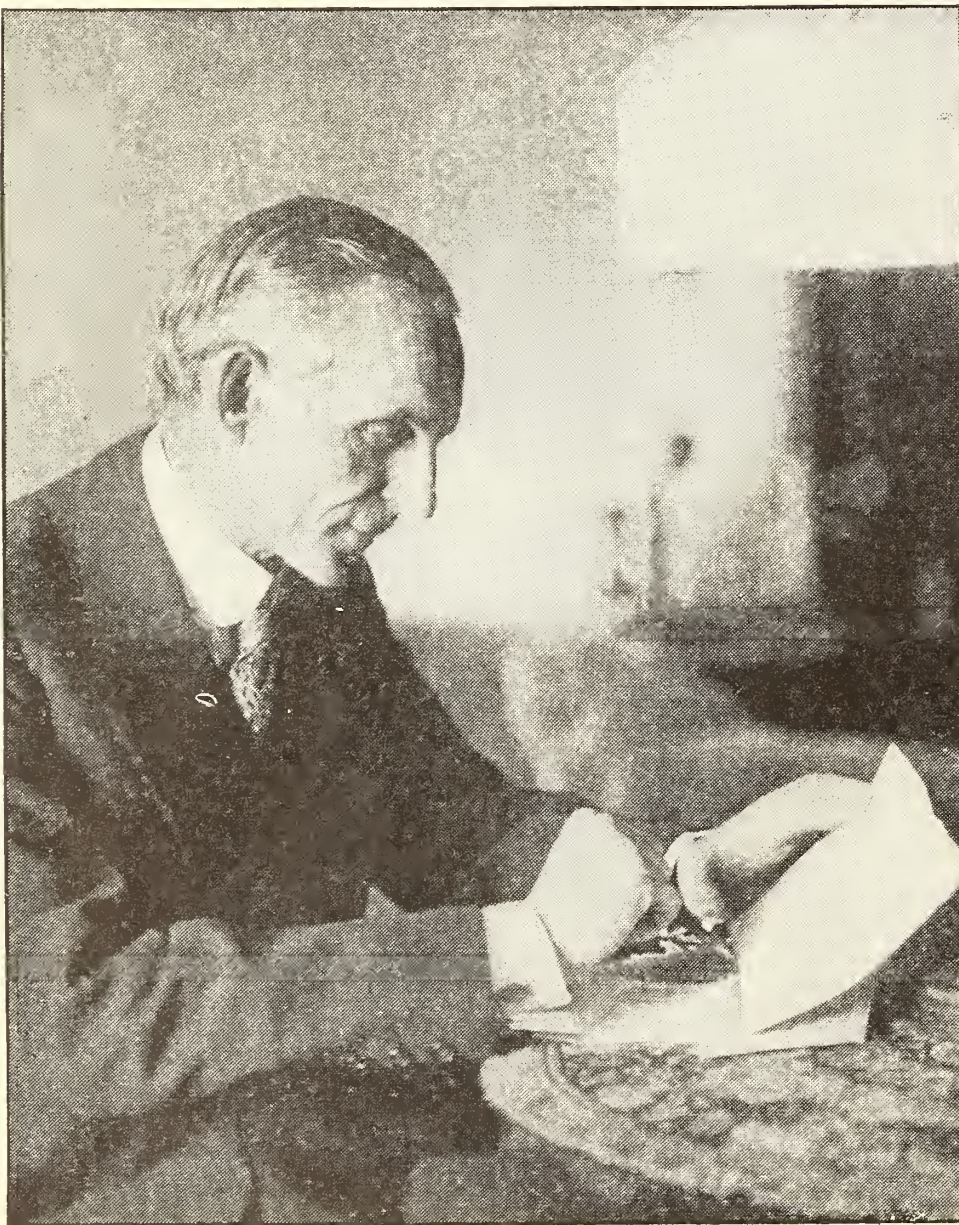

HENRY FORD

Who spoke to England from his own station, WWI, at Dearborn, Michigan, on November 30th. Mr. Ford had never made a radio address before

## DIFFICULTIES AND ADVANTAGES IN ENGLAND

THE difficulties in arranging this test were not only electrical, but physical. It is well-known that radio signals cover much greater distances at night than during daylight hours. For this reason, it was thought advisable to run the tests during a period when complete darkness prevailed between the English stations and the United States and Canada. From 10 to 10:30 P. M. Eastern Standard time, the period chosen for these tests, is 7 to 7:30 P. M. on the West Coast and from 3 to 3:30 A. M. in England.

Picture the problem of the British Broadcasting Company. They had eight stations, joined by land wire to the central offices in London. They had large staffs to maintain, during these extra hours. An additional force of experts was required at their central office to handle the mass of detail incident to keeping the whole eight stations running smoothly. Besides, the strain on the operators and managers was considerable. Not only had they to broadcast during their usual hours, but each night for a week the entire crew was kept up until at least four every morning with American transmission and reception.

Besides this, the telephone exchanges leading into the Broadcasting Company's offices were positively clogged with calls after and during their tests. There was also an enormous influx of mail from British listeners.

There were, however, four distinct advantages that British listeners had over those in America. All the British stations were under single control. There was, then, no interference from other broadcasting stations in England. Oscillating receivers, which proved a serious source of interference in cities in the United States, are prohibited by law in England. Furthermore, the American stations used a great deal more power to transmit than the English. And finally, the arrangement of programs offered slight difficulty to the English also, since all the stations were controlled at one office.



SENATORE GUGLIELMO MARCONI

At 3 A. M., London Time, November 28th, he addressed the American listeners-in through the eight stations connected by land lines to the central office in London

It would seem that it must be a notable event indeed which would keep Guglielmo Marconi, whose speech was recorded in this country, up until three o'clock in the morning. Senatore Marconi, in his radio address, mentioned this significant fact: it was just twenty-two years ago in December that the experiment took place wherein he received from Poldhu, England, that eagerly awaited letter "S" at St. Johns, Newfoundland.

## A WRECK OF PLANS AVERTED

ONE of the most serious situations we had to deal with presented itself on Thanksgiving morning. The tests conducted from England the night before had been quite unsatisfactory, due to the failure of many of the American broadcasting stations to shut down, together with unfavorable atmospheric con-

ditions on this side. The British Broadcasting Company then decided to conduct no more tests until the last night. Before their radiogram to this effect was received, we had telegraphed all over the country requesting broadcasters to maintain the silence periods on the last two remaining nights of the tests. The prospect of reception from the other side seemed excellent. Then came this startling message from England: *Reception still good no more tests until attempt at two way communication December first as per program—British Broadcasting Company.*

At twelve o'clock, we sent a message to both the British Broadcasting Company and the *Wireless World*, stating that we had secured much better cooperation and that listeners-in throughout America were waiting for them to transmit. After waiting two hours for a reply, we asked Mr. W. A. Winterbottom, Traffic Manager of the Radio Corporation to send a service message to the traffic manager in England exhorting him to get in communication with Captain Eckersley of the British Broadcasting company, or Mr. Pocock of the *Wireless World* by telephone. Within another hour, we had received this reply: *Doublepage New York — London 363 Bournemouth 385 metres 3 to 330 AM GMT—British Broadcasting Company.* A deep sigh of relief then was breathed. Service of this kind almost surpasses belief.

The space available does not permit us to detail the story of receiving England on all the test nights, but perhaps the account of the first night of receiving from England will interest thousands of other listeners in all sections of the land.

After spending a day installing the receiving sets and making preliminary tests, three complete receivers at our laboratory were ready to listen-in for the English broadcasts. RADIO BROADCAST's new laboratory was rushed to completion for the tests, but the electric light installation had not been completed. Mr. Godley and Mr. Farrand operated their receiver in a room opening off the laboratory, aided by the glow of a kerosene lamp. Beside them, operating the land wire between RADIO BROADCAST and Radio Central, Broad Street, New York, was

Willis K. Wing, of the RADIO BROADCAST staff. Behind them, in the semi-darkness, representatives of most of the New York newspapers and news services as well as foreign correspondents of English papers were gathered, eagerly awaiting the first faint British voice. At one side were the press photographers with camera and flashlight gun. Two of the most interested spectators in the laboratory were Mr. F. N. Doubleday, and Nelson Doubleday—both ardent radio enthusiasts.

In the laboratory itself sat Mr. Eltz and Mr. Haynes at their respective sets. For a half hour before the test period, the visitors were entertained by music picked up from all over this country as the operators tuned-in to get their bearings on the wavelengths and dial setting on which they would be most likely to pick up the English stations.

“HELLO, AMERICA!”

IMAGINE yourself with us in the new “shack” that night. It is five minutes to ten. The first stroke of the time signals from Arlington booms in on the loud

speakers. As each second brings the start of the test nearer, you feel the tension increase. You hear the long dash. It is just ten. Now. . . . Loud speakers are abandoned for headphones. The faint click of a filament rheostat seems as loud as a shot. Fifteen minutes pass. The only stations heard are those Americans which unwittingly continued to broadcast. No word is said, but the waiting newspaper men detect an occasional frown on the faces of the tense operators which tells plainer than words that so far, there's “nothing doing.”

Now the operators bend over their receivers and manipulate their dials most delicately. Speech is heard, but they cannot understand it. They are asked to hold their receivers to the same wavelengths, while a radiogram is sent to London asking for piano solos. Three minutes pass. Faint but clear come the notes of the piano playing in distant London. The operators catch the now famous: “Hello, America” and the newspaper men leave hastily to telephone to New York. Success! In another minute—literally—RADIO BROADCAST's congratulatory radiogram is in London.



EUGENE F. MCDONALD, JR.  
President of the National Association of Broadcasters, who helped to keep American stations off the air during the British transmitting periods



## WHAT THESE TESTS PROVE

INTERNATIONAL broadcasting is now no longer an idle dream, but a fact. Now we can expect its rapid development. These developments may not make it possible for the owner of an average receiver to listen-in on London at will. It may first be necessary to abandon our present system of direct broadcasting for some form of re-broadcasting. By this plan, the waves from stations operating in England, or even other countries, would be picked up by sensitive receivers here, amplified and sent out by any of the stations we now hear.

Before this kind of international broadcasting can be realized, there are many technical difficulties which must be overcome. But by this arrangement, it would be possible, as Marconi himself has already suggested, for the owner of a modest crystal set,

over here, to receive speech and music from Europe.

If we are not content to postpone international voice communication until this re-broadcasting system has been completed, these tests have absolutely proved that broadcasting stations of higher power than those used in Great Britain are essential. For American stations of more than average power experienced little difficulty, in general, in reaching England, whereas the English stations operating with comparatively low power did exceedingly well to be heard in this country at all.

Heretofore, the need for high-power transmitters has not been felt in England, due to the fact that their stations have been designed to serve a territory much smaller than ours.

A better apportionment of wavelengths is an unquestioned necessity to overcome the

*(Continued on page 195)*



AT RADIO CENTRAL, NEW YORK

W. A. Winterbottom, Traffic Manager of the Radio Corporation, looking over the tape used on the Wheatstone transmitter in sending messages to England directly from the RADIO BROADCAST laboratory, notifying the British broadcasters of their success in reaching America



#### THE HOUSE THAT RADIO MADE

A view of the Dixon ranch at Stevensville, Montana, taken Thanksgiving Day, 1922. In the spring of 1922, the house was radio-less. Now it contains broadcasting station KFSR and amateur stations 7IT and 7ACP

## What Radio Means at a Rocky Mountain Ranch

A Story of the Remarkable Change that Twelve Months Brought in a Remote Home in Montana

By ASHLEY C. DIXON

**F**AR out in western Montana, under the shadow of the mighty Bitter Root Mountains, lies a little valley some ten miles wide near its center and about seventy-five miles long. Similar in many respects to dozens of other ranching valleys of the great northwest, it might well be the scene of any of the present-day stories which have such an appeal to the Eastern reader: stories of cattle, of irrigation, or of the "Winning of the West."

Such spots are always described as smiling with the goodness of nature. The air is warm and dry. The sun always shines, and the hardships of city life are unknown.

In part this is true. But there is another

side to the changing seasons which mark the cycle of the sun's passage to the winter solstice. The summer is comparatively short. Autumn comes early in September, and following close upon the light frosts comes the Rocky Mountain winter. Then nature shows her other side, and for months the fields and ranch houses lie under a mantle of snow. The soft music of the summer breeze is replaced by the roar of the northeast wind bearing its burden of fine stinging snow. Roads drift feet deep in hard-packed ice particles. Cattle band together for mutual warmth and protection, seeking the shelter of the cotton-wood clump on the creek bottom.

To the Bitter Root Valley came an Eastern

family about thirteen years ago, just as thousands of others have come to trade the hardships and comforts of Eastern city life for the entirely different hardships and comforts of the West. The ranch home with its large

room and its big open fireplace, took the place of the city house. Alfalfa, fruit, and livestock replaced the office desk, and the rumble of the streets and clang of the trolley were forgotten.

There were compensations to make up for everything left behind save one thing alone. No one who enjoys concerts, opera, or addresses by the leading minds of the nation can ever find a substitute for the pleasure they give. While living in a great city such forms of entertainment are taken as a matter of course. One does not realize what they really mean till they are not to be had. And winter is the season of music.

We, the above-mentioned family, put in eleven long mountain winters. The days are short in the north-west country, and night comes in what used to be considered mid-afternoon. There were books to be read, cards and other games, and the phonograph. No physical comforts were lacking around the evening fire, but something was lacking, a part of the old life was gone with nothing to take its place. Then came radio!

A year ago last May we began to hear of the wonders of the radio receiver, and how one could light certain lamps contained in a box, after properly hooking the box up to a wire out-

### Has This Happened Yet to You?

Says Mr. Dixon: "In September, 1922, we lighted our first tube. To-day the son is a licensed commercial radio operator, and the writer holds an amateur license. Each has his own transmitting set with which communication is had every night with other amateurs in the western half of the United States."

side the house, turn a few dials, and listen to music. Wonderful! We had never seen such a box, nor did we know whether the lights in it were arc lamps or just the ordinary household electric lights. But no matter what the type or kind, if they would bring the outside world to us over the mountains and through the miles of snow covered pines, we wanted some of these Aladdin's Lamps of radio.

Advice was sought, but very difficult to get.



FIFTEEN MONTHS AGO THIS ROOM CONTAINED NOTHING More technical than a 1/4-KW sewing machine.



"THE FLOWERS THAT BLOOM IN MONTAN', TRA LA . . ."

And what we could get was of the most discouraging kind. "Bring radio waves over 10,000-foot mountains and down to the floor of the valley? Impossible." The antenna (that wire we had heard about) would have to be a couple of hundred feet high, and even then we would probably find we were in a "radio shadow," and the trouble and expense would be for nothing. Hope was blasted, and for a time we gave up the idea.

While in Missoula one day in June we happened to get into conversation with a music dealer friend. He had a picture of a radio receiver which he contemplated taking the agency for. But he, too, had heard adverse reports about what we could expect, and was hesitant about taking up the matter.

A few days after our conversation with this gentleman, we departed for California on a vacation trip. Radio was still a topic of interest, and we intended to find out just what we could learn about its wonders while in San Francisco. There were radio stores and department stores handling radio receivers and supplies. We made life miserable for many a good-natured clerk asking this and that. We saw for the first time some of the mysterious boxes, and learned that the "lamps" were called tubes, and were not the garden variety of tungsten light. We were told by ambitious

salesmen that we could expect to get something every once in a while, even in the mountains, if we would buy this or that particular set. The advice was taken and appreciated, but having in mind the picture of the set we had seen in Missoula, no purchase was made.

In July, after our return, the music dealer and the writer determined to take a wild chance, and order a radio set each. The local Forest Ranger was hunted up and asked permission to get a couple of poles out of the forest preserve. Several pages might be filled with the story of how we got these poles down from the mountain side and set up in the ranch yard. Antenna wire was bought in Butte, and finally everything was ready to hook on the little box.

It was evident that the radio set we had decided upon enjoyed a measure of popularity, as the factory could not fill our order for over two months. But all things have an end, and in September our box of tricks came. It was carried thirty miles from the city to the ranch and set up as per directions that afternoon. Evening, only a few hours off, seemed days in coming. Fear and anticipation alternated, and we had but little hope that our gamble against nature, with a man-made machine, would be other than a total loss.

"This is KDN, located on the Fairmont Hotel. Our next selection will be 'Three

O'Clock in the Morning.'” KDN! Fairmont Hotel! Why, KDN and the Fairmont were in San Francisco, eight hundred miles away. The Fairmont was where we had stopped just a few weeks before. And wonder of wonders, the son in the family had visited the studio of KDN, had talked with the announcer, and his was the first voice of the air to be heard on our new set, easily recognized as the same voice heard in person a short while before. Open before us was a vista of the winter to come. Gone was the fear of winter and its snow. KDN had voiced the promise of delights to follow!

KDN is gone, and the mighty KPO has taken its place. Now the thunder of Hale Brothers' organ, received, amplified, and released through a loud speaker, all located in a little back room called our “den,” fills not only the living room, but the entire house with its melody. WJAZ of Chicago, KHJ of Los Angeles, WGM and WSB of Atlanta, WWJ of Detroit, and now and then KDYX of Honolulu, as well as a host of others, have all contributed their share to the long winter evenings' entertainment. But never will anything sound as sweet to us as did that particular “Three O'Clock in the Morning,” from old KDN.

The writer would wish to stop here, as anything to follow seems to him an anti-climax. However, a tabloid sketch of radio progress

on this ranch might be of interest. In September, 1922, we lighted our first tube. To-day the son is a licensed commercial radio operator, and the writer holds an amateur's license. Each has his own transmitting set with which communication is had every night with other amateurs in the western half of the United States. Stations 7IT and 7ACP are known from Los Angeles to Minnesota. And to-night, September 23rd, we open our own broadcasting station, Radio KFJR, at 8 P. M. This station, designed by Mr. Abner R. Willson, radio engineer of Butte, Mont., is entirely home-made, the work being done by the writer and his son.

The same antenna we use for receiving serves for the amateur transmitters as well as KFJR. The poles are not a couple of hundred feet high, but only fifty. And every now and then, for a radio stunt, the antenna is disconnected, and music or speech picked up with a bell cord tacked to the picture rail in the den, from stations as far away as WJAZ, in Chicago, loud enough to be heard through the loud speaker a hundred feet from the house.

Winter is now a season of anticipation and joy. Summer—the poetic Western summer of gentle breezes and sunshine—is tolerated as a necessary evil, preceding the season of snow and blizzard, made perfect by the “voices of the air.”

---

*“The Choice of a Receiving Tube,” by B. S. Havens, omitted from this issue, will appear next month*

---

## The Transatlantic Broadcasting Tests and What They Prove

*(Continued from page 191)*

interference now experienced on the broadcasting wavelengths. Those now used by ship and shore stations have been adopted by international convention and it will be impossible to change them before the next international conference. However, an effort is being made to reduce this interference to an absolute minimum by regulations of the companies in charge of ship and shore stations.

Receiving sets which in themselves act as

transmitters when improperly operated, must be abandoned. Scattered owners of receivers have appreciated this fact for some time, but these tests have brought it home to many more listeners-in. They found it almost impossible to evade the disturbance these sets created.

Our own conception of the great influence that the international exchange of ideas through radio broadcasting will have, is nowhere better expressed than in these words from



Mr. Young's speech from WGY: "Men who talk with each other daily, with the object of better understanding, do not fight. Let these international conversations go on. Let the work of the engineers go on." Or, as Neal O'Hara wrote of these tests in the *New York Evening World*: "It looks like radio is doing its best to cloud up the next war."

MISS CATHERINE MOORE

The first girl radio fan to report picking up the now famous "Hello America" in RADIO BROADCAST'S transatlantic tests

ADDRESS BY MAJOR-GENERAL HARBORD TO LISTENERS-IN OF GREAT BRITAIN  
FROM STATION WGY, NOVEMBER, 28TH, 1923

*The privilege I now enjoy of addressing people of the old and the new world without having even to raise my voice above conversational tone, is so unique, so impressive, that I am awe-struck at its potentialities. This is indeed an age of miracles. It is only three years ago that experiments in radio broadcasting commanded the awakening interest of our entire country. People marveled at the wonderful agency which made it possible for them to capture from the very atmosphere about them the voice and personality of some artist or speaker perhaps a hundred miles away.*

*Since then we have passed through a period of development, so rapid and vast as to place it beyond ordinary powers of description. To-day, it can truthfully be said that there is not a community in the United States to which one or more stations of our comprehensive broadcasting systems do not carry their messages of utility and varying entertainment. Leaders of political thought, culture, science and the arts are enabled to address millions of their countrymen in all walks of life, in city and in country with an ease rivalling the intimacy of the telephone.*

*From those across the sea, our kinsmen by blood and tongue, have come your own statesmen in recent months, and served by this same genie, radio, their voices have reached millions of our people.*

*And now, scarcely before we have been able to grasp and assimilate the tremendous import of it all, we are invited to speak to our British cousins across the weary stretches of three thousand miles of the intervening Atlantic.*

*It is a matter of tremendous pride to you and to us that this new accomplishment is the logical outcome of the intensive research and development that has been untiringly carried on by scientists in both our countries since the inception of radio broadcasting.*

*As my voice reaches the people of England to-night, my memory pictures the great service and unfailing hospitality that our American soldiers received at your hands, while on their way to France. Your splendid coöperation in those trying months will never be forgotten. Nor can we forget how considerate and tender was your care for our wounded, and how our men were welcomed to your homes at a time when perhaps anything more than the barest frugality could be ill-afforded by your generous people in the throes of a great war.*

*Our nations are closely cemented by unity of democratic purpose, by the same high ideals, and by a common language. Let us hope that this first exchange of thought by voice across the broad Atlantic will serve to strengthen our existing friendship in permanent bonds of understanding.*

*The program of this National Radio Week have constituted the first attempt to reach you through organized broadcasting, and to receive your acknowledgment from your own broadcasting stations. Surely radio is the harbinger of a closer tie, more thorough understanding, among the nations of the earth.*

*I shall be very glad to hear from those of you in Great Britain who may have heard my voice this evening. This is the President of the Radio Corporation of America, speaking from station WGY on the occasion of the first organized broadcasting tests between America and Great Britain—tests instituted by one of our publications known as RADIO BROADCAST and staged during our National Radio Week. Thank you. Good-night!*



THE WRITER, THE SCEPTICAL GUIDE, AND W. A. MIVELEZ

# Listening-in in Mammoth Cave

An Account of the First Radio Tests Conducted  
in Kentucky's "Eighth Wonder of the World"

By FRED G. HARLOW

**G**IVEN: One Cave, Mammoth, located in Kentucky, 102 miles from Louisville; one broadcasting station, WHAS, in Louisville; one four-tube non-regenerative loop receiver; one assistant, W. A. Mivelez; one Negro cave-guide, tolerant though sceptical.

**TO FIND:** Radio waves, deep down in aforementioned cave.

**PROCEDURE:** As Junior Operator of WHAS, I had arranged with J. Emmett Graft, Senior Operator at the *Courier-Journal* and *Louisville Times* station, to have signals transmitted at stated times, and my companion and I betook ourselves to Mammoth Cave. While sitting in our hotel room 360 feet above the Rotunda in the cave, where we expected to make our first underground test the next day, we tuned-in

WHAS and heard the concert with great distinctness, thus assuring ourselves that our instruments were in good working order. If we did not catch our station down in the mysterious caverns we could be reasonably sure that some agency in the earth was acting as a screen or counter-attraction for the radio waves.

The next morning, with the Negro guide whom the cave authorities had very kindly put at our disposal, we left the hotel for our great adventure, feeling no little excitement in the knowledge that we were to be the first persons to make radio tests down in what is frequently called the Eighth Wonder of the World.

Following a wooded path along a steep declivity for a quarter of a mile we came at last to the great entrance, a huge mouth of black-



THE ENTRANCE TO THE CAVE

ness from which issued a continuous breath of cool fresh air. The Cave is said to "breathe" but twice a year, taking a long inhalation during the winter months when the outside air is cooler than 54 degrees, and an equally long exhalation when the outside air is warmer. It apparently holds its breath during the periods when the outer and inner temperatures are balanced.

At the brink of this great hole in the earth my companion and I stopped and looked at each other. Would we catch the Louisville station? Well, . . .

Descending the long stairway we proceeded into the cave, deeper and deeper. The winds were blowing stronger, but we soon found that when the entrance had been well passed these currents ceased, or at least, were not perceptible to our faces.

The guide had lighted lanterns, and as we moved forward along a narrowing passageway, not a little awed by the strangeness of the place, I said in half a whisper to my companion:

"Hope we'll get WHAS through all this."

With characteristic cheerfulness, he answered in the words of Dante:

"All hope abandon, ye who enter here."

About six hundred feet from the entrance, we emerged into the sublime Rotunda, with its arched ceiling sixty feet above the floor, unsupported by columns although its widest span is about two hundred and seventy-five feet across. We were standing now 360 feet directly below the hotel in which we had slept

the night before. Near by were the remains of wooden vats where in 1811 and 1812 lime nitrate was made in solution and syphoned through a crude log pipeline to the entrance there to be made into saltpeter, and thence "waggoned" across the mountains to Philadelphia for the manufacture of gunpowder.

Our watches told us that in three minutes WHAS would be on the air. We searched hastily for soil free enough from rock to drive down our iron ground-spike, and it is no wonder if our fingers trembled a little as we adjusted the instruments

and made ready to tune-in.

The guide watched us with large eyes. He did not understand these "goings-on." Although we had told him our mission—that we were there to see if we could hear music being played by a band in Louisville—he refrained from comment.

For ten minutes we listened intently, tuning this way and that. But not even a suspicion of a band in Louisville, or anywhere else, was noticeable. There was no static. There was no anything. Our earphones were as silent as the blackness around us. We had failed.

This being undeniable, we then looked for the cause of our failure. The instruments were in perfect adjustment. The aerial was the same that we had used with success the night before on top of the earth. Either the ground connection was faulty or radio waves would not penetrate Mammoth Cave. This conclusion led to a minute inspection of the soil.

Here, indeed, could readily have been the trouble, because the iron spike had penetrated a substance as dry as powder. Holding our flickering torches lower we could find no symptom of moisture anywhere; all was finely pulverized limestone dust, so light that it could be crushed in the hand and blown as easily as flour. Surely we might as well have had no ground connection as this.

We turned to the guide then, explaining the trouble and suggesting that we go on to a place where we could find moisture. We threw in a few technical terms to impress him, but



he was not at all impressed. He picked up his lantern in a leisurely way, adding now to his former polite tolerance a frankly amused smile. But, after all, who could blame him? He had guided in that cave for twenty-five years. He knew as much of it as any living man, and in all that time he had never heard any music down there, unless somebody sang or whistled. Appreciating his point of view, it is really a wonder that he did not shove us into the Bottomless Pit for a pair of escaped lunatics. At any rate, if it was moisture we wanted he intended to see that we were plentifully supplied. He said as much, and we moved forward into one of the passages leading from the Rotunda.

A quarter of a mile farther found us squirming our way like rats through the Corkscrew that eventually leads to a level eighty feet below. Another quarter of a mile brought us to the Great Relief, a spot well named in the opinion of one who carried parts of a delicate receiving set through such a tortuous climb as the Corkscrew.

Here we would gladly have made another test, as it lacked but ten minutes of the hour for transmitting, but there was no adequate place for driving our spike. And the Dead Sea, farther on, lay fifty feet below the ledge on which we were traveling. In another hundred yards, however, a good place appeared—but, alas, our watches told us that WHAS had signed off a minute before. There would be an hour to wait.

The guide did not seem to be at all affected by our disappointment. He merely suggested in his tolerant sceptical way that we should go on to Echo River and “listen to the echoes of the Louisville band there.”

So we proceeded along the Great Walk. For nearly a mile we slipped and staggered over loose stones, fearful of an accident to the vacuum tubes. The time for the next concert was approaching, yet there was no place discernible for driving our rod. The way became more hazardous, because the floor now sloped sharply off to one side, and once I not only fell but

slid toward a hole that seemed to be blacker and deeper than any abysmal pit in the entire cave. My companion made a frantic grab and checked me just as I was slipping over the brink. Only the guide remained imperturbable, and soon assured us that what we had thought was a yawning chasm was only a ledge about six or eight feet deep.

“Granting all that,” I replied, as gently as I could, “a headlong plunge of six or eight feet on rocks even as soft as limestone might have shaken up our instruments. And even a radio operator isn’t tough enough to stand that sort of thing.”

He may not have believed this, but he laughed pleasantly and said that “maybe the hole warn’t more’n four or five feet, anyway.” So I let it go at that. But we had lost another opportunity of catching our home station.

Soon we passed through the section of the cave called Purgatory—a name too mild, by far—and then came to the famous Echo River, with its eyeless fish and white crayfish. Tied to a slippery landing was a flat-bottomed skiff into which we deposited our instruments and pushed off.

It would be nearly half an hour before the next WHAS concert, so we left ourselves to the guide’s slow paddling over the hushed water. The arched ceiling, varying in height from five to thirty feet, was a mass of sparkling drops, apparently ready to fall, gorgeously re-



“BOOTH’S AMPHITHEATRE”

With some of the old saltpeter vats at the right

flecting the flames of our lamps. Outside, Green River was low, and therefore Echo River was low. It was remarkably transparent, too, giving one the feeling that the clumsy boat was, by some magic, being floated upon air.

The time was approaching for another radio concert, and we began to prepare for it. Here, with the very best of ground connections—by letting down our iron bar to the bed of the river—we felt sure of success.

Both pairs of phones were on our heads when the hour came. We listened. We tuned. We listened again, and again we tuned. The disappointment on our faces was reflected in the sceptical smile of our guide. But the test was not all failure this time, because we caught the clear, sharp whistle of the WHAS carrier wave. That was all, however; and when the time was up this abruptly ceased.

Once more we began diligently to investigate the cause of this partial failure. We had achieved something by catching the carrier wave. But, if the carrier wave, why not the voice and music? We finally hit upon a reason—certainly plausible, and one that after events strengthened. In our position on Echo River, with roof and sides simply dripping moisture, we were as a matter of fact sealed within a

thoroughly wet apartment—as though in a diving bell on the ocean bed—and the electromagnetic waves were sponged out by this condition. Our receiving set and aerial were being insulated from the WHAS wave as effectually as if they were in an iron box with all parts grounded, for everything about us—top, sides, bottom—was grounded by the saturated condition of the rocks and soil.

It required courage to tell the guide that our failure this time was due to *too much* moisture!

We had left the hotel about ten o'clock in the morning and it was now after three. The regular afternoon concert would begin from WHAS at four, and if we did not catch anything then we would have to wait until half past seven, as nothing had been arranged between this and the night concert hour. So we chained the boat to its landing, took up our packs and started in search of another promising spot.

It seemed that we had walked nearly a mile when, immediately at our feet, the flickering lamps showed a moist spot in the soil. This looked hopeful because the ceiling and walls were dry, and with good cheer we drove down the iron spike as far as it would go. The loop aerial, too, was set, our compass giving us the direction of Louisville.

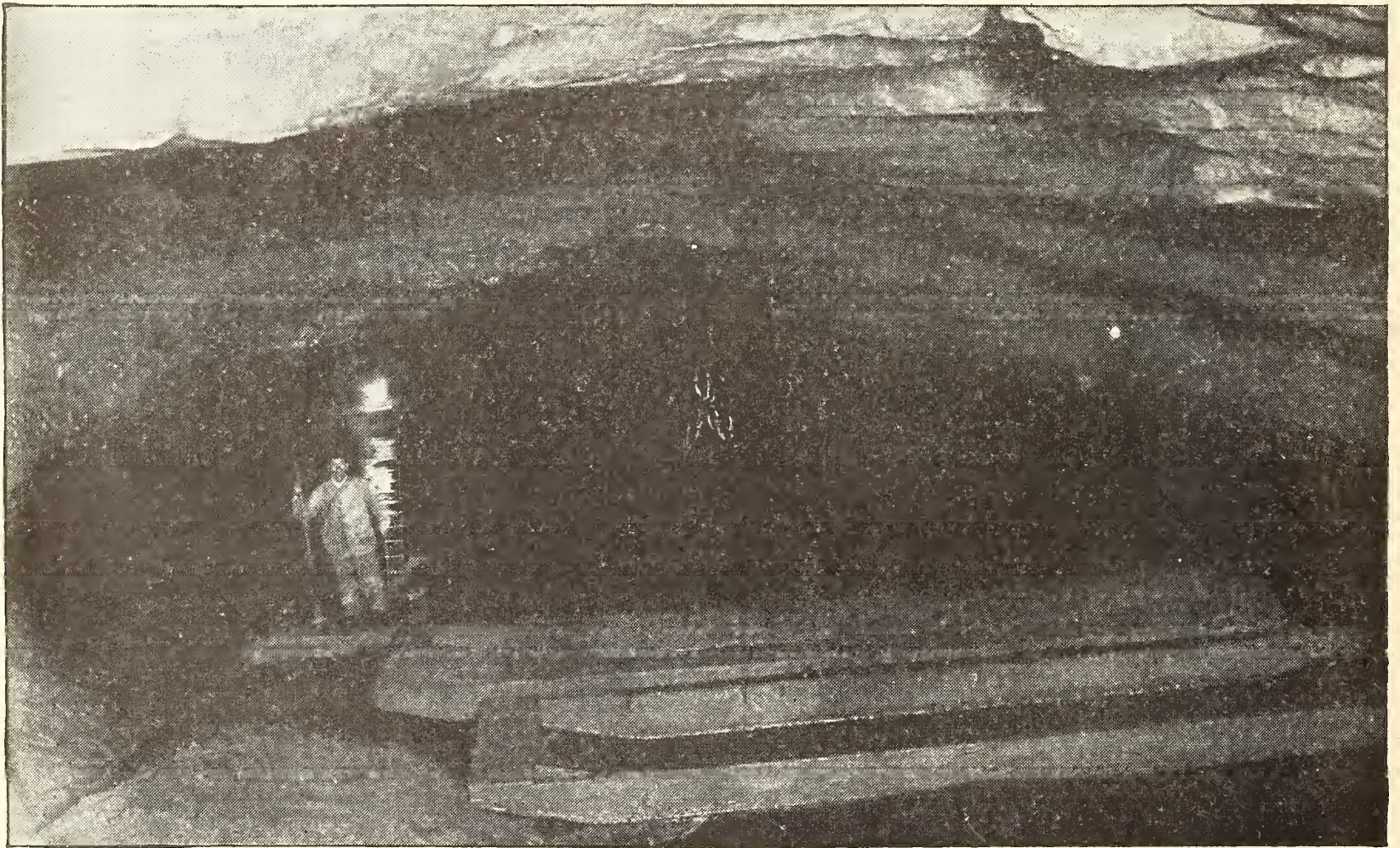

ECHO RIVER, FAR DOWN IN MAMMOTH CAVE  
Where the author's second attempt to receive signals from Louisville was made

Four o'clock came, and with earphones in place we tuned. Without a moment of hesitation, a strong, clear voice came to us, saying:

"This is WHAS, the radiophone broadcasting station of the *Courier-Journal* and *Louisville Times*, at Louisville, Kentucky. WHAS, at Louisville, Kentucky, is sending out its usual afternoon concert."

The first number was announced, and then came the music as vigorously as though we had been in Louisville. I leaned quickly over and slipped the phones on our guide's head. With a cry he sprang back, making a gesture as if to slap them off. But we steadied him, and thenceforth he was both an amazed and a

happy man. Although we could hear the music quite six feet away from the phones, we let him keep that pair to his ears. For the entire hour he listened in rapt attention.

CONCLUSION: This spot was, according to our guide, about a mile from the entrance, and 370 feet below the surface. We had successfully carried out the first radio test ever made in Mammoth Cave. Moreover, to WHAS goes the distinction of being the first broadcasting station ever received within the Cave. It may continue to be so for a long time, as a matter of fact, because after it had signed off we tried diligently to get other stations which we knew were on the air, but could not bring in even their whistles.

# What You Should Know About Antennas and Grounds

By R. H. G. MATHEWS

Chief Engineer, Chicago Radio Laboratory

THE purpose of a receiving antenna is perhaps more often misstated than that of any other device used in connection with radio. To understand just what a receiving antenna does, let us consider for a moment the form in which radio energy is transmitted. In the first place a radio telephone or telegraph transmitter simply radiates energy in an all-pervading medium called the ether. Electrical energy, as such, is *not* radiated by a radio antenna.

One of the most popular analogies to a radio transmitter is the old but serviceable example of a stone dropped into a pool of water. A chip floating in the pool is agitated by the ripples or waves set up by the dropping of the stone. No part of the stone is transmitted from the point at which it is dropped to the chip. The energy, however, acquired by the stone in dropping is transformed into wave motion in the water, a portion of which in turn is communicated to the chip, causing it to move. In a radio transmitter, the energy generated in the station produces a series of disturbances in the ether, which travel out in expanding hemispherical shape *in all directions*.

You who studied, or even merely took physics, remember that the principles of opera-

tion of an ordinary direct-current generator are summarized in a rule which runs like this: "When moving conductors cut lines of force, electrical energy is produced."

In a radio receiving antenna we have a somewhat similar condition. We have, in place of rotating conductors, an antenna of one or more wires, and we have, "cutting" this antenna, the incoming radio waves, which correspond to the magnetic field or lines of force mentioned in our generator rule. Here we have a fixed conductor with a moving field, which gives us nearly the same effect as in our generator, and accordingly we have in our receiving antenna the vibration energy of the ether wave transformed into electrical energy again.

## OVERCOMING ANTENNA LOSSES BY PROPER INSULATION

THE novice, in installing a set, considers that almost anything in the way of a wire stuck up on his roof in the most convenient manner is a satisfactory antenna. As a matter of fact, the antenna is one of the most important features of the receiving installation. If the infinitely small amount of energy collected on the antenna is subjected to all kinds of losses before it ever reaches the receiving set, how can



#### A GOOD ANTENNA IS EASY TO ERECT

Make it 75 to 150 feet long including the lead-in; insulate it at both ends

the average receiving set compensate for these losses? We would do far better, in many cases, if we would preserve more carefully the energy collected by our antennas. Then we might achieve the same result with less amplification, and hence with less possibility of distortion.

#### ANTENNA INSULATION

THE greatest source of loss in the average antenna is in its insulation. An antenna of any kind may be regarded as a condenser. Any condenser consists of two conductors having between them an insulating material known as a dielectric. In the case of an antenna, the air acts as a dielectric between the antenna and the ground. The fact that a composition of some kind is a good insulator does *not* mean that it is a good dielectric material. Receiving antennas handle very low voltages, and consequently we do not have to worry about our insulators from the standpoint of voltage break-down, but, unfortunately, manufacturers of antenna insulators usually consider only what is necessary to avoid a voltage break-down when they design their insulators.

Porcelain and glass are comparatively good insulators, whereas moulded compositions are relatively poor. Pursuing our idea of the aerial

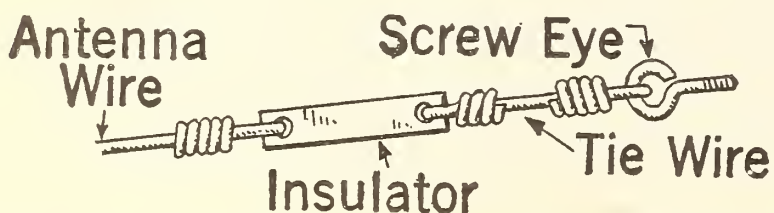

HOW TO ATTACH THE FAR END OF THE ANTENNA

as a condenser a little further, we would hardly build any condenser with a heap of miscellaneous junk under one end, a coal shed under the other end, a few trees somewhere in the middle, and various other structures along the line. The ideal antenna should have as few obstructions as possible between it and the ground. Trees, buildings, and other obstructions are sure to cause losses in antenna efficiency.

It is frequently impossible for us to find a clear space to put up an antenna. If this is the case, we must then raise our antenna wire as high as possible over obstructions that we cannot eliminate. For this reason, an antenna on an apartment building should be as high above the roof as possible, and it will be found that an increase in height even at a sacrifice of length will secure better results.

#### ANTENNA LENGTH

THE influence of the length of a receiving antenna on reception is frequently exaggerated. Many users of receiving apparatus believe that to increase the signal strength, one has only to lengthen his antenna. This is not necessarily true. An antenna of a given length has a certain natural wavelength of its own, and with the average receiving set the wavelength of the aerial should be somewhat below that of the wavelengths of the various stations which are to be received. There is a point at which extension of the antenna adds so much to its capacity and inductance that its inherent wavelength becomes greater than that of the stations from which reception is desired. Our receiving set, therefore, will not function properly on such an antenna without a condenser in series with the antenna to cut down the wavelength of the aerial to a point where reception can be accomplished satisfactorily. It has been found that with the average radio-phone receiving set now on the market, an antenna about 125 feet long is to be recommended. The length of the lead-in is included in the length of the antenna proper. No allowance has to be made because of the fact that the lead-in is generally made of insulated wire.

A single-wire antenna is generally as good with the average receiving set as a multi-wire one, and it is generally found that a single-wire antenna will give somewhat sharper tuning

and consequently greater selectivity and elimination of interference than an antenna of more than one wire.

It has been found by the writer that in many

the wavelength to which the antenna is tuned, which counteracts a certain amount of the resistance or loss in the antenna. This theory is only applicable to the regenerative or oscillating

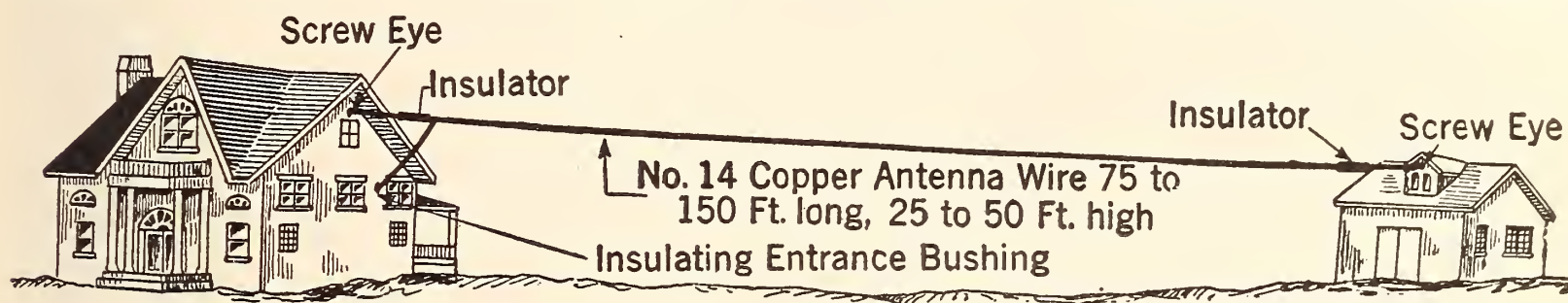

THIS ANTENNA INSTALLATION WOULD STRAIN NEITHER ARM NOR POCKETBOOK

The lead-in may be soldered to the antenna, but it should not merely be wrapped around it. The best way is to have the lead-in actually a continuation of the antenna wire itself

cases where interference from amateurs and ships is complained of bitterly, the trouble is due primarily to the use of too long and too complicated an antenna system, which absolutely prevents selective tuning of the receiving set. When the complicated antenna is eliminated and a short single wire substituted, the interference usually disappears entirely.

#### THE USE OF REGENERATIVE RECEIVERS

IT IS claimed by many radio engineers that the losses outlined in the preceding paragraphs are to a large extent neutralized when a regenerative receiver is used. That is to say, a regenerative receiver will function better on a poor antenna than will any other type of receiver, the argument in favor of this belief being that in a regenerative receiver, when the set is in proper operation, the tube is feebly oscillating; that is, when the set is brought up to the point of maximum signal intensity, just before the point of full oscillation—the antenna is absorbing a certain small amount of energy from the tube through the receiving set. This can easily be proved in the case of a regenerative receiver having an aperiodic or non-resonant primary circuit, by the fact that if our regenerative receiver is adjusted to the point of maximum sensitivity, and the antenna then is disconnected, the set will break into full oscillation, demonstrating that the antenna, when connected, is absorbing sufficient energy to keep the tube from oscillating freely. This energy is naturally being absorbed by the antenna at the wavelength of the incoming signal, since that is the wave to which the receiver is tuned. Since this is the case, we are creating in the antenna circuit negative resistance. That is, we are feeding in a certain amount of energy on

type of receiver. There are good grounds for believing the theory to be a true one.

#### NON-RESONANT ANTENNA CIRCUITS

WHILE it is necessary in nearly all receivers to adjust or tune the antenna circuit (which is the inductance and capacity in the antenna circuit of the set) to the wavelength of the incoming signal, there are on the market several sets which require no antenna tuning. In these sets the antenna circuit simply collects the received energy which is then transferred to the secondary coil of the receiving set at whatever wavelength the secondary may happen to be tuned.

#### CONCERNING GROUNDS

ALONG with the study of antennas we cannot neglect that of grounds. A great many receiving troubles blamed on the radio receiving set are actually due to a poor ground. The mere connection of a wire to a pipe which leads eventually into the ground, does not make that connection a good radio receiving ground. Our ground lead is subject to the same losses in somewhat lesser degree as our antenna and lead-in. It is generally desirable, especially where a long ground lead is used, to insulate the ground lead with porcelain or glass insulators just as we did our antennas. A water pipe in the average apartment is generally a fair receiving ground, as it goes more or less directly to the basement, and then into the ground. The connections in water pipes are generally tight. Steam pipes are usually poor grounds, as they go in a very indirect way to the ground proper. The ground connection here is usually made through the steam radiator pipes to the boiler, and through the boiler to the water pipe which



#### AN APARTMENT-HOUSE ANTENNA INSTALLATION

This shows a good way to bring the lead-in through the rear court. The farther from the building the lead-in is kept, the better

supplies the water from which the steam is made. Frequently steam or hot water pipes have non-metallic joints to allow for the expansion and contraction of the pipes under various conditions of temperature. Such pipes should never be used as ground connections. Gas pipes are similarly poor, because the gas meter usually is equipped with an insulating joint, which effectually insulates the house pipes from the incoming pipe which is the true ground.

Above all these is to be preferred the outside ground. However, by this is not meant a  $\frac{1}{4}$ " galvanized iron rod driven two feet in the ground. By an outside ground is meant a sufficient metallic surface buried in the ground, deep enough in damp soil to insure a low resistance ground connection. A copper plate 4 feet square is an excellent contact ground if buried sufficiently deep. Driven rods are generally not desirable because of the small amount of surface in actual contact with the earth. The amount of surface in direct con-

tact with moist earth is of the utmost importance.

Another type of ground which is very desirable may consist of several wires, each 25 or 30 feet in length buried radially or in fan shape out from the ground lead. These wires should be buried no less than two feet deep and preferably in damp soil. As many of them should be used as is possible.

The ground lead itself may be of insulated or bare wire, and to conform with the requirements of the Fire Underwriters, should be of copper and of no less size than No. 14, B and S gauge. The ground wire should be as short and run in as direct a line from the receiving apparatus to the ground as possible. The shorter the ground lead, the longer the antenna and lead-in can be without giving the aerial and ground system excessive wavelength. Naturally, the longer

our antenna and lead-in are, still keeping below the wavelengths on which reception is desired, the better our reception will be.

The directional effect of an antenna system is a thing that generally worries the beginner in radio. As a matter of fact, the directional effect of the average receiving aerial is almost too small to be measured, and it is therefore something over which we should not have the slightest concern. If we stretch our antenna over as clear a space as possible, running the wire in a straight line, supporting it on porcelain or glass insulators and bring our lead-in down from it in a direct and short line, supporting it also in the same way with the same type of insulators, and if we keep the length of our aerial within the limit outlined in the foregoing and if we get it as high as we possibly can, and then make a good ground connection, we should have an efficient installation. When we introduce complicated antenna systems, we also increase the possibility of loss.

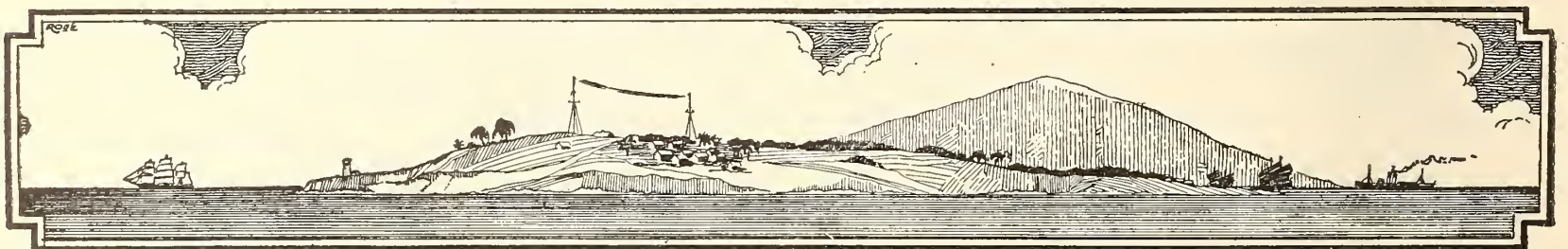



THE MISSOURI STATE PRISON CONCERT BAND

## When the Prison Band Goes on at WOS

How the Missouri State Prison Musicians Captivate Their Radio Audiences to the Extent of 2000 Letters a Concert, not to Mention Sympathy, Cigars, and Cigarettes

By J. M. WITTEN

Announcer, Station WOS

**I**F IT has been your good fortune to tune-in one of the delightful concerts of the aggregation known as the Missouri State Prison Band I know that you have been well repaid; and that you still had your head-set on, or the loud speaker going, when the blowing of Taps—the last feature on an M. S. P. B. program—was rendered.

This band broadcasts every other Monday night at nine o'clock (C.S.T.), from WOS, Missouri State Marketing Bureau, Jefferson City, Missouri. The broadcasting equipment at WOS is a 500-watt Western Electric installation in the dome of the State Capitol. It is a Class B station, transmitting on 441 meters or 680 kilocycles. The concerts by the band have been distinctly heard and greatly enjoyed, according to reports, in Honolulu, Hawaii, Alaska, Cuba, Santo Domingo, Porto Rico, Newfoundland, British Columbia, every province in Canada, several states of Mexico, every state

in the Union and ships in the Atlantic, Pacific and Arctic Oceans and the Caribbean Sea.

This organization has very probably received more radio mail in appreciation of its efforts than any band or similar organizations in the country, as the mail following each concert had averaged two thousand cards and letters. Eighty telegrams and forty-five long-distance calls have been received during a single concert.

In addition to the cards and letters of appreciation on the entertainments, the "boys" of the band are the recipients of hundreds of "tailor-made" cigarettes and cigars which they would otherwise be unable to procure.

Many of the letters and cards offer help and consolation to the boys. Letters from welfare workers are not uncommon and are generally offers of assistance. A certain member of the band, by his beautiful rendition of a solo part, aroused the interest and sympathy of a welfare

worker. She addressed her letter to the announcer and wanted to know what crime he was confined for, about his appearance, age, family, and did the announcer think he would make good when discharged. I promptly replied to her letter answering all the questions possible, and I know from talking to this prisoner that she is making necessary arrangements to assist him in making a fresh start in life upon his discharge.

Another member has secured a position in a community band in western Kansas, because he favorably impressed the band-master, over the radio, with his ability.

Many telegrams read like this: "Take the band out of jail—they ought to be in heaven"; "If I were governor of the state I would open the gates of the prison to them tonight after their wonderful concert"; or "Buy the boys a box of cigars and send me the bill." And then there is the millionaire banker's daughter somewhere in Arkansas, who, according to one of the cornetists, sends him cigarettes, candy, etc.

During a concert, the "boys" have a spirit that goes far toward putting a program over in fine shape, and a willingness and obedience that are hard to find elsewhere.

The "boys" of the Missouri State Prison Band have been convicted of about all kinds of crime from embezzlement and burglary to

murder, and the sentences imposed on them are from two years to life.

They were recently given a complete receiving set with loud speaker by a large Chicago radio jobber, and they have derived much pleasure from listening-in to the outside world. Ninety per cent. of the members of the band had never heard a radio concert themselves until the set was received by them but had played and furnished entertainment for many thousand radio fans.

Because of the small size of our studio—fourteen by seventeen feet—the band that regularly furnishes the concerts from WOS is cut down to nineteen members and a band-master. The man who has made the prison band concerts possible is the warden of the Missouri State Prison, Judge Sam Hill, who takes a very warm interest in the welfare of all the boys, especially the prison band, and his first words when he meets the station staff are: "How many did we get on the last one?" referring to the number of letters and cards received on the last radio concert by the band.

The station force at WOS is probably the smallest station staff in the United States operating a Class "B" station. It is composed of Arthur T. Nelson, Commissioner; R. J. Engler, Chief Engineer; and J. M. Witten, Announcer and Program Director.

#### THE OPERATING ROOM AT WOS, JEFFERSON CITY, MO.

At the desk is J. M. Witten, Announcer and Program Director. Behind him is R. J. Engler, Chief Engineer of the station

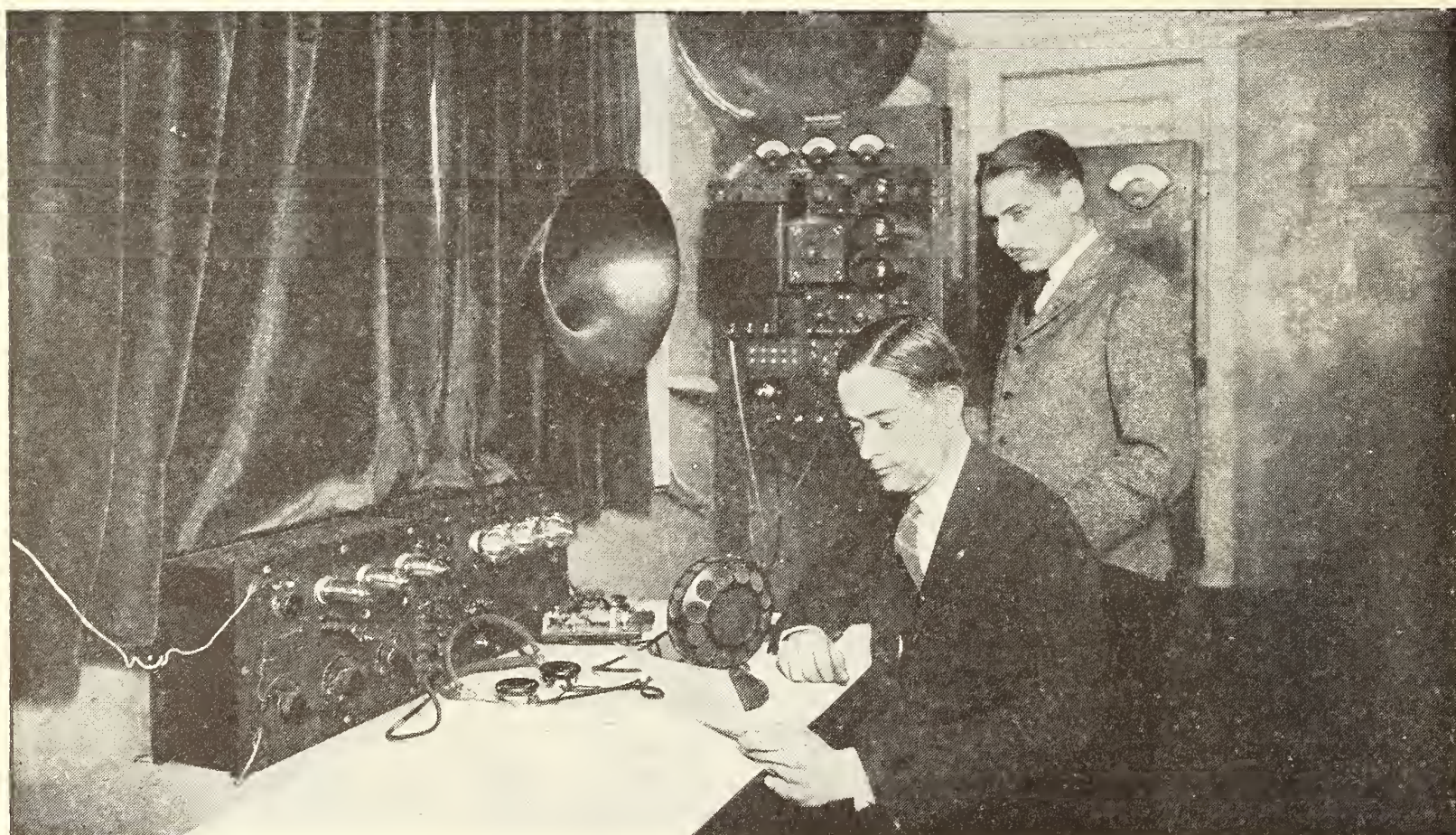





RADIO ON WHEELS

Here is a six-tube Murad radio-frequency receiver, with the loop inside the door under the handle. The loud-speaker operates behind the cane front. When a station has been tuned-in, the leaves can be folded and all apparatus concealed

## The Aristocracy of Radio Receivers

**W**HILE there are still in use plenty of unprepossessing and shy crystal receivers and many "ham sets" composed of little more than the conventional rubber boot and tin can, an aristocracy of receiving sets is emerging from the common horde of inductances and capacities, tubes and jacks, and what-not.

The most casual and disinterested observer at the recent New York radio show was struck by the many fine examples of receiver design and resplendent cabinet work. Many an enthralled amateur stopped before these beautiful sets, lost in the last stages of what the newspaper reporters love to call "open-mouthed wonder."

The radio manufacturers have found that there is a market for self-contained sets, well

built and finished with all the care of a sonorous piano. The perfection of the loop antenna and the wide use of amplification—radio and audio—have made self-contained sets possible.

So, with the aid of the cabinet manufacturer, certain types of radio receivers have come to be designed more as pieces of fine furniture—to decorate fine rooms—than as rough and not too-efficient pieces of experimental apparatus, curiosities which had their proper place in some inconspicuous corner where a mess of wires, tools and parts was not objectionable.

Many of the receivers made for "discriminating purchasers" require an outside antenna and ground, but generally have their operating batteries and tubes installed in the cabinet itself. Several sets have been built which operate from loop antennas attached to or within the cabinet.

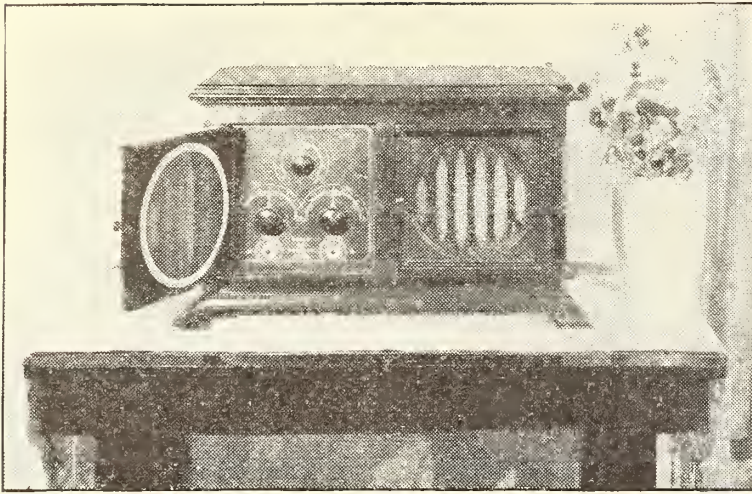

#### OPEN FOR BUSINESS

Here is the compact and well-built Radiola IV. This is a three-tube set. And it adds to, instead of detracts from, the appearance of any room

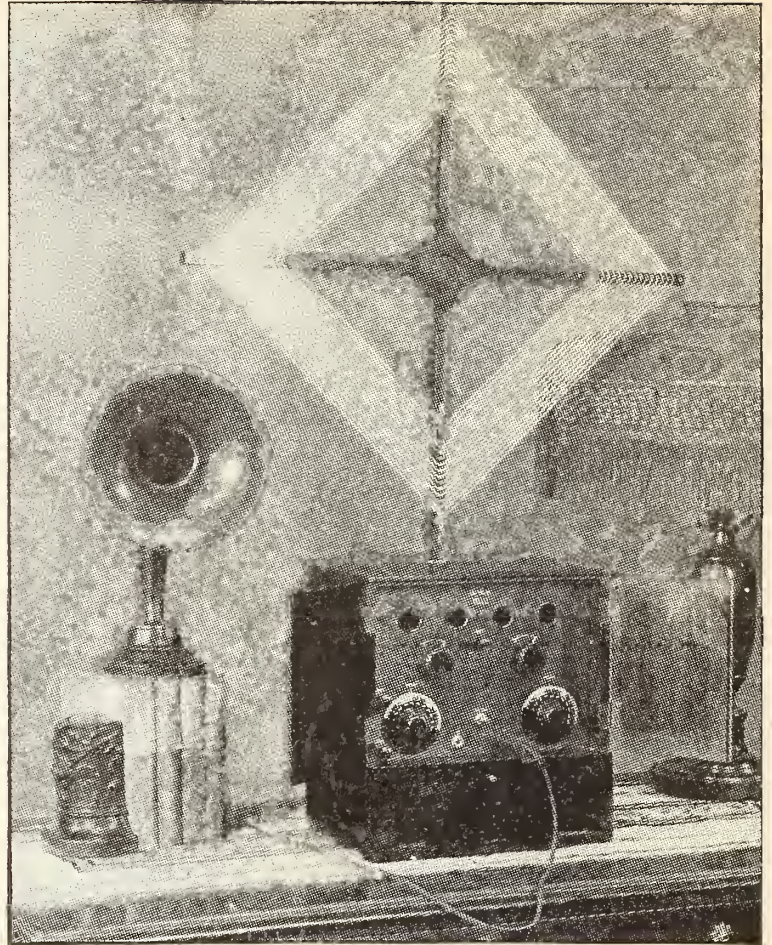

#### THIS FITS ON ANY LIBRARY TABLE

Or on the crude boards of a camper's lean-to. It is a De Forest D-10 four-tube reflex set, using dry-cell tubes

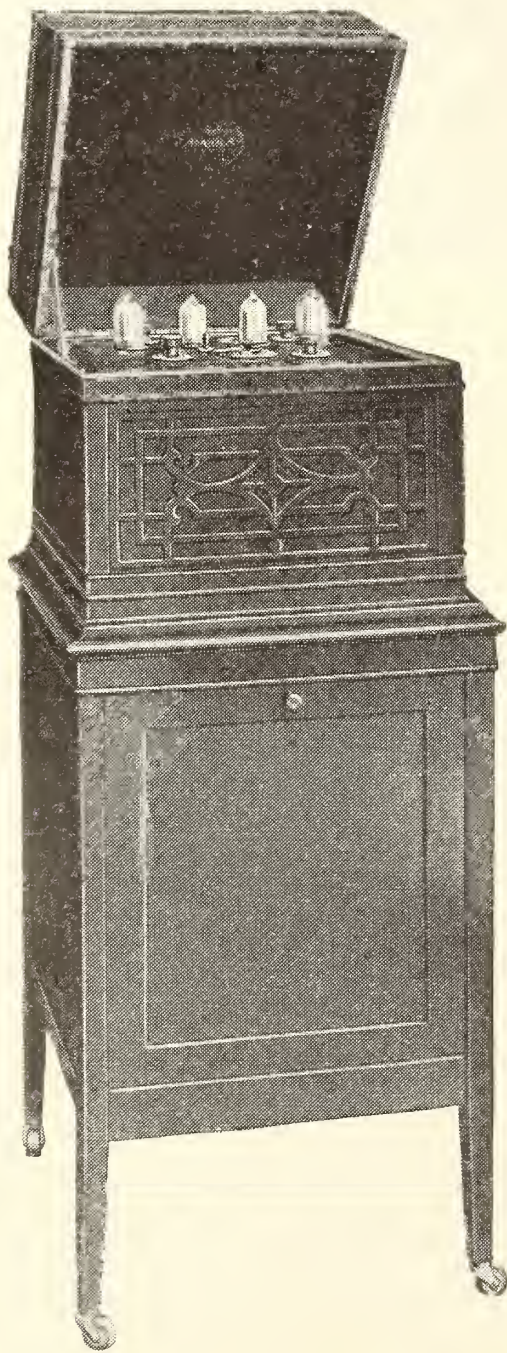

#### "HIS MASTER'S VICE"

Here is an upright type of receiver, looking suspiciously like a phonograph. It uses an outdoor, or "open," antenna



#### A RECEIVER FIT FOR A KING

A Zenith-Brunswick model which would grace any regal tiring-room (you know, the place where the king could put his feet on the table). All trace of radio apparatus has been cleverly concealed

There are *de luxe* receivers large and small. One may purchase small cabinets which will blend perfectly with library furniture or "go" nicely on a table. There is one receiver built in a standard unit of a sectional book-case, another which looks precisely like a tea-wagon and can be used as one. Perhaps the most popular type of expensive and decorative receiver is built in cabinets very much like those used for phonographs. These types range from the rather modest small size shown in an accompanying illustration to the large console type with rich and elaborate cabinet work.

Many of these receiver cabinets are useful as well as ornamental. The most unusual and striking example is the tea-wagon type, but sets are being built into fine tables, which have obvious uses.

Fine hardware is being used on these *de luxe* sets—one receiver has heavily nickled piano hinges along the full length of its cover. The advantage of this refinement will be appreciated by those who have labored long and impatiently to replace screws which have worked loose on small cheap cover hinges.

*De luxe* receivers have a sound appeal to any

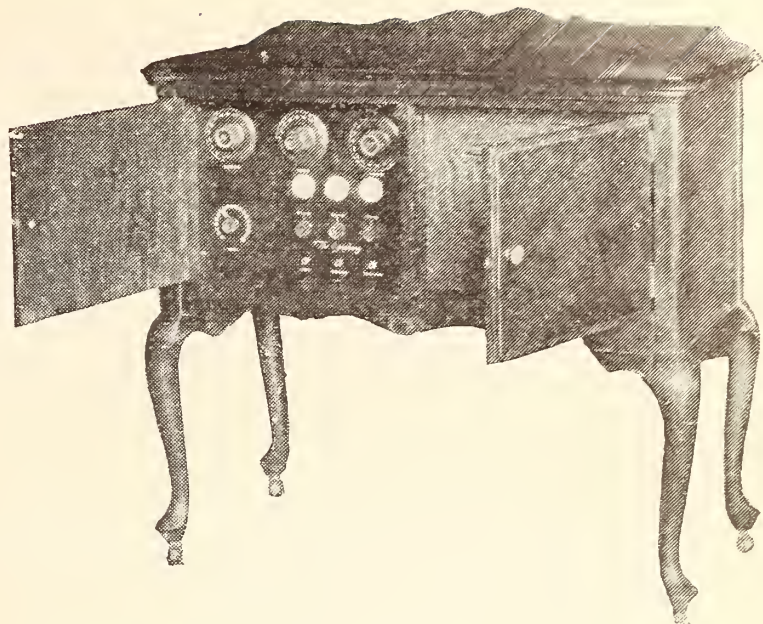

"AND WHEN THE DOORS WERE OPENED. . . .  
"The birds began to sing." Any tired broadcaster should perk up at the thought of being received by such a set

"radio prospect" who does not want to experiment with radio, but who wishes a receiver, attractive in appearance and efficient and dependable in operation. As Christmas presents many of these receivers would make rich and unusual gifts.



## A GOOD BOOK ON RADIO

FALL has passed and winter has arrived, yet apparently we are not to be deluged with such a flood of "popular" books as inundated the country a year ago. Many of the books which the fond parents of them christened "popular" didn't become nearly so popular with the public. As a matter of fact, there was a great deal of trash dumped on the market, stuff written by people who know neither radio nor writing; the familiar sentence to the effect that a certain book "had been used in training radio officers for the war" made us wonder just how much these poor officers really knew about radio after graduating from their courses.

Having in mind this type of radio "literature," it is a relief to see the appearance of a simple book on radio, written in an interesting style, by an engineer who knows radio well, both theoretically and practically. *The Outline of Radio*, by John V. L. Hogan, a radio engineer who has been one of our contributors in the past, and from whom we hope to have more articles in the future, is a well-written book, giving the story of radio as it should be presented for the layman. Those who are beginning the study of radio will do well to start with Mr. Hogan's book.

-THE EDITOR.

# A Simplified Super-Heterodyne

By A. J. HAYNES

Vice-President, Haynes-Griffin Radio Service

Mr. Haynes has distilled the results of twenty experimentally built super-heterodyne sets into this one article. He gives complete information regarding parts and prices and directions for assembling the set. The first night this set was tried out in the RADIO BROADCAST laboratory, WHAS, in Louisville, Ky., and the three Chicago stations came pounding in, too loud on one stage of audio for comfort. WHB, in Kansas City, came in loud enough to be heard a block away. The antenna system was a two-foot loop which cost one dollar. Experimenters who are capable of building a receiver such as Mr. Haynes describes, will, we are sure, be more than satisfied with the results. It certainly does "deliver."—THE EDITOR.

**T**HE super-heterodyne system of radio reception has received so much publicity, praise, and explanation since its development by Major Armstrong during the World War that it hardly seems necessary to discuss further its merits and theory of operation. It is without question the closest approach to the ideal receiver that we have to-day. The operation of this circuit is simplicity itself, provided of course, that the electrical design and mechanical construction are correct. When tuning in distant stations it is even easier to operate than the single-circuit regenerative receiver! This sounds like a broad statement to the radio fan

who has never operated such a set, but as a matter of fact, a properly designed super-heterodyne may be built with but two tuning controls, neither of which is critical.

Right here it might be well to point out the distinction between *critical* tuning and *sharp* tuning. Critical tuning is not desirable whereas sharp tuning is a most decided asset to any receiver. A critical control is one which goes in or out of adjustment with a hair-breadth movement of the tuning dial. A good example of this is the ordinary regenerative receiver when used with maximum regeneration or, as we say, on "zero beat" adjustment. Such a circuit has very critical control on long-range reception

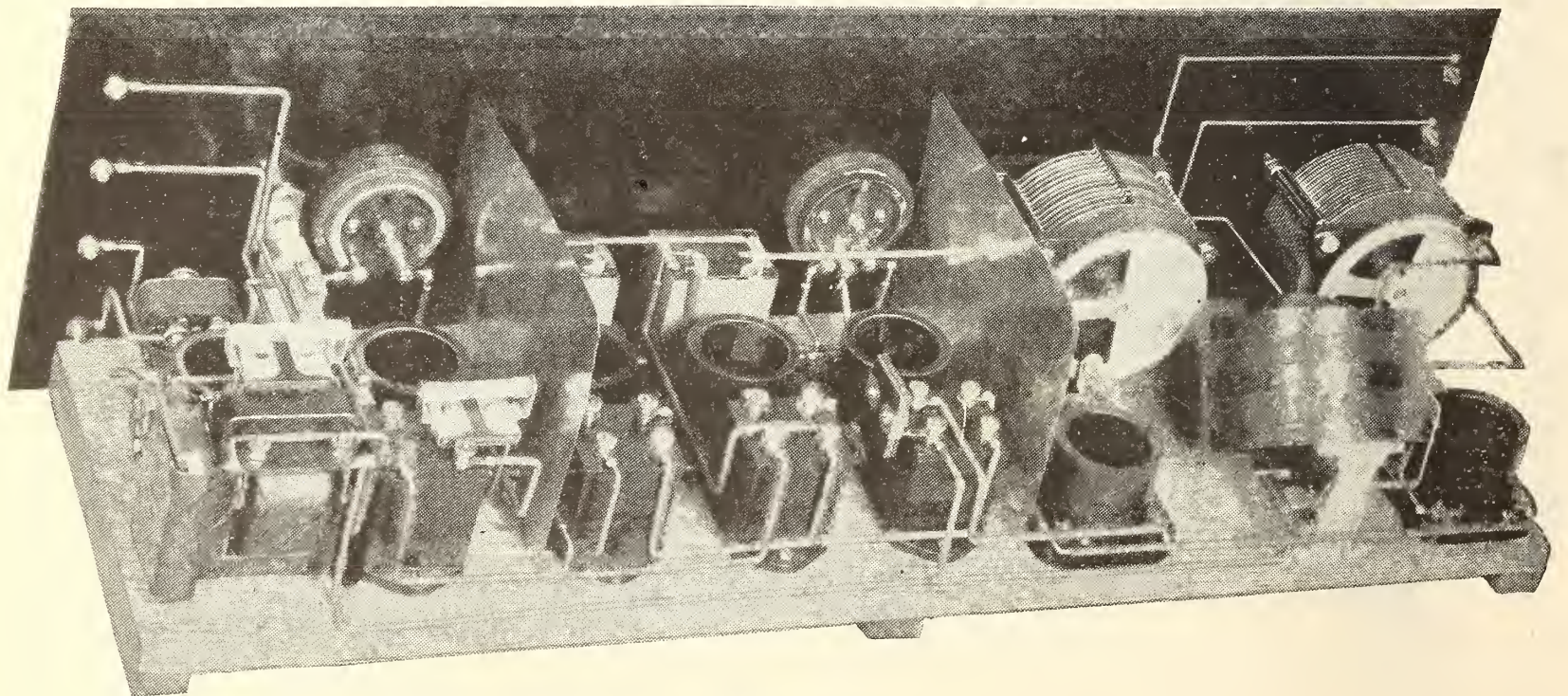

FIG. 1

This set was found to be the best after twenty had been built. Two straight shields for the radio-frequency are used. With a two-foot loop this set will bring in stations 1000 miles away with great volume. The front of this panel is shown in Fig. 9

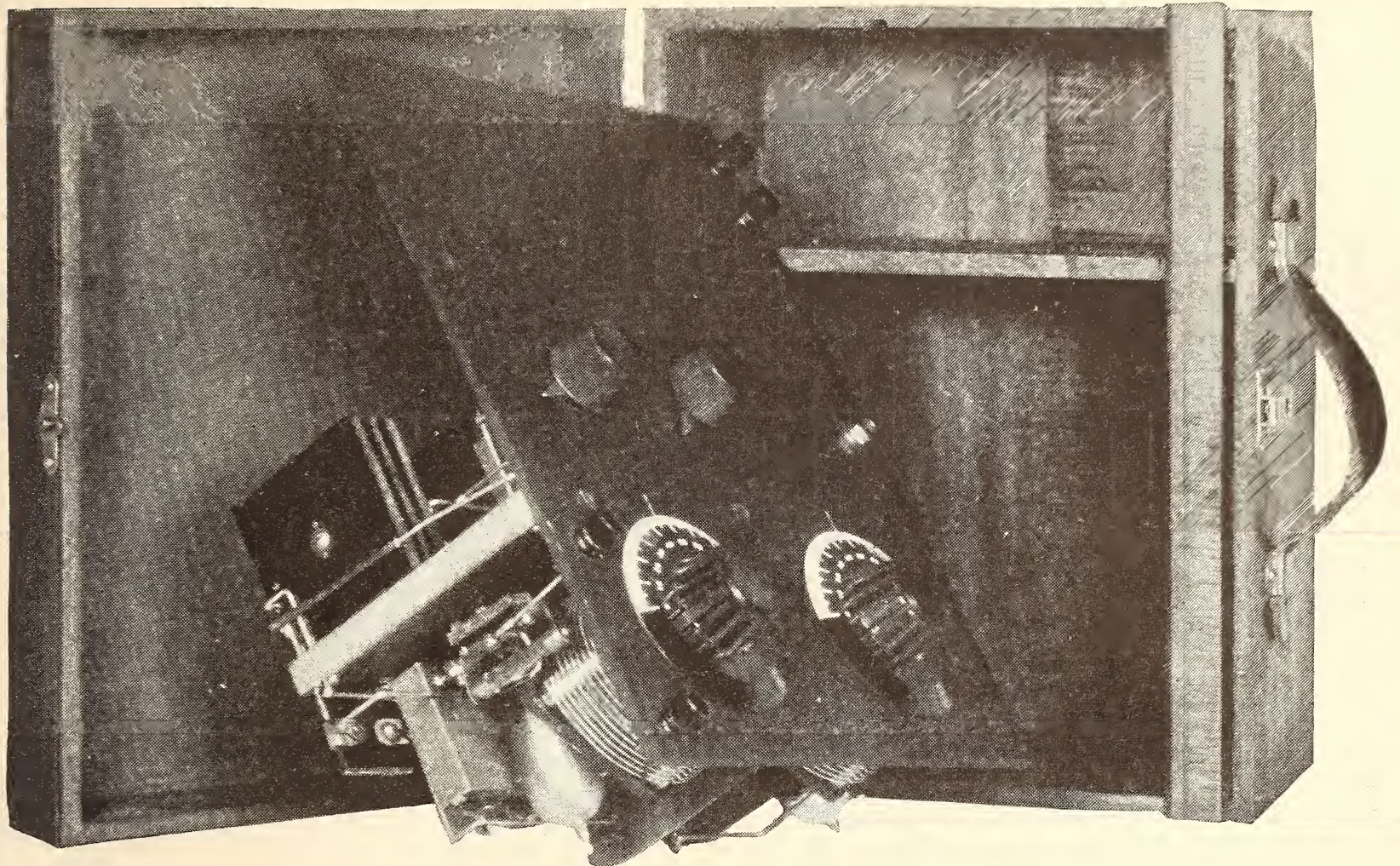

FIG. 2

A small portable super-heterodyne set with one stage of audio amplification. Its compactness is remarkable. Note the foot rule at the right of the case, near the handle

and yet may be so broad in its tuning that it is impossible to eliminate the local stations.

The super-heterodyne possesses the very desirable characteristic of being extremely sharp in tuning, and not at all critical. As the two dials—tuning and oscillator control—are moved up or down the scale in unison, the various stations, both local and long distance, come in and go out, one after another, distinct and separate from each other. Moreover, *the settings on the oscillator dial do not vary, regardless of the type of antenna or loop with which the set is used.* Thus a chart may be kept of the oscillator dial settings of all stations heard so that they may be tuned in immediately at any time. These settings vary a little, however, with different tubes and a new set of calibrations is necessary with each new tube used in the oscillator.

#### DESIGN AND CONSTRUCTION

WHILE a good super-heterodyne is a very simple set to operate, the layout of the apparatus and mechanical difficulties encountered in its construction—particularly when it is assembled as a single unit—make it a rather difficult receiver for the average layman to con-

struct, unless he has some mechanical skill and is familiar with radio wiring practice.

Therefore, I am writing this article, not to give A.B.C. instructions to the layman for building a super-heterodyne, but to assist the radio experimenter who is capable of doing design work for himself and is at least able to comprehend a schematic diagram and distinguish between the various circuits.

To this end, I am including a number of cuts showing various super-heterodyne receivers, each varying somewhat in design. These were picked from a rather large number which have been built and disassembled in an effort to arrive at a most satisfactory design.

#### A REAL PORTABLE SET

I WISH to give credit to my assistant, Mr. McMurdo Silver, for a very large part of the work done on these sets, particularly on the small portable set shown in Fig. 2. This is a six-tube super-heterodyne incorporating one stage of audio amplification. It uses UV-199 tubes and is contained complete, including the A and B battery compartment, in a cabinet measuring  $5 \times 8 \frac{3}{4} \times 11 \frac{1}{2}$ ." Mr. Silver built this portable set in six hours time from

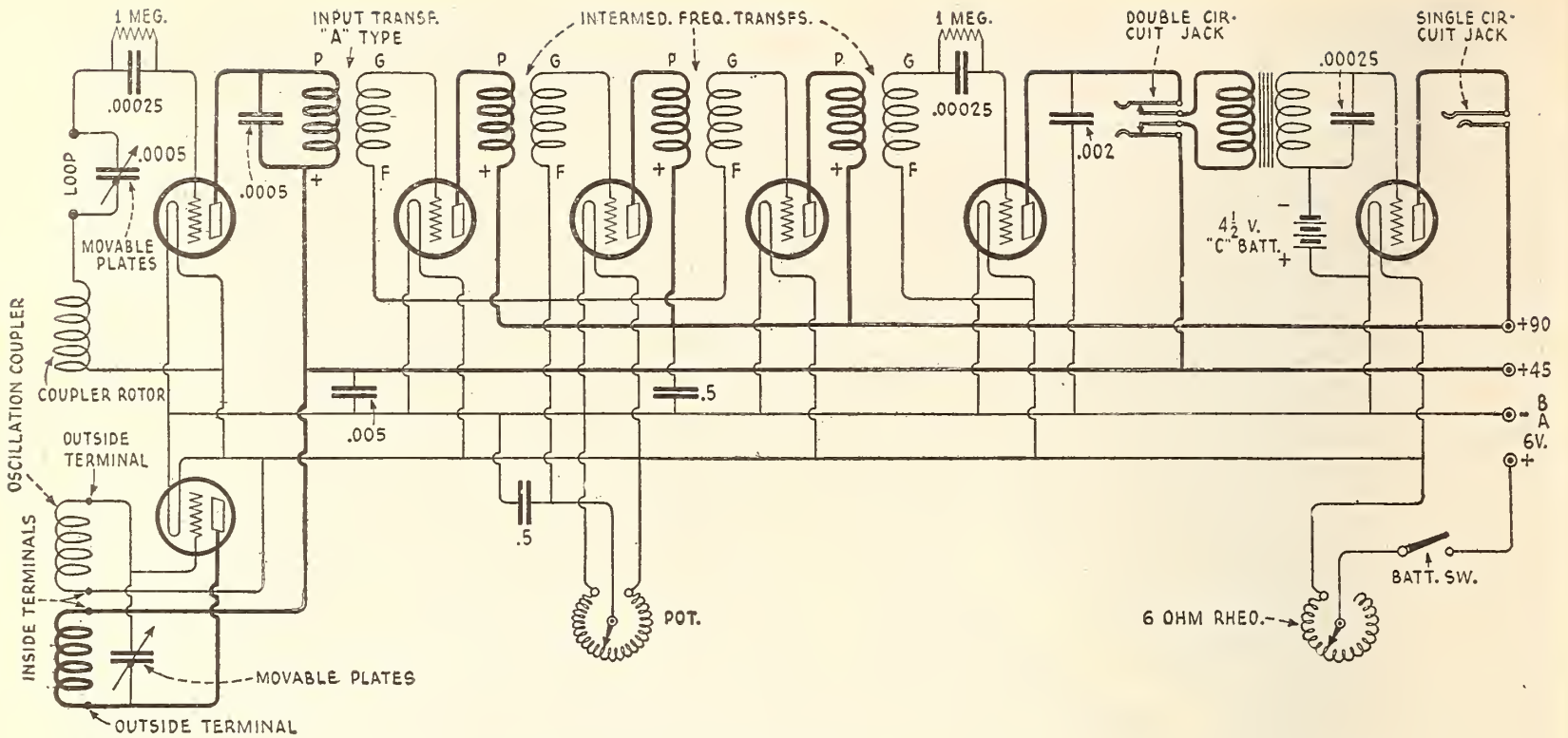

FIG. 3  
Circuit diagram of super-heterodyne shown in Fig. 1 and Fig. 9

beginning to end, starting work on it late one afternoon and finishing it the same evening. It operates beautifully, and I consider it the finest portable set I have ever seen.

While it is not recommended that such a small receiver be attempted, still it serves as a good illustration of what can be accomplished by careful design and skillful mechanical work.

In arriving at what I consider to be the most practical design for this circuit, upward of twenty different sets have been built and disassembled, each being slightly different in details of design and shielding. The object of

this work was to arrive at a design which would incorporate the following points to the greatest possible degree.

1. Amplification
2. Smoothness and ease of control
3. Sharpness of tuning (without sacrificing quality)
4. Accessibility and simplicity of wiring
5. Simplicity of mechanical construction
6. Minimum of shielding.

Fig. 4 shows a set incorporating a maximum of shielding (top and rear shields have

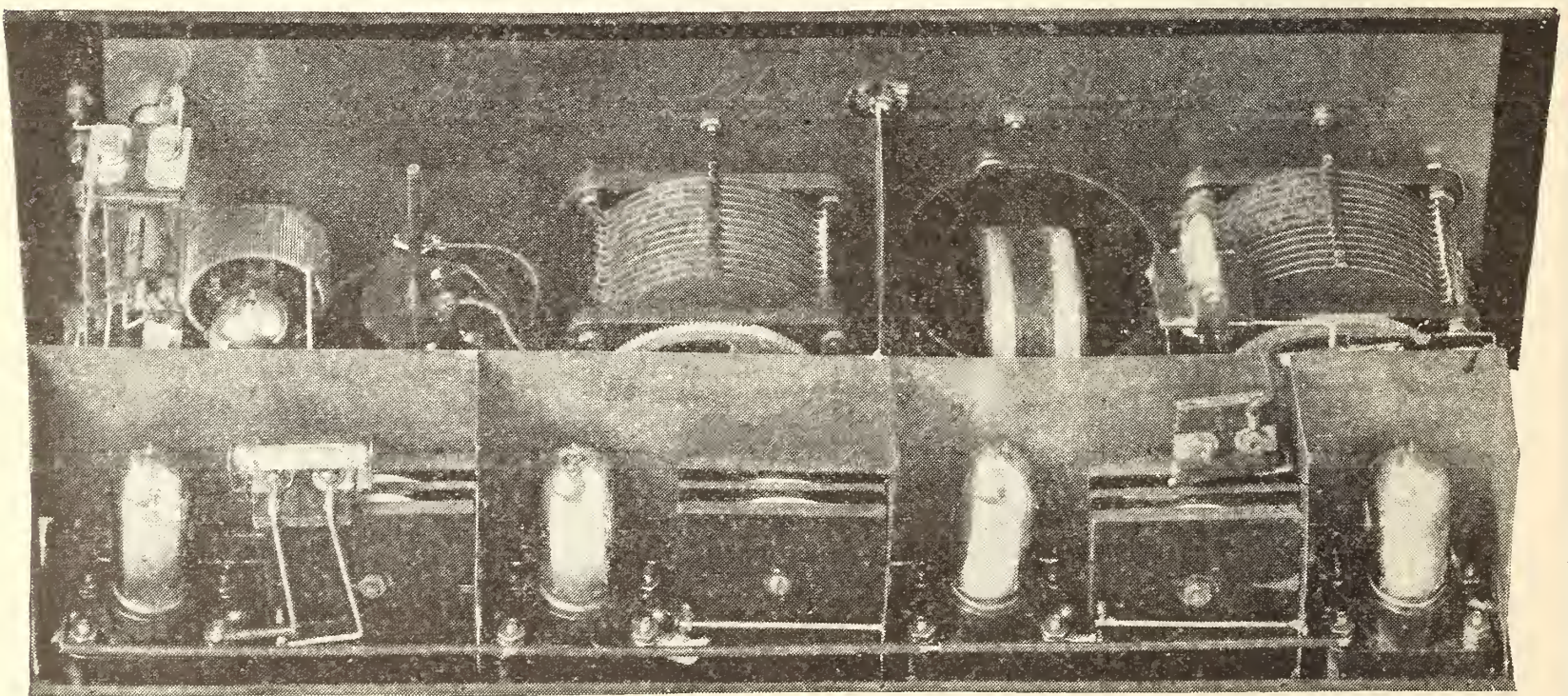

FIG. 4  
This receiver is designed with complete shielding. The result is great selectivity, with somewhat less volume than the unshielded model

been removed for photograph), while Fig. 5 shows an extreme in the other direction where shielding is absolutely eliminated. A comparison of the operation characteristics of these two sets is interesting. The receiver shown in Fig. 4 gave extremely sharp tuning with very good stability and operated with the radio frequency grid return directly on the negative side of the A battery (no potentiometer was used). On the other hand, it did not give as great a degree of radio-frequency amplification as the set shown in Fig. 5. This latter set, however, would not tune as sharply as the former and required a potentiometer to stabilize the radio-frequency amplifier, although even in this case the grids of the radio-frequency tubes were operating with a sufficient negative potential.

The fact that the radio-frequency transformers appear to be different in each set may

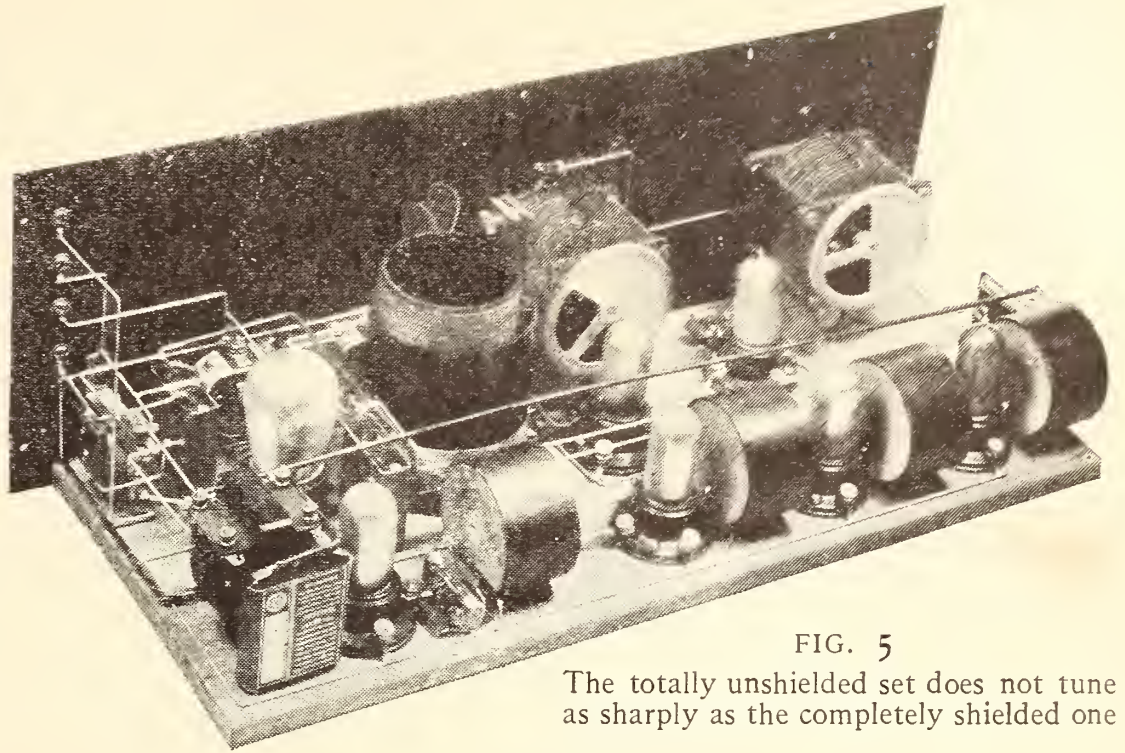

FIG. 5  
The totally unshielded set does not tune as sharply as the completely shielded one

be criticized. This is not however the case, as their electrical characteristics, spacing of windings, etc., are identical.

THE MOST PRACTICAL DESIGN

THE design which was finally found to be the most satisfactory from every standpoint is shown in Figs. 1 and 9. Two straight

MATERIAL USED FOR THE SUPER-HETERODYNE

	APPROXIMATE PRICE	
	EACH	TOTAL
1 7 x 24 x $\frac{3}{16}$ -inch hard rubber panel, drilled . . . . .		3.00
1 Sub-base (seasoned wood) 7 x 23 x $\frac{1}{2}$ inch . . . . .		1.00
2 Metal shields, 5 x 6 inch (optional) . . . . .	.15	.30
2 .0005 mfd. vernier condensers (among those recommended are General Radio, Lombardi, Felt & Kimmel, or Cardwell—with mechanical dial vernier) . . . . .	6.00	12.00
1 Potentiometer . . . . .		1.50
1 $4\frac{1}{2}$ -volt C battery . . . . .	.45	.45
1 6-ohm rheostat . . . . .		.75
7 Bakelite sockets (square type) . . . . .	.75	5.25
1 Haynes-Griffin "Input Transformer" . . . . .	4.25	4.25
3 Haynes-Griffin "Intermediate-Frequency Amplifying Transformers" . . . . .	4.25	12.75
2 .00025 mfd. Micadon with grid leak clips . . . . .	.45	.90
1 Audio-frequency amplifying transformer . . . . .	5.00 to 7.00	5.00
2 1 megohm grid leaks . . . . .	.50	1.00
1 .00025 mfd. Micadon (for audio transformer) . . . . .		.45
2 .5 mfd. condensers (or larger may be used) . . . . .	.90	1.80
1 .0005 mfd. Micadon . . . . .		.35
1 .002 mfd. Micadon . . . . .		.45
1 .005 mfd. Micadon . . . . .		.60
1 Haynes-Griffin oscillation coupler . . . . .		3.50
1 Double-circuit jack . . . . .		1.00
1 Single-circuit jack . . . . .		.75
1 Battery switch . . . . .		.60
6 Binding posts . . . . .	.06 to .12	.60
1 Cabinet for 7 x 24 panel with 8-inch depth . . . . .		6.00
Brass wire, spaghetti, soldering lugs, etc. . . . .		3.00
		<u>\$67.25</u>

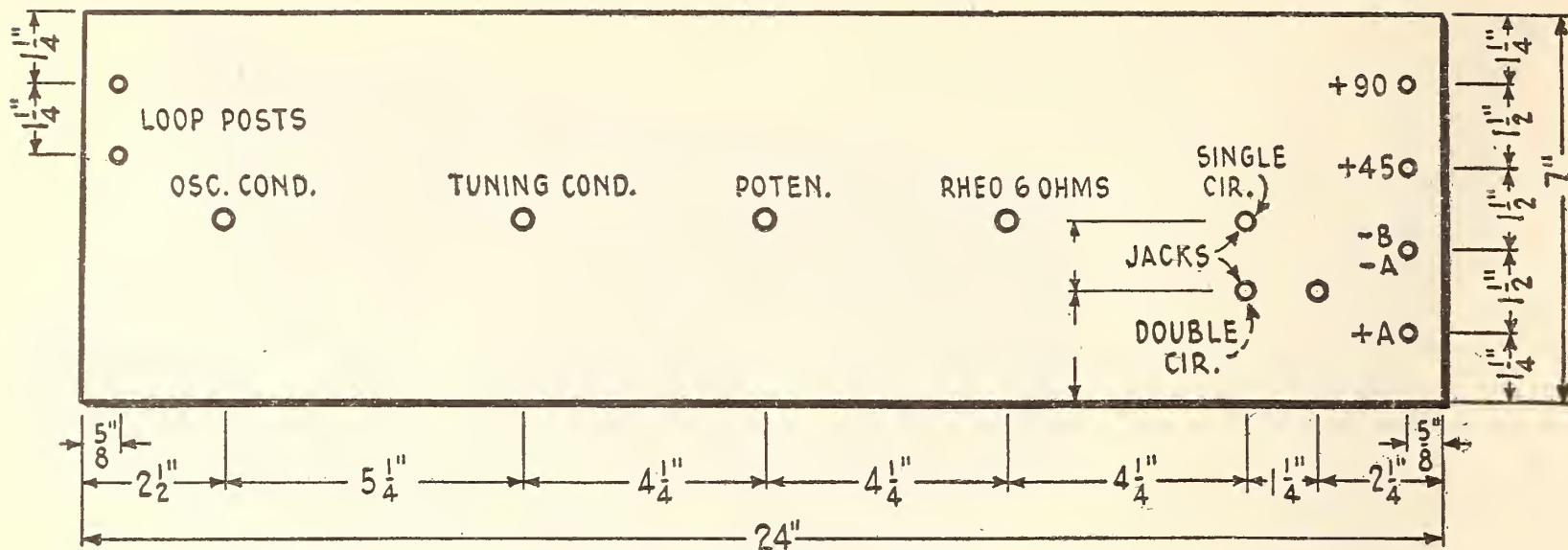

FIG. 6

The layout for the front of the panel

shields are used to isolate the radio-frequency amplifier, without decreasing its efficiency, and this has also helped in reducing the mechanical construction difficulties to a minimum. In fact, even these two shields may be omitted with very slight difference in the operating characteristics being noted.

Fig. 7 shows the sub-base assembly and wiring which should be done before the panel is attached. By assembling, and, as far as possible, wiring both the sub-base and panel layouts before the two are mounted together, the mechanical wiring difficulties are greatly reduced. It should be noted in Fig. 7 that the sub-base wiring is kept as low as possible, thus permitting the shields to be slipped into place by merely notching their edges where they cross the wires.

Fig. 1 is a rear view of the completed set, showing the wiring finished and shields in place. These shields are cut from sheet tin or brass with two narrow tabs on their lower edge.

These tabs are bent at right angles to the shield and slipped under adjacent sockets and transformers to hold the shields in place.

The oscillation coupler is shown behind the two variable condensers. After it is once adjusted it needs no further attention. The filament adjustment of this set with either UV-199 or UV-201-A tubes is not critical, and for that reason, only one rheostat is provided for all tubes. This arrangement does not provide for turning off the audio amplifier tube when it is not used, but on the other hand, it allows one to tune in a station using the head-phones and detector tube only and then plug in on the amplifier with the loud speaker, *without making any other adjustments in the set.* This would not be true if the filament of the last tube were not kept lit.

The only point to be stressed in the selection of these parts is that they should be of good quality. Beyond this requirement, the exact make of rheostats, jacks, etc., which are used

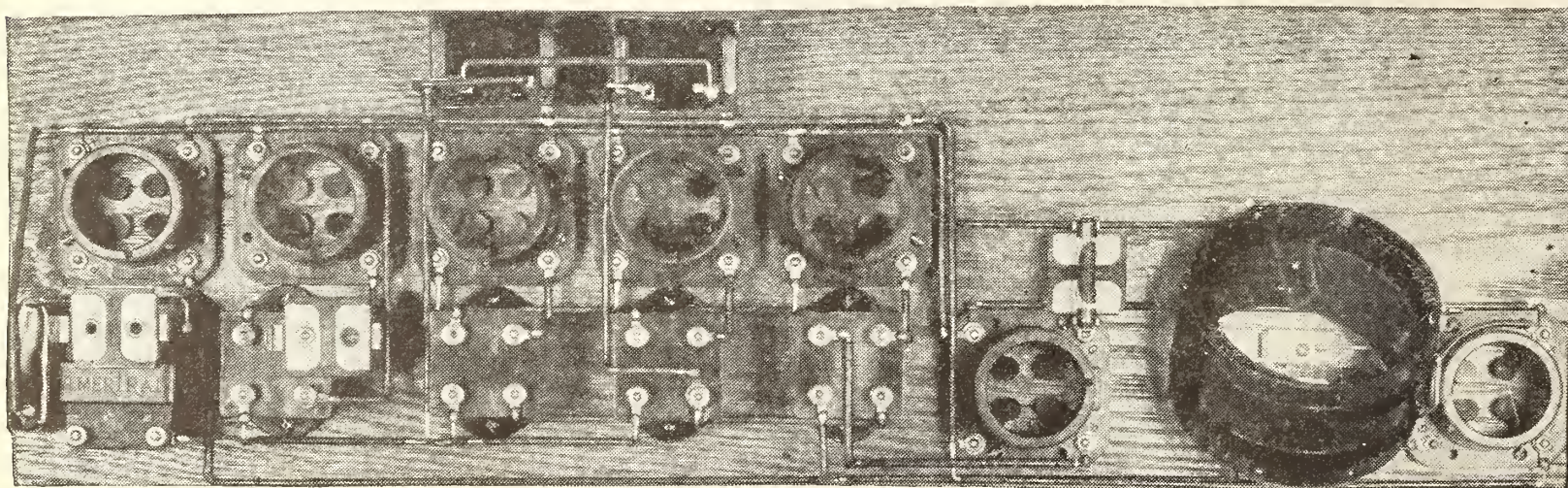

FIG. 7

Layout of the base of the super-heterodyne. The wiring is kept close to the base and it should be completed before the panel is attached



is of little consequence. This, of course, does not apply to the special radio-frequency amplifying transformers or the oscillation coupler. These instruments were designed particularly for this circuit and are responsible in no small measure for its success.

#### LAYOUT

IN THE panel layout in Fig. 6 only the center or shaft holes of the various instruments are indicated, as the holes for the mounting screws will vary with different makes of apparatus.

The general layout of the instruments on the sub-base can be seen quite clearly in Fig. 7.

I would suggest that the panel assembly should first be completed and the panel screwed to the sub-base temporarily before any wiring is done. The sockets, transformers, etc., can then be arranged on the sub-base and screwed in place. The panel should then be removed and the wiring started.

#### WIRING

HALF-HARD No. 14 tinned copper wire is recommended for hooking up the set. Spaghetti may be used where necessary. If it is desired to "bunch" the filament and B battery leads and use ordinary No. 18 annunciator wire, this may be done, and is good electrical practice, although it detracts somewhat from the appearance of the wiring job.

The grid leads from the radio-frequency transformers should be kept as short as possible.

The shields should be connected to the negative A battery lead.

It will be noted that the transformers and

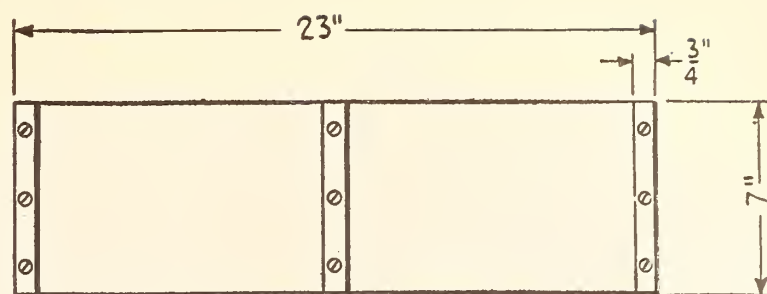

CLEATS ON BOTTOM  $7 \times \frac{1}{2} \times \frac{3}{4}$ "

FIG. 8

Diagrammatic plan of the base layout

sockets are so placed that a shield may be placed between each radio-frequency stage, if it is so desired, and this should be done if it is not possible to run the potentiometer more than half way toward the negative side. If the wiring is carefully done, however, this shielding will not be necessary.

#### OPERATION

IT DOES not seem necessary to go into the details of operating the super-heterodyne. This has already been done in this and other radio publications.

It is recommended that UV-201-A tubes be used throughout, although very good results may be had with UV-199's (use 4-volt A battery with latter). The tubes should be shifted around until the best combination is obtained. When they are properly balanced, the amplifier should slide gradually into oscillation with a slight hiss as the potentiometer is brought over to the negative side.

When the filament rheostat and potentiometer have been once adjusted, they may be

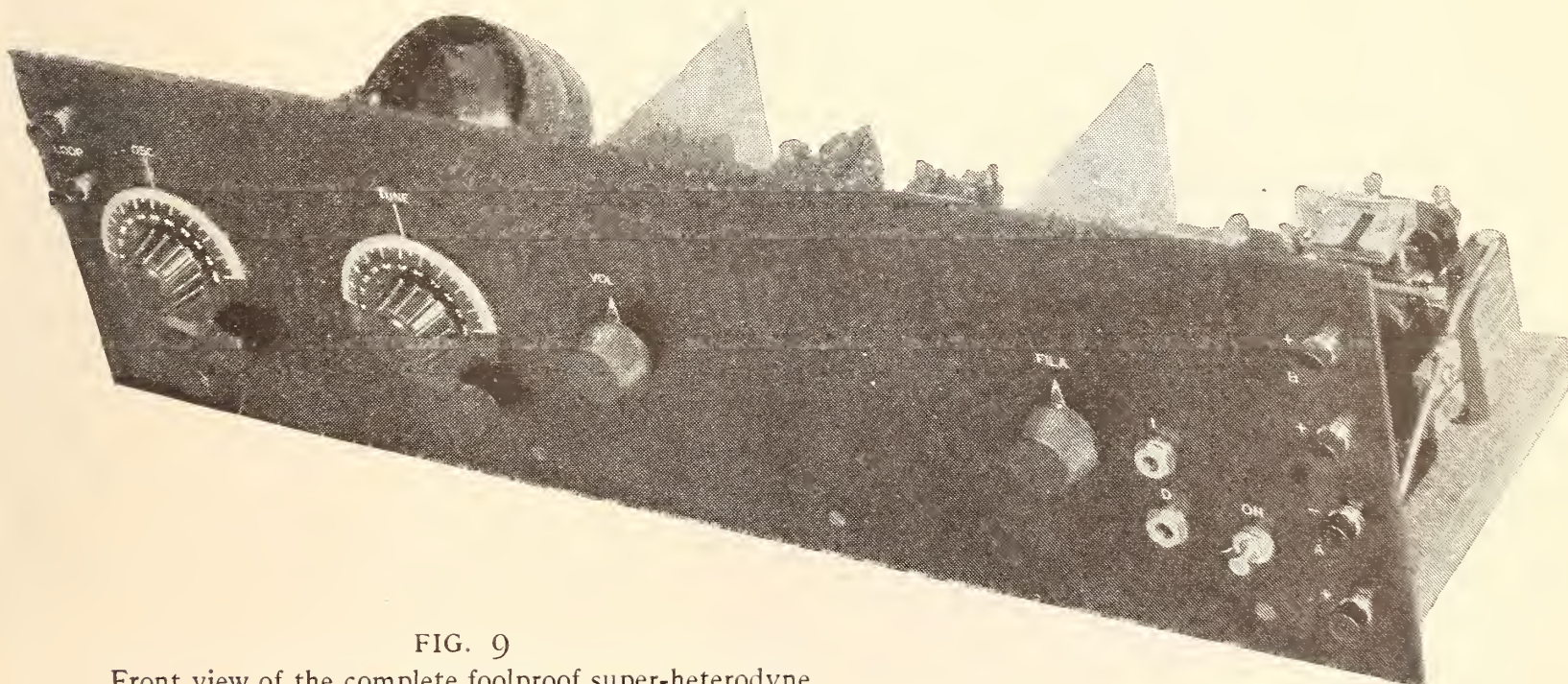

FIG. 9

Front view of the complete foolproof super-heterodyne

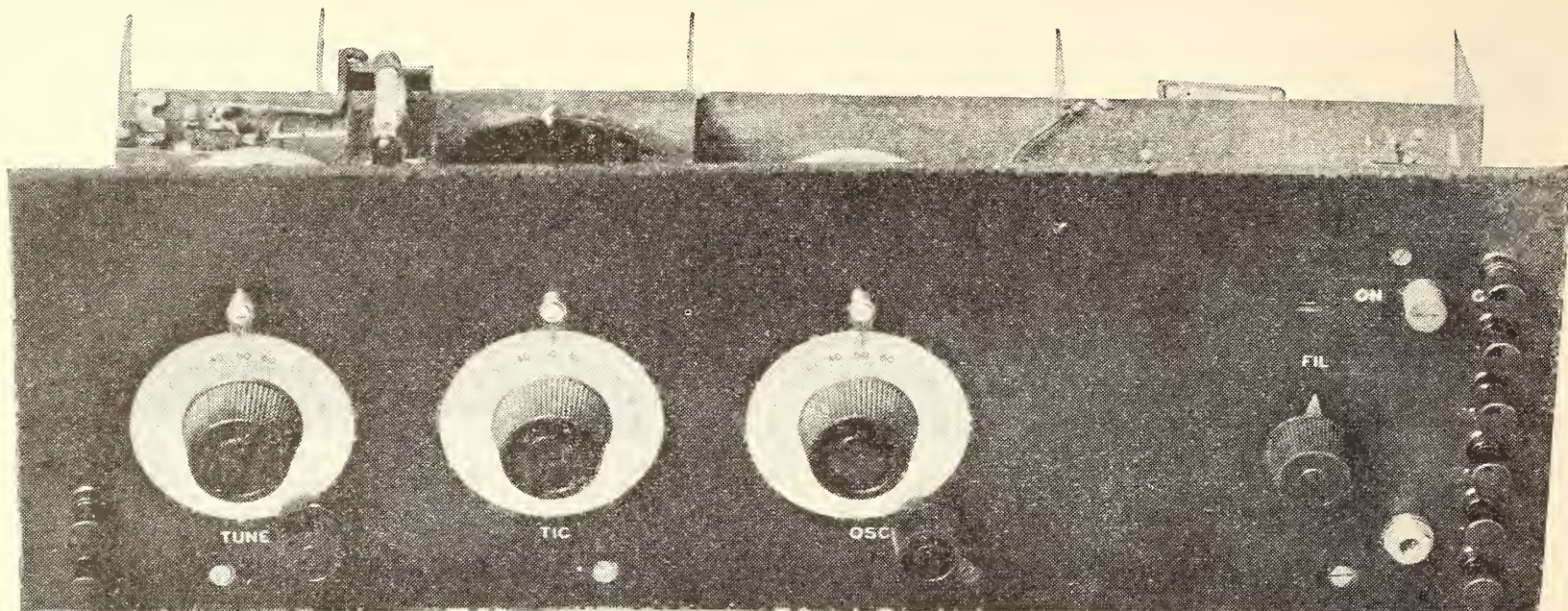

FIG. 10

Front view of one of the completely shielded sets

left alone and all tuning is done with the two condensers. After a station is tuned in, the potentiometer may be used as a volume control.

As there is no manufactured superheterodyne on the market to-day, it can be seen that this circuit is still in a comparatively experimental stage, and even though a receiver as described above is far ahead of any standard set now on the market, still the vast possibilities of this circuit have not by any means been fully realized. It is this fact that should make

this circuit have a very strong appeal to the serious radio experimenter.

There are a vast number of variations possible, such as using crystal detectors, reflexing, etc. It is also possible to do away with the separate oscillator tube and use the first detector as an autodyne with very good results.

However, as a word to the wise, I would suggest that the ambitious experimenter build such a set as is here described first, and use it as a standard of comparison if he intends to carry his experiments further.



“WITHOUT  
BENEFIT  
OF  
CLERGY”

# Various Circuits and What They Mean

## PART II

### What Inductance Is and How It's Used

By ZEH BOUCK

**I**NDUCTANCE" is a thing encountered invariably in radio circuits, and so often referred to, that a genuine comprehension of circuits is impossible with no idea of what inductance is.

To define it clearly we must go back to our high-school physics, or even to those first electrical books we read in the days when our electrical research was concerned mainly with an electric doorbell, a wet cell, and a horse-shoe magnet. Those books told of a mysterious something called "induction," concerning which the only thing most of us were able to grasp was the fact that if one circuit or wire was near another circuit or wire, and the current was turned on or off in the first circuit, a current would be "induced," i.e., created, and made to flow in the second circuit. And that is pretty nearly all we need to know concerning induction in order to comprehend inductance.

Here are several things about inductance, however, which young fellows, digging into school text-books, are likely to be unable to assimilate: Whenever a current flows through a conductor (most often a wire), a "magnetic field"—the same sort of thing that attracts nails to a horse-shoe magnet—springs up about it. When the current is turned off, the field drops. If the current becomes weaker, or stronger, the field does likewise. So we may say that with any change of current, the magnetic field caused by this current, "moves."

Now if a circuit is crossed by a *moving* magnetic field, a current is induced in the circuit. This sort of induction is very pronounced in the case of alternating currents, because, as such currents are always changing, the magnetic field is doing likewise—and *this induced, or secondary, alternating current is always flowing in a direction opposite (at the instant of induction) to the direction of the primary current which induces it.* Just why these things are so, we have left to the world's great scientists to find out.

At any rate, this evidence of induction is exactly what inductance is, namely, *the ability of*

*a circuit to induce a current by electromagnetic induction when the original supplied current varies.*<sup>1</sup>

For the simplicity of the illustration, we have spoken of *two* circuits, one close to the other, the original or primary current flowing in one wire, and the secondary or induced current flowing (always in the opposite direction) in the adjacent conductor. But supposing we make a coil of the original conductor (a piece of copper wire, let us say). Then the magnetic field about one turn will cut the adjacent turns, and we will have an induced current in the *same* circuit. It is apparent that the number of turns in the coil, their closeness together, etc., will directly determine the inductance of the coil.

Thus the inductance with which we have mostly to deal may be defined as the ability of a circuit, in which is generally included a coil of wire (which furnishes almost all of the inductance) to generate a secondary current (in itself or in a near by circuit) when the original current varies. So much for "inductance."

#### WHAT IS AN INDUCTANCE?

**A**N INDUCTANCE is something possessing the quality of inductance. The name is most commonly applied to a coil of wire, because a coil is predominantly characterized by inductance. It is like a cigarette, which is so closely associated with smoke, that a cigarette is often referred to as "a smoke"—or a passenger, generally paying a fare in a public conveyance, who is often simply designated as "a fare."

*Hence any coil of wire may correctly be called an inductance.*

#### FAMILIAR FORMS OF INDUCTANCES

**T**HE circuit in Fig. 1 is the diagram of what is becoming an exceedingly popular receiver, the one-tube reflex. The photograph in Fig. 2

<sup>1</sup>Inductance can be measured, and its unit is the "henry," named after Joseph Henry, one of America's pioneers in the field of electromagnetism. A circuit has an inductance of one henry when a current changing at the rate of one ampere a second induces an E. M. F. (electromotive force) of one volt.

shows the instruments indicated on the diagram. These will illustrate three forms of inductance most commonly encountered in radio experiments.

$T_1$  is a coupler, and in this case, the primary is wound over the secondary. If either the primary or the secondary were movable in respect to the other winding, the instrument would be what is known as a variocoupler. The primary and secondary are the inductances which make up this piece of apparatus. A coupler is generally wound with No. 20 to No.

nothing more than a coupler) the primary and secondary are the inductances.

$T_3$  is an audio-frequency amplifying transformer, consisting of some thousands of turns of very fine wire on the primary, and about four times as many turns on the secondary. These windings are made on an iron core which concentrates the magnetic field and greatly increases the inductance. The necessity for the iron core will be explained in discussing the uses of inductance. Again the primary and the secondary are the inductances.

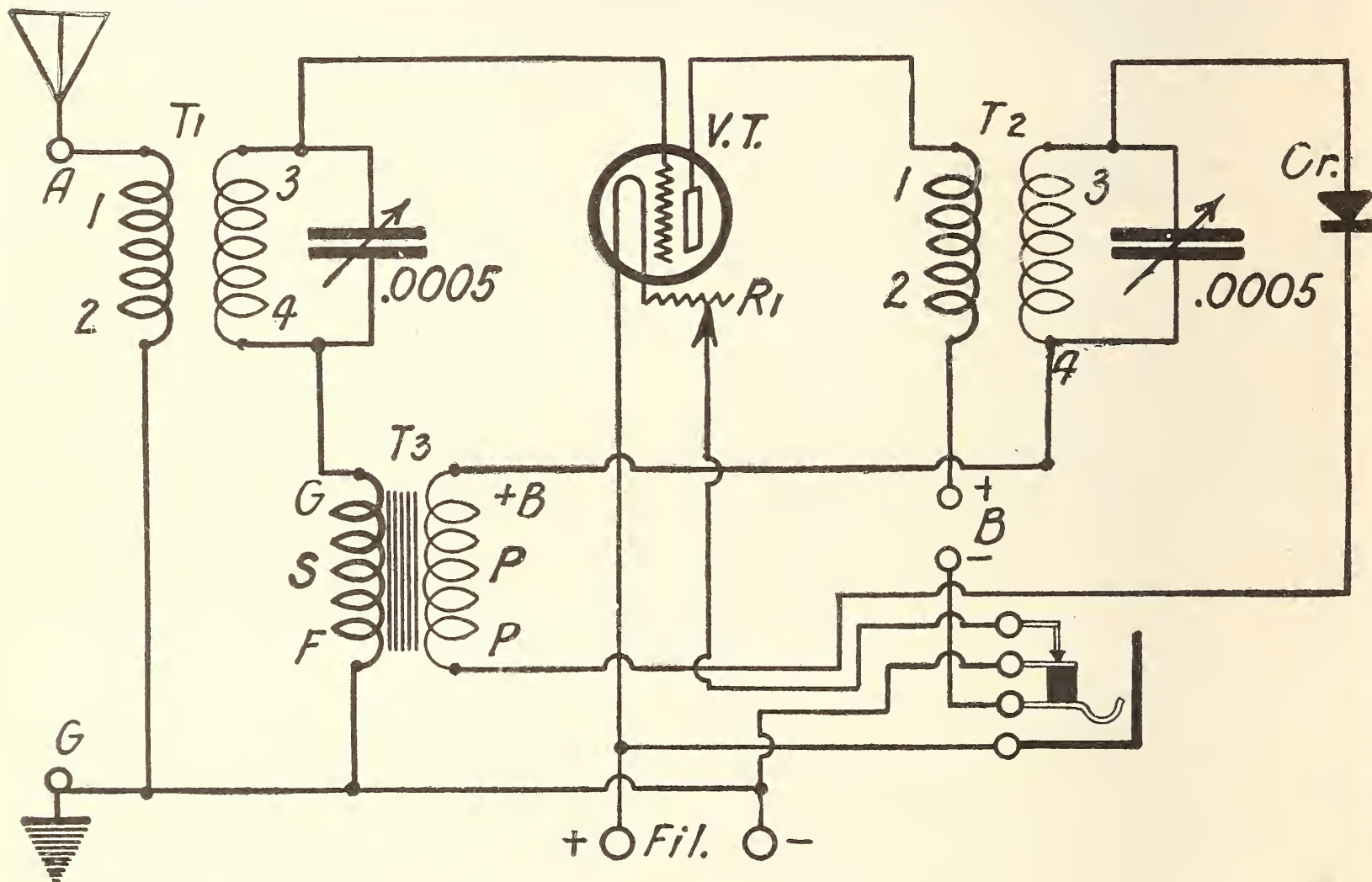

FIG. 1

A circuit showing three familiar forms of inductances ( $T_1$ ,  $T_2$ , and  $T_3$ ). This is the wiring diagram of the "knock-out" one-tube reflex receiver described in RADIO BROADCAST for November, 1923

24 wire. The primary, if fixed, has about 16 turns of wire, and about 50 turns if variable by taps. The secondary is wound with about sixty turns. A tube about  $3\frac{1}{2}$  inches in diameter is generally used for the primary winding form, with the secondary wound either alongside or on a tube or ball rotating within the primary form. Such a coupler will work nicely where no special data for a specific set are given.

$T_2$  is a radio-frequency amplifying transformer, which it is usually more satisfactory to buy than to build. As in the case of the coupler (in fact the radio-frequency transformer is

As will be shown later,  $T_2$  and  $T_3$  are called transformers because they transform energy from the primary to the secondary circuit. But  $T_1$  also does this, so the unit is sometimes, and quite correctly, termed a receiving transformer.

Fig. 3 is the diagram of a two-slide tuning coil, common to all single-circuit sets. The two-slide tuning coil is, of course, another type of inductance. In effect it is a two-winding coupler, for the turns between X and Z act as primary, and those between Y and Z as the secondary. Because of the self-contained double action, such windings are often referred to

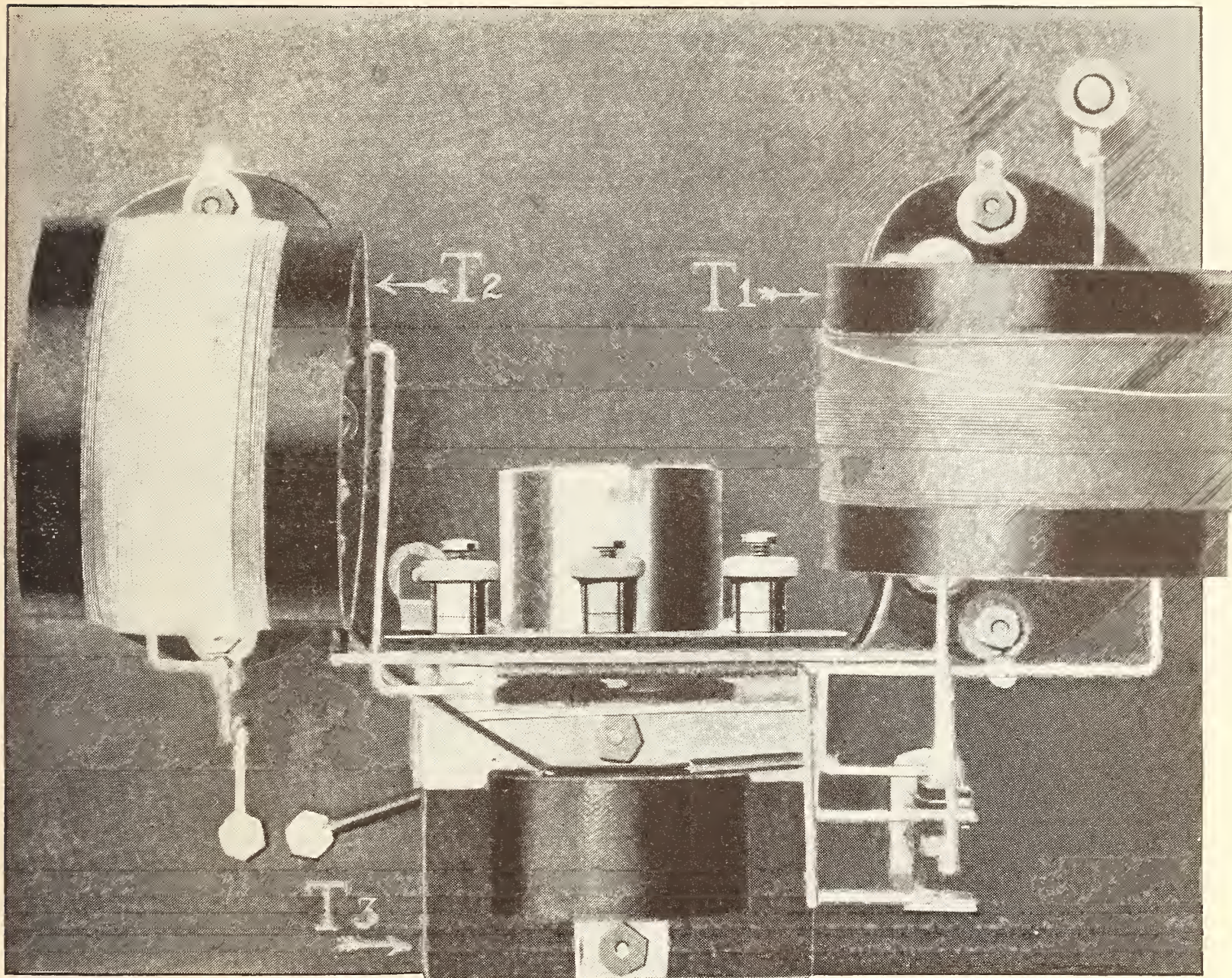

FIG. 2

The inductances shown diagrammatically in Fig. 1

as auto-transformers. About 80 to 100 turns of wire on a 3-inch winding-form are about right for such a tuner.

The variometer, which is a continuously variable inductance, as well as all other forms of coils—chokes, honeycombs (which are often used as primaries, secondaries, and plate or “tickler” coils) are inductances.

#### HOW INDUCTANCES ARE USED

THE most common use of radio inductances is to transfer the energy from one circuit to another. This transfer is made from the antenna and its circuit which “picks up” the signals, to the detector (variocoupler or tuning coil) or, inductances transfer energy from the output circuit of one tube to the input circuit of another tube. This is done by a combination of inductances called an amplifying transformer. This energy transfer is accomplished

—chiefly by induction—the phenomenon which we outlined in our opening paragraphs. It need only be remembered that the reason an inductance *is* an inductance is because of its ability to induce a current in a near by circuit (or in itself).

Now the action of radio-frequency transformers and couplers does not occur so much by the phenomenon of induction, in a narrow sense of the word, as it does by re-radiation. Whenever a radio-frequency circuit is tuned to a radio impulse, it re-transmits part of the energy it picks up. Guy wires and metal fences, etc., in the neighborhood of a powerful transmitter, are often affected by the radiation from the antenna and send out additional waves. So the primary in a radio-frequency circuit is really a small transmitting antenna which transmits its mite of energy across the intervening inch or so to the secondary. How-

ever, as radio reception is fundamentally a species of induction, the action of a variocoupler, or a radio-frequency amplifying transformer is often explained simply occurring by "induction."

In radio-frequency circuits, the magnetic field, through this process of radiation, spreads out from the conductors, apparently moving at so high a frequency that its inertia (tendency to keep on going) is so great that it cannot reverse and return to the wire. It "disconnects" itself and shoots off into space. In audio-

frequency circuits, this phenomenon does not occur. The audio-frequency waves, which act somewhat like rubber bands, merely stretch a little (the frequency or the up-and-down motion is comparatively slow) and come back to the wire again. The "rubber band" never "breaks" and flies away. Hence, to effect any transfer of audio-frequency energy across even the slight distance between primary and secondary windings, the magnetic field must be concentrated by the use of a core.

It has been mentioned that the current induced in a coil by its own primary current is always in the opposite direction to the current that induced it, so it follows that this opposition of current will have a certain undesirable effect on the inducing or primary current, or, say, the incoming radio signals. It has also been shown that this induced current varies directly with the rapidity of change of the primary current. Then this undesired effect of opposition by the secondary current on the inducing current will vary directly with the frequency, kilocycles or wavelength (the rapidity of change) of the incoming signals. This partly explains the necessity for tuning, that is, changing the values of inductance in the circuit. In radio-frequency circuits, the inductance must be kept comparatively low, and this is one of the reasons why iron cores are eliminated from such circuits. Where high inductances are a part of a radio-frequency circuit, such as telephone receivers and the windings of audio frequency amplifying transformers, these inductances are shunted by fixed condensers which "by-pass" the high-frequency impulses. These capacities are in particular evidence in the Grimes and other reflex circuits.

FIG. 3

The tuning coil which forms the inductance in most single-circuit sets. As explained in the text, this is a type of "auto-transformer"

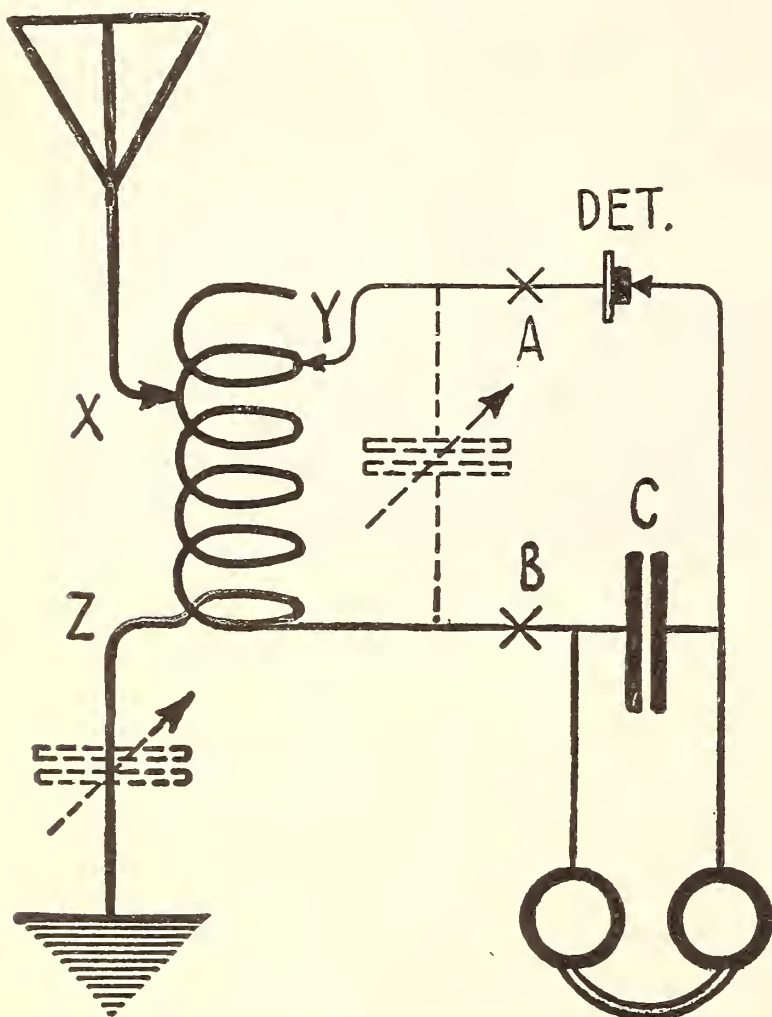

*Mr. Bouck's third article in this series will appear next month.*

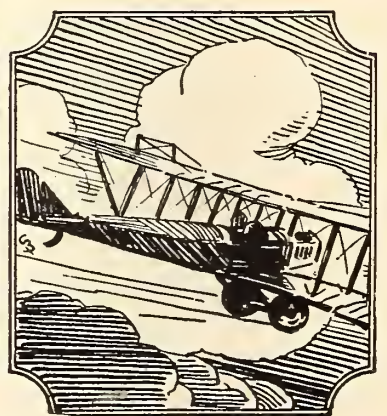
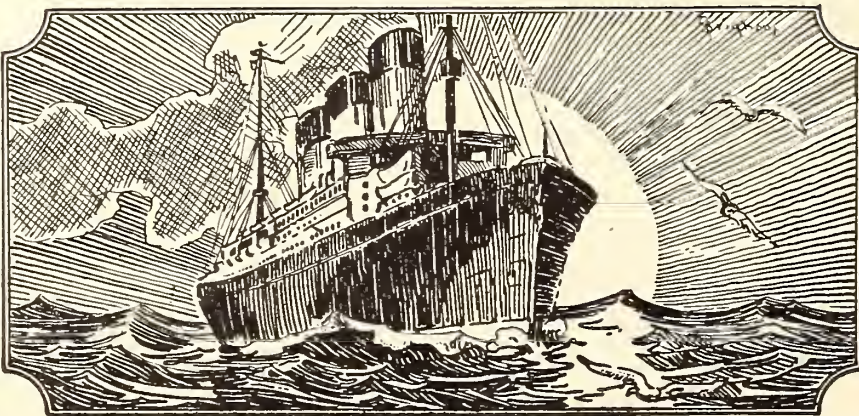



MR. STEVENS' SHOP IN WASHINGTON, D. C.

Where the simplicity, neatness, and attractive appearance of modern receiving sets are made evident to the uninitiated

## Making Radio Attractive to Women

A Sales Plan Adopted by a Dealer in Washington, D. C., and the Reasons for Its Success

By LEWIS WOOD

**I**F YOU saw a receiving set installed in the living room of your own home in such a way that it harmonized with the furnishings of the room—seemed to “go well” there, as we say—would you be any more inclined to want it than if you saw it against the background of a lot of shelves packed with electrical equipment?

Donald G. Stevens, of a radio sales company in Washington, believes you would, and therefore he has adopted a plan which has been very little developed in the field of radio merchandising. It took some courage to start such a venture as the outlay necessary was considerable, but he was convinced that the ability to realize just how radio “fits” and looks in the home would, in time, prove a great inducement to purchasers.

Accordingly, he furnished his place of business, not like a store at all; he got away from

shelves and counters, replacing these with furniture in the fashion of a parlor or a drawing room. He put a big, comfortable davenport against one wall, and along the other side of the room a desk and a table. In the middle he placed one of the long tables that are so often seen in modern homes. He did not crowd his quarters but selected his furniture with taste and discretion. As will be seen from the photograph above there are enough chairs, tables, and desks in the room, and enough pictures on the walls to secure the desired effect. Besides, three or four different types of furniture are provided in order that each prospective purchaser may pick out pieces resembling his own as much as possible.

“I have tried to make it so that the prospective customers who come in here, especially the women, do not have to draw entirely upon their imaginations,” said Mr. Stevens.

"My idea is to have enough variety to suggest the corner or center of almost any living room to-day."

Justification for this novel plan of merchandising seems to be ample, for the sales of the establishment during the second month of its existence were one fourth larger than those of the first, while sales during the third month nearly tripled those of the second!

"It's a satisfaction to me that we have been able to prove to the public that the radio business can stand alone," remarked Mr. Stevens. "We sell radio and nothing else, and I suppose it's because of that very thing that the public will come here when it won't go to some other places. Customers must realize that since we deal in nothing but

radio, we know this work as no one who manages it as one of many side-lines can ever do. If more and more dealers would go into the strictly radio business instead of making it a side-line, public confidence would grow steadier all the time.

"Radio has a special demand of its own," he continued, "just as the talking machine or the moving picture has. Some people think the talking machine will disappear with the increase of radio's popularity, but that's a mistaken theory. The phonograph will continue in its own sphere, and it's my idea that it will become a sort of vocal library, preserving voices just as the printed words are preserved in a book, while radio will be a sort of talking daily newspaper."

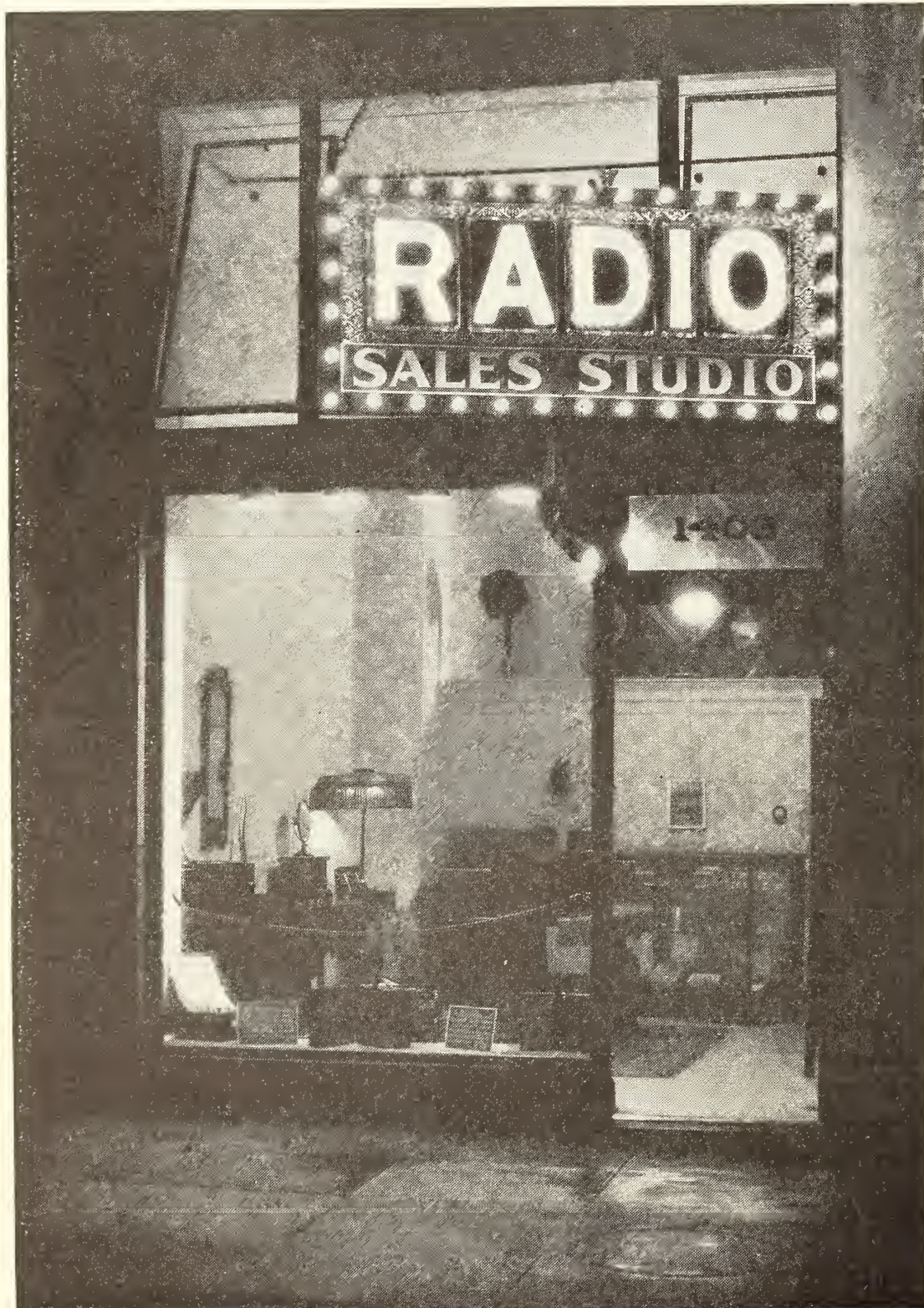

MOST  
PEOPLE  
STOP,  
AND  
MANY  
GO  
INSIDE



# How to Neutralize the Neutrodyne

The Second of a Series of Three Articles on Building, Neutralizing, and Operating a Five-Tube Hazeltine Circuit Receiver

By KIMBALL HOUTON STARK

Chief Engineer, F. A. D. Andrea, Inc.

**M**ANY people who have constructed neutrodyne receivers have possibly found the adjusting or "balancing out" of the set before it is ready for use, a difficult task. In most cases, it has been difficult, not because the process itself is complicated but because of a misunderstanding of the results to be obtained and the methods of obtaining them.

It may be well at this time to consider the function of the neutrodyne circuit in order to understand just what is accomplished when we balance out or adjust it for capacity neutralization.

Professor Hazeltine devised a method of neutralizing both the stray circuit capacities and the inherent capacity of the vacuum tube, i.e., the capacity existing between the filament or cathode and plate or anode of the tube. It is the presence of these coupling capacities in an ordinary tuned radio-frequency amplifier circuit that causes the circuit to regenerate and oscillate when the tuned amplifier circuits are in resonance, unless some means is provided for controlling the grid potential of the tubes, which usually results in a loss of efficiency.

Such parasitic oscillations make it impossible to secure pure radio-frequency amplification and in addition cause very decided signal and

speech distortion. Every listener-in knows the disadvantages of tuning-in to a local concert and hearing all sorts of "birdies."

In Professor Hazeltine's arrangement, however, coupling capacities are made to counteract each other and each individual tube circuit is balanced against another tube circuit so as to reach a condition where no signals can be heard in the phones because of passing through coupling capacities existing in the circuit.

In the neutrodyne circuit, the electromagnetic coupling between the neutroformers is approximately zero. The effect of this is to make one portion of the circuit capacity balance against another practically equal portion of circuit and tube capacity, so as to eliminate or neutralize the effect of the parasitic feed-back capacities of the entire circuit.

## HOW TO NEUTRALIZE THE CIRCUIT

**I**N PRACTICE, the balancing-out process consists of exciting the coupled receiver circuits with a comparatively strong signal and then adjusting the special neutralizing capacities or Neutrodons, as they are called, to a point where that signal becomes inaudible. The fact that this adjustment of the neutralizing capacities is made toward a minimum or inaudible signal and can accordingly be made very exact, gives us proof that the method of neutralization is a true process of actual circuit

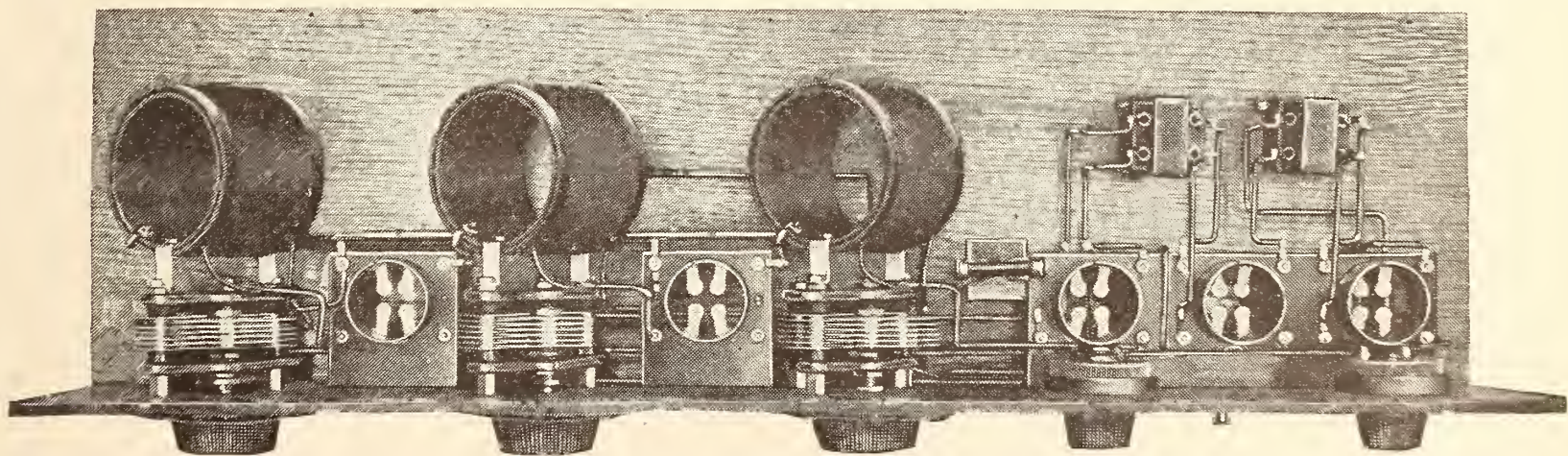

FIG. 1

Top view of the five-tube neutrodyne receiver. This is the set described in the December, 1923, RADIO BROADCAST

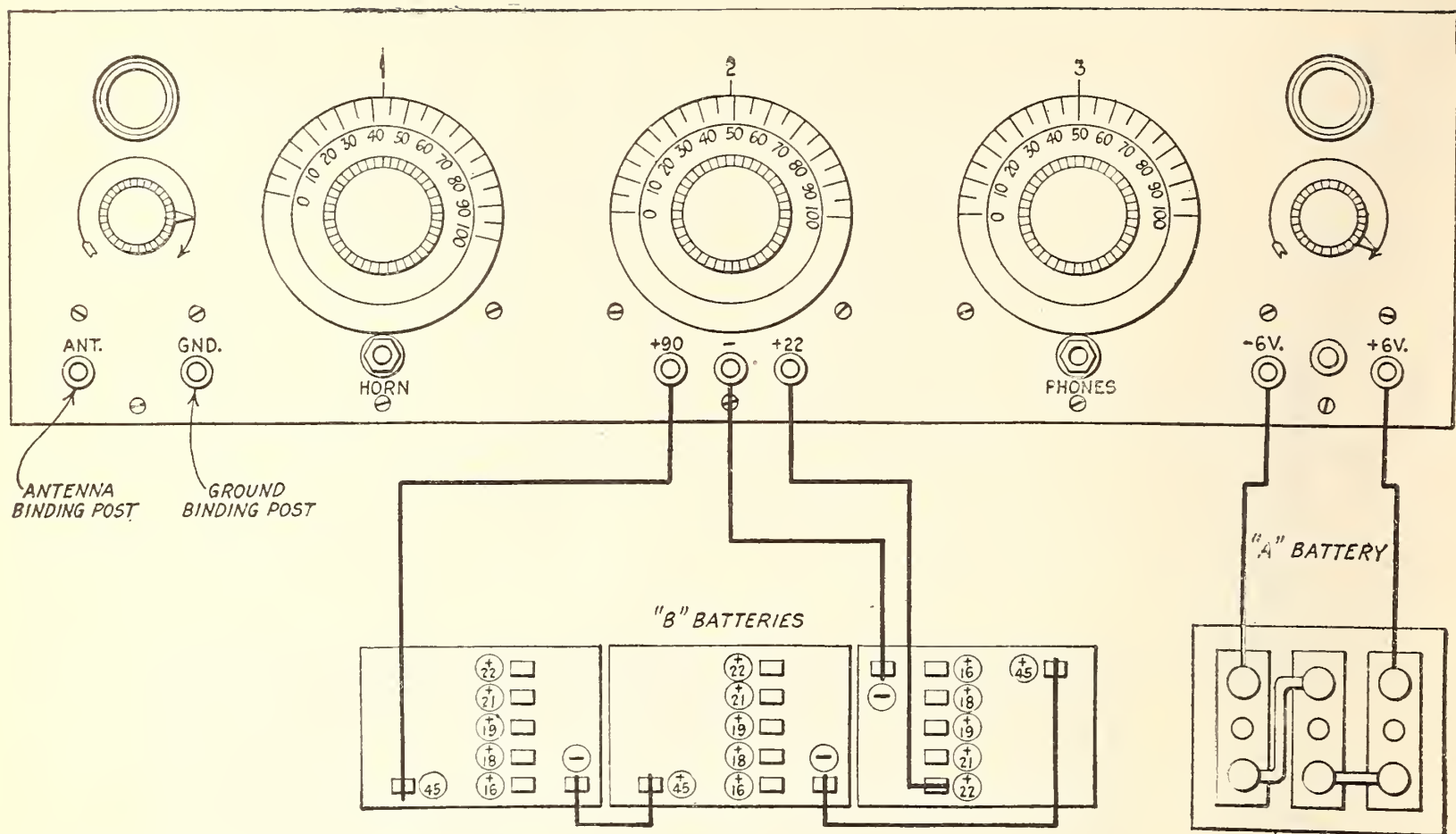

FIG. 2

The method of connecting the A and B batteries. This cut shows the four-tube receiver, but the binding posts and markings of the five-tube set are precisely the same

capacity neutralization and not a method of preventing or reducing regeneration. This is even more forcibly brought out when it is realized that the adjustment is made *without lighting the filament of the tube you are adjusting*.

The five-tube receiver, after you have completed the assembly and wiring, will appear as shown by the photograph on page 126 of RADIO BROADCAST for December and by the top view of the receiver pictured in Fig. 1 of this article. Fig. 2 shows how to connect the A and B batteries.

In addition to the battery connections, a special balancing-out circuit must be hooked up. The balancing-out circuit consists of an inductance and a variable condenser excited by a buzzer and coupled to the input or antenna terminal of the completed receiver. It is usually desirable to place this adjusting circuit 10 or 15 feet away from the actual receiver and lead a single wire over to the antenna binding post. To complete the balancing-out circuit arrangement, a wire is connected from the main terminal of the receiver to the ground such as a water pipe, etc. The wiring and circuit constants of such a circuit are shown in Fig. 3.

With the adjusting or balancing-out circuit connected as above and with the A and B

batteries connected as shown in Fig. 2, we are ready to start balancing out our receiver. The method is as follows:

1. Turn the knobs of both detector and amplifier rheostats as far to the left as possible.

2. Insert two UV-201-A or C-301-A vacuum tubes in the radio-frequency amplifier tube sockets (the two single-tube sockets at the left end of the receiver looking from the panel front). In the detector-tube socket (the one directly above the phones jack), insert a UV-200 or C-300 detector tube.

3. Pull out the filament switch between the phones and horn jack, thus closing the filament circuit, and turn the amplifier rheostat (the one at the extreme left of the panel) so that the pointer points directly at the number three Neutroformer dial. This is about the correct position of the rheostat for the UV-201-A tubes. Turning this rheostat to this position will light the filament of the first two left-hand tubes. Now turn the knob of the detector rheostat about three quarters of the way around or approximately with the pointer at the right and pointing toward the pointer of the amplifier rheostat. It is best to adjust the detector rheostat slightly so that when the phones are plugged into the phone jack, the detector rheostat will be adjusted just below a

point where a decided sizzling and frying sound is heard in the phones.

4. With the buzzer of the balancing-out circuit running, rotate all three Neutroformer dials from the front of the panel, about in step with each other, and pick up the buzzer signals with the variable condenser of the adjusting circuit set at approximately 15 or 20 degrees (an approximate wavelength of 225 meters). The buzzer signals should be picked up at about the same settings, near 15 or 20 degrees on all three of the dials. When buzzer signals are picked up, all three Neutroformer dials should be adjusted very slowly until buzzer signals come in at their maximum. At this point the dials should have approximately the same settings.

5. Remove the tube from the left-hand tube socket.

6. Readjust the three Neutroformer dials again for maximum signals.

7. Take the UV-201-A tube removed from the left-hand socket and place a small piece of paper over either one of its filament contact pins so that the paper will remain in position when the tube is again inserted in its socket.

8. Place the tube with the insulated contact pin back in its socket. This allows the connection of the plate and grid of this tube to the receiver circuit, but as one of the filament contacts is insulated, the filament of the tube will

point is the one where signals are very weak or disappear entirely and no sound is heard in the phones. To prove the minimum signal point, the tube can be lifted out of the socket and immediately signals can come in at their maximum as they did at the end of the adjustment 6 above. Replacing the tube in its socket (with the paper still in place) will cause the signals to disappear or be heard at the minimum signal intensity. The ideal condition for the Neutrodon adjustment is for the signal to disappear entirely when the tube is in its socket (with the paper in place) and at this point the Neutrodon clamp should be tightened down securely. For a more permanent adjustment of the Neutrodon, the clamp after being tightened down can be directly soldered to the sliding brass adjustment tube.

9. This covers the neutralizing adjustment for the first radio-frequency amplifying tube (the one on the extreme left.) The same procedure is followed with the second radio-frequency amplifying tube (the second tube from the left looking from the panel front). In this case the first left-hand tube and the detector tube are kept in their sockets and lit, and the second left-hand tube removed and its filament terminals insulated, after which the neutralization adjustment covered in paragraphs 7 and 9 should be followed out in detail, adjusting the second Neutrodon from

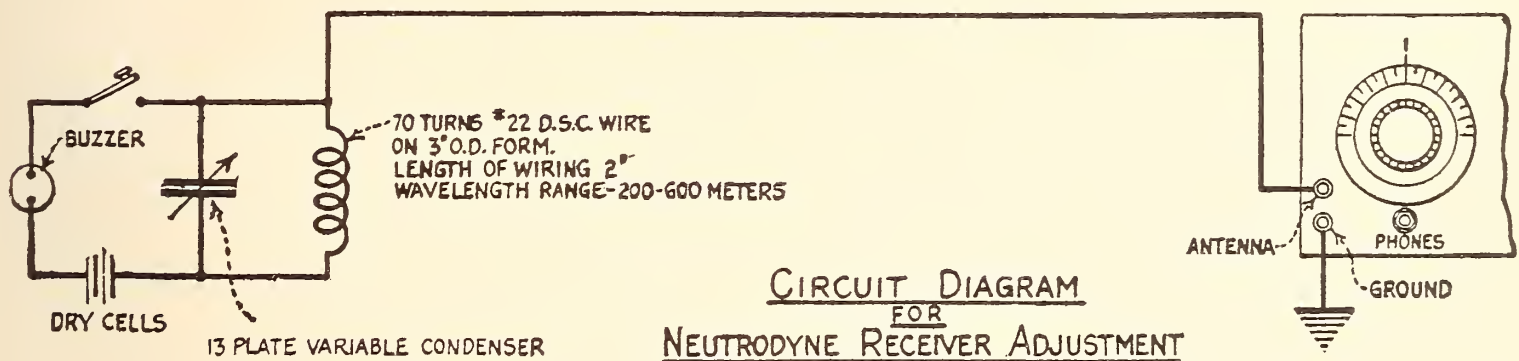

FIG. 3

An arrangement for use when it is impossible to adjust the set by taking advantage of loud broadcast signals

not light. With the tube in its socket and the filament unlit, signals will still undoubtedly be heard, but with considerably less volume than before. It will be found that by adjusting the brass tube of the first or left-hand Neutrodon lengthwise over the glass insulating tubing, the strength of signals heard with the tube in its socket with the filament circuit inoperative can be varied from loud to a minimum or inaudible signal. The desired adjustment

the left end of the baseboard and securing the adjustment at the given inaudible signal point.

The most important point to follow in this balancing-out process is to adjust all three Neutroformer dials for a maximum signal when either the first or second tube is taken out of its socket and before the neutralization and adjustments are made with the insulated filament contact pin of either the first or second tube in its respective socket.

A further test, to determine that the circuit is properly balanced out, is made with the A batteries still connected and with the antenna and ground connected to their respective binding posts, all tubes being in the receiver without any of the terminals insulated. One can try to receive broadcast signals by adjusting the receiver dials, etc., similar to method of tuning for balancing out signals described above.

By tuning the receiver one should be able to receive broadcasted signals without hearing beat notes, whistling, etc., which are the usual indications of regeneration or oscillation. If,

under any circumstances, such whistles are encountered, the entire receiver should be carefully gone over and possibly re-wired and readjusted, as will be described in detail in the third article of this series. If beat notes, etc., are heard, it is proof that the circuit is not functioning according to the neutrodyne principle and most satisfactory results cannot be obtained. The experimenter is cautioned to make sure that his receiver is adjusted properly and that no parasitic disturbances are caused by the improper capacity neutralization in the circuit, otherwise the value of the neutrodyne circuit will not be realized.

## Music Dealers: Logical Salesmen of Radio Sets

By T. M. PLETCHER

President, Q. R. S. Music Roll Co.

THE articles of Mr. George J. Eltz, Jr. and Mr. W. L. Eckhardt on the question, "Is the phonograph dealer or the electrical dealer going to prove best qualified to provide sales and service for broadcast listeners?"\* have interested me. Both are good articles. Both men display knowledge of their subject. Mr. Eckhardt has the music man's point of view, with which I am heartily in sympathy. I should be inclined to cast my vote with him. As a member of the music trade, and because I have strong convictions on the subject of radio due to more or less intimate contact with its development, I should like to take a hand in the discussion to try to throw some additional light on it. I do business with most of the music merchants of the country, and, enjoying a large personal acquaintanceship among them, am rather intimately familiar with their status and their problems. I should like to be permitted, therefore, to increase the scope of the question by substituting "Music Dealer" for "Phonograph Dealer." Many piano dealers do not handle phonographs but can sell radio. "Music Dealer" will embrace both the phonograph and piano merchant.

I cannot improve on Mr. Eckhardt's treatment of the matter in hand except perhaps to submit several considerations in addition to his.

My observation will take the form of answering Mr. Eltz in the sequence of his remarks, touching

\*These articles appear in the November, 1923, issue of Radio Broadcast.

upon those only that in my judgment raise an issue.

His classification of radio business into two divisions, one having to do with the sale of complete sets and the other with the sale of radio parts, leaves nothing to be desired. It is an interesting item of information that previous to radio broadcasting there were approximately 150,000 amateurs in the United States intensely interested in radio and that practically every one of these amateurs had at one time or another manufactured a receiver. My view of the amateur set is that it has served as the greatest incentive to business in the complete radio set. The home-made creation is responsible for the wave of popularity beginning to sweep the country for the factory-made complete set. It did more than anything else to introduce radio to the public. There are many amateurs, however, who are not satisfied with their own efforts. They realize their handicap for want of machinery and laboratory facilities, and have begun to buy professionally made radio. The parents of many an amateur are growing tired of the difficulties which beset the home-made product, and want to satisfy their desire for a set which will reach out to every part of the country, which is comparatively free from trouble, and which at the same time represents the latest advance of the science. I have talked to some about radio parts business and understand that the tendency is towards a tapering down. Whether this is true generally, I do not know, but it would be the natural result of the changing conditions.

Here is the common-sense aspect of the case: the dealer in radio will of course follow the lines of least resistance. Complete radio sets offer more profit, less trouble, less stock investment than radio parts. The reasonable tendency will be towards the complete sets. Add to this the fact that so many boys have had their fling at "rolling their own" and are willing to acknowledge that without factory facilities they are at a disadvantage, it would seem entirely probable that the parts business has seen its best days and that it is now on the downward swing. I am basing my hypothesis on purely psychological grounds.

#### PLENTY OF TECHNICAL MEN AVAILABLE TO THE MUSIC DEALER

THE distinctions which the writer makes between the phonograph and radio are theoretical rather than practical. I agree that the radio set is more complex, that it presents greater mechanical difficulties and more or less of a problem in both the installation and operation. All this, however, is not in a degree to require a man of any more training than is needed to install or repair a talking machine or tune a piano. A talking-machine department cannot be without a practical man. A piano department cannot be without a practical man. The radio department can as little as these afford to be without someone capable of taking care of the difficulties arising on the mechanical side. The radio man does not require four years of college, a post-graduate course and a long apprenticeship any more than the music-merchant's repair man or the piano tuner. As a matter of fact, the degree of expertness of the radio man is not nearly as high as that of the tuner, and what is more, a radio man is easier to get. In "Why the Electrical Dealer is the Proper Outlet for Radio" the statement is made that even before broadcasting there were 150,000 amateurs in the country. There are not anything like 15,000 piano tuners nor 15,000 talking-machine repair men. The ratio is 10 to 1 in favor of the radio man.

The author of the article in question makes extended consideration of the question. Which class of merchant serving the public at the present time is best fitted to carry on the sale of radio? He mentions five classes of channels through which radio purchases can be made: the hardware dealer, department store, phonograph dealer, electrical dealer, and special radio store.

His first objection to the music dealer successfully handling radio is: "The personnel employed by phonograph dealers is not trained in the particular way necessary for the sale of radio equipment." He is right in saying that the personnel is not yet trained in radio, but my contention is that some of the successes made by music stores handling radio show that the music men learn very quickly and that competent radio help is easy to get.



He mentions, "The average phonograph dealer or phonograph salesman is in every sense of the word a salesman." There he hit the bull's-eye. That is one of the biggest arguments in favor of the music man handling radio. He will succeed with radio because he is a salesman. Development of the business depends more on selling than technical ability. Arrange the business so that each man can function at his best. Here is the plan:

A radio department, whether it is part of an electrical business or part of a music business, should be complete in itself irrespective of the size of the general business. The music dealer in the small town should have a radio department just as clearly defined as his piano and talking-machine departments. Whenever you find a store with different commodities jumbled together without distinct departments, you will see an unprogressive establishment. Pianos need at least one salesman and a practical man. Which is true also of talking machines. No reason why the radio department should not be equally well manned. How many successful automobile men are there who happen to be combination salesmen and practical men? Let the salesman sell radio, and let someone else do the installing and the repair work.

#### ADDITIONAL EXPENSES OF A RADIO DEPARTMENT JUSTIFIED

MR. ELTZ contends that the establishment of a radio department "is an additional expense which will naturally reflect itself either in an increased price of material to customers, or in decreased profit." But can you imagine how much business a man would do in complete sets by simply stocking them and having someone with a thousand-and-one duties incident to the electrical business, merely attempt to sell radio as a side-line to his regular activities? Selling cost in such case would be little, of course, but there would be little or no business. On the other hand, a man devoting all of his time to radio, and being paid for what he accomplished in radio, would have to sell a certain quantity of sets each week to earn a living, and correspondingly more to earn an attractive income. There can be no question of outlay when there is enough business to justify the expense. And certainly the most economical way, no matter who handles radio, is to have a separate and distinct department with competent help—at least one salesman and a handy man.

The author talks about the needless "additional expense of establishing a radio department", yet he also recommends that the radio dealer "install a special department in which the more profitable lines of electrical merchandise, other than radio, are sold." Because of his unfamiliarity with the music business, he evidently does not see the analogy

between one and the other activity, and how in each case the various commodities should be handled in distinct departments.

Mr. Eltz dwells on the qualifications of the electrical dealer permitting him to sell radio equipment readily, and mentions his training to think along electrical lines, and to explain the operation of electrical devices, and to maintain and install apparatus. In the piano business, the man who knows much about construction and about tone, is usually getting a mechanic's wage, or very little more. The average salesman earns at least three times as much and generally is burdened with no more knowledge about construction than to answer the usual question of the layman. It is natural for one to talk about that with which he is most familiar. The radio expert talks glibly in the radio vernacular about things which are mysterious to the average man, who on hearing the highly technical explanation becomes more befogged than ever. The salesman's gift is to understand the importance of selling the results rather than the means, the pleasure of radio and the instruction it affords, rather than the intricate mechanical make-up. He knows how to speak in the language of his listener. He knows how to reach into his listener's experience, and he also realizes the importance of keeping technical and mechanical questions in the background. I should rather have the sales staff of my radio department, were I to introduce one, comprise good salesmen, who learned a little something about radio, than expert radio men who had learned a little something about selling.

Of course, all this discussion has to do primarily with the selling of complete radio sets. It stands to reason that the electrical dealer is best fitted to sell radio parts, because they can be handled just like many other similar articles with which the electrical store is filled.

To quote: "The greatest argument in favor of the electrical dealer handling radio equipment is that outside of the investment required for a stock of radio equipment, the electrical dealer is required to go to almost no additional expense." Another discussion is entered into about the increase of operating expense by having a separate department and how that expense will reflect in the profits of the dealer, and have a tendency to increase the price to the consumer, and at the same time decrease volume business. I have yet to find a merchandising proposition with promise, with any one or more elements lacking. A business cannot be run without stock, without salesmen, and without a certain expense. This is fundamental.

Who can conceive of a flourishing radio business when the interest in it is no more than casual? In a busy electrical store, who will take enough interest in radio to advertise it as it should be advertised,

demonstrate it as it should be demonstrated, spend his evenings calling on prospective buyers, outside of him who is devoting all of his wakeful hours to radio and gets his income from that end of the business? If in the personnel of an electrical store there is a man capable of selling \$100, \$200, \$500 radio sets, he should not be spending his time selling supplies. He is in the wrong pew. He might happen to be busy selling someone a binding post when a \$250 radio prospect walked in the door.

That kind of prospect needs a different brand of attention from what the ordinary electrical clerk can give.

A GOOD SALESMAN CAN QUICKLY LEARN ENOUGH ABOUT SETS TO SELL THEM INTELLIGENTLY

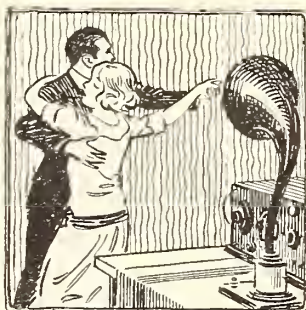

IF I turned over a live and intelligent young salesman to the sales manager of a large concern dealing in radio equipment, how long would it take the sales manager to tutor him in all that he needed to know to make a satisfactory demonstration of your most complicated radio set in the store and to answer the average run of questions from the layman? Am I correct in stating two weeks at the outside? Now, if that young man is put to work and he sells from three to five radio sets a week on a commission basis of 10 per cent. or 15 per cent., would the concern make any money? Supposing, then, I found another such fellow, and then a third! Of course, the sales manager would be increasing his personnel, but would he mind? Couldn't he, in addition to these three men, add a professional repair man and installer?

Let me put the matter in still another way. A music merchant in a town of 10,000 establishes a radio department and puts one of his phonograph men to sell radio and hires an amateur for installations and the possible tinkering. The phonograph salesman gets the necessary fundamentals in radio from the amateur and starts out to tell the people whom he has sold talking machines about the wonders of radio. Helped by his imagination and a ready tongue, he induces one after another individual to accept a demonstration at home. The amateur puts up the set and demonstrates it, and the salesman supplies the adjectives and the enthusiasm. Won't that pair, whose income will depend on volume of business, be a better means of developing trade than having the clerk back of the counter in the electrical store pause in his grind to show an inquirer a radio set?

Thus far I have touched on specific points raised in Mr. Eltz's article. I stated at the outset that my views about the music dealer handling radio coincided with those of Mr. W. L. Eckhardt. There is abundant proof that the music dealer can handle radio. I don't hesitate to say that as a general proposition the music dealer is better

fitted to sell complete radio sets than the electrical dealer.

EXISTING ELEMENTS WHICH FIT THE MUSIC DEALER FOR HANDLING RADIO

THE music dealer has learned how to departmentize his business. He gives due importance to the selling and due importance to the mechanical needs. He is used to hiring salesmen, tuners, repair men. He is usually a good business man, made so perhaps by virtue of his contact with the banking fraternity. The up-to-date merchant is one who knows how to borrow money at the bank. But the banker won't loan money to one on installment paper unless he knows quite well that the borrower is running his business in a business-like way. Otherwise, the paper is apt to be of no value. Perhaps the biggest source of instruction to the music merchant is his banker. Then again, the environment of the music store is often best adapted for the sale of a commodity such as the complete radio set. It is equipped with booths for demonstration, and generally has elaborate appointments, more inviting to the public than the crowded, frequently noisy and distracting electrical shop. Being used to sell a high-priced article he knows how to "talk" a quality product. Then, and this to my mind is extremely important, he is a chronic and keen advertiser, something that cannot be said of the average electrical dealer. Look through the Chicago papers, or the New York, Philadelphia, Pittsburgh, Kansas City, San Francisco papers, count the lines of musical-instrument advertising, as against those

of electrical-instrument advertising, and you will have your eyes opened to a very vital difference between the two dealers. The public will know much more about radio through the music merchant than through the electrical dealer, because he advertises his wares extensively. The music dealer is a public benefactor in the sense that, missionary like, he preaches in print the more or less unknown want of music or of anything that he sells.

True, there are some electrical stores with equipment equal to that of the finest music stores, and the advertising is equally extensive and potent, but they are exceptions.

There is nothing about this radio merchandising that cannot be learned in a short time, but there is a lot about a well regulated business institution such as the modern music store, that is the result of long experience and training—the art of selling, the art of advertising, the art of effective stock display, the art of financing, the art of successfully selling on the installment plan, the art of giving service—all of which, turned into any channel, whether radio, motor cars, pianos or talking machines, can have but one result—large and satisfactory distribution. These elements in the same degree are lacking, to my mind, in the average electrical shop, and they are the ones upon which I should rely for the development of business in the complete radio set. They are all at the disposal of the radio manufacturer, and they are readily accessible if he will but go to the music dealer, who represents these elements in the highest degree.



NOT A NEW CIRCUIT

Nor a recently discovered Egyptian coat-of-arms. By folding one set of hieroglyphics inward against the other, then folding back the right-hand symbols along the middle, you will achieve a result to make certain Canadian broadcasters smile



RADIO AND THE VILLAGE BELL

C. J. Waldron is receiving the noon-time signals from station WGY and tolling the village bell which broadcasts the correct time to farmers in Medusa, Albany County, N.-Y.



# What Our Readers Write Us



## *A Spare-Parts One-Tube Reflex*

**T**HIS LETTER—one of a great number inspired by the article on the one-tube reflex receiver in our November number—is of particular interest because it shows how wide are the bounds within which one can build a given set successfully, provided the circuit is correct.

This does not mean that hit-or-miss work will result in satisfaction. If one is to make substitutions, he must know what to substitute. A knowledge of the fundamentals makes the going much easier than trying to follow a circuit and description without a single deviation. If you know what the circuit should be like, it ought to be easy to use some of the material you have on hand, as Mr. Fern has done.

Editor, RADIO BROADCAST  
Doubleday, Page & Co.,  
Garden City, L. I.

DEAR SIR:

This letter is written as an expression of the appreciation felt as a result of the remarkable performance of the "Reflex Knock-out" described in the November issue of your magazine. I have already succeeded in getting stations on either coast, and most of the intermediate broadcasting stations. These results are all the more remarkable in that I made use of odds and ends about the laboratory. For example: pasteboard forms No. 27 S. C. C. wire and celluloid for a dielectric (from a Ford side-curtain) were used in the coils, and vernier condensers and a Bradleystat were used in place of the equipment specified.

Please accept my thanks for making public this circuit, *which is the first in my experience to do more than is claimed for it.*

Very truly yours,  
J. G. FERN  
Hammond, Ind.

## *A Duplicate of the Prize-Winning Tube Set*

**T**HE letter printed below is from the winner of the RADIO BROADCAST prize contest held to "determine who has done the best work with any kind of receiver and any number of tubes."

The results were printed in our August, 1923, number. The prize was a De Forest D-10 Reflex set. It is interesting to know that the writer has tested another edition of his set with so much success. Mr. Bartholomew has furnished us with complete verification of the program from KHJ he heard on the night of October 23rd.

Editor, RADIO BROADCAST  
Doubleday, Page & Co.,  
Garden City, L. I.

DEAR SIR:

First let me thank you for the D-10 set and say that it is some machine. My wife has laid claim to it and taken it to Connecticut with her.

I also thought that you might be interested in the fact that I am now making, or rather have made, a machine trying as far as possible to duplicate mine. This machine is for Dr. W. C. Wolverson of Linton, N. D. My purpose is to see if it is the machine that is good, or the location, and I want it tried out well in the States.

Now I know it is possible to duplicate the machine and have it work about the same, for last night I made my first real test with the following results: WLW, WGY, WDAF, KSD, KDKA, WHB, WSB, WBAP, WJAX, WEA, WIP, and WMC and KHJ in Los Angeles.

KHJ, I picked up at 11:55 our time, and held until I stopped working at 12:30. I will enclose a summary of what I heard from them in case you want to check them. I am doing this because I received a few rather questioning letters from the article in the October issue of RADIO BROADCAST and want you at least to feel that I was not stretching it a point.

Sincerely,  
R. Bartholomew  
Garrochales, P. R.

## *When Will Sets Be Sold Really "Complete?"*

**P**LENTY of letters have come in to our office complaining that radio dealers do not quote complete prices to prospective buyers. The set will be "complete," but strangely lacking in tubes, or batteries, or something. There are probably many prospective purchasers, knowing very little of radio, who want a



complete set, and do not want to be bothered with details of tubes, batteries, loops, antennas and whatnot. Dealers who are striving to improve their service can perhaps get an insight into conditions in some localities from the accompanying letter:

Editor, RADIO BROADCAST  
Doubleday, Page & Co.,  
Garden City, L. I.

DEAR SIR:

Intending to buy a radio receiving set for the past several weeks, I have written to several of your advertisers. A few have replied, quoting "list" prices and requesting me to write another firm, their dealer in the district, etc. Those that have quoted real prices seem to quote only on the receiver without the tubes, batteries, etc.

Finally, I went to see a man in an electrical retail store (and I paid him for the time taken by the interview). He said a good plan would be to buy the parts and have a man he knew assemble them. He wrote down a list of articles and said the cost would be about \$50.

I told him that I would see the man he recommended to assemble the set but he refused to tell me where I could reach him, saying that after I bought the articles, he would tell me who he was. As I was leaving, he mentioned that the list of parts he made did *not* include a cabinet.

Now I have gone into some detail in this matter and for a good reason. You can see how much trouble I have had in trying to buy a radio receiver.

Respectfully yours,  
N. A. Brown  
Williamsport, Pa.

*The Position of the Loop Antenna*

Editor, RADIO BROADCAST,  
Doubleday, Page & Co.,  
Garden City, L. I.

DEAR SIR:

For the past year I have been a silent partner in regard to my husband's radio experiments. I have even been supposedly disinterested, but little by little I have absorbed enough knowledge to know an antenna from a ground, a variometer from a variocoupler, and an A battery from a B battery (for we've bought batteries galore).

I know a tube from an electric light bulb, mostly because of the difference in price. I know the difference between just a horn and a loud speaker for the same reason. Audio-frequency and radio-frequency don't phase me any more and as for hook-ups and diagrams I know there are many more to come.

The other night my husband hooked up his favorite five-tube set using a directional loop antenna on

the dining table. He set the loop in the generally accepted fashion as in Fig. 1.

The talk came in clearly but not with any amount of energy. I was rather sleepy but suggested that he turn his loop around 90° as in Fig. 2. At once a most astounding change took place. The voice came in much louder, and as clear as before. We then changed the position of the loop from Fig. 1 to Fig. 2 repeatedly, and always Fig. 2 brought in the better results.

We have now incorporated the square position

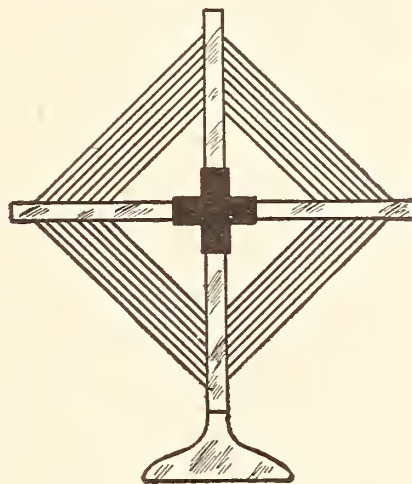

FIG. 1

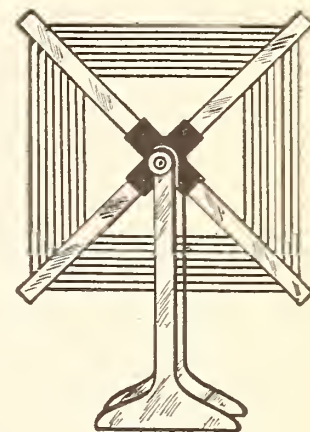

FIG. 2

Which way does your loop work best? Mrs. McArdell prefers the position shown in Fig. 2

idea in a gate-loop on the wall. It swings through an arc of 180 degrees, thus giving every direction needful in a directional loop.

However, it is often desirable to have a portable loop. This could be so mounted that it would be not only directional but would pivot in any position in a vertical plane either as Fig. 1 or Fig. 2 or any degree between the two positions.

Very truly yours,  
ALICE R. MCARDELL,  
Brooklyn, N. Y.

*Attention Announcers!*

THE accompanying letter is one of a great many of similar nature. An effort to correct the annoying omission of call letters by station announcers would undoubtedly be widely appreciated.

Editor, RADIO BROADCAST  
Doubleday, Page & Co.,  
Garden City, L. I.

DEAR SIR:

I am making an appeal for many of my B.C.L. friends who like to "fish" for distant stations. We are greatly disappointed in the stations which fail to announce their call signal after each part of the program. It is most annoying to wait through several long pieces, and then hear—"The next

selection will be—.” WHY *can't* and WHY *don't* ALL stations give their call signal, and also their location, after every item? So many times, for one reason or another, we cannot decipher it, and we vainly wait through another piece until, in disgust, we try something else.

Combinations including B, C, D, E, G, P, Z, etc., are confusing, but we almost always can understand the name of the city and state.

We'd all appreciate it so much, if through the columns of RADIO BROADCAST, which is invaluable to us, you might make this criticism of some of the stations.

E. H.  
Winchester, Mass.

*For Those Who Are Generally Considered Deaf*

IF THE mechanism of a person's ear is completely destroyed, it is of course impossible to produce any sound in a way that is audible to him; but it is safe to say that all the so-called deaf people who can hear with the aid of "acousticons" can also hear radio signals with an ordinary receiver and headset. The handicaps and the loneliness of living in a silent world are something which probably no one with normal hearing can fully appreciate. It should be the duty of all of us, then, to acquaint any deaf people we know with the possibilities for enjoyment which radio may offer them.

Editor, RADIO BROADCAST  
Doubleday, Page & Co.  
Garden City, L. I.

DEAR SIR:

It is quite generally known that deaf persons are often able to carry on a telephone conversation with little, if any, difficulty. Even though the deafness is so acute that they can hear only when spoken to in a loud tone, a telephone conversation, particularly with one whose voice is familiar, can be heard readily. It apparently has not yet become common knowledge even among radio "fans" that a person who is so deaf as to be unable to hear even a brass band can hear the sound of the voice and music from broadcasting stations.

Experiments were first made on a standard regenerative set, variocoupler and two variometers, with two stages of amplification using UV-200 and UV-201 tubes. The set was tuned to a point where the signals roared and could be heard all over the house. The location was about thirty miles from station WEAf and a few miles more from WJZ (at that time at Newark, N. J.) Several makes of phones

were tried with apparently a slight difference in favor of a pair which had a tone which was decidedly "tinny." Good results were obtained with other phones, but those having a soft tone were not successful. At first, the only signals recognized, by a person ordinarily considered deaf, were the names of the stations, but as the voices of the announcers became familiar the announcements and weather reports were readily understood. The best reception of musical numbers appeared to be a single voice with piano accompaniment, a tenor voice being a little clearer than a soprano.

Another set comprising three stages of radio, detector, and two stages of audio was built, using D-X radio transformers, Acme audio transformers with UV-200 for detector and UV-201 for both radio and first stage of audio with a 216-A in second stage. This combination gave considerably more volume and a much clearer tone. On this set, the numbers heard included grand opera, church services, speeches, concerts, and orchestras.

A great variation was observed in the reception of voice. No speaker was heard so clearly and distinctly as the announcers. In general, it seems that a man's voice is more readily understandable than a woman's. A speaker who clips his words short and whose voice rises and falls is recognized only as a man talking but is not understood. Reading from a book or other copy is not as clear as a speech, probably because the reader looks at his copy instead of at the transmitter. Familiar music or singing is better understood than something the listener does not know, and the simpler the better. No one who is actually "deaf as a post" should expect to start on music by Debussy, for instance, and be able to hear and understand it. For those whose nearest and most powerful broadcasting station happens to be one that gives the weather reports, there is probably nothing better on which to make a beginning.

These experiments were made with a person so deaf as to be unable to hear the shouting at a ball game, a military band, or any other known sound. *Absolutely no results were obtained with loud speakers.* As nothing is heard until the set is tuned to nearly its greatest volume, it is necessary at first to have someone who can hear tune it, but after becoming familiar with the operation of the set and noting the position of the dials, the deaf person can tune the set without assistance. The volume of sound is such that no one with normal hearing can wear a headset and the only way those who are not deaf can listen comfortably at the same time is to leave another pair of phones on the table at a distance of several feet.

Yours very truly,  
BEECHER OGDEN.  
Pleasantville, N. Y.

## How Germans Use Radio at Auto Races

THE throng of bankers, betters, beggars, and others who line the Grünwald automobile race-course near Berlin are able to follow the progress of their favorite dare-devils at all points in the long course.

The racers are clocked as they pass the umpires' stand and their time is transmitted, by means of a 30-watt tube set, to a number of other timers' booths at scattered points along the track. An attendant at each one of these outposts chalks up the time on a bulletin-board for the edification of the onlookers, who otherwise would not know what was going on over the considerable part of the course not within their range of vision. The timers at the booths also advise the umpires by radio telephone of the readings on the drivers which pass their stations. The wavelength band used in this communication system is 200 to 1,000 meters.

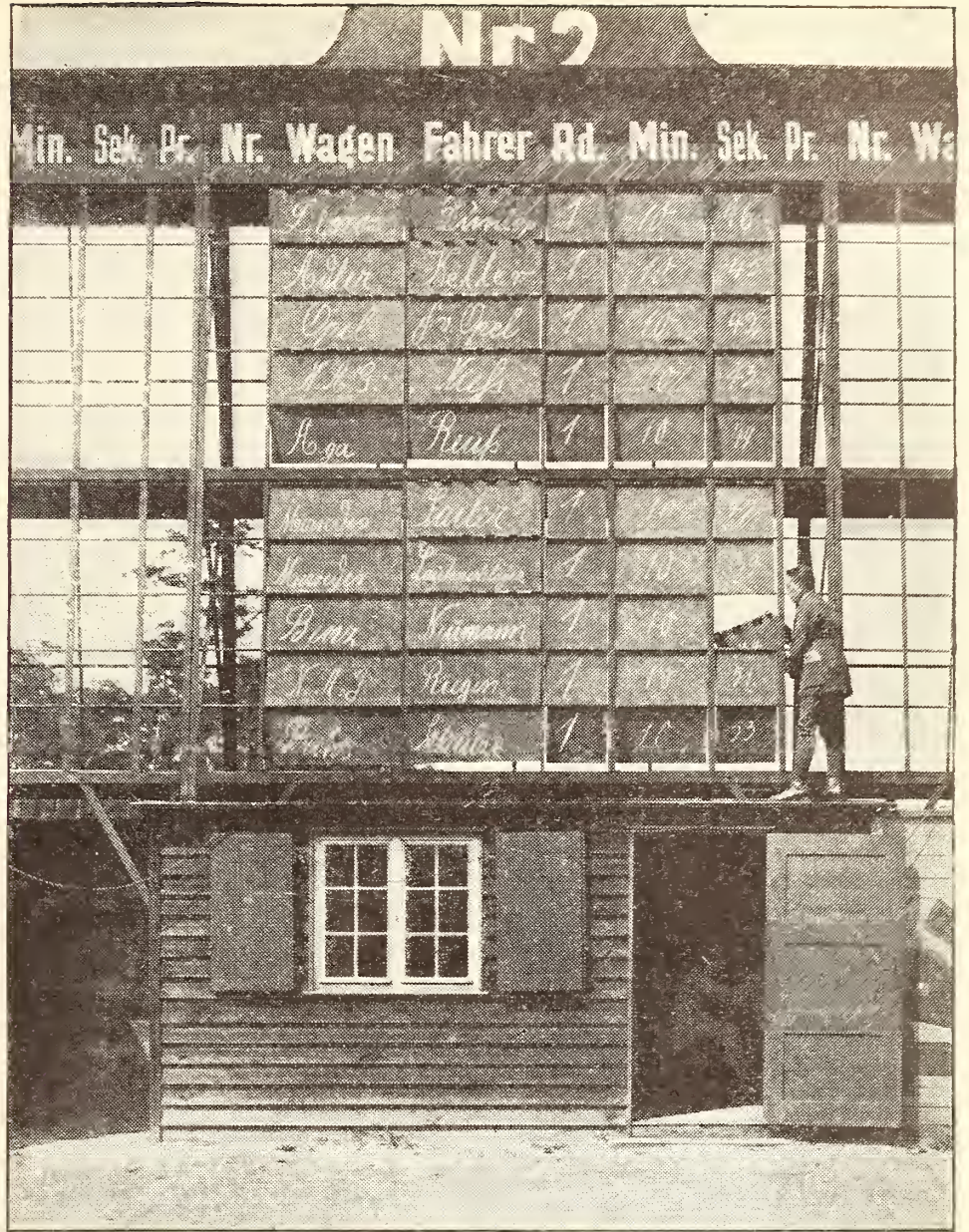

HERE THE RACERS ARE TIMED AND SCORED  
The operator can be seen just inside the door

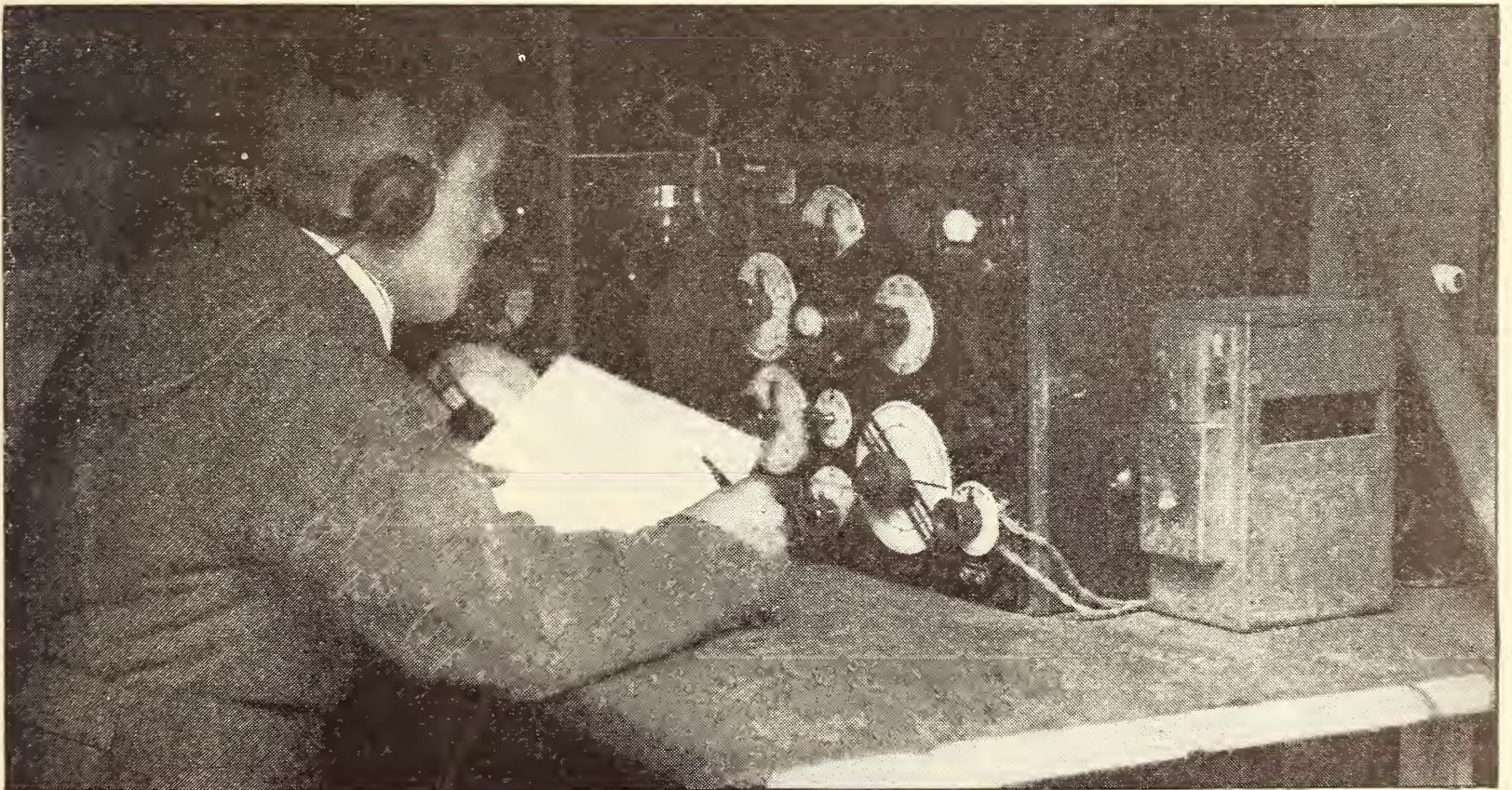

THE GERMAN RACE-COURSE OPERATOR AT HIS SET  
A thirty-watt tube set is used for communication with the judge's stand

# What Radio Means to Me

By W. FRANCIS GOODREAU

And the night shall be filled with music,  
And the cares that infest the day,  
Shall fold their tents like the Arabs,  
And as silently steal away.

*Longfellow.*

SOMEHOW, whenever I think of radio I also think of these lines by Longfellow; they express so well something of what radio means to me. After having spent almost three years in a hospital, I know what a boon radio has proved to me and others in hospitals.

I entered the hospital in November, 1920. At that time radio was very little used for entertainment purposes. To take up my time and pass the weary hours away, I tried many things such as basket-making and reading, but nothing seemed to satisfy me for any length of time. Something else was needed to make my stay in the hospital more pleasant, something that would grow more interesting day by day.

I was wondering what to do next, when I was told that we were to have a radio concert. As I had never heard music by radio, I was naturally impatient for the concert to start. It was given through the kindness of Troop 5, Providence Boy Scouts. They used a set with a two-stage audio amplifier and loud speaker. The concert was given in a large ward, but the music could be heard plainly in every corner. The concert lasted only about one hour, but I received more enjoyment in this one hour than I had ever had in any one hour in the hospital.

Thus I received my introduction to radio. From that day I have been, and always will be, a radio "bug." I decided I would have a radio set, but was a little puzzled how to get one. I had almost decided to purchase an outfit when I was told by a friend that it was easy to make a simple crystal receiver. That suggestion appealed to me, for I could while away much of my time in making it. By making my own I would be sure to get a better idea of radio and would perhaps enjoy a simple receiver that I had built myself more than one I might purchase. I secured several books on radio, from which I got at least a faint idea of radio sets and

how to build them. I decided that a two-slide tuner was what I wanted. I secured the material and built one. Strange to say, it worked, and I must confess that my first radio set gave me more pleasure than all the radio sets I have had since.

I used this set for some time and then decided that I had outgrown it. I had heard that a two-circuit tuner would give better results, so I built one. It worked splendidly, so I commenced to study radio in earnest; I studied radio books on an average of five hours a day. At last I had found what I had been seeking, that something which should pass time away and give greater pleasure the longer I worked with it.

In the daytime I studied my books and worked on my radio set; at night I listened to music until I became tired and went to sleep. I had been using this radio set (the two-circuit one) for about two months, when I thought I could undertake a tube set. I purchased several new parts and built a three-circuit regenerative set using a WD-11 tube given me by a friend. I was somewhat disappointed with this set because, like many other beginners with a tube set, I expected too much of it at first. I expected to hear stations a thousand miles away the first night, but I didn't. In fact, for the first week I heard nothing that I could not hear on my crystal set. However, as time went on, I became more expert. Soon I found no trouble in reaching every evening those stations that I had long wanted to hear.

To share my pleasure with the others in the hospital, I found I would need a two-stage amplifier and some kind of a loud-speaker. Well, the two stage was soon secured and a friend kindly loaned his loud-speaker. Permission was obtained for us to give a concert one Sunday evening in a ward. As there was a good program scheduled, we made our initial bow under favorable conditions. This

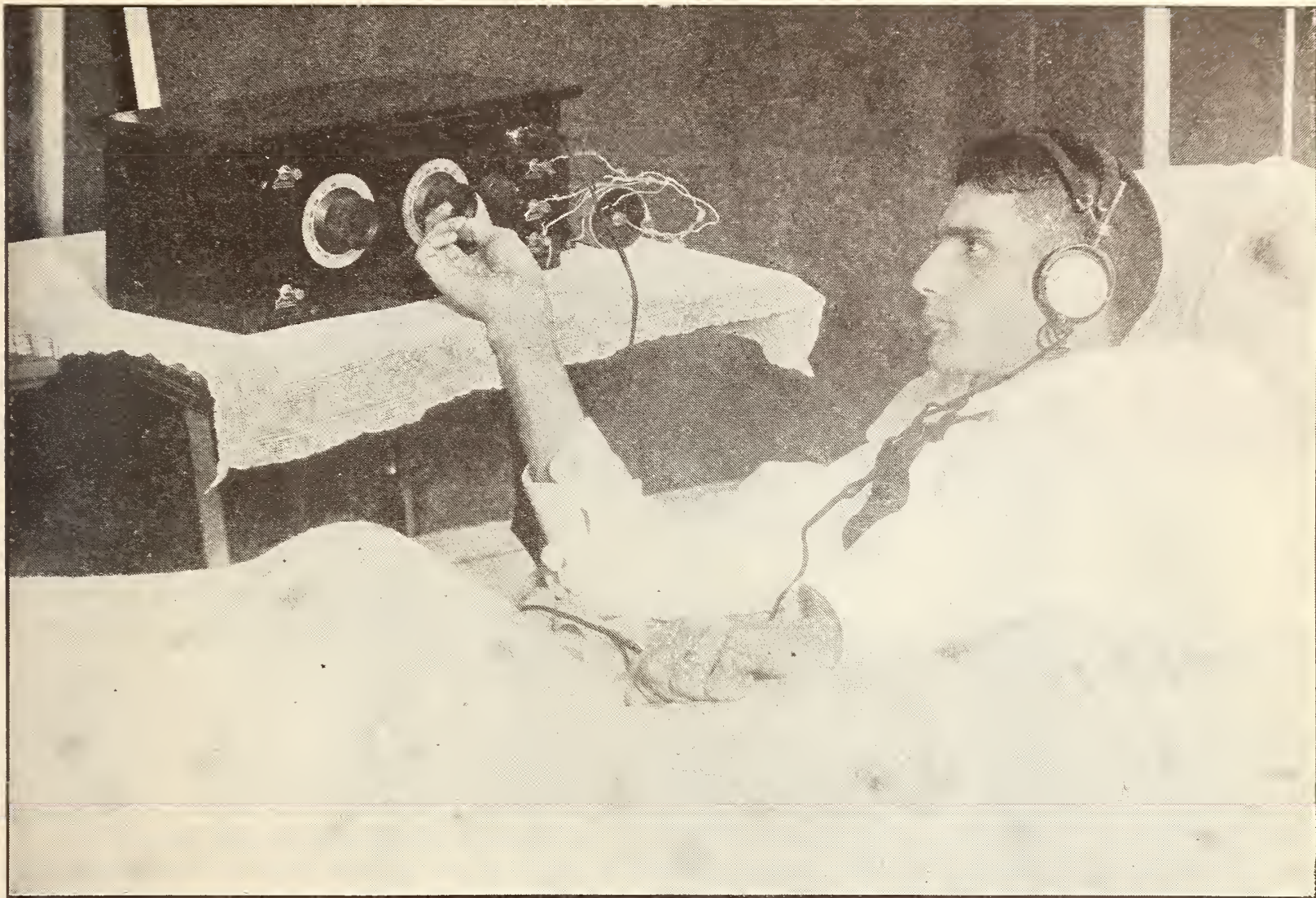

THE WIDE WORLD BUT TWO FEET AWAY

concert consisted of selections by one hundred harps, vocal selections, etc. The patients told me that they enjoyed it a lot. Some of them decided that they would like to have radio sets and asked me if I would help them make them. I did, and soon there were twelve sets in our ward. No one but those who have had the experience can ever know how much enjoyment radio is giving to those who are shut in.

To the person shut in, radio means more than just a new means of hearing music. Although the music we hear is excellent, the greatest benefit we derive from radio is *the feeling of intimate touch with the world*. We cannot go to the theatre nor the ball game, but

thanks to radio they can and do come to us. A turn of the wrist and we have our choice of entertainment for the evening.

Truly radio means much to me. Those in charge of our hospitals are coming to realize how much radio can help them in their great work, and as fast as they can, they are installing radio for the benefit of those in their care. Unfortunately, many hospitals have not the funds to install radio. However, I am sure when it is realized just how much radio means and how much good it can do, the funds will be found somehow. Radio began to interest me eighteen months ago and to-day I realize it has filled a place in my life that nothing else could ever do.

## What Would You Like to Have in RADIO BROADCAST?

*The editors would be pleased to hear from readers of the magazine on the following (or other) topics:*

1. *The kind of article, or diagram, or explanation, or improvement you would like to see in RADIO BROADCAST.*

2. *What has interested you most, and what least, in the numbers you have read so far.*

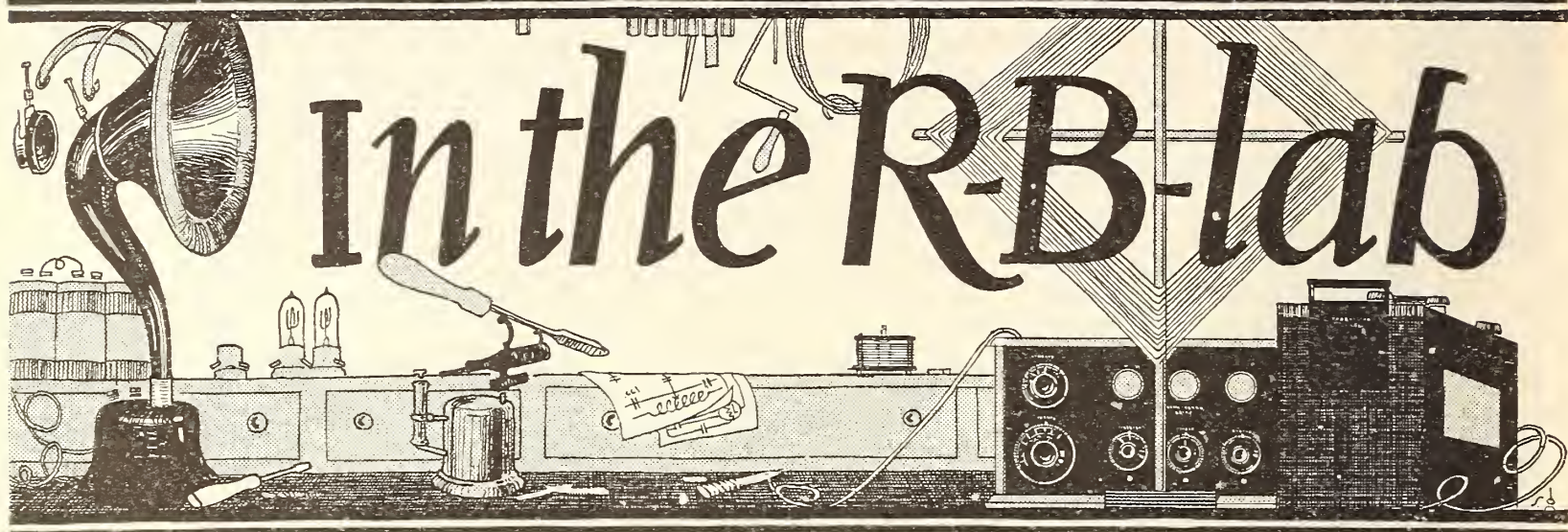

So much corking good Lab material is piling up that we are forced to devote more space to it this month than we originally intended it to occupy. Our successful experiments with the apparatus described, and the many letters of inquiry, appreciation, and suggestions that have come to our office since the R. B. Lab was started, in October, persuade us that we could not employ these pages to better advantage.

Upon observing the one-tube reflex circuit in operation and seeing a sample of a Ballantine Variotransformer sent us for test, Mr. Zeh Bouck, Editor of the R. B. Lab. suggested the unique arrangement he describes below. We then asked the manufacturers of the transformer to build up a circuit in the manner described. A comprehensive report from that company indicates that the results obtained check with our own, and that the Variotransformer works about as well in the circuit as the radio-frequency transformer and variable condenser combination described in R. B. for November and used by Mr. Bouck.

RADIO BROADCAST will be pleased to buy from its readers, at prices from three to five dollars, commensurate with the value of the data, kinks, devices, original ideas, etc., with photographs if possible, which the editor may consider eligible for this department.—THE EDITOR

## IMPROVING THE ONE-TUBE REFLEX SET

**T**HE article by Mr. Kenneth Harkness, in the November RADIO BROADCAST, on the best one-tube reflex set that has ever been brought to the attention of this magazine, furnished the Lab with material for additional experiments. The object of the tests was the elimination of the predominant and admitted defect of such sets, namely the tendency toward self-oscillation. This fault was overcome to a considerable extent in Mr. Harkness' set, and though remarkably stable for apparatus of this type, the set will nevertheless oscillate at certain adjustments on the radio-frequency transformer (T<sub>2</sub>, page 14, RADIO BROADCAST for November). These adjustments are: (1) when the single tuning condenser across the secondary of the transformer does not effect sufficient resonance between the primary and secondary (when they are not tuned sufficiently near to the same wave), and (2) when a high-resistance contact is made by the cat-whisker on the crystal detector, an adjustment, incidentally, which is often the most sensitive one.

The reason for oscillations at such adjustments is this: If a circuit has a tendency to oscillate, such as is a characteristic of the plate circuit of the bulb in the one-tube reflex, and another resonant circuit is coupled to it, so much energy will be absorbed by this second circuit that not enough will remain to sustain oscillations. But of course the moment that this second circuit is detuned (or imperfect resonance is established, as often happens with the single tuning condenser), or the circuit is opened (as is virtually the case when the resistance of the crystal detector contact, which is in series with this additional circuit, is raised very high), oscillations will start.

However, these difficulties would be obviated if the transformer unit could be so arranged that there would always be so perfect a resonance between the primary and secondary windings, that even with a high-resistance crystal contact, sufficient energy would be absorbed to smother oscillations. The development of the Ballantine Variotransformer, which is a tunable radio-frequency amplifying trans-

former having a range from 200 to 600 meters, suggested this instrument as the solution to the problem. This transformer has both primary and secondary continuously variable by turning a single knob, and both windings are always tuned to the same wavelength, i. e., in resonance with each other!

Fig. 1 shows the set as made up under the supervision of the R. B. Lab and in which our theory was maintained beautifully in practice. The circuit is identical with that shown on page 14 of the November RADIO BROADCAST, except that the Ballantine Variotransformer is substituted for T<sub>2</sub>, and, of course, the variable condenser across the secondary of T<sub>2</sub> is not used.

#### WHAT THIS SET WILL DO

ON THE single tube shown in the photograph and on the diagram, it will bring in signals more loudly and clearly than a one-tube, single-circuit regenerative set. Reception is generally superior to that achieved with the set described by Mr. Harkness in the November RADIO BROADCAST.

With one exterior stage of audio amplification, it will bring in local broadcasts so as to fill a large room (the single tube itself will actuate a *good* loud-speaker) giving a volume exceeding that of the average regenerative set with two stages of audio amplification.

It gives signals of remarkable clarity, with freedom from crackling sounds (excepting static, of course) and other extraneous sounds.

It will tune sharply with a minimum of effort, and with greater ease than any single-circuit regenerator.

#### WHAT THIS SET HAS DONE

(The following four paragraphs, by the Editor of this magazine, indicate what he, personally, has done with the receiver under discussion.)

WE HAVE tried this one-tube reflex with all kinds of tubes in all kinds of places. In every case it has proven to be a "knock-out." On Long Island, 23 miles from New York, we have heard two stations in Chicago on a loud-speaker, using a 60-foot antenna and a single UV-199 tube with about 80 volts on the plate. The music was not loud enough to dance to or keep the neighbors awake, but it could be heard in a room of moderate size. Speech was perfectly understandable, and several of our friends who witnessed the performance were as amazed as

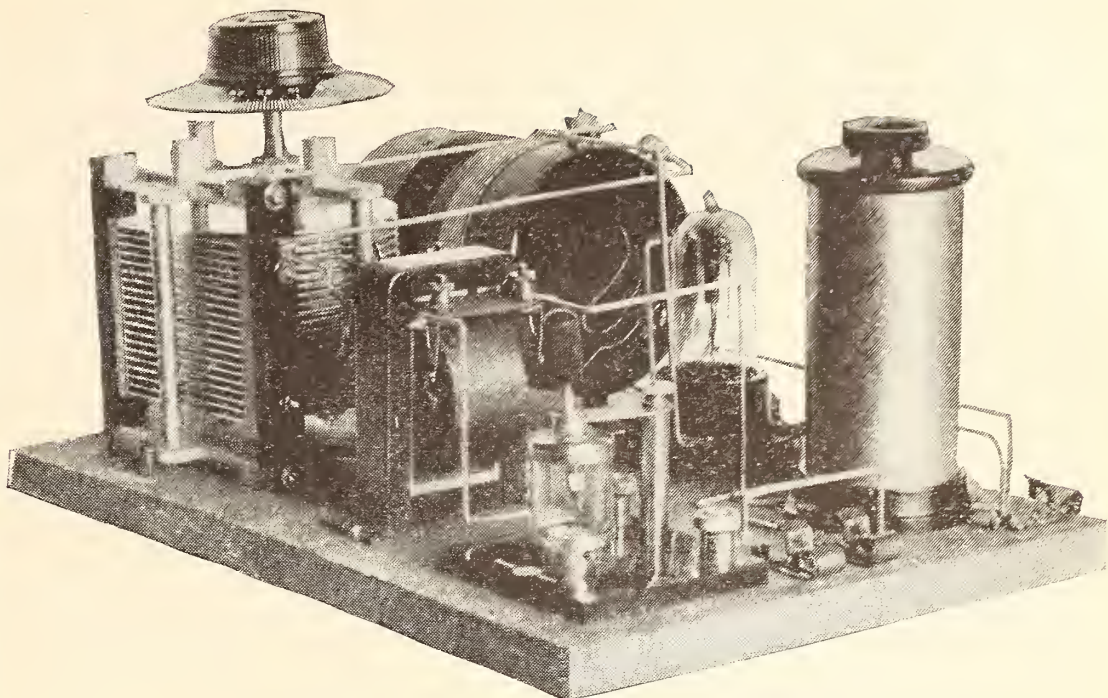

FIG. 1

Showing the one-tube reflex circuit made up by the R. B. Lab. The Ballantine Variotransformer is used. We reprint the original circuit diagram on page 218

we were. Truly, we did not expect such results. To date, we have heard (from Garden City, L. I.) KDKA, WGY, WJAZ, and WDAP on a loud-speaker, with the equipment described above, which is not too bad. The local stations can be heard on a loud-speaker either night or day and many other long-distance stations have been heard on the phones.

During the radio show in New York, some of our out-of-town friends were anything but polite in letting us know that our enthusiastic statements regarding this one-tube reflex were taken with a grain of salt. One went so far as to say, "Radio and golf will surely make liars of us all." That was the last straw. We took a train for Long Island, grabbed our little set from the living room table, amid shouts of objection from an erstwhile happy family, and returned to New York. We made directly for the room of our friend, our pockets jammed with dry cells, B batteries, a pair of phones, and a coil of annunciator wire. Under one arm we carried the receiver; under the other a loud speaker.

In a few minutes all the connections were made. A cuspidor-weighted wire swung from a window on the twenty-first floor of an exclusive New York hotel. We were less than two blocks (or squares) from the powerful broadcasting station of the Radio Corporation at Aeolian Hall. We had no trouble in tuning out that station and bringing in other New York stations on the loud speaker—which does not speak badly for the selectivity of the receiver!

#### WHAT THIS SET WILL NOT DO

THE set will not oscillate, or "spill over," to your own annoyance and that of your neighboring enthusiasts (except as described above).

It is apparently immune to body capacity effects, shielding being quite unnecessary.



FIG. 2

The one-tube reflex described below. It will operate a loud speaker on local stations

For a description of the parts, other than the Variotransformer, and for constructional data, the reader is referred to the November issue of RADIO BROADCAST. This set can be mounted on a panel, the Variotransformer being made in panel-mounting style.

### THE ONE-TUBE REFLEX WITH A BALLANTINE VARIOTRANSFORMER

(Report by Dr. L. M. HULL of experiments conducted by him at Radio Frequency Laboratories, Inc., Boonton, N. J.)

THE circuit described in the article "A Single-Tube Reflex Receiver" has been assembled and tested, using as the radio-frequency transformer,  $T_2$ , a Ballantine Variotransformer, Model 5. Transformer  $T$  (refer to Fig. 1 in the above designated article) was constructed for our test circuit according to the specifications supplied by the writer. The transformer,  $T_3$ , was a General Radio "Amplifying Transformer" having a turn ratio of approximately 4:1. A type UV-201-A tube was used, with approximately 80 volts on the plate.

As a crystal detector we used alternatively an iron point on iron pyrites or a combination of pyrite and ferro-silicon which we have found to possess particularly fine rectifying qualities.

Assuming that the main point of interest is the performance of the circuit containing a Variotransformer relative to its performance with the transformer specified in the article, a second tuned transformer was constructed according to the specifications supplied for  $T_2$ , and for purposes of comparison this transformer (which will hereafter be designated the " $T_2$  coupler") was substituted for the Ballantine Variotransformer at given adjustments of the crystal detector. For the reception of signals an antenna and counterpoise were connected between terminals A and G\* hav-

ing in combination an effective capacity of 700-500 micro-microfarads between 300 and 600 meters and an effective resistance varying from 13 to 16 ohms in this wavelength range.

When this circuit was excited by a locally generated modulated radio-frequency E.M.F., the Ballantine Variotransformer produced an appreciably greater amplification than the  $T_2$  coupler at wavelengths between 300 and 400 meters, indicated by a louder signal in a head set connected between the jack terminals (see Fig. 1, page 218) as well as by the production of an audible sound with the Variotransformer from a signal so weak as to be inaudible with the  $T_2$  coupler: there was no appreciable difference in selectivity in this range. Between 400 and 500 meters the signal intensity appeared to be very closely the same with either radio-frequency transformer. It was possible, by selecting a high-resistance contact on the crystal to force regeneration to the point of strong sustained oscillation with the  $T_2$  coupler, thereby increasing the sharpness of tuning above that obtainable with the Variotransformer. The circuit containing the Variotransformer was by far the more stable of the two, since it was found to be impossible to throw the circuit into oscillation with any adjustment of the crystal and

\*Shown in diagram on page 218.



any tuning combination. At wavelengths above 500 meters there was no apparent difference between the behavior of the two circuits, although in subsequent tests signals from spark transmitters on 600 meters were received with appreciably greater intensity when using the Variotransformer.

In comparative reception tests, telephone signals were received from the New York stations (distances from 30 to 35 miles), from Chicago, Schenectady, and Buffalo. At the lower wavelengths, transmitted by WHN and WGY, signals were received with slightly greater intensity when using the Variotransformer. At wavelengths above 400 meters there appeared to be little choice between the two transformers, as regards intensity and quality of the sounds produced.

One difference between the behavior of the two circuits was noticed, however, in that the tendency of the circuit toward self-oscillation when using the  $T_2$  coupler depended largely upon the nature and location of the detector contact, whereas no oscillations whatever were produced when using the Variotransformer. Thus with the Variotransformer

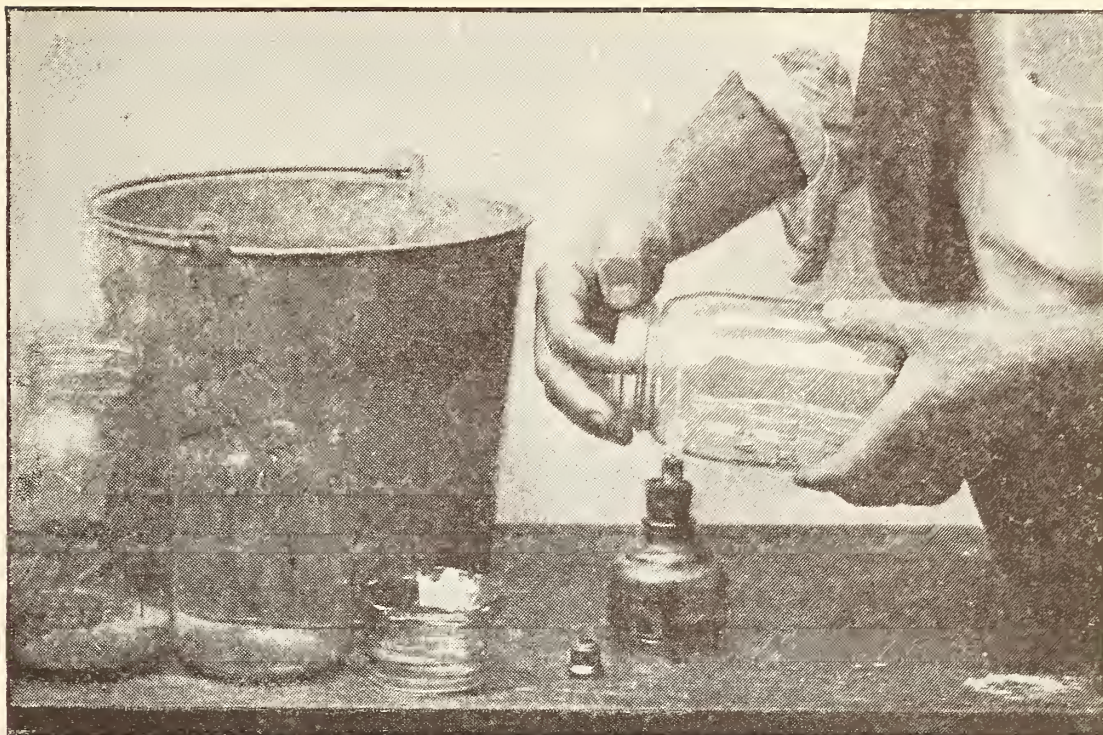

FIG. 4

Removing the top from the preserve jar at the shoulder

the tuning adjustment was entirely independent of the adjustment of the detector for sensitivity, and this stability and relative ease of operation were not offset by any appreciable decrease in the relative signal strength.

No quantitative measurements were made of the signal intensity obtained with the Variotransformer in this circuit. The programs broadcast by stations WEAJ and WJZ on the night of October 12th were received on this circuit and reproduced with good intensity in a high-impedance loud speaker.

## THE DANIELL CELL AS AN "A" BATTERY

By DR. E. BADE

THE dry cell is not an ideal source of power for any closed-circuit work (i.e., where current is being consumed steadily) such as is encountered in the lighting of low-amperage filaments. The production of electric current in a battery, wet or dry, is accompanied by a chemical action within the cells, one of the elements being gradually destroyed as the current is generated. The best type of cell is that which permits an almost total destruction of the at-

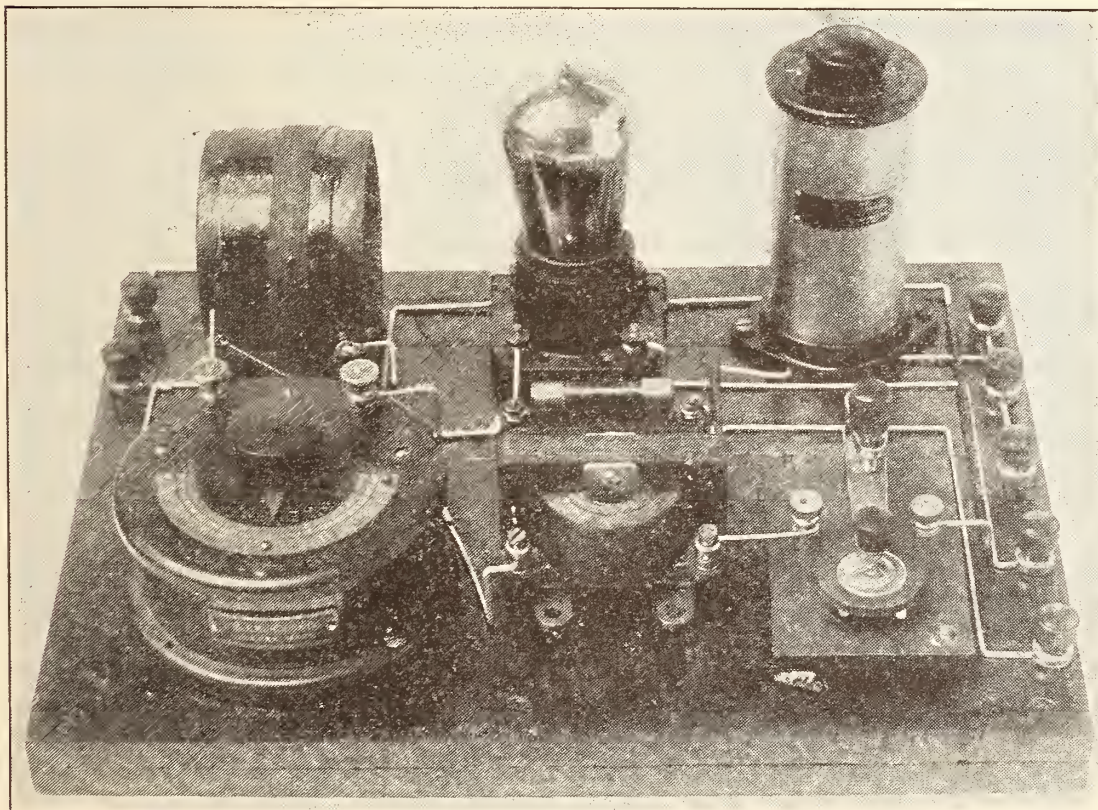

FIG. 3

The set made up by Radio Frequency Laboratories, Inc., showing the primary of the antenna coupling (See Fig. 1, page 218) wound over the secondary. In the R. B. Lab's model (p. 237) the two windings are laid on side by side

tacked element before its efficiency, or current generating ability, is seriously impaired. In the dry cell, the outer zinc case (the element which decomposes) is only slightly eaten away before the cell is rendered useless by either polarization or the drying up of the salt filling compound. If such a cell could be used until the zinc were totally destroyed, its life as a radio A battery would be prolonged many months.

The making of a cell which will give a strong electric current until the zinc is considerably decomposed is neither difficult nor expensive. A set of six such cells, each giving about 1.1 volts, can be made at home for approximately the cost of four dry cells. The dry cells will give the same total voltage but have a much shorter life. Such a cell is that of which the Daniell battery is composed (a "battery" is merely two or more cells) and is easily made according to the following directions:

#### THE MATERIALS

Six neckless quart jars  
 Three ounces of mercury  
 Four pounds of plaster of Paris  
 Six sheets of zinc  $7\frac{1}{2}$ " by 8"  
 " " " copper 3" by 6"  
 Two pounds of copper sulphate  
 Eight ounces of sulphuric acid

The jars may be easily made by removing the necks from Mason or quart preserve jars. A line is scratched with a glass cutter around the shoulder of the jar. The scratch is then moderately heated over an alcohol or bunsen flame (Fig. 4) and the top of the jar immediately dipped into a pail of cold water. The shoulder of the jar should crack at the scratch and fall into the water, leaving a very satisfactory battery jar, such as is shown alongside the pail in Fig. 3.

The porous cup of plaster of Paris is next made. A heavy paper cylinder with a bottom

is formed for the outside of the mold. This, for the quart size jar, should be about 7" high and  $2\frac{1}{2}$ " in diameter. A smaller tube,  $1\frac{1}{2}$ " in diameter, is also made. The plaster of Paris is mixed in a convenient bowl (mix, at a time, only as much as is immediately needed) to a paste-like consistency. This is poured into the large paper cylinder until the bottom is covered to a depth of one-half inch; the smaller tube is now placed in the middle of the larger one, and the plaster of Paris poured in between the walls until a complete cup is formed (Fig. 5), when it is permitted to harden.



FIG. 5  
Molding the porous cup

The zinc electrode (negative pole) is now prepared. The sheet is first thoroughly cleaned by wiping with a dilute solution of sulphuric acid. A drop of mercury (quicksilver) is then placed on the zinc and "rubbed in" with a piece of cotton moistened with the dilute acid. Both sides of the zinc are similarly treated, the coating of quicksilver forming an amalgamation with the zinc. The amalgamated zinc is rolled into a cylinder that will fit over the plaster of Paris cup, and a wire either soldered or bolted to one corner. The joint between the wire and the zinc should be coated with beeswax or vaseline.

The positive pole or copper electrode is also a cylinder (or it may be merely a strip), but should be made smaller, so as to fit loosely within the porous cup.

One quart of a saturated solution of copper sulphate should be made up. This is most easily accomplished by heating the water to just below the boiling point and dissolving in it, by vigorous stirring, all the copper sulphate crystals it will take up. Some of the blue crystals will be precipitated upon cooling, showing that the solution contains all that can be dissolved.

The battery may now be assembled. The jar is half filled with water to which are added a few drops of sulphuric acid. Fig. 6 shows the

cell being put together, the zinc element standing alongside the jar with the dilute acid solution, and the porous cup in the act of being placed in the center of the glass container. Several completed cells are shown in the photograph.

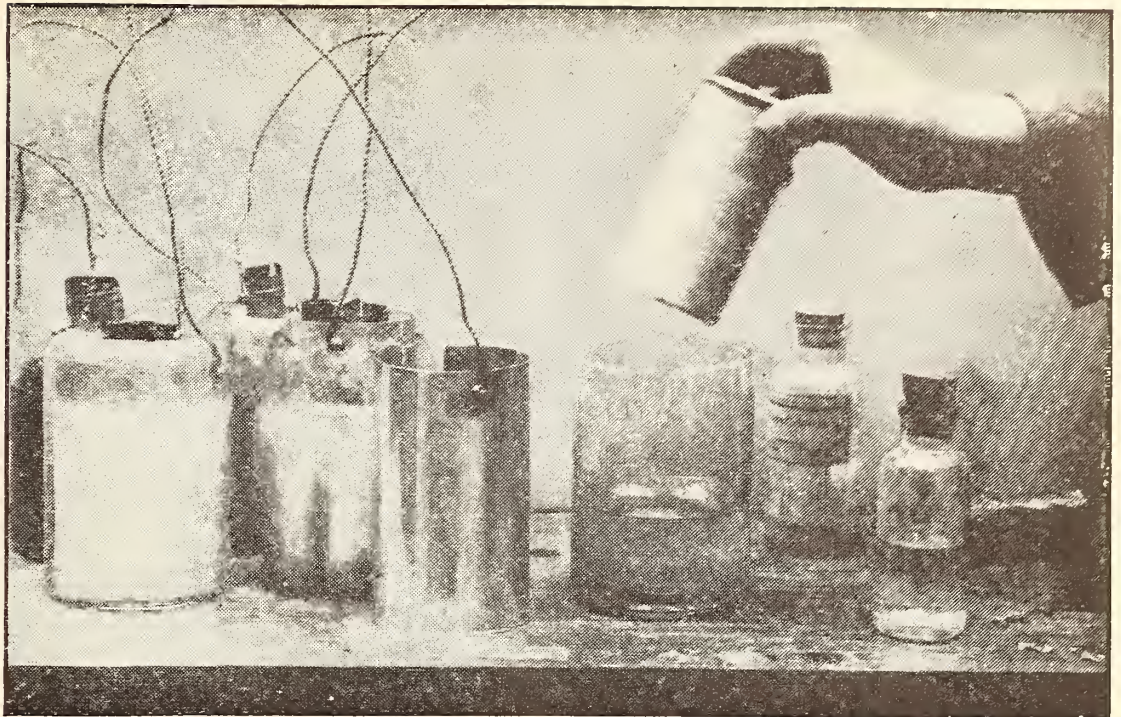

FIG. 6  
Assembling the cell

When the plaster cup is placed, the zinc sheet is fitted about it, and the copper electrode placed inside of it. The sulphate solution is poured about the copper element, and a few extra sulphate crystals thrown in, which are replenished from time to time. The cell is now ready for use as soon as the few minutes elapse necessary for the plaster of paris to absorb the required amount of the solutions. It is a good idea to short-circuit this cell for several hours immediately after assembling.

The Daniell cell is a closed-circuit cell, and will give its best service when used almost constantly, day after day, four and five hours each evening. Three cells make an excellent battery for the UV-199, while a single cell, without rheostat, may be used on the WD-11 and WD-12.

When the zinc is practically eaten away, the internal resistance of the battery becomes very high, and it is, at last, necessary to renew the elements of the cell. New solutions and zinc should be added, at a cost of a few cents, and

the cell is again ready for long and steady service.

### A "SUPER" WAVE-CHANGER FROM A THREE-CIRCUIT REGENERATIVE RECEIVER

Recently, we've had a few hunches on the building of super-heterodyne receivers from parts such as those that the average experimenter already owns. (We refer you also to the timely and well-executed articles in the November and December, 1923, numbers by George J. Eltz, Jr.) And below we present the results of some work of our own on a home-made "super." Some of the illustrations have appeared in RADIO BROADCAST be-

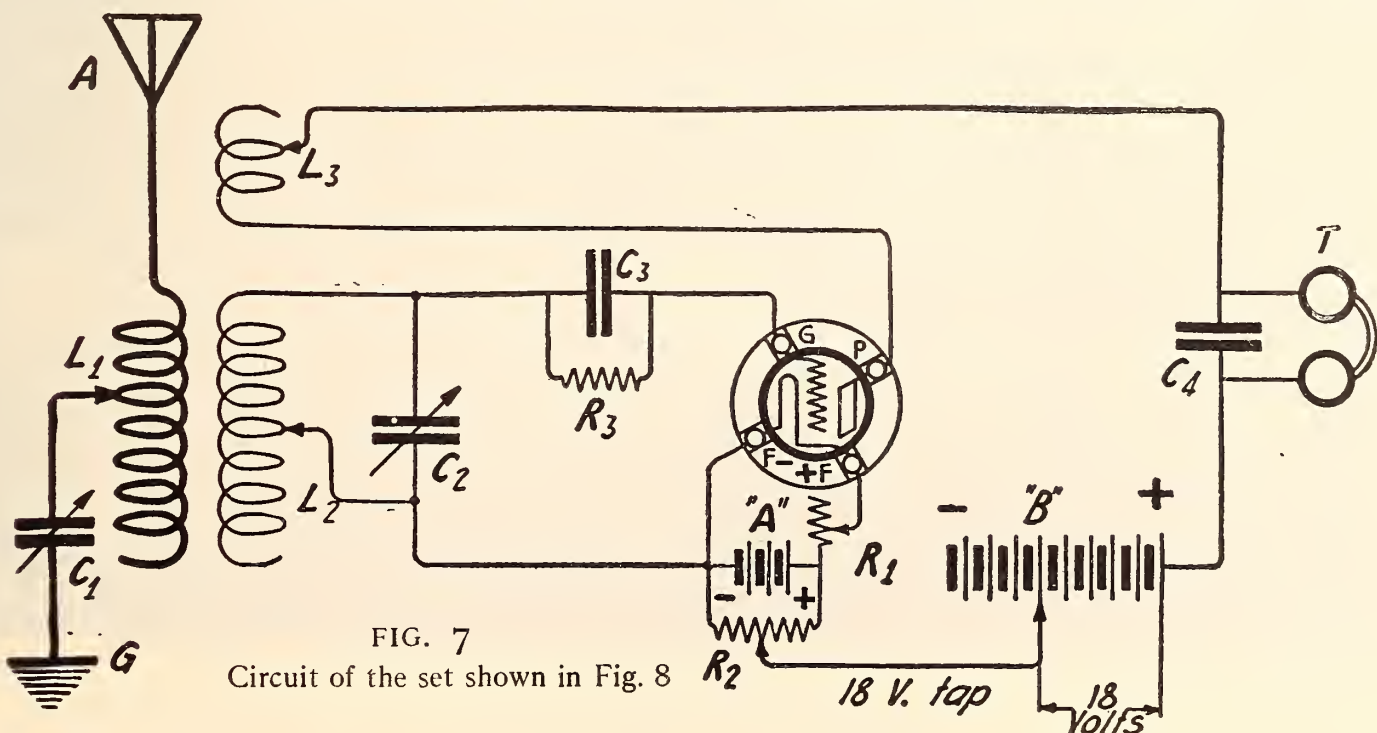

FIG. 7  
Circuit of the set shown in Fig. 8

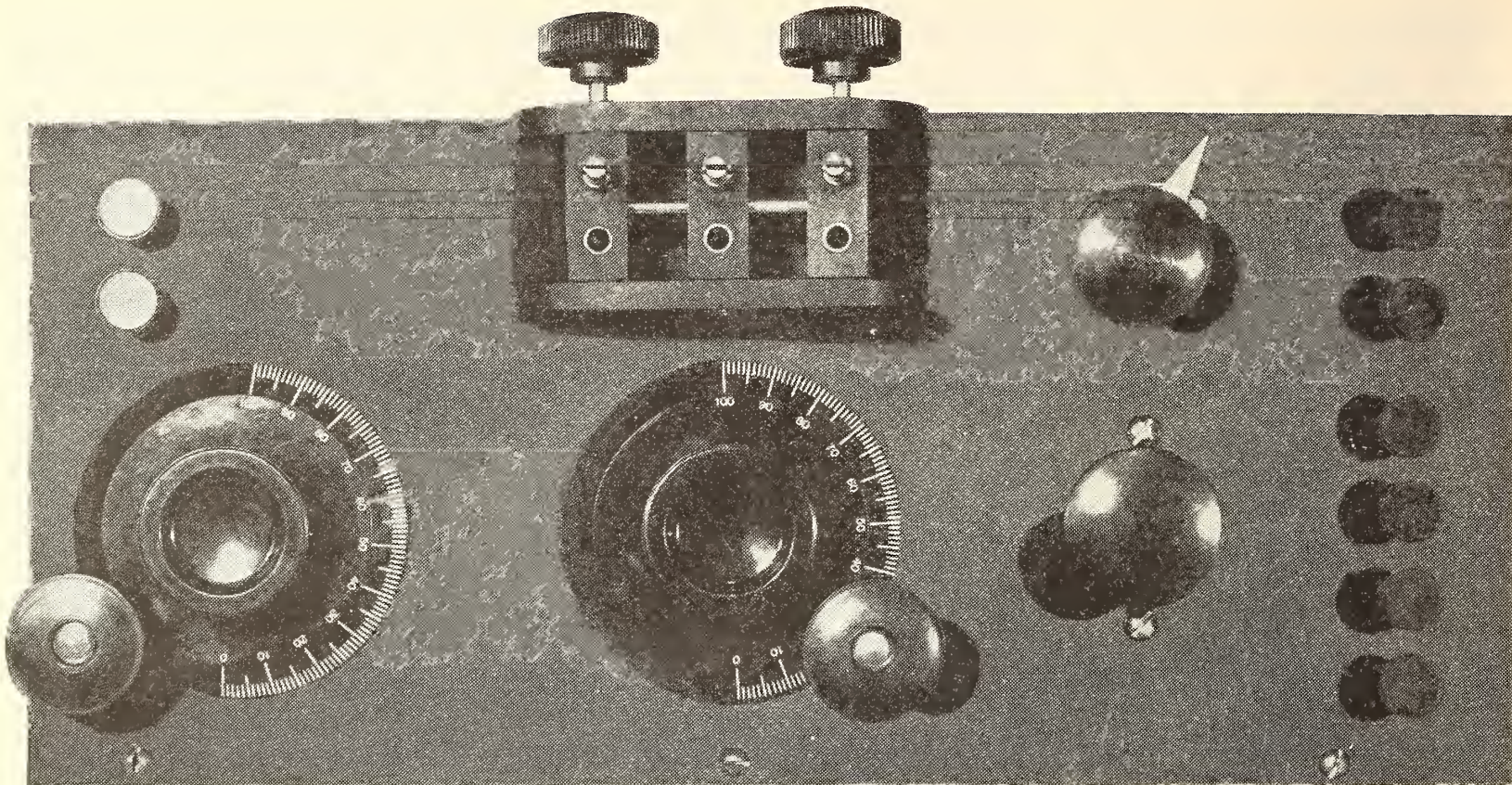

FIG. 8

The three-circuit receiver before being converted (see Figs. 9, 10, and 11. This receiver was described on page 136, RADIO BROADCAST for December, 1922). The upper left hand posts are for antenna and ground, and are replaced by a jack (upper right in Fig. 12) into which the loop aerial is plugged

fore; in fact they were used to illustrate A. Henry's article, "Paris and Honolulu Are Calling You," in our December, 1922, number. We have converted Mr. Henry's three-circuit regenerative outfit (Fig. 8) into a wave-changer simply by the addition of a tube socket, a two-coil mounting, and two large coils to couple the output of the wave changer to the intermediate-frequency amplifier. By combining this wave-

changer with such a circuit as illustrated in Fig. 1 of Mr. Eltz's article (p. 145, Dec., 1923), we have a complete super-heterodyne.

Fig. 10 shows the panel with coils mounted. The two upper left-hand posts connect to a loop. The diagram (Fig. 11) shows the connections. The layout has been altered very little. The diagram shows clearly the values of duo-lateral coils employed. A new

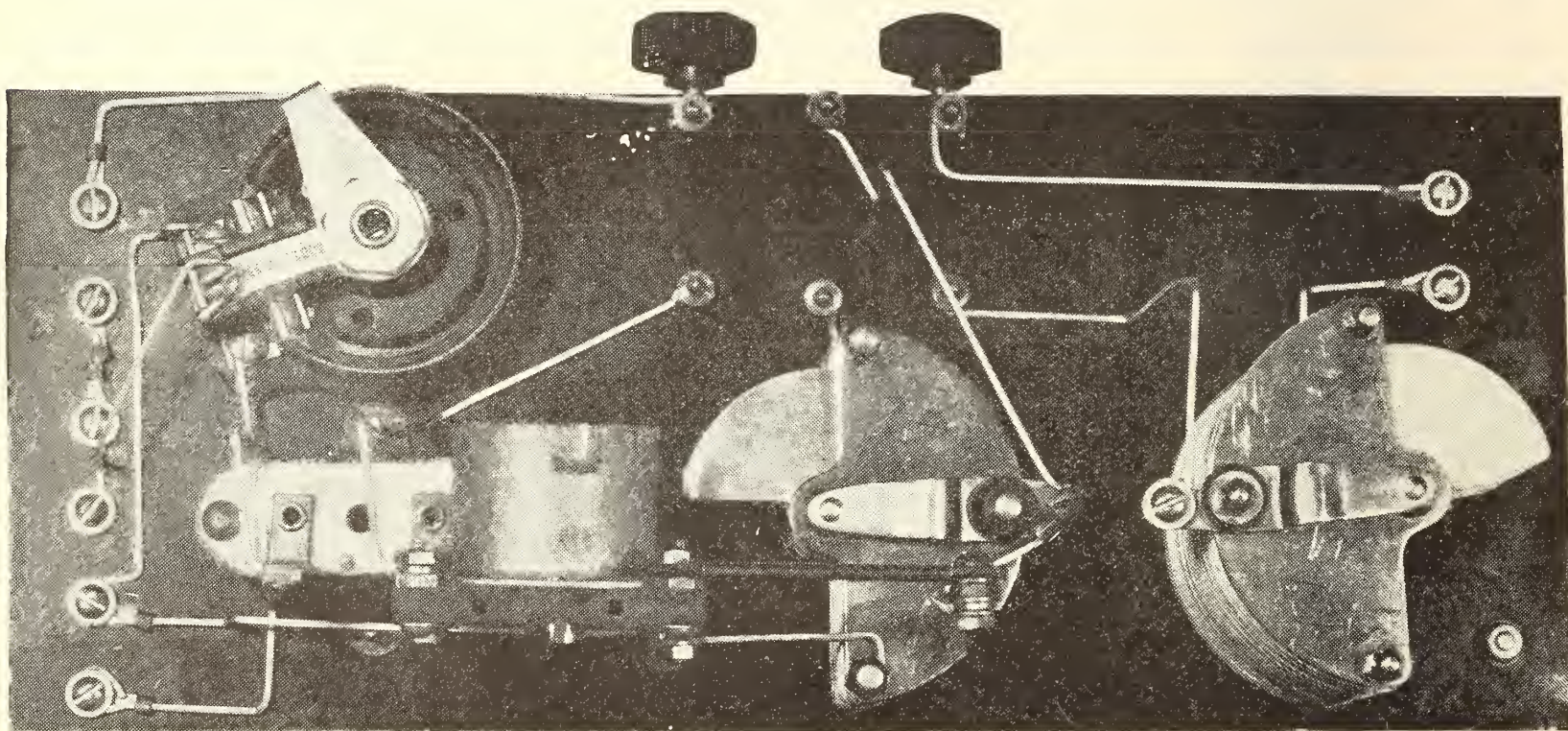
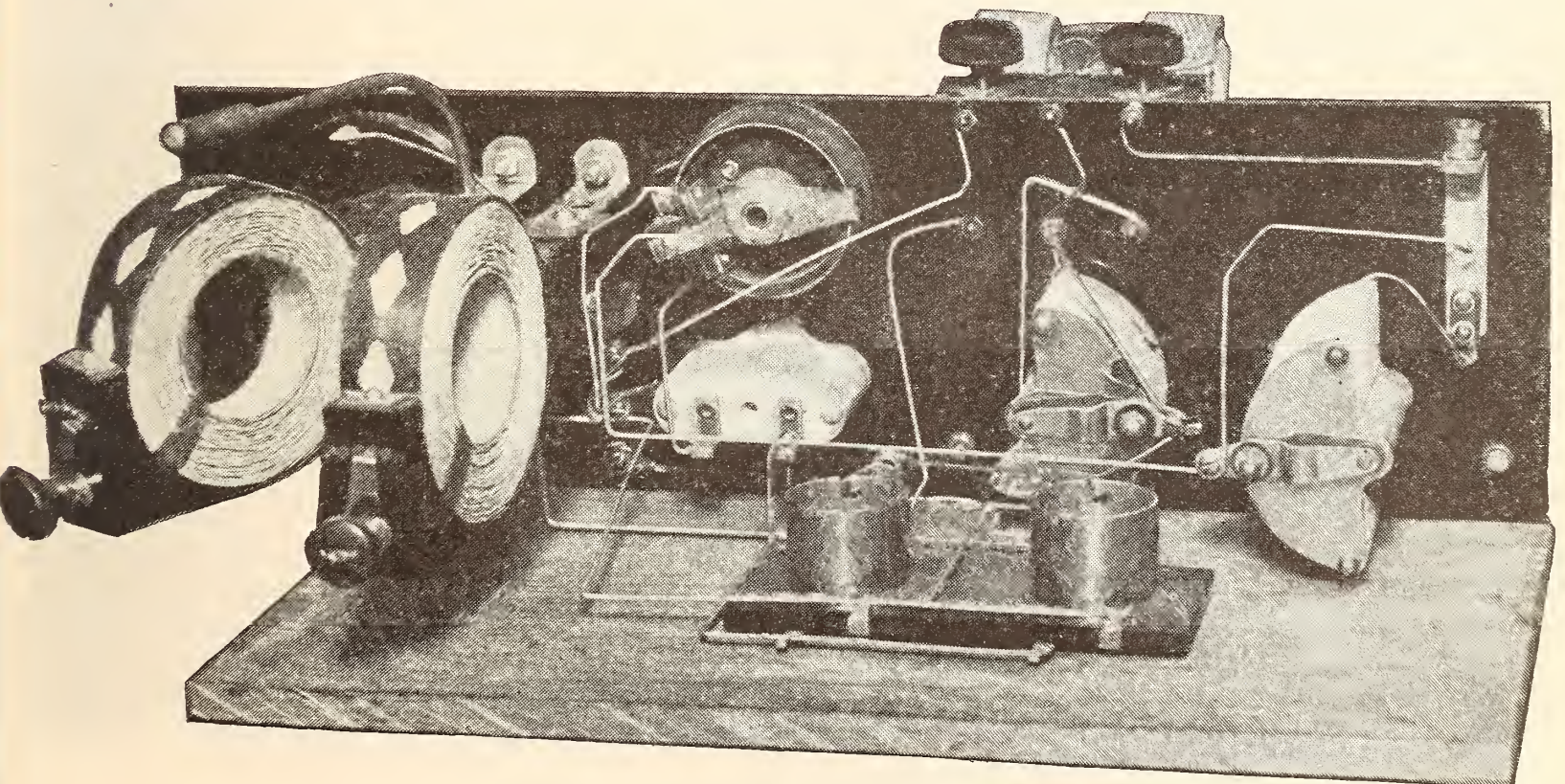
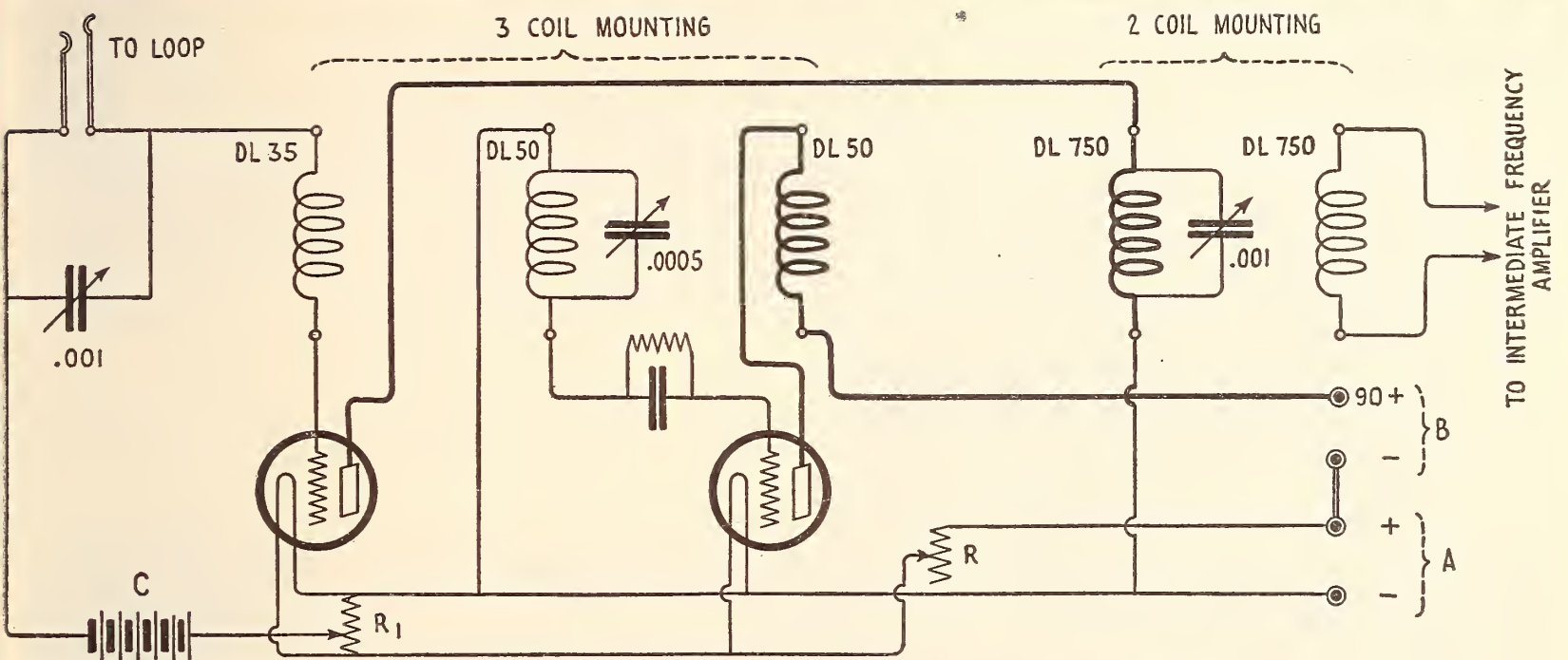
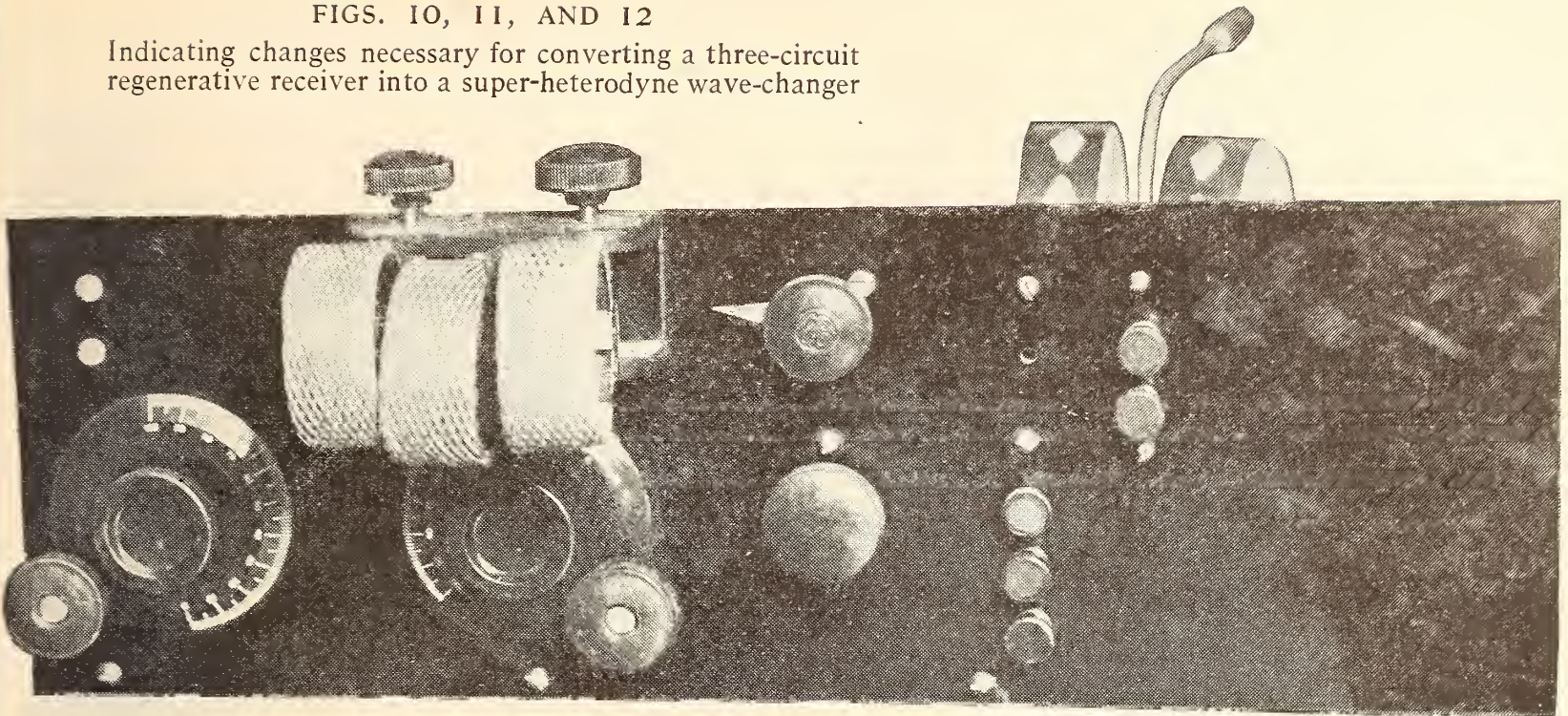

FIG. 9

Rear view of the set shown in Fig. 8

FIGS. 10, 11, AND 12

Indicating changes necessary for converting a three-circuit regenerative receiver into a super-heterodyne wave-changer



tube socket has been added and the new two-coil mounting is indicated on the diagram (Fig. 11) and at the extreme left in Fig. 12.

Fig. 11 has been drawn with the apparatus shown in the exact position from left to right that it occupies on the panel. In Fig. 12, note the jack installed at the right in which a loop may be plugged. The coils in Fig. 11 (DL-750) are both shown in the photo (Fig. 12) as variable, but DL-750 has been found to be the proper size.

The installation of the two-coil mounting allows the output to be fed to an intermediate-frequency amplifier.

### LEAVES FROM AN OLD TIMER'S NOTEBOOK

*Amplifier Squeal In The Last Stage:* This annoyance is often encountered in using a third stage of audio amplification, and, occasionally,

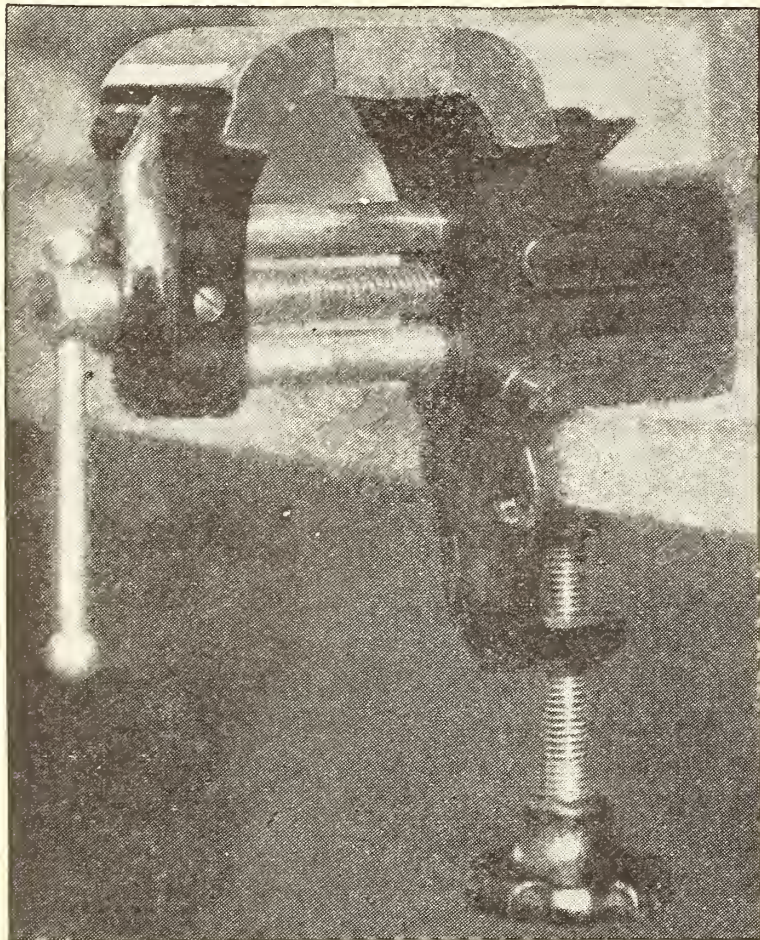

FIG. 13

A fine vise of the approved type. Note the massive construction, and the two guide bars

on the second stage. *Every metallic object in the immediate vicinity of the set, but not electrically connected to it, should be grounded.* The high voltage wires (those running from the B

battery) should be run in grounded lead covering.

Specific instance: Third stage of amplifier possessed a very high (in the upper limits of audibility) squeal, a persistent peanut whistle which was more nerve-racking than if it had broken up the signals. All wiring was run in lead-covered duplex which was grounded. Instruments were perfectly spaced, shielded in places, and of the best electrical design. Special telephone cam switches were used for cutting out amplification stages. As a last resort, the metal frames of the switches were connected together and grounded. The squeal stopped!

### BUILDING YOUR OWN LAB

RADIO BROADCAST'S suggestion for this month's addition to the budding laboratory is a vise—but not of the five and ten cent store variety. The experimenter should pay about two dollars for the vise. It should be of a reliable, well-known make. It should have steel jaws with at least a two-inch separation. A vise of the recommended type is shown in Fig. 13.

The vise is one of the most useful tools in the workshop, but one that is often the last thought of by the average amateur, and it is generally not added to his equipment for many months, or even years, after he has accumulated less useful tools. The uses of this "third hand" are so many that there is scarcely a bit of radio construction in which it will not save time and extra labor, as well as lending accuracy and finish to the completed work. It will hold panels for drilling after one or two instruments are already mounted: It will hold rods and tubing for threading; bakelite, rubber or wood for working and sawing; metal strips, etc., for bending and filing, and many other materials for many similar tasks where a slip means minutes or even hours of additional labor.

When used for holding wood, or panel material, for drilling, planing, etc., small blocks of wood should be placed between the jaws and the material, in order to prevent marring under the tight grip of the steel jaws.

The vise lends itself to perfect coöperation with the drill, taps and dies which we have recently suggested as additions to the laboratory.

RADIO BROADCAST will be pleased to buy from its readers, at prices from three to five dollars, any kinks, devices, original ideas, etc., with photographs if possible, which the Editor may consider eligible for this department. Address all communications to the R. B. Lab Editor.

# Alone Before Thousands



AGNES LEONARD

With her ukelele and her charming voice, she sings the youngsters to sleep on Friday evenings from WJZ, New York



DOROTHY GISH

Bidding farewell to movie fans who are also radio fans, just before leaving for Italy to start work on a new picture



PARIS HORRORS LOSE NOTHING THROUGH THE MICROPHONE

The Grand Guignol Players, on their tour of this continent, stopped off at Station CKAC, Montreal, and gave one of their most blood-curdling offerings, "Une Nuit au Bouge" ("A Night in a Den")

# If You Like Them, Let Them Know It

By MYRA MAY

**W**HAT is it like to play to an unseen audience? How do famous artists, used to applause and adulation, feel when they perform before a "tin can" as their sole spectator?

Charles B. Popenoe, director of WJZ, has watched hundreds of seasoned stage stars make their radio debut. He says nearly all of them get radio fright.

"Practically everyone is self-conscious before

the microphone," he explained. "Professionals during their first concert by radio are always as nervous as amateurs on their first appearance. The only exception I ever saw was the Hasty Pudding Club, of Harvard. These boys, dressed in feminine attire, came up to the studio prepared for a good time. Nothing in the world could phase them. Even the 'little tin can', as the microphone is disrespectfully called, failed to dampen their enthusiasm.

"They cracked their jokes and sang their



E. H. SOTHERN AND JULIA MARLOWE

Who are almost as well known to radio audiences as they are to inveterate Shakespeare play-goers





PAUL WHITEMAN AND HIS DANCE ORCHESTRA

Frequent performers before the microphone. Paul Whiteman's song, "Wonderful One," was written for a radio birthday party which he gave, in New York, for his mother in far-away Denver

songs. It didn't make any difference to them that the audience was scattered in all parts of the world, that in hundreds of homes, families had hooked up the old set and were listening-in. The boys were honestly enjoying what they were doing so that the inevitable reaction was that the audience enjoyed it too.

"The average professional is nervous for the first two minutes. He thinks of the vast audience—many thousands of people—hearing him. His reputation is at stake, for never has there been so large a crowd at entertainments as the radio has made possible. Then he thinks of one person out in this vast audience to whom he wishes to perform. Automatically he forgets the multitude who are listening-in, and works for that person alone. Frequently he does the best work of his career, for his thoughts are on the person far away to whom he is pouring out his soul."

The first show ever broadcasted was "The Perfect Fool" with Ed Wynn. Now, Ed Wynn, as everybody knows, is one of our funniest comedians. When he is on the stage, the audience keeps up a steady roar of laughter. It never occurred to him how close is the relation between an actor and his audience until "The Perfect Fool" company went to a studio to give the play by radio.

Ed Wynn approached the microphone gingerly. He looked at it suspiciously. The time came for him to perform. As with all professionals, he was a trifle nervous. The nervousness, however, wore off, but Wynn was appalled by the silence. He had told some of his best stories and had not even heard a snicker.

Wet with perspiration, he turned to the announcer. "I can't do anything," he said.

The announcer quickly assembled all the

people from around the studio. Electricians in shirt sleeves, scrubwomen with their skirts tucked up, telephone operators, and artists who were billed later on the program, were invited to come into the studio-theatre and enjoy the show. It was a strange audience but their approbation turned the trick. With their giggles, guffaws, and shouts of merriment to encourage him, Wynn proceeded with the entertainment. He needed only the responsive sight of his hearers doubled over with laughter. Had he been a more frequent radio performer, he would have been able to imagine the fans in their homes, tuned-in to his program and convulsed with mirth.

An audience, although silent, is not necessarily unappreciative, according to Paul Whiteman, the well-known jazz orchestra leader. His first experience with the radio audience was rather terrifying. Now that he is used to it, he says he enjoys imagining all his various hearers—some in homes dancing, some in remote localities with a radio set as their only home tie. And sometimes, he likes to visualize the crew of Captain Mac-Millan's *Bowdoin* up near the North Pole, perhaps giving the Eskimos the benefit of a jazz band concert, while he plays on. Whiteman is quite a radio fan, himself. That is one reason why so many radio fans went to a party he gave a few months ago.

He had always gone home for his mother's birthday. Last October, when the birthday came around, he was in New York unable to go to Denver to be with his mother. About a week before the birthday, as he sat before his professional looking set, a sudden inspiration came to him. It was such a wonderful idea that it didn't seem possible, but Whiteman said nothing to any one and went to work.

A few days later, a sweet faced little lady

in Denver heard from her son that because he couldn't come home for the birthday, he was going to give her a party that day. Three million persons had been invited; the party would be held on the evening of the birthday. Part of the schedule when the son was at home, was his playing on his violin, his mother's favorite songs. It was this custom which Whiteman was to incorporate in his birthday party. Only instead of playing to his mother

alone, he arranged to bring his ten-piece orchestra with him to Newark and broadcast the entire program. Many of you fans probably attended the party. The guest of honor, Mrs. Whiteman, calls it her happiest day. Instead of a birthday cake, the party had a birthday song, "Wonderful One," which Paul Whiteman himself wrote especially for the occasion.

"At first," Whiteman relates, "I felt ill at ease. My orchestra and I had never played before such a silent assembly. We were used to a crowd which encored the numbers they liked and which inspired us to better playing. This quiet studio was an entirely new thing

for us; we felt alien. Then I realized that this was my mother's birthday, that way out in Denver she and my father were listening to me. A new spirit was infused in us; we felt that although the audience was silent, they were not necessarily unappreciative. Responses would come later, we believed. They did. Hundreds of birthday congratulations came to my mother, hundreds of letters of thanks came to the orchestra, from our birthday guests. It takes longer to get the applause from a radio audience than it does from an audience there in person, but the people who listen-in are no less enthusiastic and grateful."

Cecil Arden, Metropolitan Opera singer, is



CECIL ARDEN

"I don't mind singing to an unseen audience. To me, the only drawback in radio is the inability to gauge how your audience likes you"

one of the most popular artists on radio programs. When her vibrant personality goes over the air, the radio audience falls under the spell of it, as surely as do the crowds at the Metropolitan Opera House.

"Singing by radio is a spooky experience," Miss Arden confides. "There is something so vast, so indefinite about singing into a microphone. I always have the feeling that I don't know where my voice is carrying, who is hearing me, how my singing is being reproduced. On one occasion I sang in Kansas City and my program was broadcasted. Some friends of mine unknown to me, were in Dallas enjoying a receiving set. Suddenly tuning-in to the Kansas City station, they heard me singing and recognized my voice. Immediately they sent me a telegram and within nine minutes after they had heard me, I received the telegram. To me, that was a revelation of the power of radio."

Miss Arden is a radio "veteran." She made her debut almost two years ago as the first opera singer to give a concert broadcasted.

"My first impression was one of wonder. I thought of the message—'What hath God wrought'—that Morse sent after he had invented and perfected the telegraph," Miss Arden explained. "No, I was not nervous the first time I sang. I was too struck with the wonder of it all. Later on, when I began to realize the size of my audience, I got scared. But by that time I had received letters of thanks and I felt reassured.

"I don't mind singing to an unseen audience. To me, the only drawback in radio is the inability to gauge how your audience likes you. On the stage you immediately know whether the people out front are gay or sad, whether

they want rollicking tunes or a classic program. A radio entertainer never knows exactly how his number gets across. He is at the mercy of a diverse number of people, weather conditions, and freaky sound waves which are apt to distort the most perfect rendition.

"When I am singing a program that is being broadcasted, I like to think of the shut-ins and the people in the hospitals, to whom I am trying to bring a little pleasure. I like to reach the audience who has little communication with the outside world, that audience which by the invention of radio has been given something for which to live."

In speaking with artists whose programs are frequently broadcasted, you are struck with their interest in the moods of their audiences. Most of the entertainers feel that the disadvantage of playing to an unseen audience is the inability to tell how the selection is being received. If we knew how our hearers liked us, we wouldn't mind performing to a microphone, we wouldn't even mind the stony silence, the radio artists say. It is the dreadful uncertainty of knowing how the public likes their work that worries the entertainers.

So, radio fans, there is just one thing for you to do. When you like a number, write and tell the artist that you enjoyed his selection. Not only will the artist feel repaid for his work but he will appreciate the courtesy of the letter. Audiences in a concert-hall sometimes have to pay several dollars for the pleasure of hearing a certain player or singer; radio audiences often have the music of the same artists brought to them free. A letter of thanks is small payment. Radio fans, it is up to you to show your applause in writing.

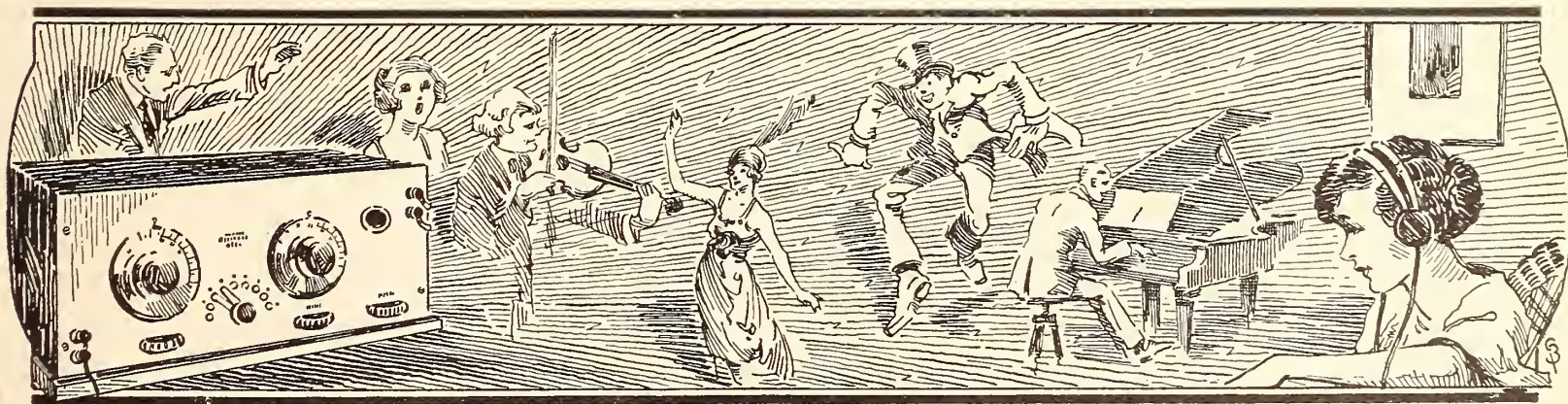

# A Two-Stage Amplifier for Your Receiver

By CARL GOUDY

Assistant Instructor of Mechanical Engineering, Pratt Institute

A home-made two-stage amplifier of sound electrical design and strong mechanical construction, which may be hooked up with any tube or crystal set, is well worth looking into. It helps those who have been receiving principally local stations, sufficiently loud really to enjoy them, bring in the distant ones louder; it enables them to use a loud speaker on signals that would operate only the phones without it, so that a roomful of people, can enjoy the programs. We put our enthusiastic "OK" on the amplifier described below. We have been trying one of these amplifiers made in exact accordance with these instructions. It has plenty of "kick" both with dry-cell and storage-battery tubes, and brings in signals unusually clear.

Mr. Goudy has followed out our suggestions in designing and describing this apparatus in a manner that should make the building of it a comparatively simple matter. It is designed for use with any type of amplifying tube, and room enough has been allowed for the use of any transformer or combination of transformers and other parts now on the market.—THE EDITOR

**I**N OFFERING this amplifier to the radio amateur and broadcast listeners, the writer has endeavored to design an instrument of marked simplicity in detail, and one that may readily be constructed with a minimum number of tools. This amplifier has the following outstanding features:

1. Dead jacks when not in use. In most amplifiers using jacks for the different stages of amplification, the nipples extending through the panel are alive whether the set is in operation or not. An inspection of the accompanying wiring diagrams will show that the frames of the first and second jacks are entirely out of the circuit, this being accomplished by the selection of the correct jack for the particular part of the circuit. If a high B battery voltage is carried by the usual jack, the radio fan using live jacks is exposed to a severe jolt when inserting the phone plug.

2. The entire frame and transformer cores are at ground potential, with transformers well spaced, reducing the chance of howling to a minimum.

3. Grid leads are extremely short and well separated from the plate circuit.

4. Transformer leads are mechanically secured by means of the binding post provided, but also soldered direct to the coil terminal, thus assuring absolute contact.

5. A variable C battery is used to provide a suitable grid bias for the plate voltage used and is incorporated within the set and placed so that advantage may be taken of the differ-

ent steps of voltage. When using high B battery voltages, say above 60, a C battery is necessary. It will be found to improve the quality of amplification quite naturally.

6. Input and output jacks and binding posts are used, making a truly universal amplifier that may be quickly connected or "plugged" to most any type of receiver. This is important, since the receivers change but the amplifier still remains the same.

## GOOD PARTS ARE ESSENTIAL

**T**O HAVE a well-designed receiver or amplifier function properly after building it from a set of construction drawings, the instruction and drawings should be followed closely, good material and dependable equipment should be employed, and each item of apparatus should be tested before it is placed in the set and hooked up.

It is very much like assembling an automobile engine or a watch—I have drawn a wide comparison, but fundamentally the idea is the same. Take in the first case: if the carburetor is carefully looked into, you are sure that the gas passage is clear and that it is ready to function as a unit; the magneto is given the same inspection, timing is checked—and, in so many words, every detail is examined. The result is that the motor will run; of course, it will have to be tuned or adjusted, but you have variables in the radio set that may be adjusted as well. You may try a leak here and a condenser there and find that it is worth while.

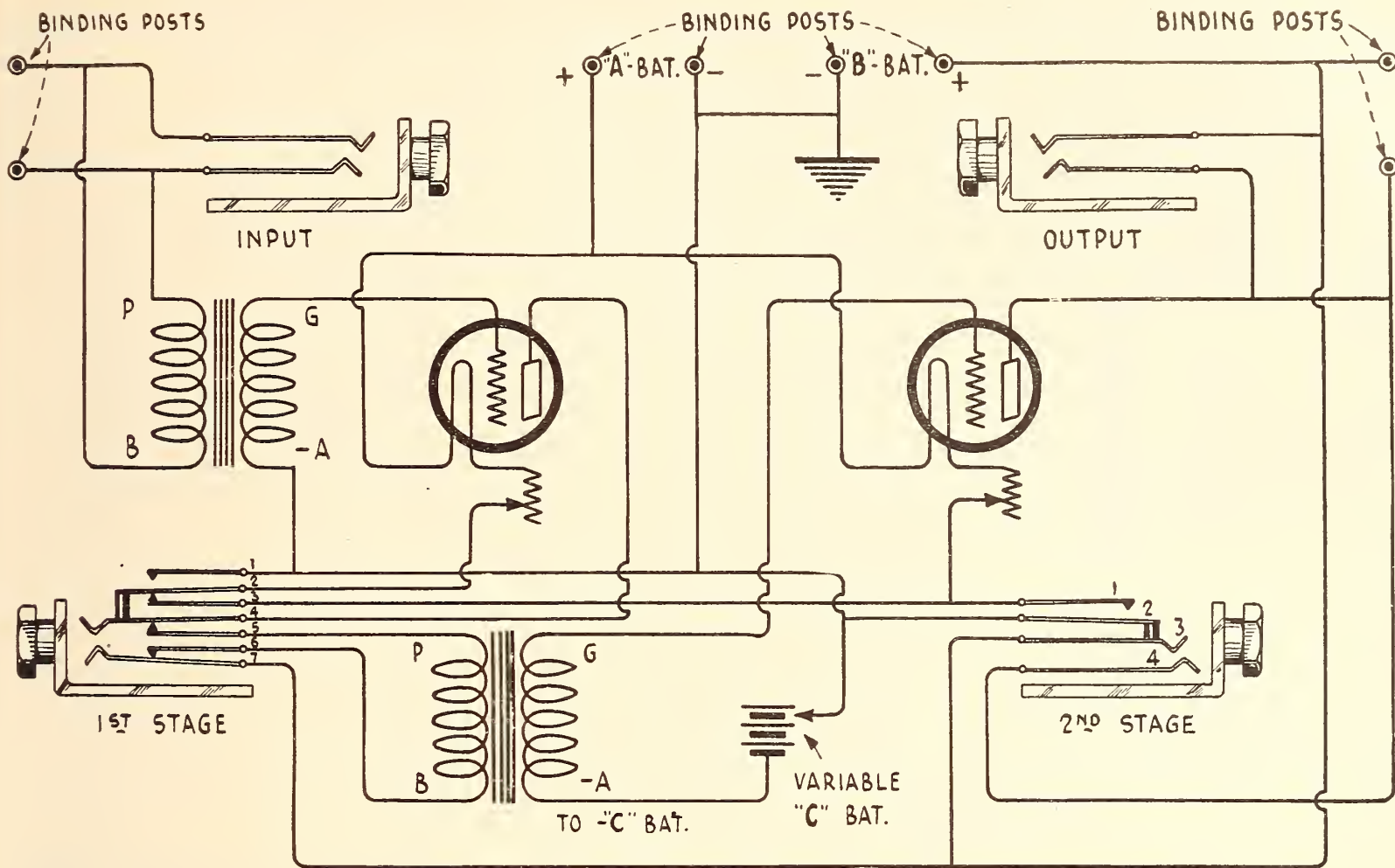

THE ENTIRE CIRCUIT

Have you ever watched a jeweler assemble a watch? Notice how carefully he inspects every part before putting it in place. It's the same in radio work. If you check every part carefully and hook it up correctly, it has got to work.

The time to "shoot" our trouble is before the set is assembled, and I propose that

you "shoot" it dead now. This fiddling around, trying to make it operate after it is all intact, is very unsatisfactory and certainly will make a carefully assembled job look as though someone had pulled a rake through it.

The writer was called in to render first aid to a set a short while ago. The detector functioned perfectly, but nothing was to be had from the

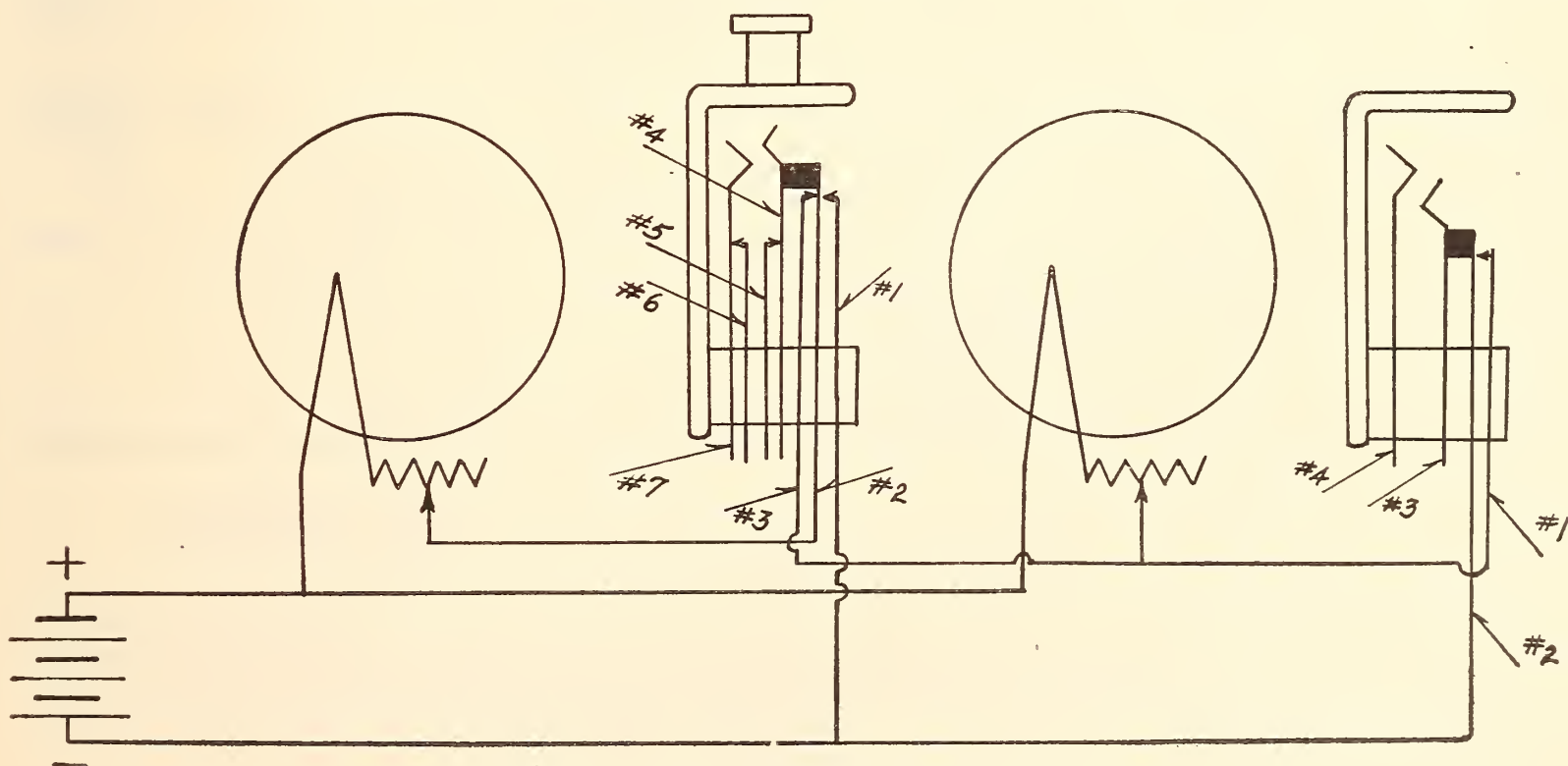

HOW TO WIRE THE FILAMENT CIRCUIT

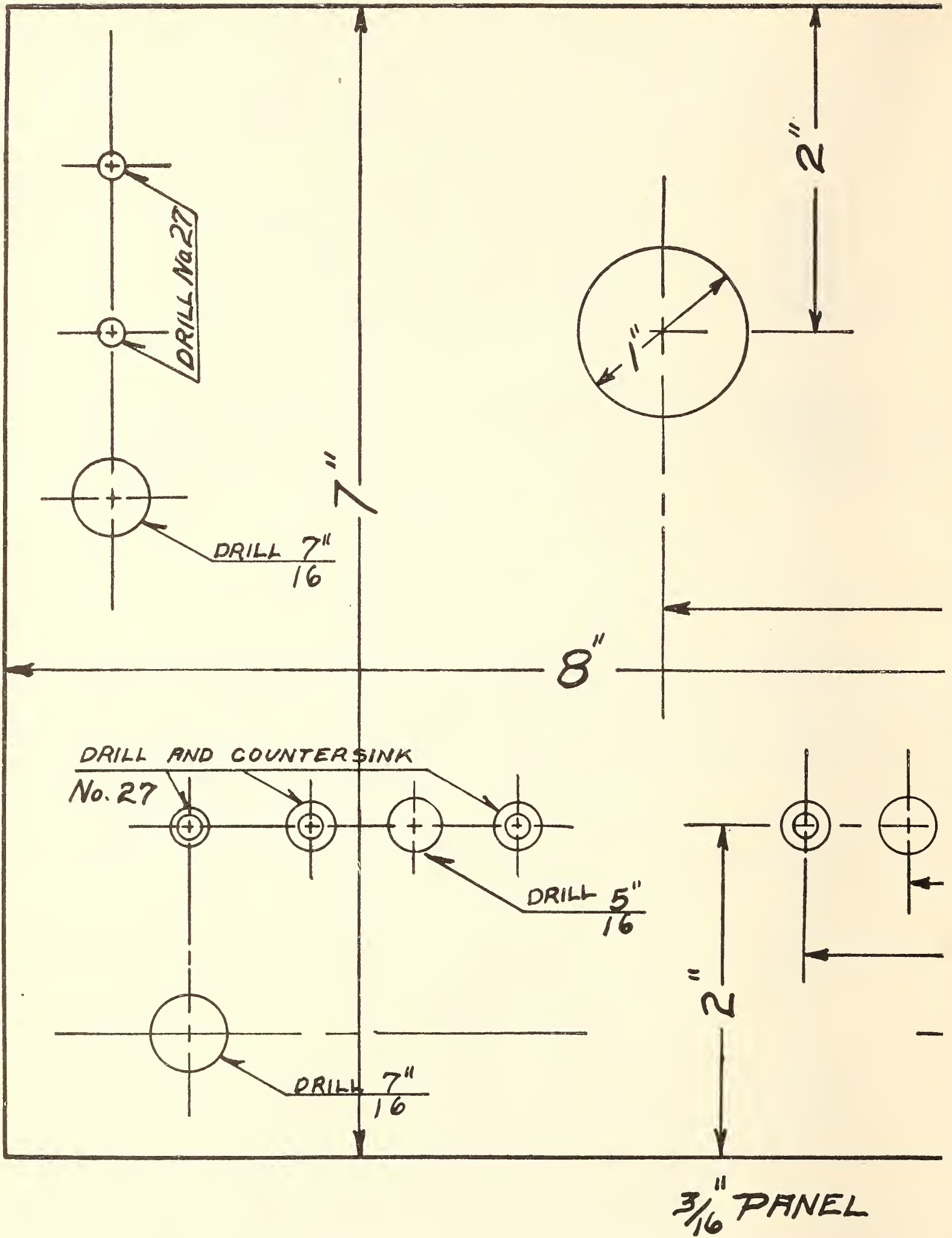

ACTUAL SIZE FOR—  
 Cut out the two parts of the pattern, on this page and the opposite page, and join—  
 template" is fixed to the panel with light paste, it will be easy to locate the center of—  
 center punch, and will save a great deal of measuring—

amplifier end. The trouble was in the jacks. The jack springs were not of spring stock and failed to return to position. The result was a failure to make contact, thus leaving the circuit for the amplifier open. The jack was removed and the springs bent to make proper contact, but this measure could only be temporary. There is no more troublesome part to replace in a radio set than a jack, or a piece more vital in its proper functioning.

HOW TO CHOOSE THE PROPER RHEOSTAT

THE law connecting volts, amperes, and ohms (known as Ohm's law) is expressed as follows:

$$\text{ohms} = \frac{\text{volts}}{\text{amperes}}$$

This law applies to the whole circuit or to any part of it.

The table below shows that a UV-199 tube requires 3.0 volts 0.06 ampere. We can compute its resistance by Ohm's law. It is

$$\frac{\text{volts}}{\text{amperes}} = \text{ohms} \quad \text{or} \quad \frac{3.0}{.06} = 50 \text{ ohms}$$

If this tube is to be operated from a 4.5-volt battery (three dry cells in series) the extra 1.5 volts (4.5-3.0) must be taken by the rheostat. Since the tube and the rheostat are in series, the current in the rheostat should also be 0.06 amperes when the correct voltage is obtained. We can then compute the resistance required in the rheostat by Ohm's law. It is

$$\frac{\text{volts}}{\text{amperes}} = \text{ohms} \quad \text{or} \quad \frac{1.5}{.06} = 25 \text{ ohms}$$

The rule for determining the resistance required in a rheostat is therefore as follows:

*Subtract the volts required by the tube from the volts at the battery.*

*Divide the remainder by the tube amperes.*

It is best to select a rheostat with a resistance somewhat greater than that computed and adjust it down to the required value.

Approximate D. C. characteristics of popular tubes:

TYPE	E (VOLTS)	I (AMP)	R (OHMS)
200	6	1	6
201	6	1	6
201-A	6	.25	24
199	3	.06	50
215-A	1.5	.25	6
WD-11	1.5	.25	6
WD-12	1.5	.25	6

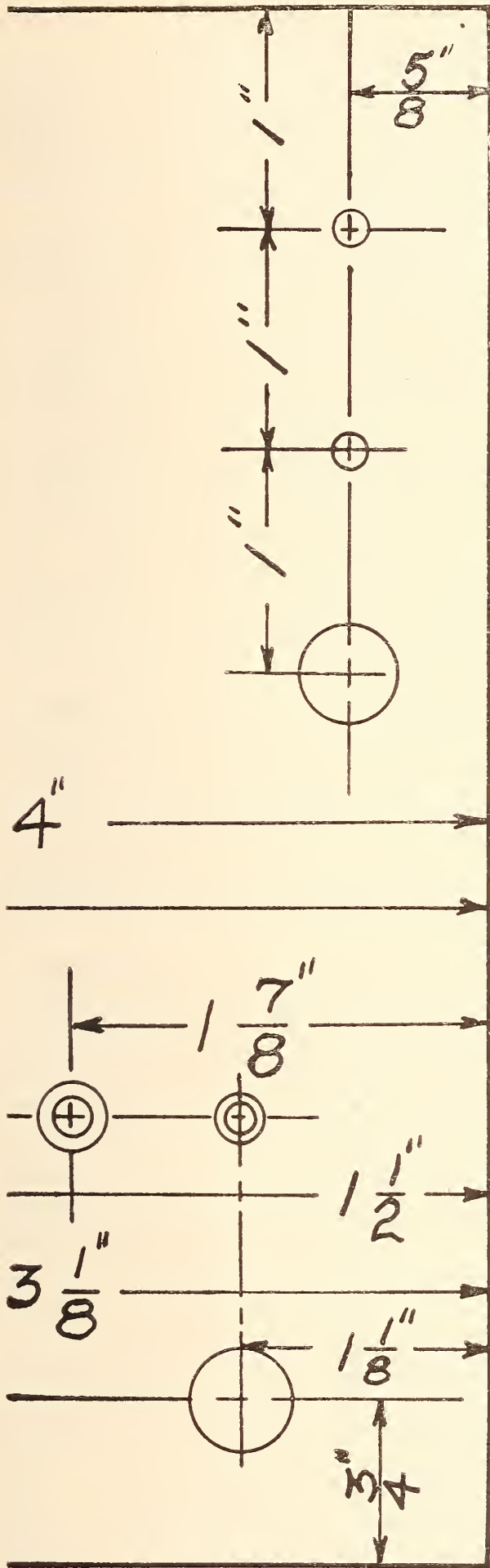

—MAIN PANEL

—them together. If this "pattern, or the drill holes with the aid of a and marking.

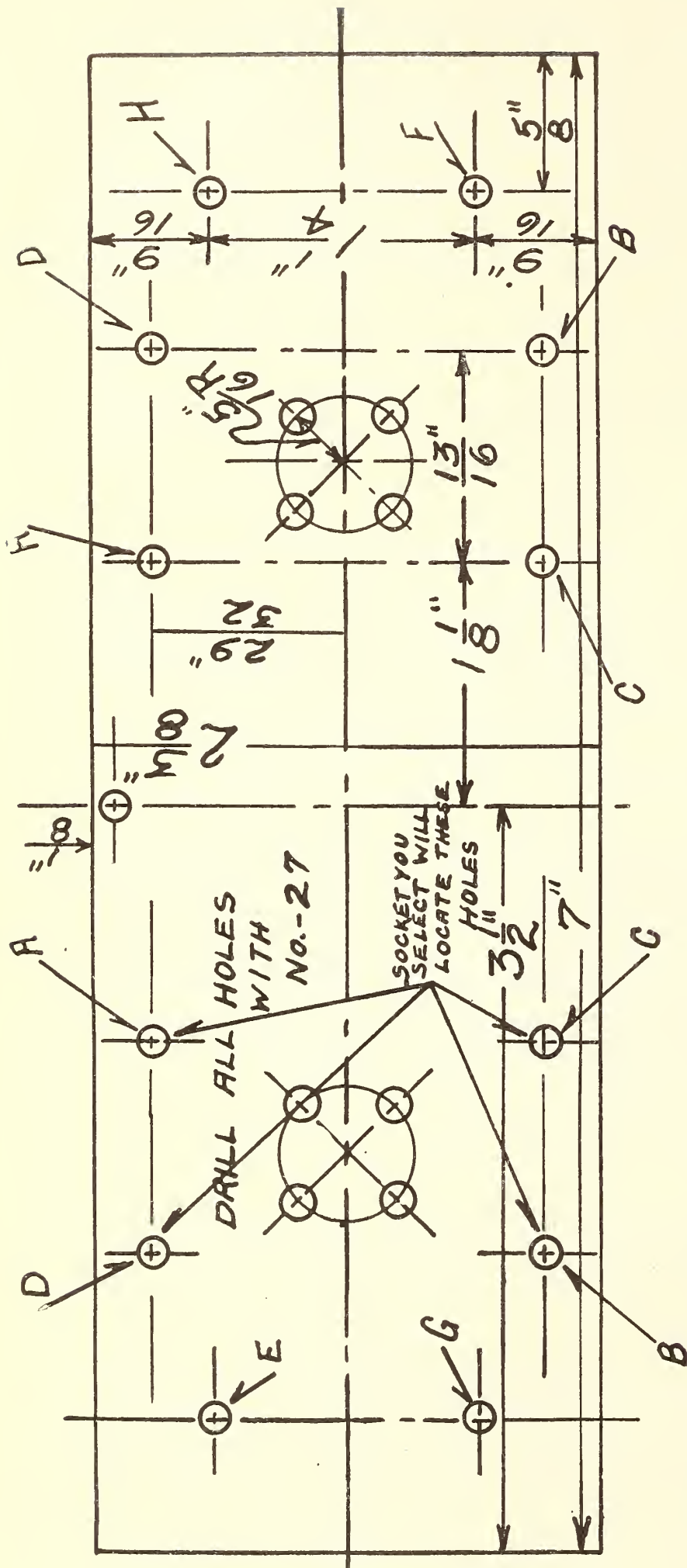

ACTUAL-SIZE PATTERN FOR SOCKET SHELF

In drilling holes for sockets, drill A and B first, then mount the sockets. Drill holes C and D when it is in place. Likewise, drill E and F before mounting—G and H, when shelf is in place on supporting brackets.

Below is given the proper rheostat to use for control of various tubes:

6 ohm—for one UV-200, UV-201, C-300, C-301, WD-11, WD-12, DV-1, DV-6, VT-1, VT-2, 209-A, 215-A, WR-21-A, WR-21D, Meyer tube or three or four UV-201A or UV-301A tubes.

10 ohm—One DV6A, two UV201-A's, four to sixteen UV199

20 ohm—One UV201-A, two to eight UV-199 30 ohm—One UV-199

50 ohm—for UV-199 when storage battery is used.

Take the jack selected for the first stage—(Fig. 1) a seven-spring automatic and insert a phone plug. Look closely and see what takes place. If we number the springs 1 to 7, from top to bottom, 1 and 2 will now be making contact, 2 and 3 separated, 3 and 4 open, 6 and 7 open. Now, upon removing the phone plug, 1 and 2 will open, 2 and 3, 4 and 5, and 6 and 7 will close. Note that the contacts are firmly made with plenty of spring tension behind. A four-spring, auto-triple-circuit jack, used in the last stage in the same manner is also shown. With plug inserted, springs 1 and 2 will make contact; and they will separate when the plug is taken out.

The sockets should now be inspected. Tighten the screws that secure the contact springs in place and lock securely with the nut. This is a precaution worth while, for it is difficult to get at these screws should they need attention after the socket is screwed into place on the shelf. Insert the vacuum tube and see that the prongs make a firm contact with the four springs. As an additional precaution, holes are shown in the drawing of the socket shelf. These holes are included so that the springs may be raised by merely pushing some object up through the holes should the spring tension fail later on. After trying different sockets and adapters and tubes, you will find that some of them vary considerably in the height from the locating pin to the prongs, and changing them sometimes causes spring trouble in the sockets.

See that your rheostats are free running for the entire range and that contact is ample for good tube operation. It is well to make sure that all assembly screws are tightened securely. All kinds of noises, usually mistaken for static, may result from rheostats with loose moving parts. Standard sockets are used since their selection permits the use of standard base



tubes such as the 201-A, and WD-12, while adaptors may be employed to make use of other tubes such as the WD-11 and the UV-199.

The transformers may be readily tested by connecting a battery to the primary post and touching the other primary post, thus completing the circuit. If a wire is brought from one secondary post to the other but not quite touching it, leaving a slight air gap, a spark may be seen to jump across to the second secondary post, giving assurance that the primary and secondary windings are all right.

THE TOOLS YOU NEED

ONLY a small number of tools are necessary to complete the job. They are:

- A small hand drill
- 1 No. 27 drill for all screw holes and binding posts
- 1 5/16 drill for rheostat shafts
- 1 7/16 drill for jacks (unless jacks of another size are used)
- 1 flat file, center punch, square, dividers, hammer.
- 1 countersink, hack saw or fine-tooth back saw, screw driver, pliers, soldering iron, and soldering material

Even this list can be cut down to some extent, the countersink may be replaced by re-grinding the 7/16 drill to an angle of 60 degrees; in fact, it will do better work in drilling the thin panel if used in this manner. The 5/16 drill may be replaced by first drilling the hole for the rheostat shaft with the No. 27 drill, and then using the countersink from both sides until it will accommodate the rheostat shaft, but this practise is not recommended. The No. 27 drill is necessary for a good job, and you will find it is slightly larger than a 1/8-inch drill.

LIST OF MATERIAL

- 1 Panel, 3/16 x 7x12 inches
- 2 Sockets
- 2 Rheostats
- 2 Transformers
- 8 Binding Posts
- 1 seven-spring automatic jack
- 1 four-spring automatic triple-circuit jack
- 28 inches of 1/16 x 1/2-inch brass
- 24 8/32 x 3/4-inch round-head brass machine screws
- 2 8/32 x 3/8-inch flat head brass machine screws
- 5 lengths tinned bus wire
- 2 Heavy-duty jacks
- Markers for jacks, INPUT, OUTPUT, 1st STAGE, 2nd STAGE
- Markers for battery binding posts

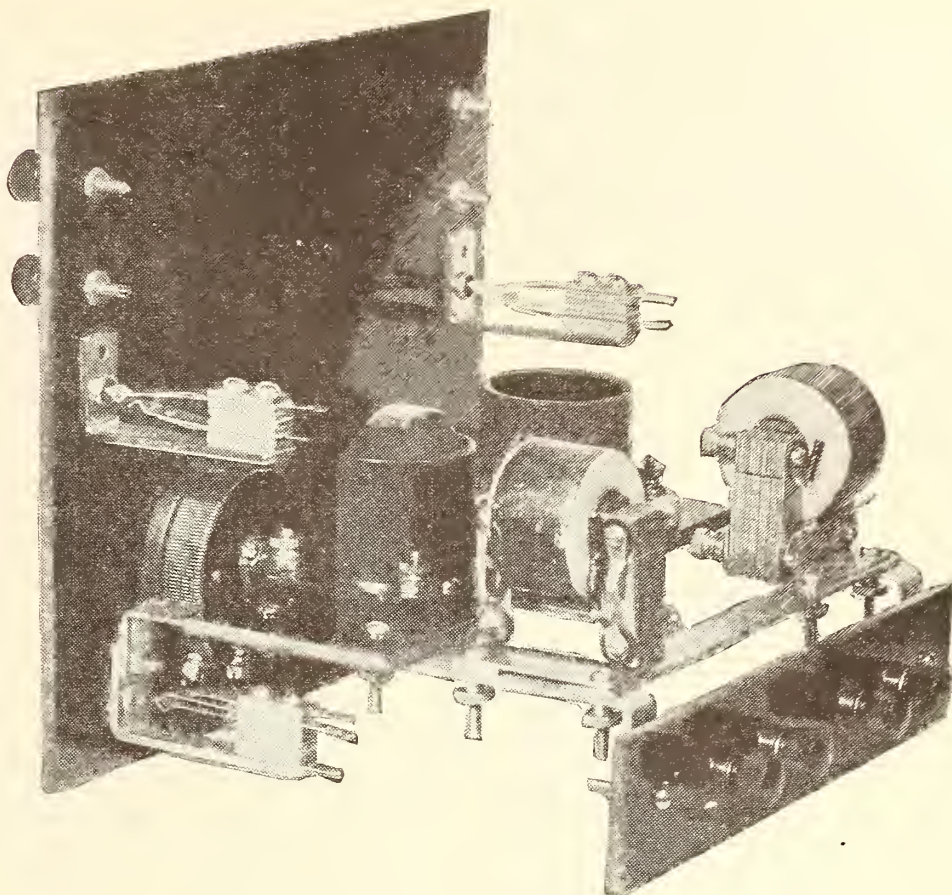

REAR VIEW

With main panel, rheostats and input and output jacks and binding posts

WORKING THE PANELS

IN PURCHASING the panel it is well to procure one of standard make because the sides are more likely to line up square. Now we are ready to prepare the panel. Look it over carefully and select the best side. See

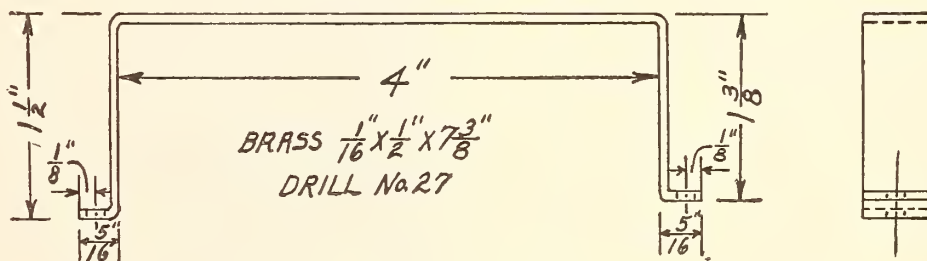

CLIP FOR C BATTERY

The clip shown is correct for Burgess type 2370 battery or the Eveready No. 771. If other batteries are used, the clip will have to be changed to fit

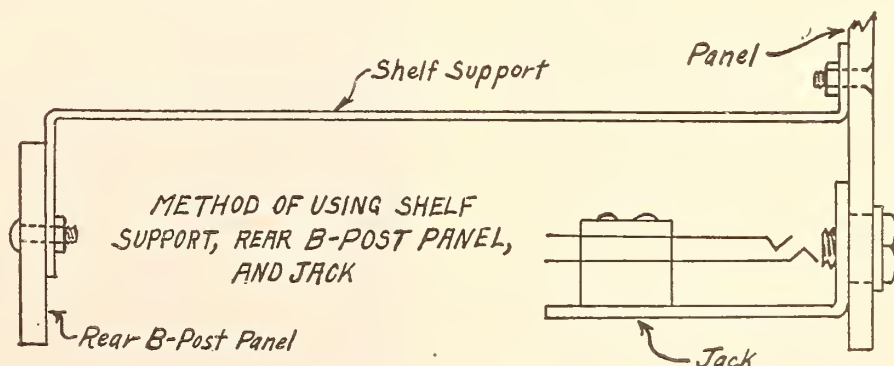

SHOWING METHOD OF MOUNTING Supporting shelves and jacks to main and rear panels

that the trade-mark, if one is stamped in it, is located so that it will cut out of the panel proper. Lay off  $2\frac{1}{2}$ -inches from one of the short ends, so you may cut a piece 7 inches long or the height of the panel. Then lay off 8" from the other end as shown in the drawing.

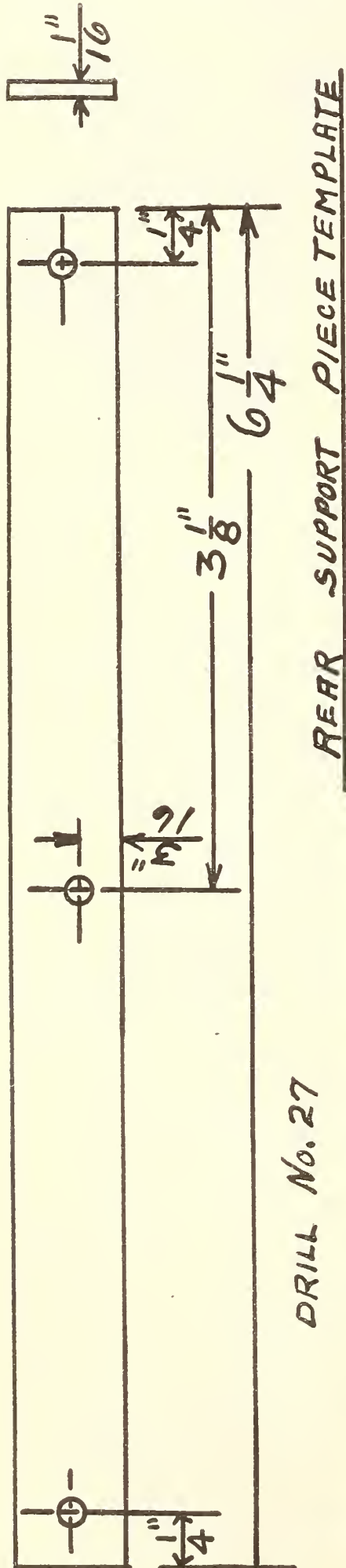

Square carefully and mark with a sharp pointed tool, and then saw with a hack saw or a fine-tooth saw. Allow the saw to have a good slant, as this will prevent the panel from chipping from the under side. A hacksaw will take care of this point, because the frame will prevent a vertical cut. By cutting the small pieces first, namely, the socket shelf and the rear binding

post panel, you will enjoy some practice for the final cutting of the main panel. It is well to square the large piece by filing with a flat file. Then the large panel may be laid out and cut. It is well to check your measurements and refer back to the drawing and be doubly sure you are right. Break all the sharp edges with a file.

Now lay out the holes to be drilled as per the drawing and mark lightly. Check this layout from all sides as an added precaution. You will find it a good point to set your dividers to the radius of the drill to be used and scribe every hole according to the drawing. It may save you running the  $\frac{5}{16}$  drill through where the No. 27 should be. What it will certainly do, however, is to insure the hole being drilled where you intended, and after a few turns of the drill you can inspect it and see that the drill is located directly in the center of the circle, and if not, you may easily correct it by drifting the drill in the proper direction. The window was cut with a fly cutter and, of course, is optional and may be replaced with the conventional six small holes design. In reality, it is unnecessary as far as ventilation goes when using the tubes of small current capacity. It does add somewhat to the appearance of the panel.

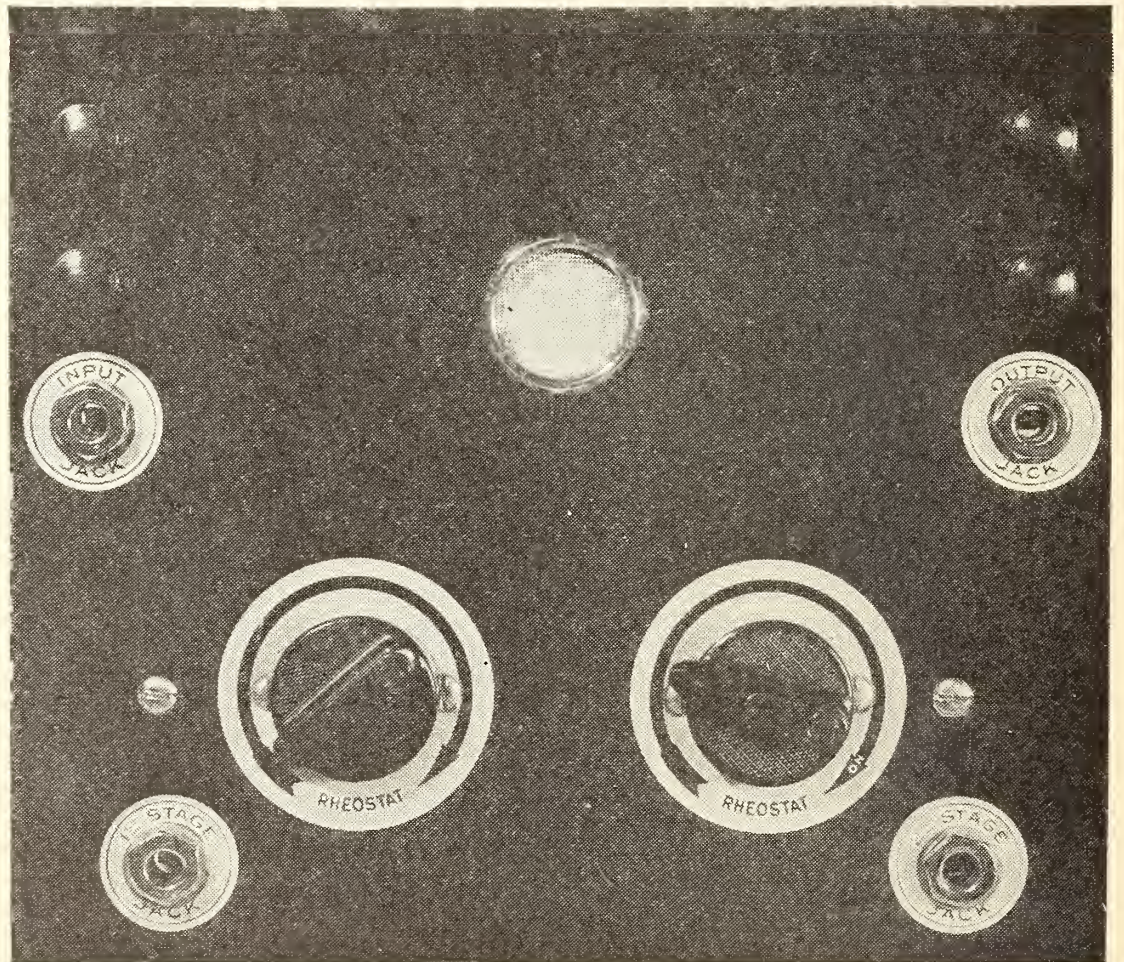

FRONT VIEW

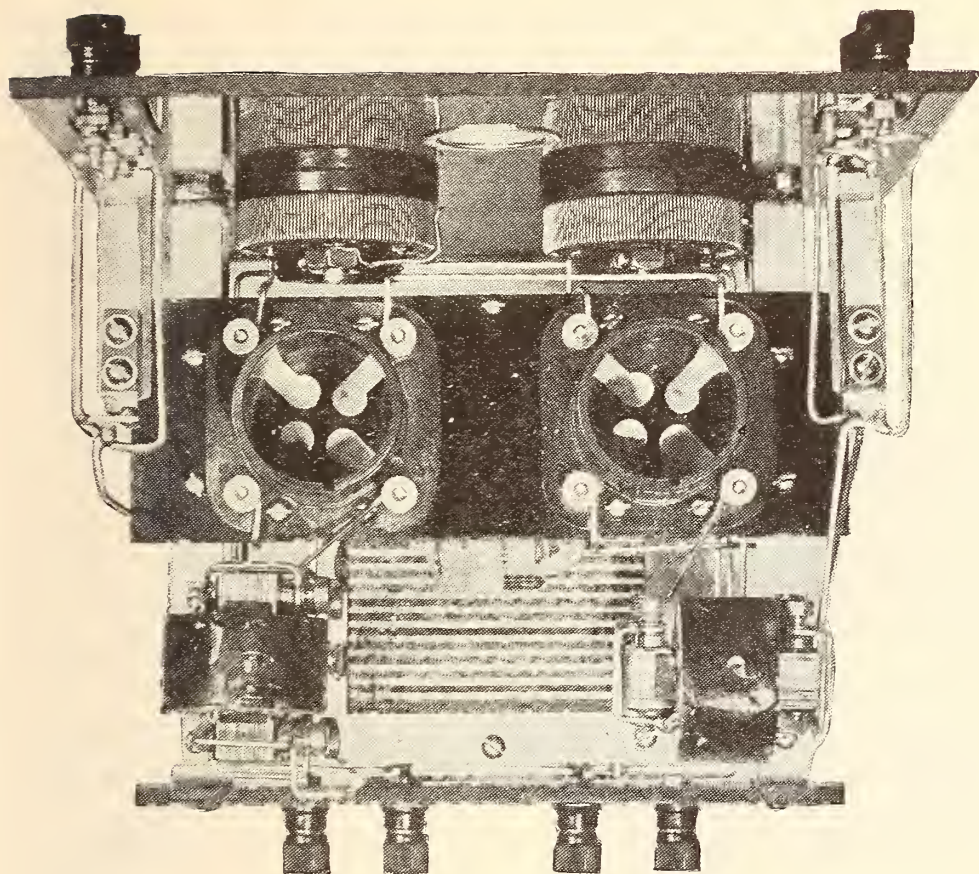

THE COMPLETED UNIT  
Looking from above

In laying off the socket shelf you will find it easier if only two of the four holes for securing the socket are drilled. The remaining two holes may be drilled after the sockets are in place. The same may hold true when the extreme end holes on the shelf are drilled. The slightest error will cause these holes not to line up properly.

MAKING THE BRASS FRAMEWORK

THE three brass frame members may now be laid out, drilled and bent as shown in the drawing. Do not try to make too sharp a bend. Bite or grip both strips in the same manner. This may be done by placing them side by side in a vise. If this is done, you will find that the two pieces will be shaped up to match. Now drill all the holes. If the countersink is used, in order to break the sharpness of the holes, the assembly will be easier.

ABOUT THE ASSEMBLY

NOW is the time to pick up the tools and clean up the table. You cannot do a careful job if the table is cluttered with tools, brass filings, and chips. If you are going to keep the original polish on the panel, take care in removing all the brass chips from the table, for they will invariably mar the panel. Now mount the rheostats, binding posts, and jacks

on the panel. The sockets may be screwed to the shelf and the balance of the holes drilled. The rear binding post panel piece is ready for the binding posts, and with the brass shelf support secured to the panel the amplifier has suddenly grown up and the next thought is the wiring.

THEN THE WIRING

THE soldering iron, soldering material, bus wire, and pliers are all that are

needed now to complete the job. Study the diagram and instead of making a maze of it, try to see how each instrument is hooked into the circuit. To make it easier, the filament circuit has been drawn separately from

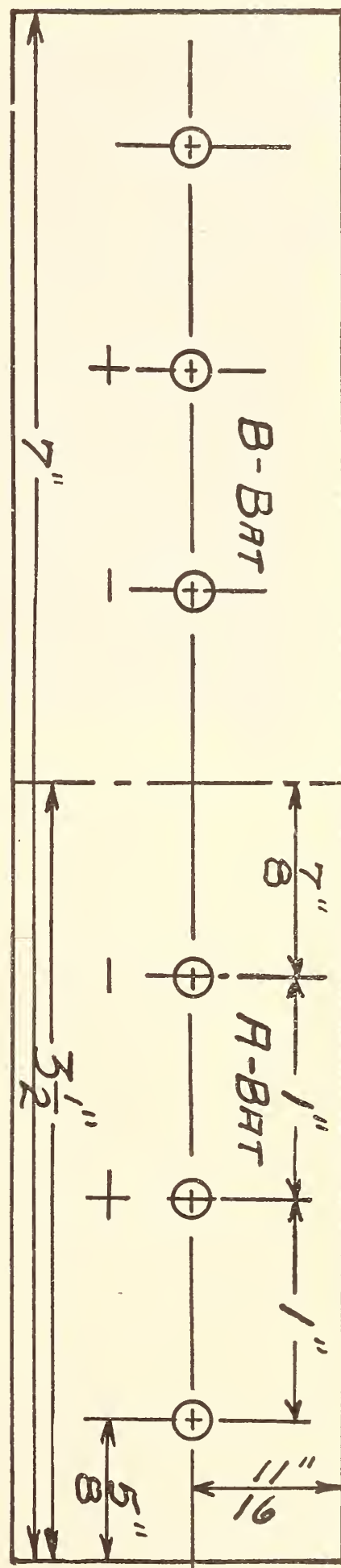

PATTERN OF REAR  
Binding post panel

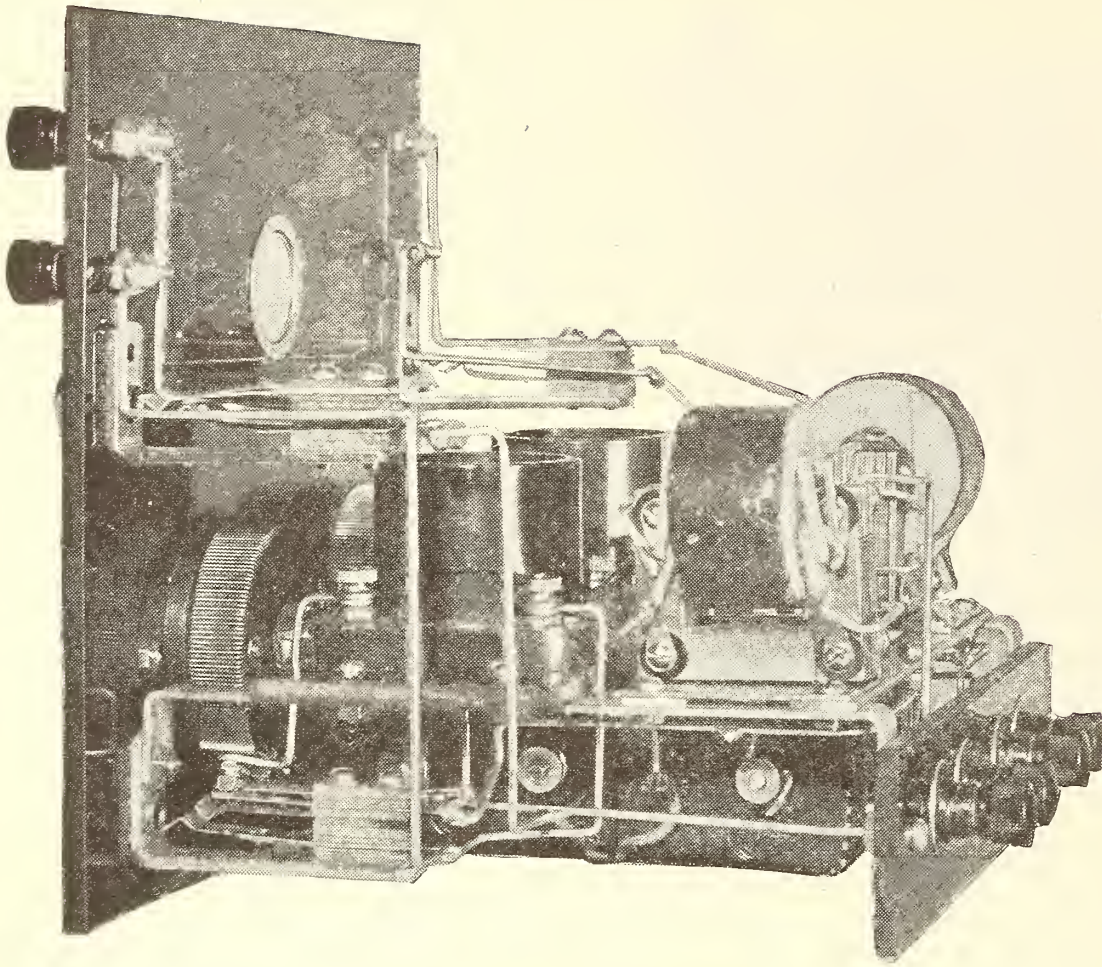

FROM THE LEFT REAR  
Showing the arrangement of the parts and wiring

the entire hookup, in an accompanying drawing. This is the circuit to tackle first, and with it off your hands the rest is easy sailing. With the filament circuit completed, try it out and see that the jacks operate correctly before you go any farther. Take the B battery and plate circuit next, after which the grid circuit should be completed.

#### HOW TO SOLDER

**I**N NEARLY every instance of soldering, the instrument end has been taken care of by first having been tinned. If you will do the same to the bus wire after it has been bent to the desired shape, you will find upon applying the iron to the parts to be joined that they will knit neatly without the usual dropping of solder into the set.

The point to bear in mind when soldering is this: both members to be soldered must come up to the same heat, and this is not attained by briskly rubbing the soldering iron over the parts to be soldered, but is obtained, instead, by first having a hot, clean iron, which is simply held against the parts to be joined. Both members to be soldered must first be tinned. In connecting the transformers, carry the bus wire to the binding post and then around—keeping clear of the frame of the transformer—to the clip, where the wire emerging from the coil is attached. This method gives you a true soldered connection. If you must use the paste soldering compound, try

benzine instead of alcohol for removing the paste after the joint is made.

See that the C battery is connected correctly

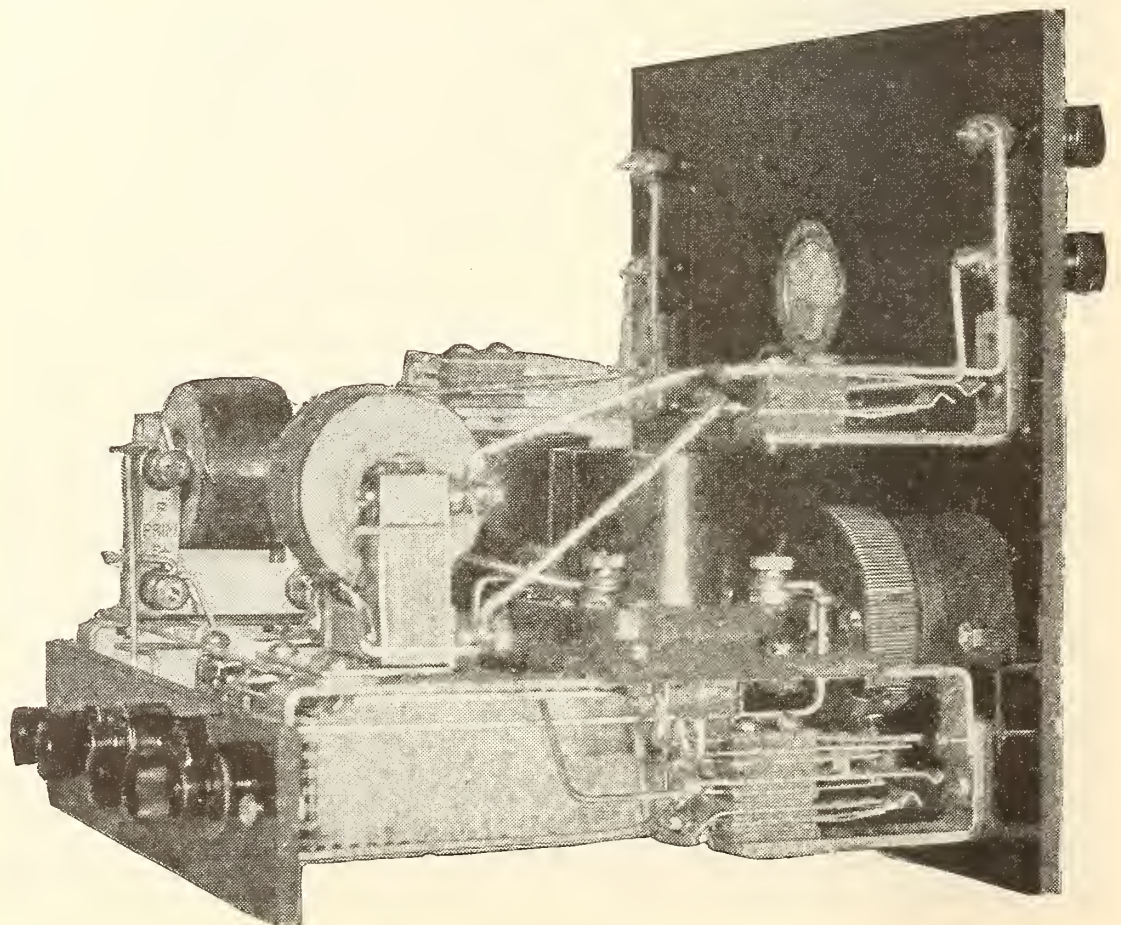

FROM THE RIGHT REAR

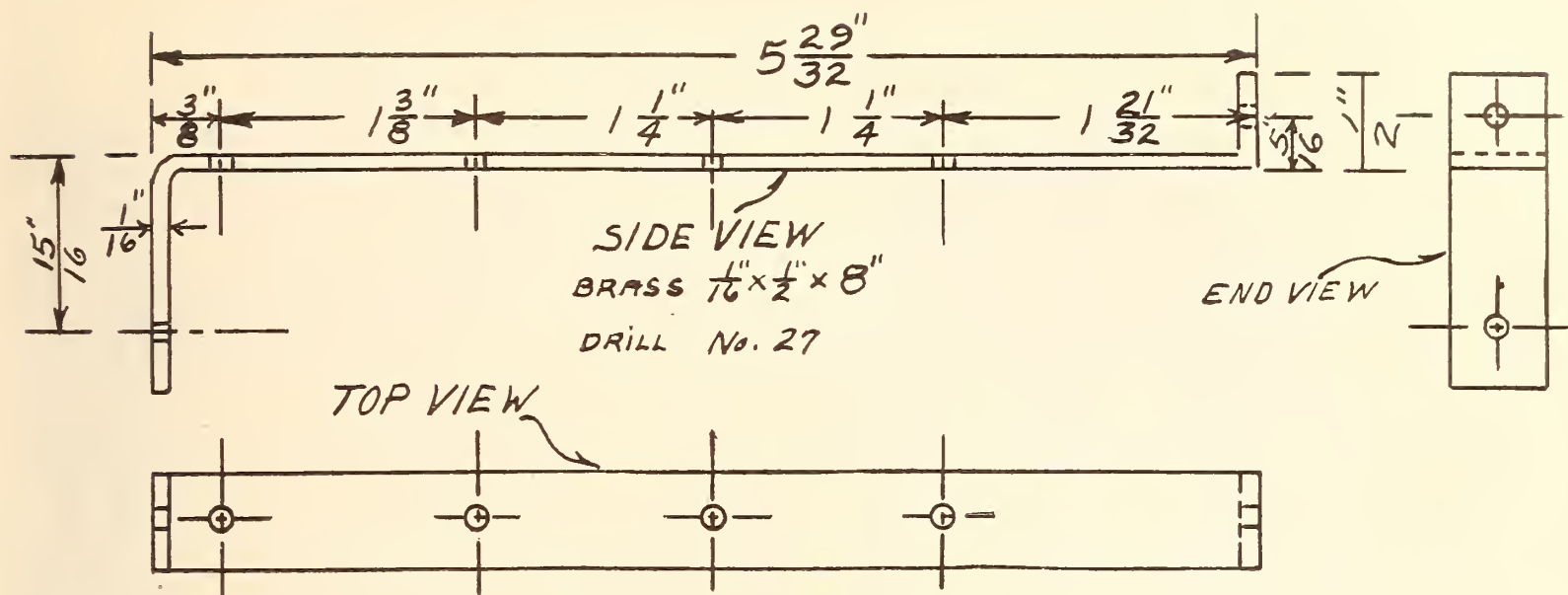

DETAILS OF SHELF SUPPORT

with the positive side to the minus side of the A and B batteries. They in turn are grounded to the frame, thus bringing the transformer cores to ground potential.

connect the A battery to the B battery binding post and see if by chance the tubes light, showing that you have made a mistake. This may save the life of a tube which might otherwise be burned out.

To check the B battery circuit it is well to

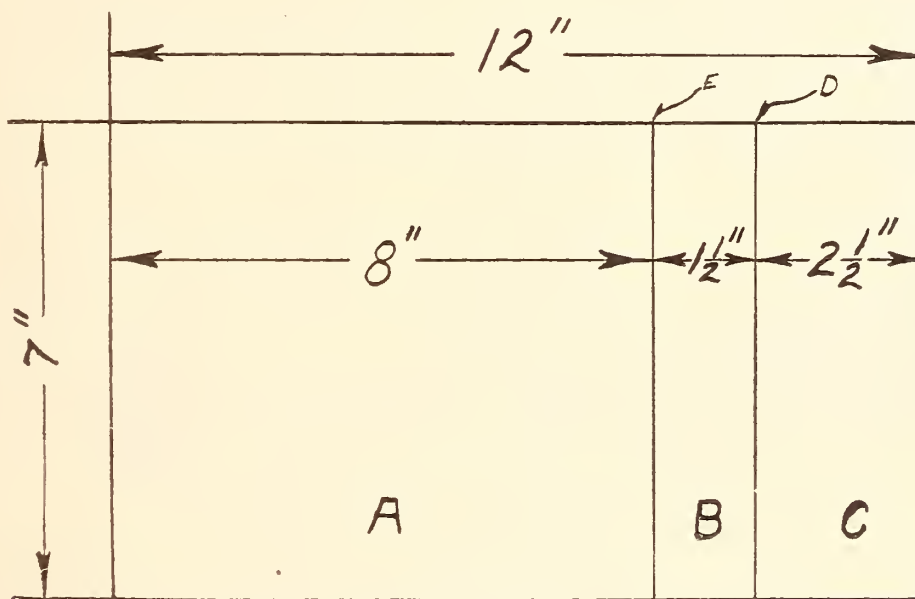

PANEL LAYOUT

Laying off 8" from the left and  $2 \frac{1}{2}$ " from the right leaves a piece about  $1 \frac{1}{2}$ " in between. Saw line D first. In sawing line E keep the saw well to the right of the line and thus allow some leeway for squaring up the edge of the front panel with a file. It will be found that the pieces B and C will not actually measure  $1 \frac{1}{2}$ " and  $2 \frac{1}{2}$ " respectively due to the loss of material caused by the sawing



# The Grid

## QUESTIONS AND ANSWERS

The Grid is a Question and Answer Department maintained especially for the radio amateurs. Full answers will be given wherever possible. In answering questions, those of a like nature will be grouped together and answered by one article. Every effort will be made to keep the answers simple and direct, yet fully self-explanatory. Questions should be addressed to Editor, "The Grid," RADIO BROADCAST, Garden City, N. Y.

### ADDING AUDIO AMPLIFICATION TO THE R. B. ONE-TUBE REFLEX

*I have built the one-tube reflex set described in the November RADIO BROADCAST, and I must say it is a wonderful little set. I should like to add one stage of additional audio amplification to it, and should appreciate your showing me just how it is done. I should like to use filament control jacks, as one of this type is already in the single tube set.*

R. O. O., New York City.

THE accompanying diagram Fig. 1 shows the connections for adding one stage of exterior, or straight audio-frequency amplification to the single-tube reflex set. Filament control jacks, of the most easily obtainable type, have been indicated, but readers not possessing jacks of this design may use any other type that will accomplish the same thing. The reader having any doubt concerning

the connections for the particular type of jack which he finds it necessary to employ, is advised to read the article on "Jacks and How to Use Them" appearing in the April RADIO BROADCAST. Of course, straight double-circuit non-filament-control jacks may be used if desired, the filaments being turned off by a switch, if a balance resistance such as the "Amperite" is used, or by a rheostat, which acts as a switch when in the "off" position.

Observant readers may notice that the positions of the telephone receivers and the "B" battery have been reversed. The reason for this is explained in the amplification article in the July RADIO BROADCAST, which readers desiring to add amplification to any set, will find it worth while reading. The diagram is otherwise quite self-explanatory. Any well known and reliable amplifying transformer can be used. This one additional stage will probably be all that will ever be desired on this remarkable little set.

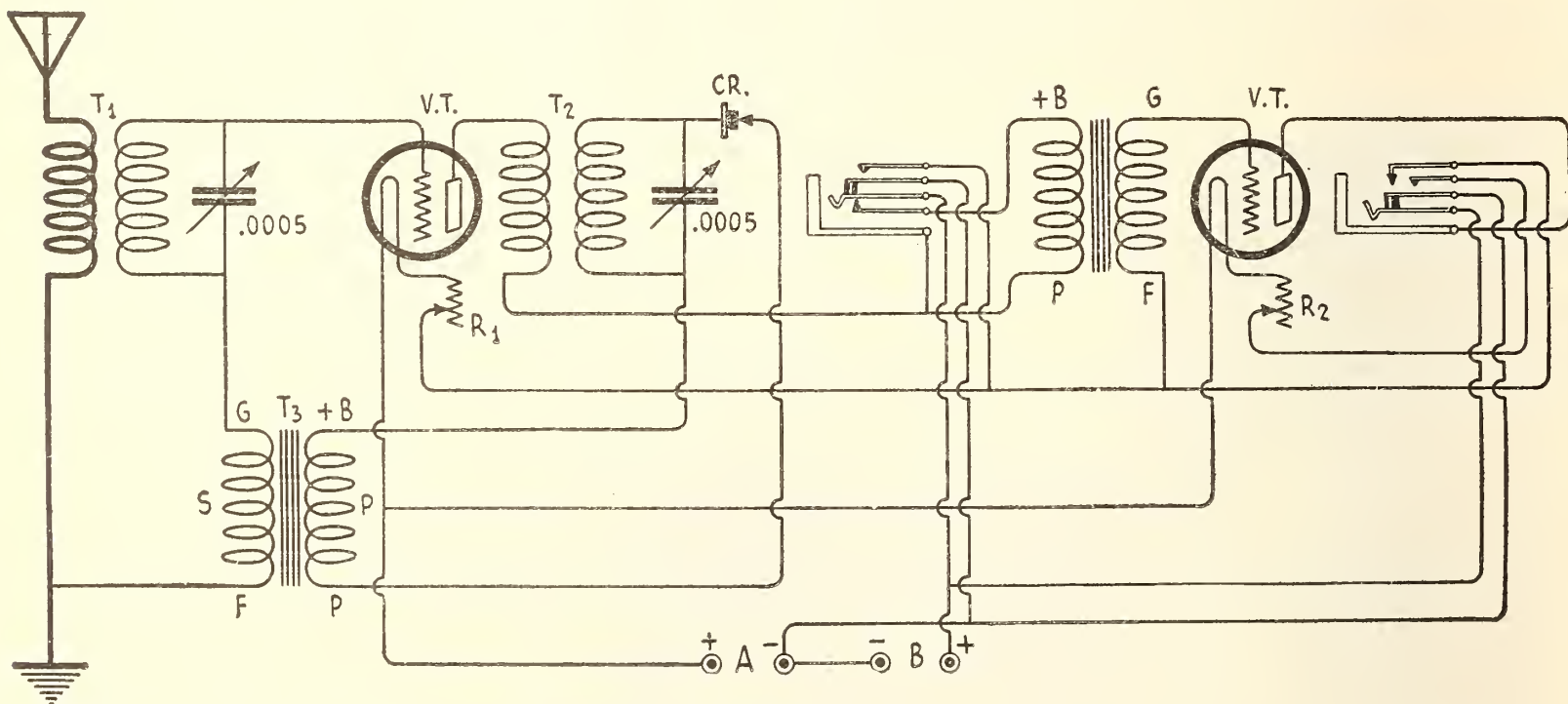
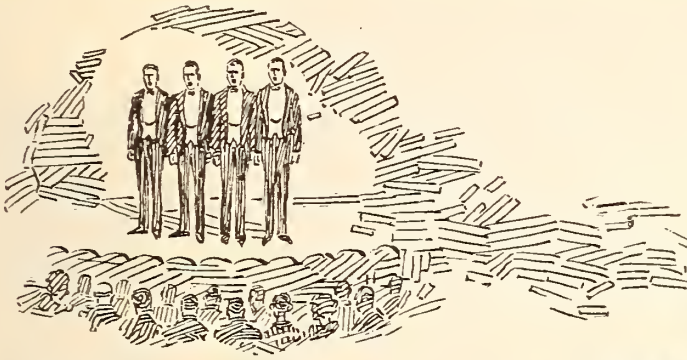
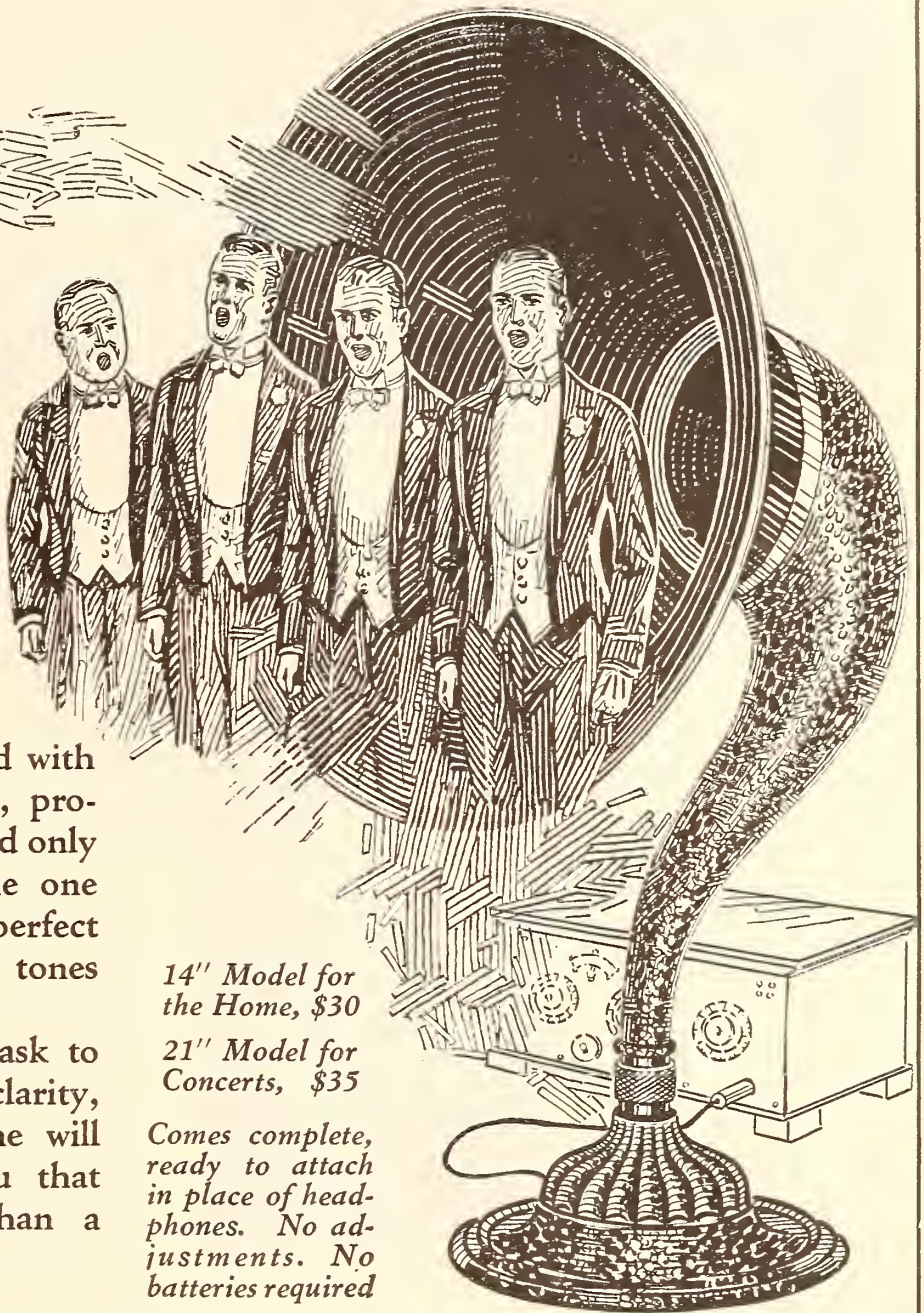

FIG. 1

One stage of audio added to the one-tube reflex set. Note the position of telephones and "B" batteries



# WOOD'S The Thing!!



MUSIC MASTER is equipped with a *wood* amplifying bell. Wood, properly shaped as a horn,—furnished only with MUSIC MASTER,—is the one material that makes possible perfect reproduction of the actual, living tones themselves.

Go to your radio dealer and ask to hear MUSIC MASTER. Its clarity, brilliance and naturalness of tone will delight you—and prove to you that MUSIC MASTER is more than a name.

DEALERS EVERYWHERE

14" Model for the Home, \$30

21" Model for Concerts, \$35

*Comes complete, ready to attach in place of headphones. No adjustments. No batteries required*

## MUSIC MASTER CORPORATION

(Formerly General Radio Corporation)

*Makers and Distributors of High-Grade Radio Apparatus*

CHICAGO

S.W. Cor. 10th and Cherry Sts., PHILADELPHIA PITTSBURGH

# Music Master

## RADIO REPRODUCER



# Among Our Authors



W. W. ROGERS

services and other radio topics.

**E** F. McDONALD, JR., who has something interesting to say this month on "What We Think the Public Wants," is President of the National Association of Broadcasters and head of the Zenith Radio Corporation. He confessed to us from Chicago the other day that he was born in Syracuse, N. Y., and positively does not play golf, but likes yachting and hunting. He accompanied Mac Millan on the *Bowdoin* as far as Labrador last summer.



E. F. McDONALD, JR.

**L** A. HAZELTINE is the inventor of the neutrodyne circuit. He is head of the Department of Electrical Engineering at Stevens Institute of Technology at Hoboken. He is also manager of the Institute of Radio Engineers and served as a member of Secretary Hoover's Radio Conference Board.



R. H. AND W. B. MARRIOTT

**W** W. RODGERS, who contributes "Broadcasting Complete American Programs to All England" in this issue, lives in the industrial smoke of Pittsburgh. He has contributed to our pages before on broadcasting church

graduated from Ohio State. Mr. Marriott sends this photograph of himself and his son on their way to make a "Siwash" camp in Alaska. "On this occasion," Mr. Marriott writes, "the boy got a trout sixteen inches long. We caught a deer, as well."

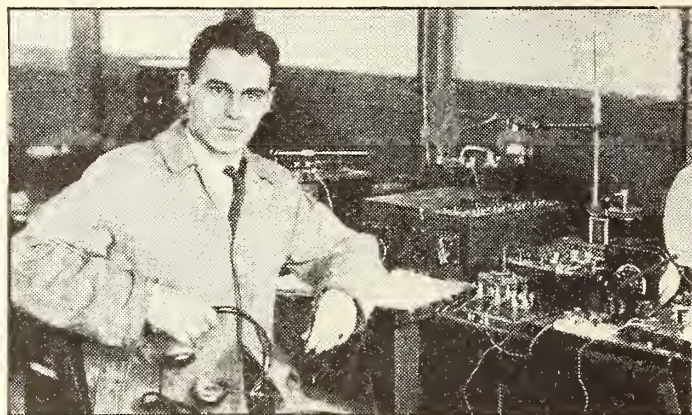

LEWIS M. HULL

**I** FIRST BECAME interested in radio when an undergraduate at the University of Kansas in the days when carborundum and Gen. Dunwoody were equally famous, and the rotary spark gap was an innovation," says Lewis M. Hull of the Radio Frequency Laboratories at Boonton, N. J. He adds, speaking of his research at Cruft Radio Laboratory at Harvard and at the Bureau of Standards in Washington: "and I've since been making futile but persistent efforts to see things invisible and hear things inaudible." Doctor Hull admits a fondness for historical novels and counterpoint.

**C** ARL DREHER sends us the second article of his interesting series on the receiver and the received this month. He is a radio engineer who is as much at home in the unrelated fields of philosophy, sociology, and literature as among the big quiet tubes of a broadcasting station. He is a quiet sort, but mention of the movies is apt to cause trouble. He is in charge of WJZ and WJY.

**W** ALTER VAN B. ROBERTS is doing research work in physics at Princeton. In the intervals he plays golf and writes radio articles.



W. VAN B. ROBERTS

**R** OBERT H. MARRIOTT writes this second article in his series from Bremerton, Washington, where he is a radio engineer at the Puget Sound Navy Yard. He first became interested in radio in 1901 after he





## THE SIEGE

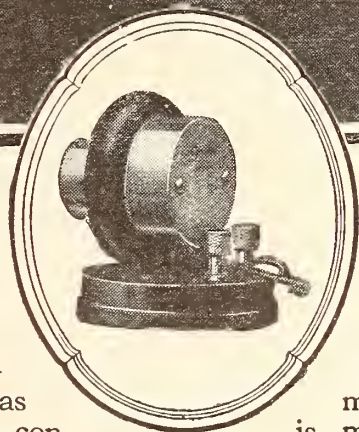

## OF TROY

**A**T the dawn of civilization the signal fire was the principal means of conveying information over distances.

During the ten-year siege of ancient Troy, the Greeks under Agamemnon by this means maintained constant communication throughout their encircling camps.

To-day there has been developed a series of instruments that enable us to communicate and even project our actual personalities over vast distances.

Of all the instruments that make Radio possible none is more important than the Headphones or Loud Speakers. These transform into sound the delicate electric currents produced in your receiving set. If they are imperfect, the results are unsatisfactory.

**HOLTZER-CABOT** Headphones and Loud Speakers embody the latest developments in the art and will greatly increase your enjoyment of Radio.

Holtzer-Cabot Loud Speaker,	\$25.00
Loud Speaker Phonograph Attachment,	10.00
No. 2 Universal Headphones,	9.50
No. 4 National Headphones,	6.00

*Write for booklets explaining how the exclusive features of these instruments enable you to enjoy the wonders of Radio*

**THE HOLTZER-CABOT ELECTRIC CO.**  
 125 Amory Street, **Boston, Mass.**  
 6161-65 South State Street, **Chicago, Ill.**  
 Dept. A

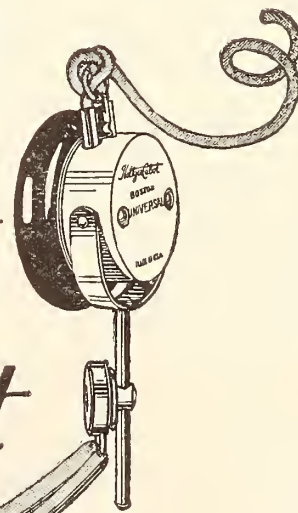
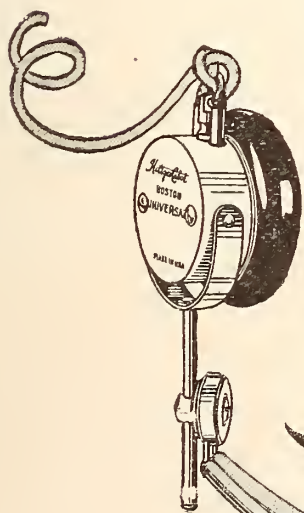

*Holtzer-Cabot*  
 BUSINESS ESTABLISHED 1875



## More About the Super-Heterodyne

ARTICLES have appeared in this magazine on the super-heterodyne receiver in the February, August, November, December, 1923, issues, as well as in January and March, 1924. There will be another important article in our April number.

Since all of these articles, except that of Mr. Paul Godley in February, 1923, and that of Mr. Walter van B. Roberts in August, 1923, specify intermediate frequency transformers—type UV-1716—which have become difficult to purchase, many eager experimenters have not been able to build one of these sets. Transformers are now appearing on the market for this purpose. In our April issue, we will publish the details of transformers which may easily be built, which will effectively replace the UV-1716 and others necessary for the super-heterodynes we have described.

On page 347 of our August, 1923, issue, Walter Roberts describes the windings and characteristics of a suitable intermediate frequency amplifier which will work quite satisfactorily.

Mr. Godley's article in February, 1923, was introductory, showed fundamental circuits of an excellent receiver he built. In August, 1923, Mr. Roberts described a six-tube outfit with UV-199 tubes, of which he writes: "this receiver has all the advantages of the super-heterodyne control, the neutrodyne type amplifier, and the "reflex" system rolled into one."

In Mr. George Eltz's two articles, he describes in December, how to make a "super" out of extras around the laboratory. In his November, 1923, contribution, he describes a seven-tube outfit which has been very neatly installed and arranged.

Mr. Haynes in January, 1924, and in this present issue, has described his seven-tube super, avoiding the use of the unobtainable UV-1716 transformer. In our Lab section for the April, 1924, issue, we will have an article describing how to make a satisfactory intermediate frequency transformer, which may be used in the Haynes super-heterodyne circuit, as well as information on the super-heterodyne for 100 meter reception.

---

## How Spark Interference Was Reduced

By JACK BINNS

Radio Editor, *New York Tribune*

MUCH of the interference encountered by broadcast listeners comes from commercial spark stations which use the wavelength of 450 meters. The recent conference at New York, presided over by Arthur Batcheller, Supervisor of Radio, Second District, which abolished this wavelength, was called as a result of the interest of the Radio Club of America and its President, George Burghard.

The agreement by which the 450-meter wave was abandoned and most ship to shore communication moved up above 600 meters came as a direct result of the personal interest which President Coolidge has taken in the entire radio art. This interest commenced when his address to Congress was broadcast. Shortly after that a committee headed by George E. Burghard, president of the Radio Club of America, called upon the President to bring to his attention the serious interference caused by ship to shore communication on the 450-meter wave. The committee pointed out to the President that the 450-meter wave was only used by the United States and was not authorized under the International Radio Convention.

This agreement, however, is entirely voluntary and has no binding force. The radio inspector cannot legally enforce it, so that at any time, any of the operating companies may violate, it should occasion arise.

In view of the tremendous improvement which

has been effected as a direct result of the agreement, steps should be taken immediately to see that it is embodied in an act of Congress that will give the full force of the law behind it. In this connection, every radio fan should write to his particular representative, urging the enactment of such a rule.

Since the new order went into effect, officers of the Radio Club of America have been carrying on a very careful study of the resulting situation, particularly to determine just how much interference has been cut down. The survey included constant listening-in to distant as well as local programs with highly sensitive receivers such as the super-heterodyne. This work has been carried on by the officers of the club, including Major E. H. Armstrong.

### IMMEDIATE IMPROVEMENT

IN OUTLINING results, George E. Burghard, president of the club, said: "The effect of the agreement became apparent immediately, especially on the higher wavelengths used by the broadcasting stations in different parts of the country. For instance, in the City of New York, with a super-heterodyne receiver, we have been able to reproduce, with a great deal of regularity, the programs from station KSD, in St. Louis, which operates on the wavelength of 546 meters. This reception has been done with practically absolute freedom from spark interference.

47  
FEB. 1924

**RADIO**

25 CENTS

# BROADCAST

Who Heard England?

What Limits Long Distance Reception?

Is the Amateur at Fault?

How the C Battery Prevents Distortion

A "Knock-out" 3-Tube Receiver



**CUNNINGHAM  
RADIO TUBES**

C-301A—5 Volts 1-4  
ampere filament \$6.50  
C-299—3 volts, .06 amp.  
Dry Battery Det. &  
Amp. .... \$6.50  
C-300—5Volts Gas Con-  
tent Detector..... \$5.00  
C-11—1.1Volts, 25 amp.  
Dry Battery Det. and  
Amp. Special Base \$6.50  
C-12—Similar to C-11  
with standard base  
..... \$6.50

**PATENT  
NOTICE**

*Cunningham tubes  
are covered by patents  
dated 11-7-05, 1-15-  
07, 2-18-08, and others  
issued and pending.  
Licensed for amateur,  
experimental and en-  
tertainment use in  
radio communication.  
Any other use will be  
an infringement.*

Type C-301A gives greater Power Amplification with only  $\frac{1}{4}$  Amp. Filament Current.

# Cunningham

## RADIO TUBES

*For Every Make of Receiving Set*

**T**HROUGHOUT the entire country to-day Cunningham Radio Tubes are recognized as the ideal tube for use in all makes of Radio Receiving Sets.

The famous Cunningham C-301A Amplifier shown above is a high vacuum tube designed for use as an amplifier and detector containing a new Tungsten Filament, the characteristics of which are long life, low power consumption, low operating temperature and greater power amplification than any previous amplifier tube. This tube has a standard four prong base, and the glass bulb has the same dimensions as

C-300 and C-301. The filament current is only one-fourth of the filament current of the previous type of Amplifier tube, and it is, therefore, possible to use four of these tubes in a set, without exhausting the storage battery any faster than when using only one of the previous types of tubes.

The care and operation of each model of Receiving Tube is fully explained in our new 40 page "Radio Tube Data Book." Copies may be obtained by sending ten cents in stamps to our San Francisco office.



*E. J. Cunningham Inc.*



Home Office:  
182 Second Street  
San Francisco

154 West Lake Street  
Chicago

30 Church Street  
New York

★ Tested and approved by RADIO BROADCAST ★



# Rheostats - Potentiometers

GENERAL RADIO type 214 rheostats and potentiometers are a quality product. The base is made of genuine moulded bakelite and the wire is tightly wound on a specially treated fibre strip. A perfect, non-arcing contact is thus assured.

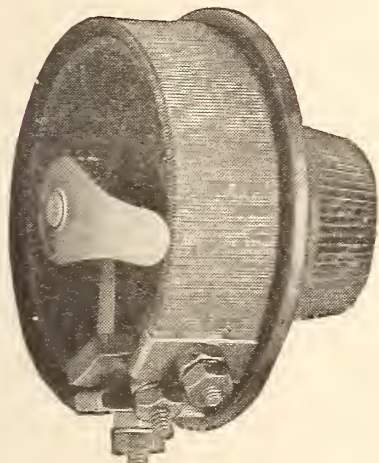

Type 214

Where a smaller rheostat or potentiometer is required the type 301 will be found very satisfactory. These units are similar in construction to our type 214.

The diameter of the 214 rheostat is three inches and that of the 301 is two inches.

G R rheostats and potentiometers also embody—

*Fineness in adjustment*

*Smoothness in operation*

*Temperature resistance stability*

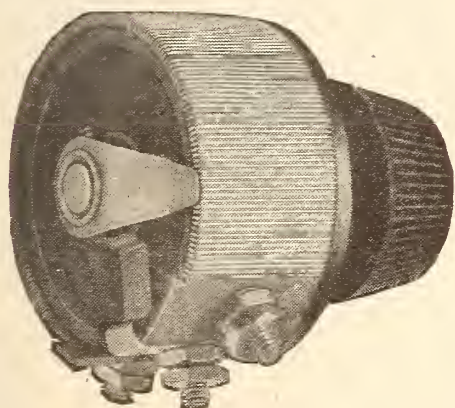

Type 301

TYPE	PRICE
214A 2 ohm Rheostat.....	\$2.25
214A 7 " " .....	2.25
214A 20 " " .....	2.25
214A 50 " " .....	2.25
214A 400 ohm Potentiometer .....	3.00
301 10 " Rheostat.....	1.25
301 30 " " .....	1.25
301 200 " Potentiometer .....	1.25

Send for Bulletin 916B

## GENERAL RADIO COMPANY



Manufacturers of Electrical and Radio Laboratory Apparatus

MASSACHUSETTS AVENUE AND WINDSOR STREET

CAMBRIDGE

MASSACHUSETTS

# Radio Broadcast

ARTHUR H. LYNCH, EDITOR

## FEBRUARY, 1924

A PAGE IN RADIO HISTORY - - - - -	<i>Frontispiece</i>	
THE MARCH OF RADIO - - - - -	<i>J. H. M.</i>	271
THE FACTOR THAT LIMITS LONG-DISTANCE RECEPTION - - -	<i>A. J. Haynes</i>	283
THE CHOICE OF A RECEIVING TUBE - - - - -	<i>B. S. Havens</i>	287
FROM BINDING POST TO VARNISH - - - - -	<i>Howard S. Pyle</i>	289
IS THE AMATEUR AT FAULT? - - - - -	<i>Carl Dreber</i>	293
CHARLES PROTEUS STEINMETZ - - - - -	<i>J. H. Morecroft</i>	296
HOW THE C BATTERY PREVENTS DISTORTION - - - - -	<i>John F. Rider</i>	298
IN THE R. B. LAB - - - - -		303
The Latest Reports on the Grimes Circuit	Transformers and Reflex Sets	
Spider Webs and the One-Tube Reflex	Loading the Twin Variometer Set	
Building Your Own Lab		
OPERATING THE NEUTRODYNE RECEIVER - - - - -	<i>Kimball Houton Stark</i>	310
VARIOUS CIRCUITS AND WHAT THEY MEAN		
Part III. Capacity and Inductance: Their Relation to Tuning	<i>Zeb Bouck</i>	313
ANNOUNCING SOME ANNOUNCERS - - - - -		317
THE ANATOMY OF THE B BATTERY - - - - -		318
THE YOUNG HEART - - - - -	<i>Robert Oliver</i>	320
HOW LOUD SHALL THE LOUD SPEAKER SPEAK? - - - - -	<i>R. H. Marriott</i>	323
A "KNOCK-OUT" 3-TUBE SET - - - - -		325
THE RIGHT INSULATOR IN THE RIGHT PLACE - - - - -	<i>Paul McGinnis</i>	331
I HAD TO TELL IT - - - - -	<i>Willis Kingsley Wing</i>	333
WHEN COWBOYS HEARD BEDTIME STORIES - - - - -	<i>Thomas H. McKee</i>	338
WHO HEARD ENGLAND? - - - - -		341
WHAT BROADCASTING DOES FOR A NEWSPAPER - - - - -	<i>Winfield Barton</i>	344
THE GRID - - - - -		347
How to Connect Jacks	Bank Winding	
How to Make a Wave-Trap	R. F. and the Flivver Circuit	
Wavelength and Size of Coils		
ADDITIONAL BROADCASTING STATIONS IN THE UNITED STATES - - - - -		354
AMONG OUR AUTHORS - - - - -		356

Copyright, 1924, by Doubleday, Page & Co. All rights reserved

TERMS: \$3.00 a year; single copies 25 cents

F. N. DOUBLEDAY, Pres.

RUSSELL DOUBLEDAY, Sec'y.

ARTHUR W. PAGE, Vice-Pres.

S. A. EVERITT, Treas.

NELSON DOUBLEDAY, Vice-Pres.

JOHN J. HESSIAN, Asst. Treas.

## DOUBLEDAY, PAGE & CO.

THE WORLD'S WORK

COUNTRY LIFE

THE GARDEN MAGAZINE

SHORT STORIES

EDUCATIONAL REVIEW

CHICAGO: People's Gas Bldg.

GARDEN CITY, N. Y.

NEW YORK: 120 W. 32nd Street

BOSTON: Tremont Bldg.

LOS ANGELES: Van Nuys Bldg.

# Radiotron

REG. U. S. PAT. OFF.

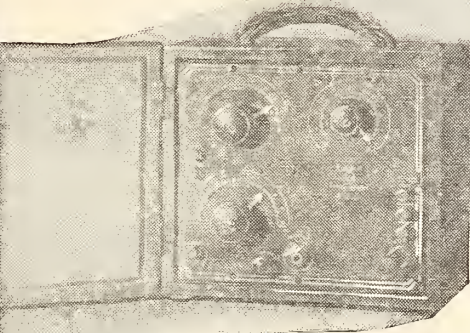
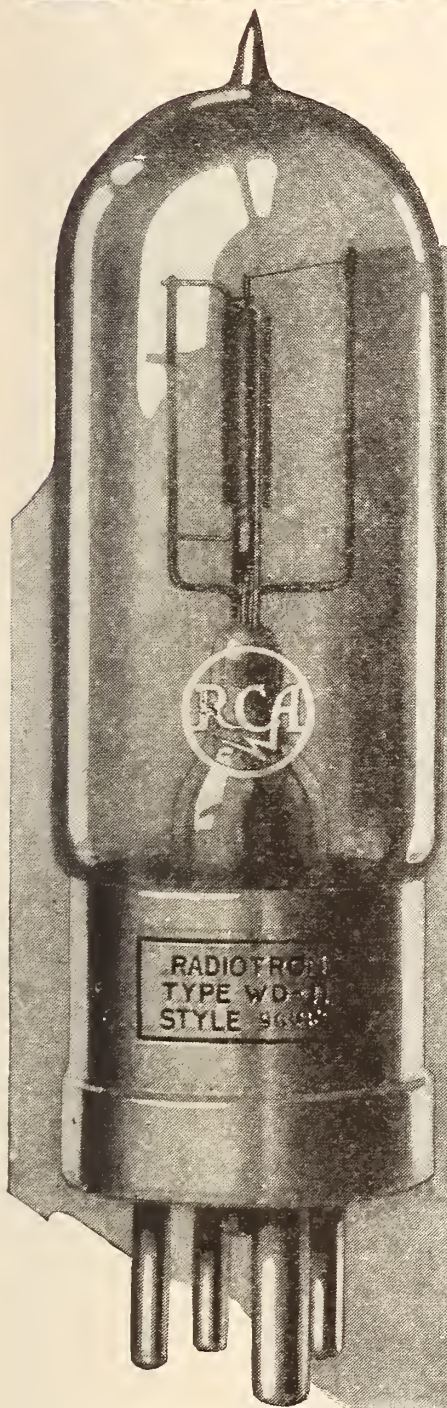

Radiola II

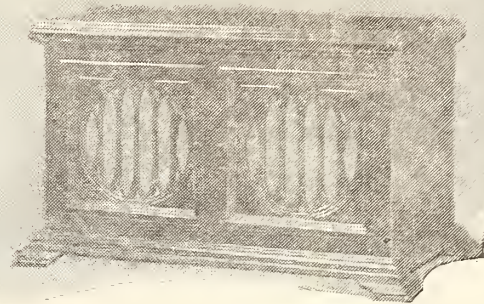

Radiola IV

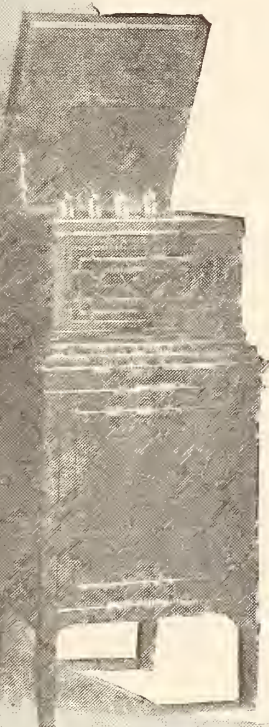

Radiola Grand



Radiola V with Loudspeaker

In high quality receiving sets, the vacuum tubes — the heart of their fine performance — bear the name **Radiotron** and the **RCA** mark. Be sure to look for this identification when you replace your tubes.



This symbol of quality is your protection

- Radiotron WI-11
- Radiotron WD-12
- Radiotron UV-159
- Radiotron UV-200
- Radiotron UV-201-A



Radio Corporation of America

Sales Offices:

233 Broadway, New York

10 So. La Salle Street, Chicago, Ill. 433 California Street, San Francisco, Cal.

# Radiola

REG. U. S. PAT. OFF.

Send for free booklet that describes all Radiotrons giving their characteristics and circuit diagrams.

Radio Corporation of America  
Dept. 32. (Address office nearest you.) Please send me your free Radiotron Booklet.

Name \_\_\_\_\_

Street Address \_\_\_\_\_

City \_\_\_\_\_ State \_\_\_\_\_

★ Tested and approved by RADIO BROADCAST ★

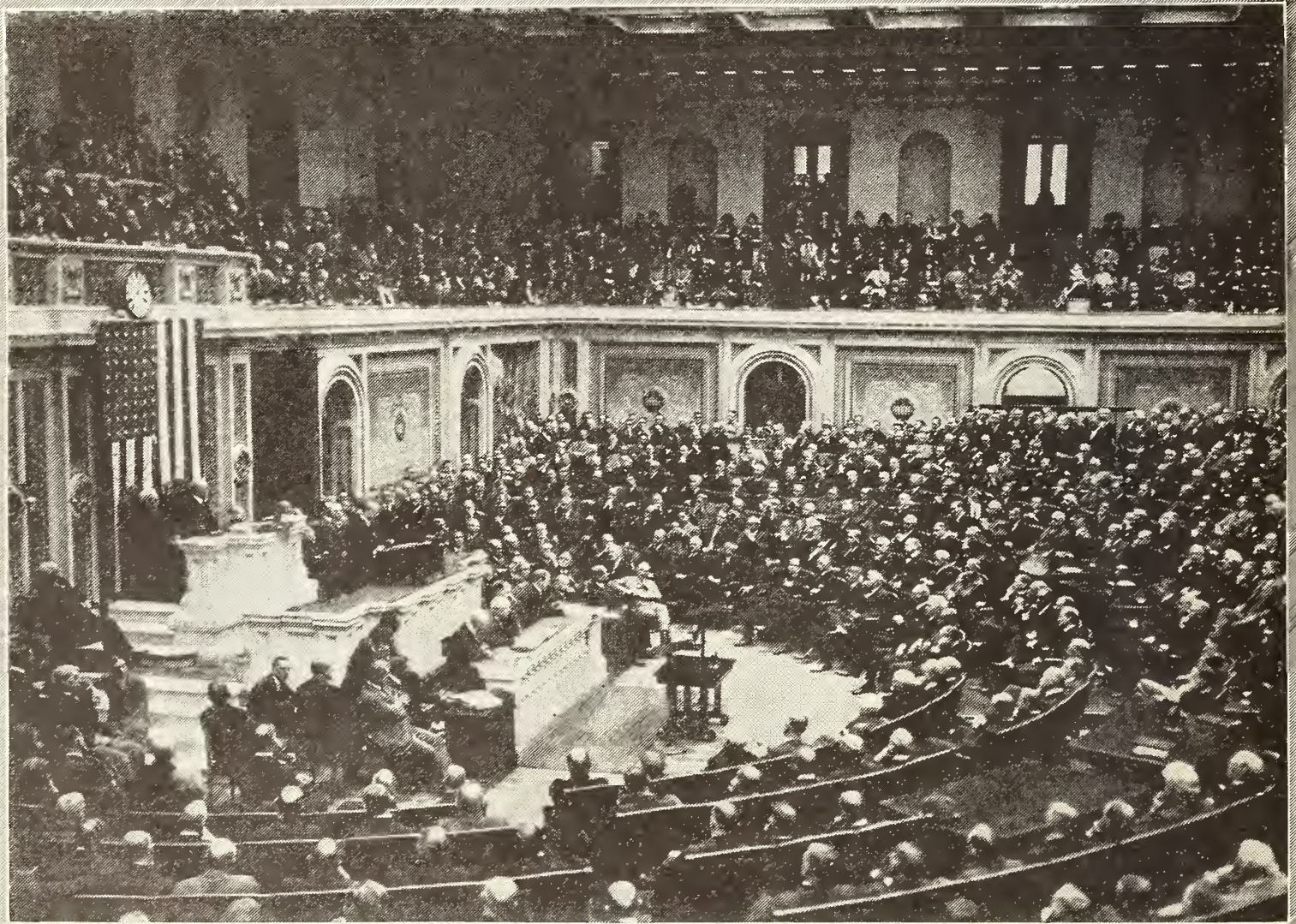
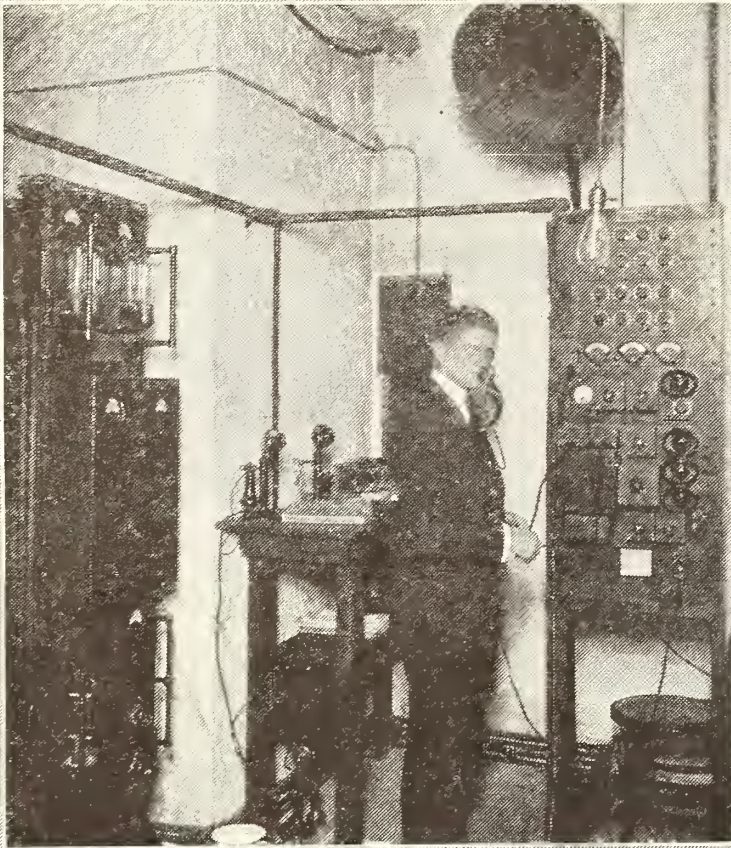

© Kadel & Herbert and Wide World

#### A PAGE IN RADIO HISTORY

At 12:40 P. M., on Thursday, December 6, 1923, the President's voice as he delivered his annual message to the Congress was heard not only by the Congress, but by all who could listen-in on any one of six stations (WCAP, WEA, WJAR, WDAF, KSD, and WFAA). People from Maine to Texas heard the speech so clearly that the President's New England inflection was easily noticeable. Two microphones may be seen in front of the President's manuscript. UPPER LEFT: The amplifying panel located in the basement of the Capitol. UPPER RIGHT: The microphone control operator in the balcony of the house



# RADIO BROADCAST

Vol. 4 No. 4



February, 1924

## The March of Radio

### BROADCASTING BROWNING

**A** VERY interesting experiment has been inaugurated through the co-operation of the management of Station WEAJ and the Home Study Department of Columbia University. The question has frequently been put: Is there a demand for the transmission of real educational material over the radio channel? Does the radio public want only amusement from the evening's radio hour or would an educational course of high order, presented by an authority, be welcomed and appreciated?

Undoubtedly, a very large part of the present-day radio audience prefers jazz to a Philharmonic concert; of two equally available stations, one modulated by the whining tones of a saxophone orchestra and the other by the voice of an eminent Shakesperean scholar, there is no doubt as to what wavelength most of the sets would be tuned to. Elementary talks on radio and kindred subjects, such as storage batteries, loud speakers, and the like, unquestionably get the attention of the average radio listener, but probably this is because the knowledge thus gained is to be used the following evening in improving the reception of popular music. This is not the type of talk we have in mind in asking the question about the value of radio as a means of education.

A certain amount of sound education is un-

doubtedly being absorbed by the radio listeners as a result of the excellent musical programs being broadcasted nowadays by the better class of stations; one cannot listen, for example, to a worth-while rendition of "Elijah" accompanied by explanatory comments on the work and its composer without absorbing some knowledge of music and its masters. The well known and much appreciated "Roxie," with his excellent staff of artists, is doing much to make us appreciate good music. Many people have heard better music at Roxie's Capitol Theatre concerts than they ever heard before, and their taste for good music by high-grade performers has been whetted as a result. A radio impresario of the right kind can educate the musical tastes and appreciation of his audiences quite painlessly. We remember a mildly sarcastic comment directed at our well loved Professor of Chemistry, whose lecture notes were liberally diluted with stories, good and otherwise. A more sober-minded colleague, whose son had attended the chemistry lectures, inquired whether the chemistry department considered story telling as a major course, and if they didn't why were there so many stories in a course in general chemistry? "Well, you see," was the retort, "many of the boys really don't like chemistry; it seems to them dry and uninteresting—but they do like stories of the kind I tell



#### BROADCASTING BROWNING

Hoxie Neale Fairchild, Supervisor of Home Study Courses at Columbia University, whose first radio lectures on Robert Browning were favorably received

them. So they swallow the stories, I inject a little chemistry, and that goes right down at the same time as the stories and before they know it they have really learned a little chemistry, and have enjoyed doing so."

But education gained in this fashion isn't what we have in mind when we consider the question whether radio can be used as an educating medium. Is there a demand for out-and-out educational lectures on art or literature? Is there an appreciable percentage of the radio listeners who wish serious talks by acknowledged authorities? Furthermore, is the demand for such a radio program sufficiently real to induce people to pay enough for it to make the work self-supporting? This is the question to which WEA and Columbia are seeking the answer. One of Columbia's scholars, an authority on Robert Browning and his work, is giving a series of ten twenty-minute talks on this poet alone. A synopsis of the ground covered is sent to those interested, *for the sum of five dollars*. The synopsis is so arranged that much more benefit may be derived from the lectures themselves if one has properly studied it before listening to the evening's lecture, as

the lecturer continually refers to it during his talk.

This is probably the first time that an attempt has been carried out to make radio directly self-supporting. Fortunately, the lecturer was well chosen. He is gifted with a good radio voice, it is as easy to listen to him by radio as though one were in his class room. Now the interesting point is this: although any one can listen-in on these talks without paying the five dollars, and although the talks are of no material value to the listener (i. e., they do not increase his earning capacity or make the adjustment of his radio set any easier), *the demand for the Browning synopsis has been immediate* and after the first lecture the director of the work told us that the cost of conducting the work had already been paid for by the copies sold! The American Telephone and Telegraph Company has been sufficiently interested in this experiment to give the use of its station to the University, without cost, for carrying out this experiment in education. In the course of the next two months we shall get more interesting information as to the success of this course.

#### Bureau of Standards Tests Receiving Sets

**A** LENGTHY report is at hand giving the work of the Bureau of Standards in making comparative tests of the better known receiving sets on the market. The sets tested are, of course, not tabulated by name, but those familiar with the radio receiver market will easily identify them since they are described in detail.

An extremely wide range in sensitiveness and selectivity is shown when comparing the different types of receivers; we have known that such was the fact but have never seen before an unprejudiced compilation of the merits of the sets put on the market by the various manufacturers. The comparative merits of the sets tested is probably not of very great importance because of the frequency with which changes in receiver design are incorporated by any wide awake manufacturer. This publication of the Bureau will probably be of considerable value to radio engineers and manufacturers, however, as indicating what seems to be a very reasonable ground upon which to judge the merits of a set, and thereby pointing the way to improvement in design.

## General Electric Company to Invade the Middle West

THE General Electric Company has chosen Denver, Colorado, as the site of a broadcasting station to be erected as soon as the station at Oakland California, is completed. Work in Denver will probably be in progress before the spring of this year.

Denver will have the third, and probably the last, station in the G. E. string of broadcasting stations. The first, WGY in Schenectady, has been in successful operation for the last eighteen months and both the Oakland and Denver stations will be modeled after it in so far as technical equipment is concerned. They will each have the same power and sending radius, it is presumed, as WGY, which station has, under favorable conditions, been heard simultaneously all over the United States, in England, Hawaii, and several countries of South America.

### Data on Standard Single-Layer Coils

IF YOU are interested in having standard coils with which to compare those you are using in your experiments, it is worth your while to send to the Bureau of Standards for Letter Circular No. 103, entitled "Description of a Series of Single-Layer Inductance Coils Suitable for Radio-Frequency Standards." One wouldn't ordinarily think it worth

while putting out a circular on single-layer coils, but the Bureau has thought it sufficiently important to publish the data, undoubtedly with the idea of cutting down the amount of standardization measurement work which the staff is called upon to do.

A whole series of coils is minutely described, the values of inductance lying between eight and five thousand microhenries, there being a practically constant ratio between the adjacent coils of the series.

### With Justice for All

AND still they ask: "Who is going to pay for broadcasting?" Several performers recently demanded pay for their services, their managers having refused to allow them to appear before the microphone without suitable remuneration. Certainly the radio public should pay. But how much, and how?

The tactics of the self-styled American Society of Composers, Authors, and Publishers, in trying to force broadcasting stations to take out licenses for the privilege of putting their jazz on the air have been frequently commented upon and frequently condemned.

The arguments of their counsel at meetings of the broadcasters, as well as at court proceedings, were specious, beside the point, frequently untrue. Their statements were conjecture rather than fact. On investigation, it was found that the society did not include as much musical talent as its high-sounding name would lead one to believe. A survey showed that



JOHN GREER HIBBEN

President of Princeton University. In a recent letter to RADIO BROADCAST, President Hibben summed up his conception of the educational possibilities of radio as follows:

*I am in hearty sympathy with your efforts and I feel that much may be done in disseminating broadcast to the people of the United States a knowledge of the world, both of the past and present, in its physical constitution and the intellectual, moral, and spiritual influences which move, control, and direct the activities of mankind. I feel that radio does not realize the large scope of its possibilities if it aims only to give momentary pleasure and diversion.*

among the members were only 253 out of 5,000 authors and composers. The conservative writers and publishers were not appreciably represented in their membership, and it was found that much of the most successful music of the day did not originate in this society. This is true, for instance, of such popular hits as "Three O'Clock in the Morning" and "No Bananas."

Representative broadcasters ignored altogether the demands of the small but noisy band of jazz writers. As we have mentioned before,

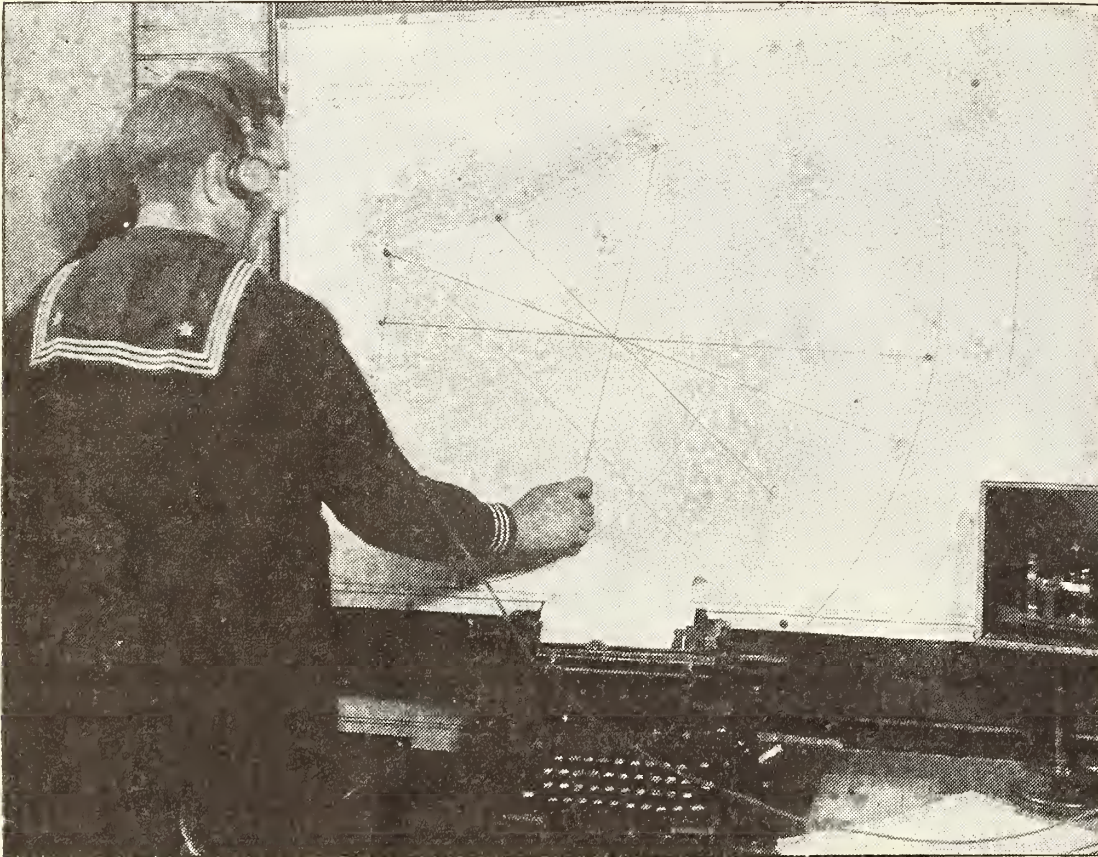

PLOTTING A SHIP'S POSITION

The compass bearings of a given ship, reported to the central station in New York by several radio compass stations, are indicated by lines drawn from the receiving stations on a map. The ship's position is the point at which the lines cross

the outcome was the formation of the National Association of Broadcasters. A successful business man, having intimate knowledge of the musical game, Mr. Paul B. Klugh, was selected as executive chairman to guide the destinies of this new society which is attempting to solve the question of broadcasting rights and income for the broadcasting station. The story of their present and anticipated activities convinces one that they are attacking the problem in a fair and unbiased fashion.

The Broadcasters' first activity was devoted to the question as to whether or not broadcasting did have a real advertising value. So they set about to get real information on the matter. Two experiments they made show, beyond peradventure, how powerful an agent

radio is in making songs popular. The result of such advertising was sure and decisive. In one case, a two-year-old song was selected as a test piece. This song had been put out on phonograph records but the sale had not been large. At the time of the test, the piece was stagnant, most stores reporting practically no sales. An inventory of the records in stock was taken by an agent of the broadcasters. A short time after a good station had broadcasted this song, using an accomplished artist to "put it over", another canvass of the stores

showed that *80 per cent. of the phonograph houses had sold out the record.* With such facts to go on, the broadcasters *knew* what they were talking about.

A composer now sends in his song and it is examined by well-qualified musical critics. If it passes the judges, the members of the association put it on the air. If the song is a hit, the author at once begins to receive whatever royalties on the sheet music the copyright law entitles him to. With no advertising expense of his own, he begins to reap the benefit of the radio advertising. If the song proves sufficiently popular to justify its reproduction for the phonograph and player piano, the broadcasters begin to get some

return for selling the song to the public. Their contract with the author stipulates that a certain reasonable percentage of the mechanical royalties shall accrue to the Association of Broadcasters; if the song is successful, the author receives all the royalties from the sheet music sales. But he shares the royalties from the records and piano rolls, with the National Association of Broadcasters.

This solution of the problem looks logical, and eminently fair to the author. He stands to lose nothing if his song doesn't "go," and if it does, his interests are identical with those of the Broadcasters' Association, so he may be sure that his song will be given as much prominence as possible. We hope the new scheme proves a success.

## Guiding Our Mail Planes

WE SCARCELY realize the extent to which aviation is gradually working itself into the transportation scheme of our country. Trips of the air route-mail carriers are now expected as regularly as those of the mail cars. It is evident that fog and snow present very great danger to the air mail carrier, and that anything which will increase his safety must be developed and utilized as soon as possible. The General Electric Company has undertaken the development of transmitting and receiving sets which are suitable for airplane installation, and tests recently carried out indicate that two-way communication from plane to ground may be reasonably expected with these sets, up to a distance of about one hundred miles, under average conditions.

One contribution to the safety of the airmen, which has had no wide application up to the present, is the "radio beacon"; this is a transmitting station, located at a landing field, which sends out signals in such a manner that when an aviator picks up the signal he knows at once his bearing from the field. In its present form, the radio beacon consists of a transmitter which sends out directional signals, the direction of transmission being adjustable. A characteristic signal, say two dots, is sent due north for a second or two and then the station is silent; five seconds later the two dots are again sent out, but the maximum signal is now a certain number of degrees from north, say thirty degrees west of north. This process is repeated until the signal has been sent all the way around the compass and then after a longer silent period another cycle of signals is sent out. As soon as an aviator comes within the range of such a radio beacon he can at once tell his bearing from the landing field. These beacons will probably be installed at the air mail fields as soon as funds are available.

## WGY and KDKA Recommended as Wavelength Standards

AS A result of the supervision the Bureau of Standards has been exercising over some of our broadcasting stations, they have found that two of the better known stations have maintained their frequency sufficiently constant to enable them to be recommended as secondary wavelength standards. For those who are within range of the Bureau of Standards, of course, observations of the

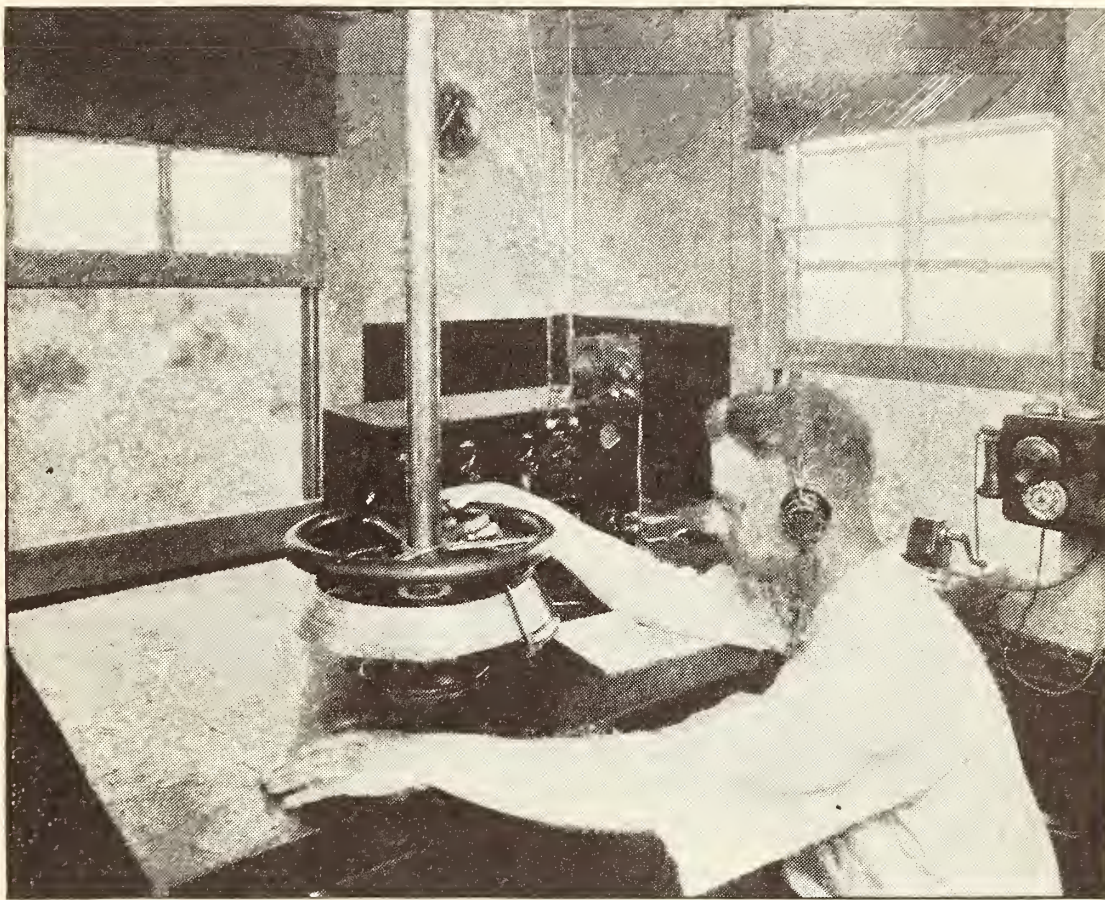

A RADIO COMPASS RECEIVING STATION

At Sandy Hook, N. J. The operator is shown turning the wheel which adjusts the position of the big loop aerial. This station is connected by land wire to the control station shown on page 274

standard frequencies periodically transmitted from WWV give the best method of calibrating a receiving set, but WGY and KDKA have kept their assigned frequencies so closely that for ordinary purposes, their daily transmission may be used. WGY sends on 790 kilocycles, has a maximum observed deviation from this frequency of 0.5 per cent. and an average deviation of only 0.2 per cent. This means that the carrier wave of this station is, on the average, within one meter of 379 meters. KDKA transmits officially on 326 meters and her carrier wave is generally within one meter of this specified wavelength.

These two stations then may be used as frequency standards for any but the most

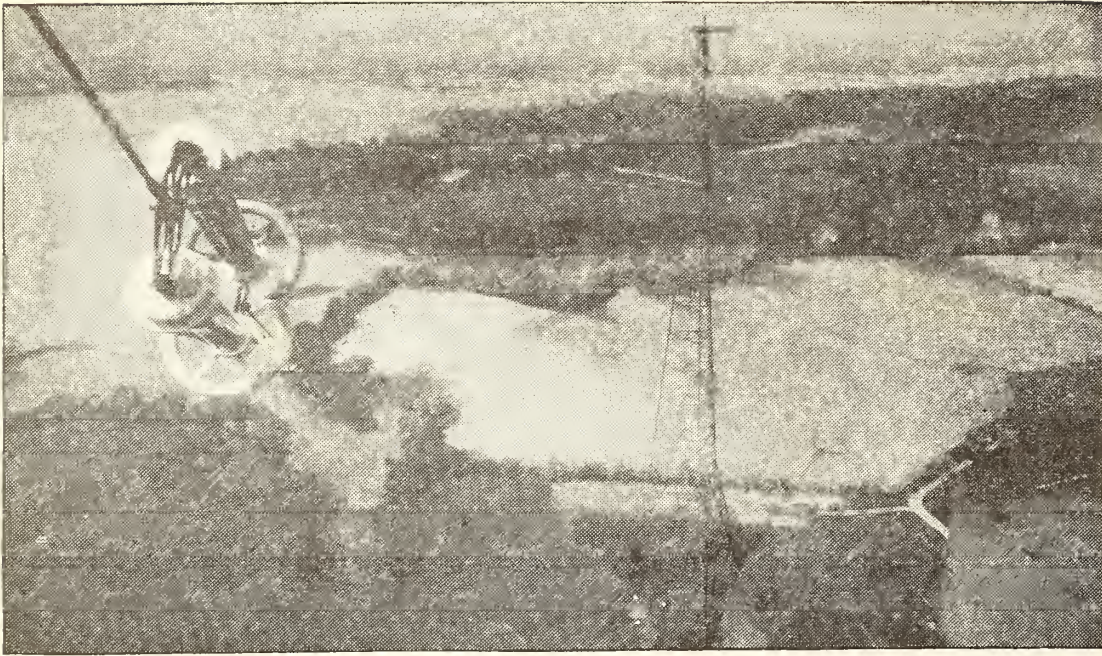

AN INSULATOR'S VIEW OF ANNAPOLIS, MD.  
Taken from the top of one of the towers of the Government transatlantic radio telegraph station (NSS)

precise work. The Bureau of Standards will soon publish results on the frequency of other stations, as soon as sufficient observations have been made to justify their estimate of probable error.

### Once You Hear Them Speak . . .

**O**N SEVERAL occasions lately we have had demonstrations of the great possibilities of radio broadcasting in forming and influencing public opinion.

Just before Lloyd George sailed for England after his circuit of the United States and Canada he was tendered a farewell dinner by the Lotus Club, in New York, where many of America's leaders were present to do honor to Great Britain's best known citizen. In responding to the welcome given him, Lloyd George expressed again, as he had done repeatedly in his many talks in various parts of the country, the importance of unity of ideas and ideals of the two great English speaking peoples. He regarded, so he said, the intertwining of the two flags in the banquet hall as the most helpful sign on the horizon for the future of the world, there being in his mind, of course, the tremendously complex and discouraging situation in Europe with its conflicting and antagonistic interests.

The master of our steel industry, Charles M. Schwab, in commenting upon Lloyd George's idea of the intertwined flags, acknowledged the importance of the idea they symbolized, but said he regarded as much more important the

presence in America of Lloyd George himself. For the message he could bring to our people and deliver by word of mouth was a far more potent agency in cementing the friendship of America and Great Britain than the mere intertwining of flags. And surely all those who heard Lloyd George would agree with Mr. Schwab; the dynamic force behind the argument and exposition of the War Premier stirred everyone.

It is evident that some means must be provided to let such messages be heard by as many Americans as

possible; the spoken word is so much more appealing than the next morning's press version of what the speaker said, absorbed between sips of breakfast coffee. The press now is more mighty in spreading information, but it is written on the wall that the spoken word will soon supplant it as the primary agent in forming public opinion. This spoken word will be carried by radio waves.

On the eve of Armistice Day, thousands of Americans heard their ex-Chief Executive deliver that stinging rebuke, meant to arouse the indignation of those who might influence our government to give more thought to Europe's problems. So faithfully was the radio transmission that one could not help picture, behind that trembling and hesitant voice, the broken man who had but a short time before been the world's leading figure. His voice was passionate with appeal and condemnation. Those who listened to him were impressed by the tremendous earnestness with which this man had pursued his ideals. Whether or not we believe in his arraignment of our government's inaction and aloofness, we must acknowledge radio as the medium for conveying messages of this sort to the people. The appeal of type is as nothing compared to that of the spoken word when delivered in the manner used by Mr. Wilson on the evening of Armistice Day. By the help of radio, the mere whisper as it comes from the lips of the speaker covers vast spaces of our country. Each of us feel then more directly in touch with those we have elected to guide our country's policies.

On Thursday, December 6th, the people throughout the East and Middle West heard the President delivering his message to Congress. Country-wide reception of such an event can, of course, come about only when many stations all over our country are arranged for simultaneous transmission of one speaker's voice. But such a knitting together of the radio channels is rapidly taking place. Six stations broadcasted the President's recent message. By the use of high-quality cable and wire connection, or by inter-connecting radio channels, we shall soon have a dozen or more stations all operated by a single microphone.

### The Long Arm of the Explorer

WE HAVE often stated that one of the most important services radio can perform is to help keep in touch with the rest of their race those intrepid investigators who feel, and follow, the urge to penetrate into distant and uninhabited parts of our world. We stay-at-homes can find entertainment at the theatre or the companionship of our acquaintances, for instance, and can use the wire service for communicating, but to the lonely explorer, with no wire connections and limited means of entertainment, radio is proving a great boon.

During the last month, two instances have forced us to notice this rôle which radio is playing. The daring engineers of the Government Geological Bureau, on their trip of exploration down the Colorado cañon, many

times thought of as lost by those knowing the danger of this seldom attempted trip, informed us after they had successfully finished their long journey that radio kept them in continual touch with the outside world. Two thousand feet down in a crack of the earth's crust, often so narrow that daylight scarcely penetrated, with the raging falls and rapids to tax to the utmost their ability and endurance, when a misstep or accident meant almost certain death, radio cheered and heartened them in the evening by bringing down into their camp, music, news, and entertainment. It is not impossible that a small transmitter might have kept them in continual communication with the outside world, in spite of the unfavorable conditions under which the transmitter would have had to work.

A still more striking instance of radio serving the explorer is seen in the MacMillan polar expedition, now ice-bound off the coast of Greenland. Instead of being cut off from us for a year or more, as would have been the case but for radio, this polar expedition is able to be practically in constant touch with the homeland. Not only is the *Bowdoin*, MacMillan's ship, able to get messages from the more habitable portions of the earth, but it is able to transmit them to us with a reasonable certainty of coming through. Recently MacMillan actually dedicated, with his own voice, the new home of the Chicago Yacht Club, of which he is a member. From a microphone on board his ice-bound boat, his voice was able to leap across the vast spans of ice and



GRAND OPERA IN THE MEADOWS

This car of Lloyd's *Sunday News*, equipped with a receiver and loud speaker, brings the concerts of the British Broadcasting Company to those who would not otherwise hear them

snow which separated him physically from his fellow club members, so that their dedication program could be actually carried out by their most distinguished member.

### Fading

**I**N SCIENTIFIC Paper No. 476 of the Bureau of Standards, an attempt is made to interpret the results of the fading tests carried out by the Bureau with the assistance of about one hundred widely scattered amateurs who volunteered to try and get data which could be compiled in an effort to find out the how and why of fading. Does fading occur at all stations simultaneously and to the same extent? If so, it would seem to indicate a general absorption of the signal in the neighborhood of the transmitting station. Or does the signal increase in stations in one location when it fades in stations in another? If so, it would presumably indicate that the energy which should be normally sent in one direction had been refracted or reflected and sent in another. Is there any law or order about this fading phenomenon?

The scientists at the Bureau attempt to answer the question, in the light of the results of the tests they had carried out, but the answer is quite evidently only conjecture.

Sufficiently accurate data is not at hand to permit a reasonable attack on this problem as yet. Data of the kind required for the solution of problems of this nature cannot be collected by amateurs—that is, amateurs in the sense that they have had no experience in taking accurate radio measurements. If one judges radio transmission by what is heard in the telephone receivers, his data will indeed be of but little value. The ear is of practically no use as a measurer of sound intensity, as may be inferred by any one who has been listening to a signal, as the static gradually increased in intensity. The ear always interprets such an occurrence as a fading of the signal.

This fading phenomenon will be analyzed and explained some day, but it will undoubtedly be solved only after skilled investigators, equipped with the very best radio measuring instruments, have spent much time and effort on the problem. As the question is an extremely important one, we may rest assured that the answer will soon be forthcoming, if one is possible.

### Batting a Dot About

**T**O THE electrical engineer there is nothing novel in the idea of "remote control." Our great electric power stations, generating hundreds of thousands of horsepower, are operated

entirely by one man in a small room overlooking the generator room, who manipulates a set of push buttons. All of the heavy switches and similar apparatus are set into motion by motors and electromagnets, the current for which is controlled by these buttons in the supervisor's tower.

But the crowning achievement of automatic remote control was carried out a short time ago when two tremendous radio stations, one in America and the other in Europe, automatically controlled each other's apparatus. It is possible to put one of our large radio stations "on the air" by a series of very delicate electrically controlled switches, called relays. One of these



RADIOGRAMS TO AND FROM ENGLAND WENT THROUGH HIM

In the recent transatlantic broadcasting tests. He is Mr. H. E. Fulton, operating at Radio Central, Broad Street, New York. The buzzer fastened on the telephone instrument was used in communicating with the RADIO BROADCAST receiving station at Garden City, N. Y.





#### THE FIRST HARMONICA BAND TO GO ON THE AIR

Organized in Junior High School No. 61, New York City. Harmonica bands are being organized throughout the country as a result of the successful venture undertaken at this school

relays may be operated, by the help of suitably disposed triodes, by the minute currents picked up from a radio station thousands of miles away, and this was what was done on the occasion we have in mind.

A telegraphic "dot," sent out from the Radio Corporation's "Radio Central" on Long Island, was picked up by a receiving station in Poland, over four thousand miles away. Suitably amplified and controlled, this dot put the transmitting station at Warsaw into operation, the American station having in the meantime ceased radiating. The dot thus sent out from Warsaw was received in America and here used to put our station back on the air for another dot, the operator in America not touching his sending key after sending the first dot. The dot from this side of the Atlantic then began its travel to Poland and on arriving there

carried out the same operation as the first one, and thus the dot, started in America by the operator pressing his sending key for an instant, was tossed back and forth from America to Europe several hundred times. Except for disturbing influences, such a game of radio baseball might be kept up indefinitely.

This experiment opens an interesting method for checking messages to the engineer responsible for getting traffic through. He could arrange that the Warsaw station be controlled by the message received there from New York, the operator in New York, tuning to the wavelength of the Warsaw transmitting station, can listen to the message as received in Poland.

To one gifted with any imagination, such a test opens up all sorts of possibilities. The physicist sees how he may perform a wonder-

ful experiment to check the results of the famous Michelson-Morley test. This test apparently proved that light waves travel with a fixed velocity through space, independent of the speed of the light-emitting source. The speed of light east and west was compared with that going north and south. Due to the high velocity of travel of the earth on its axis and through space, it seemed possible that the velocity of a light wave would be different in the different directions.

They found no difference at all, although their apparatus could easily detect even smaller differences than was to be expected in the test. This remarkable experiment, the results of which underlie the modern theory of relativity, was carried out over comparatively short light paths. Now it is within the realm of possibility that two sets of radio stations might be used to repeat the test. Radio waves, we believe, are exactly the same as light waves except for wavelength. This experiment, using

light waves, could just as well be proved by radio. A pair of stations with east and west transmission, automatically controlled, as in the case mentioned above, could be compared with the transmission with a similar pair having north and south transmission (say New York-Warsaw pair and a New York-Argentine pair). There will be a certain difference in time required for transmission between the two pairs of stations due to the different distances, but this difference changes as the earth rotates, if the results of the Michelson-Morley test are not correct. If, therefore, two such pairs of stations, operating as "radio clocks" should be left running all day, and if it could be shown that one gained on the other with a periodically changing rate, as the earth revolved, our ideas on light phenomena would have to be materially revised. It is not improbable that this striking means of checking the time period of radio waves will soon be used to advantage.

### An Interesting Court Decision

MANY a radio enthusiast will at some time or other get an idea which has commercial value; if he is employed in the technical division of a radio manufacturing company, the decision recently handed down in the case of the Burgess Laboratories against the French Battery and Carbon Company will prove interesting. The decision is neither new nor novel, but it serves to bring up again a certain aspect of the patent problem which must interest all who have inventive minds.

One of the members of the Burgess Company, a man who did much of the technical development for the company, severed his business connection here and entered the French Battery and Carbon Company. Naturally he was of value to his new associates primarily because of the experience and knowledge he had gained while working

with the Burgess Company. He began to improve the products of his new employer, who was in competition with his old one, in the dry-battery market.

It appears that many of the improvements he soon incorporated in the products of the French Company were conceived while still under contract with the Burgess Company. If so, according to the decision of the Court, he has no right to use these ideas in improving the product of its rivals.

But how is one to tell when he first conceived an idea? And did he conceive it completely or only in part at this time? Whatever he conceived, in line with the general character of his work, while in the employ of a company, belongs to that company, and he is not free to use it for any one else. It is not necessary that the idea should have been shown workable, or "reduced to practice," as the patent law has it; if the mere conception of the idea can be shown by one's former employers to have been gained



*"And now, little Kiddies, what do you think Peter Rabbit answered?"*

(This was the eloquent cover of *Life* for November 1, 1923)



**"BY REQUEST" WJAZ GOT 4284 TELEGRAMS IN FOUR HOURS**

Left to right: Mr. C. H. Handerson, WJAX, Cleveland; Mr. Raymond Walker, Manager of Bureau of Music Release; Senator Frank W. Elliott, WOC, Davenport; Mr. Eugene McDonald, Jr., WJAZ, Chicago; Mr. Paul B. Klugh, Executive Chairman; Mr. William S. Hedges, WMAQ, Chicago; Mr. J. Elliott Jenkins, WDAP, Chicago; Mr. C. B. Cooper, Department of Commerce Radio Committee; Mr. John Shepard, III, WNAC, Boston; Mr. Powel Crosley, Jr., WLW, Cincinnati. Executives of the National Association of Broadcasters in their convention at the Hotel Commodore, New York, are examining the results of a test of the size of a listening audience at WJAZ. 4284 paid telegrams, averaging 75 cents each in cost were received in four hours. It is estimated that only one person in a hundred would be willing to spend this amount, and that therefore the number of listeners-in on that night may fairly be estimated at 400,000

while the inventor was working for them, the idea is theirs, not his.

Strange as this may seem at first, it is seen to be the only reasonable and just decision to make in cases of this kind. All of the company's secrets are opened for the instruction of their investigators—they pay him what is thought by them a reasonable salary in the hope and expectation that his brain will yield something worth more to them than the salary they have paid him while the idea was incubating. It is a kind of a bet they make on their experimenting staff; salaries are paid for years without anything of actual money value being turned out by the experimenter, but he is still employed in the hope that his direct, or indirect, contributions to the output of the factory will more than offset what he costs the company.

It is evident that if the court should rule otherwise than it did in this case, and as it always rules in such cases, it would be possible for an investigator to work for a company for a

year or two, learning all their secrets, drawing a salary, turning out nothing, and then, when a valuable idea came to him, sell his idea and services to a rival concern. Such would evidently be unfair procedure, and if it could be successfully carried out by technical workers, would do much to wreck the wonderful research organizations which many of our large companies have built up during the last decade.

In awarding a verdict for the Burgess Company the Court said: "The question here involved is not whether the invention was reduced to practice or whether it was merely an abandoned experiment, but whether it was 'made or conceived' during the life of Mr. Ruhoff's [the investigator whose transfer of association caused the suit to be brought] contract with the [Burgess] Laboratories, which contract was by its terms automatically continued in force until Mr. Ruhoff resigned to go with the French Company. If the con-



TWO FOOTBALL GAMES AT ONCE

Radio reports of the Yale-Princeton game being received at Hoboken, N. J. on the football field of Stevens Institute of Technology. R. W. Gast has the receivers on and T. J. Kauffeld is telling the stands how the Bulldog's fangs are sinking deeper in the neck of the Tiger

tract required that an invention should be actually or constructively reduced to practice in order to come within its terms, any laboratory worker could appropriate to himself the results of his discoveries while at the Laboratories by postponing the reduction to practice till he had severed his connection with the Laboratories."

#### Radio Replaces Flowers and Fruit at Hospital

**I**N THE old days, when we went to see a hospital patient, we brought him food, with the dull-witted notion that hospitals neglected the culinary niceties, and it was therefore our duty to smuggle in something that the sick person would enjoy. We knew he would enjoy it, because we were bringing him his favorite dish. We never could understand that smart nurse's edict that "he couldn't have it now."

Or we went to the florist's and tried to choose between roses tied with a ribbon and carnations gracefully arranged in a basket. And then we were often amazed to find that someone else had thought of the same thing, and perhaps, with more success.

To be sure, the thought is what counts,

and it should not be inferred from this that flowers and fruit and reading matter are not giving pleasure to thousands of hospital patients even while we are writing this. But when a patient is swamped with flowers, forbidden to eat delicacies brought in from the outside, and either unable or disinclined to read, the chances are he would like nothing better than just to lie back and listen to what's going on in the air, from a receiver which he can control with a turn of his wrist.

Ellis Hospital has seen radio so far merely as a diversion, one that is bulwark to the morale of the patient who has long hours alone. Under daylight saving, the program begins only a little while before visitors must leave, and they continue long enough to top off a day as giddily as it is ended at home. This hospital owns a portable tube set which is taken to any patient who expresses a desire to have it.

"I read the other day about a hospital in Philadelphia where radio can be turned on or off anywhere in the place at will," said the head nurse. "The whole building is equipped, and any patient who wishes to hear the programs is able to, while those who tire of it need not be annoyed. Maybe some day we'll have one like that."

J. H. M.

# The Factor That Limits Long-Distance Reception

Why the Most Sensitive and Selective Set Possible Cannot Hear Any Station Anywhere

By A. J. HAYNES

Vice-President, Haynes-Griffin Radio Service, Inc.

**W**ITH the advent of ultra-sensitive receiving sets, such as the tuned radio-frequency and super-heterodyne circuits, radio fans are coming up against a new proposition in the way of long-distance reception. The general feeling seems to be that long-distance reception can always be attained provided the set is sensitive enough—that is, has sufficient radio-frequency amplification ahead of the detector tube. And of course, looking at the theory of radio-frequency amplification in an off-hand way, this would seem to be the case.

A radio signal sent out from a transmitting station in the form of a wave has a diminishing progression, which, theoretically, will never reach absolute zero. In a way it is similar to the case of a man who starts to walk from New York to Boston, resting when he reaches half way. Then he starts on the remaining distance and rests when half of that is covered then he walks half the remaining distance again, and so on. Eventually, of course, he will reach Boston, but theoretically he will always have a remaining distance to go.

Accordingly, the weakest radio impulse sent out by a broadcasting station theoretically continues forever. But there is a practical limit to the distance at which this impulse may be picked up. Just what this limiting factor is has been given little thought and certainly is not understood by the average broadcast listener. In his mind, the only limiting factor is, his receiving set. Increase the sensitiveness of the receiver and you increase your receiving range—that is the generally accepted theory. It sounds reasonable, doesn't it? Pick up any newspaper radio edition and you will see that the hunt is still on for the ultimate reversed, ingrowing circuit that will permit

the user to tune-in San Francisco or Seattle, at will, from New York.

THE MAN WHO WANTED EVERYTHING . . .

**R**ECENTLY, there was brought to my attention an incident which, if it were not for its pathetic side, would be extremely humorous. A well-to-do man living in New York City came to the conclusion that he wanted a radio installation. He couldn't use any ordinary form of antenna, or at least he refused to do so, but wanted a loop set of standard manufacture—the finest to be had. One of the best makes of receiving sets was



put in, and the installation man was expressly instructed to stay with the owner that evening to show him how to operate the set, and if possible to pick up some distant stations, although the set was located in a house in the heart of New York City. By a stroke of rare good fortune it so happened that he had a particularly fine location for loop reception. When the set was completely installed, the buyer started asking the installation man to bring in various stations, starting with Pittsburgh, Boston and then Chicago. Much to the operator's own surprise he complied with each of these requests in turn, and was highly elated at his phenomenal success. Then, following Chicago, came the blow.

"Now, get me Los Angeles," said the purchaser of the set.

The operator looked up with a smile on his face, taking the request as a joke. But the man was in earnest, and because Los Angeles could not be brought in at that minute, he ordered the set taken out and said that he was "through with this radio business," and "hoped that some day they would get it perfected."

This may be an extreme case, but it indicates how unreasonable we often are and how

little the basic theories of radio are known to the general public.

. . . AND WHY HE COULDN'T GET IT

**B**UT to get back to the subject in hand—why couldn't the operator get Los Angeles? Why can't you always increase the distance by increasing the sensitiveness of your set? The fact is, there is a limit. It can't be done.

To explain this clearly, let us consider a form of receiving set such as the super-heterodyne which can be arranged to provide an unlimited amount of radio-frequency amplification. What is there to prevent, for instance, the carrying of this amplification as far as we wish? If the radio wave, even from the weakest transmitter, actually does go on and on, why can't we merely add radio frequency and receive farther and farther? The answer is simple, and depends upon a single factor of fundamental importance to radio reception—*static*.

#### THE "STATIC LEVEL"

**N**OW, static is, as we are accustomed to think of it, a crashing sound in the receivers resembling thunder crashes during an electrical storm. It is extremely bad in the summer time and practically absent in winter. However, under this heading of static can be classed, for the sake of convenience, all types of radio-frequency noises: local interference from induction, elevator clicks, buzzes, etc. In the winter, on a seemingly perfect night for radio reception, when, perhaps, not a particle of electrical disturbance can be heard in the ordinary regenerative set, still there is static present, as will be readily learned if one starts to experiment with sensitive receivers. *It is the quantity of this radio-frequency noise that exists which is the limiting factor in our distance reception.* In other words, no matter how low the "static level" drops, if we amplify sufficiently we can bring it back to a roaring series of crashes and clicks in the phones. And unless the signal which it is desired to receive is present with greater intensity than the static, it cannot be heard.

It is an impressive sight to look out over a body of still water and see a submarine sink slowly below the level of a smooth sea. This is the finest analogy to a radio wave and the static level that I know of. The signal goes on and on, always diminishing in value until it reaches the point where it sinks below the

surface of the static level; and, as in the case of the submarine, which cannot be seen below the surface of the water, no matter how powerful the field glasses employed, so will a radio signal disappear below the static level and be lost to the listener no matter how sensitive the receiver. This could well be called the threshold value of the transmitting station's wave. "Threshold value," a term used in physics, indicates (as applied to a radio signal) the critical value above which the signal is audible and below which it disappears.

There is always an infinite amount of small electrical disturbance present in a city. Its intensity depends upon conditions and locations in which receiving work is done. In some locations this static interference is so bad that it makes long-distance work out of the question, regardless of the type of set used. Naturally, the man who buys the finest receiving set obtainable expects the finest kind of reception, and it is sometimes hard to explain to him that he cannot get results in spite of the apparatus he uses. Without knowing the cause of the trouble, he immediately puts the blame on the equipment and the dealer's judgment, or capabilities. I know of many in-

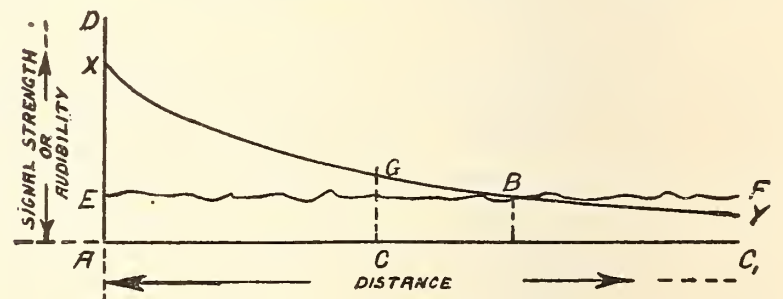

FIG. 1

The distance from the Pacific to the Atlantic Coast is represented by the line AC. XY indicates the strength of a broadcast signal sent from the Pacific Coast. It can be heard in New York (C), with sensitive enough apparatus, because, at that point its strength is still greater than the static strength. But at B (somewhere out on the Atlantic Ocean), the strength of static and signal are equal

stances where radio enthusiasts who are trying to solve this static problem have spent hundreds of dollars shifting from set to set. They vainly hope to find a "good set," as they would call it, when, as a matter of fact, it is their receiving conditions, not the sets, that are fundamentally wrong.

#### "DEAD SPOTS"

**A**NOTHER problem frequently encountered is that of "dead spots." It is an undeniable fact that there are many places, not only in the city (although the complaints

generally come from cities), but even in what seemingly are ideal receiving locations, in a country community, where signals are not always received with good volume. And perhaps some fairly close station that should be received well comes in weakly or is not heard at all. In the latter case, however, provided the radio-frequency noises are not bad, a sensitive receiver will bring up these near-by stations, in spite of "dead spots." On the other hand, the ratio of radio noise—or static, as we are calling it—to signal strength is increased in such a locality so the possibilities for doing good long-distance work are decreased in the same proportion.

These dead spots can be attributed to numerous causes. In a city, it often happens that the receiving location is surrounded by a good many steel structures. It may be that some of these steel structures have a natural frequency corresponding to some particular wavelength. If this is so, any station of this wavelength is difficult to receive, because the main energy of the wave is absorbed before it reaches the receiving stations. In a way, this situation is similar to that brought about by stepping behind a big tree while out in a strong wind. The tree absorbs the force of the wind while you, behind it, receive little or none of its energy.

Again, a receiving installation will sometimes receive short wavelengths admirably, but cannot receive long wavelengths satisfactorily, or vice versa. This trouble is also invariably blamed upon the dealer or the type of set used. But here again the cause is usually due to one range of wavelengths being absorbed more than another, a situation brought about by surrounding conditions.

#### RECEPTION UNDER VARIOUS CONDITIONS OF STATIC AND SIGNAL STRENGTH

HOWEVER, the large part played by the ratio of signal to static, in our distance reception, is the main point I wish to emphasize.

Let us suppose again the case of a set with unlimited powers of radio-frequency amplification. Suppose this set is located in New York City, and while in the course of operation on a certain night, a Pacific Coast station is picked up and brought in beautifully. No noise, no interference, nothing but clean-cut speech and music. On the following night, perhaps, the same set is tuned-in on the same

station when they are on their usual schedule; but with the same adjustments and same amount of amplification being used, nothing is heard. Then the operator starts increasing his radio-frequency amplification. He continues this until the set is amplifying to the point where the static level on that particular night is brought up to audibility. He begins to hear clicks, buzzes and bangs in his re-

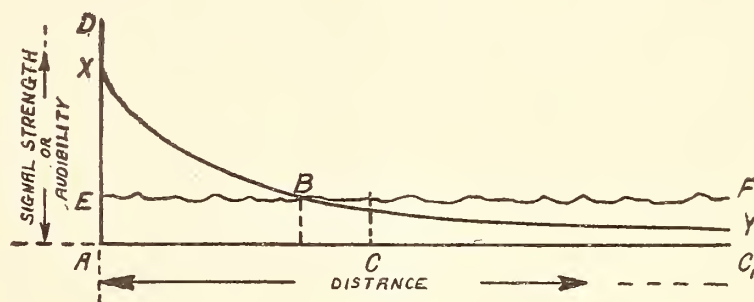

FIG. 2

Here, the static level is the same as in Fig. 1. But the broadcast signal is weakened in its passage eastward, due to conditions between the Pacific (A), and the Atlantic (C) Coasts, with the result that it sinks below the static level before reaching New York (C) and no receiver now known can receive it

ceivers—and still no signal. Why? The signal was there the night before and could be brought out clearly with less amplification than he is now using. And to-night, every additional step simply increases the roar in his phones. If the signal is being brought in, it is so weak in comparison to the noise that it cannot be heard.

The answer is just this: for some reason, somewhere between Los Angeles and New York, certain prevailing conditions weaken the wave sent out by this particular station to a greater degree than the night before. Its energy has fallen off more quickly, and by the time it has reached this particular location in New York it has dropped below the level of radio-frequency noise and cannot be brought above it again by any ordinary methods.

This can well be illustrated by the diagram, Fig. 1. Let the two points, A and C, represent the Pacific Coast and New York, respectively, with the intervening distance, indicated by the line between them. Let the height above the line AC, measured along the line AD, represent signal strength or audibility. The irregular line, EF represents the static level that existed on the first night of reception. The line XY represents the radio signal that is sent out from the Pacific Coast as it travels toward the East. It will be seen that the farther it goes in the easterly direction, the

more it falls off and approaches the line AC, but as this is the decreasing progression that carries on to infinity, it will never actually reach the line AC, but at some point such as B, east of New York City, it is bound to run under the static level, EF. In this particular case any receiver in New York that is capable of giving sufficient amplification to reproduce a signal of intensity CG will be able to bring in this station. At this point the signal audibility is well above that of the static level and can be reproduced without interference from this source.

Now let us turn to Fig. 2. Here the same conditions prevail, with one exception—the signal-static ratio is changed. It can be seen that we have two variables here, both of which lie between fairly wide limits—that is, the actual signal strength itself represented as the distance of the line XY above the line AC and the strength of the static level EF (which is shown at the same height above AC in both Fig. 1 and Fig. 2, indicating it to be the same strength on these two nights). However, in Fig. 2, the line XY is seen to pass under the line EF before it reaches New York. In other words, due to poor conditions prevailing between the points A and C, the radio signal is not carrying as well the second night as it did the first, falling off more rapidly. And after it has passed beyond the point B,

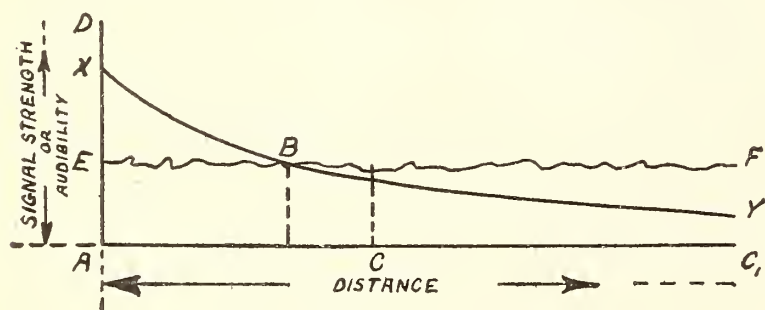

FIG. 3

On this night, the signal which reaches New York is represented as of the same intensity as in Fig. 1. The static is worse, and there is "nothing doing" on West Coast signals

where it reaches the static level, it is lost, as far as radio reception, as we know it, is concerned.

There is another case that might be considered: the signal strength on these two succeeding nights might have remained the same, or varied only slightly, while the static level itself changed. This condition is illustrated in Fig. 3, where the signal strength represented by XY is identical with that indicated in Fig. 1, but the signal-static ratio or the line EF, is higher. If this were the case on the second night, the operator would never have attempted

to increase his radio-frequency amplification, because when he turned his set on with the same adjustments as he had on the first night, i. e., would immediately get a terrific roaring in his phones that would force him to decrease his amplification; and even though the signal itself was present with as great intensity as on the preceding night, the static would be "in" with still greater volume. And when he decreased his amplification to the point where the noise had diminished sufficiently to listen-in, there would not be enough amplification to bring in the signal.

Now, if you follow this thought closely you may ask: What is the use of a sensitive receiving set? What, for instance, can be done with a good super-heterodyne that cannot be done with any other receiver?

This can also be illustrated most simply with the diagram, Fig. 4.

Supposing the same lines, AC and AD, to represent distance and signal strength respectively, and supposing the same signal to be sent from the Pacific Coast, let us see what happens with different types of receivers, and how it is possible to receive farther on one type than another. Suppose, further, that the signal submerges beneath the static level at point B, some indefinite point between the Pacific and Atlantic Coasts. Now let us consider three types of sets: first, the ordinary crystal set; second, the regenerative receiver, and lastly, a super-heterodyne with unlimited powers of amplification (the latter, for instance, being capable of bringing any radio-frequency noise that is above the line AC, into audibility). The amplification power of the regenerative set may be indicated by the dash line GH—that is, it is capable of receiving any radio-frequency impulse whose strength is represented by the distance AG above the line AC, and lastly, the crystal receiver whose power of reception is represented by the dash line IK, and which will receive any radio-frequency impulse whose strength is greater than the distance of the line IK above AC.

In this diagram we are supposing a good average winter night with the static level, EF, very low. In fact, it is well below the limit of amplification of a good regenerative receiver as indicated by its distance below GH. In other words, no static disturbance or noise will be heard on either the crystal or the regenerative receiver.

The signal starts from the Pacific Coast from



point X. (While, of course, it travels out from this point in all directions we are only considering its easterly bearing.) At first, it falls off very quickly and passes below the line IK at M. This means that the distance IM is as far as the signal can be heard at this particular time, on a crystal receiver. It may be ten miles. It may be fifty. The signal continues on at point N, where it falls below the line GH, which represents the amplification limit of the regenerative receiver. This station then, may be received at this particular time with a regenerative receiver at any point between G and N. Now, it may be seen that this signal travels still a great distance before it reaches the point B, where it passes below the static level and is lost to any form of receiver. And here is where the more sensitive set gets in its work; for the set that is capable of giving sufficient amplification to get down below the static level at this particular time, can receive that radio signal anywhere over the distance up to the point B, which in this case we are supposing is practically twice as far as the regenerative receiver will go. Here is a real gain, and it is made possible by one thing only—the low static level of the static interference represented by the line EF. If this line EF were as high as, or higher than, the line GH (as would be the case on almost any summer night), the regenerative receiver would be able to receive over just as great a distance as

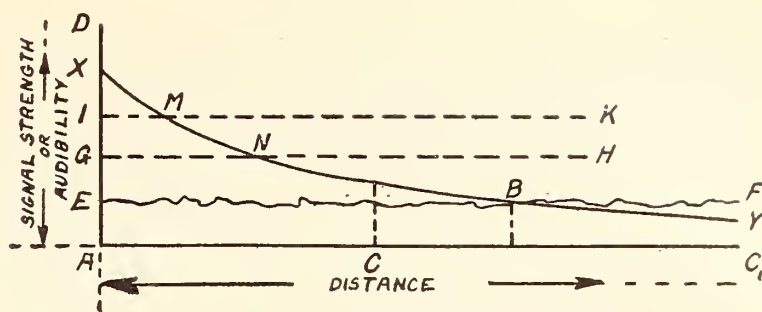

FIG. 4

A crystal set can receive San Francisco's signal at IM distance from the transmitting station, a regenerative set at GN distance, and a super-heterodyne at any distance up to point B

the receiver with unlimited powers of amplification. Therefore, the factor which limits the range of a radio receiver is not only its sensitiveness but the signal-static ratio.

I do not mean to say that this condition will never be overcome. There are already systems of radio telephone broadcasting (such as single side-band transmission), which will improve the signal-static ratio; but with the radio reception and broadcasting we have to-day, this condition certainly does apply and is the fundamental factor that limits our long-distance reception. If the radio fan can realize this, he will no longer complain when on a bad night he can do no better with his neutrodyne or even super-heterodyne than he can do with his old regenerative set. He will realize that, on that particular night, either the signal strength itself has fallen or the static level has risen.

# The Choice of a Receiving Tube

Some Useful Data on Radiotron and Cunningham Tubes

By B. S. HAVENS

General Electric Company

**T**HE choice of a tube to use for a particular purpose depends in general upon three main considerations:

1. The purpose for which the set is to be used:
  - a. Broadcast listening for the enjoyment of entertainment programs.
  - b. Experimentation on apparatus and circuits.
  - c. Long-distance code reception.
2. The type of set in which the tube is to be used; that is, the electrical circuits involved, number of tubes used, and whether a loud speaker is included in the equipment.

3. Whether storage batteries, No. 6 dry cells, or flashlight dry cells are to be used for filament operation.

## THE UV-199 AND C-299

**T**HESE tubes require a minimum of filament energy. In fact they use only .18 of a watt, or about one eightieth the power consumed by a 40-watt electric lamp.

The bulb is of small size, and a special base and socket suitable for such a small tube are used. On account of the small size of this tube, the capacity between electrodes is lower than in either of the other tubes, but when it is

used in a standard socket the capacity of the adapter employed added to the capacity of the tube makes it practicable without changing the circuit. This tube is particularly suited for portable sets in which it is necessary or desirable to use ordinary dry cells, or flashlight cells for filament operation.

The small electrical capacity between the electrodes makes it a very satisfactory tube for radio-frequency amplification. This tube does not require critical adjustment of plate voltage, and tapped plate batteries are not necessary, whether the tube is used as a detector or as an amplifier.

#### THE UV-200 AND C-300

THESE tubes are particularly desirable for the skilled radio experimenter interested in code work and reception over great distances. They are not suitable for dry-cell operation because the filament requires one ampere at five volts.

Their action as a detector is very critical with respect to filament voltage and plate voltage, and is not as uniform between different tubes of the same type or as constant in any one tube as in the case of the high-vacuum tubes (UV-199, C-299, UV-201-A, and C-301-A).

They are very sensitive to weak signals, especially spark and modulated CW signals, when skillfully handled by experienced operators in a circuit particularly equipped for the proper voltage operation of filament and plate.

They are not recommended for audio- or radio-frequency amplification and should never be used with a plate voltage greater than that obtainable from a 22½-volt B battery at full voltage.

These tubes require a little patience and skill in adjustment for the reception of weak signals. Under certain conditions they have a tendency to be slightly more noisy in operation than either of the high-vacuum tubes which are practically free from such disturbances.

#### UV-201-A AND C-301-A

THESE tubes are powerful amplifiers, inherently better than the UV-199, and are particularly suitable for loud-speaker operation.

They are designed to give the best possible amplification for general use, their amplification property not being sacrificed to any extent to give a minimum of filament energy.

The operation of these tubes is almost free

from variations caused by slight changes in plate and filament voltage. Accordingly, they are quiet in operation and have a longer operating life than any of the tubes mentioned above.

They are equipped with a standard base and thus fit in many sets already constructed, unless they have been made especially for UV-199's, C-299's, or WD-11's.

The filaments require a much greater amount of electrical energy for their operation than does the UV-199 or C-299, but the UV-201-A and C-301-A tubes can be operated from dry cells in the case of one or two tubes used only a few hours per day at a lower expense than with the use of a storage battery.

As an audio-frequency amplifier, these tubes are somewhat superior to the UV-199 or C-299.

As a detector, the UV-201-A or C-301-A are about the same in response as the UV-199 or C-299 and are to be recommended over the UV-200 for most general purposes, except in equipment specifically designed for the latter tube as regards potentiometer adjustment for plate voltage and very fine adjustment for filament voltage.

The UV-201-A and C-301-A are ideal for a one-tube set employing dry cells or a multi-tube set when a storage battery is available for filament operation.

Critical adjustment of filament and plate voltages are not required and it is not necessary to have taps on the plate batteries.

Although the capacity between the electrodes of the UV-201-A and C-301-A are somewhat greater than the UV-199 and C-299, their greater inherent amplification makes them just as satisfactory in most radio-frequency amplifier circuits.

When used for audio-frequency amplification, a negative grid bias or C battery should be used [see page 80, RADIO BROADCAST for Nov., 1923], the C battery voltage depending upon the plate voltage employed. The following table gives the correct value of C battery with different plate voltages:

PLATE VOLTAGES	C BATTERY VOLTAGE
40	0.5 to 1.0
60	1.0 to 3.0
80	3.0 to 4.5
100	4.5 to 6.0
120	6.0 to 9.0 (not to be used with UV-199's or C-299's.)



# From Binding Post to Varnish

By HOWARD S. PYLE

**U**P IN the cold, lonely timberlands of the north—down in the warm, tropical countries—on hundreds of ships on the seven seas, myriad tiny voices of the night bring cheer and comfort and entertainment to eager listeners. And all through proper manipulation of a few simple controls on a small wooden cabinet. It is an accomplishment to inspire awe, and we have a respect for the little cabinet that forms a medium of contact with the world about us. So faithfully and efficiently does the little mystery box serve us, that many do not stop to wonder how and where and by whom the delicate apparatus was assembled and arranged within.

The writer recently made an investigation of the manufacture of modern broadcast receiving equipment, concluding his search with a trip through one of the largest and most modern factories of the independent radio manufacturers.

The entire plant had been laid out after the policy followed by the Ford Motor Company: the raw materials are routed through a definite

manufacturing cycle. As each part is completed, it is delayed at an operating station until the arrival of the next part required in the receiver assembly. By this method as a panel progresses through the factory, various completed parts are added until the panel reaches the testing department with a completed set attached to it.

The first photograph shows the individual units being made up. The girl at the extreme right is operating an automatic screw assembling machine—a combination power-driven screw driver and socket wrench. To the left, other operators are seen with automatic rheostat winding machines. A large proportion of the special machinery found to be imperative in accurate work, has been developed within the plant.

Following the completion of the various parts, they are delivered to the assembly department, to be incorporated in the receivers at the proper stations during their progress along the assembly tables.

In the photograph on page 290 we see the first stages in the construction of a four-tube re-



HERE THE PARTS ARE MADE UP

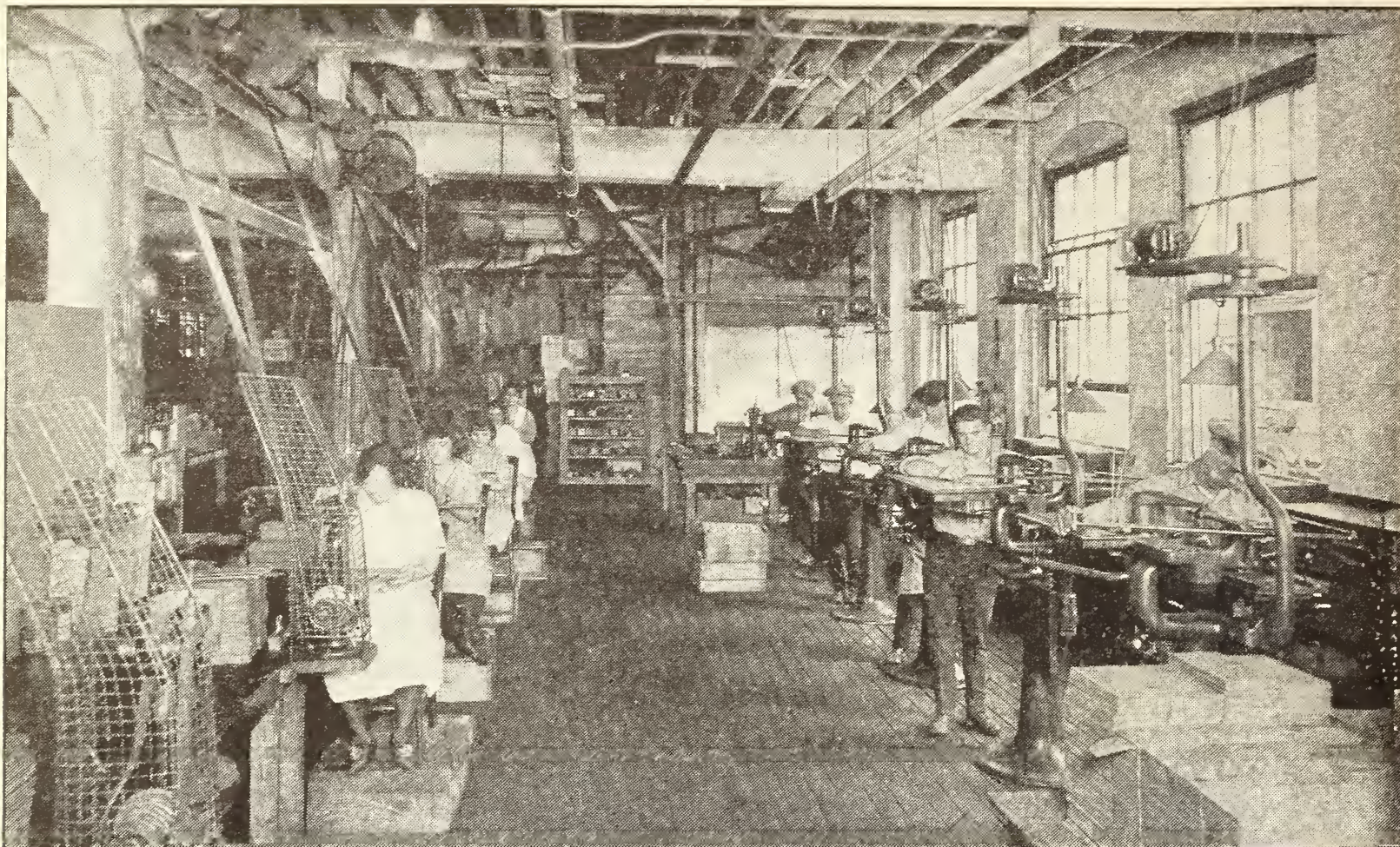

ENGRAVING AND FINISHING PANELS FOR FOUR-TUBE RECEIVERS

ceiver—an extremely popular product of this particular manufacturer. In the operations pictured, the panels appearing in the lower right-hand corner are machined to the desired dimensions, sanded, and then subjected to a finishing operation which completely removes the gloss and gives the panels a pleasing, flat, grained finish. They are then passed through a gang of drills, each operator drilling but one size hole, thus eliminating change of drills and lessening the possibility of error. The next step is through the engraving machines. A battery of five are seen behind the blank panels in the foreground. Here the work is also divided, so that one machine operator engraves only a small amount of “copy.” Thus each man becomes expert in engraving some particular character such as a trade-mark or a group of letters or figures.

The panel is then ready for the assembly department. One row of long tables permits the progressive passage of the panel through the various stages of assembly. A separate row permits an uninterrupted line of receivers of five different types to be constantly in production. One worker, for instance, secures the filament rheostat and the two audio-frequency transformers in place, the next places on the binding posts, and so the work progresses down

the line until all of the parts are assembled on the panel.

Next in order is the wiring, or “hooking-up.” It has been found desirable to limit the number of wires placed by any one operator. Hence we find one worker caring for but two or three wires, the instrument then passing to the next station where two or three more are placed. This procedure enables each operator to work rapidly without sacrificing accuracy. In a plant where the bonus system is in vogue, this division of labor works to the advantage of both employee and manufacturer.

When a number of instruments are completely wired they are passed to the testing department on “wagon-racks.” Several of these wagon-racks are shown at the right in the upper picture on the opposite page.

Passing along the right-hand row of tables, each instrument is subjected to an inspection for possible loose connections and given a thorough brushing and cleansing of all soldered joints with benzine and alcohol. This serves to eliminate leakage paths which might be caused by excessive soldering flux.

The instrument is then delivered to the radio-frequency test tables. Two small, continuous-wave oscillators installed in this department furnish energy for testing receiving



HERE THE RECEIVERS ARE INSPECTED AND TRIED OUT

sets on actual radio-frequency signals. One oscillator is adjusted to a wavelength of 200 meters and modulated at a frequency of 1000 cycles. The second oscillator is adjusted to 600 and modulated at 100 cycles. These testing oscillators are arranged on a loop, and the energy is transmitted to the series of loops

shown in the photograph. A receiver must function at both wavelengths before passing the testing department.

It has been found practically impossible to locate faults in radio-frequency apparatus unless actual radio-frequency currents are applied to the instruments under operating

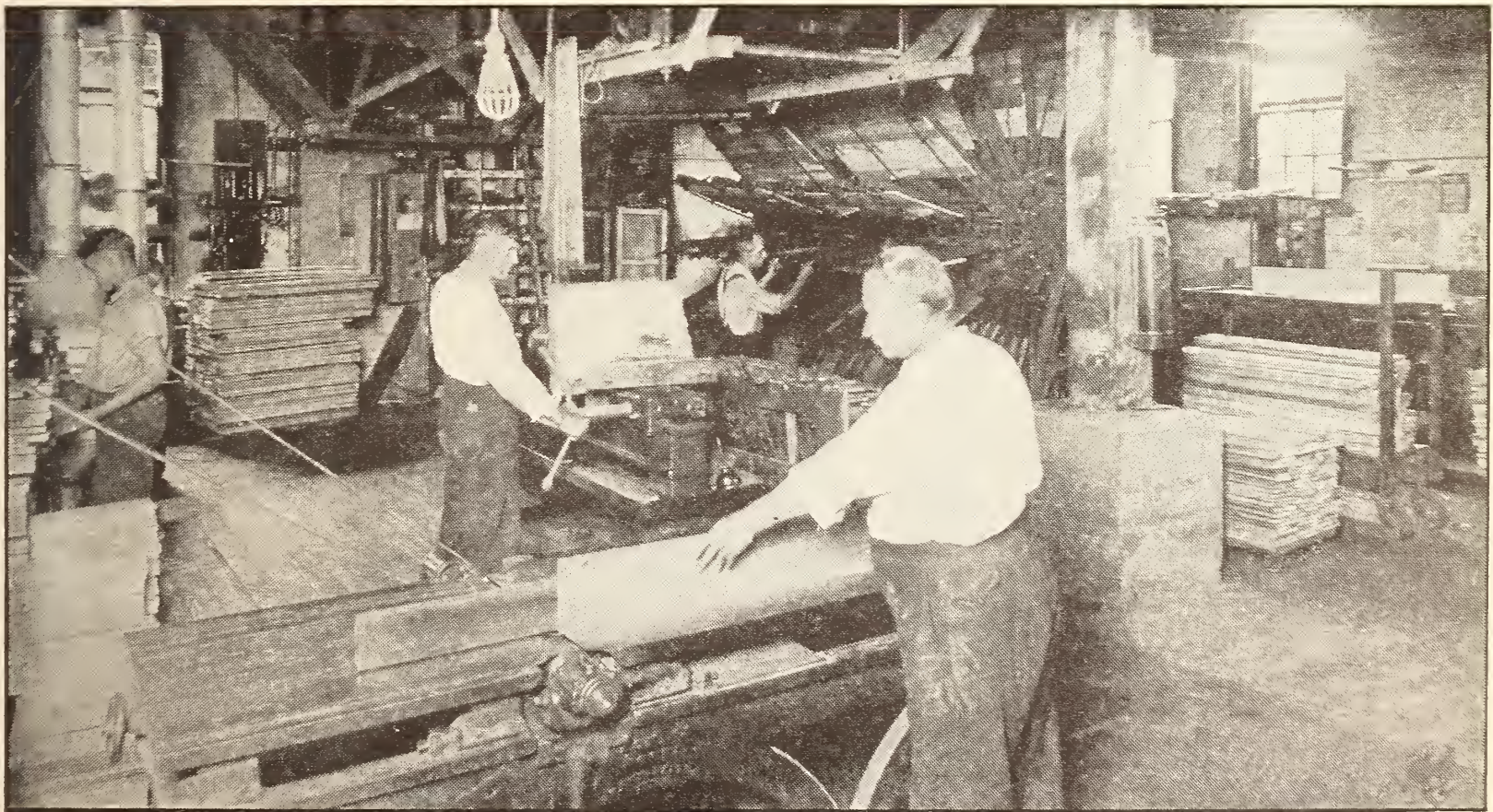

CABINETS IN THE EARLY STAGES OF CONSTRUCTION

conditions. In other words, receivers which have satisfactorily passed a mechanical and electrical test, are often inoperative when connected to an antenna system. The testing system just described enables a really satisfactory test to be made, the loop antenna design being such as to represent the electrical characteristics of the average antenna erected to receive broadcasting.

A receiver satisfactorily passing all tests is finally routed to the table at the rear of the testing department where the necessary instructions are placed in the cabinet and the serial number entered on the cards. The set is then packed for shipment.

In order that all of the parts entering into the final assembly may be manufactured in the one plant described, a wood-working department is maintained, which is among the largest and most modern in this country. Here the cabinets and other wood work used in the manufacture of radio equipment are turned out, with a considerable surplus for outside distribution. An example of the modern machinery in use throughout the entire organization is seen in the "sticking-machine"—the paddle-wheel-like machine shown in the lower picture on the previous page. This has

replaced the old method of setting up long lines of cabinet work held together by means of "gluing-clamps."

A cabinet, upon leaving the wood-working plant, goes to the spraying department where the finish is sprayed on the cabinet instead of being applied by hand with a brush.

Completing the equipment of this manufacturing plant is an up-to-date printing establishment in which are published all catalogues, instruction sheets, and circular matter, as well as a weekly newspaper.

From the foregoing, it can readily be seen that radio as an industry has assumed a definite place in the business world. Conditions, so chaotic two years ago, have so shaped and stabilized themselves that an establishment such as the one described, representing an investment of many thousands of dollars and employing hundreds of workers, is recognized as a sound and substantial industry. The fly-by-night manufacturers of a year or two ago are now practically extinct. Good workmanship, correct policies, and a desire to give the public dollar for dollar value, have narrowed the great new field of radio manufacturing down to a comparatively few progressive manufacturers.

HERE THE FINISH IS SPRAYED ON

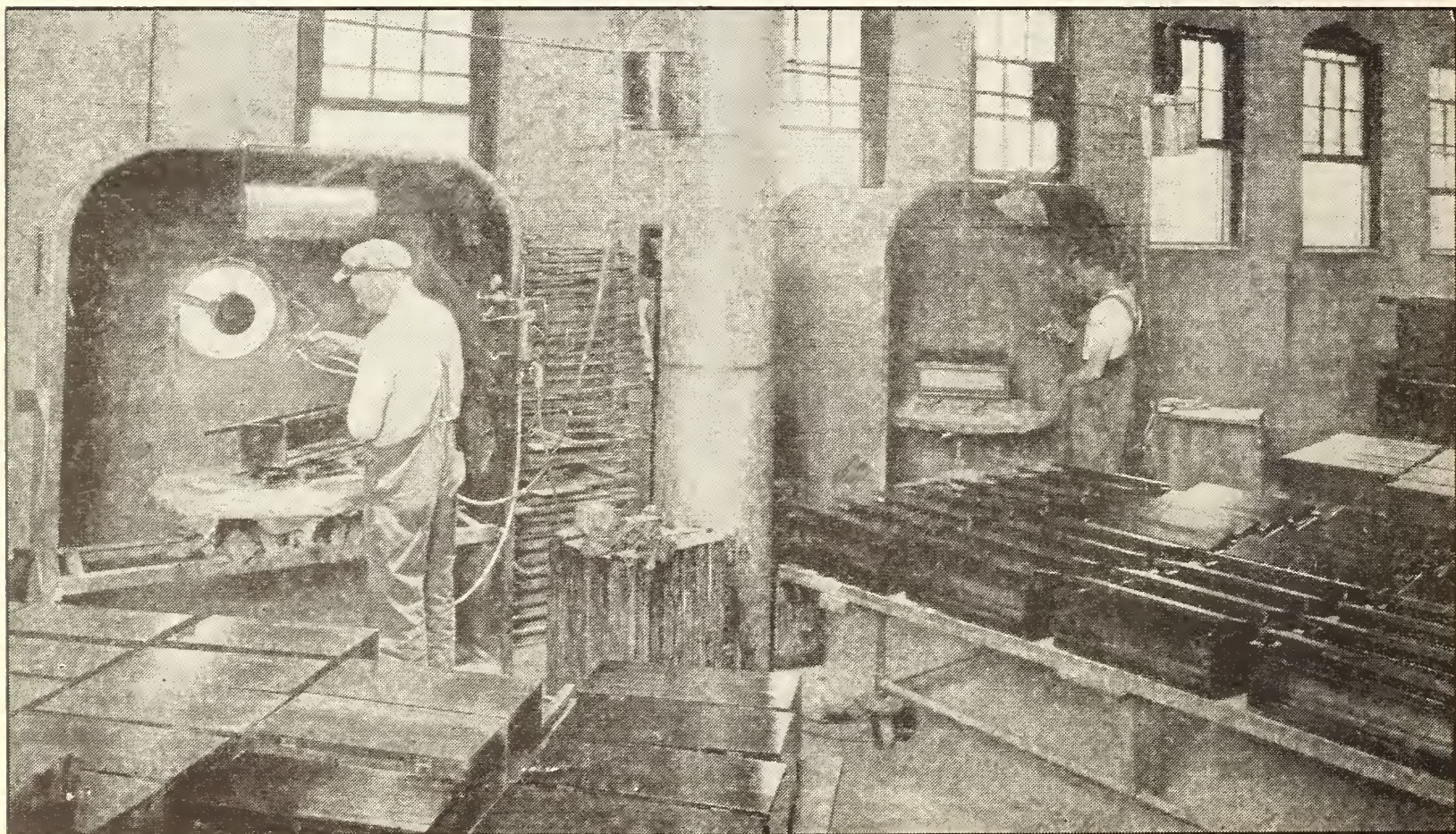

# Is the Amateur at Fault?

By CARL DREHER

I HOPE the spirit of this article will not be taken as one of "A plague on both your houses"—the houses referred to being not those of Capulet and Montague, but those of the broadcast listener and the telegraph amateur. I grew up as a radio telegraph amateur, myself, and it is now my fortune to cater, professionally, to the broadcast listener. I am in a position, I believe, to know both factions and to view their differences with an impartial eye. Neither party is without faults; or, to be accurate, each class contains individuals who have more radio faults than a regenerative set has squeals. A frank analysis of these members of the groups will, I feel, be in the interest of the radio art as a whole.

When seventeen years ago I listened, wonder-stricken, to my first wireless signals, the art was at a sort of scientific frontier. Like other pioneers, we suffered somewhat from loneliness and hardships, self-inflicted, to be sure, but none the less poignant. Signals were few and we were ignorant as to the proper procedure to follow in receiving those few, so that an amateur would sometimes listen for weeks without hearing anything. Yet he would listen for hours every day, holding his breath a good part of the time, in the hope of hearing a few dots and dashes. When a silicon crystal jarred out of adjustment in the middle of a message the owner would be plunged into despair, for he was not likely to get it into adjustment again that night. When he hit a sensitive spot in his explorations there was no signal on the air nineteen chances out of twenty; and when someone was sending it was a fair bet that the sensitive area would be passed over, for the crystal was apt to be about as good as a piece of anthracite. Some of the boys did use coal, as a matter of fact. Long before this time, even, experimenters were

using an electrophorus to make a spark in one room of a house, and listening on a telephone receiver connected across an autocoherer, consisting of a needle laid across two pencil leads, in another room; and that was radio.

It had one salient advantage—every one did what he pleased without bothering any one else. The frontier, in other words. My friendly indictment of the present telegraph amateurs is that some of them seem to think that they are still in that state.

## THE BOY THAT SITS ON THE KEY

FOR example, I happen to live in New York City, near three or four amateurs with C. W. transmitters. My business makes it necessary for me to listen-in on broadcasting

wavelengths, almost all evening and practically every evening. I have a wave-trap to take care of these amateurs; still, as they are very near me, enough stuff gets through to interfere with reception, sometimes even to limit out the broadcasting stations in my receiver. (The transmitters are fed on AC, I may remark, quite imperfectly filtered, and with prominent key thumps). Anyway, between 8:00 and 10:30 in the evening these transmitters are supposed to be off the air. Sure enough, they are not used for signaling during these intervals, but not infrequently one of the boys holds down his key for a minute, presumably to test radiation, and then stops without signing. A natural enough procedure—my friend gets an idea for squeezing another eighth of an ampere out of his set, and of course he has to try it right away. Why wait until 10:30? In 1906, or 1912, or even in 1920, there would have been no harm at all. But to-day our careless friend interferes with twenty or thirty broadcast listeners in the surrounding apartment houses when he touches his key at this time. Instead of music, they get a loud 60-

The author makes a plea for tolerance and common sense in the relations of amateur and "B C L" toward one another. In this article, he takes the radio amateur to task for the interference he sometimes creates with his spark or continuous-wave transmitter; but the severity of his criticism is tempered with constructive suggestions and with a sympathetic understanding of the amateur's point of view. Next month, Mr. Dreher will put the broadcast listener on the carpet.—THE EDITOR.

cycle hum which is music only to the ears of a telegraph amateur. And the broadcast listeners have no recourse at all. The operator is careful not to sign his call letters, so it is impossible, even for a listener who knows the code, to make a definite log entry and complain to the U. S. Supervisor of Radio in the district.

For the time being, the amateur seems to be getting away with it. But what will happen in the long run? The broadcast listener is only too prone to ascribe to the amateur interference for which the amateur is in no way responsible as well as that for which he is responsible. As a practical proposition, therefore, it behooves the amateur to have the broadcast listener interfered with as little as possible. If he himself causes such interference gratuitously, he is helping to accumulate a weight of resentment and irritation which, in time, may be exceedingly dangerous to the amateur's interests. Public feeling gathers its forces slowly, but they are very great once they get started, and occasions have been known where it was hard to stop them at a reasonable point.

The amateurs have their privileges, and, like other people, act as if they will always have them. But these are not inalienable rights. The idea of further restrictions in transmitting seems preposterous to many present-day amateurs. But the idea of having to confine themselves to a particular wavelength, and taking out a license, and emitting a sharp wave, seemed preposterous to some of the amateurs of 1912. I well remember the indignation of one old fellow who snorted indignantly at the idea that he could no longer talk back to the commercial stations and send as he pleased—which was on 800 meters with a spark gap in the aerial, a kilowatt or so of power, and a wave as broad as the ocean. Even after the "W" calls had been assigned and the new law was in full effect, the amateurs had, for a time, much greater liberty than at present, and I well remember hearing Doctor Hudson sending a deadhead to the National Electric Signaling Company's station at Bush Terminal, asking Mr. Hogan to look for his pipe, which he had left at the station on a visit. At that time this procedure was quite in order. Those days are past. They were picturesque, but picturesqueness is a poor argument for survival.

#### WHY THE AMATEUR SHOULD "WATCH HIS STEP"

I AM speaking specifically of the urban amateurs. Out on the farms the situation is much less acute. But in the cities the ether simply cannot carry all the traffic imposed on it, taking into account that broadcast receivers must be built to be handled by laymen not engineers, and that within a few hundred feet of an antenna radiating an ampere or two, eliminating the signal from such an antenna is a more or less dubious proposition.



There is one Procrustean way of doing it, and that is to eliminate the amateur. This proposal is in fact made, and in no very subdued tones. Personally, I am warmly against it. I doubt, also, if it can be done. But there is no reason to be certain and cocksure. No organization is so great that it can

throw aside prudence and give no thought to the morrow.

If the amateur is wise, he will read the handwriting on the wall, adjust himself quietly to new conditions and superior forces, save what he can—which is considerable—and so keep a reasonably prominent place in the radio game. He has one fine argument on his side—the demonstrable fact that the amateur telegraphers are the best source of material for army and navy radio men in time of war. This argument, if not pushed to absurd lengths, will sustain the amateurs perfectly well. If it is used to prove that amateurs should be allowed to do what they please with the air at all hours in time of peace, it will suffer the same fate as the syllogism to the effect that since skill with firearms is a virtue in time of war, gangsters should be allowed to kill all the bank-messengers they please for practice. The comparison is overdrawn, but it makes the point clear.

As for justice, one should not rely on it too much. The son of the present Secretary of Commerce is a prominent and competent amateur, and as long as Mr. Hoover is in the Cabinet the amateurs are assured of justice. But Mr. Hoover will not be secretary forever, nor even for a decade. The next secretary may be a broadcast listener. In fact, he is twenty times as apt to be a broadcast listener as a code man. And at some time, thunderous key thumps or raw AC on the plates or forty-eight CQ's in a row or a spark set next door



may have prejudiced him against the amateurs. This prejudice may easily be shared by a majority of the Congress. What then? Justice is a very relative and elastic term, and one is too apt to get it after one is dead.

#### SUGGESTIONS FOR REDUCING TELEGRAPH INTERFERENCE

IF THESE points are conceded, specific suggestions for reform are in order. Without going into the matter exhaustively, we may enumerate four, as follows:

1. Use of artificial antennas for testing.
2. Technical restrictions on C. W. as well as spark sets.
3. Establishment of a reduced-power rule for local communication.
4. Reforms in calling and traffic handling.

The carelessness, amounting almost to profligacy, of the American code amateur is illustrated by this single observation—it is next to impossible to find one who owns, or who has ever owned, an artificial antenna, which permits testing a transmitter without radiating. Instead, practically all amateur testing is done on the air. If I had a tenspot for every time one amateur has asked another, "How is my spark?" or, "How do you like this note?" I should be in a position to pay the German debt, and have enough left over to relieve me from the necessity of following radio for a living. Let us concede that many receiving sets are not all they should be, that their owners are inexpert in the operations of tuning, that the amateurs are blamed for much interference of which they are innocent—conceding all this, why should an experimenter be allowed to use the air for endless tests? The air should be used for communication.

Most tests can be performed privately. An artificial aerial and a receiving set will tell Brother Jones that his new chopper gives a note like a rasp in difficulties with a piece of battleship steel, without an inquiry dispatched to Brother Smith across the city. The same remark applies to Brother Brown's telephone set, which transmits a band of frequencies from 400 to 1000, so that Brown could not understand himself talk if he did not know what he wanted to say. Brown should not attempt to talk to Smith with this set; he should have Smith come to his home and listen to it on an artificial antenna, just as he would, in simple charity, keep the windows

closed while he was learning to play the oboe. If the air were reserved for communication; and if only such tests as actually require a distant listener, or a wavelength setting on a particular aerial, were permitted on a radiating antenna, and if this rule were applied to amateurs as it is applied to commercial stations, an immense gain in freedom from interference could be realized.

#### C. W. TRANSMITTERS NOT ABOVE REPROACH

UNDER the second head, it is in order to question the current belief that C. W. transmitters do not cause interference. This is true only relatively in any case, and for direct-current plate feed, and when the radiation is unmodulated, and, finally, when "key transients" are suppressed. At present there are regulations covering the emission of a pure and sharp wave from commercial stations, but these are not enforced in the case of amateurs, because in the earlier state of the art, as long as the amateurs stayed down around 200 meters they were not apt to interfere with commercial traffic, and the radio inspection service had all it could do to regulate marine radio. Since the advent of broadcasting, conditions have changed, so that it is only a matter of time when amateur as well as commercial stations will be subjected to technical regulations. The paramount consideration, now as before, is the protection of life and property at sea. Broadcasting has added a secondary but important consideration—the elimination of interference on broadcasting wavelengths. This will involve restrictions on amateur tube transmitters, as well as on spark sets, and, just as the commercial interests were able to agree on fair and practicable standards for spark transmitters in 1912, it will, before long, be in order for the amateurs, and the other interests involved, to agree on proper technical standards for amateur transmitting sets, in common with other sending stations. The prevalent notion that an amateur has done his whole duty when he has put in a tube transmitter and does not exceed the upper wavelength limit for his class, and stays off the air between 8.00 and 10.30, will not, I believe, stand the test of time.



My final criticism, calling for reforms in calling and traffic handling, applies to a great many amateurs—to a majority, I think—

but in fairness it should be stated that an appreciable number of amateurs handle their keys as well as commercial operators; they are, in fact, distinguished from the latter only by the fact that they receive no pay for their work. I am a great admirer of virtuosity in traffic dispatching, and am glad to pay my compliments to these men. For every good operator among the amateurs there are, however, ten bad ones. The percentage may be the same among commercial operators, but the latter are at least restricted in the degree of badness they can reach, by the certainty of getting fired by the company, or having their licenses revoked by the Department of Commerce. An amateur, on the other hand, is free to send a string of CQ's as long as a Beverage aerial, to prolong a

conversation interminably, and to send the code with such misspacing and mangling of the characters that reading his traffic is simply guesswork. The recent introduction of an amateur extra-grade license may do something to improve conditions, but personally I feel that the issuance of transmitting licenses should be limited to applicants who can pass the first class commercial requirements, and who have acquired a decent "fist" in sending. The good men in the ranks would not be affected by such a ruling; most of them have such licenses already, or can get them whenever they like. As for the others, let them prepare themselves, or do without; that is the rule everywhere. This proposal, incidentally, has been put forward by leading amateurs.

## Charles Proteus Steinmetz

By J. H. MORECROFT

**F**EW radio listeners have any idea of the contributions Charles Proteus Steinmetz made to their hobby; his name was practically never mentioned in connection with radio, and it was probably unknown to the greater part of the multitude which nightly tunes-in the broadcast programs. His death had no particular significance for them. But every trained radio engineer realizes that radio is only a small branch of the electrical engineering profession, and that it is only the engineers well schooled in general alternating current theory who will get far ahead. The large companies, by whom most of the future radio development will necessarily be carried out, seldom care whether or not an applicant for their engineering staff has had radio experience, but they always want to know the extent of his training in general physics and electrical theory. This idea cannot be too strongly emphasized by those who are occupied in guiding boys who expect to enter the engineering profession; the fundamental electrical actions must be thoroughly mastered before great progress can be made in any special branch of engineering such as radio.

Having in mind, then, that the ultimate progress of radio cannot depend upon the relative merits of one circuit compared with another, or high vacuum tubes versus sodium tubes as detectors, but that it is rather based

on those broad principles which guide the undertakings of all our large electrical industries, then in the death of Steinmetz we can well say radio has lost one of its most resourceful contributors.

Steinmetz' contributions to theory and development in the field of general alternating-current electrical engineering stand out more prominently than those of any other single man. To many Americans, Edison serves as the most prominent expounder of the electrical science, but this is only because some of his achievements, notably the early electric generators and the incandescent lamp, come more closely into contact with the everyday life of the general public than do the achievements of Steinmetz. In the record of the proceedings of the American Institute of Electrical Engineers, for instance, no engineer has to his credit more important work than has Steinmetz. Much of the material he wrote will always remain inaccessible to the general radio public; alternating-current theory, even in its simpler phases, is not easy, and Steinmetz was generally busy with only the more complicated aspects of it. He could, however, and did often get down to the level of the embryo engineer and talk interestingly and instructively on the elements of his science.

His progress and attainments in our country must often serve as an inspiration to other immigrants. Landing at Castle Garden as a

penniless youth he soon found the niche where his thorough training in mathematics and electrical theory would serve him best. After entering the employ of the General Electric Company his advancement was sure and rapid. Alternating-current theory was then being developed; many of the simplest phenomena seemed baffling to even the best engineers, so that a man of the vision and ability of Steinmetz simply had to forge ahead to the position which he held for more than twenty years. Only ten years after this crippled, penniless youth passed through the immigrant gates at Ellis Island he was elected President of the American Institute of Electrical Engineers, the greatest honor his fellow engineers could confer on him.

In spite of the great physical disability, which must have proved a continual burden to him, he showed tremendous push and perseverance; his mind was ever keen to grapple with the new problems continually presenting themselves to the scientific worker, and what his mind was applied to, it generally mastered. Only a few days before his death one of our mathematical colleagues was commenting on Steinmetz's treatment of Einstein's relativity theory, as presented in a published series of semi-popular lectures. "You know," he said, "Steinmetz actually understood the stuff and he puts his ideas in such terse language that even a layman almost understands what Einstein was trying to say." We have often heard him get up to discuss a paper on some technical topic, presented by one of his fellow engineers, and many times we learned more from Steinmetz's discussion of the paper than we did from the paper itself.

In spite of his wonderful mastery of his chosen field he retained an unusual degree of modesty, and an openness of mind which made him ever willing to listen to the other side of the question. Typical of his dry humor was an incident at an engineering meeting, where in excited discussion was being waged regard-

ing the feasibility of a certain type of machine—could such a machine work, was the question. After listening to the pros and cons by several engineers, Steinmetz got the floor, and after assuming the characteristic pose we all knew so well, expressed his admiration of the logic of those engineers who said the machine couldn't possibly work. "I myself," said he, "proved conclusively some time ago that such a machine was against all reasonable theory and couldn't possibly work. But since then," he added, with a dry expression on his face, "I've unfortunately seen it work." That, of course, ended the discussion.



THE LATE CHARLES PROTEUS STEINMETZ

A fellow engineer, one who had worked with Steinmetz and knew the abilities and eccentricities of this electrical genius by intimate association and sympathetic understanding, pays a splendid tribute to him in the *Cornell Daily Sun*. Says Prof. Vladimir Karapetoff: "It was impossible to make him do anything except what he himself desired to do. He

stayed away from the works for days; he smoked in buildings in which the President himself did not dare to smoke; he used clockwise rotation of vectors when everybody was using the opposite rotation; he insisted on saying "ze" for "the"; he wore a soft shirt and shabby gray suit at formal functions; and he belonged to a political party which cursed his company and its principal customers for years.

"Modest, thoughtful, a prodigious worker, always ready to discuss an electrical problem on equal terms with any cub engineer, he was the very impersonation of the principle of losing one's self so as to find it again in bigger things. His contribution to our welfare and knowledge is beyond measure or computation and his life is a shining example of a quiet, straight, and unswerving path amidst the turmoil of conflicting passions, avarice, extravagance, cure-alls, pseudo-science, pseudo-patriotism, pseudo-life itself. And yet, with all, his life is also a glowing tribute to this

great, broad-minded country of ours which early recognized his genius, took him lovingly in her arms, and carried him steadily to the pinnacle of his fame."

As we recollect the many talks by Steinmetz which it was our good fortune to hear, it seems that his life and work assuredly bore out the thesis which President Nicholas Murray Butler of Columbia University recently submitted to a group of engineering students, to whom he was giving an informal talk. Although he

was "not an engineer and didn't pretend to understand the great problems which engineers undertake," yet his observations, those of a layman, had convinced him "that only those engineers really succeed and accomplish things who have imagination." Steinmetz was gifted with a wonderful imagination, and the products of this imagination he brought to concrete and useful forms by the workings of his well trained mind. Furthermore, he could really think—an activity in which few of us seriously indulge.

## How the C Battery Prevents Distortion

Your Amplifier Need Not Distort Signals If You Know  
How to Apply the Proper C Battery Voltage to the Grid

By JOHN F. RIDER

**T**RANSFORMER-coupled audio-frequency amplification is almost as old as the three-element vacuum tube, yet its refinements are just appearing before the public. Before broadcasting became popular, when spark and CW signals dominated the ether, distortion in an audio-frequency amplifier was a rare complaint. The character of the signal did not require distortionless amplification. Very little attention was paid to the design of amplifiers, if the desired amount of volume amplification was obtained. Since broadcasting came in, the requirements for audio-frequency amplifiers have been much more exacting.

To-day, amplifiers are required which shall increase the intensity of the signal, yet retain all the fine variations of the voice impulse, so that the music emitted from the loud speaker is an exact reproduction of that picked up by the microphone in the studio. Even if the transmission is perfect, entirely without distortion, and if the detection is perfect, nevertheless the signal is distorted after passing through a two-stage amplifier. What has caused the distortion?

Fig. 1 is a schematic diagram of a standard two-stage audio-frequency amplifier. One can readily see that there are only two parts of the amplifier which can cause distortion: the coupling transformers and the vacuum tubes. In which of these two does the trouble lie? Extensive experiments have been made and are continually being made by the manufacturers of audio-frequency transformers, in an endeavor to produce a transformer that operates perfectly on all frequencies encountered in the broadcasting of voice and music. Their experiments have proved successful, and transformers that function admirably in that respect are now on the market. Therefore, let us also assume that the transformers in the amplifier have been matched for the tubes and are perfect. The entire unit operates excellently on weak signals, but the distortion persists when strong signals are being amplified. So, by the process of elimination, we have arrived at the vacuum tube as the source of our troubles.

*The C battery eliminates distortion, increases the life of the B battery, and makes the audio amplifier more economical to operate.*

We find by experience that, by reducing the brilliancy of the filament, we can minimize the distortion to a certain degree, but this method is unsatisfactory, as it results in a decrease of signal intensity.

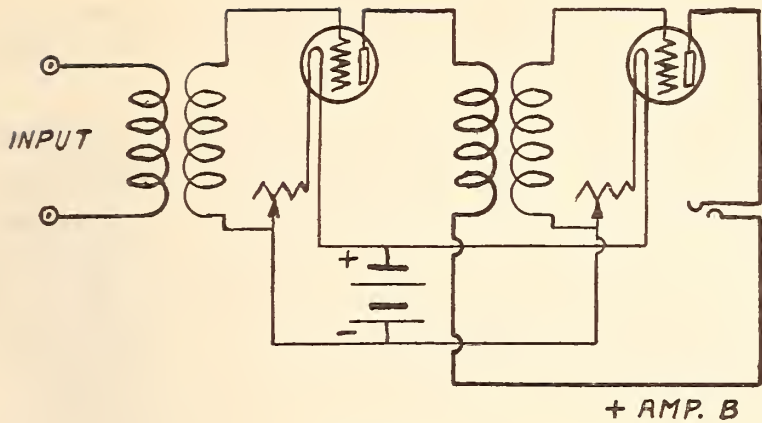

FIG. 1

Two-stage audio amplifier. If the transformers are of reliable make and matched for the tubes, any distortion must occur in the tube circuit

Therefore, we will focus attention upon the vacuum tube and see what part it plays in the amplifier. Also what other apparatus, if any, must be added to the amplifier so that the vacuum tube will operate with maximum efficiency, eliminate distortion, and still afford maximum amplification.

What is the three-element vacuum tube as used in our present-day amplifiers? It is an instrument consisting of an evacuated bulb, containing a filament that can be made incandescent so as to emit electrons; a grid, and another metallic object called the plate. Further, it is a voltage-operated device, which, when an alternating potential is impressed upon the grid, will produce the same alternations in the current flowing in the plate circuit but of greater amplitude. Now the question might arise in the mind of the reader: How can distortion occur in a vacuum tube if the alternations impressed upon the grid are reproduced in the plate circuit? This can best be explained by means of a plate-current, grid-voltage characteristic curve (Fig. 2). Before going into the explanation of the curve, a few remarks concerning the plate current might help the uninitiated.

Experiments have determined that when a filament is contained in an evacuated chamber and made incandescent, it will emit electrons at a certain rate per second, the rate depending upon the degree of incandescence. Also, that when another metallic object in the form of a plate is placed into that chamber and given a positive charge in respect to the filament (the positive terminal of the B battery is always connected to the plate), the electrons will be attracted to the plate, and a stream of electrons will flow from the filament to the plate. Now if we place a meter that will indicate the flow

and quantity of any current in the plate circuit, we will find that when there is a flow of electrons within the tube (from filament to plate), there is a certain value of current flowing in the plate circuit. So we can say that the electronic flow is equal to a current flow within the tube. And we find that by varying the brilliancy of the filament (thus varying the number of electrons that are emitted from the filament per second), we can vary the plate current; also, that we can vary the plate current by varying the value of the voltage applied to the plate, for the greater the positive charge on the plate, the greater its attracting power, and a greater number of electrons are attracted to the plate. The plate current corresponds to the number of electrons reaching the plate per second. If we maintain the filament current constant and the plate voltage is also maintained at a constant value, there will be a definite number of electrons flowing across inside the tube, and the plate current will be constant. This value of the plate current is usually expressed as the amount of current the tube draws. When the plate voltage is held constant and the filament current varied from minimum to maximum, there will be a variation in the plate current from minimum to maximum. The maximum indicates that the positive charge on the plate has attracted all the electrons possible, and any increase in filament current in order to increase the number of electrons emitted will be of no use. When this stage is reached, we have reached the saturation point of the tube, i.e. for that plate voltage.

Now let us go back to the characteristic curve of the tube. We are to illustrate how distortion may occur within the vacuum tube, and we shall also show how it can be eliminated. The curve illustrates the operation of a three-

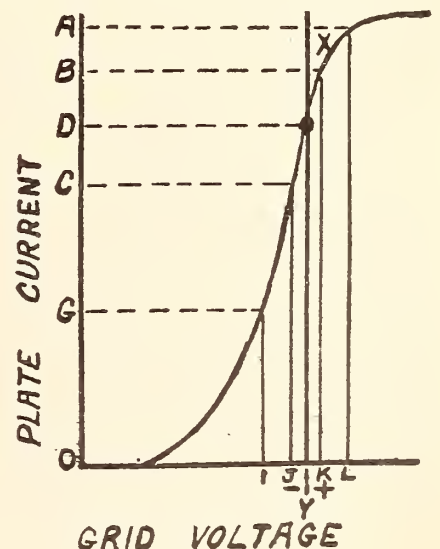

FIG. 2

Showing the relationship between the current and the grid voltage when the plate voltage and filament current are held constant

element vacuum tube as an amplifier, by showing the relationship between the plate current and the grid voltage, when the plate voltage and the filament current are held constant. The vertical line on the extreme left indicates the value of plate current (usually expressed in milliamperes); the horizontal line, on the bottom, the grid voltage; the vertical line in the center, the zero line, i.e., the dividing line between negative and positive grid voltage. To the right of this line is positive grid voltage and to the left, negative. The curve shows the variation of the plate current, and the bend X is the saturation point. Assume that the curve illustrates the characteristics of a UV-201-A as an amplifier with a plate voltage of  $67\frac{1}{2}$  volts. The dot on the curve and point D on the left-hand line indicates the normal plate current as explained in the preceding paragraph. Now suppose that an incoming signal of a medium intensity has been impressed upon the grid. The applied potential being of alternating character, an alternating positive and negative charge is therefore applied to the grid. This is shown by YJ as the negative charge and YK as the positive charge. By following up the vertical lines at these points and noting where they cross the plate current curve then following the horizontal line at that point toward the left vertical line, we see the value of the plate current in each case. The negative charge upon the grid has reduced the plate current a certain value below normal, and the positive charge upon the grid has increased the plate current the same value above normal. This phenomenon occurs because when there is a negative charge upon the grid it repels some of the electrons emitted from the filament and less travel to the plate, hence the plate current is reduced; the opposite is true when the grid is charged positively. The grid attracts electrons and a greater number travel to the plate, increasing the plate current. Expressing this differently, we can say that when the grid carries a positive charge it increases the attracting power of the plate. By glancing once more at the curve it will be noted that the increase and decrease in the plate current are exactly proportional to the grid potential variations, but are of greater magnitude; so the wave-

*Do you know just how your tube works? What difference does it make if you apply more B battery, or more filament voltage? Mr. Rider answers these questions in this article.*

form in the plate circuit will be exactly the same as those in the grid, and no distortion will take place in this case.

Let us now assume that the signal has passed through one stage of amplification, or that the original input has been greatly increased. What happens when a stronger signal is applied to the grid? Since the signal is of greater intensity on being amplified, the alternating potential that is impressed upon the grid is greater. This is indicated by YI and YL, the former the negative charge and the latter the positive. We follow the various lines through once more, and note that the negative half of the applied grid potential has produced the plate current variation DG, and the positive half the variation DA, but that the two variations are not equal and

therefore are not exactly proportional to the grid potential variations. The reduction in the plate current for the negative charge on the grid is greater than the increase for the positive charge, and the increase has been carried beyond the saturation point. Since the variations in the plate current are not exactly equal, the wave-form in the plate circuit is not an exact reproduction of that applied to the grid. The effect of this is distortion. Thus distortion is produced within the vacuum tube in amplifying circuits.

What is the remedy for this situation? To reduce the grid voltage would reduce the amplification. That would never do, for maximum amplification is generally desirable; therefore, we must reduce the normal plate current to such a point that equal increase and decrease will be produced in it by the grid voltage variations. Expressed differently, the operating point (normal plate current) must be shifted to such a position that the plate current variations will be equal at all times, and this point is midway between the two bends. We can do this by two direct methods:

1. By reducing the filament brilliancy, thus reducing the electronic emission.
2. By reducing the plate voltage, thus reducing the attracting power of the plate.

Neither method is completely desirable, for in each case we would not obtain maximum amplification. We shall have to resort to an indirect method of shifting the operating point

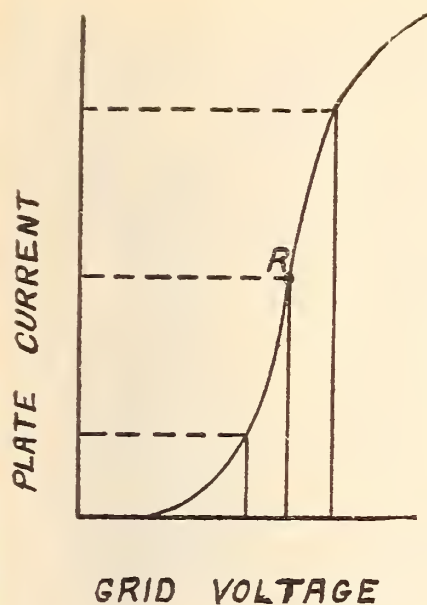

FIG. 3  
Showing the "characteristic curve" when C battery (grid bias) is used

of the tube. We shall utilize the grid, we can either increase or decrease the plate current. As we want to reduce the normal plate current to a certain point, we place a constant negative charge upon the grid. This calls for the insertion of a source from which we can obtain this negative charge.

The most logical source would be a battery, and that is the means employed in actual practice. This battery is called the C battery, and is sometimes known as the "grid bias." The battery is connected as shown in Fig. 4, and we apply just enough negative potential to the grid to reduce the normal plate current to the point where changes in the grid potential due to the incoming signal, will produce equal increases and decreases in the plate current. Therefore, by means of the C battery, we can confine ourselves to operation on the straight portion of the characteristic curve, and place the operating point midway between the two bends. In this way, the symmetry of the oscillations applied to the grid are faithfully reproduced in the plate current, the variations are proportional, and distortion is eliminated. Further, the greatest amount of variation is obtained in the plate current for the grid potential variation, and maximum amplification is also obtained. This is shown in Fig. 3. The operating point, R, has been reduced, and for the same value of input the greatest variation is obtained and the variations are proportional.

Fig. 4 is the same as Fig. 1, except for the C battery between the grid return lead of the transformer and the negative terminal of the A battery. That point is the proper position for the battery, and not between the grid of the tube and the grid terminal of the transformer.

The patent rights for the use of a C battery in an amplifier are owned by certain radio concerns, and because of their refusal to grant other manufacturers this right, separate C batteries are not found in the average amplifying unit. There is no ruling that forbids the radio fan to insert such a battery in his own amplifier. To overcome this patent situation, other methods of obtaining a negative grid bias are resorted to by the manufacturers. One is to connect the grid return of the transformer to the negative terminal of the A battery, and another to place the filament rheostat into the negative lead of the A battery and connect the grid return of the transformer to a part of the rheostat, so as to apply the voltage drop across the rheostat to the grid of the tube. These methods are limited in their degree of efficiency, since the required value of "grid bias" might be more than that obtainable by the above means. The value of the C battery is best determined by experiment, as it depends upon the controlling constants of the tube. The following table offers a close approximation to the C battery voltages to be used with a given plate voltage.

PLATE VOLTAGES	C BATTERY VOLTAGE
40	0.5 to 1.0
60	1.0 to 3.0
80	3.0 to 4.5
100	4.5 to 6.0
120	6.0 to 9.0 (not to be used with UV-199's or C-299's)

The C battery:

1. Eliminates distortion.
2. Reduces the normal plate current, thus increasing the life of the B battery and making the amplifier more economical to operate. This is illustrated by the following experiments:

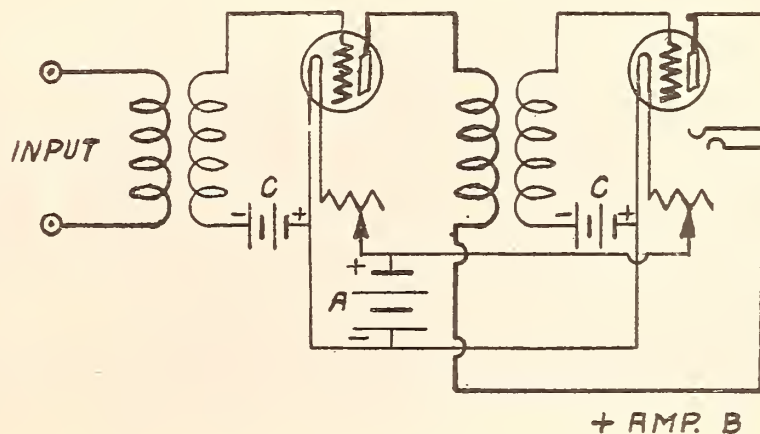
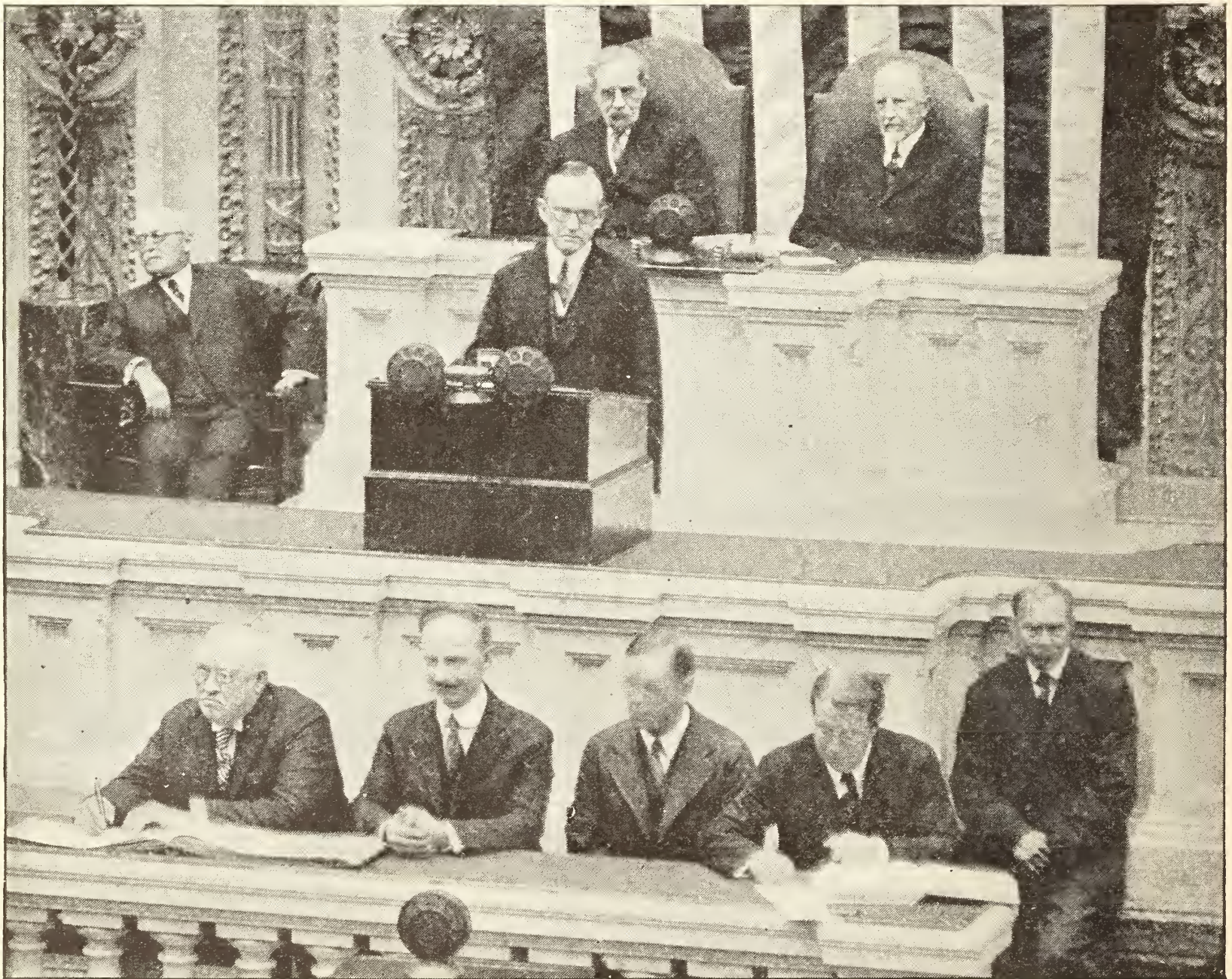

FIG. 4  
Showing how the C battery is connected in an audio-frequency amplifier

A receiver consisting of a regenerative detector and two stages of audio-frequency amplification, as in Fig. 1, was put into operation. The amplifying tubes were VT-2's and drew approximately 1.2 amperes on the filament. A potential of about 150 volts was applied to the plate. The signal strength on local stations was tremendous, but the music was distorted. A milliammeter was placed into the plate circuit, and with above filament current and plate voltage, the two tubes drew approximately 32 milliamperes normal current. To minimize distortion, the filament current was reduced until the music sounded best (i. e., till amplification was best), yet the tubes drew 22 milliamperes. (It can be readily seen that with this amount of current being drawn from the B batteries, they cannot last very long. That is the case with many amplifiers in use to-day. The operators are told to increase

the plate voltage if they desire greater signal strength. That is true, but the other constants must also be in proportion, if efficient operation is desired.) Now the filament current was brought back to normal—1.2 amperes—and C batteries were added as in Fig. 4, until maximum intensity was obtained without any trace of distortion. With the C batteries in, greater signal intensity was obtained than previously, due to the fact that we were operating on the straight part of the characteristic curve, and full plate-current variations were obtained. When in this state, the reading on the milliammeter was noted, and it was only 5 milliamperes for both tubes. The increase in the life of the B battery is readily apparent.

A great deal of the distortion that is attributed to the loud speaker may be taking place within the second stage of the amplifier. Who can tell?



PRESIDENT COOLIDGE READING HIS ANNUAL MESSAGE TO CONGRESS

The two microphones on his reading desk actuated six broadcasting stations. Behind the President are Senator Cummings, President *pro tem* of the Senate, and Speaker Gillette, presiding



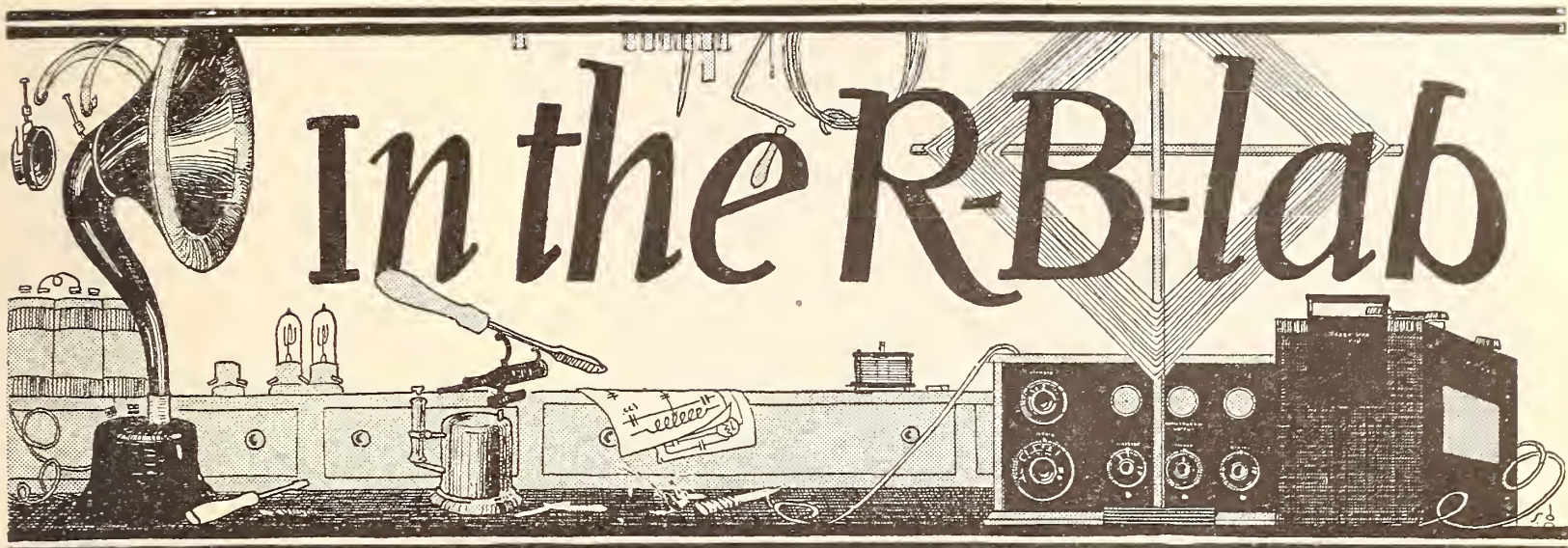

The "lab" department has been inaugurated by RADIO BROADCAST in order that its readers may benefit from the many experiments which are necessarily carried on by the makers of this magazine in their endeavor to publish only "fact articles" backed by their personal observations.

## THE LATEST REPORTS ON THE GRIMES CIRCUIT

**I**T IS doubtful if any other circuit made public in recent months has received so enthusiastic a welcome by the broadcast fan as the Grimes Inverse Duplex. The difficulties encountered in making this circuit function as it should, have not daunted the experimenter, and every mail received by RADIO BROADCAST contains new evidence of his unflagging interest in the circuit.

The Grimes circuit is a queer one. It is a puzzle, and deserves all the light that experimentation can throw upon it. Our readers who have experimented with this set, in either the three bulb or four bulb form, are divided sharply into two factions—those who claim it is the best circuit in the world, capable of the most remarkable results, and those who cuss it caustically as a set that will howl, squeal and do everything but receive signals.

However, the circuit *will* work, and we are going to let our successful readers give a few pointers on how it is done—including, here and there, a few words of our own.

### A FOUR-TUBE SET

**F**IGS. 1 and 2 show the four-tube set constructed by Mr. Martin A. Zeiger in his endeavor to duplicate the installation of Mr. Shalkhauser, the winner of Second Prize in RADIO BROADCAST's last "How Far Have You Heard" contest. The corrected circuit for Mr. Shalkhauser's set was published on page 142 in the December number, while other details will be found in the September issue.

These photographs of Mr. Zeiger's set are particularly interesting in that they show very clearly an accepted way of placing the parts, mounting, etc. Fig. 2 is also illustrative of the care and neatness in wiring which so often determines whether or not a receiver will work.

In order to make Mr. Zeiger's apparatus function, it was necessary to add two small fixed condensers (.001 mfd.) across the secondaries of the audio transformers nearest to the detector, as was recommended last month in reference to the corrected diagram. The selection of tubes was found to be eccentric, to say the least, and an indiscriminate juggling of a half dozen UV-201-A's was necessary before results were at all satisfactory. Filament control was such as to necessitate separate rheostats on each tube, *no two tubes being burned at the same brilliancy*.

The tendency towards self-oscillation in a reflex set (its predominant fault) is in a direct ratio to the number of tubes, or, more correctly,



FIG. 1

A compact four-tube Grimes set. Potentiometer, condenser and four rheostats are the only controls

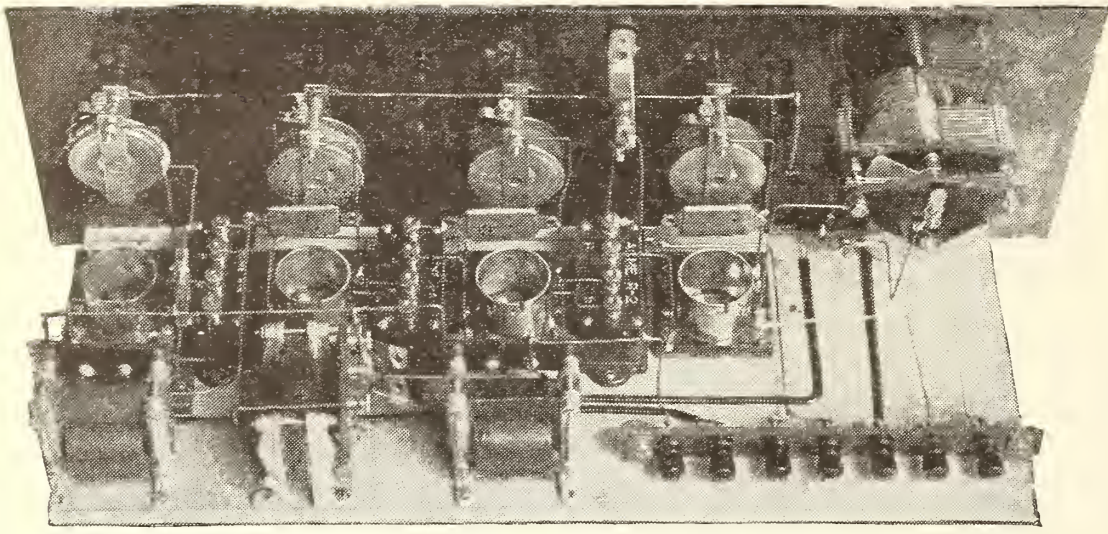

FIG. 2

The Interior of Mr. Zieger's set. Note the rear connections, the neat wiring, and the placing of the transformers

to the number of reflexed stages. That this is so was demonstrated quite conclusively in Mr. Zeiger's set, which was much more unstable than a three-tube set recently brought to the attention of this department. The various adjustments of tubes, rheostats, etc., mentioned above, were necessary in order to stop self-oscillations, which adjustments, however, caused the tubes to be operated in such a manner that they neither detected nor amplified to the best of their ability.

For this reason, we advise our readers not to attempt the building of a four-tube set duplexing all amplifying tubes, unless he possesses infinite patience and experimenting facilities—and luck! Our advice is: Build a four-tube set (or rebuild your present one if you are having difficulty with it), but rather than reflex through three tubes, reflex through only two of them, employing one stage of straight audio amplification. Such a set would use the standard three-bulb Grimes circuit as shown in the April, 1923, number of RADIO BROADCAST\*, with a single stage of audio, added according to the directions given in the amplification article appearing in the July issue. The four bulbs would then be, two reflex, detector and one

\* Back numbers of the magazine may be had from the publishers at twenty-five cents each.

straight audio. This set will be much more stable than the average four-tube, all reflex set. It will probably give even louder signals than the full reflex set working at its best, for one step of straight audio amplification is always superior to a stage of reflexed audio, and the third step of R. F. is rarely of much advantage.

A PORTABLE SET FOR AN OPEN ANTENNA

FIGS. 3 and 4 show interesting views of the three-bulb set made by Mr. Leonard H. Searing, in which, for the greater part, he followed the circuit shown in the April, 1923, RADIO BROADCAST. His main variation from the original diagram is the use of a variocoupler which permits the set to be operated from an open antenna rather than on a loop. The primary of the variocoupler is in the aerial circuit with a variable condenser in series with the ground lead. The secondary is connected in place of the loop—a simple and self-evident change.

However, a loop may be used with Mr. Searing's set, and in order to facilitate the change from open antenna to coil antenna (loop), a standard double-circuit jack has been placed across the secondary of the variocoupler (be-

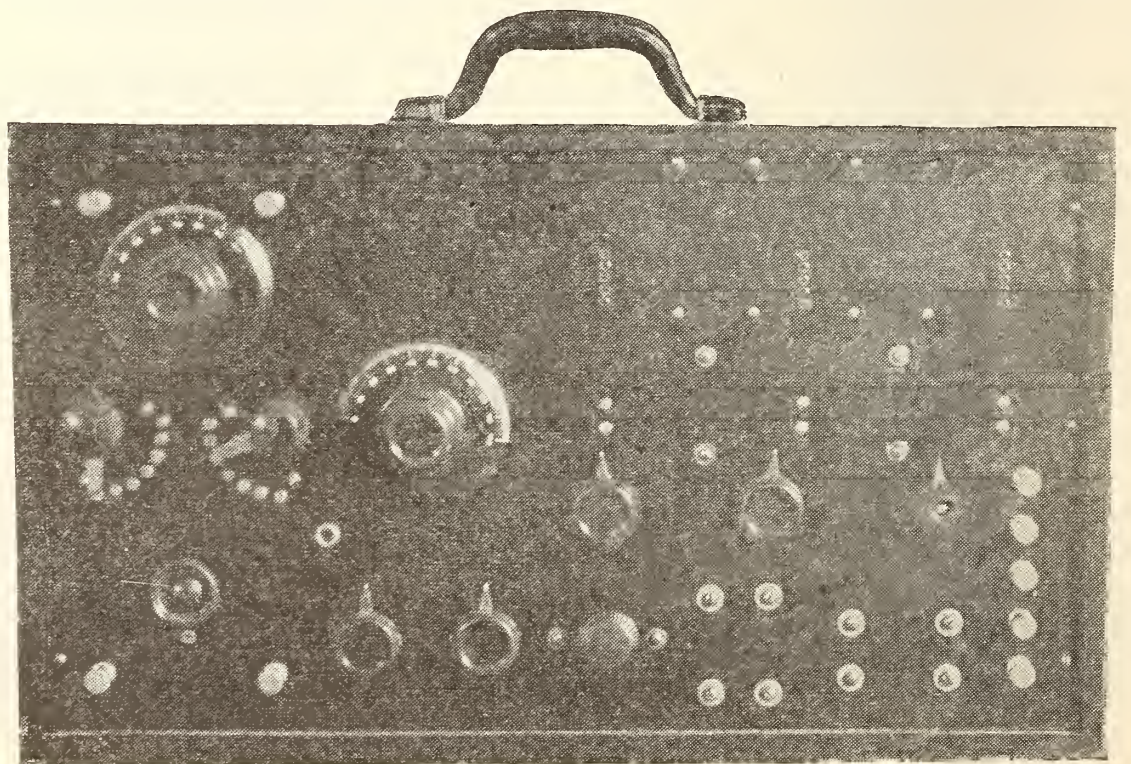

FIG. 3

A portable three tube Grimes set, for outside antenna or loop, built by Mr. Searing

fore it connects to the secondary condenser). The inside terminals of the jack run to the variocoupler, while the outside prongs are connected across the secondary condenser from which they run to the potentiometer and grid of the first tube. The loop may thus be plugged in, a process which automatically disconnects the variocoupler. It might be more convenient to mount this jack in the top of the cabinet, making it possible to use a loop with a plug in the bottom of its upright support (after the manner of the DeForest reflex), thus doing away with the separate stand for the loop.

Mr. Searing obtains excellent results with this set, his only complaint being that it tunes rather broadly. This is surprising, for the use of the variocoupler should result in a very selective set. It is possible that Mr. Searing is using an antenna of unusually high resistance (of small-size wire). This will broaden tuning, and in several cases which have been brought to the attention of this department, it has decreased the selectivity of good receivers. No wire smaller than No. 14 should be used, and No. 12 is to be preferred.

It will be noticed, from Fig. 4, that the builder has not crowded his apparatus. Plenty of space in the Grimes circuit lessens the chance of undesirable complications.

NEUTRODYNING THE DUPLEX

AGAIN we emphasize the prevailing fault of reflex circuits—the tendency towards self oscillation. In an endeavor to overcome this, Messrs. John C. Stick and N. P. Moerdyke have evolved about the best Duplex circuit we have yet seen (Fig. 5), in which they have combined three effective methods for the reduction and elimination of self-

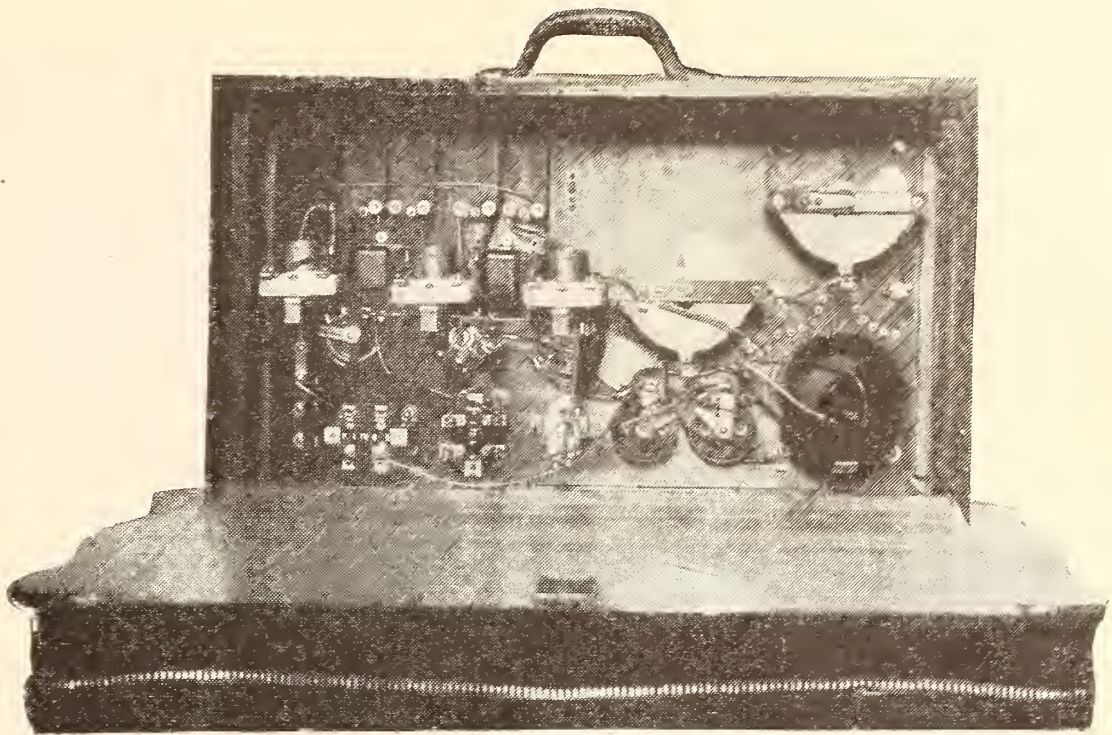

FIG. 4  
The interior of the three-tube set. Plenty of room here, and no crowding of parts

oscillation. First of all, they have minimized the feed-back possibilities by not over-doing the reflexing, having thrown back the energy through only two tubes, leaving the first tube to function as a straight radio-frequency amplifier. Secondly, they detect with a crystal, eliminating the complications which attend bulb detection in such circuits, and which caused the DeForest Company to adopt similar means of rectification. Thirdly, they applied the neutrodyne principle, and, “obtained a great improvement over the straight Grimes hook-up. As in the neutrodyne, the tendency to oscillate, and the presence of body capacity, were *completely*

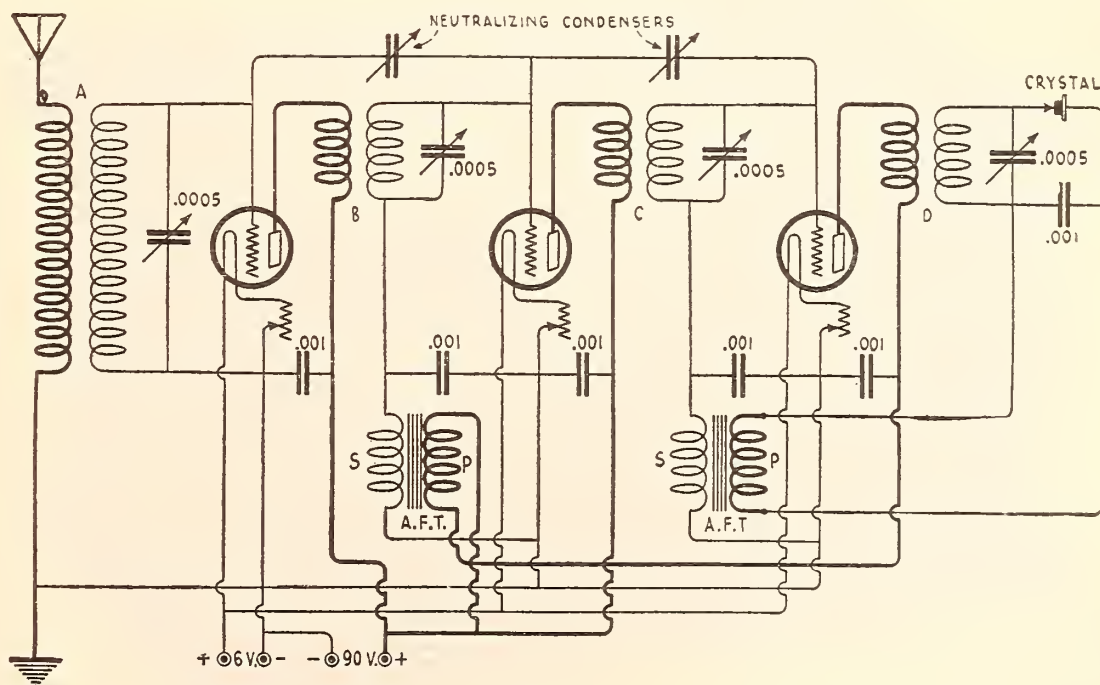

FIG. 5  
The best Inverse Duplex circuit we have yet seen. The neutrodyne condenser helps smother self-oscillations

*eliminated*, and the clarity and quality greatly improved."

The neutrodyning condensers may be made in many simple ways. Perhaps the best and most easily varied for experimental purposes, is made by twisting together two wires, two or three inches long. A few inches of regular two-conductor lamp cord will do nicely, though its lack of rigidity makes it less desirable than some other conductors.

A, B, C, and D are R. F. transformers, the primaries wound on  $2\frac{5}{8}$ " tubing and the secondaries on 3" tubing. The primaries consist of 17 turns of No. 20 double-silk-covered wire, and the secondaries of 68 turns of No. 22 D. S. C. The remaining values are indicated on the diagram, Fig. 5.

The secondary of the first transformer may be replaced by a loop. It might, however, be advisable to retain the ground connection to the negative filament.

### SPIDER WEBS AND THE ONE-TUBE REFLEX

THE photographs in Figs. 6 and 7 show a single-tube reflex set made after the complete instructions given in the November, 1923, issue of RADIO BROADCAST. The apparatus was constructed by Mr. C. H. Brown, and we are sure our readers will agree with this department that he made an excellent job of it.

Mr. Brown, however, departed slightly from

the plans worked out by Mr. Kenneth Harkness, substituting spiderweb coils for the conventional layer windings in the original apparatus. It is likely that the spider-web inductances are slightly more efficient. No. 28 enameled wire was used, all windings being made with the same number of turns as specified in the November article, which any one considering such a set is advised to read. The primaries are also wound over the secondaries.  $3\frac{1}{2}$ -inch to 4-inch winding forms made from pasteboard, thin wood, or fibre are about the correct size; the winding starts  $\frac{3}{4}$ -inch from the center. Any *odd* number of segments or slits in the spider-web forms may be used. Between ten and thirty are the most common and convenient.

Mr. Brown has also replaced the fixed resistance with a standard filament rheostat, a change of which this department approves. The rheostat is connected in the identical position of the fixed resistance.

The crystal detector used in Mr. Harkness' set has not, at this writing, been placed on the American market, but the builder of this neat set found an efficient substitute. Any good crystal detector may be used in place of the French arrangement mentioned in the original write-up. A permanent crystal is now on the market, which needs no adjustment, and so reduces by one the controls that must be manipulated.

The set illustrated in Figs. 6 and 7 is particularly interesting because of these deviations from the original described in the November issue. It is an excellent example of what we have been endeavoring to impress upon our readers, that considerable variation is allowable (unless specifically warned against) in making up radio apparatus. Indeed, it is seldom desirable to follow directions to the letter, for such a procedure is obviously antagonistic to progress. One tube will generally work as well in a particular circuit as will another, as long as the correct voltages, resistances, etc., are used. If you do not possess a certain make of audio-frequency transformer specified by one builder, use what

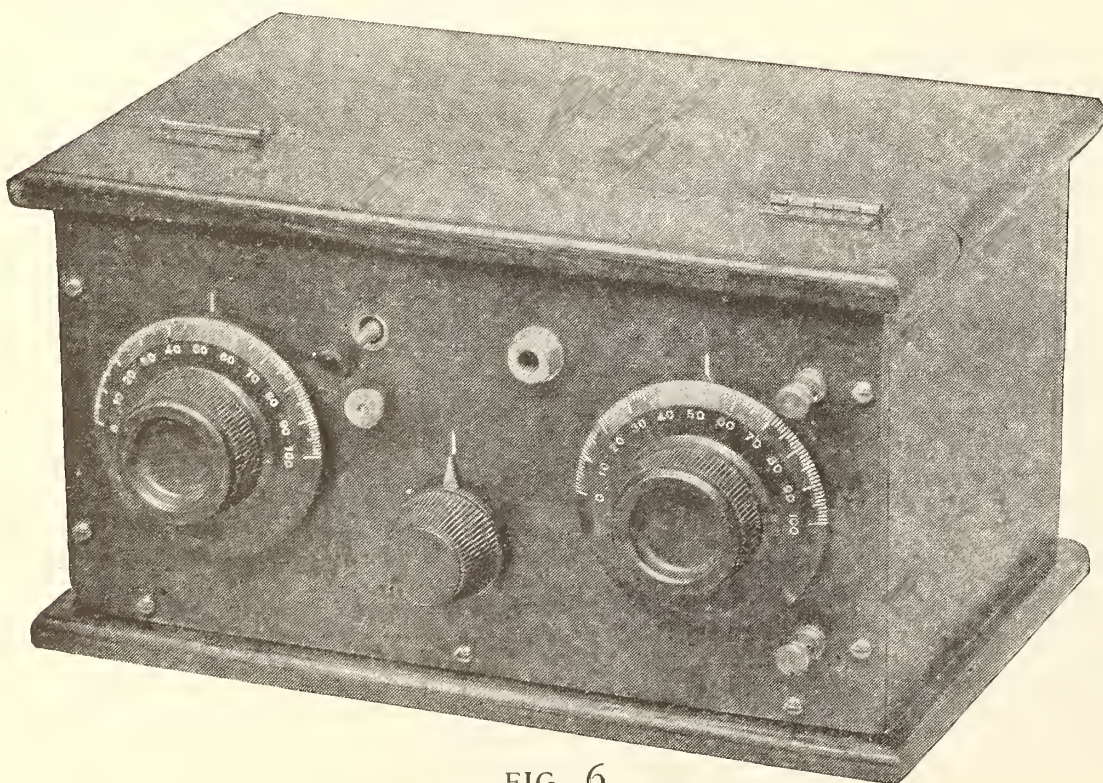

FIG. 6

Mr. Brown's neat reflex

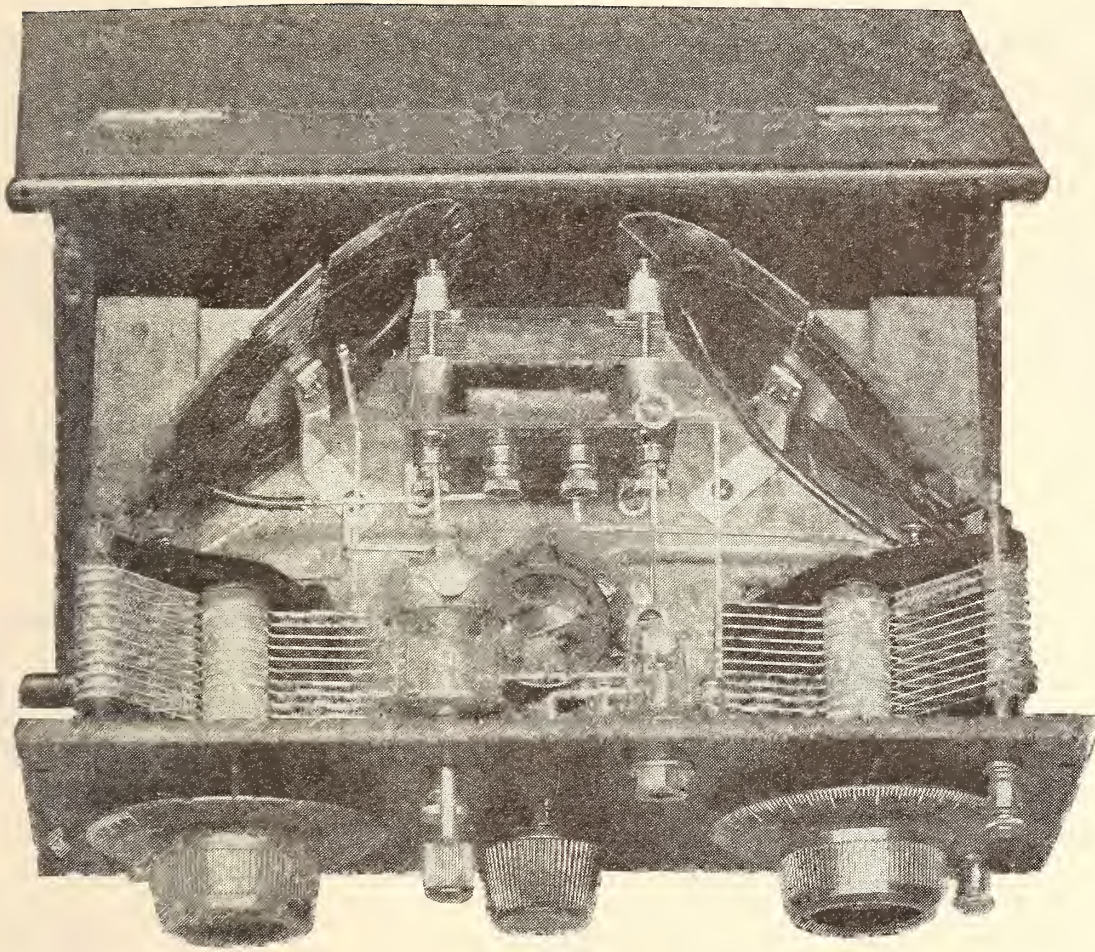

FIG. 7

The "works" of Mr. Brown's one tube reflex set. Note the spider-web coils

you have or can obtain, always, of course, confining yourself to good apparatus. Mr. Brown uses an Acme transformer; this laboratory has used the Amertran and Pacent with equally good results. If a set calls for a straight coil of wire, but you have (or prefer) a honeycomb, bank-winding, or spider-web, use it. The chances are it will work as well as, or even better than the inductance specified.

A radio set is of infinitely more value and pride to the owner, when it is, in part at least, a tribute to his own originality and thought.

## TRANSFORMERS AND REFLEX SETS

WITH the stir that reflex sets are making in radio circles, a word as to the proper series connections between radio- and audio-frequency transformers is quite appropriate, and will, perhaps, clear up some of the difficulties under which many of our readers seem to be laboring.

There are, of course, certain ends of both radio and audio transformer windings which should connect to the grid and plate, with the remaining terminals of the secondary and primary going respectively to the filament and plus (positive) side of the B battery. In the majority of cases, these terminals will be found

marked as "G," "F," "P" and the plus sign, +, or in another equally obvious manner. However, in a few cases, the reader may be left in doubt. In the case of a single-layer primary and single-layer secondary radio transformer, such as is found in the neutrodyne circuit, the coils are always wound in the same direction. Then if the start of the primary is led to the plate, the start of the secondary must run to the grid. In the case of audio transformers, the outside leads from primary and secondary run to the plate and grid respectively. It is generally a simple matter to determine the outside leads by noting how far from the core they enter the windings.

In reflex sets the *grid* terminals and the *plate*

terminals must always run to those two elements of the tube, either directly or through the windings of another transformer. The windings must always be "pointed" or heading in the right direction. For instance, the grid connection from an R. F. transformer will go to the grid, as it should, while the filament end of the secondary winding will run *to the grid connection of the audio transformer*. Thus the filament connection of the R. F. transformer finally reaches the filament, after running through the secondary of the audio transformer, while the grid connection of this latter transformer reaches the grid by running through the secondary of the radio transformer.

The circuit shown in Fig. 8 (the Inverse Duplex as improved by Mr. Eric Shalkhauser), indicates this principle very clearly by the lettering at the transformer terminals.

## LOADING THE TWIN VARIOMETER SET

By WM. H. WEST

SINCE the new allocation of wavelengths, the majority of owners of the twin variometer type of apparatus have experienced difficulty in receiving stations transmitting on waves above four hundred meters. The September, 1923, GRID section of RADIO BROAD-

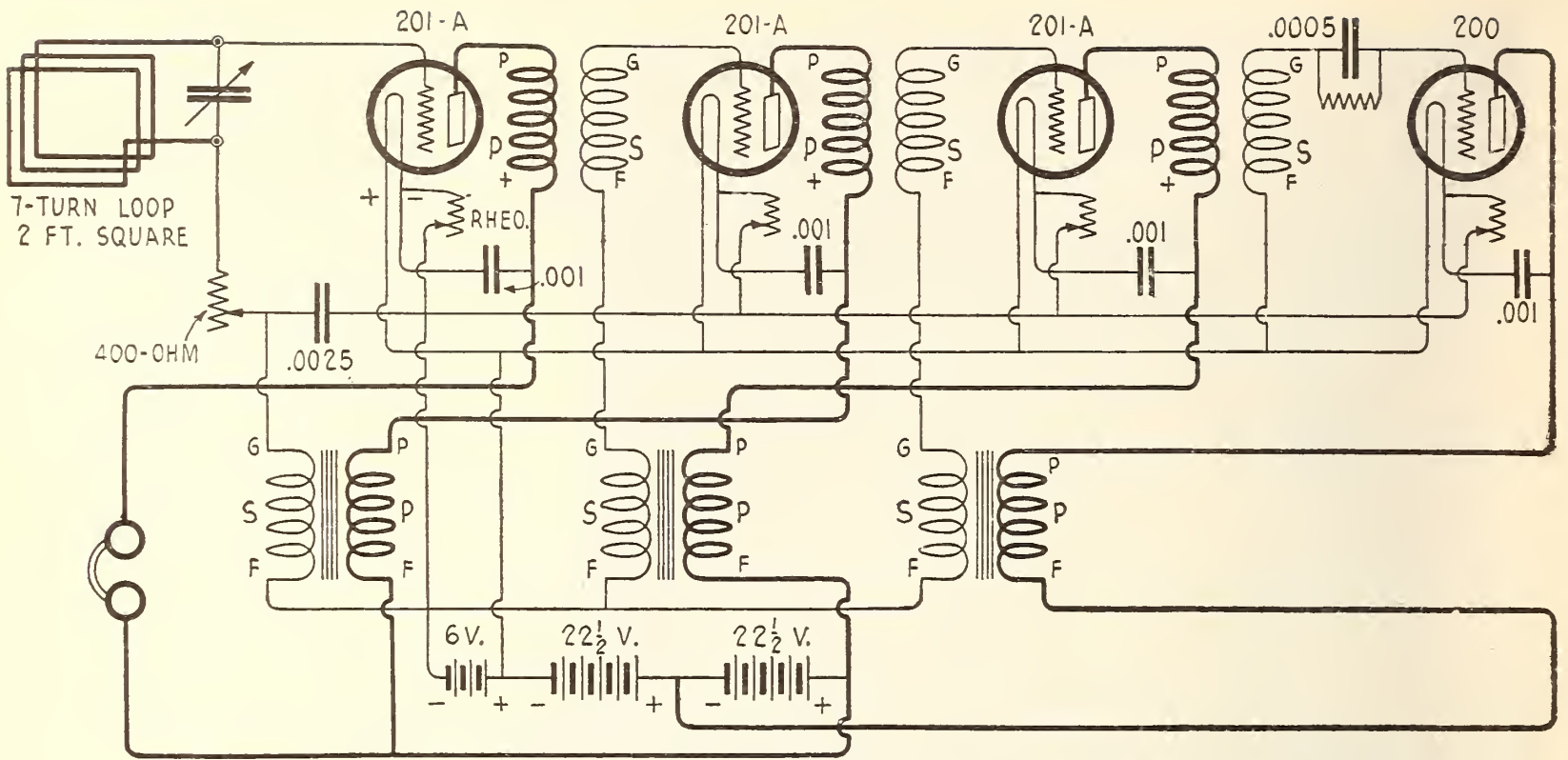

FIG. 8

The terminal initials of the transformers plainly indicate the principle involved in lining up the windings

CAST told how the wave range could be increased by means of added capacities. However, on many sets, greater efficiency and better results can be secured through a genuine load, that is, by means of inductance.

Such an inductance may be wound on a 4-inch tube with 75 turns of No. 22 to No. 24 wire. If you care to take a little more trouble in winding the coil, it can be done in such a way as to take up less space for the same amount of effective inductance. This is accomplished by winding 44 turns of wire in a pyramid bank winding on the same size form. This means that the first layer will have 9 turns, and each succeeding layer one turn less.

In order to avoid, as far as possible, the dielectric losses which are apt to be present when shellac or some similar substance is employed as an adhesive, it is suggested that the coil be painted with collodium, which is obtainable from any druggist.\*

Fig. 9 shows how this inductance is mounted beside the plate variometer, and in the same plane with the stationary windings. The coil should be located on the far side of the variometer, in order that it will have no inductive effect on the remainder of the set. The electrical position of this coil is in series with the secondary of the variocoupler, i.e., between the lower lead and the filament battery. Before the set will regenerate properly, it will in

\*This bit of advice applies to any other type of coil, and it is worth following.—THE EDITOR.

some cases prove necessary to reverse the leads to the coil.

In many cases it is a good idea to provide a panel switch for cutting the extra coil in and out of the circuit. This is quite necessary when it is desired to receive amateur wavelengths (below 220 meters).

It will be observed that on short waves regeneration is effected by means of the tuned plate method, and on the longer waves, by a combination of tuned plate and tickler feedback to the grid circuit from the plate variometer to the coil. This arrangement gives adequate regeneration over the entire range.

A standard receiver employing this addition and using an aerial of average proportions, was found to have a wavelength range of from under 200 meters, to over 900 meters; and it could be made to oscillate, with little difficulty, on all waves.

Slightly different characteristics were noted on the short waves after the change was made, but results were every bit as good, and on waves over four hundred meters, a much better signal was obtained.

#### BUILDING YOUR OWN LAB

THIS month's suggestion for the growing workshop is a good hack-saw, accommodating different lengths of blades, costing from seventy-five cents to one dollar. A small assortment of blades should be bought at the

same time. Four small blades with fine teeth for metal work, and two larger blades, with coarser teeth, for working hard wood, rubber, and bakelite, are desirable.

Any material with which the electrical experimenter has to deal can be cut by the hack-saw. It is particularly convenient in metal work, and it saves much time and labor on pieces too large for filing. It is also handy in cutting panels to size, and, on some woodwork, it makes a much neater job than the ordinary cross-cut saw.

In the usual position, with the teeth of the blade facing down, the hacksaw is unable to cut more than

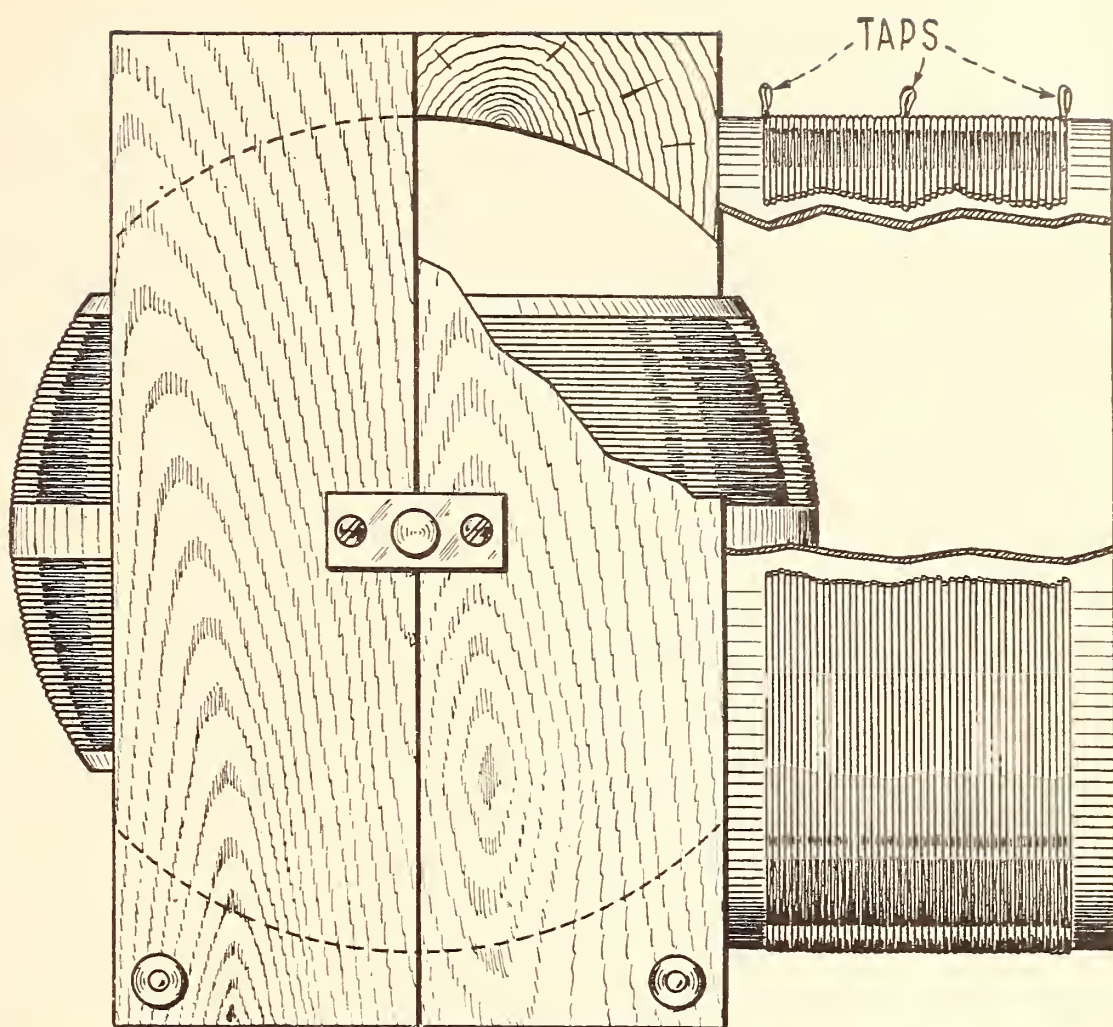

FIG. 9

How the extra coil is mounted on the plate variometer. The use of three taps, one for eliminating the coil altogether, is sometimes desirable, but not necessary

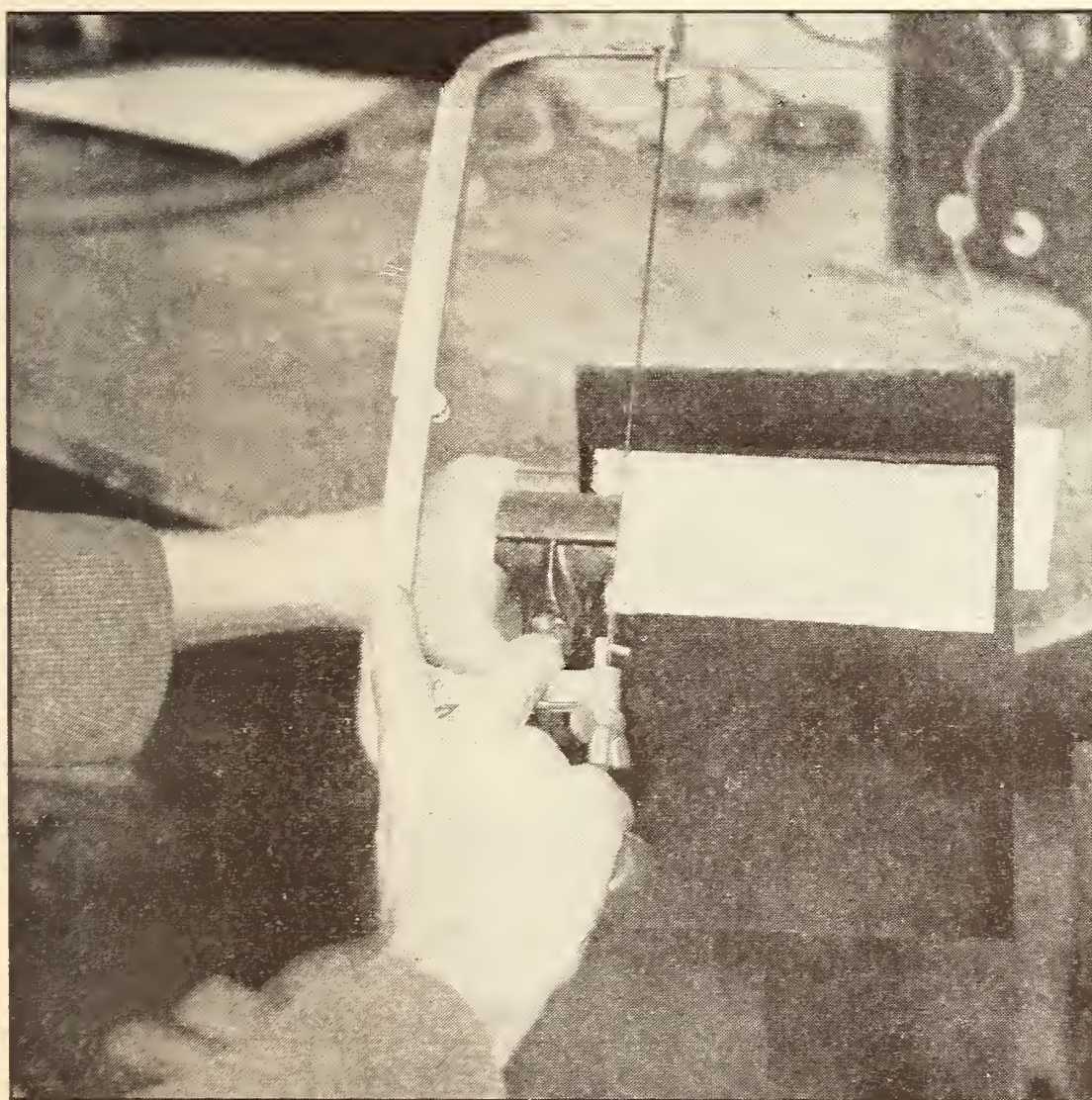

FIG. 10

Making a long cut with a hacksaw, the blade turned sideways

four or five inches before the motion is obstructed by the frame of the saw. However, the blade may be turned at right angles to the ordinary position (Fig. 10), and a cut of any length may be made with the blade in this position (providing, of course, that you do not saw so far from the edge of the material, that the frame is again in the way).

The vise described last month is just the thing to use when working with the hack-saw.

# Operating the Neutrodyne Receiver

Directions for Tuning, How Best to Use Different Kinds of Tubes, and How to "Shoot Trouble"

By KIMBALL HOUTON STARK

Chief Engineer, F. A. D. Andrea, Inc.

This is the third and final article of this series on building the five-tube Hazeltine-circuit receiver. The first two articles appeared in RADIO BROADCAST for December, 1923, and January, 1924, respectively.

**I**N THE first and second articles you have learned how to assemble and wire your neutrodyne receiver and have found it necessary, after its complete assembly, to adjust it for capacity neutralization.

The necessity of such a neutralizing adjustment is characteristic only of neutrodyne receivers. Due to the radical difference of the circuit, the method of tuning is also quite different from the tuning of the usual regenerative or non-regenerative receiver. Consequently, instructions must be very explicit.

In this article, we shall accordingly study in detail the method of tuning neutrodyne circuit receivers and in addition, some general information will be given on antennas, vacuum tubes and "trouble-shooting."

## TUNING THE RECEIVER

**T**HE procedure of tuning your neutrodyne receiver, providing antenna, ground, and all battery connections have been properly made, is as follows:

1. Insert the recommended vacuum tubes (See paragraph on the use of different tubes) in their respective sockets and with the power rheostat at its correct position for the type of tubes you are using, and with the vernier rheostat knob turned to the left as far as possible, and with the plug of the loud speaker inserted in the "horn" jack, pull out the knob of the filament switch on the panel front, causing the three amplifier tube filaments to light.

2. Turn the vernier rheostat knob to the right slowly. When the filament current is turned on, the first indication that the receiver is functioning properly will be indicated by a slight noise in the phones. As the rheostat knob is turned farther to the right, this slight sensitivity indication does not increase in

volume until a point near the end of the rheostat adjustment is reached. At this point will begin a comparatively loud "hissing" and "frying" noise. For the best signal reception the rheostat should be turned back slightly to a point just before this "hissing" and "frying" starts.

3. With the detector tube at approximately its right operating point, set "Neutroformer" dials 2 and 3 at the same dial setting. Select any particular dial setting, but take for instance the wavelength of station WEAJ, 492 meters. Dial settings for this particular station are about 66 or 67. Setting dials 2 and 3 at this point, rotate dial 1 very slowly over its entire range from 0 to 100. If any broadcasting station is operating at the particular time at 492 meters, it should be heard at a maximum when the setting of dial 1 is approximately in the range of 10 or 15 above or below these settings of dials 2 and 3.

4. When signals from any particular broadcasting station are coming in, it is advisable to readjust dials, 1, 2, and 3 slightly and possibly also the vernier rheostat, in order to increase the intensity of the signals.

In tuning, the dials should be moved slowly. It may be found that the tuning adjustment will have to be changed slightly when shifting the phone plug or loud speaker plug from one jack to another.

Dials 2 and 3 should be rotated slowly at the same time, and about in step with each other. Then with dials 2 and 3 on the setting for a particular station, dial 1 is rotated until signals come in with maximum strength and clarity. Sharpness of tuning of neutrodyne receivers when using short indoor antennas is much greater than when using outdoor antennas.

In tuning neutrodyne receivers, the broadcasting stations will not be picked up by hear-



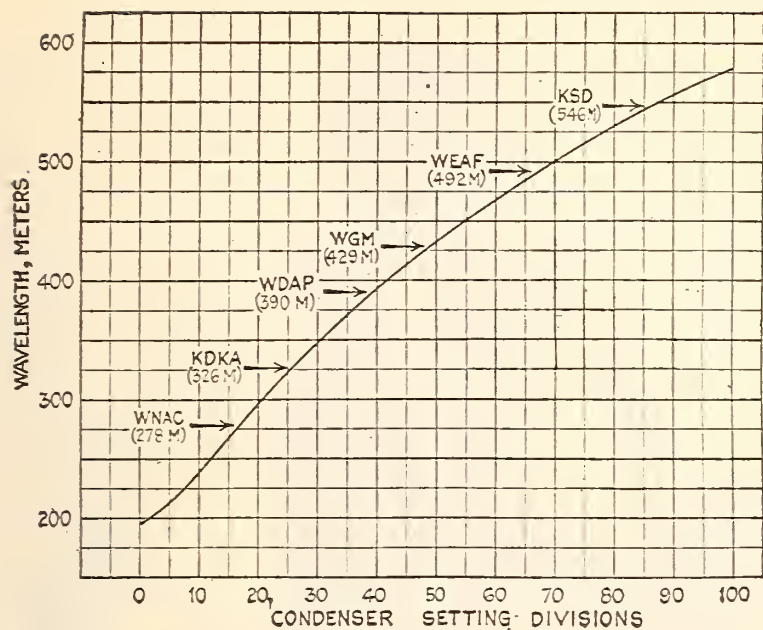

FIG. 1

Wavelength calibration curve showing approximately at what settings of dials 2 and 3 the various stations may be expected

ing "beat notes" and the usual regenerative whistling. As the dials are rotated the programs of different stations will be heard, first softly then with greater intensity and clarity as all adjustments are properly made for that particular station.

THE WAVELENGTH RANGE

THE Neutroformer coils specified in these articles are designed to cover a wavelength range of from approximately 200 to 600 meters. The wavelength calibration curve is shown in Fig. 1 and has several broadcasting stations' wavelength calibration points indicated.

USING DIFFERENT TUBES WITH THE NEUTRODYNE

IN THE early stages of neutrodyne receiver development, receivers were constructed that allowed the neutralization of a given tube and circuit capacity and which did not operate efficiently when different vacuum tubes having different capacities were used. With the placing on the market of the UV-201-A and the dry-cell tube, this matter of basic design was very carefully studied, and now they, and other tubes, can be used with comparatively good success. It has been found that C-301-A tubes are the best for the radio- and audio-frequency amplifier circuits. The C-300 or UV-200 is the best to use as detector tube. The UV-201-A is very good as an amplifier tube and is a close second to the C-301-A. I have been in intimate touch with many users of neutrodyne receivers and a great many of them have had good success with WD-11, WD-12, VT-1, VT-2, 216-A, and UV-199 tubes. When using any of these various types, it is, of course necessary to make sure that correct filament voltages as well as filament current is supplied to the tubes and in general the chart given in Fig. 2 covering "Operating Data for Vacuum Tubes" will be found variable. The lettered notations as regards the suitability of the tubes has been described with neutrodyne receivers particularly in mind.

The volume obtained using UV-199's or other dry-cell tubes is generally less than the volume obtained using UV-201-A or C-301-A

OPERATING DATA FOR VACUUM TUBES

TYPE OF TUBE	FILAMENT VOLTAGE	FILAMENT CURRENT (AMPERES)	"A" BATTERY SOURCE	PLATE VOLTAGE	USED AS			
					DETECTOR	R. F. AMPLIFIER	A. F. AMPLIFIER 1ST STAGE	A. F. AMPLIFIER 2ND STAGE
WD-12	1.1	0.20	1 DRY CELL	22½ TO 90	A	X	C	D
UV-199	3.0	0.06	3 DRY CELLS	22½ TO 90	D	A	C	D
UV-201-A C-301-A	5.0	0.25	6 VOLT STORAGE BATTERY OR 4 DRY CELLS	45 TO 120	C	A	A	A
UV-201 C-301	5.0	1.00	6 VOLT STORAGE BATTERY	45 TO 120	D	A	B	B
UV-200 C-300	5.0	1.00	6 " " "	18 TO 22½	A	Y	Z	Z
VT-1	4.0	1.10	6 " " "	22½ TO 67½	A	Y	B	B
VT-2	6.0	1.35	6 " " "	90 TO 350	D	B	B	A
216-A	6.0	1.35	6 " " "	67½ TO 120	D	B	B	A
UV-202	8.0	2.35	10 " " "	90 TO 500	X	D	B	A

LEGEND

A = EXCELLENT B = VERY GOOD C = GOOD D = FAIR X = POOR Y = VERY POOR Z = UNSUITABLE

FIG. 2

tubes, and this in general is true when any of the other different types of dry-cell tubes are used. The volume obtained, however, with dry-cell tubes under correct conditions permits loud speaker operation on distant stations. It is suggested, however, that with UV-199 tubes as radio-frequency amplifiers, C-301-A or UV-201-A tubes be used for the audio-frequency amplification.

#### THE MOST SUITABLE ANTENNAS

**A**N OUTDOOR antenna 60 to 70 ft. long and 30 to 40 ft. high, is possibly the best for use with a neutrodyne receiver. The multiple-wire antenna is generally no better than the single wire type for receiving.

A great many people desire to use an indoor antenna, either through necessity or to eliminate the trouble and expense of an outdoor installation. With a five-tube neutrodyne receiver, constructed in accordance with these articles, such an arrangement is feasible and in fact very good results can be obtained if one does not insist on getting the distant stations. A stretch of wire 50 or 60 ft. long in an apartment will work nicely, but this same length of wire should not be coiled around the wall in a single room and the same results expected.

There is still loop reception to be considered. Many people are using neutrodyne receivers with loop antennas. There are several methods of connecting a loop to the receiver: connecting one terminal of the loop to the antenna

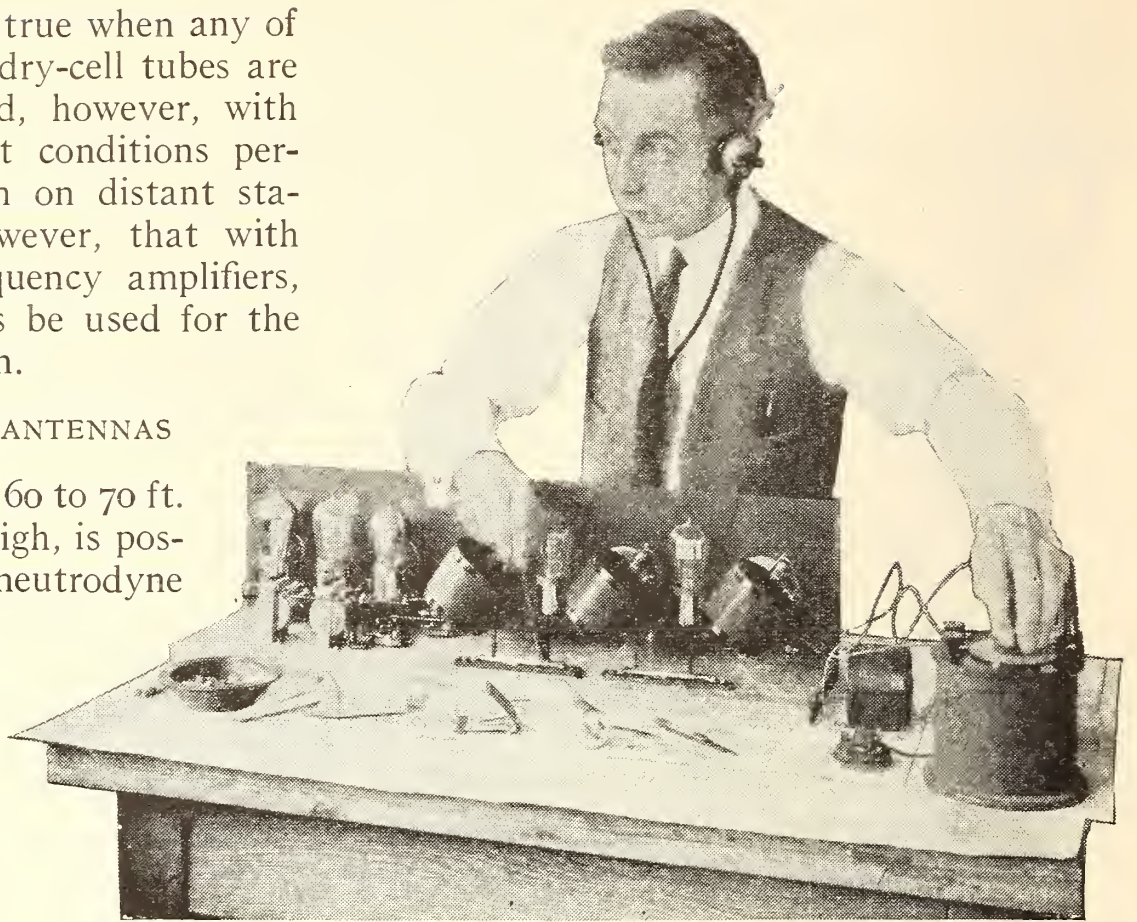

MR. STARK ADJUSTING THE SECOND "NEUTRODON"

binding post; connecting both terminals to the antenna binding post, thus shortening the loop itself; connecting the loop in series with a variable condenser and then connecting the condenser and loop in series with the antenna and ground binding post; and connecting one terminal to the antenna post and the other to the ground post. This is the arrangement most frequently used. In any of these cases it will usually be best to have the ground binding post to the receiver connected to the ground wire. The five-tube receiver described is not designed primarily for loop reception and an outdoor antenna is strongly advised.

#### "TROUBLE SHOOTING"

**T**HERE are people, who build receivers, that have very little technical knowledge, and it is somewhat difficult to describe to them technical processes. Even the simplest thing which the radio amateur or experimenter takes for granted are at first puzzling to the uninitiated, and it is not surprising that many people who have constructed neutrodyne circuit receivers have not been able to obtain complete satisfaction at their first efforts.

A detailed list of "trouble-shooting" instructions that will usually aid the home constructor to put the breath of life into his receiver satisfactorily follows:

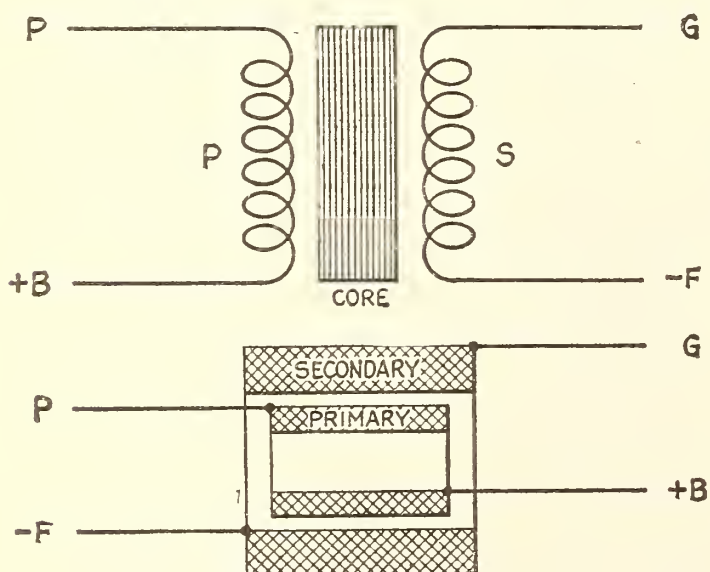

FIG. 3

Showing the audio-frequency transformer connections

Check all connections very carefully with the picture wiring diagram given in the second article of this series (RADIO BROADCAST, Jan. 1924). After your own check convinces you that your wiring is correct and absolutely identical with the diagram, it is best to have someone else check it over so that the same mistake will not be repeated.

A point of great importance is that the variable condenser of the Neutroformer unit rotary plate terminal be connected directly to the negative terminal of the vacuum-tube socket of the amplifier tubes. It will be noted in the diagram, however, that this wire from the rotary condenser plate terminal of the third from the right hand Neutroformer connects to the +90-volt terminal of the detector tube.

*Audio Transformers:* Many times, when howling occurs, reversing the connections to the primaries of either one or both of the audio-frequency transformers will remedy the trouble. The drawing Fig. 3 shows the correct arrangement of transformer terminals and also the best plan of connecting the various leads from the transformer windings to the terminals.

*Fixed Condensers:* In special cases, where trouble with balancing out is had, it may be advantageous to cut out entirely the fixed

condenser (capacity .006 mfd.) which is connected from the detector tube plate terminal to ground of the negative A and B batteries common lead. Eliminating this condenser and re-balancing carefully will many times secure a very good minimum or inaudible signal balance.

*Dirty Contacts:* Connections which lead from the elements of the vacuum tube to the direct terminals are soldered to the tube contact pins and these soldering connections oxidize and become dirty very quickly. One should see that the bottoms of these tube contact pins are always bright and clean.

*Neutroformer Mounting:* The neutrodyne circuit requires that all electromagnetic coupling as well as electrostatic coupling be balanced or neutralized. Accordingly, the mounting of the Neutroformer is of great importance, and the correct angle that they should be mounted at is 54.7 degrees from the horizontal. A slight variation from this angle will cause trouble in balancing out. If the experimenter drills his own panels, great care should be taken to see that this angle is correct.

Be sure that all your connections are OK. Then if your set is built in accordance with the directions given in these articles, the results will repay you many times over for your work.

# Various Circuits and What They Mean

## PART III

### Capacity and Inductance and Their Relation to Tuning in Radio Circuits

By ZEH BOUCK

In response to our requests to readers for information on just what type of articles they desire, we have received many letters which indicate that the radio public is growing more interested in the theory of their science. It is an obvious fact that greater enjoyment and efficiency can be derived from any type of apparatus when the theory of its action is comprehended. However it is difficult for us to know just how far we may delve into the fundamentals of radio and yet appeal to the layman. Let us know how you like this article, and if you would care for more of a similar nature.—THE EDITOR.

**T**HERE are some bits of radio theory which are of great aid to the enthusiast in getting the most from his apparatus. Among these theoretical facts which cannot be scorned with impunity, is what actually occurs during the process of tuning. Just what does happen when one juggles the condenser and inductance dials on the receiving set? Many en-

thusiasts have wondered, but have been deterred in satisfying their curiosity by the fog of mathematics which more or less covers the theoretical functioning of C (capacity) and L (inductance).\*

However, the only mathematics of which

\* The reader is advised to read the article on "inductance," appearing in the January RADIO BROADCAST, and which is the second in this series.

one need boast, in order to understand the theoretical significance of tuning, is a knowledge of fractions and equations which is herewith slightly reviewed.

A common fraction is designated by two numbers, the numerator and denominator, placed respectively above and below a bar indicating a fraction,— $\frac{1}{2}$ ,  $\frac{5}{16}$ ,  $\frac{1}{4}$  etc. There are very few of us who are unfamiliar with these relics of elementary schooling.

If the *denominator* of a fraction is made larger, the value of the fraction is quite obviously made *smaller*. Thus  $\frac{1}{16}$  is less than  $\frac{1}{2}$ . And so, if we have two quantities called X and Y, X being equal to  $\frac{1}{16}$  ( $X = \frac{1}{16}$ ) and Y being equal to  $\frac{1}{2}$  ( $Y = \frac{1}{2}$ ), Y is a larger quantity than X.

#### THE EQUATION

**A**N EQUATION, as its name declares, is a statement of equality: For instance,  $10 = 2 \times 5$  or  $8 = \frac{1}{2} \times 16$ . We can see by observation and from the definition of an equation, that if one side of an equation is multiplied or increased, the remaining side increases automatically (in order to maintain an *equation*) and in proportion. Thus in the equation  $10 = 2 \times 5$ , if the 2 on the right-hand side of the equal mark is changed to 4, the 10 must be changed to 20, and the equation read  $20 = 4 \times 5$ . In the equations  $XL = 2\pi f .25$ , and  $XL = 2\pi f .5$  in the latter equation represents twice the amount of XL in the former equation.

Likewise, if one side of an equation is reduced, the other side decreases in proportion.

#### REACTANCE AND RADIO CURRENTS

**T**HOUGH it has been many times stated and explained, it will do no harm to reiterate that radio currents in the antenna and in most of the circuits of receiving and transmitting apparatus are "alternating," that is, they travel first in one direction and then in another, *changing polarity from positive to negative*. As was shown in the preceding article on "inductance," a coil of wire carrying an alternating current will have induced in it an E. M. F. (electro motive force which results in a current) in a direction opposite to the inducing current. This is called, for obvious reasons, a "counter E. M. F." Therefore, we have, in an inductance carrying radio electricity, perhaps a tuning coil, variometer, etc.,

*two currents which are opposing each other, the counter E. M. F. tending to hold back the original current; and, if the counter E. M. F. is sufficiently powerful (the inductance of the coil sufficiently high), it will retard the current until the voltage has changed polarity.* In other words, the current may be on the plus side of an alternation when the voltage is on the negative side; and as work (such as making a sound in the receiver) can be accomplished by electricity only when voltage and amperes come together, power is lost by this inductive effect. It is obvious that the slightest loss of weak radio currents must be fatal to reception.

This ability with which a coil builds up a counter E. M. F. is known as reactance, i. e., "acting back on." Now, as the counter E. M. F. is caused by the rise and fall of the magnetic flux generated by the original current, the strength of the counter E. M. F. varies with the rapidity with which this field rises and falls, in

other words with the frequency of the current. Indeed, all of this may be summed up in the following formula for reactance:

$$XL = 2 \pi f l$$

XL is the reactance which is computed in ohms, for its effect on a circuit is very similar to that of resistance. L is the inductance in the circuit (for the greater part, the coils of wire, etc.), and as L increases, for instance, by adding more turns of wire, the reactance, XL, will necessarily become greater. (Increasing one side of an equation automatically increases the other side). F is the frequency of the current, and, likewise, as that becomes higher, so does the reactance. (The frequency of a radio current, of course, changes with the wavelength. However, the proportion is an inverse one. That is, when the wave is decreased, the frequency increases; when the wavelength increases, the frequency is lessened. The reader must bear this in mind, so that when we have occasion to speak of a wave change, he may instantly interpret our words in terms of frequency, and vice versa.)

In brief: *in a coil of wire carrying a radio current, there exists a tendency to nullify or make useless that current—a tendency that varies directly with the size of the coil and the wavelength of the current.*

Coils of wire, or inductances, are necessary in every radio set, for the transference of energy



from the antenna to the tube circuit, and from one circuit to another. But it is quite apparent that if a set consisted of inductance alone, it would not work, because due to the reactance, the current would lag—be altogether useless—and no signals would be heard. There must, therefore, be some way of overcoming the difficulty of neutralizing the reactance. There is, and in order to name this something, the reactance of inductance has been qualified by the word “positive.” That is, instead of saying a coil of wire merely has reactance, it is said that it possesses positive reactance, while the thing that overcomes it is known as *negative* reactance: the reactance of a capacity or condenser.

It has been shown that positive reactance causes the alternating current to lag or slip behind the voltage, but a circuit having a great deal of capacity has just the opposite effect, and causes the current to “lead” or jump ahead of the voltage. Thus, by carefully balancing the lag and lead, with coils and condensers, it is possible to bring the current into step, or electrically, into “phase” with the voltage. When this condition is realized, efficiency will be the greatest and the most work accomplished.

This current lead which characterizes a circuit containing a predominance of capacity, is due to a “displacement current” which anticipates the direction of the current which is to follow. This displacement current varies with the capacity of the condenser and the frequency of the E. M. F. in a manner that is best illustrated by the formula for negative reactance:

$$XC = \frac{1}{2\pi fC}$$

XC, the reactance, varies *inversely* with the frequency and capacity. (It will be remembered that positive reactance varies *directly* with the change in the qualities which are responsible for it.) If the condenser or frequency is increased (*the denominator of the fraction*), the reactance drops, and vice versa. We now arrive at the point where this information throws light upon the tuning of a radio circuit.

#### WHAT REALLY HAPPENS WHEN YOU TUNE

**B**OTH kinds of reactance, positive and negative, change with the wavelength or frequency, and to receive energy at any particular frequency, the two kinds of re-

actance must be equal to each other at that frequency so that the current will be in phase with the voltage. This point of equilibrium or balance is called the “resonance point.” *All circuits have some resonance point*, no matter what the values of capacity and inductance may be. In other words there is always some wavelength at which the negative reactance will balance out the positive reactance. This may be shown by examining the two formulas simultaneously:  $X = 2\pi fL$  and  $XC = \frac{1}{2\pi fC}$ . *Now, follow this carefully:* If we start at an extremely high frequency (a high value of  $f$ ), we shall find (regardless of the values of  $L$  and  $C$ ) that  $XL$  is much greater than  $XC$ . As the frequency is lowered (the wavelength raised)  $XL$  of course becomes smaller, while  $XC$  (the denominator decreasing) becomes greater. Hence, at some point or another (the resonance point),  $XL$  will be exactly equal to  $XC$ , and the wave (frequency) at which this occurs will be *that to which the circuit is tuned*.



All of this may seem slightly confused, but we believe it will be clarified by a more concrete example, for which we shall specify a regular three-coil honeycomb, three-circuit receiver, the circuit for which is shown in Fig. 1. During our hypothetical tests, the honeycomb coils will not be changed—in other words,  $L$ , or inductance, will be constant. There is a condenser in series with the primary coil, and another shunting the secondary. The capacity between antenna and ground acts as an additional capacity, which, in conjunction with the primary variable, is virtually a shunt across the primary coil. Thus each coil, primary and secondary, have condensers across them, the capacities of which are decreased by turning down the scales of the variable condensers. Hence what proves true of one circuit (in so far as varying the condenser is concerned) will be true of the other, and so, only one circuit, the primary, will be considered.

We shall assume, at the start of our experiment, that the primary is tuned to four hundred meters, and the primary condenser is set at fifty degrees, about one half of its scale. We now move the condenser down to twenty-five degrees. What has happened? We have increased the negative reactance (by decreasing  $C$ , or the denominator of the fraction). If the negative reactance has been increased, then the new resonance point will be one at which the

positive reactance is also greater (remember they must always balance). How can the positive reactance increase to meet this negative increase? By increasing the inductance or frequency, or  $L$  and  $f$  in the formula  $XL = 2\pi fL$ . But we have said that the honeycomb coils, or  $L$ , are not to be changed, so that leaves  $f$ , or frequency, as the only possible variation. Therefore  $f$  must rise, and so it does until the increasing positive reactance equals the negative reactance which rose when the primary condenser was lowered. But when the frequency rises the wavelength comes down. Thus lowering the capacity in a condenser decreases the wavelength. The reverse is equally true and obvious, i. e., the condenser capacity increases,

means of taps), the positive reactance is increased in accordance with the formula  $XL = 2\pi fL$ . Therefore, at the new resonance point the negative reactance must also be higher. But, as the condenser or capacity is not to be varied, the frequency must drop (lowering the denominator of the fraction in  $XC = \frac{1}{2\pi fC}$ ) or the wave rises. Hence increasing the inductance in a circuit increases the frequency of wave.

#### UNDESIRABLE EFFECTS OF CAPACITY

THAT is all there is to the mystery of tuning, and a comprehension of the foregoing will be of value to the experimenter in showing the true functioning of capacity and inductance as no analogy or less scientific explanation could do. A little thought will now indicate why it is desirable to eliminate all stray capacity from a circuit. In the circuit of Fig. 1, the strength of the signal depends on the E. M. F. induced across the coil, or between the terminals Y and Z. The larger this coil, or the higher the inductance, the greater will be this E. M. F. and the strength of the received signal. Hence it is always best to increase wave by means of inductance rather than by shunting with capacity. On a honeycomb set, experienced operators always use the largest coil permissible for a given wavelength, keeping their condensers as near to the zero point as possible.

For this same reason, shellac, and similar adhesives which, through their dielectric qualities, increase the distributed capacity, are eliminated from efficient windings. The honeycombs and duolateral windings, the spider webs, etc., were all designed and invented with the idea of decreasing capacity and permitting a higher value of  $L$  for a given wave. Professor Hazeltine has developed the neutrodyne system with the same purpose in mind. Short wave radio frequency amplification had been impossible for many years due to the high capacity between the elements of the vacuum tubes boosting the waves, so that not sufficient inductance could be used for an efficient transference of energy.

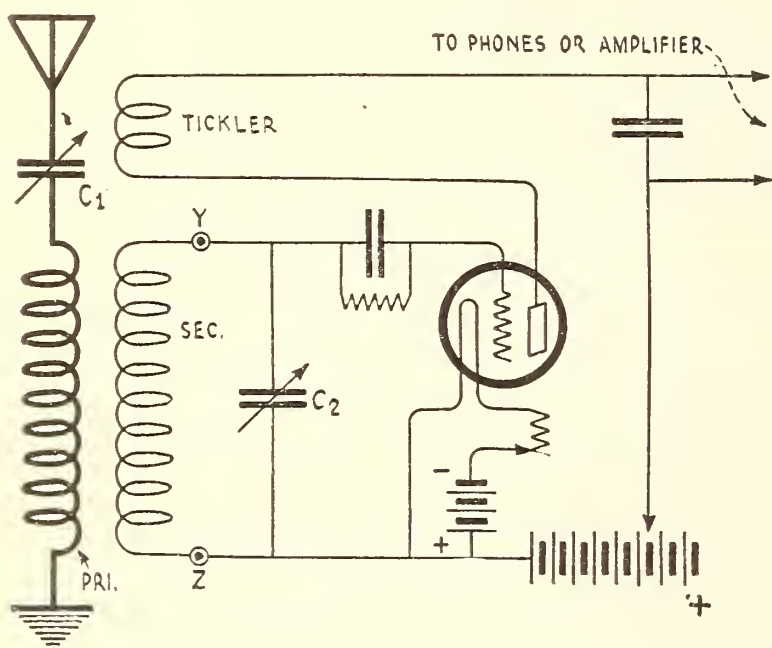

FIG. 1.

Diagram for a three-coil honeycomb set. For best operation, the primary, secondary, and tickler coils should be comparatively large, the tuning being done with condensers  $C_1$  and  $C_2$ , the latter should be of small capacity, as outlined under "undesirable effects of capacity"

the negative reactance is lowered, and to lower the positive reactance to the same value, the frequency must come down—and the wavelength rises.

The effect of varying the inductance in the circuit is also easily followed in the same manner. If the inductance is increased (perhaps more turns of wire are put into the circuit by



# Announcing Some Announcers



## "CHIEF MIDNIGHT AGGRAVATOR"

Earl Martz, director of programs and announcer at WDAL, the Florida, *Times-Union* station, who puts his collection of Midnight Aggravators on the air from 12 to 1 o'clock. Their sparkling jazz is being heard "from Maine to Cuba and all through the West," says C. M. A. Martz



## EDWARD F. HARRINGTON

Studio director of WCX, the station of the *Detroit Free Press*, out there in Michigan



## MARTINEAU OF KPO

E. J. are the initials, although it's "H. J. announcing." He is director of the Hale Brothers station in San Francisco



## CREATOR OF "RADARIOS"

Herewith Fred Smith, studio director of WLW, the Crosley Manufacturing Company station in Cincinnati, who originated the type of drama broadcasting known as the "radario"



## TRANSFERRED FROM WJZ TO WRC

Bruce Lum's handsome voice now issues from his handsome self at the Washington, D. C., station of the Radio Corporation of America

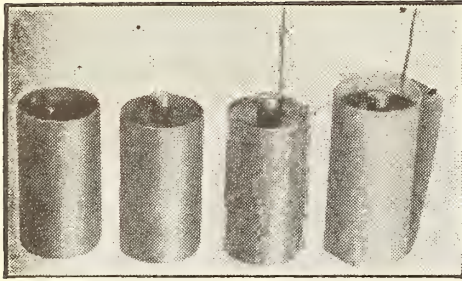

$\frac{1}{15}$  OF A B BATTERY

First, the zinc case; next, the core in the case; then, the top of the core is sealed, after the electrolyte has been poured in; and finally, the insulating wrapper



THE HISTORY OF A ZINC CASE

Which forms the exterior of one of the fifteen units of a B battery. Presses reduce the diameter of the cap until it reaches the size shown at the right

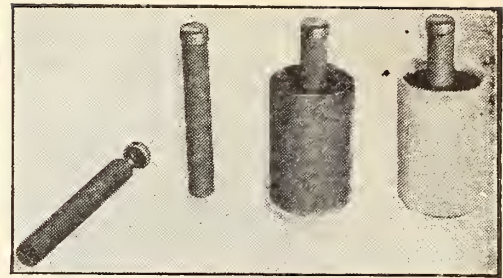

THE CENTER OF THE CELL

The "mix" of black substance in the cell is compressed mechanically and then the core is driven into it. When the core and "mix" are thus united, the whole is wrapped tightly with cheese cloth

## The Anatomy of the B Battery

**W**E BUY what is called a B battery, connect it to our set, use it until it is "low" or "dead," discard it, and get another which will deliver the necessary voltage. We know that it is heavy and more or less foolproof, and contains a number of cylindrical cells, with "chemicals" inside them. But do we ask ourselves how they are built and tested and what the "chemicals" are?

B batteries are carefully made. They are put through long tests to determine their life. Every bit of material which goes into them has passed the chemical board of review in the factory—and there are no more critical souls than the chemists.

Your B battery of 22.5 volts contains fifteen little cells, each with a voltage of 1.5. These fifteen cells are connected in series. And while there are other sized cells on the market, the process of manufacture is about the same.

First, the zinc case is stamped out. When this

is completed, the carbon core is made. Then it is wrapped with a certain grade of cheese-cloth, and capped with a bit of shiny brass. The breath of life to a dry cell is manganese dioxide ore, graphite, sal ammoniac and zinc chloride—the gelatinous electrolyte. Paraffin is used liberally in cell manufacture to keep moisture out and for its value as an insulator. The carbon cores are dipped in paraffin, as are the washers used in the cell interior.

The finished core and the finished zinc can are ready for assembly. The core, even with its winding of cheese cloth has plenty of space

between it and the zinc casing. This space is where the electrolyte is placed. It is the electro-chemical action between the carbon core and the zinc case, aided by the half-damp electrolyte between, (which is put in by compression hammers) that causes a voltage to be developed between the zinc and carbon terminals of the cell.

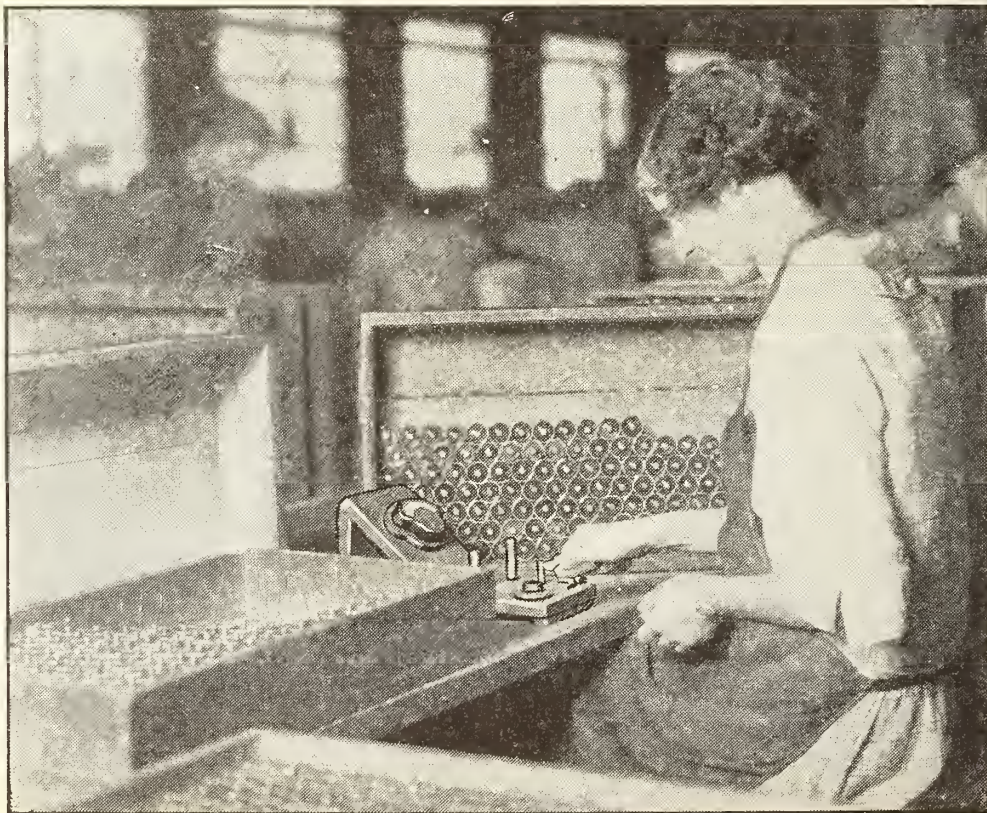

EACH UNIT MUST PASS THIS METER

Only cells which measure up to the proper open-circuit voltage and the proper short-circuit amperage go into B batteries



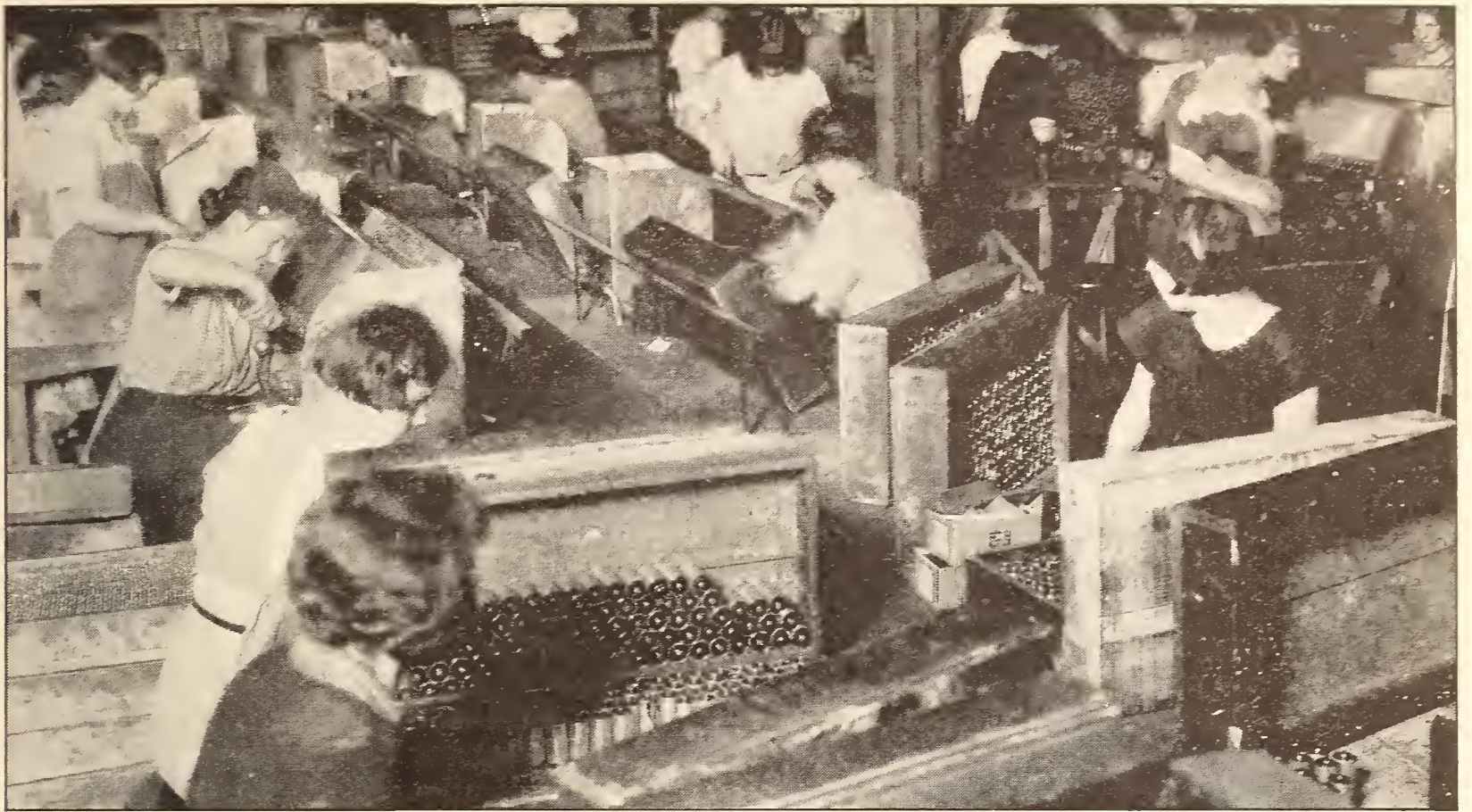

#### WHOLESALE SOLDERING

Cells are soldered in groups of three instead of five, although the latter would be easier, in order to reduce the voltage drop. In all the soldering and insulating a non-corrosive compound is used to flux the solder. Any other flux would cause current losses inside the finished battery block

#### THE FINAL STEP IN MANUFACTURING

The picture shows the process of pouring the sealing and insulating compound around the completed cells. One layer of the hot mixture, a layer of cheese cloth, to prevent the sealing mixture from cracking, and two additional layers of compound are added to the battery. The terminals are then tested for proper voltage, stamped, and the battery is finished

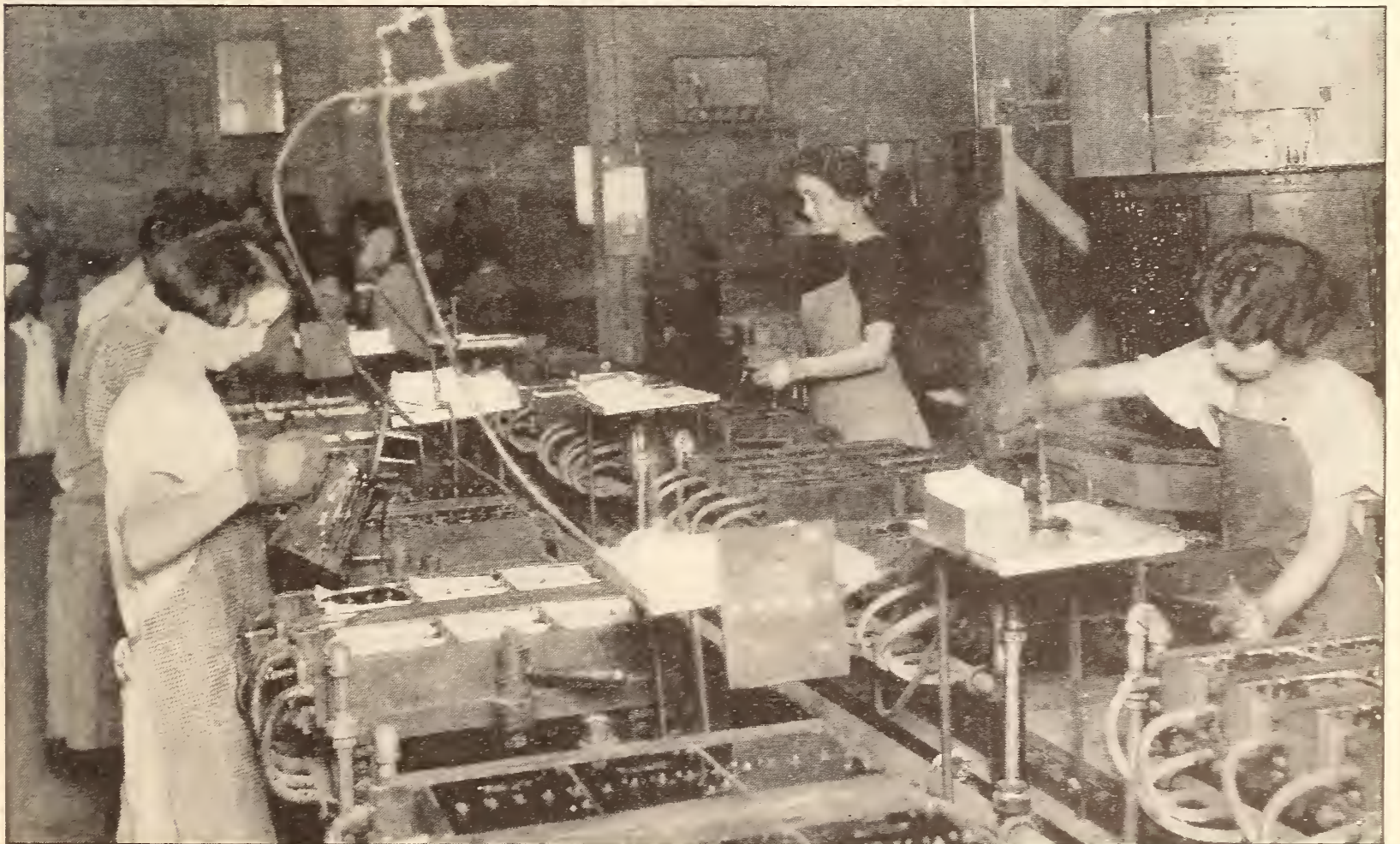

# The Young Heart

By ROBERT OLIVER

**P**ROWLING about among the city's radio stores, as I often do, to keep posted on the "market" as it relates to the price of parts and accessories, I have on numerous occasions encountered an elderly gentleman who seems to have a passion for buying all kinds of equipment. I have seen him at the "five and ten" and at down-town "gyp" shops, as well as in the more expensive places around Grand Central.

He is not a mere "looker," as the clerks dub those poor wistful wishers who yearn to possess but haven't got the price and those who *can* raise the price, but who *can't* make up their minds. No, he is not a "looker," for he buys, buys, buys.

I am sure this old man has accumulated a stock of radio parts sufficient to build a dozen sets, enough parts to keep a man busy for weeks putting them together—and taking them apart as soon as some particular hook-up has been given a trial.

There is a sort of free-masonry among radio fans. If you happen to sit next to a chap on the 5:15, who is solemnly drawing peculiar designs in his notebook, the odds are ten to one that it's a hook-up. There is no grand hailing sign, in this fraternity. Almost any one of a thousand questions touching upon radio will suffice. For instance, if you inquire, "How many volts are you using on your detector?" you are introduced at once. There is a warmly responding interest and you're off, as if you had known each other for years. No icy reserve, no elevated eyebrows, no "Pardon me, but you have the advantage of me, sir."

I wanted to talk to the elderly gentleman, for he had aroused my genuine interest. I had found it so easy to begin conversation with a radio bug that I laid no careful plan of approach, but merely asked:

"Pardon me, do you find radio an interesting pastime? And if so, why?"

Casually drawing out of my left-hand trouser pocket an assortment of switch points, binding posts, crystals, etc., I jingled them carelessly

in my hand as a sign that I too was a devotee, I might say, a slave.

Recognizing in me a brother of the thirty-third and last degree of that fraternity which is doing so nobly in furnishing the funds that keep broadcast stations going, the elderly gentleman greeted me with what seemed to me to be sincere pleasure.

Receiving his package of parts from the clerk, he withdrew with me to a corner of the establishment where we could chat in seclusion. "You ask me," he said, "if I find radio an interesting pastime? and if so, why?"

"I trust you will overlook the unconventionality of the occasion," I replied, "when you know that I have no wish to pry, but seek only to fraternize for a moment with one of the brethren of the guild."

"My boy," exclaimed the old man with feeling, "I am glad you asked me that question. Yes, I do find radio an interesting pastime. Frankly, it has become almost a passion with me. In answer to the second part of your question I will show you my purchases for to-day."

Eagerly he untied the package. "This you will recognize as a single-coil mounting. I have no immediate need for it, but I bought it because hook-up No. 46, as I recall it, calls for a 75-turn honeycomb. What's that? Oh yes, I number the hook-ups as I file them away. I file them as they come out. It's the only way I can keep track of them. I am now up to No. 24, according to my record, and when I get to 46, or perhaps it's 47, I shall need this mounting. And here are two rheostats, they come in handy when I am in a hurry and haven't time to dismantle some other set to get the rheostats. And this transformer—I bought it at a bargain. I have three at home, one just like this, but I simply couldn't resist buying it—a real bargain, I think, and I know it is good.

"And here are several grid leaks, a condenser, some bus-bar wire, and several dials, and two phone plugs. And this," his hand trembled as he unwrapped another package which he

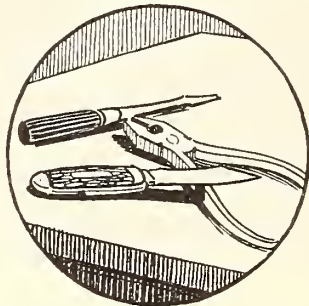

had taken from his pocket," this is a sending key."

"A sending key!" I exclaimed. "You mean—you mean you are a Ham?"

"No, my boy, I am not a Ham, but before I get through with radio, I will need that key. I am learning the code now. Yes, never too old to learn, as I told Jack the other day. Jack is the boy next door, a bright young chap. We are learning the code together. We are practising now with a buzzer. As we get it down a bit better, I am going to rig up a bulb on the buzzer set and we will learn to read the code by the blinkers.

"Oh, yes, I'm going to have plenty of use for that key, if I live. I wonder if you will understand?" He peered into my eyes, searching

life on their own, and then one day my wife passed on. There was then nothing left, apparently, for me to live for.

"Time hung heavily on my hands. I found myself waiting for the end. Life held little of interest, until one day the radio bug bit me.

"I needn't tell you how it came about. Perhaps you will recall how it was in your own case. I soon became a most enthusiastic fan. I began to build sets. For years, without realizing it, I had stifled a hunger to build something, to play with tools, to tinker, to experiment. I was too busy.

"At my age, many men go to seed. They turn their faces toward the sunset and hasten the setting of the sun by dwelling upon the approaching end. Not so with me. Radio

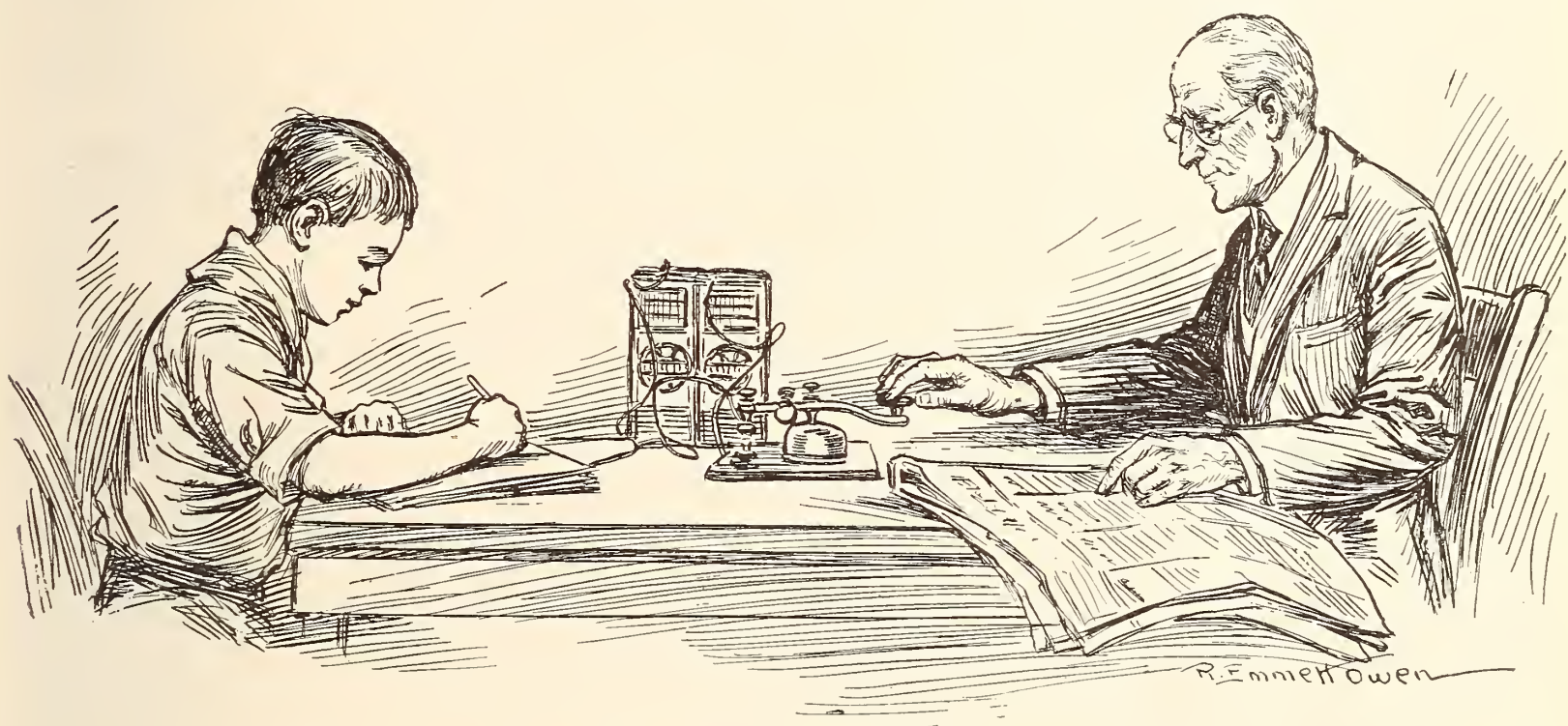

"WE ARE LEARNING THE CODE TOGETHER"

for the answer to his question. "The fact is, my boy, I am way behind in my play. It's only a little while ago that I learned *how* to play. Did you ever stop to think how far behind a busy man gets? I am years and years behind in my play. As a boy I started to work at a very early age. Most boys in my day had to work. Some of the well-to-do lads, there were a few in those days, had time to make home-made telegraph sets, and bladder-skin telephones, but not I.

"I had to work and work hard. I never learned how to play. As time passed I married, brought up my family and that kept me busy, so busy I had no time to play. I had one big aim, to see my children well started. Years passed, my children left one by one to begin

has opened a fascinating realm of study. I am reading up on the principles of electricity, the construction and action of storage batteries, the science of sound, the chemistry of light, Everything of a scientific nature is interesting to me now.

"And then there is the code. If any one tells you a man is too old to learn, tell him for me it is not so. Stir up the stagnant brain cells with something of absorbing interest and you *can* learn.

"The days are too short. I begrudge the hours I spend in sleep. I am so far behind in my play. Now I have so much in common with the boys of the neighborhood. Perhaps you think it more seemly that I should sit quietly on my porch in carpet slippers and skull

cap smoking a long pipe instead of playing with the boys. No, I forget I am old. I am always busy. I sing at my work bench. My heart is young. The boys come to me and we have good times, splendid times together. We speak the same language, a language of enthusiasm and happiness."

As he tied up his packages, I noted an eager-

ness in the movements of the old man. His eye sparkled with enthusiasm. There was a faint flush on his wrinkled cheek, and under his coat beat the heart of a boy. We took leave of one another, and went our separate ways. I felt that I had received adequate answer to my question, "Do you find radio an interesting pastime? and if so, why?"

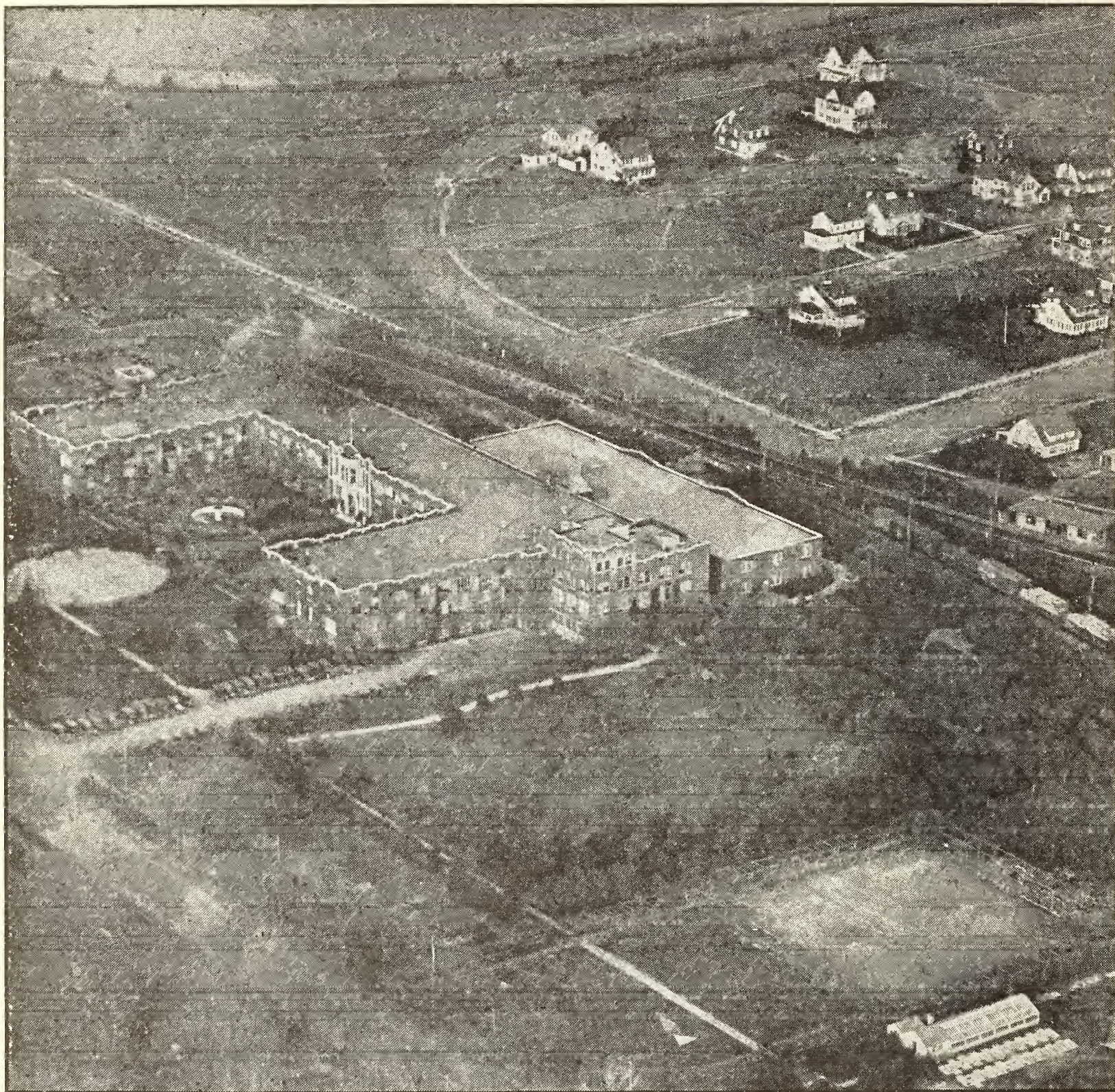

#### THE CENTER OF ACTIVITY IN THE RECENT TRANSATLANTIC BROADCASTING TESTS

Airplane view of the Doubleday, Page & Co. offices and plant (Country Life Press) and gardens. The diminutive building just to the left of the greenhouse, at the lower right, is the new RADIO BROADCAST laboratory. Here, during the week of the tests, the super-heterodynes and a six-tube reflex set were used in hearing England. Here also were received, by telephone and telegraph, messages from hundreds of American listeners-in who themselves heard England. A direct wire from the laboratory to the Radio Corporation's "Radio Central", at Broad Street, New York, controlled the transatlantic radio telegraph circuit. Informing London how the British broadcasting stations were coming in was thus a matter of seconds. (The editorial office of this magazine is in the right inner corner of main building. Telephone and buzzer lines connect the office and the "shack")

# How Loud Shall the Loud Speaker Speak?

By R. H. MARRIOTT

Radio Aide, United States Navy, Bremerton, Washington

**I**N THE dining, dinning or dancing room of a certain popular United States city hotel, several young fellows with slick hair and urban manner supply power intermittently to saxophones, drums, horns, pieces of wood, pieces of metal, and a piano. The room is full to overflowing with the sounds they produce.

Twenty miles away, at the end of a trail and between hills, in a little clearing in the big timber, is a log cabin. There, the finest phonograph records are played with a very soft fibre needle. There are woods sounds and a babbling brook. There is no din. And there are many who walk miles to enjoy that place.

I live between those two places and hear radio broadcasting, and hear criticism of what broadcasters broadcast, and criticism of what loud speakers speak.

Some criticisms deal with the subject of loudness. For example the Watts family has the Listener family in to hear their radio, and the next day Mrs. Listener remarks to a neighbor that the Watts's radio loud speaker is too loud, and Mr. Listener tells his fellow men that the Watts's radio is mighty noisy. On the other hand some listeners are dissatisfied with other radios because the sounds are too faint.

"What is normal loudness?" is often asked. A good answer is: "Conversational loudness is normal loudness." A good rule is to adjust the radio equipment so that the broadcast announcer talks as loudly through the speaker as he should talk if he himself were in the room.

In the quiet home, very little power is required to bring the sound to the ears at conversational loudness. In a boiler shop conversational loudness needs to be as loud as in a quiet place, and must also be as loud as the boiler shop noises. In the boiler shop, the ears are strained and the voice is strained. The sound is painful and the producing of the sound waves is painful.

Loud speakers should not be operated in a

way that pains the listeners and strains the radio equipment. If the loud speakers are operated in a noisy place, they must be operated louder than the noises. In trying to make the broadcast louder than the local noises the radio and sound equipment may be strained so the equipment adds squeaking or sputtering sounds. Usually the next step is to make the speaker speak still louder so the broadcast that the speaker gives out, added to the noise it gives out, are together very much louder than the local noises, and then the broadcast is heard. That hearing is sometimes a painful process.

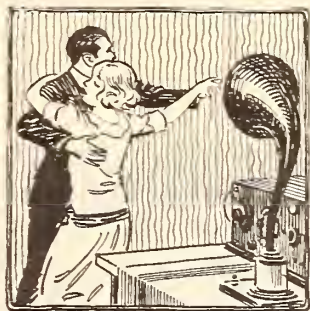

The tendency to overcome local noises by making a loud speaker speak louder is wrong because instead of securing pleasing sounds, that method, if pursued far enough, will certainly produce painful loudness. If the same amount of effort, thought, and money are applied to eliminating the local noises, better results should be obtained. Closing a door will sometimes shut out more noise than one amplifier could overcome. And if the broadcasting station is close enough, a crystal detector can furnish power enough to give pleasing results in a soft walled room.

Not only is painful loudness sometimes the result of attempting to drown out interfering loud noises, but painful loudness and straining of receiving equipment is sometimes the result of attempting to overcome reflection of sounds. For example: If part of the sound from the speaker comes direct to the ear while another part of that same sound goes direct to a hard surface and is there reflected to the ear, that reflected sound is usually an interference. The reflected sound has traveled farther and therefore does not enter the ear with the same sound it started with. It more or less deforms the direct sound that is entering the ear when it gets there. If all of the sound given by the speaker is small, then the undeformed difference between the strength of the direct sounds and reflected sounds may be too small to be

intelligible. By increasing all of the sound from the speaker the difference between the direct and reflected sound may be made intelligible, but the total loudness may be painful and the radio receiving equipment may be strained.

Glass in windows reflects or transmits nearly all of the sound that strikes the glass. The glass windows let in noise interference from the outside and produce reflection interference inside. Open windows produce no reflection, but let noises come in. Double glass with a dead air space between will cut out much of the interference from the outside, but the inside glass will reflect. Soft, thick, closely knit curtains will reduce the noises from the outside and reduce the reflection inside. Noises may be prevented from entering through a ventilation opening by hanging a heavy curtain, that is broader than the opening, in front of the opening and a few inches from it.

Hard, smooth plaster walls and ceilings usu-

ally produce the most reflection and interference because of their size. Soft paper or cloth having a deep soft surface like blotting paper or felt will reflect very little sound.

Any hard, smooth surface is a sound reflector which usually produces interference, while soft material like upholstery, felt, or shoddy absorbs sound and prevents interference. Any hard and rough surface reflects but it reflects from many adjacent angular surfaces and does not produce much interference, because the reflected sound waves are thrown into each other contrariwise and neutralize themselves to a considerable extent before they reach the ear.

Painful loudness can usually be avoided by choosing the room with the softest lining for your loud speaker, by cutting out and shutting out local noises, by selecting for reception a broadcasting station that is near enough to give too much volume, and then by cutting down the volume here and there until the announcer talks like a gentleman.



SEEK RELIEF FROM CODE INTERFERENCE

Representatives of the *Boston American*, the National Association of Broadcasters, and the Radio Club of America called on the President suggesting that commercial traffic be abolished on 450 meters—that more funds and increased personnel be granted the Department of Commerce for radio—that the radio laws of 1912 be brought up to date by revision. Left to right, Walter Howey, Managing Editor, *Boston American*; George Burghard, President, Radio Club of America; J. V. L. Hogan, Radio Club of America; J. Shephard, Vice-President, National Association of Broadcasters; and Paul Godley, Radio Club of America

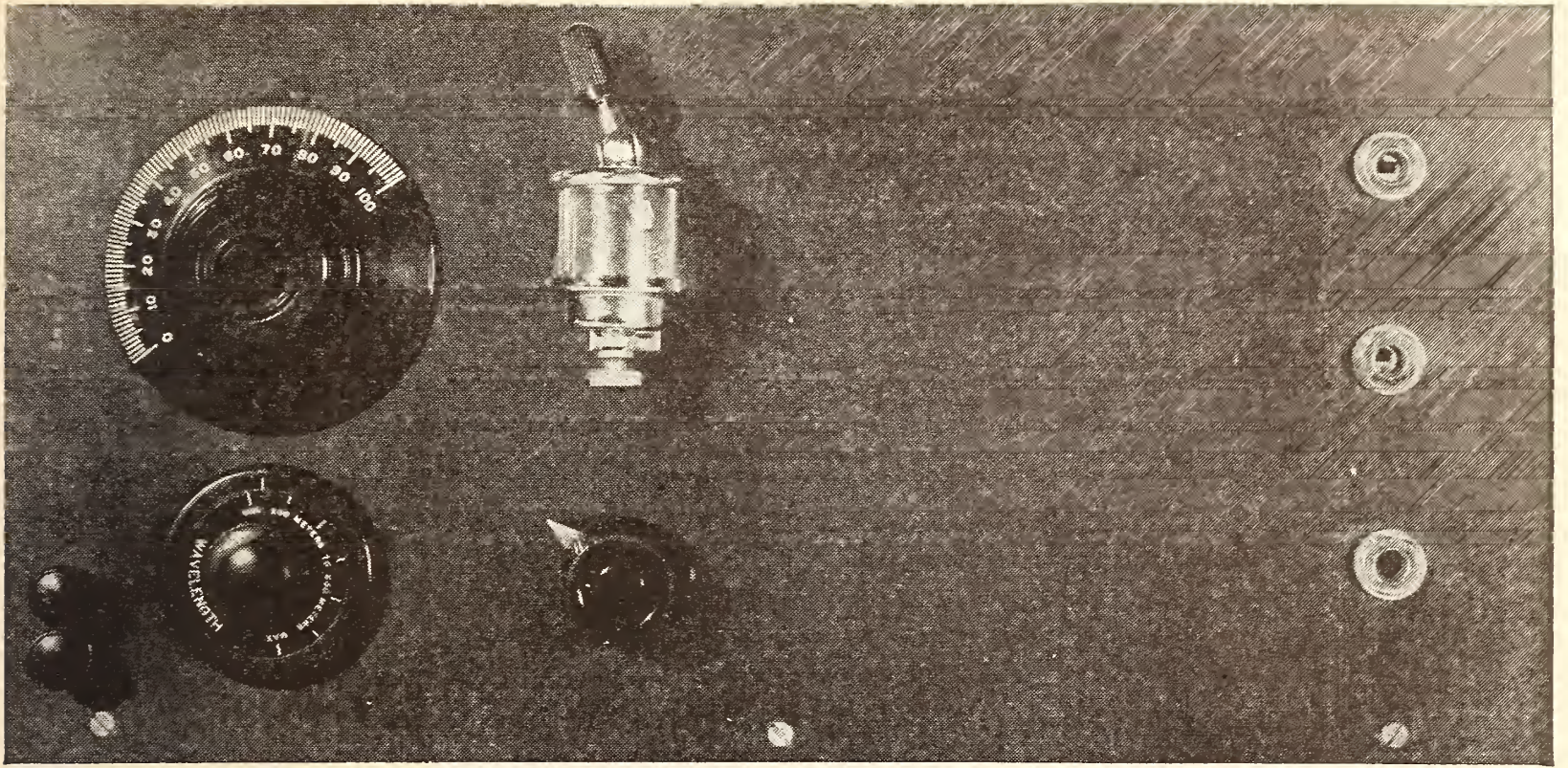

THE RESULT OF CAREFUL WORKMANSHIP  
Front view of the reflex set described below

## A “Knock-Out” 3-Tube Set

### A “How To Make It” Article

**E**VER since the publication in the November RADIO BROADCAST of the “knock-out” one-tube set developed by Mr. Kenneth Harkness, enthusiastic readers, sensing the possibilities of further amplification, have clamored for the addition of two audio stages. Many have added a single stage successfully, as suggested in this magazine. However, the addition of the ultimate second external step has been made impossible by howling, on which the usual remedies of grid biasing, the lowering of plate voltage, the mounting of transformers at right angles, and the use of separate A and B batteries have had little or no effect. These are methods of stabilization which are ordinarily effective in the correction of magnetic feed-back, that is, the interlocking of magnetic fields, resulting in undesirable induced effects.

Investigation in the RADIO BROADCAST laboratories showed that the feed-back in the case under discussion was almost entirely capacitive—capacity between the exterior amplifier and the reflex part of the circuit through ex-

ternal objects, such as the operator, near-by electric wiring, etc. When the phones were used on the last or second stage, the receiver squealed loudly when the tuning dials were approached but the squealing ceased the moment the operator was grounded. Shielding will probably suggest itself immediately to the prospective builder as the obvious solution, but, in many cases, it will be only partially corrective. Perhaps, if the complete set were boxed and paneled in metal, the howling tendency would be totally eliminated, but this, as experiments have shown, tends to lessen the rectifying effect of the detector—probably through capacitive bypass.

The solution of the problem was found in the RADIO BROADCAST laboratory, by localizing the difficulty, and applying what is probably the effect of shielding, to the localized area. The grid of the second tube (the first external amplifier) appeared to be the crux of the situation, and a small condenser, C<sub>2</sub>, connected between this grid and the ground, completely and definitely eliminated the howling. In

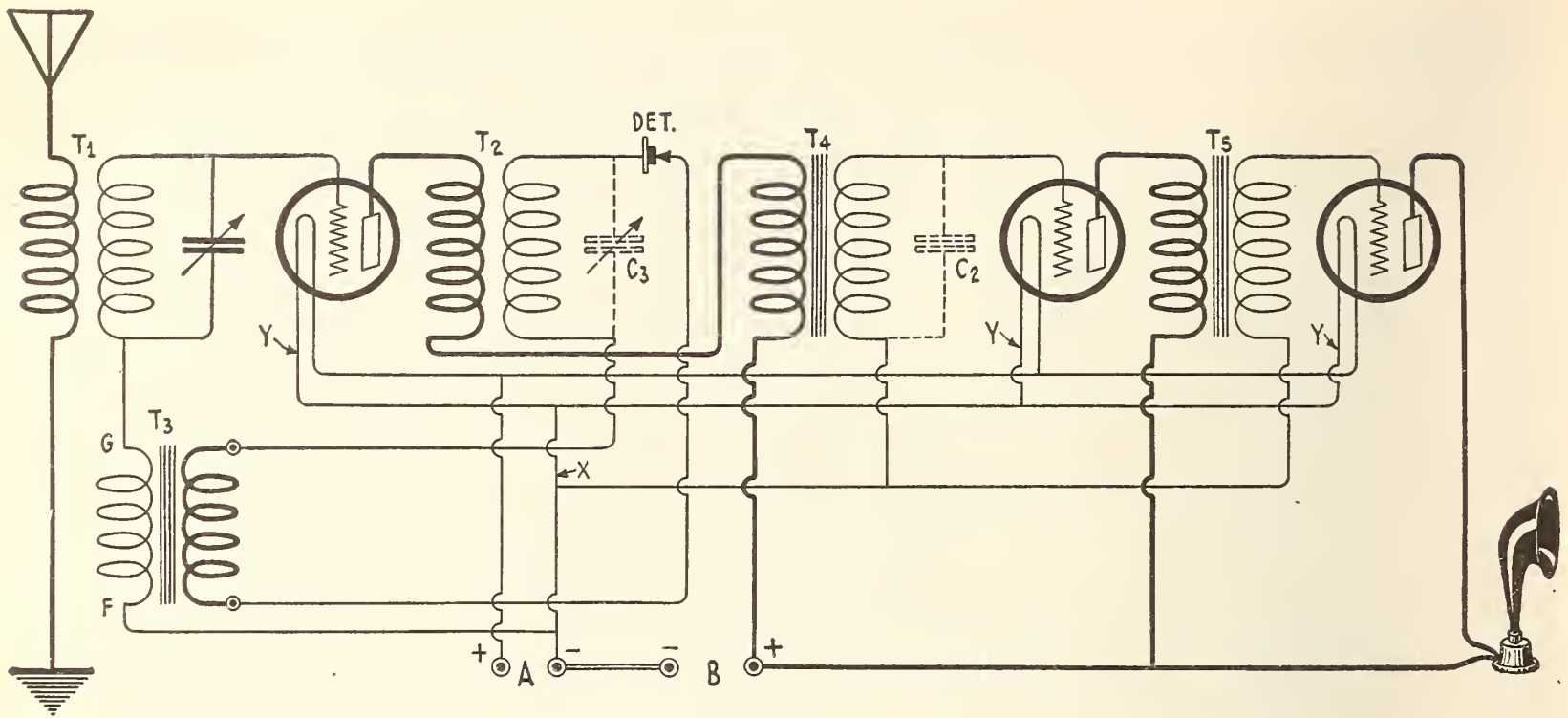

FIG. 1

The "Fundamental Circuit." Build your set with this as a basis if you do not care to follow explicitly the instructions given by the writer, or if you cannot obtain the parts designated. You may use such rheostats, jacks, transformers, etc., as you have on hand and as are within the latitude always allowed the constructor

this particular, and rather unusual connection, there exists also, perhaps, a neutrodyning effect—the system applied so successfully to the elimination of capacity phenomena in radio frequency amplification.

#### THE CIRCUIT

**WE** HAVE drawn up for the benefit of our readers, two circuits, the fundamental circuit, Fig. 1, and the specific circuit, Fig. 2. The fundamental circuit, which we shall first consider, is the basis on which the majority of enthusiasts, who are unable to obtain the exact instruments used by RADIO BROADCAST in building the set, must work.

T<sub>1</sub> and T<sub>2</sub> have been described in detail in the November RADIO BROADCAST, and a very interesting variation, the use of spider-webs, is covered in the "R. B. Lab." Department for this issue. If a homemade T<sub>2</sub> is used, the tentative condenser, C<sub>3</sub> capacity, .0005, will be necessary. If a Ballantine Varioformer is employed, this condenser is done away with. The audio transformers, T<sub>3</sub>, T<sub>4</sub>, and T<sub>5</sub> may be any reliable make, such as Acme, Federal, Amertran, etc., with a ratio of approximately five to one. The same make or type of transformer need not be used throughout the circuit. "Det." represents any good crystal detector.

C<sub>2</sub> is the anti-capacity condenser, and should be as small a capacity as is effective. Generally a .0005 Micadon suffices. This condenser, incidentally clears up other objectionable noises,

and noticeably reduces A. C. induction from near-by lighting wires (electric lights in the vicinity of the operating table, etc.). In a few instances, and with some tubes, this condenser may be unnecessary.

No rheostats are shown in the fundamental circuit. If UV-199's are used, and a steady three-volt source is available, the filament adjustment may be eliminated. If the builder desires to use individual rheostats, one for each tube, they will be connected in the filament circuit at "Y". If a single rheostat is decided upon, as is most likely, it should be inserted at "X". In all cases of resistances, it will be noted that the secondaries of the external audio transformers are brought down to the battery side of the rheostats. This places a desirable negative potential on the grids.

No jacks have been indicated. The constructor may use any type he possesses, or can obtain conveniently, filament control or otherwise. Various types of jacks have been pictured and described in the April issue of RADIO BROADCAST. While jacks are of course advisable, the set will function at all times on the last amplifying stage.

#### THE SPECIFIC CIRCUIT

**T**HE set as built by RADIO BROADCAST employed the T<sub>1</sub> exactly as described in the November issue. T<sub>2</sub> is a Ballantine Varioformer. T<sub>3</sub>, T<sub>4</sub>, and T<sub>5</sub> are Amertran transformers. Standard sockets (De Forest) were



used with adaptors for the UV-199's, for which tubes this particular set was designed. A single ten-ohm rheostat controls all tubes through filament lighting jacks of the most easily obtainable type. C<sub>2</sub>, the anti-squeal condenser, is a .0005 Micadon. The detector is a De Forest stand with a Fada cat-whisker and arm. Forty-five volts were used on the plates of the tubes, and four and a half volts on the filaments.

#### BUILDING THE SET

OUR first experiments with this apparatus were conducted with the set built up on a base-board, as shown in Fig. 3. Such temporary construction is always a good idea, and is invariably followed by veteran experimenters. It facilitates various tests, and makes possible the definite designing of the ultimate apparatus. The base-board measured sixteen by ten inches, and Fig. 3 shows very plainly the distribution of the instruments. It will be noted that, even in the temporary installation, wiring has been done with at least a semblance of care. Neat wiring consumes a bit more time, but it is worth the extra trouble. In the case of inoperation, it eliminates careless running of leads as a possible and frequent source of difficulty.

Figs. 4 and 5 show the completed set of so simple design that any one can follow our instructions. It was with simplicity in mind that RADIO BROADCAST has eliminated all constructional gymnastics, such as shelves, brack-

ets, etc., which often strain the ability of the average fan. Straight base and panel mounting has been adhered to throughout, with the possible exception of T<sub>1</sub>, which may be mounted on a three inch square shelf resting on top of the reflex audio transformer, if the experimenter is unable to accomplish the feat of securing it to the variable condenser.

Fig. 6 is a working drawing of the panel. The comparatively large hole,  $1\frac{3}{4}$  inches in diameter, passing the Ballantine Varioformer (which should be of the panel mounting type) is made by drilling a circle of small holes.

The base (see the insert of Fig. 6) is 13 inches long, six inches wide, and  $\frac{3}{4}$  inch thick. This thickness makes a firm support for the panel which is fastened to it by three screws,  $\frac{3}{8}$  inch up from the bottom. This, in conjunction with rigid wiring, holds the panel quite firmly. The base, one inch shorter than the panel, makes possible the use of a cabinet with grooved sides into which the panel is slid.

Fahnstock clips have been employed for the battery connections, and are screwed to the rear of the base, between the audio transformers as shown in the insert. "A" indicates the A battery terminals and "B" the high voltage connections.

#### CONSTRUCTION HINTS

THE panel should, of course, be drilled, grained if desired, and fastened to the base-board as the first step in construction. All panel instruments, C<sub>1</sub>, T<sub>1</sub>, T<sub>2</sub>, detector,

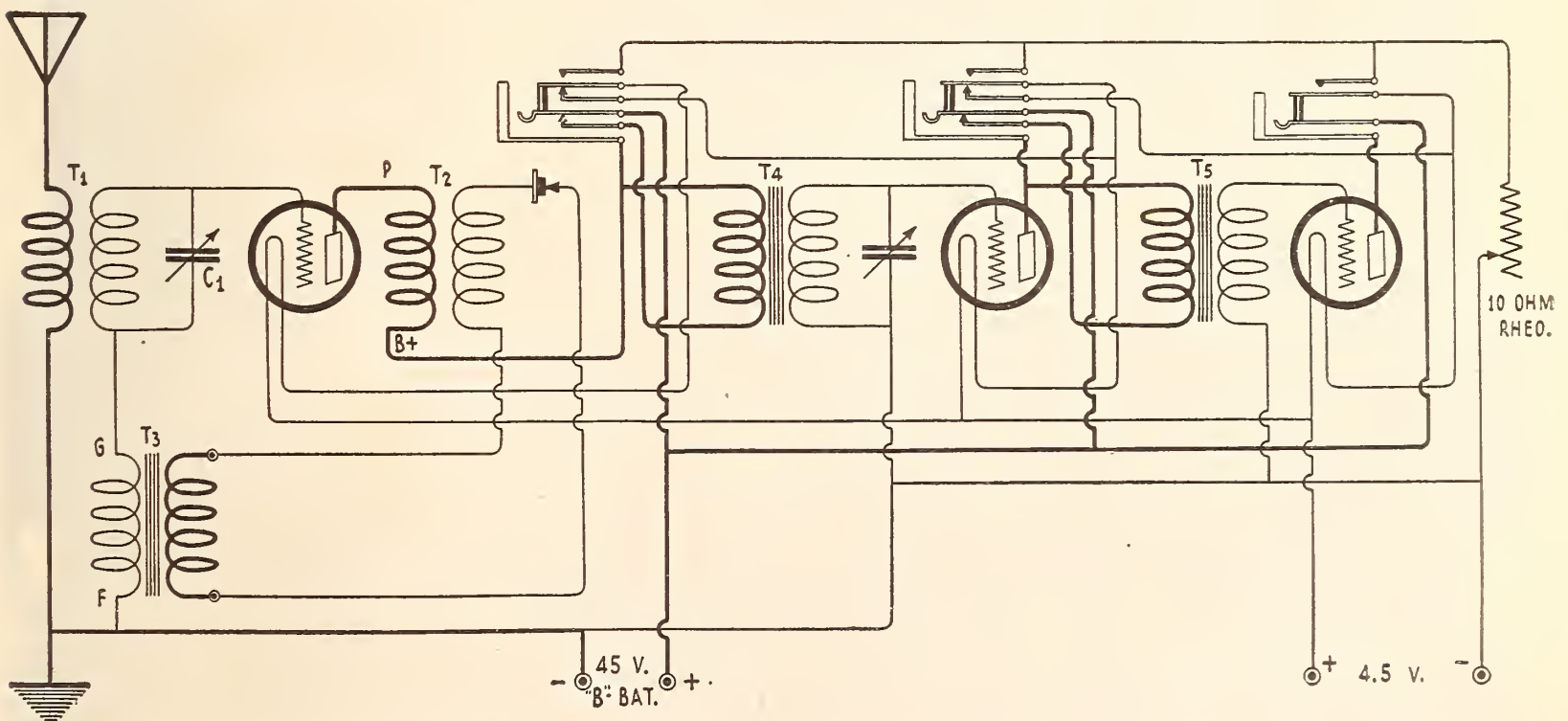

FIG. 2

The "Specific Circuit." This is the modification of the fundamental circuit used by RADIO BROADCAST in building the set described

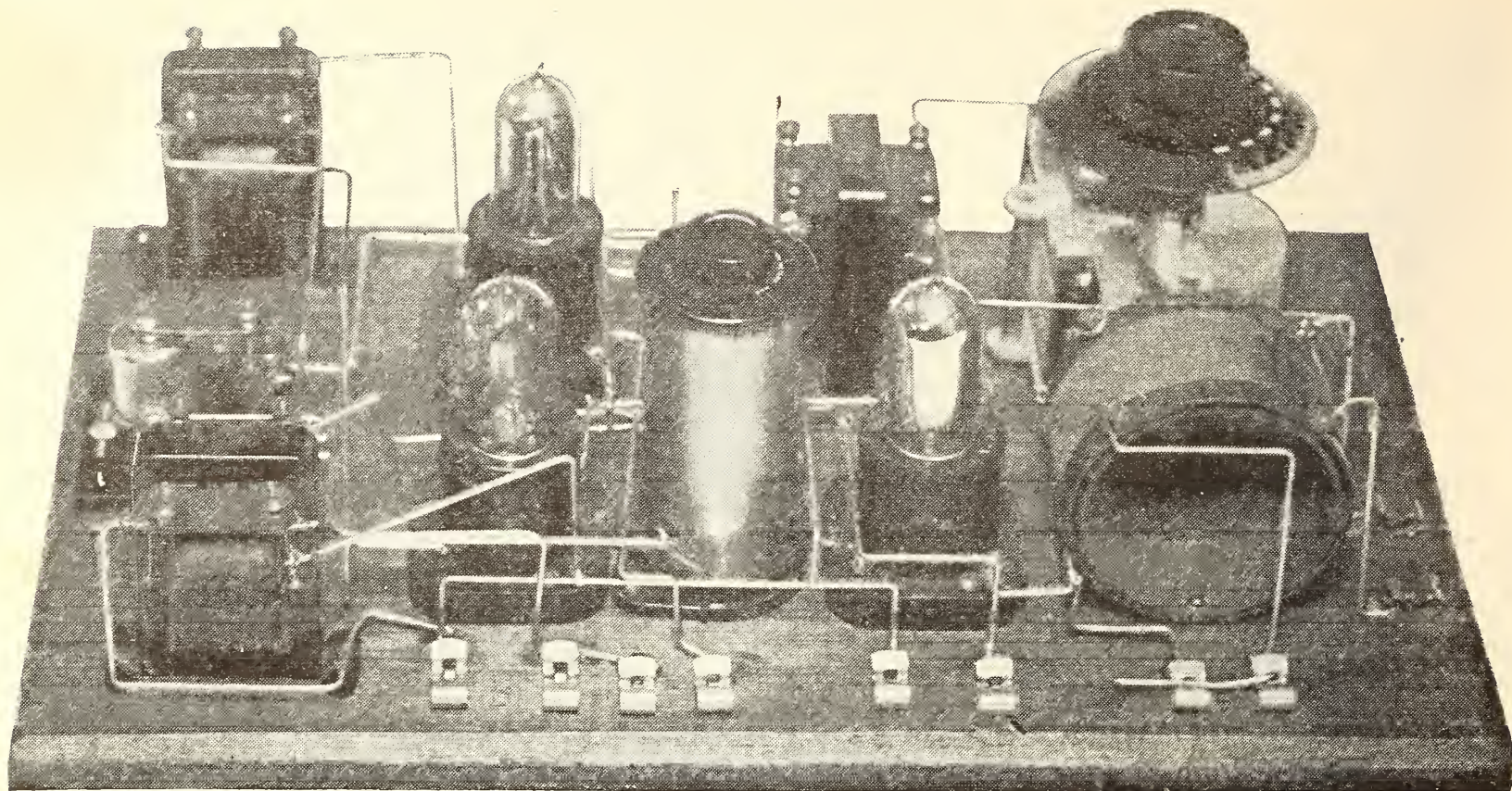

FIG. 3

The temporary set, built up on a base-board, where it was completely tested, and when it was proved satisfactory it was properly wired on the panel, as seen in Fig. 4

rheostat and jacks, and antenna and ground binding-posts, are next mounted, along with the sockets and  $T_3$  on the base. The positive filament connections on the sockets are wired with a single straight piece of bus-bar wire, and

the connections of the reflex or tuning circuit are made complete.  $T_4$  is next mounted, along with the Fahnstock clips, two on each side. All filament control connections are now made, as well as those to transformer  $T_4$ .

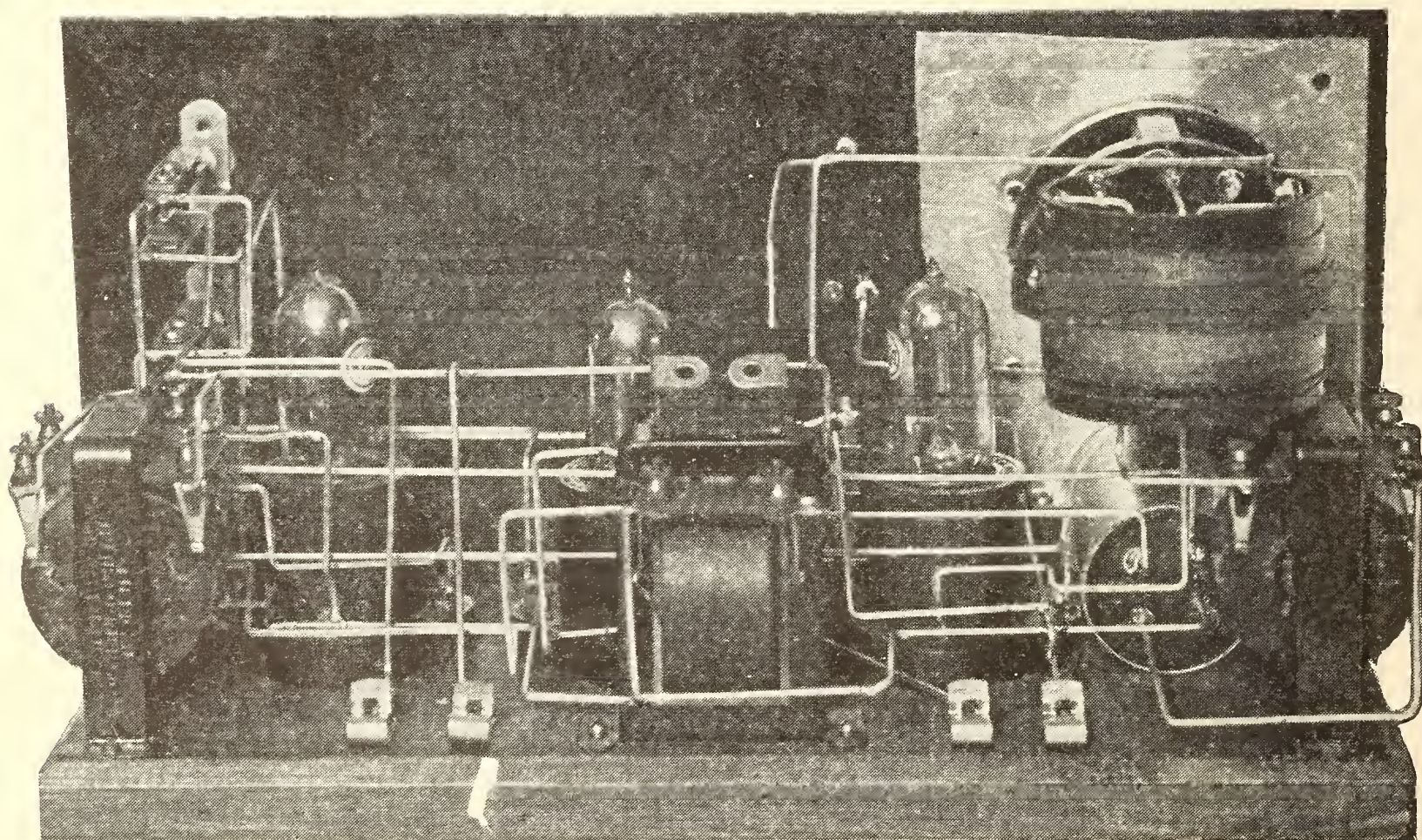

FIG. 4

Rear view of the completed set. Note the neat wiring, and the partial shielding

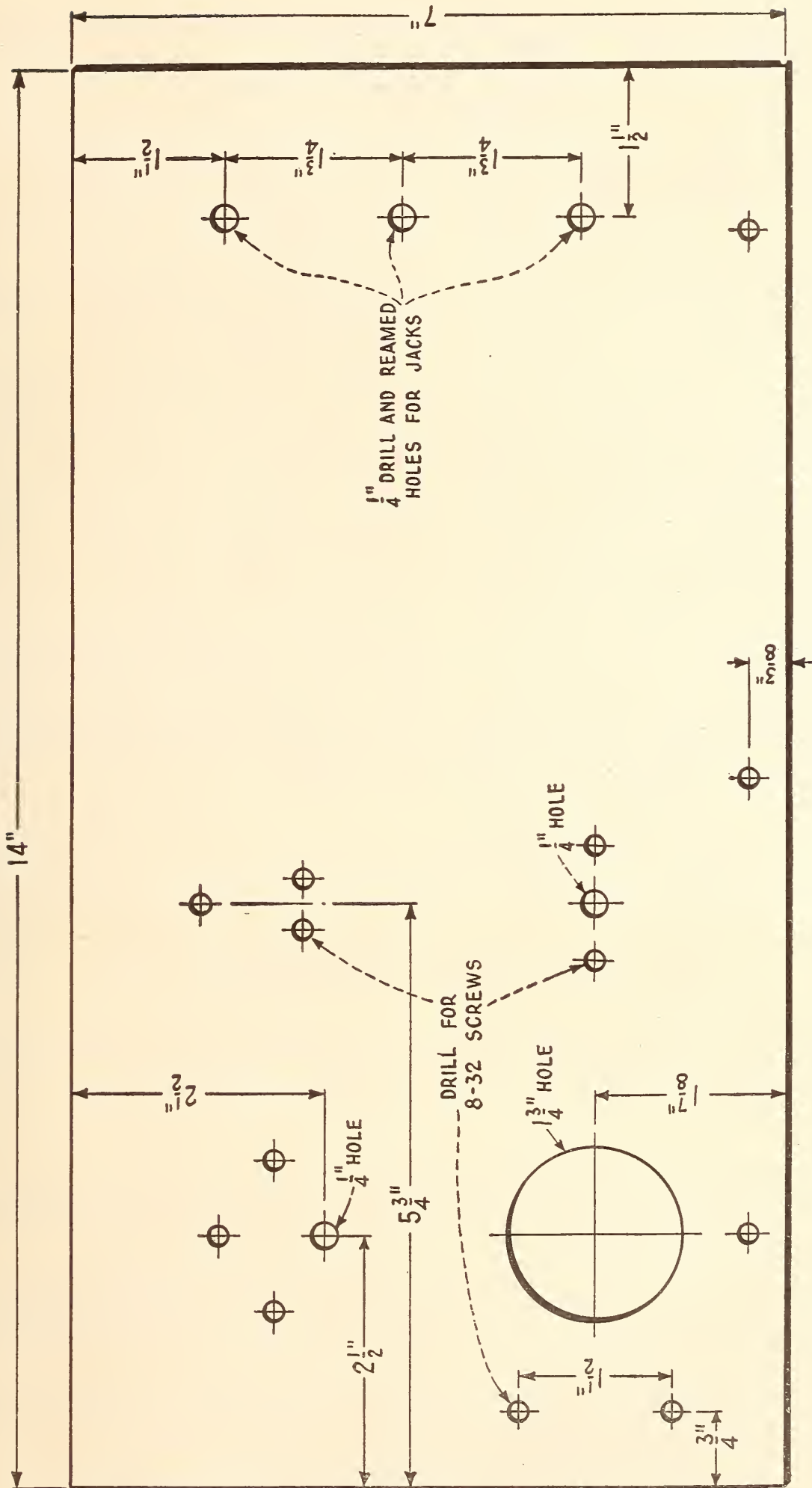

FIG. 5  
Working drawing of panel, half actual size

Allowance in wiring the jacks must be made for the position of T<sub>5</sub>, which is the last instrument mounted and wired. It is suggested that wiring be done with bus-bar or hard-drawn copper wire, avoiding all types of insulation. Wiring, for the sake of neatness and efficiency,

should be run straight and with right angles, and, needless to emphasize, all joints soldered.

Shielding may be used, and in some cases it may eliminate the necessity for the anti-capacity condenser, C<sub>2</sub>. However, it is suggested that the shielding be localized, and only

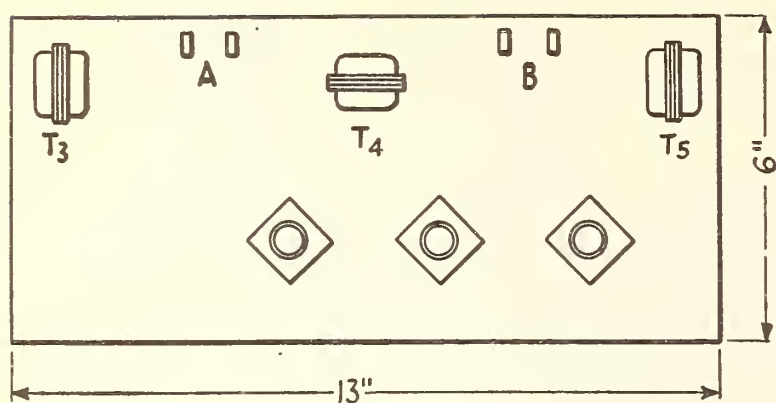

FIG. 6

Showing arrangement of units on the base

that one third portion of the panel on which the tuning elements are mounted be protected in this way. The shield is connected to the case of the Ballantine Vario transformer under the clamp which holds both the transformer and the shielding in place. The shielding is not grounded.

#### RESULTS

THE set, as shown in Figure 4, is the best dry cell equipment that ever has been brought to the attention of the writer. It is

remarkably sensitive, and will bring in distant stations on the loud-speaker. During comparative tests in New York City, Chicago was received on this little set, with greater intensity than on one of the most efficient regenerative receivers made. The regenerative set was using storage battery tubes, detector, and two steps, with one hundred and thirty volts on the plates of the amplifying tubes. The reflex set employed the same number of UV-199's, with a plate voltage of forty-five.

The second stage of external amplification is never necessary for loud-speaker reception of local signals, and, in the case of the UV-199, which is limited in the amount of power it can handle, will give only a slight additional amplification, and will probably distort signals.

The possibilities of this remarkable little set as a portable receiver need no delineation. Its sensitivity is such that it will operate on the most makeshift of antennas, such as 125 feet of wire thrown over the limb of a tree (*a good ground, however, must be used*), and the necessary batteries add but little to the bulk and weight.

## If You are Thinking

*Of submitting an article to RADIO BROADCAST, you may save yourself and the editors time and trouble by considering the following notes as to what we want and what we cannot use:*

#### WE WANT:

*True accounts of the uses of radio in remote regions.*

*Short, true stories of adventures in which radio played an important part: unusual and interesting occurrences to you or your acquaintances.*

*Clear explanations of new or especially effective circuits or uses for apparatus.*

*Concise and logical discussion of some important problem or phase of radio, whether in the field of broadcasting, constructing, operating, buying or selling; or of reading or writing that has to do with radio.*

*True accounts, of some particular interest, relating "What Radio Has Done For Me."*

*Humor, when the object is not merely to appear funny, but to present some phase of radio in an attractive, amusing way. The same applies to drawings.*

*Clear, unusual photographs are always in order, as are good circuit diagrams.*

*A liberal rate is paid for material used.*

#### WE CANNOT USE:

*Fiction, unless it deals in a striking way with some subject of interest to those interested in radio.*

*Articles or illustrations to which RADIO BROADCAST would not have the exclusive rights.*

*The best way to do is to read several numbers of the magazine to get an idea of the various kinds of articles we publish.*

# The Right Insulator in the Right Place

The Best Kinds to Use for Cabinets, Coils, and Condensers

By PAUL MCGINNIS

**T**HE builder of a radio set thinks first of all of conductors, proper sizes of wire, and proper connections and is likely to overlook the fact that without insulators there could be no conductors. He knows in general that a rubber composition is better than wood for making panels, but he may ruin an otherwise good set by overlooking smaller details of insulation in out-of-the-way places behind the scenes.

The only difference between conductors and insulators is in their resistance to electrical current. In the class of materials called conductors, the cohesion between the atoms and their electrons is considered to be overcome more easily by electrical pressure than in the materials called insulators.

The vast difference in the common kinds of insulation is particularly important in radio where alternating currents of high frequency are used, and especially in transmitting apparatus where high voltage is employed. The problem of covering coil windings with a proper insulating compound is one which presents itself to the amateur at an early stage in his radio progress. He wonders whether he should use paraffin or shellac. The paraffin will rub off more easily, he thinks, and decides to use shellac, perhaps, because it is a "good insulator." Shellac is in fact a "good insulator," since one cubic centimeter has a resistance of millions of millions of ohms; but a glance at the accompanying table will show that paraffin may have more than 500 times the resistance of shellac! A coil wound with cotton-covered wire and dipped in paraffin is usually well insulated.

Sealing wax is good for fastening wires in place and generally for use where large quantities are not required. It remains firm and is easy to apply. It has a much higher resistance than beeswax or other ordinary waxes which the amateur is tempted to use.

Where large quantities of wax-like material are required, sulphur can be used to advantage.

It is much better than sealing wax, as the table indicates. It may be better than ordinary paraffin and is much more durable where it is exposed to wear.

A beautiful panel can be made of wood, and its possibilities are tempting to the novice. When he hears of the high prices quoted for patented panel material, he has another argument in favor of wood.

If he does use wood, he should select the hardest available and give it a thorough painting with hot paraffin (hard wood like mahogany is best and is quite practical); but the best panels are made from rubber or some chemically-prepared insulating material. Hard rubber is one of the best insulators known, being superior even to porcelain or glass. Mica or moulded mica can be used to advantage for insulating small parts.

Climate may well be considered in addition to these fundamental characteristics of insulators, since both temperature and humidity change the resistance materially, and may make considerable difference in the operation of a station.

A change of ten degrees in temperature may make a change of sixteen times the original resistance of a substance such as beeswax. Sealing wax is one of the most stable insulators at normal temperatures, but all insulators are affected by heat. In government experiments, it was found that bakelite had 300 times as much resistance at 25 per cent. humidity as at 90 per cent. Such substances as marble, slate, and hard fibre, which are slightly porous, are also affected, but to a lesser degree. Although shellac absorbs much moisture, its resistance changes little with humidity.

## SURFACE LEAKAGE

**O**NE of the chief causes for changes in the resistance of materials with humidity is surface leakage. This is an important consideration when choosing insulators for use in humid climates. The surface leakage is not caused

by the material itself so much as by the film which accumulates on it. The film is composed largely of moisture condensed from the humid atmosphere. In general, hard substances have more surface leakage than soft substances. At high humidities, there may be a change of ten per cent. on account of surface leakage, and this deficiency lasts for several hours and sometimes as much as a month after the humidity is lowered.

Since good oil is one of the best insulating materials, it can be used to advantage in many places. When moisture meets an oily surface it tends to collect in drops which otherwise might spread over the surface and cause a filmy leakage path.

Air is an insulator, but is not so good as the ordinary solid insulators. Where bare conductors come close together they should be kept apart by some solid insulating substance.

In the case of condenser action, insulators exhibit another property quite out of proportion to their insulating power. It is called the dielectric constant and must be considered when building a condenser. Air is taken as the unit of measurement in the accompanying table and the constants of other materials are figured in proportion to that of air:

TABLE\* OF COMPARATIVE RESISTANCES OF VARIOUS INSULATORS TO HIGH-FREQUENCY CURRENTS

The figures given must be multiplied by 1,000,000,000,000 to find the ohms resistance of a cubic centimeter.

Amberite . . . . .	50
Bakelite . . . . .	.004-20
Beeswax . . . . .	2
Celluloid . . . . .	.00002
Condensite . . . . .	.00004
Dielectrite . . . . .	.005
Electrose . . . . .	.1-20
Fibre, hard . . . . .	.00002
Fibre, red . . . . .	.000005
Glass . . . . .	.001-.05
Halowax . . . . .	.02-20
Hard rubber . . . . .	1000
Marble . . . . .	.000005
Mica . . . . .	2.-200
Paraffin, special . . . . .	over 5,000
Paraffin, ordinary . . . . .	10.-100
Porcelain . . . . .	.3

\*Prepared by the Bureau of Standards

Quartz . . . . .	over 5,000
Redmonite . . . . .	.2
Rosin . . . . .	50.
Sealing Wax . . . . .	8.
Shellac . . . . .	10.
Slate . . . . .	.0000001
Sulphur . . . . .	100.
Wood, mahogany . . . . .	.04
Maple . . . . .	.00003
Poplar . . . . .	.0005

TABLE SHOWING CHANGE OF RESISTANCE WITH TEMPERATURE

These figures show the ratio of the resistance at 20 degrees Centigrade to that at 30 degrees, based on experiments of the Bureau of Standards.

Sealing Wax . . . . .	.9
Mica . . . . .	1 to 2.
Shellac . . . . .	1.5
Celluloid . . . . .	1.8
Parawax . . . . .	2
Bakelite . . . . .	2.4 to 3.6
German glass . . . . .	2.5
Red fibre . . . . .	2.6
Hard fibre . . . . .	3.2
Plate glass . . . . .	3.2
Paraffined wood . . . . .	3.6
Beeswax . . . . .	16.

TABLE OF DIELECTRIC CONSTANTS AS USED BY THE SIGNAL CORPS

The capacity of a condenser using various substances as the dielectric is given in ratio to the capacity of the same condenser using air as the dielectric.

Air . . . . .	1.
Glass . . . . .	4 to 10
Mica . . . . .	4 to 8
Hard Rubber . . . . .	2 to 4
Paraffin . . . . .	2 to 3
Paper, dry . . . . .	1.5 to 3
Paper, treated as used in cables . . . . .	2.5 to 4
Porcelain, unglazed . . . . .	5 to 7
Sulphur . . . . .	3 to 4.2
Marble . . . . .	9 to 12
Shellac . . . . .	3 to 3.7
Beeswax . . . . .	3.2
Silk . . . . .	4.6
Celluloid . . . . .	7 to 10
Wood, maple, dry . . . . .	3 to 4.5
Wood, oak, dry . . . . .	3 to 6
Molded insulating material, shellac base . . . . .	4 to 7
Molded insulating material, phenol base (bakelite) . . . . .	5 to 7.5
Vulcanized fibre . . . . .	5 to 8
Castor oil . . . . .	4.7
Transformer oil . . . . .	2.5
Cotton seed oil. . . . .	3.1

# I Had to Tell It

How Poetry and Vocal Salesmanship Combined to Make a Radio Newspaper Pay on the Great Lakes

By WILLIS KINGSLEY WING

**I** DOUBT it," said the Superintendent. "You can't make a wireless newspaper go on the Lakes, even if you have got the longest run out here. Your passengers won't be interested in a daily paper when they are out for a pleasure cruise. This isn't salt water."

"But," I interrupted, "we have them for nine days and the trip is nearly 2,400 miles long. Buffalo to Duluth and back, you know."

It was a warm day in early June and the Superintendent was in a hurry. He relented. "All right, go to it," he said. "Get your assignment slips for your vessel and hop down and convince the steamship owners. You haven't much time. Your ship sails in two days."

I got out of the wireless company's office, and past the long line of operators waiting assignment in the "static room" as quickly as I could. The battle was nearly won.

The steamship people weren't nearly as hard to convince, and in an hour we had all arrangements made. The arrangements for that paper—grandiloquently named the *Great Lakes Radio News*—cost me one luncheon and two special-delivery stamps. I submit that to the promoting people as about the last word in low "first costs."

Wireless papers had been tried on the Lakes before and had failed. One of the first was printed on the SS. *South American* during the exciting days of 1914. My junior operator and I had the job of making a radio newspaper

bloom where radio newspaper had never bloomed before.

We issued no metropolitan daily of 48 pages. Ours was a simple four-page affair, but it was all news. First we had the latest weather forecasts which came in by radio from the Canadian and American stations and then we featured the baseball scores. Five hundred words of condensed press matter followed, which we copied from broadcasting stations and high-power code stations. And, honorably bringing up the journalistic rear, was the passenger list—a highly important item. Few papers can exist without a social column and the passenger list was our social department.

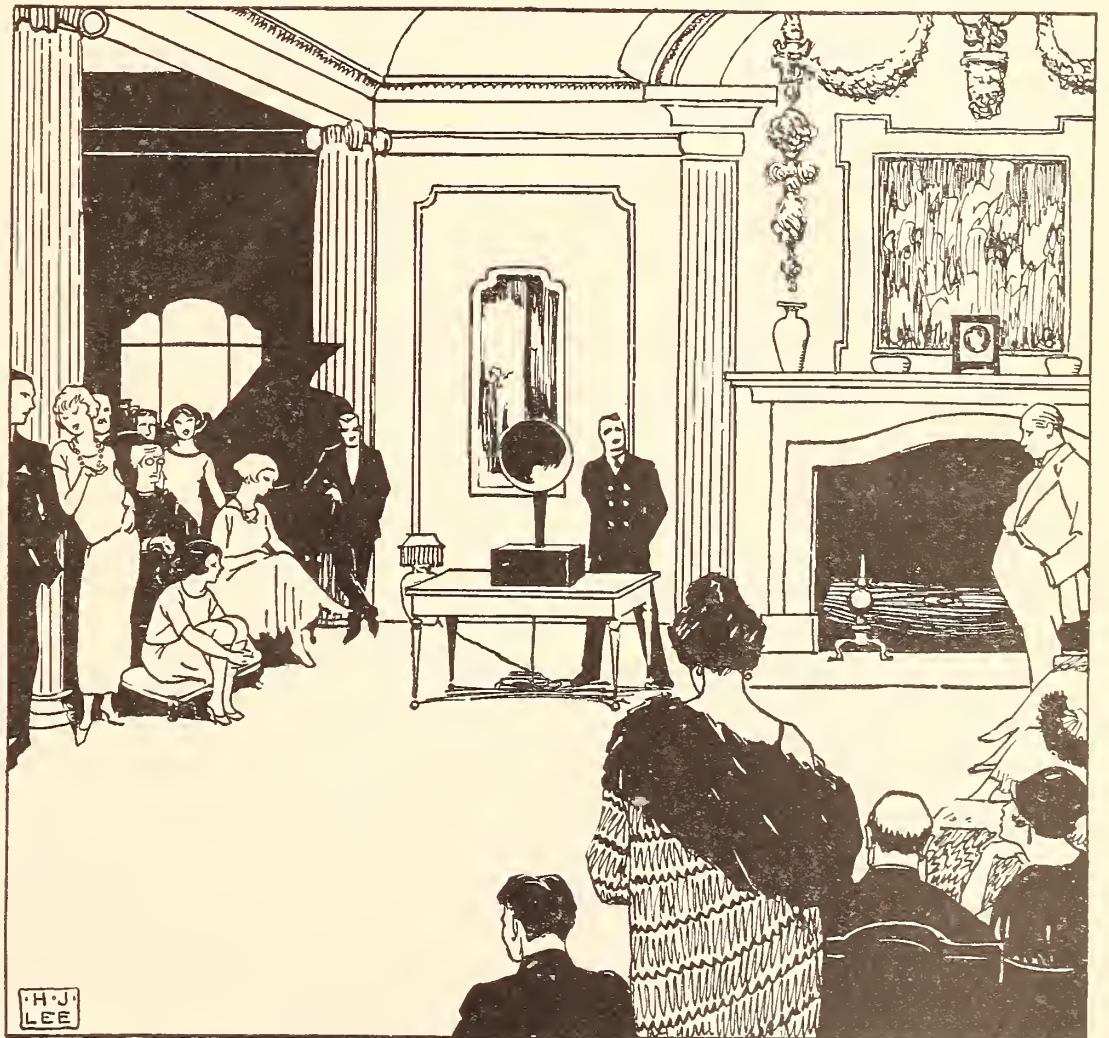

THE YOUTH AND BEAUTY OF THE SHIP GATHERED IN THE MUSIC ROOM

The insurance people especially were positively agog waiting for the address of their president, back in C. But in the radio cabin, there were smiles of another wavelength

**S·S·SOUTH·AMERICAN·NEWS**

VOL 1 NO 9 PUBLISHED DAILY AT WIRELESS OFFICE

ASSOCIATED PRESS DESPATCH FROM NEW YORK  
VIA MARCONI WIRELESS, CALUMET STATION

AUG 10

1ST EDITION

2 P.M.

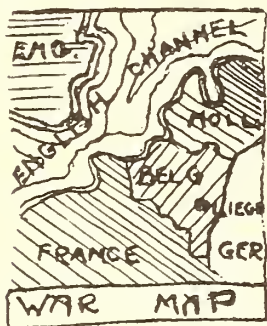
**GERMANS TAKE LIEGE**

BERLIN.....After several days of fighting in which every device of modern warfare has been brought into play and thousands of lives were given up before the blazing muzzles of the machine guns

Liege, so a dispatch from the Kaiser announces, is in the hands of the Germans. The capture of Liege by the Germans is the first decisive victory of the war, and if Germany is able to hold this point an entrance into France will be a comparatively easy matter

BRUSSELS.....Reports from many directions concerning the Liege fight, without exactly verifying the above news indicate that the German cavalry are forcing the French troops from their hard fought positions and are in possession of many strategic points

ROME.....Germany and Austria threaten Italy with a declaration that if Italy persists in her stand of neutrality, they will immediately declare war and Austria will invade Venetia and Lombardy, two Northern provinces Italy is deliberating

WEATHER report via Wireless from  
from Port Arthur

Lake Superior Strong west and Northwest winds. Cooler  
Fair Wednesday

ONE OF THE FIRST GREAT LAKES WIRELESS DAILIES

The edition was limited to fifty copies—the capacity of the hectograph on which it was printed

When does a wireless operator have time to gather and print the news, you are probably asking yourself. That is easy. Since we had the steamship company print the blank forms—with space left for the news and passenger list to be mimeographed in, we had no worry about elaborate printing machinery nor fear of strikes in the composing room. Reporters demanding an unholy increase in pay after making a big news “beat” bothered us not at all. Ours was a close corporation and we two could “point to ourselves with pride” as Editor, Owner, Publisher, etc.

Blithely, I undertook the task of preparing the news and cutting the stencils for the mimeograph machine with our radio typewriter-of-all-work. And during the dull hours of the dog watch, my junior printed our daily masterpiece.

So, promptly at 6, the first copies of the sheet were waiting the early rising passengers, out for a promenade before breakfast.

However, our first issue did not roll off the press as easily as we had anticipated. The occult ways of a mimeograph were new to us, the paper jammed in the rolls, and the ink got all over the deck of the radio cabin and ruined one rather handsome uniform. I wouldn't have minded that first attempt so much if it hadn't been for a couple of grinning sailors outside our door, intent on superintending our unheard-of operation.

After the first couple of issues had been printed and partially sold (they didn't go so well at first), our wireless-journalism combine learned several things. First, we needed an advertising department, a sales force, and some interested reporters to scour the ship for news.

The passengers were eager enough to help us gather news. My junior

and I passed the word to a carefully chosen few on the first trip, and after that it was easy. “Who is that fascinating-looking man?” some one asked me after we had established our paper firmly, by three successive and successful issues. The tip was passed to one of our star reporters, that bobbed-haired girl from Wellesley, I think, and in an hour we had unearthed the winner of a newspaper popularity contest in Wilkes-Barre, Pennsylvania. Oh, getting the news was easy.

But our “news” did not always prove to be accurate. A man came to the radio office with an item about a birthday party being held in Parlor M for Miss Gumble in celebration of her 21st birthday. Serenely, we printed it. The next day Miss Gumble descended on the editorial sanctum. Miss Gumble was plainly



40. I don't see yet why she was so disturbed; we said 21. Anyhow, her friends thought it a great joke and we sold that issue out entirely. Figure it for yourself at ten cents each. Our publishing costs were exactly nothing, because the steamship company furnished the paper and the mimeographs. The mathematics, if you insist: 1 social note = 150 papers = \$15.00. Easy.

The most consequential item we ever printed was probably the most innocent in intent. My watch at the key was nearly over, the paper was almost written, but at the very end was a disgusting gap. So in the "Ship Gossip" department, this harmless paragraph went in:

Shipboard conversational struggles are frequently difficult, and the *Radio News* is making its heroic struggle to aid the *Tionesta* traveling public to a way out. Any bona fide passengers (i. e., those who have paid their passage money and who can point to at least 8 laps around the deck per day) who submit five good conversational tags to replace the following will be given a year's free subscription to the *News*:

- (1) "Isn't it calm?"
- (2) "Have you walked your mile?"
- (3) "Do you like the water?"
- (4) "Don't you think ships are romantic?"
- (5) "Are you seasick?"

The next morning one hundred and fifty (150) passengers, by actual count, dashed up to the radio cabin and demanded to know if I referred to *their* conversations in the radio room on this day or that. Husbands accompanied protesting wives, small children and older men all came and made me verbal faces. What did I mean by slurring them? But the husbands' eyes held a twinkle.

Another time we had a party of life insurance men and their wives aboard. The trip was awarded them as a bonus for selling \$100,000 or more insurance in a year. Things were growing dull after the second day and the di-



"HUSBANDS ACCOMPANIED PROTESTING WIVES——  
"Small children and older men all came and made me verbal faces"

rector of the party dropped in the radio room for a chat.

"What am I going to do to amuse these people to-morrow?" he asked, hardly expecting an answer. I looked at our broadcasting receiver, and was struck by one of the few good ideas I ever had. "Why don't you give them some special broadcasting: a personal message from the president of the company, back in C——?"

"But we can't arrange that," he argued. "There isn't time."

"You see that power amplifier on our broadcast set?" He admitted he did. "Well," said I, "we have a telephone transmitter rigged on it so we can talk into the loud speaker up forward, where the radio concerts come in. Your president controls the broadcasting station in C—— and if you will write a speech that he might give and dig up a man here in your party who talks like him, I'll do the rest."

We did. Our paper came out the next morning with the announcement of a special message to be broadcasted to the insurance party aboard our ship, and the whole crowd thought it was great. The actors got together in our cabin

office copy trip #7 issue #3

# The Great Lakes Radio News

Published by  
**GREAT LAKES TRANSIT CORPORATION**  
 Marine Trust Building, BUFFALO, N. Y.

The RADIO NEWS is published simultaneously on the TIONESTA, JUNIATA and OCTORARA. It is for sale at the News Stand, the Purser's Office and Radio Office, at the price of ten cents.

## RADIO NEWS BULLETINS

SS TIONESTA		
Vol. 2	Great Lakes Radio News	No. 8
Buffalo, for Duluth. Stopping to day at Mackinac Island and Sault Ste Marie, Michigan.		
Saturday, 4th August, 1923.		
Roster of Officers		
Captain....John Deherty		
First Officer..J McGillivray.	Chief Engineer..R J Keefe	
Second Officer..F M Premo	First Ass't Eng'r..H Hook	
	Second Ass't Eng'r..C Watt	
Steward..C W Hone	Purser..S J Fleck	
Radio		
Willis K Wing, senior		
Alton T Medsger, junior.		
-----		
THE WEATHER		
For <u>Lower Lakes and Georgian Bay</u> : Light to moderate winds fair and slightly-warmer with thunder storms in many localities before night.		
For <u>Lake Superior</u> : Light to moderate winds shifting to northwest fair weather with some local thunder showers.		
*--Canadian Marconi Toronto Ont 905P 3rd		
BECAUSE OF the death of President Harding, no baseball scores were broadcast last night, and so are omitted from the Radio News this morning.		
NEWS OF the death of President Harding was received at the radio office at 2 30A M Friday morning as it was being sent from Radiocentral station of the Radio Corporation in New York to the SS Mauretania. It was also received from Cleveland radio at 4 30 A M Friday morning.		



## GREAT LAKES TRANSIT CORPORATION

MARINE TRUST BUILDING  
 BUFFALO, N. Y.

J. F. CONDON, GENERAL PASSENGER AGENT

W. J. CONNERS, CHAIRMAN

S. C. EYANS, PRESIDENT

### WHAT THEY FELL FOR

The first page of one of our four-page dailies that found a ready sale at ten cents each

and rehearsed, we assembled the party in the music room at the appointed hour, I put on my best announcer's voice, and the thing was done. How they fell for it! And when we published the speech in full in the next day's sheet we sold 300 copies. More income arithmetic. 1 broadcasting (fake) = 300 . . . But I refrain.

The morning weather forecast would come in and I would read it through the loud speaker and follow it with something like this (with a bow of acknowledgement to the broadcasters):

You have heard the weather forecast just received by radio telegraph from radio station W W W. This is the radio cabin, SS. *Tionesta* announcing. Copies of the *Great Lakes Radio News*, containing baseball scores, late news bulletins, and the complete passenger list are on sale at the radio office. Any passenger, with honest intentions, accompanied by ten cents, will be welcome at the radio office. This is the radio cabin, SS. *Tionesta* signing off.

Did it work? Why they flocked to the cabin for paper. It was positively insidious. But the shock was great the first time we tried it. One little old lady was sitting calmly enough reading Anthony Trollope, or somebody, directly underneath that solemn black horn of our loud speaker. When the voice suddenly boomed out of the horn, for no reason at all . . . well, she was surprised.

Our colored deck stewards used to sell many copies for us. Two of them would report every morning for their fifty copies each. Harry was the most comical negro I have ever seen. I didn't think he could ever be serious, but when he asked me to let him sell some copies for us I thought he might remain solemn long enough to sell his

quota of fifty. So, the first morning he packed his fifty under his arm, never glancing at them. He had gone five steps down the deck when I heard to my horror: "Great Lakes Rado Noos. Stock market falls! Man killed in Albany! Terrible Chicago fire! See your name in print! Great Lakes Noos—ten cents!"

Harry sold the sheet. He had a new "line" each morning and I'll wager half his customers bought the paper to hear him tell about the fearful and wonderful contents. He was a sound salesman when he mentioned the "name in print" idea, for that worked great. That

was another fundamental of journalism we learned. Any small-town paper can be a success if it prints the names of enough residents even if they do nothing more startling than take a calm morning drive to the county seat.

We had our tragedies, too. When static was bad it was almost impossible to get the baseball scores. What were we to do? We couldn't make them up out of whole cloth because the baseball fans would check against the daily paper at the next port. I thought in envy of a friend of mine on the South American run, who made up scores for two weeks once when his receiver went bad. He was safe, but we could only make excuses and dig up more personal items—which were nearly as good. One night about three I was jarred awake by my junior operator pulling at my arm. "Say," he cried, "I've got the passenger list printed but our ink has run out. What can we do? We can't print any news."

"Oh, let it go at that," I mumbled, "we'll sell what we have for five cents then."

Newspaper editors are always complaining that they are supposed to know everything from the date the Assouan Dam was completed to the number of children possessed by John R. Twirp, the famous movie star. And we two amateur newspaper publishers—radio operators on the side—encountered the same blind confidence on our ship.

We printed the weather forecast in the paper. And one day, striking some icy weather in Lake Superior, a confident man, shivering in last season's topcoat, stopped at the door: "Say, how hot was it in Sioux Falls to-day?" Distractedly, we made a guess, and the next one came along. "Did it rain in Kenosha yesterday?" Probably.

One trip we had an unusually inquisitive lot aboard. This day our paper contained some facts about the locks at Sault Ste. Marie, Michigan. One of the three locks in use there is 250 feet longer than those at the Panama Canal and they never fail to excite deep interest

among the passengers. Just as we were pulling into the lock-channel about a quarter of a mile from them, a woman dashed up, quite breathless. One could see plainly she intended to miss nothing. My guess was that she was one of those mentally thirsty school teachers. "You know," she said, "I have wanted all my life to see the Locks. I've studied up about them, but there is one question I want to ask you. Which end of the boat goes in the Locks first?" How should one answer that?

Our paper brought a lot of interesting people to the cabin, too. I remember the oldish man

from Georgia who told me about the thrill he got from tuning up his broadcast receiver in an out-of-the-way camp in Florida and letting a hundred or so of the natives who had never heard good music before in their lives listen to "Roxie" in far-away New York.

And there was the energetic woman who was on her way around the world in her automobile. She had just motored through Japan and got her first news

of the Japanese earthquake from our modest radio paper. She was going it alone and told thrilling stories. An American flag on the radiator of her car had saved her from capture by some bloodthirsty Chinese bandits not three months before.

I remember best the lawyer in a small Michigan town who came in and read me Mencken and some of his own poems. Good verse it was, too. He had great stories of his trips to Washington, and interesting nights there at the Gridiron Club, where press correspondents from American and foreign papers come nightly. Our own little sheet was the introduction to that interesting evening.

For the life of me I don't know whether it was more fun printing our little four-page daily or talking to the people who came aft to our radio cabin to praise or blame us. Perhaps (you are thinking) the real thrill came when we looked at our bankbooks at the end of the season.

Perhaps.



WHERE THE RADIO FUN WENT ON  
The good ship *Tionesta*, which makes an eight-day cruise between Buffalo and Duluth

# When Cowboys Heard Bedtime Stories

An Adventure in Receiving at a Grand Canyon "Dead Spot"

By THOMAS H. McKEE

VISITORS to the north rim of the Grand Canyon, at Bright Angel Point in Arizona, appalled by a sense of remoteness, have exclaimed: "Radio is made for just such places as this! Why doesn't somebody put in a receiving set?"

In the light of the many trials and failures we have witnessed there, our answer has been: "Radio has been thoroughly tried out here and it won't work. The great forest about us absorbs too much of the strength of the ether waves; and with high amplification, static takes possession of the receiving set and drowns out all intelligible sounds. It can't be done. Nature is against it."

This region eighty miles from a post-office and two hundred from a railroad station is probably the most remote area of its size in the United States, and therefore an ideal place for radio to show its worth. But, in spite of ambitious efforts of both novice and expert, the north rim has hitherto remained a blank spot on the radio map.

The north rim stands a vertical mile above the river. Its altitude above sea level is eight to nine thousand feet. Northward from the brink spread a million acres of dense pine forest, cut by long side-canyons three to four thousand feet deep, each with precipitous walls and rocky rims.

The chief obstacle to successful reception has been the astonishing prevalence of static electricity. It is rampant both night and day, and as no one remains in the region in winter, the experiments have all been carried on in summer when static conditions are at their worst. All through the summer thunder-storms are frequent, with lightning stabbing viciously and constantly at the high pinnacles and promontories which stand out from the rim. No wise person ever stays near the Canyon's brink during these electrical bombardments, though withdrawal a few hundred yards from the verge

brings one into a zone of reasonable safety. Standing there the stranger is filled with awe as his ear-drums are pounded by the mighty thunder-claps and the rolling reverberations from the Canyon walls. It suggests some bitterly fought contest of unseen Titans, whose struggles threaten the overthrow of the precipices themselves.

It is no uncommon thing for persons in shaking hands with one another to be startled by a spark passing between them. One wearing a silk-lined coat draws it off and on touching some other object emits a spark that lights his tent at night. But most curious of all this static phenomena is the effect frequently seen on people's hair. Persons standing on the tip of Bright Angel Point often feel their hair pulled strongly upward; and to see a bobbed-haired girl standing there with her hat off and her abbreviated locks stretched skyward into a sharp pointed cone is not only one of the most ridiculous of spectacles but one that brings spooky thoughts to the steadiest minds.

Even the United States Government failed in a serious and expensive effort to establish radio communication here. In 1917 elaborate sending and receiving apparatus was set up on Bright Angel Point, and also on the south rim just across the Canyon. The main purpose was to establish communication between the two rims. Although the air-line distance is only thirteen miles complete failure resulted. Radio science has advanced greatly since then, but so discouraging was the report on the general static situation on the north rim that despite the sore need for such communication Uncle Sam's men have never tried it again.

Two telephone lines lead into the region from the outside world. They are single wires with ground return, and static interferes with their operation so seriously that for long spells nothing intelligible can be sent over them. Thus it is that the rangers, hunters, cowboys, and occasional visitors, who make up the

scanty summer population, remain out of all touch with the doings of the world. Even the recent death of a President remained for more than a week an unconfirmed rumor.

But fortunately for us of the north rim, and for the good reputation of radio, there remained at least one skeptic—Mr. A. W. Marksheffel, of Colorado Springs.

Mr. Marksheffel happens to be one of those who not only wants to know the reason for things, but is willing to exert himself greatly in discovering the truth about them. His enthusiasm and persistence in pursuing difficult radio problems have led him to undertake reception in several of the alleged "dead zones" in the mountainous regions around his home in Colorado, and his success there has proved that there are fewer of these unresponsive areas than is generally supposed. With carefully designed apparatus, skillfully operated, he has been able to bring in signals where there had been only failure before.

Having earned a reputation as a successful radio trouble shooter, in his own state, Marksheffel accepted an invitation to come to the north rim and see what he could do with the radio situation there, or, rather, according to the local wise-aces, to see what that situation would do to him. It was a long expensive journey by auto, but with the prospect of a contest worth his while, he came.

He arrived at Bright Angel Point on the evening of August 27th, the very day on which the Government expedition, descending the river and mapping the Canyon's depths, landed at the mouth of Bright Angel Creek, a mile straight down below the point. The telephone running up from the river had, in one of its more communicative moments, informed us of



AT THE RIM OF THE GRAND CANYON  
Mr. Marksheffel (at left) tuning-in broadcasting signals where none had ever been received before

their arrival, and that their radio-receiving set was then operating perfectly at the bottom of the gorge. With this auspicious news in mind we of the north rim watched Marksheffel with keen anticipation while he unboxed his apparatus for the test.

The arrival of a new and more promising set had served to bring to the Point that night an odd but interested group of observers. Half-a-dozen cowboys in chaps and sombreros had ridden in from the cow camps above; a couple of cougar hunters parked their rifles against a neighboring tree and joined the onlookers; there were two or three Forest Rangers in their natty, dress-up uniforms; while a few

"dudes" of both sexes strolled over from the Wylie-Way Camp near by. All were eager for a chance to hear even one intelligible word from the outside world. But in the comments of those who had attended previous trials, only to go away in disappointment, there was a note of doubt and even of scoffing, as Marksheffel mounted his big loop aerial and tinkered with his connecting wires.

At last all was ready and Marksheffel raised his hand for silence. He swung his aerial to and fro and twisted the knobs of his tuners. For five minutes this continued, his countenance growing longer. The doubters smiled and whispered.

"She's dead as a salted mackerel!" the operator announced in vexation. He flung open the lid of his box and began tracing out his wires, while a young cowboy disgustedly remarked:

"This radio business is sure the bunk. Here I've rode ten miles to-night after a hard day in the saddle to hear talk come out of that little black coffin and nothing comes. I've done that same thing half-a-dozen times before, but never again. I'm through."

"Coffin is right, Jim," put in his mate. "There's a dead one in it. Come on, let's go."

Then Marksheffel spoke excitedly. "Here's the trouble!" he cried. "A broken connection! I'll stick the ends together and try it again."

Once more he clapped the phones to his ears and began adjusting the set. Then slowly over his countenance spread that look of rapture seen only on the face of the searcher in the air for something he at last finds.

"I've got it now! Quiet, please!" he said. "There's considerable static, but I can hear Uncle John telling his bedtime story in the

*Times* tower in Los Angeles. I'll see if I can't clear out some more of the static."

A few moments more and he handed the phones to the nearest spectator, who happened to be the disgruntled young cowboy himself. That worthy tried vainly to get the head set on over his sombrero, but finally discarded the hat and put the receivers gingerly to his ears. Instantly he jerked them off and pressed them into the hands of his pal.

"It's there!" he shouted in delight. "Listen, Bob! It's real, honest-to-gawd talk!"

Then to Marksheffel he declared: "I take back all I said. You done it, Mister."

Bob, too, tried to jam the head set over his two-gallon hat, amid the laughter of the crowd, but in time got it in place. He also listened but a second and passed on the phones. Neither had listened long enough to understand what had been heard; for the moment they were possessed by the astounding fact that words were coming out of the sky.

Other phones were soon attached, the head sets separated into single units and passed around. While the company drank in the broadcasted messages and music, Marksheffel busied himself adjusting the apparatus to eliminate as far as possible the static which was still interfering. Later that evening he began bringing in other broadcasting stations.

There came a jazz orchestra from San Francisco, the daily news from Kansas City, a lecture on psychology from Los Angeles, and music, both vocal and instrumental, from other places. A peculiar feature of the situation, as developed that evening and verified later, was that no broadcasting could be heard from stations either to the north or to the south of us, but only from those directly, or almost directly, east and west. But a grand and glorious evening it was for us castaways.

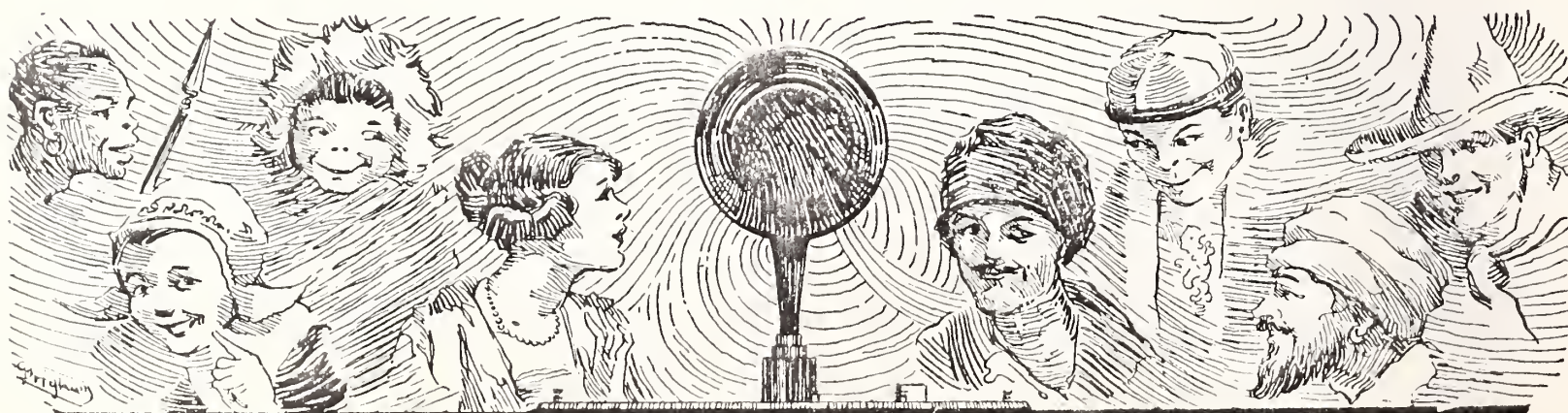

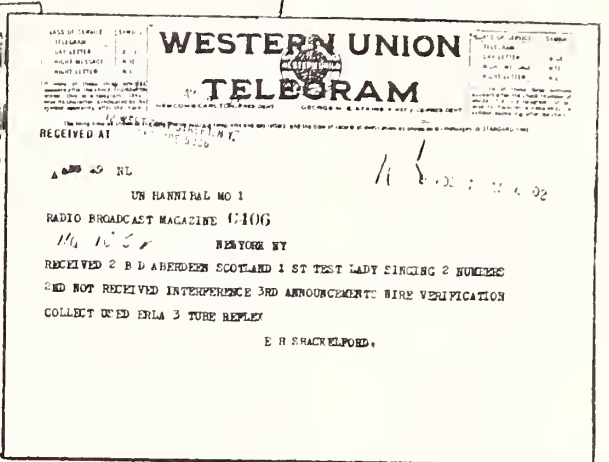
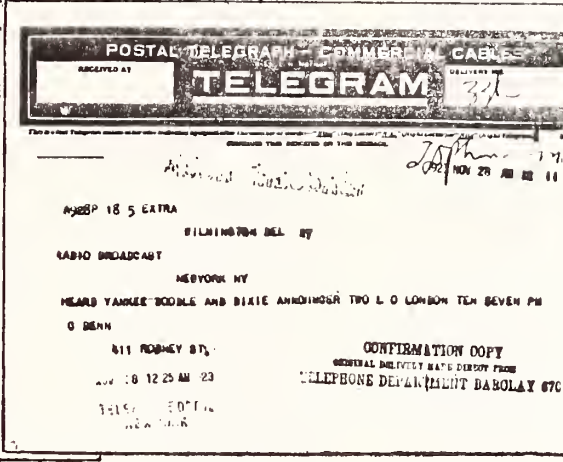
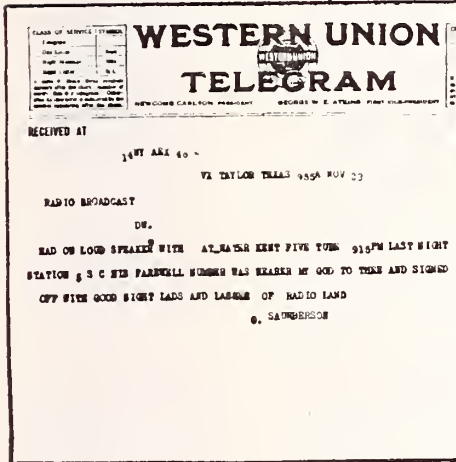
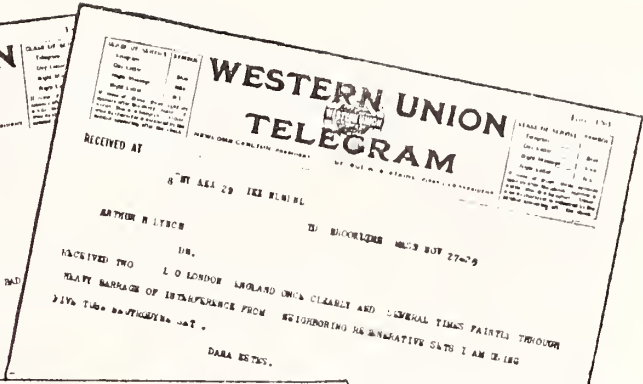
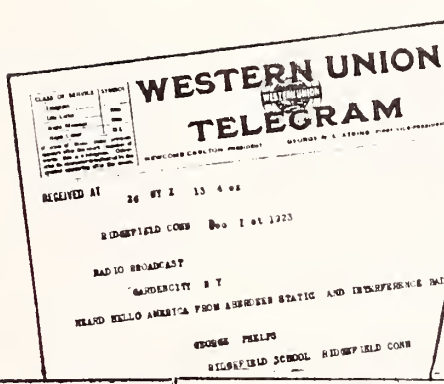

## Who Heard England?

IT WOULD be difficult to make an accurate estimate of the number of people on this side of the Atlantic who heard the British broadcasting stations during the recent broadcasting tests conducted by RADIO BROADCAST, but the following list, including the names of all whose reports of hearing England we have verified, does show how wide is the geographical distribution of the owners of successful receiving stations. 32 states and 4 Canadian provinces are represented. (The number after each state indicates the number of reports,

telegrams, telephone messages, and letters, that were received from listeners in that state.)

New York (47), Illinois (35), Iowa (31), Missouri (27), Pennsylvania (26), Massachusetts (22), Ohio (15), New Jersey (15), Connecticut (11), Minnesota (7), Texas (8), Oklahoma (6), Kansas (4), Michigan (4), New Hampshire (4), Wisconsin (4), Arkansas (4), Nova Scotia (3), Tennessee (3), Ontario (3), Indiana (3), Virginia (3), Quebec (2), West Virginia (2), Maryland (2), Maine (2), Delaware (2), Kentucky (2), South Dakota (2), British Columbia (1), Florida (1), Georgia (1), Nebraska (1), Mississippi (1), Vermont (1), New Mexico (1).

NAME	CITY
Miss C. A. Acker	Savannah, Ills.
C. E. Adams	Warner, N. H.
H. Adams, Jr.	Shinnston, W. Va.
Jos. Allen	Lacon, Ills.
L. C. Alblinger	Ste. Marie, Ills.
J. J. Alblinger	Ste. Marie, Ills.
A. D. Alderman	Holyoke, Mass.
Dr. B. Appleberg	Kings Park, L. I.
Wm. Ashe	Kings Park, L. I.
R. B. Avery	South Bend, Ind.
Mrs. J. C. Allen	Monmouth, Ills.
R. Atherton	Harrison, O.
W. A. Armstrong	New York, N. Y.
C. C. Anderson	Barberton, O.
T. C. Anderson	Greenwich, Conn.
J. G. Bradley	Justin, Tex.
J. A. Belton	Brooklyn, N. Y.
M. J. Belton	Brooklyn, N. Y.
H. G. Brown	Peoria, Ills.
C. L. Besler	Hopkinton, Ia.
Dr. C. Barnert	New York, N. Y.
S. E. Brooks	Leeton, Mo.
W. Burke	St. Louis, Mo.
W. F. Burden	St. Louis, Mo.
Fred Black	Alva, Okla.
E. R. Blocker	Waco, Tex.
R. M. Brooke	Casey, Ills.
Fred. Becker	St. Louis, Mo.
N. C. Baechler	Louisville, Ky.
C. R. Bowser	Kingston, N. Y.
Dr. E. W. Burt	New Bedford, Mass.
N. J. Buck	Colts Neck, N. J.
V. W. Bihlman	Dayton, O.
C. F. Baker	Dallas, Tex.

NAME	CITY
R. Bonyne	New Preston, Conn.
H. G. Brown	Peoria, Ills.
T. C. Bethel	Paullina, Ia.
W. J. Bray	Kirksville, Mo.
E. Bertschinger	College Pt., L. I.
C. W. Booth	New Brunswick, N. J.
J. J. Brus	Davenport, Ia.
A. W. Baehr	Cincinnati, O.
R. Baxter	Grafton, Ills.
E. H. Breedlove	Bentonville, Ark.
B. W. Bridgman	Eau Claire, Wis.
R. C. Bacon	Boston, Mass.
N. A. Berg, Jr.	Butler, Pa.
G. F. Boynton	Wollaston, Mass.
C. W. Cain	Okmulgee, Okla.
H. Church	Chagrin Falls, O.
F. Cassen	Franklin Square, L. I.
W. F. Clancey	Evergreen, L. I.
H. J. Conant	New York
A. Coombs	East Bridgewater, Mass.
H. E. Clark	Monmouth, Ills.
S. W. Cobb	South Portland, Me.
James Cosgrove	Virginia, Minn.
A. B. Cossett	Niagara Falls, Ont.
R. Classen	Schenectady, N. Y.
C. G. Clark	Berwick, N. S.
Chambers RadioCo.	Charleston, Ills.
W. S. Currier	Rose Hill, Ia.
S. H. Croft	Philadelphia, Pa.
G. H. Cilley	Paoli, Pa.
A. F. Combs	Enid, Okla.
J. E. Clarkson	Amherst, N. H.
J. F. Carrol	St. Louis, Mo.
E. A. Dettloff	Bloomer, Wis.
D. A. Dowling	Glencoe, Mo.

NAME	CITY
W. Davee	West Point, Neb.
W. L. Dulany	Woodstock, N. Y.
D. E. Dougherty	Oneida, Ills.
H. L. Duffey	New Straightville, O.
R. Dreyer	St. Louis, Mo.
O. A. Dixon	Raton, N. M.
P. A. Dinmoor	Lawrence, Kan.
F. E. Dunn	Keota, Ia.
H. S. Dolechi	St. Louis, Mo.
E. N. Duty	Charleroi, Penn.
H. N. Darst	Richmond, Tex.
F. J. Diehl	Freeport, Ills.
L. L. Dinkelspiel	West New York, N. J.
C. Denn	Wilmington, Del.
L. W. Edmonds	Brooklyn, N. Y.
A. Eichelberger	Alexander, N. Y.
Miss M. Eppley	Davenport, Ia.
C. Elliott	Brooklyn, N. Y.
D. Estes	Brookline, Mass.
G. G. Early	St. Louis, Mo.
J. C. Ewen	Bogota, N. J.
Miss G. M. Francis	Brooklyn, N. Y.
J. F. Fischer	Newman, Ga.
J. C. Fortune	Sydney, N. S.
K. M. Foster	Great Barrington, Mass.
R. Frazer	Windsor, Mo.
J. R. Farnsworth	West Point, Ills.
L. K. Garland	Apollo, Pa.
M. B. Gresham	Myrtle, Miss.
Miss L. A. Green	Smithport, Pa.
Goldsmith Bros.	Clarence, Ia.
F. A. Goodsell	Marshall, Mich.
M. R. M. Gwilliam	Bloomfield, N. J.
G. F. Gardner	Webster City, Ia.

Radio Broadcast

NAME	CITY
R. M. Gridley	Beaver, Pa.
Mrs. L. E. Gooch	Willmar, Minn.
J. N. Good	Magog, Que.
J. R. Haviland	Brooklyn, N. Y.
F. Gerlacke	Sidney, O.
Mrs. C. G. Halsey	Westfield, N. J.
H. Higgins	Springfield, Mass.
A. G. Hollingworth	East Elmhurst, L. I.
A. R. Hodges	Ridgewood, N. J.
A. P. Hall	Norfolk, Mass.
C. E. Hense	Alburnett, Ia.
P. Hampden	Ridgefield, Conn.
T. W. Herrick	So. Duxbury, Mass.
B. B. Holvis	Cochran, Pa.
F. L. Hall	Stamford, Conn.
W. W. Heaton	Mamaroneck, N. Y.
L. R. Horst	Rock Island, Ills.
Dr. L. M. Hardin	Flandreau, S. D.
H. E. Heyt	Duncansville, Pa.
F. G. Helyar	New Brunswick, N. J.
H. D. Harton	Nashville, Tenn.
J. W. M. Harry, Jr.	Havana, Ills.
J. S. Hays	Newkirk, Okla.
L. E. Harris	Ponsford, Minn.
R. Heckman	Liberty, Kan.
E. Hals	North Branch, Minn.
G. Hall	St. Louis, Mo.
H. F. Hoch	Webster Groves, Mo.
E. Hooker	St. Louis, Mo.
G. P. Hamilton	Eau Claire, Wis.
J. Harris	Windsor, Mo.
W. J. Hinchey	Medina, N. Y.
W. Henry	Keithsburg, Ill.
A. H. Helmar	Buffalo, N. Y.
C. E. Heyer	Sumner, Ia.
E. S. Jennings	Bridgeport, Conn.
W. A. Johnson	Lisbon Falls, Me.
E. I. M. Jamieson	Victoria, B. C.
F. L. Judd	New York
R. N. Jones	Johnsonburg, Pa.
W. Johnson	Cohoes, N. Y.
Rev. V. Jacobs	Williamsfield, Ills.
W. E. Jones	Rutland, Ia.
E. Jackson	Jacksonville, Ills.
Mrs. E. H. Johnson	Jessup, Ia.
T. O. Jones	Pittsburgh, Pa.
Station KDKA	Pittsburgh, Pa.
F. Koenig	Tarrytown, N. Y.
C. J. Kazmierczyk	Ramsey, N. J.
W. C. Kuehl	Manistee, Mich.
H. E. Kuehn	Baltimore, Md.
J. Kirkpatrick	Collison, Ills.
C. A. Kling	Vinton, Ia.
C. Kofie	Lakewood, O.
A. J. Kempien	St. Paul, Minn.
E. W. Kent	North Sydney, N. S.
R. R. Kegirise	Newcastle, Pa.
L. P. Kyle	Bristol, Ia.
T. Lewis	Waterbury, Conn.
F. H. Lutz	Buffalo, N. Y.
H. W. Lemberger	Burlington, Ia.
E. L. Le Fevre	Dayton, O.
C. E. Lowry, Jr.	Richmond, Va.
M. Loe	Blanchardville, Wis.
J. C. Lopez	Princeton, N. J.
V. Lopicolo	St. Louis, Mo.
B. F. Lamoreux	Lanark, Ills.
A. J. Lorimer	Farnham, Que.
F. C. Ludecker	Glencoe, L. I.

NAME	CITY
E. B. Ludlow	North Pembroke, Mass.
G. A. Lowden	Tarpon Springs, Fla.
W. E. Long	Sterling, Ills.
H. C. Leighton	Salem, Mass.
G. F. Leland	Springfield, Vt.
F. D. Layfield	Princesse Anne, Md.
A. R. Laing	Tipton, Ia.
J. H. Lafers	Minneapolis, Minn.
C. C. Magrath	St. Louis, Mo.
Dr. F. N. McMullin	Philadelphia, Pa.
J. F. McMullin	Philadelphia, Pa.
Monahan Radio Shop	Memphis, Tenn.
Miss E. Morgan	Maunie, Ills.
S. H. Mapes	New York
M. May	Brooklyn, N. Y.
C. M. Mackley	Peoria, Ills.
I. Meyer	Greenville, N. Y.
G. McPherson	Bellevue, Tenn.
T. L. Munson	Cheshire, Conn.
M. Mackenzie	Flushing, N. Y.
J. C. Marr	Alta Vista, Ia.
D. Mueller	Chicago, Ills.
R. Merservey	Wooster, Mass.
L. Martin	West Lafayette, Ind.
J. Martin	Clinton, Ia.
R. V. MacNiel	Harrisburg, Pa.
C. L. Miller	Harrisburg, Pa.
H. W. McClure	Ann Arbor, Mich.
K. Merritt	Mamaroneck, N. Y.
F. Menneke	Preston, Ia.
E. M. McCann	Lansing, Mich.
G. H. Murray	Metuchen, N. Y.
J. Martin	Waterbury, Conn.
C. L. McGhee	Edmond, Okla.
K. Miller	Lisbon, Ia.
C. R. McLaughlin	Philadelphia, Pa.
Mrs. F. Memmen	Minonk, Ills.
A. A. Mudge	Afton, N. Y.
F. Neiderlander	New Milford, N. J.
E. S. Nyce	Norristown, Pa.
G. W. Nicola	Muscatine, Ia.
E. E. Noe	Richland, Mo.
M. E. Newman	Boston, Mass.
Mrs. L. Owen	Peoria, Ills.
G. Phelps	Ridgefield, Conn.
E. J. Pritas	Bedford, Mass.
C. Parcell	Fredericksburg, Va.
W. Phillips, Jr.	Montclair, N. J.
W. R. Pettijohn	Hoyt, Kan.
J. F. Plumb	Cedar Rapids, Ia.
W. H. Palmer	Springfield, Ills.
O. H. Pool	Wynne, Ark.
W. H. Phelps	Winslow, Ills.
Miss Angela Pickart	Watkins, Ia.
D. Pitner	Sioux City, Ia.
S. Price	Hamilton, Ont.
R. K. Pierce	Port Colborne, Ont.
G. Pickett	Buffalo, N. Y.
H. L. Rex	Mauch Chunk, Pa.
E. L. Rice	New Haven, Conn.
Mrs. G. L. Rumberger	Nickleville, Pa.
A. C. Rothmund	St. Paul, Minn.
Radio Installation Co.	St. Louis, Mo.
E. A. Ryder	Keypoint, N. J.
F. J. Reichert	Esopus, N. Y.
J. Ruckman	Providence, Ky.
R. L. Rockett	Ft. Worth, Tex.
J. T. Rick	Corsica, S. D.
K. P. Ruggles	Cuyahoga Falls, O.

NAME	CITY
F. C. Ryder	Wollaston, Mass.
F. G. Ruso	Albany, N. Y.
J. G. Riger	Buffalo, N. Y.
W. Ruse	Aledo, Ills.
N. P. Rawson	Richmond, Va.
A. K. Reading	Bettendorf, Ia.
R. Sheehy	Newfields, N. H.
D. A. Sanders	Nyack, N. Y.
W. Swathburg	East Orange, N. J.
W. B. Symmer	Beverly, Mass.
Miss Schramm	St. Louis, Mo.
E. Stoltz	St. Louis, Mo.
Mrs. J. M. Stevens	Hastings, Okla.
Mrs. H. Spooner	Wheeling, Mo.
W. H. Stephens	Prompton, Pa.
H. Sharp, Jr.	Cincinnati, O.
E. N. Schmitz	Stewart, Minn.
A. Selzer	St. Louis, Mo.
Miss F. L. Satterlee	Flushing, N. Y.
C. D. Schutte	Topeka, Kan.
R. B. Sturgis	Barnstable, Mass.
H. E. Simpson	Lakeport, N. H.
J. E. Shepherd	La Plata, Mo.
H. Sawyer	New York
J. J. Shugart	Princeton, Ills.
L. D. Strubinger	Barrie, Ills.
A. G. Schmidt	Kirkwood, Mo.
G. Saunderson	Taylor, Tex.
E. H. Shackelford	Hannibal, Mo.
L. J. Schwingle	LaMoille, Ills.
H. W. Tribble	Rogers, Ark.
W. G. Thomas	Sheffield, Ills.
G. S. Tebbetts, Jr.	England, Ark.
L. A. Talbott	Audobon, Ia.
Miss E. Theye	Cincinnati, O.
J. Tritle	Alburnett, Ia.
K. P. Thompson	Seaford, Del.
D. J. Terwilleiger	New York
P. E. Uniker	Stamford, Conn.
J. H. Untzinger	Uniontown, Pa.
C. Vint	Beaman, Ia.
G. Vaux	Bryn Mawr, Pa.
A. R. Von Ottenfeld	Saranac Lake, N. Y.
O. A. Volberding	Latimer, Ia.
Station WGI	Medford Hillside, Mass.
WGJ	Schenectady, N. Y.
WOC	Davenport, Ia.
WOR	Newark, N. J.
WFAA	Dallas, Texas
J. C. Walsh Elec Co.	Jacksonville, Ills.
P. O. Wass	Rockport, Mass.
E. C. Washburn	Palmyra, N. Y.
D. B. Wollcott	Kent, O.
W. B. Winslow	New York
H. Waje	Bronx, N. Y.
O. R. Williams	St. Marys, W. Va.
V. E. Wilson	Philadelphia, Pa.
S. A. Witham	Brookline, Mass.
Mrs. H. A. Wettstine	Hazleton, Pa.
J. L. Wilhelm	Indianapolis, Ind.
W. E. Walker	Bettendorf, Ia.
W. W. Webb	Alliance, O.
R. B. Whitman	Garden City, N. Y.
M. Wood	Rockford, Ills.
C. D. Zimmerman	Cleveland, O.
N. A. Yeny	Stelton, Pa.
C. S. Young	Allentown, Pa.
H. Young	Brooklyn, N. Y.
E. L. Young	Quincy, Mass.

BRITISH LISTENERS-IN WHO HEARD AMERICAN STATIONS

ALTHOUGH radiograms from the *Wireless World and Radio Review* and the British Broadcasting Company were received by RADIO BROADCAST all during the week of the recent transatlantic tests, informing us that English listeners had heard excellently the programs of many of the American stations, there has

not yet been time for many letters to come to us from the other side. However, we have reports from the following persons, and many of the communications mention the interesting fact that successful American reception was accomplished frequently with the use of only one tube.

NAME	ADDRESS	AMERICAN STATION HEARD	NAME	ADDRESS	AMERICAN STATION HEARD
P. H. Audsley	Loftus, Yorks	WGJ	J. G. Bruce	Dundee, Scotland	WGJ, WHAZ, WOR, WMAF
M. Ault	Purley	WGJ	H. Brooks	Cheshire	WGJ
Anthony	Liverpool	WGJ	Bates	Buckinghamshire	WGJ
W. P. Ancock	Congleton, Cheshire	WGJ	R. G. Burder	Loughborough	WGJ
R. W. Arnott	The Garth, Monmouth	WGJ, WHAZ	H. Bendle	Chiddlehampton	WGJ
A. Ballentyne	Langside, Glasgow	WGJ	H. B. Burke	Leeds	WGJ
R. Bates	St. Catherines, Lincoln	WGJ			



NAME	ADDRESS	AMERICAN STATION HEARD	NAME	ADDRESS	AMERICAN STATION HEARD
Bickley	Birmingham	WGY	Macintosh	Inverness	WGY
H. F. Bateman	Nelson, Lancashire	WGY	Macrory	Londonderry	WGY
Basil	Liverpool	WGY	Munro	Oban	WGY
Brackney	Finchley	WGY, WHAZ	K. MacKenzie, R.N.	Linlithgow	WGY
W. Copfield	Exton, Exeter	WGY	J. Morris	Fleetwood	WGY
Cartwright	Bristol	WGY	A. H. Orcutt	N. Birmingham	WGY
H. Collen	Billericay, Essex	WGY	Oekll	Chester	WGY
A. B. Clark	Stowmarket	WGY	A. F. Paterson	Montrose, Scotland	WGY
E. J. Clark	Holloway	WGY	N. C. Powell	Hitchin, Herts.	WHAZ
D. K. Cameron	Ryde, Is. of Wight	WGY	C. Pycroft	Potefract	WGY
J. W. F. Cardell	Newquay, Cornwall	WGY, KDKA, WHAZ	Parsons	Dorchester	WGY, WSY
"Capacity"	Dundee, Scotland	WGY	F. P. Phillips	St. Anstell, Cornwall	WGY, WJZ
C. Chaplin	Colwyn Bay	WGY	H. R. Phillips	Arundell	WGY
C. B. Childs	Edinburg, Scotland	WNAV	A. N. Porter	Redland, Bristol	WGY, WJZ, WOR
R. Dunn	Leicester	WGY, WOO	H. J. Price	Cardiff	KDKA, WGY
W. Diggle	Blackpool	WGY	Paisley	Glasgow	WGY
Dadd	Clapham Jct.	WGY	Pilkington	Manchester	WGY
Davis	London	WGY, WHAZ	E. H. Rogers	Torrington, Devon.	WGY
Drysdale	Keswick	WGY	R. C. Rowley	Bradford	WGY
M. Edoloff	Stoke Newington	WGY	A. G. Richards	Chorleywood West, Herts.	WGY
A. Entwistle	Preston	WGY, WDAF, WHAZ	W. R. Redway	Exmouth, Devon.	WGY
J. Ewing	Arbroath	WGY	N. Rofs	Woking, Surrey	WGY
W. A. Edge	Manchester	WGY, WHAZ	Randell	Liverpool	WGY
R. E. Fabian	Durham	WGY	Renfrew	Glasgow	WGY
G. Featherby	Bishop's Stortford, Herts.	WGY	A. Stevens	Lancashire	WGY
A. R. V. Garnett	Camberley	WGY	T. F. Salisbury	Oundle, Northamptonshire	WGY
F. W. Glass	Durham	WGY, WJZ	W. R. Stainton	Leigh, Lancashire	WGY, WHAZ
H. J. Galliers	Brighton	WGY, WHAZ	S. J. Smith	Glasgow	WGY, WBAH, WHAZ, WJZ, WDAR, KPO (?)
W. P. L. Harrison	London	WGY, WHAZ	N. T. Smith	Broadstairs, Kent.	WGY
A. N. C. Horne	Queenstown, Ireland	WGY	A. G. Saunders	Runcorn, Cheshire	WGY, WHAZ, WOR
Harvey	Woolwich	WDAR	A. H. S. Stewart	Brighton	WGY
S. Hunter	Limavady	WGY	E. P. Sentance	Grantham	WGY, WHAZ
Holmberg	Cheshunt, Herts	WGY	Sinclair	Bristol	WGY
W. A. D. Howes	Staplecross, Sussex	WGY	A. Stevenson	Morecambe	WGY
H. E. Hiller	London	WGY	A. Shaw	Colney, Lancashire	WGY
Hardman	Whitefield	WGY, WJZ	H. B. Scargill	Harrowgate	WGY
Healey	Perranborth	WGY, WHAZ, WOR	Slater	Vogablik, Kirkwall	WGY
Howiston	Prestwick	WGY	Stone	Hinckley	WGY
Hughes	Douglas, Isle of Man	WGY	Dr. Shepherd	Sheerness	WGY
Hambling	London	WGY, WOR	Col. P. Smith	Newquay	WGY, WHAZ
Hill	Bristol	WGY	Tye	Sevenoaks	WGY
Hill	Letchworth	WGY	A. H. Thornhill	Cambridge	WGY
H. C. Henley	Breconshire	WGY	S. W. Troupe	Brighton	WGY
C. E. Horner	London	WGY, WJZ, WDAR, WSY	Taylor	Burnley	WGY
Holmes	London	WJZ	Taylor	Ipswich	WGY
Hall	Doncaster	WGY	H. J. Walden	Peterborough	WGY
S. Hecks	London	WGY, WJAZ	A. S. Walker	Brentford, Middlesex	WHAZ, WGY, KDKA, WFAA, KSD
Haywards	Haverhill	WGY	Lt. A. R. Williams, R.N.	Kensington	WGY
H. J. Jarrold	Norwich	WGY	C. R. Wicks	Westcliff-on-Sea	WGY
J. F. Johnston	Altrincham	WGY	E. Watts & Son, Ltd.	Hove	WGY
Jonston	Wallasey	WGY	O. W. Walker	Topsham, Devon.	WGY, WCAE
J. E. Jeffrey	Banff	WGY	H. W. Walker	Brentford, Middlesex	WGY, WMAF, WHAZ, KDKA
Rev. Jenkins	Enniskillen	WGY, WHAZ	Wood	Halifax	WGY, WOR
W. H. Kinnersley	Bristol	WGY	Warriner	Birkenhead	WGY
R. Logan, Jr.	Ayrshire, Scotland	WGY, KDKA	H. F. Wooler	Stockton-on-Tees	WGY
Leach	Petersfield	WJZ	Wyatt	Portsmouth	WGY
Maj. D. M. Lovett	Hollybank	WGY	Worth	Amberley, Sussex	WGY
L. Lott	Burnham-on-Sea	WGY, WHAZ, WOR	Watkinson	Dumbarton	WGY
C. K. Murray	Romsey, Hants	WGY	Wallington	Northampton	WGY
H. Marsden	Manchester	KDKA	Whiting	Biddeford	WGY
L. L. Miell	Bath	WGY, WHAZ	Capt Young	Southampton	WGY
E. Millard	London	WGY	A. Y. Yeates	Lincoln	WGY
McAndrew	Kilmarnook	WGY			
Mead	Longeaton, Nottingham	WGY			
Mather	Fleetwood	WGY			

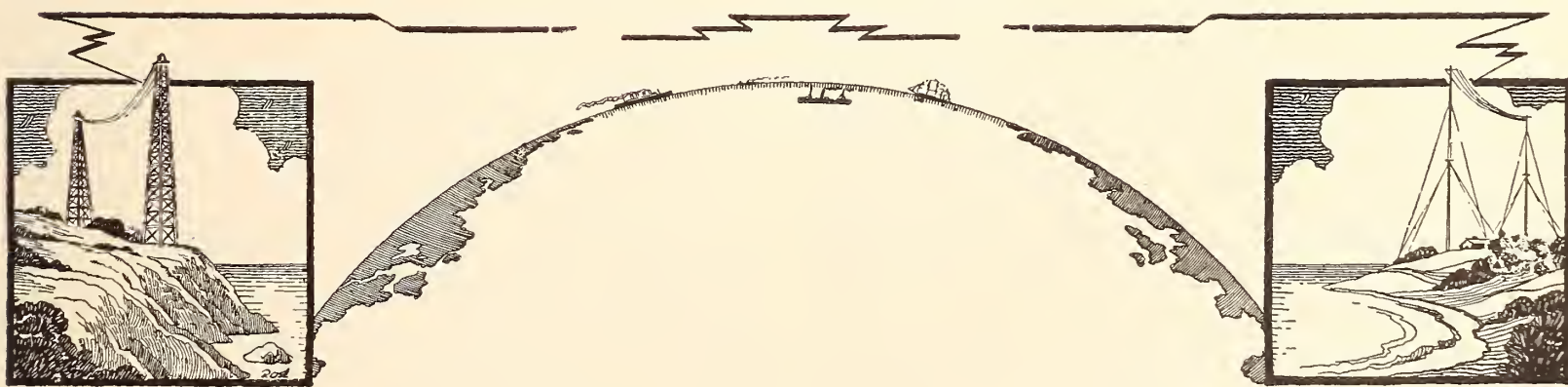

# What Broadcasting Does for a Newspaper

Why Some Newspapers Broadcast, and Why Some Don't. The Opinions of Newspapermen Themselves on the Relation of Radio to Their Field

By WINFIELD BARTON

WHEN you sit down at night before your radio set in a happy glow, due partially to the good dinner you have just enjoyed, and partially to your pleasant anticipation of a good radio program soon to come in, you rarely stop to think, Why are these stations broadcasting? But someone has thought out the answer to the problem, "Who shall broadcast, and why?"

Broadcasting is only three years old. In this brief span, electrical manufacturers and retail dealers have seen fit to install broadcasting stations, and their pioneer work was quickly followed by enterprising newspapers.

And now the list of owners of broadcasting stations shows they are maintained by hotels, department stores, banks, government departments, electrical manufacturers, and newspapers.

The reasons for manufacturing and selling concerns entering the broadcasting field are quite obvious to all. But why should a newspaper install a broadcasting station? Is anyone going to buy the newspaper in a given city because he has heard the programs from their station? Isn't the circulation of a newspaper built on its editorial policies—and its "dress," to borrow from the advertisers? Does, then, a broadcasting station owned by a newspaper help to sell more papers? Naturally, this question is that which most deeply concerns the newspaper owners.

"There are several practical reasons why a newspaper should broadcast," says William S. Hedges, Radio Editor of the *Chicago Daily News*. "The creation of good will, that intangible, yet nevertheless invaluable asset for

quasi-public institutions, such as newspapers, results from our broadcasting. Dollars may not directly follow from the pleasures experienced by listeners to programs broadcasted by newspapers, but the feeling of friendliness is there, and the friendship of the masses makes strength for the newspaper.

*"What is the good of a newspaper running a radio?" . . . We asked ourselves frankly. We decided that the return in good will was not worth the expense involved.*

—T. J. Dillon, Managing Editor,  
*Minneapolis Tribune.*

"It has been said that a newspaper has a harder time advertising itself than any other institution. Other firms, other institutions, can place their advertising in the newspaper, reach their clientele, and

attract new patrons. The institution can advertise too, in other papers in the same city. The newspaper can, of course, advertise in other newspapers in its locality, but isn't that a confession of its own weakness? So we find the newspaper advertising on billboards. The power of billboard advertising is debatable. When radio broadcasting was made possible, the newspaper had a new means of advertising, though of course, an indirect one.

"The radio broadcasting station of the newspaper pours inoffensively its name into the willing ears of thousands of listeners. The various departments of the paper become known to great numbers who had never given a thought to the variety of newspaper service before. The automobile editor, giving his talks on motor trails, local traffic regulations, and helpful hints on safety in driving, interests that group among his listeners who own motor cars. And those who are interested in automobile tours, safe driving, and the problems of the motorist will turn to their radio-friend's column for information when they buy the paper. The broadcasting of football, baseball, and other sporting returns emphasizes the sporting department. So, in giving ser-

vice to the public, the newspaper builds up its clientele.

"Some of these reasons for the newspaper entering the broadcasting field may not seem especially 'practical.' But newspapers do not gain their strength from being too 'practical' or cold-bloodedly commercial in their relations with the public. The newspaper must be willing to serve."

There are a number of representative newspapers with excellent broadcasting stations now in operation. Among these are the *Detroit News*, the *St. Louis Post Dispatch*, the *Dallas News*, the *Fort Worth Star-Telegram*, the *Detroit Free Press*, the *Kansas City Star*, and the *Chicago Daily News*. At one time, there were other papers maintaining broadcasting stations. The *Minneapolis Tribune* and the *Atlanta Constitution* are two of the best-known papers which have withdrawn from the broadcasting field. Many other

newspapers have, at one time or another, made arrangements with broadcasting stations already existing in their towns to broadcast special programs on certain nights. The newspaper would thus buy special service from those qualified to give it, without itself incurring the expense of its own station.

Not all newspaper-owners feel the same way about broadcasting as the *Chicago Daily News* does. Clark Howell, Editor of the *Atlanta Constitution* says:

"The *Constitution* quit broadcasting because, after we installed a station at great expense and operated it for a year, we reached the conclusion that the novelty had worn off, and we abandoned the service for much the same reasons which induced the *Chicago Tribune* to withdraw from the field.

"We do believe, however, that there is a great future in radio for commercial purposes, and when the Georgia Institute of Technology asked our aid in securing a radio plant to enable it to teach radiography in its commerce department, we were glad to make a contribution of our radio plant for that purpose.

That station is now in practical use at Georgia 'Tech.'

"As a novelty, we were glad enough to operate the plant for a year, but we saw no reason why a newspaper should maintain this service as a permanent feature.

"Our conclusion was that the large sum it cost to maintain a broadcasting service could be put to a very much better use by enlarging our news and special feature departments. This," concludes Mr. Howell, "we have done, with gratifying success."

A broadcasting station costs from \$50,000 to \$100,000 to install. The maintenance expense per year is high, for these broadcasting stations, unfortunately, cannot run themselves. The *Detroit News*, for example, maintains, in addition to the regular operating staff of its station WWJ, a group of trained radio men which it places at the disposal of the public, to give those who wish

*Radio offers the newspaper a new opportunity to serve. The modern newspaper not only presents the news of the day, but it strives to instruct and entertain.*

*If, when we close our program each night, we leave our listeners a little better than when they started listening-in, we have done much. We . . . cast our bread upon the waters, but the return of that bread, in the form of good will and increased circulation, is almost a certainty.*

—William S. Hedges, Radio Editor,  
*Chicago Daily News.*

it, reliable information about radio receiving sets and equipment. That costs money.

T. J. Dillon, Managing Editor of the *Minneapolis Tribune*, considers the question, "Should newspapers broadcast?" in another way. Mr. Dillon tells of the experience the newspaper owners in his city had with radio, and relates how amusingly radio worked to bring the formerly hard and unyielding competitors of Minneapolis and St. Paul around the conference table.

"The *Minneapolis Tribune* entered the broadcasting field in the realization that it was only a temporary advertising activity, the value of which would disappear as soon as broadcasting became more general. Other newspapers in our local field installed broadcasting apparatus, or made connections with stations to which they gave their names. Department stores, electrical companies, and other commercial enterprises were quick to see the advertising possibilities of this novelty, and in a short time it was necessary to organize the directors of these various stations and select a neutral executive officer to portion out the time for each station.

"None of us knew a great deal about radio telephony, and, looking back on the efforts of those days, we will all here admit that they were quite crude, compared to the present-day broadcasting.

"It soon became apparent to the *Tribune* that this competition for the air, and the competition for singers, musicians, bands, etc., would soon reach the point where the *Tribune* would have to assume a very heavy financial burden. In return for this burden, we could hope to get nothing except that intangible and transient commodity known as good will. Then, inasmuch, as this good will would have to be divided more or less equally among our many broadcasting stations, we did not think that our net return would be worth the expense involved.

"The three large newspapers of the Twin Cities evidently came to this conclusion about the same time. The managing editors who had hitherto been cold and uncommunicative competitors, began to get confidential, and even complimentary toward each other. This unnatural condition of inter-office amity deceived none of those interested. It was only a short time until the three gathered together, laid their cards on the table, and frankly asked each other what was the use of a newspaper running a radio.

"The result was the agreement on the part of the three newspapers to withdraw from the field and to lend their support to a private organization that was then planning to install a thoroughly up-to-date station. Simultaneous announcement of this decision drew from the public rather unflattering but fervent commendation.

"The truth of the matter was, that with our lack of experience, we were not giving the public the service and the quality of entertainment they desired, and I think that experience has shown that one or two well-organized stations, operated by a management that would have no other interest, are able to give the public better service than a multitude of stations operated as adjuncts to some other business. This is true, at least, as far as my experience is concerned with the hastily born and short-lived WAAL."

C. W. Kirby, the Radio Editor of the *Detroit News* feels that in spite of the heavy expense in maintaining a good broadcasting station, a solvent and progressive newspaper is justified

in maintaining a station. "The newspaper derives no tangible benefit from broadcasting," says Mr. Kirby.

"The *Detroit News* was one of the pioneers in radio broadcasting. Its first set was placed in operation on August 30, 1920. A few months later, its original broadcasting equipment was discarded for the more powerful, more efficient 500-watt station now in use. Our paper and our call letters, WWJ, have become known in every state in the Union, and in countries within 4,500 miles of Detroit through our broadcasting service.

"Good will is about the only return we expect from our station. The circulation department tells us positively that they list no increases in circulation due to our efforts in radio. The advertising department is of the same opinion. The *Detroit News* maintains its broadcasting station as a part of its public service. In addition to the actual broadcasting of entertainment and general items of interest we have a staff of trained radio experts, at the call of the public."

The presence of the newspaper in broadcasting undoubtedly has made the programs more varied and the service to the public greater. One need not go far for a recent example. Out of six stations broadcasting the address of President Coolidge to Congress, three of them were newspaper stations; WFAA, the *Dallas News*; KSD, the *St. Louis Post Dispatch*; and WDAF, the *Kansas City Star*. The newspaper brings its traditional acuteness for "what the public wants" successfully into the broadcasting field.

So, newspaper owners are grouped in two opposing camps. Those who have gracefully retired from the field say, "It isn't worth the money." Those who are still active and healthy participants say, "We shall reap our reward in good will, by helping directly and indirectly to serve the public."

Who is right? Perhaps both. But one of the most interesting side-light on the whole question was given the other day when we asked a radio enthusiast if he thought radio broadcasting helped the newspaper. "Help it?" he questioned and answered in the same breath, "I don't see how radio can avoid doing that very thing. Where I formerly bought one paper, I now buy two and sometimes three, for I don't want to miss any of the programs, near or far!"

# The Grid

## QUESTIONS AND ANSWERS

The Grid is a Question and Answer Department maintained especially for the radio amateurs. Full answers will be given wherever possible. In answering questions, those of a like nature will be grouped together and answered by one article. Every effort will be made to keep the answers simple and direct, yet fully self-explanatory. Questions should be addressed to Editor, "The Grid," RADIO BROADCAST, Garden City, N. Y.

### HOW TO CONNECT JACKS

I enclose a diagram of a two-stage amplifier. I believe the circuit is correct, but I do not wish to use the amplifier at all times, and so should appreciate your showing me how I can cut out both one stage and the complete amplifier by means of telephone jacks and a plug. Also, please show me how I can do the same thing with the Grimes circuit.

R. U. R., Wilmington, Del.

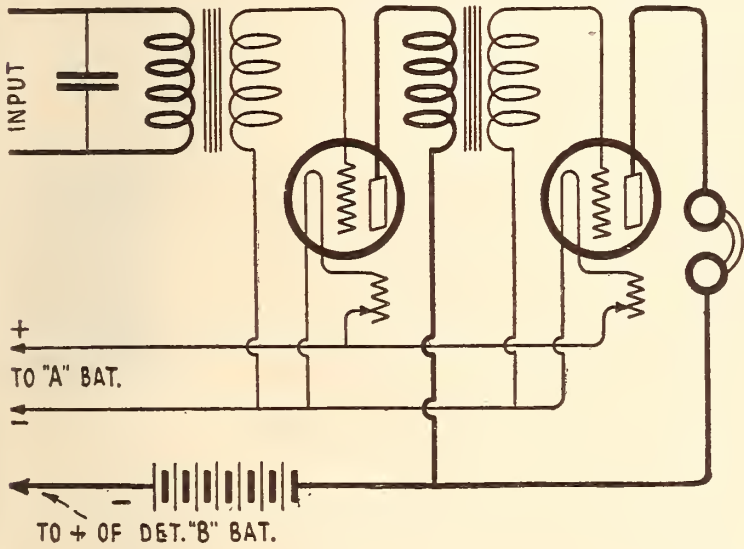

FIG. 1

The circuit submitted to *The Grid*

will be better understood if their functioning in a circuit, or just what they accomplish, is first made clear. There are only two kinds of jacks that, for the sake of efficiency and reliability, the GRID recommends to its readers. These are the "open circuit" and the "closed circuit" types. The first two jacks in Fig. 2 are of the closed circuit design, while that in the plate circuit of the third tube is an open circuit jack.

The open circuit jack is used to make a simple connection. When the plug is in, whatever instruments are led to the plug, are in series with the wires leading to the jack. When the plug is out, the instruments are disconnected and the circuit is "open."

The closed circuit jack, which is the more used, is employed where it is desired to disconnect automatically one instrument (say an amplifying transformer) while another instrument (telephone receivers for instance) is plugged in its place. Taking jack two, in Fig. 2, as an illustration: When the plug is removed, as it is in the drawing, the outside prongs close down and make contact with the inside prongs. Thus the transformer is in series with the plate circuit of the first amplifying tube, just as it is in Fig. 1. However, when the phones are plugged in, the plug forces the outer prongs farther apart, until they fail to make connection with the inner ones, and, instead, scrape contact with the plug. The phones are now in exactly the same position as was the transformer primary before the plug was inserted.

Whenever it is desired to cut out amplification by plug-

THIS problem (if it presents sufficient difficulties to be so termed) like many other radio puzzles is merely a matter of a principle involved, and when this is understood, the solution may be applied to many circuits and uses. Jacks are connected in the Grimes circuit in identically the same manner as they are in a straight amplifier. The majority of broadcast enthusiasts complicate radio circuits, and their resulting radio troubles, by insisting on vast differences between circuits, when fundamentally there exists little or no difference. Almost everything the experimenter may learn through the operation of a Grimes or another receiver, can be applied equally well to experiments with a super-heterodyne, etc.

The arbitrary connections for jacks

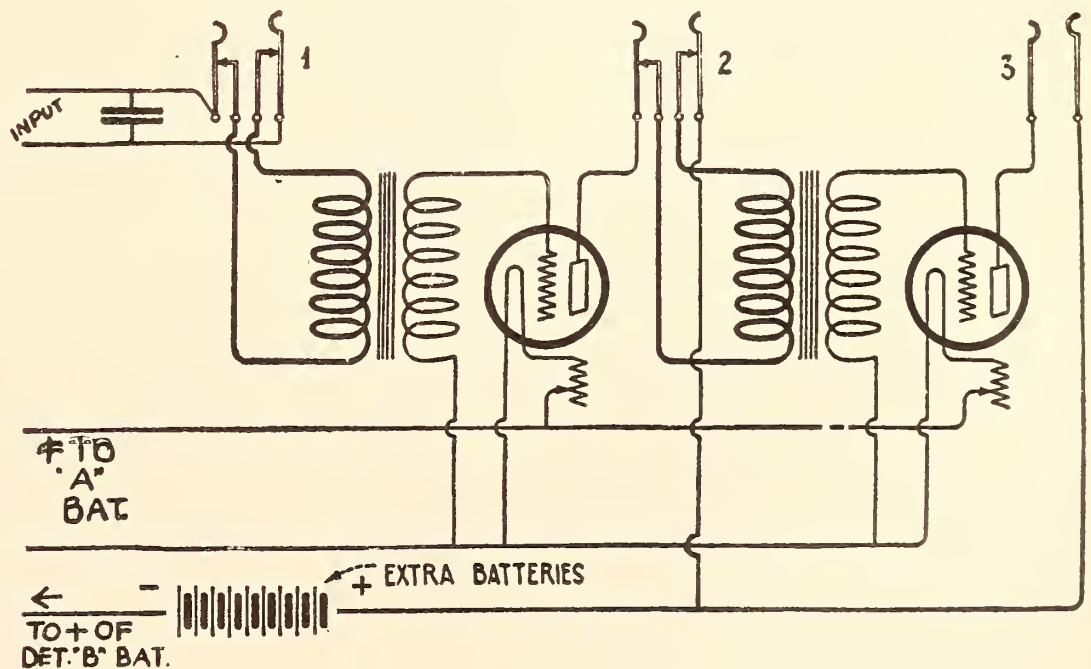

FIG. 2

The circuit of Fig. 1 with jacks added

ging in phones at some preceding tube, it is only necessary to shunt the primary of the transformer for which the phones are going to be substituted, by a closed circuit jack (Fig. 3). Connect the inner prongs to the transformer, and the outside prongs to the original leads in the plate circuit. Make sure that the same lead runs (through the jack) to the same terminal on the transformer as it did before the change was made (assuming, of course, that it was connected rightly in the first place). All soldering paste, acid, and dirt, which will cause noises, should be carefully wiped away from the prongs.

Fig. 1 shows our correspondent's circuit as he submitted it to the GRID, and Fig. 2 is the same circuit with the addition of the jacks.

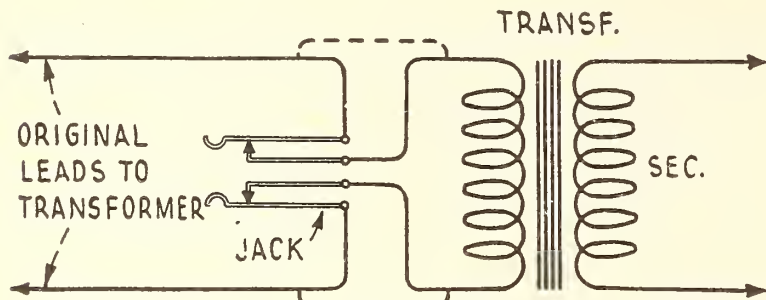

FIG. 3

Jacks may be shunted across any transformer where it may be desired to plug in phones

#### HOW TO MAKE A WAVE-TRAP

*I have had much interference from amateur and commercial stations. Would a wave-trap help me? Can I make one, or must it be purchased? What is the theory of its action?*

T. O. B., New York City.

**T**HE wave-trap, as its name suggests, is merely a device into which an undesired frequency or wave may be enticed, while the desired wave is passed on to the receiving circuit unimpaired or only slightly affected. Its most simple and common form is a coil of wire shunted by a variable condenser, which is placed in series with the

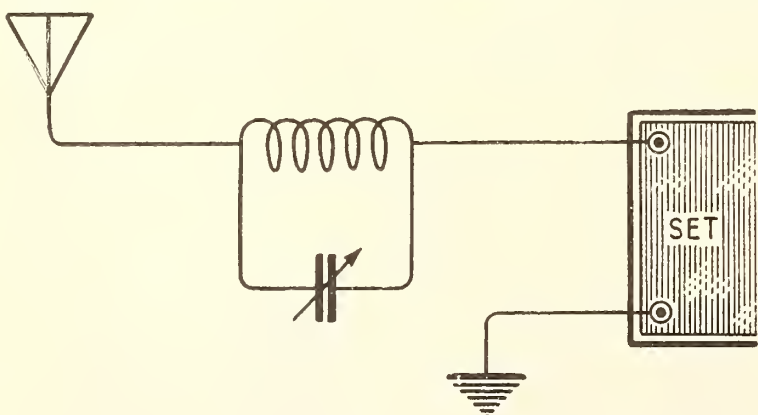

FIG. 4

One method of connecting parts of a "wave-trap"

antenna lead to the receiving set, Fig. 4. This forms a resonant circuit, or one which will absorb energy from the wavelength to which it is tuned. Thus if it is tuned to six hundred meters, the wave on which our correspondent doubtless experiences the greatest part of his interference, energy on that wave will be "trapped" and dissipated in the trap circuit, while other waves will pass on to the set.

The coil may be of the lattice-wound variety, about thirty-five turns, or wound to the same number of turns with No.

26 wire on a 3-inch tube. The condenser should be at least a 43-plate variable, and if possible a still larger one (.0015 mfd.). The larger the condenser, the smaller will be the coil, or load on the set, with an additional by-pass for the legitimate waves. It is a good idea to reduce the number of turns to the minimum (with full condenser capacity) for absorbing the highest of the undesired waves. This will lessen the reduction in strength of the broadcasting station. The tuning of the wave-trap is rather broad, and it affects signals anywhere from fifty to a hundred meters off its resonance point.

In some cases, particularly in spark interference, the arrangement shown at Fig. 5, is more efficient than that just described, and will probably prove more efficacious in eliminating disturbances from amateur transmitters, though a correctly built and operated receiver should experience little QRM (interference) from such stations. The constants (the coil and condenser) remain the same as for the previous series arrangement, the trap merely being shunted across the antenna and ground rather than in series with the former.

If the interference is confined to commercial traffic on six hundred meters, the 43-plate variable condenser is not necessary, and a 23-plate variable shunted by a .0005 grid condenser, without leak, may be substituted for it.

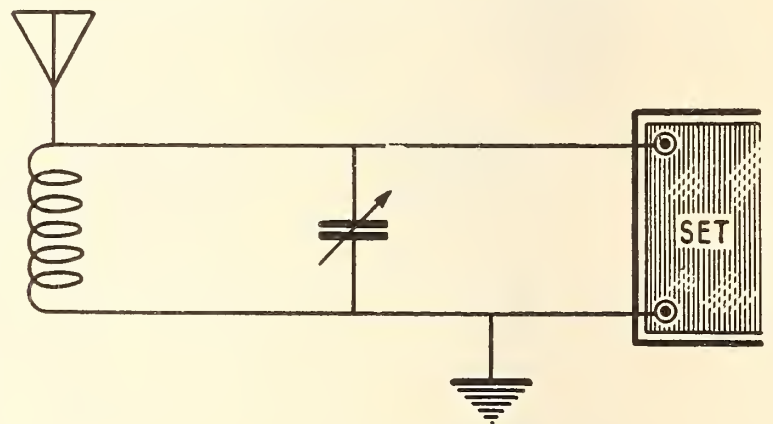

FIG. 5

This arrangement is more efficient in cutting out spark interference than that of Fig. 4

#### BANK WINDING

*What is "bank winding"? I see it mentioned very often as an efficient form of inductance, but no one is able to describe it or instruct me as to the method of winding.*

W. B., Montreal, Canada.

**B**ANK winding, like the honeycomb and duolateral coils, is a form of inductance in which many turns of wire, or a high inductance, is possible, while the distributed capacity is kept at a minimum. Bank winding, however, can be achieved without special winding forms and apparatus such as is necessary with the variations of the honeycomb.

Distributed capacity is the condenser action between the turns of a winding. It is naturally very high in ordinary multilayer coils in which each successive layer acts as a condenser plate. This capacity, which is virtually shunted across the coil, boosts up the wave and thus limits the inductance in tuning the lower wavelengths, or, more simply, there is an apparent loss due to the fact that the capacity offers a path to the higher frequency currents, which jump from layer to layer, the path of least resistance, rather than pass through the windings.

Bank winding, to an extent, is a method of breaking up

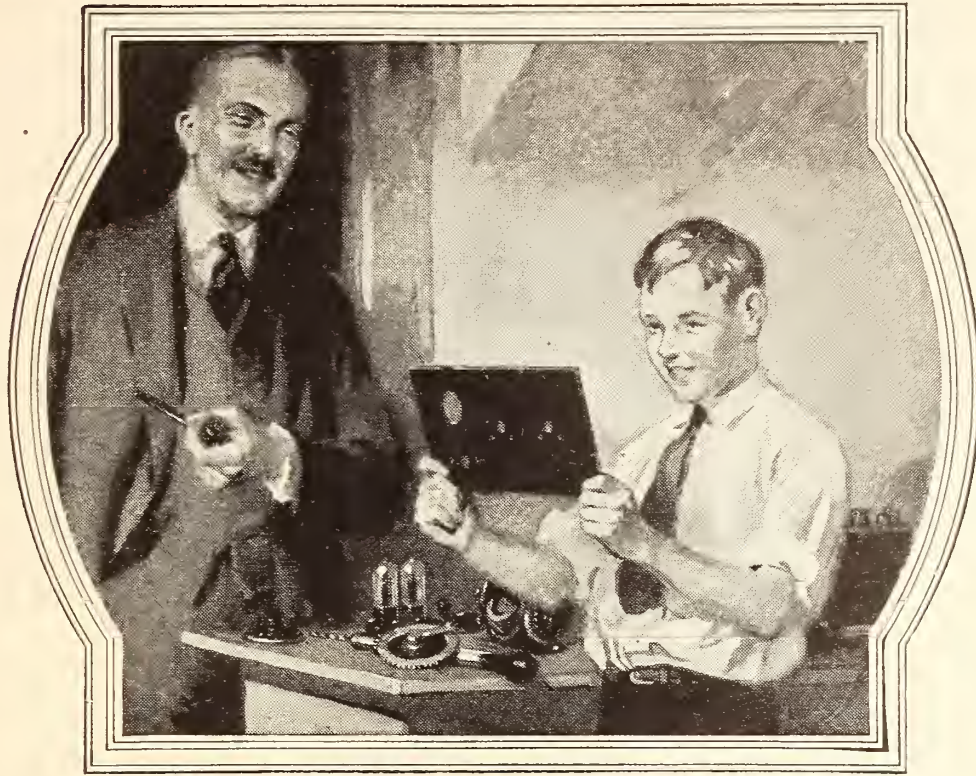

## Now for the hook-up

**T**HE radio set builder's eyes shine with pride as he inspects his drilled Celoron panel. He has done a good job. The finely finished Celoron panel reflects his good workmanship. He is ready to mount his instruments and make the final connections.

A Celoron panel insures good looks to the radio set. Celoron panels are finished in black, oak and mahogany. Each Celoron panel is wrapped in a dust-proof glassine envelope to protect its lustrous surface. Grit cannot scratch it. Hands cannot fingerprint it. You are the *first* to unwrap it.

Celoron, a bakelite product, has high dielectric strength. It is approved by the U. S. Navy and the U. S. Signal Corps.

Special-sized Celoron panels are cut to order from sheet Celoron. Standard Celoron panels come cut and trimmed, ready to use, in these sizes:

1—6 x 7 x 1/8	5—7 x 18 x 3/16
2—7 x 9 x 1/8	6—7 x 21 x 3/16
3—7 x 12 x 1/8	7—7 x 24 x 3/16
4—7 x 14 x 3/16	8—12 x 18 x 3/16
	9—7 x 26 x 3/16

Write for our interesting booklet, "*Getting the Right Hook-Up.*" Sent free upon request.

To radio dealers: Send for special dealer price list showing standard assortments

### Diamond State Fibre Company

BRIDGEPORT

(near Philadelphia)

PENNSYLVANIA

Offices in Principal Cities

In Canada: Diamond State Fibre Company of Canada, Limited, 245 Carlaw Ave., Toronto

CONDENSITE  
**CELORON** ★  
 STANDARD RADIO PANEL

a multilayer coil into a *series* of distributed capacities; and when condensers are connected in series, which is the effect here achieved, the total capacity is reduced! The method is illustrated by the drawing, Fig. 6, which shows

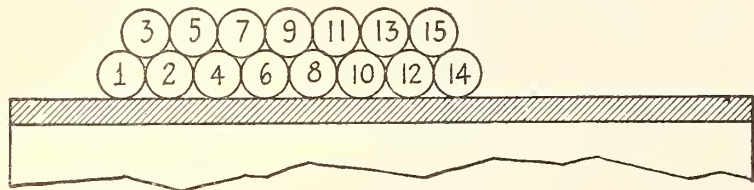

FIG. 6

How the wire is wound on a two-bank coil

a bank-wound primary, and the following table which indicates the exact system of winding the most popular banks. The numerals represent the numbers of the turns.

Two-Bank Coil:

3	5	7	9	11	13	15	
1	2	4	6	8	10	12	14

Three-Bank Coil:

6	9	12	15	18		
5	4	8	11	14	17	
1	2	3	7	10	13	16

Four-Bank Coil:

10	14	18	22			
8	9	13	17	21		
7	6	5	12	16	20	
1	2	3	4	11	15	19

It will be observed that at no time is there any great length of wire between the adjacent turns as is often the case in regular layer windings, such as the following:

15	14	13	12	11	10	9	
1	2	3	4	5	6	7	8

—where, between the 1st and 15th turns there may be many feet of wire, and a voltage equal to that impressed on the coil! If fifteen hundred volts were applied to this winding, the insulation, were it of ordinary quality, would probably break down between turns one and fifteen, whereas, in a fifteen turn two-bank coil, the potential difference between any adjacent turns, under the same charge, could never exceed two hundred volts! Thus in bank-winding there is little dielectric loss.

#### R. F. AND THE FLIVVER CIRCUIT

*I have been using the "Flivver" circuit described in The Grid section of your July number. I have had remarkable results with this set, receiving stations as far away as Schenectady (WGY) through tropical static (when it lets up a little). However, I should like further to improve the set, if possible, by the addition of one stage of radio-frequency amplification and a single step of audio. I should appreciate a diagram if such exists.*

*Also, in such radio-frequency sets, will you please explain how the received wave perseveres as an alternating current after passing through the first tube, which, so it seems to me, must necessarily rectify it. (Only a one-way current can pass through a tube).*

M. E. S., MEXICO CITY.

RADIO BROADCAST has been experimenting with several possible radio-frequency adaptations to this circuit (Fig. 7) with the idea not so much of increasing the receiving range, but of choking the oscillations to which this set gives rise and which, when admitted to the antenna circuit, cause no small amount of interference in congested radio districts. We are glad to pass on the following data and circuit.

The circuit is shown in Fig. 8, and the right-hand portion enclosed in the dotted lines is the original single-circuit "flivver" receiver (by other names, the Automatic Regenerator, the Colpitts Oscillator, this last being its correct radio designation). The remainder of the circuit comprises the radio-frequency amplifier. A glance at Fig. 8 will indicate an *apparent* addition to the original hook-up in the condenser C<sub>2</sub>. This, however, is merely a small capacity which compensates for that of the missing antenna. It will be observed that it is connected where the antenna and ground would ordinarily go. This condenser should approximate .00015 mfd., and it may be made up of

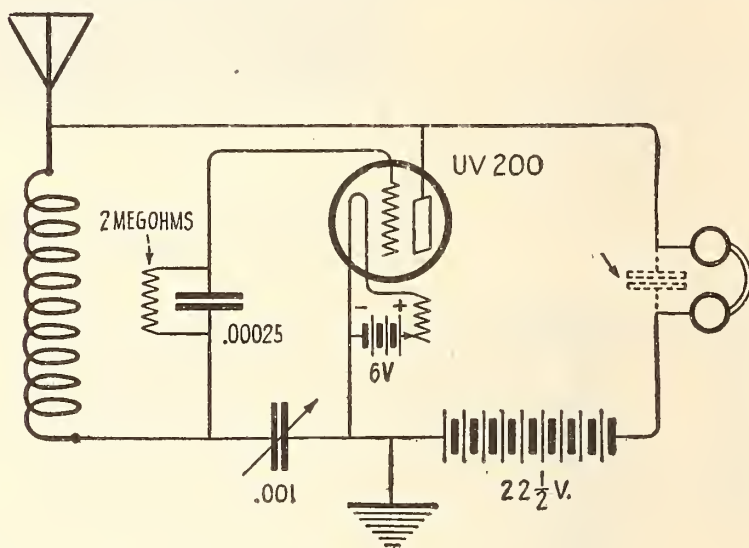

FIG. 7

The "Flivver" or Colpitts Oscillator Circuit

two plates of copper or tin foil, one inch wide, overlapping one inch and separated by a piece of waxed paper. It may also be formed from a grid condenser (without leak) by removing two thirds of the foil.

P and S are respectively the primary and secondary of a standard variocoupler. L is a small coil of ten turns of wire wound on a three-inch form, and is often necessary as a partial compensation (C<sub>1</sub> also helps) for the grid variometer with which many variocouplers are designed to be used. If it is desired to employ a loop, a coil antenna of the type described in the June Grid may be substituted for S and L.

C<sub>1</sub> can be either a .0005 mfd. or a .001 mfd. condenser with a vernier adjustment—the last being preferable. RFT is a standard radio-frequency transformer, one in which maximum amplification (the peak) is at about 425 meters. It will be observed that the secondary is merely substituted for the inductance in the original "flivver" circuit. Hence the operator of the fundamental circuit may, if he desires, build up his own transformer, utilizing his present tuning coil as the secondary. It will merely be necessary to wind over the tuner the same number of turns, minus eight, that are used on the single inductance for the reception of the stations it is desired to amplify. This extra winding forms the primary and it should be shunted with a 23-plate condenser as tentatively shown



*"New York's Grand Opera - one of the many events enjoyed by Magnavox owners"*

---

**MAGNAVOX**  
Radio  
Reproducers and Amplifiers



**M**AGNAVOX instruments are never subject to those internal interferences which, at critical moments, are so apt to mar the performance of ordinary radio reproducers.

To measure the success which Magnavox engineers have accomplished in the design and manufacture of Magnavox products, remember that they have been sold in far larger quantities than any other radio units in the world.

- |  |  |         |
|--|--|---------|
| <b>Magnavox Reproducer</b>                             | in. curvex horn and 1 stage of amplification .         | \$59.00 |
| R2 with 18-inch curvex horn                            |  |         |
|  |  | \$60.00 |
| R3 with 14-inch curvex horn                            | A2-R consisting of electro-dynamic Reproducer with 14- |         |
|  | in. curvex horn and 2 stages of amplification .        | \$85.00 |
|  |  |         |
| M1 with 14-inch curvex horn.                           |  |         |
| Requires no battery for the field . . . . .            |  | \$35.00 |
| <b>Magnavox Combination Sets</b>                       | <b>Magnavox Power Amplifiers</b>                       |         |
| A1-R consisting of electro-dynamic Reproducer with 14- | A1-1-stage . . .                                       | \$27.50 |
|  | AC-2-C-2-stage . . .                                   | \$55.00 |
|  | AC-3-C-3-stage . . .                                   | \$75.00 |

*Magnavox Products are for sale at Registered Magnavox Dealers everywhere. Write for new 32-page Magnavox Radio Catalogue.*

**THE MAGNAVOX CO., Oakland, California**  
New York Office: 370 Seventh Avenue  
Perkins Electric, Limited, Toronto, Montreal, Winnipeg  
Canadian Distributors



*For every receiving set there is a / MAGNAVOX*

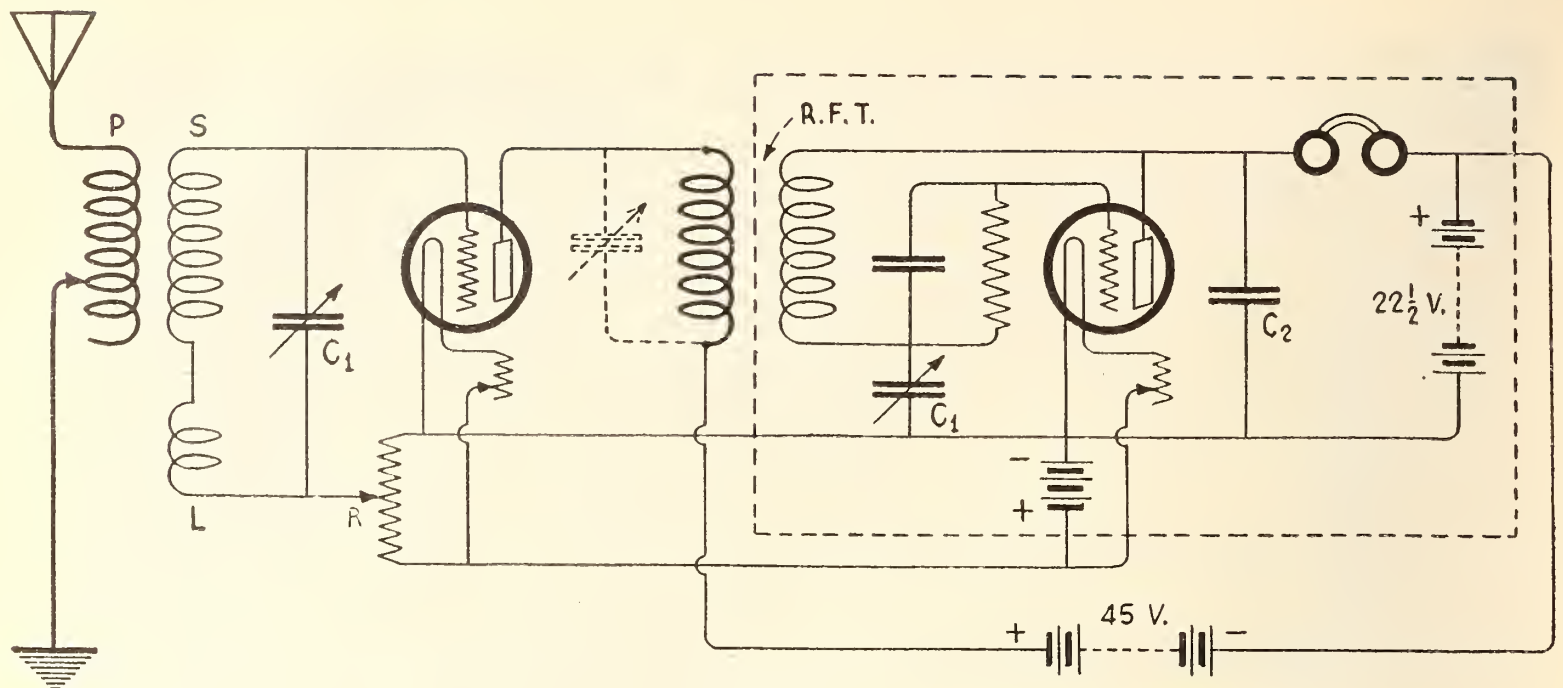

FIG. 8

The dotted lines bound the original Colpitts Oscillator circuit and the radio-frequency amplifier is at the left. Very little alteration in apparatus is necessary to obtain this R. F. amplification

by the dotted lines on the diagram, but which is not required when a standard transformer is used. (Incidentally, employing the arrangement outlined for the home-made primary and secondary, the amplifier is changed to the pure-tuned type, and while adding an additional control, it is, on the whole, the more efficient system.)

The 200- to 400-ohm potentiometer is that usually employed with radio-frequency apparatus. Our readers are familiar with the remainder of the circuit.

The theoretical operation of the amplifier, and the apparent lack of rectification in the first tube (viz., the passing on of the radio wave as an alternating current) is of interest to the student reader. It is suggested that he study the article on R. F. amplification published in the August, 1922, issue of RADIO BROADCAST. Several subtleties coincident with this system of amplification are there explained.

The truth is, as our correspondent has suggested by referring to the audion's single-way conductivity, that the radio wave is rectified in every tube through which it passes. The alternating currents or radio oscillations which are passed to the succeeding tubes are not the original wave (which of course was effectually blocked by the first tube), but is its amplified duplicate which is generated in the plate circuit of the tube. When the grid of the R. F. amplifier is adjusted in a certain way (see the article just mentioned in the August issue) by the potentiometer, the direct plate current will rise and fall in perfect synchronism with and in proportion to the alternations of the incoming wave. The primary of the amplifying transformer is a part of the plate circuit, and it follows that the rise and fall of the plate current, which flows through it, is accompanied by a corresponding rise and fall of the magnetic flux which is set up by the current. (Electricity in motion always "generates" a magnetic field.) This magnetic flux necessarily "cuts" the secondary of the R. F. transformer, and by the law of induction induces an alternating current therein—an alternating current of the same wavelength or frequency as the original wave intercepted by the antenna.

It is quite obvious that this arrangement will block the passage of any oscillations generated in the detector circuit

back through the R. F. amplifier and out to the antenna—thus eliminating radiation, the greatest objection to this "flivver" circuit.

For the audio amplifier data, our inquirer is referred to the July 1923 issue of RADIO BROADCAST.

#### WAVELENGTH AND SIZE OF COILS

*I am sure that many of your readers, in common with myself, have many occasions for winding coils for various wavelengths. Will you please publish a formula for determining the wavelengths of different coils, or, more correctly, the method for designing inductances for different waves?*

O. J., New York City.

THERE is, of course, a formula (in fact there are several of them) for determining the required number of turns of wire in a coil for a desired wavelength. However, the application of these formulas is a comparatively difficult task, involving calculations of distributed capacity, spacing, diameter of the coil, inductance, etc., to say nothing of various correction formulas. These are complications that make such formulas useless to any one but the radio engineer, and luckily, they are really unnecessary except when calculations must be made with mathematical precision. An explanation, which would necessarily accompany the publication of these formulas, would be interesting to only a very small percentage of our readers. Such readers interested in the theory of coil design, are referred to *The Wireless Experimenter's Manual*, by E. E. Bucher, where this subject is treated very comprehensively.

For the average radio enthusiast, the correct winding of inductances is much more conveniently described in simple tables, which involve no subsequent mathematical calculations.

Chart 1 is quite self-explanatory, indicating the number of turns, size of winding forms, etc., for primary, secondary, and tickler coils on the wavelengths in which the broadcast enthusiast is most interested. These calculations are only approximate, and are based on average values of antenna capacity, etc. In order to secure the indicated wave range,

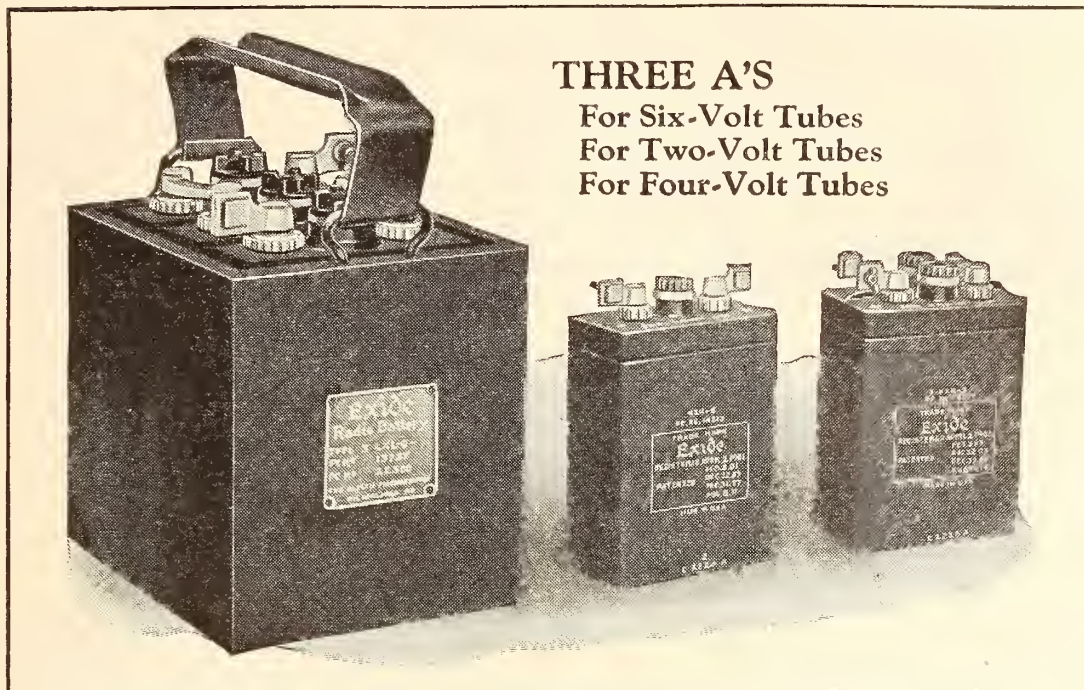

## If you take radio seriously

**Y**OU want to tune in distant stations, but there is another thing you want just as keenly—to get what you get *clearly*.

No matter how far or how near the station is, for greatest clearness and for all-round satisfaction, you must use storage batteries. Once you hook up to Exide Radio Batteries you will never be satisfied with anything less. They give uniform current, smoothly, quietly, over a long period of discharge. Like good little boys, they are seen and not heard.

### For low-voltage tubes

The two newest members of the Exide family are midgets in size but giants in power. These sturdy little A batteries weigh only five and six pounds each. They furnish in full measure that uniform and unfailing power so essential to clarity and distant reception.

They were specially designed for WD-11 and UV-199 vacuum tubes, but can be used with any low-voltage tube. The two-volt Exide A Battery consists of a single cell. It will heat the filament of a WD-11 or other quarter-ampere tube for approximately 96 hours. The four-volt A battery, having two cells, will light the filament of a UV-199 tube for 200 hours.

### For six-volt tubes

Like all Exide Storage Batteries, the Exide A Battery for six-volt tubes is dependable and long-

lasting. It is made in four sizes—of 25, 50, 100, and 150 ampere-hour capacities.

### On land, at sea and in the air

It is the experience back of Exide Batteries that makes the Exide give such exceptional service in radio. There is an Exide Battery for every purpose. Exides run trucks, start and light automobiles, operate drawbridges, propel under the sea a majority of the world's submarines, send your voice over the wire every time you use the telephone.

A majority of all government and commercial radio plants both on land and at sea are equipped with Exide

Batteries. The Leviathan is Exide-equipped. The giant dirigible "Shenandoah" carries Exide Batteries for ignition, lights and radio.

It does not pay to get any but a known-to-be-reliable storage battery for radio. Exide Radio Batteries are sold by radio dealers and Exide Service Stations everywhere. Ask your dealer for booklets describing in detail the Exide Radio Batteries, or write us direct.

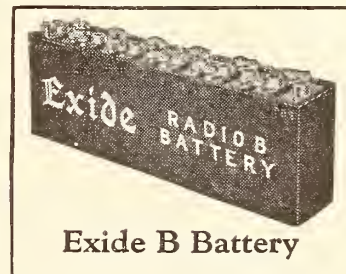

Exide B Battery

# Exide<sup>★</sup>

## RADIO BATTERIES

THE ELECTRIC STORAGE BATTERY COMPANY, PHILADELPHIA

Manufactured in Canada by Exide Batteries of Canada, Limited, 133-157 Dufferin Street, Toronto

★ Tested and approved by RADIO BROADCAST ★

CHART I

Wavelength Range in Meters	Size of Primary Tube	Size of Secondary tube (or ball)	Turns on Primary	Turns on Secondary	Turns on Tickler
175 to 220 (amateur)	3½"	3" ball or 2½" tube	12	30	40
220 to 500 (broadcast)	same	same	40	40	60
350 to 650 (upper broadcast and commercial)	same	same	60	80	80

CHART II

Type of Signal	Wave Range	Primary	Secondary	Tickler
Commercial	450-700 900-1400	DL75 DL100	DL100 DL150	DL100 DL100
High commercial, And Time Signals (NAA)	1560-2750	DL300	DL300	DL100
Long Wave	8000-15000 10000-20000	DL600 DL1000	DL750 DL1250	DL300, 400 or 500 DL300, 500 or 600

CHART III

It is always a good idea to use the largest possible coil for a given wave. Boosting it up by the addition of a shunt capacity is inefficient and results in loss of signal strength.

a .001 mfd. condenser must be shunted across the secondary coil. Sharper tuning and a greater wave range may also be had by using a similar variable condenser in the antenna circuit, with a series-parallel switch, permitting its use in series with the antenna, and in shunt with the primary.

The number of turns in Chart I apply equally well to straight windings, honeycombs, or the average spider-web.

If the last division in Chart I (No. 3) is used, and the coils tapped, the wave range will include all those given for the smaller coils.

For wavelengths in excess of those covered in the first chart, the reader is referred to Chart No. 2, which spans the higher wavelengths, which can only be attained, practically, by the use of honeycomb coils (duolaterals).

Chart 3 gives the wavelengths of honeycomb coils used singly, and shunted by .001 mfd. condensers. This data is useful in wavemeter work and in the construction of single circuit tuners for long wave reception. The relation between wavelength of a given coil and its number of turns is clearly shown by the charts.

Coil Number	Approximate wave range with .001 shunt condenser
DL25	170-375
DL35	200-515
DL50	240-730
DL75	330-1030
DL100	450-1460
DL150	660-2200
DL200	860-2850
DL250	1120-4000
DL300	1340-4800
DL400	1860-6300
DL500	2340-8500
DL600	2940-12000
DL750	3100-15000
DL1000	5700-19000
DL1250	5900-21000
DL1500	7200-25000



## Supplemental List of Broadcasting Stations in the United States

LICENSED FROM NOVEMBER 17 TO DECEMBER 14 INCLUSIVE

CALL SIGNAL	LOCATION	FREQUENCY (Kilocycles)	WAVE-LENGTH	POWER WATTS
KFLX	Galveston, Texas	1250	240	10
KFLY	Fargo, N. Dak.	1300	231	20
KFLZ	Atlantic, Iowa	1100	273	10
KFMO	Fayetteville, Arkansas	1140	263	100
KFMR	Sioux City, Iowa	1150	261	50
WABQ	Haverford, Pa.	1150	261	50
WABR	Toledo, Ohio	1110	270	50
WABS	Newark, N. J.	1230	244	50
WABT	Washington, Pa.	1190	252	100
WABU	Camden, N. J.	1330	226	100
WABV	Nashville, Tenn.	1140	263	20
WBR	Butler, Pa.	1050	286	250
WOAR	Kenosha, Wis.	1310	229	50
WWAO	Houghton, Mich.	1230	244	250

HOW FAR HAVE YOU HEARD?

PRICE  
25 CENTS

MARCH,  
1924

# RADIO BROADCAST

The Truth About Trick Circuits

Shooting Trouble in the "Super-Heterodyne"

What Makes the Wheels  
Go 'Round

An Ideal Antenna



*His Master's Vice*

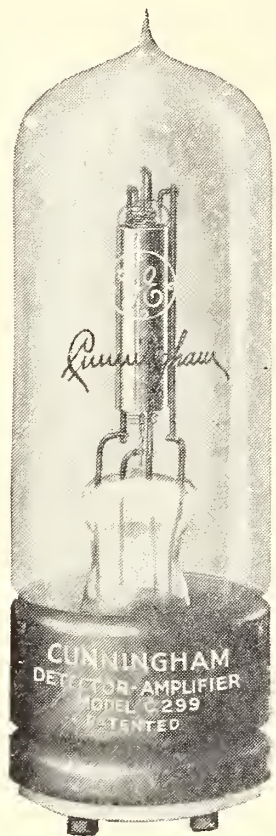

# Cunningham

## RADIO TUBES

*The Superior Tube  
for Radio Receiving Sets*



### Cunningham Radio Tubes

C-301A—5 Volts 1-4 Ampere filament .....\$6.50  
 C-299—3 Volts .06 amp. Dry Battery Det. and Amp. \$6.50  
 C-300—5 Volts Gas Content Detector .....\$5.00  
 C-11—1.1 Volts .25 amp. Dry Battery Det. and Amp. Special Base .....\$6.50  
 C-12—Similar to C-11 with standard base .....\$6.50

#### PATENT NOTICE

*Cunningham tubes are covered by patents dated 11-7-05, 1-15-07, 2-18-08, and others issued and pending. Licensed for amateur, experimental and entertainment use in radio communication. Any other use will be an infringement.*

**C**unningham Radio Tube Type C-299 is a Detector and Amplifier of the high vacuum type, designed especially for dry battery filament current supply. The special filament in this tube draws a current so low that as many as four tubes may be readily operated from a single set of three standard No. 6 dry cells. The ideal tube to use in your set.

*The care and operation of each model of Receiving Tube is fully explained in our new 40-page "Radio Tube Data Book." Copies may be obtained by sending ten cents to our San Francisco office.*

*R. J. Cunningham Inc.* ★

Home Office: 182 Second Street  
San Francisco, Calif.

154 W. Lake Street  
Chicago, Ill.

30 Church Street  
New York City, N. Y.



The  
FERBEND

TRADE MARK  
PATENT APPLIED FOR  
**Wave Trap**  
**STOPS INTERFERENCE**

★ To Get "Out of Town"—first Tune Out that Local Station!

It isn't hard to receive nowadays, on most any good set, from stations all over a country as big as the United States—if the nearby station doesn't interfere. Even then, if your set is extremely selective, and if you have the right antenna, and if you are an expert at tuning—and if you have good luck—you can perhaps tune out the offending transmitter.

But it happened that Wm. L. Mann, of 767 N. Fortieth St., in Philadelphia, didn't have all these things—so he just

bought a FERBEND WAVE TRAP, and now he says he has no trouble tuning out any of the four big Philadelphia stations. The same thing can be done (probably is being done) in your town. Try it!

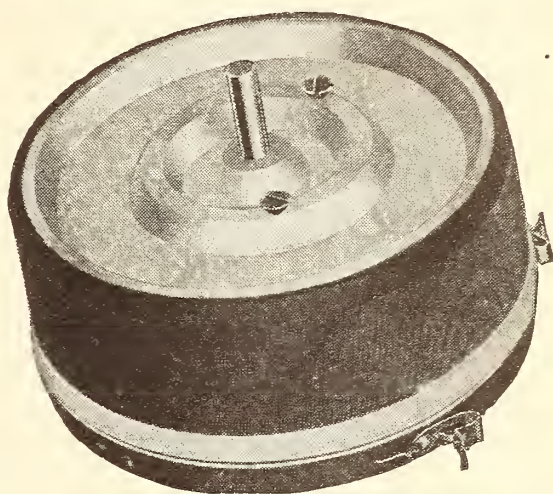

Unmounted ready for panel mounting.  
**\$6.00 POSTPAID**

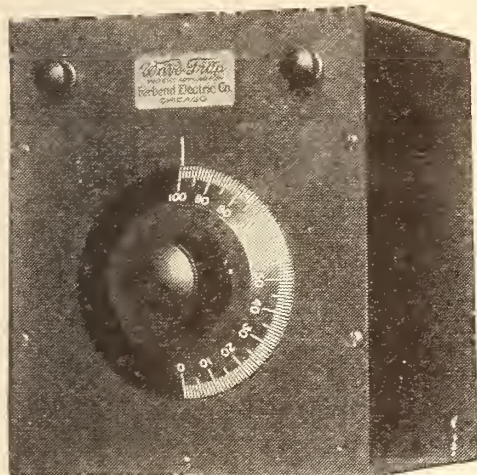

Mounted on Formica panel in Mahogany finished cabinet 6 x 5 x 6  
**\$8.50 POSTPAID**

**ANY NIGHT is "SILENT NIGHT" with a FERBEND!**

Send us your order now, or write us for full information

*Do not be misled by imitations. The FERBEND WAVE TRAP is the first inductive as well as the original WAVE TRAP. It is not assembled haphazardly from standard parts, but is made up of special parts designed and manufactured by us for the sole purpose for which they are used.*

**"The Original Wave Filter"**

**Ferbend Electric Company**  
**19 E. South Water St. Chicago**



# Radio Broadcast

ARTHUR H. LYNCH, EDITOR

## MARCH, 1924

MAJOR-GENERAL GEORGE O. SQUIER AND COLONEL SALTZMAN - - -	<i>Frontispiece</i>	
BROADCASTING COMPLETE AMERICAN PROGRAMS TO ENGLAND	<i>W. W. Rodgers</i>	359
THE TRUTH ABOUT TRICK CIRCUITS. - - - - -	<i>Zeb Bouck</i>	365
THE MARCH OF RADIO - - - - -	<i>J. H. M.</i>	371
HOW TO INCREASE YOUR RANGE - - - - -	<i>Arthur H. Lynch</i>	380
WHAT WE THINK THE PUBLIC WANTS - - - - -	<i>E. F. McDonald, Jr.</i>	382
1923 PASSES IN REVIEW - - - - -	<i>J. H. Morecroft</i>	385
WHY NO RECEIVER CAN ELIMINATE SPARK INTERFERENCE -	<i>L. A. Hazeltine</i>	397
SOUND: A MATTER OF PERSONAL OPINION - - - - -	<i>R. H. Marriott</i>	400
IN THE R. B. LAB - - - - -		402
Adding R. F. to a Standard Three Circuit Set	The Single Circuit Set and the Sodian Tube	
A "Relay" Soldering Iron for Fine Work	Leaves from an Old Timer's Notebook	
Building Your Own Laboratory		
TAKING OHMS OUT OF AN ANTENNA - - - - -	<i>L. M. Hull</i>	406
SHOOTING TROUBLE IN THE SUPER - - - - -	<i>A. J. Haynes</i>	413
HOW FAR HAVE YOU HEARD? - - - - -		420
HAMS ACROSS THE SEA - - - - -		422
IS THE BROADCAST LISTENER AT FAULT? - - - - -	<i>Carl Dreber</i>	424
WHAT MAKES THE WHEELS GO 'ROUND		
Part I. One Syllable Electrical Theory - -	<i>Walter Van B. Roberts</i>	426
ADDITIONAL BROADCASTING STATIONS IN THE UNITED STATES - - - - -		435
THE GRID - - - - -		436
Adding R. F. to Any Receiver	B Battery Trouble	
A Standby Set	Oscillation of a R. F. Amplifier	
NEW EQUIPMENT - - - - -		442
AMONG OUR AUTHORS - - - - -		444
MORE ABOUT THE SUPER-HETERODYNE - - - - -		446
HOW SPARK INTERFERENCE WAS REDUCED - - - - -		446

Copyright, 1924, by Doubleday, Page & Co. All rights reserved

TERMS: \$3.00 a year; single copies 25 cents

F. N. DOUBLEDAY, Pres.

RUSSELL DOUBLEDAY, Sec'y.

ARTHUR W. PAGE, Vice-Pres.

S. A. EVERITT, Treas.

NELSON DOUBLEDAY, Vice-Pres.

JOHN J. HESSIAN, Asst. Treas.

DOUBLEDAY, PAGE & CO.

THE WORLD'S WORK

COUNTRY LIFE

THE GARDEN MAGAZINE

SHORT STORIES

EDUCATIONAL REVIEW

CHICAGO: People's Gas Bldg.

GARDEN CITY, N. Y.

NEW YORK: 120 W. 32nd Street

BOSTON: Tremont Bldg.

LOS ANGELES: Van Nuys Bldg.



# A Radio Statement to the Public

**K**EEPING its pledge to the public, the Radio Corporation of America has concentrated its vast research and engineering forces upon the solution of certain fundamental problems facing the art—problems which have become more apparent as broadcasting stations and radio receivers multiply.

The phenomenal expansion of the radio industry, and the universal and ever-increasing appeal of radio represent an outstanding development of the present century—for this industry has grown from infancy to maturity in a space of but two years.

Briefly stated, there is today a necessity for

—*A radio receiver providing super-selectivity*—the ability to select the station you want—whether or not local stations operate. A selectivity which goes to the theoretical limits of the science.

—*Super-sensitiveness*—meaning volume from distant stations—along with selectivity.

—*Improved acoustics*—more faithful reproduction of broadcasted voice and music than has ever been possible before.

—*“Non-radiating” receivers*—a new development—a type of receiver which, no matter how handled, will not interfere with your neighbor’s enjoyment.

—*More simplified operation*—a super-receiver requiring no technical skill, thus making the greatest achievements of entertainment immediately available to all members of the family.

—*A receiver for the apartment house* and populated districts, requiring neither aerial nor ground connection.

—*Another type of improved receiver for the suburban districts*, equally capable to that above, for use where the erection of an aerial presents no problem.

♦ ♦ ♦

Painstaking search in quest of these ideals has led to new discoveries, setting new standards of excellence and performance—discoveries, which have established:

*First*—that improved acoustics are possible—a matter of scientific research and not of haphazard design—for truly melodious reception.

*Second*—that dry battery operated sets can be so designed as to give both *volume* and distance.

*Third*—that the regenerative receiver is susceptible to marked improvement providing selectivity, sensitiveness and simplicity of operation hitherto deemed impossible of accomplishment.

*Fourth*—that the Super-Heterodyne—the hitherto complicated device requiring engineering skill to operate—could be vastly improved—improved in sensitiveness and selectivity—and simplified so that the very novice and the layman could enter new regions of entertainment and delight.

*Watch For Further Announcements*

Radio Corporation of America



*Sales Offices:*

233 Broadway, N. Y. C.    10 So. LaSalle St., Chicago, Ill.    433 California St., San Francisco, Cal.

# Radiola

REG. U. S. PAT. OFF.

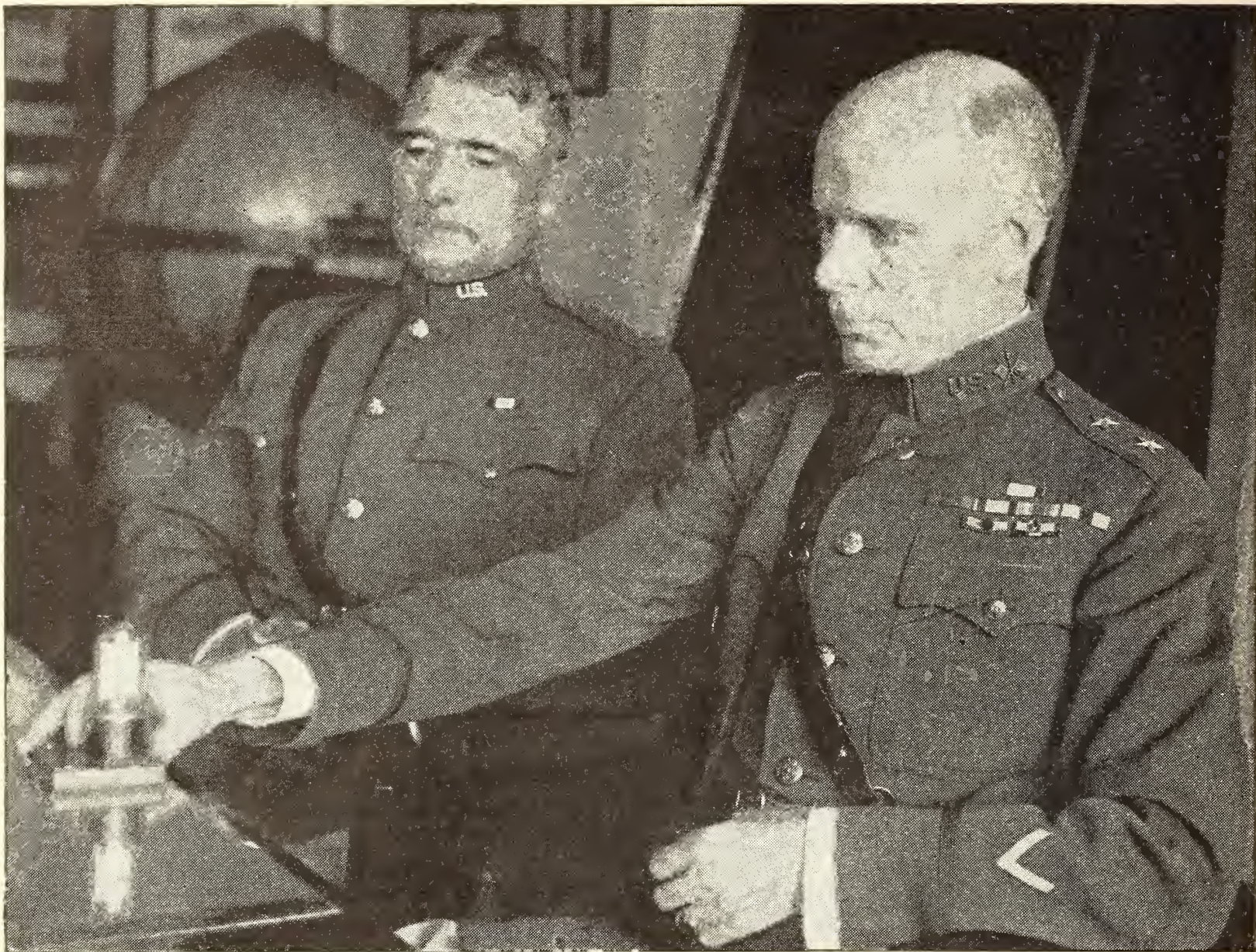

© Harris & Ewing

#### HAIL AND FAREWELL

Major General George O. Squier, right, seated with Col. Charles McK. Saltzman who has recently succeeded him as chief signal officer of the Army. General Squier is returning to private life, after forty years of active service—one of the best known men in radio. "Wired wireless" is attributed to him as well as other developments and technical refinements in radio. Col. Saltzman is well suited to assume charge of the Signal Corps, since he has previously done much in the administration of the Corps

# RADIO BROADCAST

Vol. 4 No. 5



March, 1924

## Broadcasting Complete American Programs to All England

How KDKA Programs on Only 94 Meters Were Heard in England Even  
Over Lowly Crystal Sets. What Broadcast Repeating May Mean

By W. W. RODGERS

**I**NTERNATIONAL broadcasting, three months ago only an imaginative theory, is now an actual fact, due to the great progress made in relaying or repeating broadcasts, by means of high frequency waves.

Short waves or high frequency broadcasts—both terms have the same meaning—have opened up a new field in broadcasting. The first test completed at the very start of the New Year open up possibilities that promise extremely rapid developments in 1924.

The first complete international repeating of concerts was accomplished by the Westinghouse Electric and Manufacturing Company coöperating with the Metropolitan-Vickers Electric Company at Manchester, England. There is a kind of unusual justice that KDKA, one of the pioneer broadcasting stations should be the first radio station to transmit concerts to England on a thoroughly accurate basis.

Radio moves so swiftly these days that events tread upon the very heels of one another. The transatlantic tests, sponsored by RADIO BROADCAST, the *Wireless World and Radio Review* (London) and the British Broadcasting Company used the old method of transmitting

programs. These had hardly been completed to the satisfaction of the world, when this new scientific feat was accomplished and the latter was so much more satisfactory that there was hardly a comparison between the old method and this new method started by the Westinghouse Company. The old method of transatlantic reception, as all readers of RADIO BROADCAST know, is the same as receiving the concerts in the United States. The station trying to reach England sends out advance notices and then on a prearranged night sends its concert. Those on the other side, know the hour the concert will be broadcasted and listen patiently for the signals. Sometimes on favorable nights, the operator equipped with an extremely sensitive receiver will hear fragments of the concert, but he is never certain to get the signals. The drawback to this method is, of course, the fact that only a small minority of the people living in a country can hear these transatlantic signals because it is only the small minority who own high-priced, very sensitive receiving apparatus. The great mass of the people depend upon the one—or two—tube sets—the English call them “valves”—for the reception of the concerts.

No reception is certain by this method. The listener must be ruled by the god of static, and the good or bad genii of "conditions." It is at best a haphazard arrangement.

But now comes the perfection of the short wave, or high frequency broadcasts. The first announcement of the use of high frequency or very short wavelengths came late last year when Station KFKX, the first radio repeating station in the world, was opened at Hastings, Nebraska. This station is near the exact geographical center of the United States for the purpose of repeating the broadcasts of KDKA, at East Pittsburgh, Pa. It was built to bring the concerts of KDKA to the people of the entire country. The normal range of KDKA was greatly increased because of the repeating station, and the people on the West Coast, who heretofore, had not heard that station, except on very sensitive multi-tube sets, began to pick up Pittsburgh with average receivers.

The same principle as used in rebroadcasting from KFKX at Hastings was used in the repeating of concerts in England. The same waves were used as were sent to KFKX, in fact the same transmitter broadcasting its very short waves to the Hastings, Nebraska station simultaneously carried the concert to England for repeating.

All this development in short wave application was accomplished in the last two years'

experimenting with these short waves by Frank Conrad, assistant chief engineer of the Westinghouse Company. He had found in his experimenting that the short waves go farther with the same power than do the longer waves and had also made the revolutionary discovery that the short wavelengths were not affected by daylight in nearly the same degree as are the ordinary waves now used in broadcasting. Interference from other stations, of course, at that frequency, did not exist.

Thus, since a medium by means of which broadcasting could be carried on at great distances without interference was at the engineer's command, no barrier opposed international broadcasting. But the proper cooperation from the other side of the Atlantic involved many problems, which though not apparent to the public, took nearly a year to perfect. International broadcasting, brought to a climax with the New Year, really started early in 1922, yet so quietly were the developments made that, at the time of the trans-Atlantic tests last November, few in the broadcast world had even hinted at the possibilities of the repeating station.

#### HOW THE PLANS WERE QUIETLY MADE

IN THE summer of 1922, Mr. A. P. M. Fleming, manager of the research department of the Metropolitan-Vickers Electrical

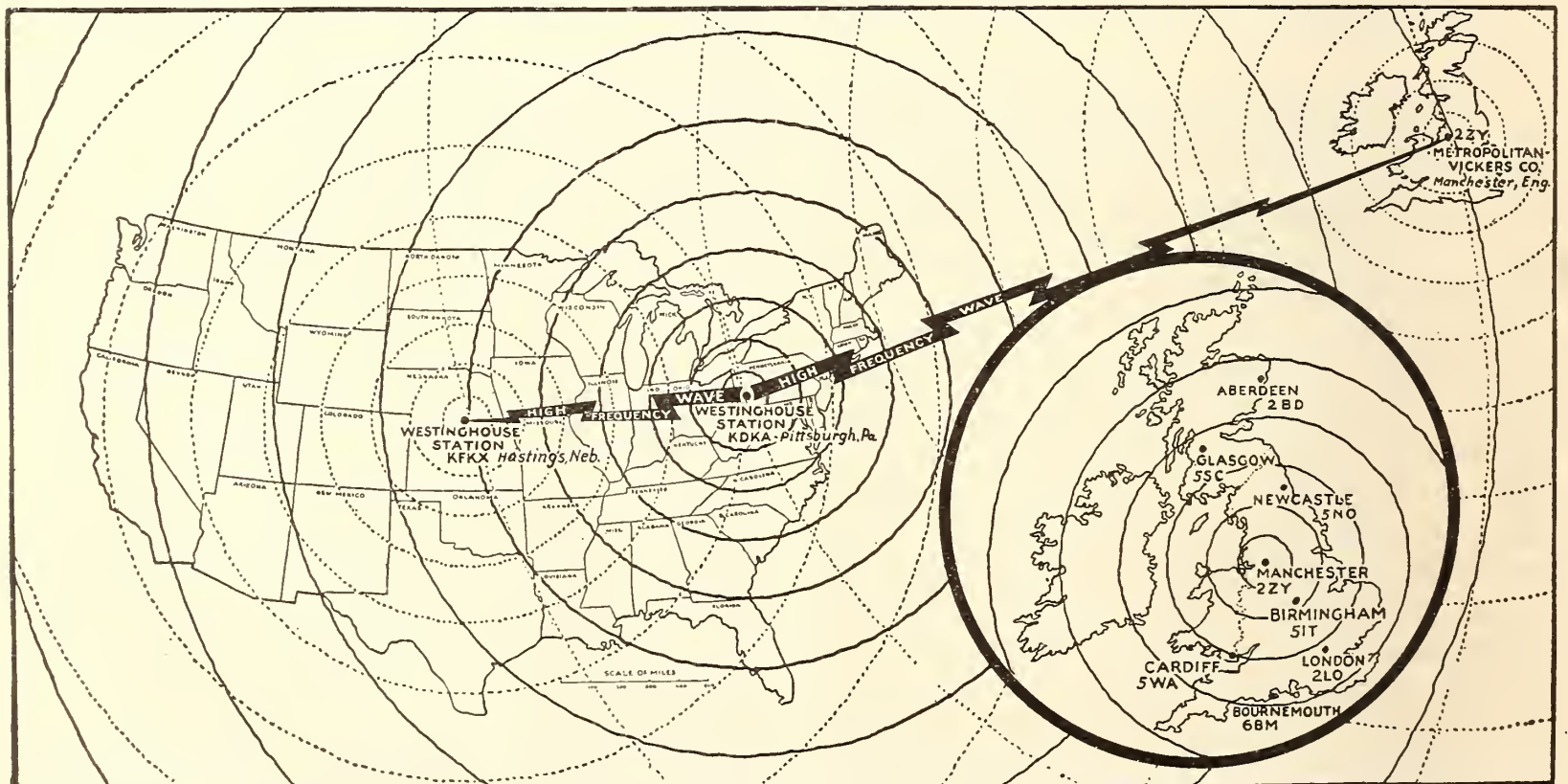

#### HOW KDKA'S 94 METER WAVE TRAVELS

KFKX at Hastings, Nebraska, and the stations of the British Broadcasting Company rebroadcast the short waves with the regular transmitter so that any one with a simple receiver can pick the signals up

Company, visited the engineering department of the Westinghouse Company. During this visit, he talked with Mr. Conrad, Mr. Davis, and others of the officials interested in broadcasting and was told of the short wave tests and how this new medium promised great developments in the radio field. It was in a talk with Mr. Davis that the idea for this international broadcasting was started.

Mr. Fleming told Mr. Davis of the broadcast situation in England at the time and though the possibilities were there, the thought seemed literally and metaphorically a very ethereal subject because while the United States had been very thoroughly "sold" to radio broadcasting, in England the furore was just starting. The public had not caught the enthusiasm. Many of the English newspapers were even severely critical of the future of broadcasting.

Despite the uncertain broadcasting situation in England, the research department of the Metropolitan-Vickers research laboratories were at the time working on the radio problem and had high hopes for radio broadcasting in England. As a matter of fact, scarcely had Mr. Fleming returned when the radio storm broke and swept over England in the same manner it had swept the United States.

During the later months of organization, the British Broadcasting Company was formed, an organization which has a monopoly on broadcasting in England. The company is an association of manufacturers operating broadcasting stations. Those comprising the association of



MR. H. P. DAVIS

Vice-President of the Westinghouse Company, before the microphone at KDKA where he sent New Year greetings to England at 7 p.m. on December 31, 1923. It was just midnight in England



MR. FRANK CONRAD

Assistant chief engineer of the Westinghouse Company, who was largely responsible for the success of the short wave broadcasting

broadcast stations include the following—2LO, London, 363 meters; 6BM, Bournemouth, 385 meters; 5WA, Cardiff, 353 meters; 5SC, Glasgow, 415 meters; 5IT, Birmingham, 423 meters; 5 NO, Newcastle, 400 meters; 2AC, Manchester, 370 meters; and 2BD, Aberdeen, 495 meters. These stations besides operating independently of each other are also linked by land wire so that in the event of an important happening in one section of the country, the stations can be linked together. Simultaneous broadcasting from all eight stations occurred in RADIO BROADCAST'S test of last November.

This was the situation when the "Metro-Vick" Company began testing with East Pittsburgh on short wavelengths. After leaving America, Mr. Fleming had not been forgotten by the Pittsburgh broadcast officials and they were constantly in correspondence with him regarding the progress of developments with the high frequencies. After the success of the short wave tests in the United States, the English Company installed a private high frequency receiver in its plant at Manchester, England to test with the broadcasts of KDKA and particularly with the broadcasts sent to KFKX.

After many weeks' testing and frequent changes in the design of various units in the high frequency receiver, the results showed a stable reception and one that could easily be

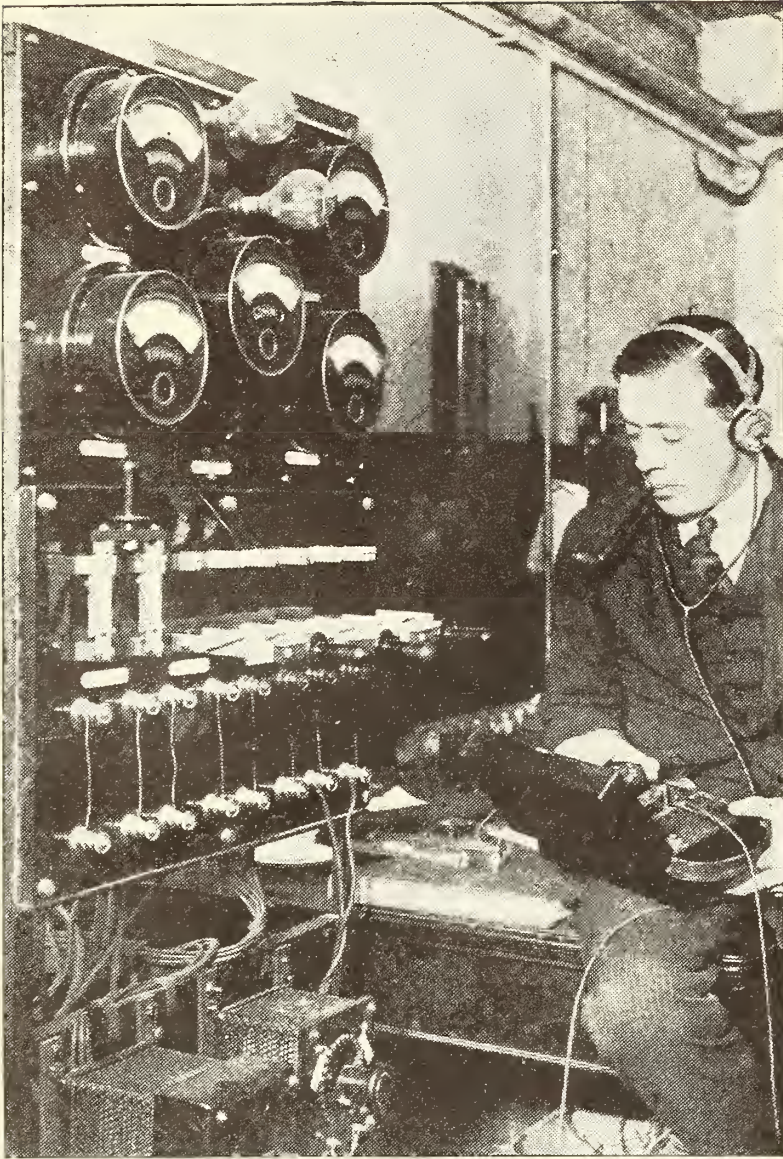

“THIS IS 2LO, LONDON”

And Captain E. P. Eckersley, chief engineer of the British Broadcasting Company with a wavemeter and long wavelength pipe testing their radiated wave. 2 LO was one of the stations to rebroadcast KDKA's short wave program

placed on the air in England whenever desirable. So the Metropolitan-Vickers Company sent the program out through “Merrie” England and the European continent for the first time, December 29, 1923. The other seven British broadcasting stations were linked in by land phone with the result that all of them were broadcasting KDKA's concerts, a feat never before accomplished.

Of course, this wasn't the first time KDKA had been heard in England. As a matter of fact, KDKA has been receiving hundreds of letters from all parts of the world, telling of the reception of its concerts on its regular wavelength, but the receivers of these broadcast signals did it with multi-tube sets and then the reception at most was greatly dependent upon weather conditions and was quite haphazard. However, here was an actuality that gave every one in the ordinary broadcast range of the English stations, (which, by the way, are

limited by law to an output of three kilowatts and which usually operate much below that figure), an opportunity to listen-in.

Knowing from the cables that passed back and forth between England and the American company that the proper time had come to exchange international greetings, arrangements were made to repeat KDKA's concerts throughout England through the Metropolitan-Vickers pick-up with Mr. H. P. Davis of the Westinghouse Company sending the greetings. Mr. Davis gave his New Year's greeting from the East Pittsburgh Studio of KDKA at seven o'clock, Eastern Standard Time Monday evening, December 31, 1923. Because of the difference in time—five hours—this was exactly midnight in Great Britain and Mr. Davis's speech was the first greeting received in the Old World from the New, for the coming year. Mr. Davis said:

“To the people of Great Britain in this New Year's Eve, I send greetings from America and express to you the wish of every American—that Great Britain and her European neighbors may enjoy a prosperous, peaceful, and progressive New Year.

“That the means of communication have been greatly advanced during the past year is fitly shown by the fact that I am able to speak directly to you, across an intervening ocean. This achievement will ultimately result in making known to you America's daily events and your every day happenings known to us.

“A year ago such an achievement seemed beyond belief. With such advancement in the radio art an established fact, no man dares predict what developments will take place before another New Year.

“It is a wonderful thing for the world—this achievement which enables the peoples of one continent to “listen in” on the activities of the peoples of another continent—for the friendship of nations is founded on closer understanding among the various peoples and in no way can different nations better understand each other and become more closely in touch with each other than by improved means of rapid and accurate communication.

“It is also fitting that Westinghouse Station KDKA, the pioneer broadcasting station of the world, should be the first station to develop a means for the repeating of its programs to you, the peoples of other continents, for it was here, and by this station, from which I am now

sending this message, that radio broadcasting was first undertaken. This feat is only another progressive step in the development of this great utility.

"On behalf of the people of America, it is my great privilege, therefore, for the first time in history, by means of the spoken word, to speak directly to you the wish for a happy and prosperous New Year."

The announcer at the time Mr. Davis spoke was an Englishman, chosen because of the fact that his decided English accent would be an added touch to the broadcasting. This announcer was Mr. Sidney Nightingale, who prefaced the speaker's remarks.

An aftermath of Mr. Nightingale's announcing came the next day in a message from his mother, Mrs. J. R. Nightingale of Manchester, England. This lady listened to her son's announcing 3,900 miles away. It is safe to say that a mother, any mother for that matter, after hearing her son's voice coming so far would feel quite proud, but she was particularly proud that her son's voice should be the first that came over from America to be repeated by these British stations.

So, just a year after a speculative talk in the offices of Mr. Davis at East Pittsburgh, the theory of the future had become the established fact and international broadcasting had become a scientific accomplishment.

For this rebroadcasting, KDKA transmits to England on 94 meters (3,200 kilocycles), the same frequency or wavelength at which it transmits to Hastings, Nebraska. The wavelengths of the English stations have been listed earlier in this article and are not important except as being a definite link between the 94 meters of KDKA and the broadcast listener of the Old World.

The antenna at East Pittsburgh used for this repeating radio transmission is not more than thirty-five feet long. This is much smaller than the antenna required for ordinary broadcasting. There are only thirty-five feet between flat top and counterpoise. The antenna and counterpoise consist of two small cages.

One of the difficulties of short wave broadcasting is that every precaution must be taken to prevent any outside influences, such as vibration, that would change the frequency. The vibration of the ground or the swinging of the antenna would serve to throw the set off its frequency. To guard against the possibility of swinging, the East Pittsburgh short wave antenna, including the flat top and counterpoise, are stretched between cross arms rigidly attached to the tower instead of the more common swinging spreaders.

The lead-in from the antenna to the counterpoise consists of copper tubing rigidly mounted on long high voltage porcelain insulators on the poles. The various inductances on the set are wound on rigid forms. Copper tubing is used to make all the connections.

The short wave set at East Pittsburgh is located on the top of a nine-story building and is subjected to the usual jars. But the set is therefore suspended on a system of springs, and vibrations of the building cannot affect the operation of the set.

The transmitting set at East Pittsburgh con-

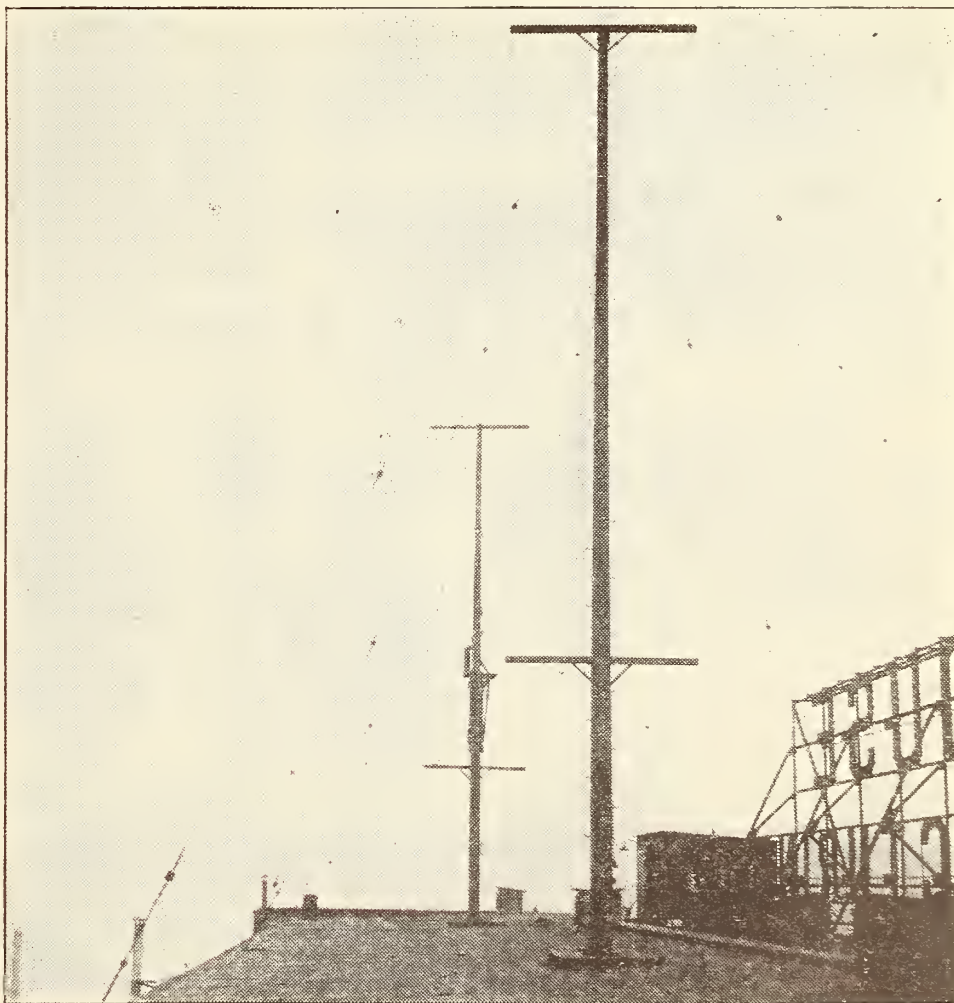

THIS ANTENNA RADIATES ON 94 METERS

And is only 35 feet long. Note that the spreaders are tightly fixed to the masts, in order to prevent any swinging of the wires and consequent slight variation in the radiated wave. This is the antenna used in sending to England and to KFKX, the "repeater" broadcasting station at Hastings, Nebraska

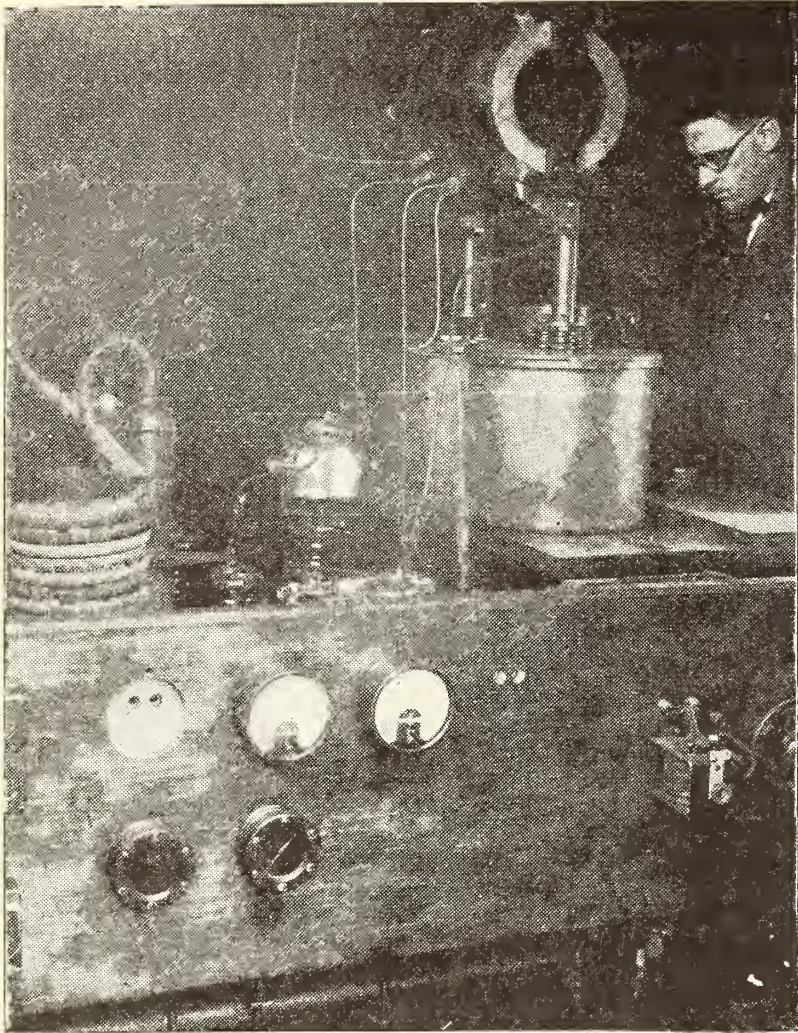

#### THE 94 METER TRANSMITTER

In use at KDKA to send programs to Hastings, Nebraska. The transmitter is supported on heavy springs so local jars will not change the wavelength adjustment

sists of three panels: the rectifier panel, the modulator panel, and the oscillator panel. The rectifier converts the high voltage A. C. current, obtained by stepping up the ordinary plant current supply to high voltage D. C. for the plate circuit. The modulator with its accessories impresses the voice frequency on his high voltage D.C. current before it goes to the oscillator. Finally the oscillator converts the high voltage D.C. currents into radio frequency, in which form it is delivered to the antenna.

Although this article tells primarily of repeating of concerts in England, that all the while that the very short waves of 3,200 kc. are

going across the ocean to be received in Great Britain, similar waves are going out to Hastings, Nebraska, where they are being repeated through Station KFXX. Therefore, when KDKA goes into operation, with the repeating equipment in England and at Hastings, Nebraska, the station is covering nearly half of the world.

Not only is this an enormous scientific and engineering achievement but it is also a great step forward toward better international relations. By means of this amazing means of communication, the human touch is possible over thousands of leagues of ocean and it must prove a thing of inestimable good, bringing as it does whole continents into personal communication, which is bound to result in that better understanding so vitally necessary for any lasting peace.

C. W. Horn, superintendent of radio operations of the Westinghouse Company, a man who is very close to the broadcast situation, sees something significant in the English repeating. According to Mr. Horn it sounds the death knell of those stations who either can't or won't put on the air the best of programs. The pace that is being set is very swift and, Mr. Horn thinks, those who can't maintain it will fall by the wayside.

Significantly, the repeating of these English concerts brings to mind the remarks of Mr. Davis, one year and a half ago, relative to the broadcast situation. At that time he said that the only way to obtain the greatest possible good out of radio was to have a few modern powerful and efficient transmitting sets located in such manner as to serve various districts. Within these districts there would be located repeating stations which would repeat efficiently the concerts broadcasted by the central station. Developments of the last few months seem to indicate that this may be the ultimate in broadcasting and with events moving so swiftly, the new year may give the answer.

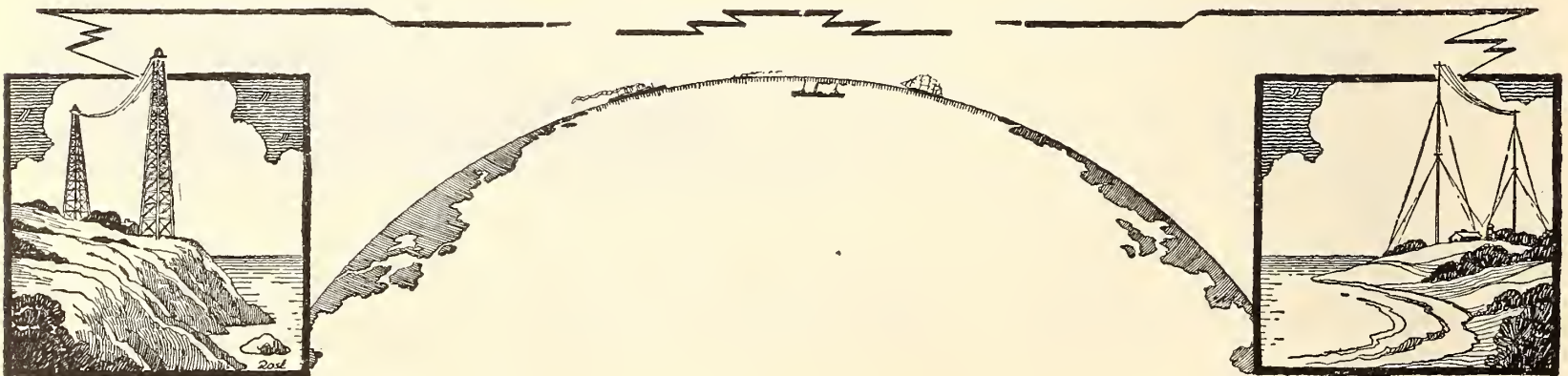



# The Truth About Trick Circuits

## PART IV

### Various Circuits and What They Mean

By ZEH BOUCK

**N**O, THERE are very few things in this world bearing the imprint of originality to such an extent as to justify the descriptive "new"—whether it be vitamins or radio circuits. But there exists a psychological attraction in scientific things called "new", and if the lack of antiquity is made at all convincing, the public will do anything from nauseating itself with yeast cakes, to stretching its spine one half inch a day, or wasting solder and patience on misrepresented radio circuits.

The only systems which have made their appearance since the Great War that embody original principles not found in previous equipment, are the super-regenerative and the super-heterodyne. The reflex dates back to the pioneer days of bulb reception, while the neutrodyne principle is a century old—though credit should certainly be given to Hazeltine, an original and talented experimenter, for adapting it to the conventional radio frequency amplifier. Englund, Round, Fiske, and Weagant experimented with four circuit receivers, in the early days of radio, and discarded them for more efficient circuits, as many over-credulous broadcast enthusiasts are doing today.

The so-called "new circuit" is a most inviting pitfall into

which the broadcast enthused public is being willingly led by newspaper radio supplements (who must give their readers what they wish), pseudo-radio engineers and avaricious manufacturers.

#### THE WHY OF THE "NEW" CIRCUITS

**C**IRCUITS are dubbed "new" for one or more of several reasons. Occasionally an experimenter, whose radio experience does not antedate the advent of wireless telephone broadcasting, hits upon a receiving arrangement, which he honestly believes to be new; and an equally ignorant manufacturer is often induced to build up some circuit that De Forest and Colpitts played with years ago. RADIO BROADCAST receives one or two of these brain-

children each week. The second, and more malignant type of "new" circuits are those consciously camouflaged by manufacturers in order to gain the psychological advantage of the exclusive and "new," or to disguise a single circuit set, against which the radio public has been warned, under an innocuous epithet. The editor of RADIO BROADCAST was recently talking with the head of a radio store, concerning the merits of single circuit regenerative tuners. The radio dealer was quite decisive in his denunciation of such receivers, averring that none were ever sold over his counter.

#### I am the "New" Circuit

I am the new circuit. I am as numerous as the hours. I am born and reborn whenever there is nothing of real value immediately at the disposal of the "gyp" or the pseudo radio experts who feel the need of having their names appear in print.

I am generally a complication of some discarded radio relic. My new clothes, though expensive, are usually of poor quality. They serve me well in my masquerading and aid in beguiling the inexperienced. My best friends are those who desire an immediate "clean-up" with but little thought to the future. I am valuable in that my faults may be cited as the "horrible examples" after knowledge of my cunning has been gained.

I am the subject of much controversy and usually a breeder of ill-will, suspicion, and doubt.

My biographer, Mr. Bouck, knows me of old and has used me to serve two useful purposes at a single stroke. Under his pen I am disclosed as the prince of "birdies" and the masked Ancient posing as Youth.

I am the "New" Circuit.—THE EDITOR.

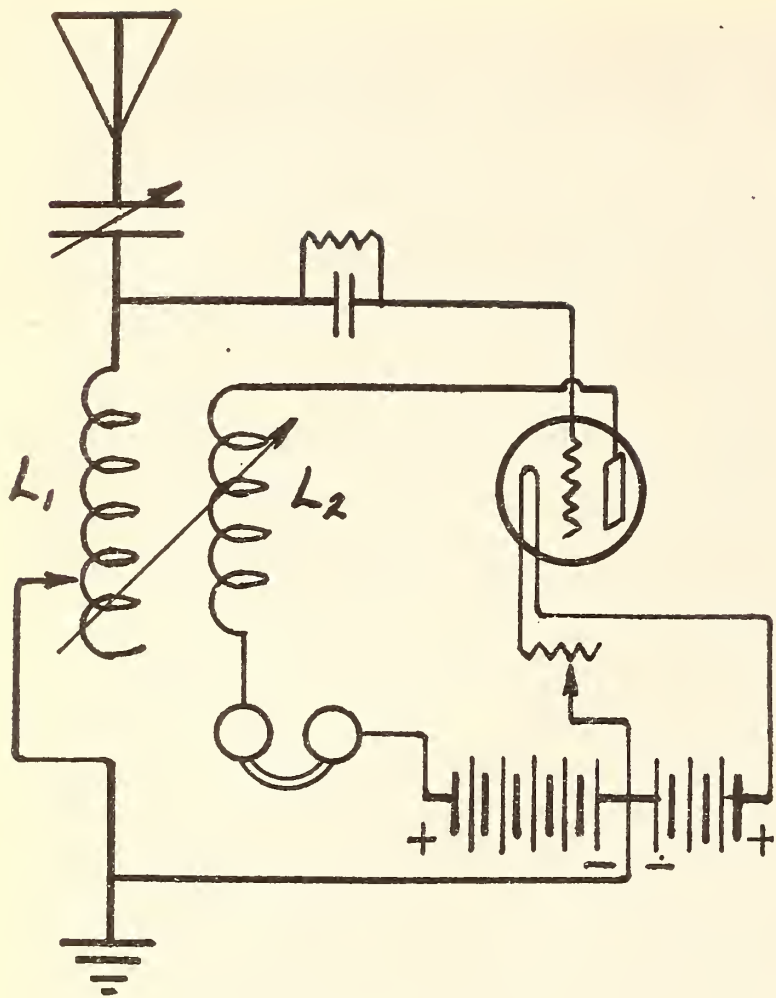

FIG. 1

The single-circuit regenerator. By adding a few jim-cracks to this old-timer, it may be made to look much different and becomes sufficiently complicated to attract attention

Rather amazed, your editor pointed to a set featured by the company in question, and which was obviously a single circuit tuner of the type diagramed in Fig. 1.

"What do you call that?" asked Mr. Lynch.

"Oh, why that's a——circuit!" and the dealer named a meaningless trade mark.

That the single circuit regenerator is a guilty creature is shown by its many aliases. The reader may safely assume that any regenerative bulb set sold for less than thirty dollars is a single circuit tuner, and, for the good of radio, he should refrain from buying it. Many of the circuits, however, are so disguised that a casual glance will not disclose the usual malefactor. But such camouflage is superficial, and a critical analysis of the circuit before building or purchasing the set, will disclose the wolf in sheep's clothing—generally a "dyne" or a "plex", or the name of the company selling the set or parts.

The reader who has followed our quasi-theoretical discussions of inductance, capacity, etc., in the last three issues of RADIO BROADCAST, should now be able to grasp the true significance of circuits. He should experience

little difficulty in stripping the "new" circuits that our newspapers are forever proclaiming, of their superfluities—little useless variations or additions—and bring to light the underlying circuit, which will probably be as old as the hills. And a critical analysis of a circuit may save him hours of futile labor into which the lure of something apparently new might have intrigued him.

To emphasize in the reader's mind, the essential considerations in circuit analysis, we shall briefly review the salient arguments in the previous articles, and apply the knowledge which we have gained to showing up a few (alas! space permits but very few) typical "gyp" circuits.

#### HOW TO RECOGNIZE "NEW ANTIQUES"

WE FOUND that inductance, or "L", is a characteristic of a conductor, a circuit, and particularly of a coil of wire, and that through the agency of inductance energy can be transformed (by induction) from one circuit to another. It was also explained how inductance is one of the qualities which determine resonance, or tuning, the other determining quality being capacity. When the opposing reactances of inductance and capacity are balanced, at a certain frequency or wave, the circuit is in resonance with, or tuned to that wave. It was also shown that condensers possess a secondary effect of by-passing—that is, a high frequency current will pass quite

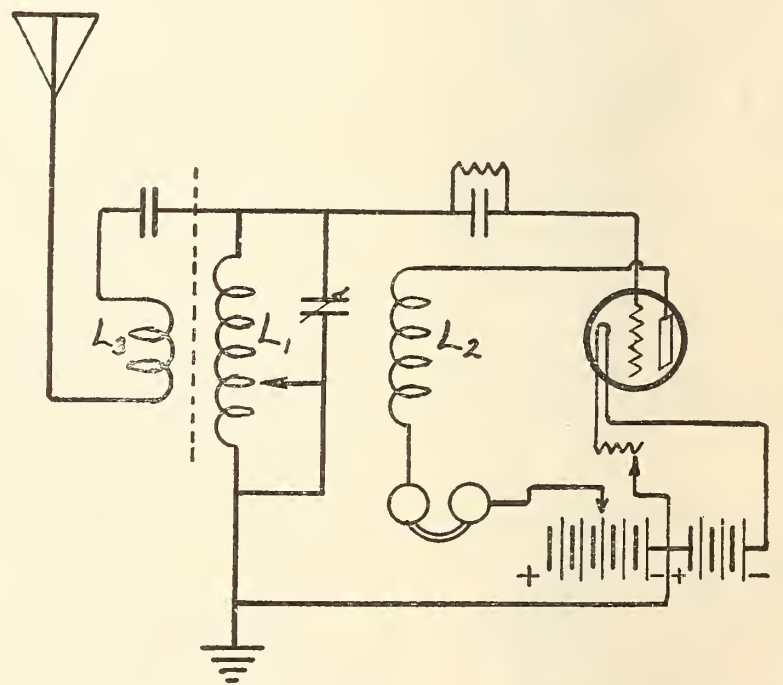

FIG. 2

At a single blow I kill interference for I am partly a wave trap; make tuning sharper because my primary and secondary are loosely coupled; and save you expense as all the parts for me are cheap. And, I nearly forgot, I can make many enemies among my neighbors

readily across a condenser which would "open" a direct current or low frequency alternating current circuit.

We shall take, as our starting point, the most common single circuit tuner, that shown in Fig. 1. This receiver is regenerative through a tickler feed-back. Tuning is accomplished by a variable antenna condenser, a tapped inductance, or both.  $L_1$  is an auto-transformer, with its winding common to the antenna and grid circuits. Impulses in the plate circuit are regenerated (fed back to the grid circuit) by induction from  $L_2$  (the tickler) to  $L_1$ . This circuit is a very powerful radiator, and is often used in transmitting systems.

The circuit shown in Fig. 1, with and without modifications, has many unofficial names, a few of which are: "The Parker Circuit," "The Haynes Circuit," "The Overland Circuit," "The Hardy Circuit" (Fig. 2), "The Flewelling Circuit" (Fig. 3). The "Aeriola Senior," several of the "Radiola," "Radak" "Grebe" series are also of this type, though the manufacturers, of course, make no claim to an exclusive or original circuit.

The derivation of Fig. 2 from Fig. 1 is most obvious. The manufacturer has ostensibly attempted to incorporate a wave-trap ( $L_3$ ), hoping, perhaps, to disguise the single circuit tuner, which nevertheless remains in all its iniquitous glory. The addition of  $L_3$  does not reduce the tendency to oscillate at the

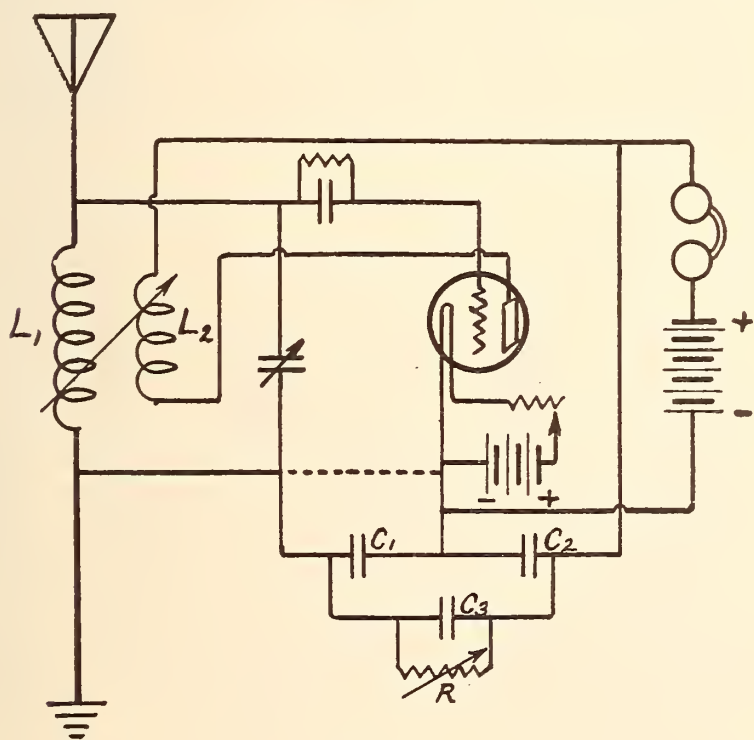

FIG. 3

Much perfectly good printer's ink has been wasted upon me and I have caused my share of whistles and howls, I have helped many a "gyp" dealer unload parts of questionable merit and now I am serving the very useful purpose of gathering dust

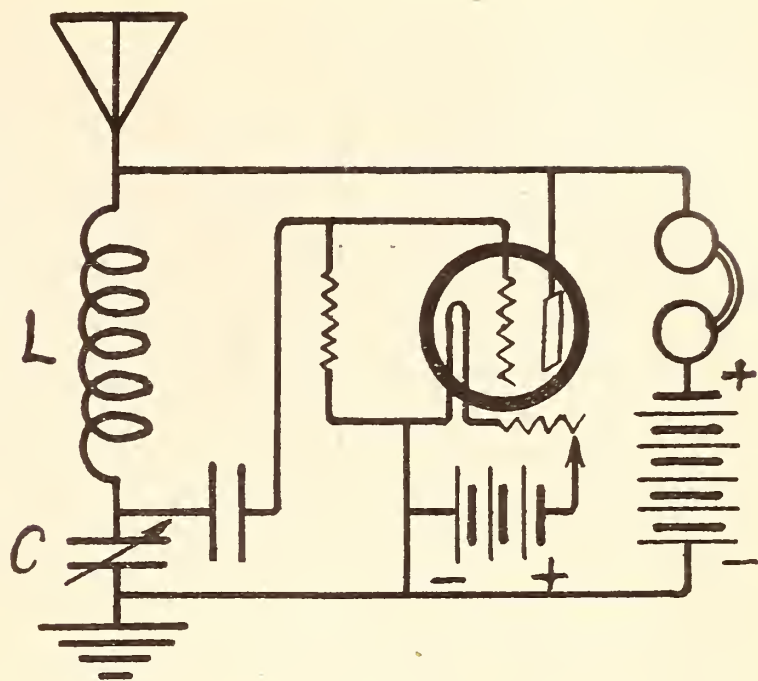

FIG. 4

Before inexperienced experimenters or ruthless gold-diggers, press-agented this "Simplex," alias "Flivver," alias "Carpet of Bagdad," alias "Automatic Regenerative Circuit," it was described by Colpitts as a *transmitting system*. It is a wolf in sheep's clothing

received frequency (unless you are content to reduce signal strength at the same time), nor is it effectual as a wave-trap. Fig. 2 is a typical "New" circuit.

Fig. 3 shows the Flewelling circuit, and again it requires no stretch of the imagination to associate its genesis with Fig. 1. A short scrutiny will show the differences between it and the more elementary single circuit tuner superficial and of doubtful advantage.  $C_1$  acts as a by-pass condenser, giving the effect of the straight ground connection to the filament (as per the dotted line) in Fig. 1.  $C_2$  is nothing more than a slightly misplaced telephone shunt capacity (although it is often used in this position) bridging the high voltage battery and receivers.  $C_3$  and the variable resistance  $R$ , do little more than complicate and render the circuit less stable through an undesirable additional regeneration, secured by means of an ultra-audion action. The De Forest ultra-audion oscillating circuit is characterized by a lead running from the lower side of the tuning coil to the plate side of the telephone receivers rather than to the filament battery. As may be guessed, the Flewelling circuit is a powerful and malignant radiator.

NEW CLOTHES FOR AN OLD ACTOR

ANOTHER fundamental circuit which has been dubbed "new" as many times as it has names, which is legion, is the Colpitts oscillator, Fig. 4. This *transmitting circuit*,

when used for receiving, has many names—"Automatic Regenerative," the "Flivver circuit," the "Carpet of Bagdad," the "Simplex," etc., etc.

This circuit regenerates by means of capacity feed-back through condenser C and the capacity between the antenna and ground. Sometimes L is tapped, or a variometer is used in place of the usual coil—thus giving us another "new" circuit. Occasionally the coil is a fixed inductance, and C is variable. This circuit, with one hundred volts on the plate, is capable of transmitting in excess of fifteen miles: in other words, an inconsiderate operator using this circuit for reception, can spoil a concert for all other listeners within a radius of several miles.

Fig. 5 shows the "Phantom" circuit, which is nothing more than our single circuit set with tuned plate regeneration. Instead of coupling L2 to L1, as in Fig. 1, L2 is made a variable inductance (a variometer or a tapped coil). When the plate circuit is tuned to resonance with the incoming signal, energy for regeneration is fed back, from plate to grid, through the capacity in the tube. When two

### Some People Think This

"Radiophone reception has been developed so rapidly of late that the interested public has been literally jumping from one marvel to another. Not since the release of the epoch-making super-regenerative circuit has anything of so great importance been brought to the attention of radio fans as the so-called phantom circuit.

"The phantom, however, is so sensitive that it requires a tiny amount of incoming energy for operation, and only a small piece of wire for a collector. This wire, preferably lamp cord, may be about fifteen feet long. It may be thrown carelessly about the floor, dropped out the window, or concealed beneath the rug or behind the moulding. It may be disposed of in any place that is convenient. . . ."—*The descriptive article about this "phantom circuit."*

circuits are in resonance with each other, they are, of course, affected by the slightest variation in one of the circuits, even if coupled by only the small capacity existing between the grid and plate of a vacuum tube.

This circuit is, needless to say, claimed to be new, and in evidence of the newness, the fact that the set will function with no

ground connection is cited. Of course it will—and so will any other tuned plate or tickler regenerative receiver!

### THE "GOULASH" CIRCUIT

AT TIMES there is no limit to the extent to which an "experimenter" or manufacturer will go in search of something which he may brand as "new." The Kauffman circuit, Fig. 6, is illustrative of this. Its inventor, perhaps weary in the quest of things new, decided to shake up all of the present day circuits, and, via the newspaper wireless supplements, tendered the public this radio goulash.

The Kauffman circuit embodies all three methods of regeneration we have just discussed. There exists capacity feed-back through antenna and ground and condenser C;

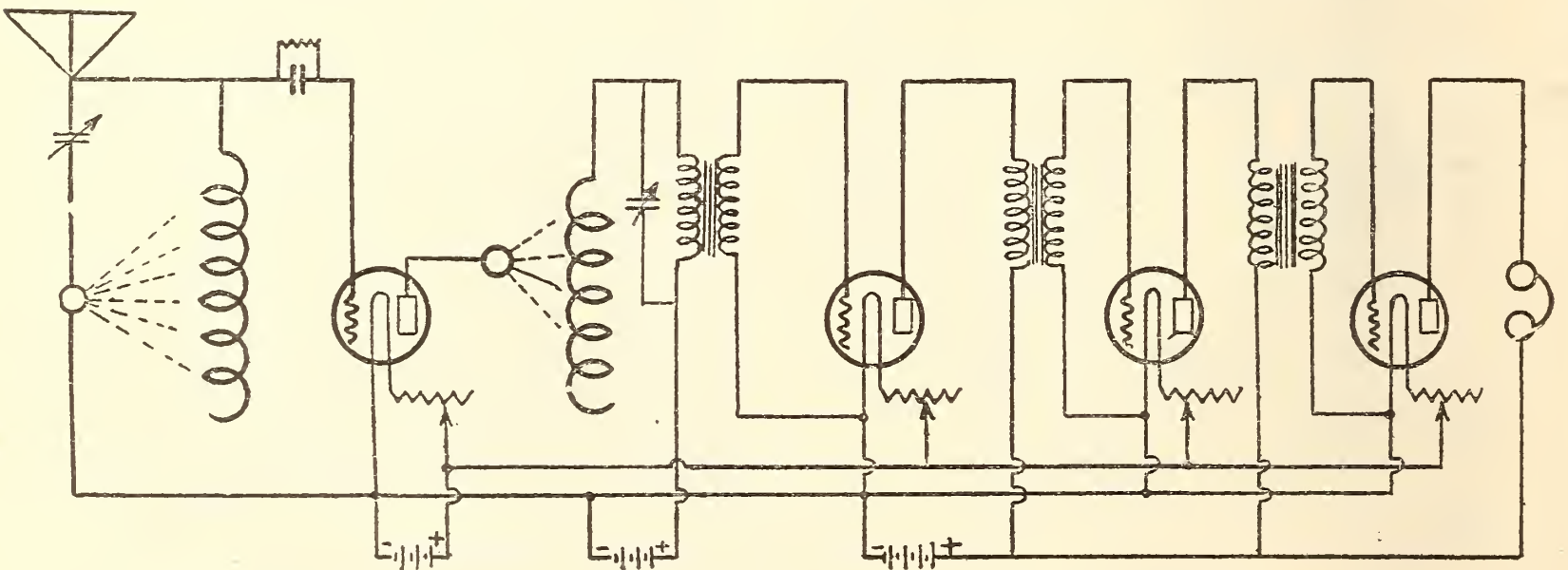

### THIS ISN'T WHAT IT SEEMS

They called this a "phantom circuit" in the periodical in which this originally appeared and from which this diagram has been photographed. Do you recognize your old friend, the tuned plate circuit? This arrangement will work, but any properly connected, squeaking and howling single circuit regenerator will do about as well under similar conditions.

Who was it who said, "It's all right, but it doesn't mean anything"?

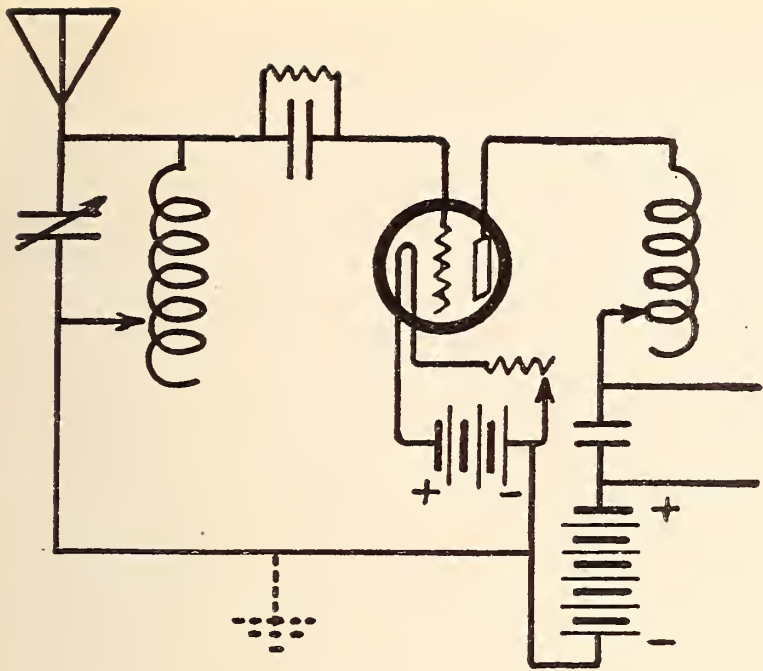

FIG. 5

Behold! No ground connection, but I work just the same. Am I not new? Indeed you are—*not*, old dear, you are Fig. 1 in a new gown and some other fixings

inductive feed-back between  $L_1$  and  $L_2$ ; and then tuned plate regeneration effected by means of the tapped coil,  $L_3$ . Quite naturally, with all this regeneration, it is a very difficult matter to control or stop oscillations. To do this, the inventor was compelled to short-circuit his whole system with the comparatively low resistance  $R$ . In efficiency, this is quite on a par with controlling an electric bell by short-circuiting the battery.

One could continue thus almost indefinitely. But the reader is, by now, qualified to use his own discrimination, at least in so far as avoiding the single circuit tuners and their modifications which are generally efficiency detracting additions. The inseparable mechanical characteristic of the single circuit tuner is a coil in the antenna circuit ( $L$ ), which is also common to either the grid or plate circuit. If a set employing this auto-transformer is regenerative, it should neither be bought nor made for receiving purposes. With all its coils and circuits, the Kauffman arrangement is, as we have shown it, nothing but a single circuit tuner. You can hang coils to anything in a set, from the tip of the bulb to condenser knobs, but it will still be a single circuit tuner, unless the antenna tuning system is given a coil all to itself.

If the reader desires a regenerative set, and one is desirable in the case of a broadcast enthusiast who cares to follow up speech and music with code, the receiver chosen should be one of two types. The variocoupler tuner,

with tuned plate regeneration (the coupler-twin-variometer set is a good example of this system) is an excellent short wave set, while the three coil honeycomb (primary, secondary and tickler) is equally efficient on all waves.

But even using one of these two receivers, if the experimenter is operating in a crowded radio district, it will be more considerate of his neighboring enthusiasts, if a non-oscillating receiver, such as an efficient reflex or the neutrodyne, is used on the broadcasting waves.

If you have any doubt concerning a "new" circuit, submit it to RADIO BROADCAST, and its engineering staff will be glad to tell you the truth about it.

### WHILE WE'RE ON THIS SUBJECT

WE WISH to say a word about the campaign against the squealing receivers. We do not make a practise of blowing RADIO BROADCAST'S horn in our text pages, but in this case, we feel that it is justified.

It is doubtful if any single agency could have brought down the avalanche of objection to the howlers, though several of our misguided contemporaries are attempting to take into their own camps the entire credit for this campaign, though they never criticised the nuisance until the general public began complaining.

Back in 1922, the editorial reprinted on the next page, appeared in RADIO BROADCAST and it was followed by many others of like nature—so many, in fact, that the magazine lost thousands of dollars worth of advertising for adopting what some manufacturers of squealing receivers called a "short-sighted policy."

One of the principal reasons for the recent transatlantic receiving tests was to demonstrate to all those who listened, American broadcast stations being off the air, just how serious this menace has become. Judging from the space

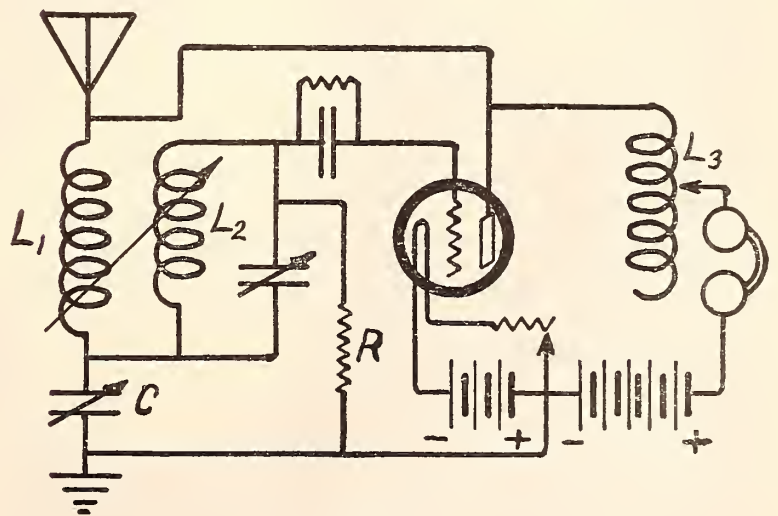

FIG. 6

I combine them all and am therefore the best. So does hash, but it is hardly to be preferred to chicken or lobster

now being devoted to the discussion, perhaps we were not as short-sighted as it at first seemed. The very cures now being offered for this disease to-day were described in the editorial below—in 1922.—THE EDITOR.

#### REGENERATIVE RECEIVERS MUST BE CONTROLLED

AS ONE listens nowadays for the evening concert he is continually bothered by whistling noises coming from his receiver, generally, it seems, at a critical point in the program. Just as the singer endeavors to show the radio audience how well her voice can execute a pianissimo passage, a series of peeps (of which fortunately, she is not aware), spoils the whole effect.

These whistling interruptions are due to some regenerative receiving circuit in the neighborhood of the listener, radiating from its antenna continuous-wave power which, combined with the power sent out from the broadcast station, produces a disagreeable beat note in other receiving sets in the vicinity. When a regenerative set is made to oscillate, it really becomes a miniature continuous-wave transmitting station, sending out perhaps one hundredth of a watt of power. It might seem that such a small amount of power could do no harm, but

it is to be remembered that the amount of power picked up by an antenna from the distant broadcasting station is only a very small fraction of this. In fact, if the oscillating receiving set is within a mile or so of the listening station being disturbed, the amount of power received from the broadcasting station may be only a small fraction of the amount received from the interfering oscillating receiver.

As more receiving sets are installed, the nuisance from this source continually increases at a much faster rate than does the number of receiving stations. This trouble must be controlled and stopped in some way, either by the good sense of the operators or by requiring that receiving sets shall not be allowed which are capable of oscillating at the frequencies used for broadcasting. If Armstrong's super-regenerative idea is used by an appreciable number of receivers, on elevated antennas, the trouble will be immeasurably worse, and some regulation should be at once put into effect to prohibit the use of these sets except on loop aerials, which radiate comparatively little power. A regenerative, oscillating set may be used without causing this trouble if it is preceded in the receiving circuit by a radio-frequency, non-oscillating amplifier, a scheme not yet used to any great extent.



WHAT WE MAY COME TO



ONE HUNDRED FEET BELOW THE HUDSON

In the New Jersey-New York vehicle tunnel, radio engineers, and members of the tunnel commission received broadcasting from Pittsburgh on the loop and six tube set shown in the photograph. These experimenters were 500 miles by air from Pittsburgh, down 100 feet in the water and behind 30 feet of mud and steel, encasing the tunnel. G. Y. Allen, radio engineer of the Westinghouse Electric Co., is facing the camera, bareheaded, fourth from the right. Radio may be used as a safety communication in future tunnels

## The March of Radio

### THE FEDERAL TRADE COMMISSION INVESTIGATES THE RADIO CORPORATION

**L**AST month a report by the Federal Trade Commission dealing with the situation existing in the radio industry was transmitted to Congress. This report was the outcome of an investigation requested by House Resolution 548 of the 67th Congress. This report is so thorough in its gathering of important facts not generally known of the radio field, that it should have the widest publicity. Many items in the daily press, having to do with patent suits, trade agreements, shortage of tubes, etc., can be bet-

ter understood in the light of this official report of present conditions in the industry. The Federal Trade Commission had no power to determine whether or not a monopoly exists in radio. It could merely collect the facts of the situation.

The report traces the development of the situation which gave rise to the founding of the Radio Corporation. In 1919, two of the officials of the Navy Department, in conference with the General Electric Co. officials, suggested that an American radio company be formed

privately, with the idea of having radio channels controlled entirely by American interests. The General Electric Co. was party to the conference not only because of its vast electrical resources but because the Alexanderson alternator, a General Electric product, was just then assuming tremendous importance as the best high powered, transmitting generator available. This original project, instigated by Admiral Bullard and Commander Hooper, of the Navy, did not mature because Secretary Daniels was in favor of Government ownership of radio.

The General Electric Co. then went ahead on its own initiative and formed the Radio Corporation of America, which at once absorbed the American Marconi Co. Most of the \$25,000,000 capital was furnished by General Electric and Westinghouse interests. The United Fruit Co. (one of the other members), had a comparatively small share in the stock allotment. The new Radio Corporation at once started to acquire all the available radio patents which had not been controlled by the companies forming it, until, at the time the Trade Commission report was issued, about 2,000 radio patents were controlled by the Radio Corporation. These 2,000 patents represent the pooling of all those owned by the General Electric Co., the Westinghouse Co., the American Marconi Co., the American Telegraph and Telephone Co., the Western Electric Co., the United Fruit Co., the Wireless Specialty Apparatus Co., the International Radio Co., and the Radio Engineering Co. These companies agreed to a mutual exchange of information relating to radio at the same time the latest interests were pooled which undoubtedly accounts for the almost simultaneous appearance of new developments in entirely different laboratories of companies who are members of this radio combine.



EDWARD W. BOK

Donor of \$100,000 for a workable plan for international peace, reading winning plan No. 1469 before the microphone at New York

The Radio Corporation is the selling company for all the apparatus controlled by the hundreds of patents which had been accumulated in its archives. The agreement specified that the General Electric Co. and the Westinghouse Co. will manufacture the apparatus and deliver it to the Radio Corporation to sell, the division of the output to be 60 per cent. General Electric, and 40 per cent. Westinghouse manufacture.

Until the expiration of the Fleming patent in 1922, the Radio Corporation had an absolute monopoly in the sale of vacuum tubes. Even the De Forest Company had no legal right to sell "audions"

until after the expiration of the Fleming valve patent. There are now seventeen concerns which still retain license privileges granted by Armstrong before his patent had been acquired by the Radio Corporation. These licensed manufacturers are at present being sued by this corporation on the basis that they have no right to manufacture sets which are manifestly intended for use with vacuum tubes. It is contended by the Radio Corporation in this suit that the sale of these sets constitutes an infringement of their tube patents. If this suit is decided in favor of the Corporation the decision "will prevent all competition in the sale of complete sets" in the language of the commission's report.

"The company has secured a virtual monopoly in the field of international communication," says the report, "and it controls all the high power stations with the exception of those owned by the government." In addition it has entered into traffic agreements with the various foreign governments and radio companies so that practically no messages originating in foreign countries can be received in America except through the Radio Corporation.

An interesting outcome of this situation in



international radio was the decision of several of the more important daily newspapers and press services to be rid of this control. They decided to build a radio station of their own. But they couldn't do it in the United States—so they went to Canada and erected their station in Nova Scotia. This station is now being operated independently of the Radio Corporation of America, by virtue of an agreement with the British Post Office.

Here are some authoritative figures which show the tremendous growth of the radio industry. In 1921 the Radio Corporation furnished on order 112,500 tubes; in 1922, 1,583,021; and in 1923, at the rate given in the report the sale of tubes will reach 4,000,000. This means that the radio public has invested about \$24,000,000 in tubes alone, in a single year.

We do not question these figures. But— isn't it time that more of the "development cost" of the tube was charged off and the price adjusted more in accordance with the actual manufacturing cost?

### Broadcasting Over Extremely Long Distances

SINCE broadcasting has come into its own, we are all learning a great deal about sections of the world that were formerly nothing more than names associated with a spot on a map, or, in many instances, not even that familiar to us.

Men in our foreign service and even in the Arctic and Antarctic regions need no longer be without direct and very intimate contact with this great country of ours. A few months

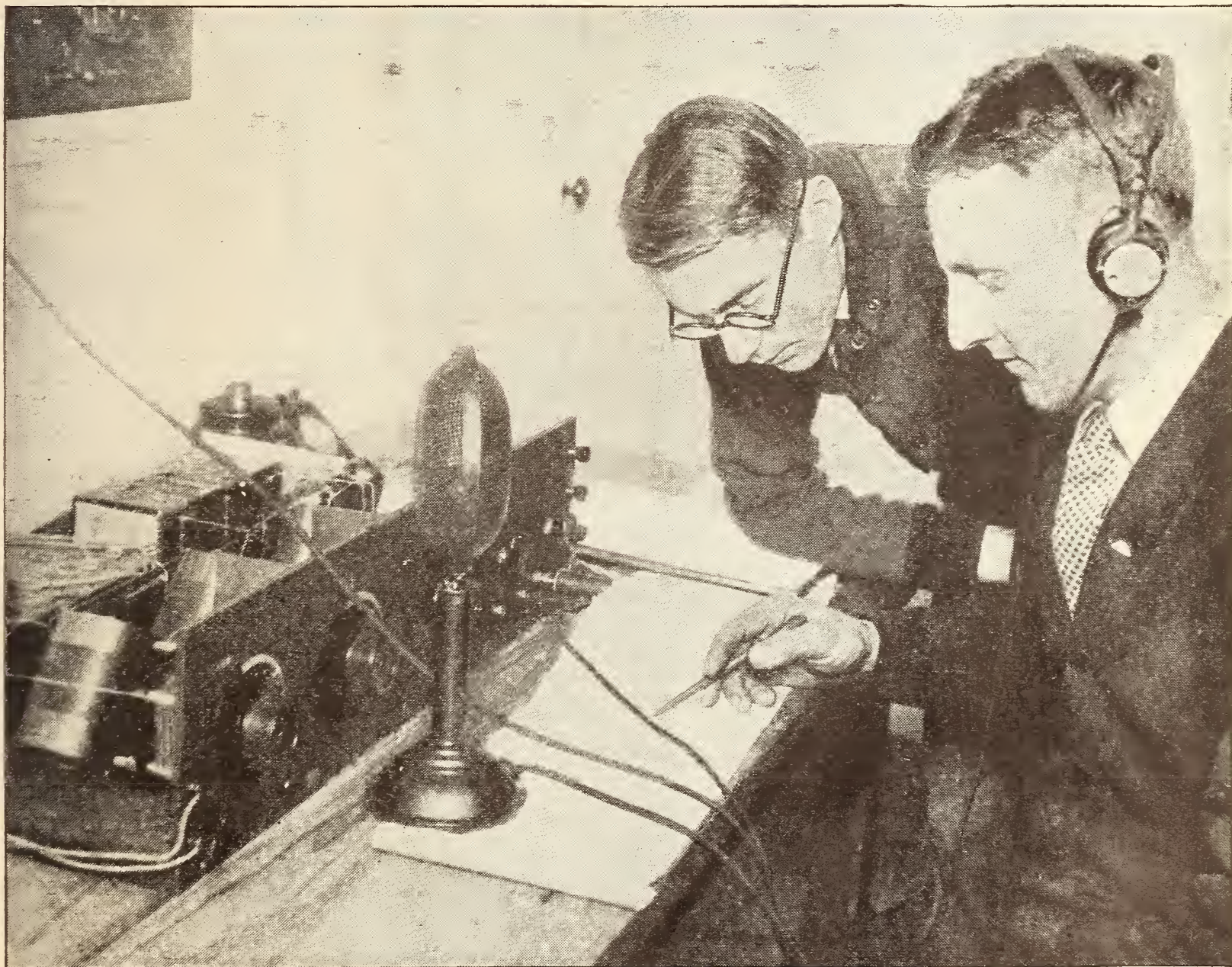

#### FOLLOWING AN AIR MAIL PLANE BY RADIO

Superintendent D. B. Colyer of the Western Air Mail Division of the Post Office Department is tracing on the map the course of Jack Knight's mail plane from Omaha to North Platte. The pilot reported in to Omaha every fifteen minutes by radio. Mr. J. V. Magee, special assistant to the Postmaster General is leaning over the map



LEADERS IN THE MYTHICAL DX CLUB  
Dr. and Mrs. Q. F. Roberts who heard Chicago  
broadcasting at their home in Apia, Samoa

ago RADIO BROADCAST published a description of the attempts being made in Samoa to pick up American broadcast programs. Mr. Quincy F. Roberts, American Vice-Consul in Apia, Samoa, who wrote the article for us, sent the following message through station VMG, Samoa, to the Director of Naval Communications at Washington, D. C.

"Please inform Zenith Edgewater Beach Hotel Radio Station that Chicago messages and music to MacMillan, North Pole were received by me at 7.45 Samoa time, December 19th."

When we think of Samoa located some 12 degrees below the Equator, in the Pacific ocean hearing broadcasting intended primarily for Donald MacMillan, up above the Arctic Circle, we may have some slight notion of what a powerful agency broadcasting really is developing into. It is of interest to note that the MacMillan material sent out from station 9XN begins at midnight Central Time. It was picked up in Samoa at 7:45 in the evening or more than four hours earlier. The distance from Chicago to Samoa is about 7,300 miles. Is this not an evidence of the vastness of the area covered by a single broadcasting station? We now have more than 500 of them. Are

they serving to the utmost the useful purposes to which they may be put?

### PWX Reaching Out Farther

IN A recent number of the *Revista Telefonica Internacional* appeared a note on the operation of the Cuban station PWX, a note which makes the manager feel justly proud. It was considered notable when PWX was first heard in Canada, then came the thrill of reception on the Pacific coast, then Alaska and later England. And now northern Europe is quite regularly picking her broadcasting. The chief engineer of the Cuban Telephone Co., which operates PWX, has received a letter from the foreign manager of the Federal Telephone and Telegraph Co. saying, "I am pleased to be able to say that I constantly receive reports from various territories, including Mexico, Great Britain, and Holland, from those who pick up your station. In fact it seems to be one of the most prominent ones operating to-day."

### What Mr. G. W. Pickard Has Found About Fading

ONLY a short time ago we commented upon the hopeless task that the scientists of the Bureau of Standards had laid out for themselves in trying to get some idea on the why and how of fading, using the data sent in by hundreds of amateurs who had been requested by the Bureau to make observations. It seemed to us at the time, that what was needed in the solution of this problem was not mere observations, but more accurate observations, observations not dependent upon the ear, which is such a poor instrument for judging the intensity of a sound.

Such a paper has just appeared, a most remarkable series of observations by Mr. G. W. Pickard, one of the ablest radio experimenters in the country. By the use of carefully constructed radio frequency amplifiers he has been able to increase the intensity of signals from most of the Eastern stations to such an extent that the signals could be actually read on a sensitive galvanometer. Having properly adjusted his apparatus he and his associates have then taken readings (or have made the signals record themselves automatically) for long periods of time, showing how the signal changed in intensity from day time to night time.

We have known that transmission is better in the winter than in the summer. Austen's results having shown a variation of about three to one, for wavelengths considerably longer than those used for broadcasting. Pickard's results show even a greater difference. He found the average winter signal strengths were five times as great as those for summer.

His results show that for stations within perhaps ten miles of the receiving set there is practically no observable fading effect. Actually, his instruments showed a fluctuation of about 10 per cent. but such a small difference is not detectable by the ear. As the distance between the transmitter and the receiver increases, short period changes in signal strength begin to appear, especially in the night time signals.

"In day time," says the paper, "although transmission is relatively free from the large amplitude, short period, variations commonly known as "fading," "swinging" or "soaring," there is usually a slow change from hour to hour which in the majority of cases appears as a gradual decrease from morning to night, the morning intensities often being twice those of the afternoon.

"About half an hour after sunset at the receiving station, the weak and relatively constant field from the distant station begins to show marked short-period fluctuations which grow in amplitude from minute to minute until, soon after sunset, they usually assume grotesquely large amplitudes. The principal change from day to night is an increase in field intensity; in general, the lower limit of the night time field is approximately the same as the late afternoon field, although from time to time there will be found a momentary fall to a much lower value than at any time during the day. The upper limit of the night time field is not so definite; it may

be ten, a hundred, or even on occasions, thousands of times greater than the day-time intensity, depending upon the distance, and the character of the night.

"The amplitude of the short period variations, that is, those fluctuations ranging in duration from seconds to tens of minutes, is principally controlled by the distance between the transmitter and the receiver, and this is true of both night and day transmission. At eleven kilometers (about seven miles) from a broadcasting station, there is a well defined short period fluctuation in intensity during night time transmission which is practically absent during the day, and which on some evenings shows an amplitude of 10 per cent. or more. As the distance increases the amplitude of the variations increases, becoming readily observable by day at a distance of fifty kilometers, more or less.

"At first there is no change in the character of the fluctuation other than amplitude, but when the distance of between one and two hundred kilometers is exceeded, the oscillations of periods ranging from seconds to a minute or two become less prominent, and the longer swings of minutes and tens of minutes are accentuated. At an ill-defined distance of perhaps one hundred and fifty kilometers the amplitude of the short period variations appear to be a maximum."

We hope Mr. Pickard will continue to gather data on the transmission of radio signals, because, with his apparatus and skill, much more reliable and valuable results will emanate from



AMATEUR STATION 6AWT, SAN FRANCISCO

With the owner and operator, Bartholomew Molinari, at the key of his 250-watt tube set. Molinari has exchanged radio messages direct with WNP, the *Bowdoin*, which is now frozen in off Greenland on its slow way to the North Pole

the experiments than from those of some other investigator just taking up the problem. As an indication of the apparatus used and skill shown in making these tests, let us point out to those radio listeners in the New England States who occasionally hear a weak signal from the Texas stations, that Mr. Pickard



THE OLD LIBERTY BELL AND THE NEW MICROPHONE

Together at Independence Hall, Philadelphia. Harry T. Baxter, Chief of Philadelphia City Property is reading the history of the famous bell, which listeners heard last New Year's Eve

(near Boston) receives these stations strong enough to get a continuous record of their signals on his galvanometer, an instrument by no means as sensitive as a telephone receiver.

### The Army's Radio Chief Retires

ON JANUARY first, 1924, Major General George O. Squier, Chief Signal Officer of the United States Army, retired and was succeeded by Col. Charles McK. Saltzman. In Major General Squier, the Signal Corps had one of the ablest scientists in the entire radio field. General Squier has been in active Army service for forty years. During that time, his services have been many, but he is chiefly known for his technical contributions to radio. He is responsible for "wired wireless" or "line

radio," as it is often called. He has made successful experiments using trees as antennas and first observed the phenomena as early as 1904.

Major-General Squier's developments with "wired wireless" have made modern multiplex telegraphy and telephony possible. Where a wire once carried but a single message, now eighty-five telegraph messages and five telephone conversations can be sent over it simultaneously.

Under Major-General Squier, the Signal Service of the Army has expanded, the standard of operation and maintenance has been kept high, so high that our own Signal Corps has had to acknowledge none as superior.

He is a graduate of West Point, secured his Ph. D. in physics at Johns Hopkins and has done considerable research under Rowland and Preece. His name is frequently linked with Marconi, Fessenden, De Forest, and Armstrong as one of radio's great. With the active duties of army life no longer pressing on him, General Squier may be able to devote his time exclusively to research in his chosen field of radio and electricity. And one may say . . . "Well done, good and faithful servant."

### A New Standard for Wavelength Measurements

EVERY intelligent radio listener is interested to know that the frequency of radiation from a given broadcasting station is so constant that its signals may be used as a wave-length standard. But he is

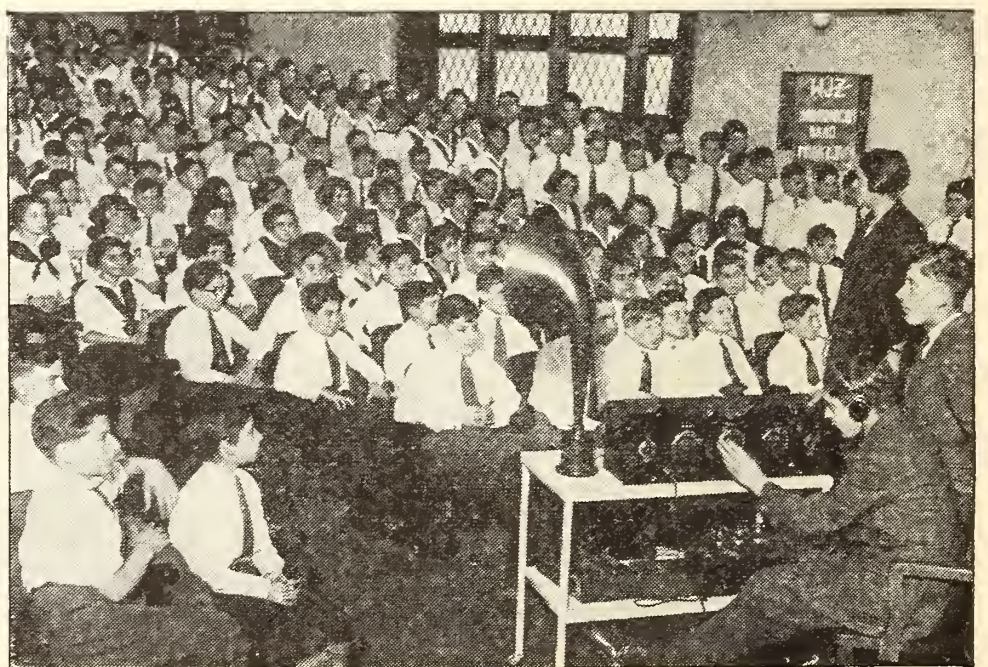

A CLASS IN THE "UNIVERSITY OF THE AIR"  
In the junior high school 61, New York City. The assorted students are listening to a special lesson in music being broadcast from the Metropolitan Opera House, New York



#### THE CHRISTUS OF THE PASSION PLAY BROADCASTS

From his room at the Waldorf-Astoria through WJZ. Anton Lang is almost the only member of the Oberammergau Passion Players who can speak English. Thomas A. Cowan is the announcer and H. V. Higgs is the operator at the speech amplifier panel

perhaps curious to know how this standard measurement is made. The signals of the station are compared with a standard wavemeter, of course.

But how are we to know that this standard wavemeter really stays standard? By comparison with other standard wavemeters, you suggest, just as the mariner used to judge the accuracy of his chronometers. He used three of them and compared one with the other. Of course nowadays the chronometers are tested for accuracy each day by means of the radio time signals sent out from many stations for just that purpose. These signals themselves come from a "standard" clock, however. How do we know that the clock is right? This clock is adjusted by comparison with the time taken for a revolution of the earth, as measured by the passage of certain stars through the meridian. The earth itself is a great clock of such extremely great mass that its rate of rotation may be assumed constant.

What corresponding standard do we have for the radio wavelength? A wavemeter is nothing but a resonant circuit, the resonant frequency of which is determined by the inductance of its coil, and the capacity of its condenser. How do we know whether or not these change? In general, we tell this by the same method the old sailing master used to employ with his chronometers. We compare several coils by very accurate measurement. If their comparative inductances stay the same, we are reasonably sure in saying that each of them is staying constant; for the condensers, we make similar comparisons.

But is there some other method, avoiding entirely the use of coils and condensers? The mariner eventually leaves his chronometers and goes to the earth's rotation for his standard time. The satisfactory use of some substitutes for the usual inductance-capacity standard wavemeter has occurred several times lately. By sending high frequency current through a

pair of wires ("wired wireless") and adjusting this frequency to the right value, standing waves can be set up on the wires just as stationary waves can be set up on a stretched rope if its end is shaken up and down with just the right frequency. The length of these standing waves can be very accurately measured by a vacuum tube detector. Then, on the assumption that the waves travel along wires with the same speed as they would if they were as free as are actually radiated radio waves, the frequency of the vacuum tube oscillator which is furnishing the power for the test, is accurately known. A wavemeter may then be accurately calibrated for this one frequency; other points may be calibrated in similar manner after the length of the standing wave has been changed.

Another scheme starts with frequencies which are sufficiently low to be counted. The rate of vibration of an electrically driven tuning fork for example, can be measured to  $\frac{1}{100}$  of 1 per cent. if sufficient time and apparatus are available.

A vacuum tube may then be excited in some way by the oscillation of this fork. This fork might vibrate a microphone.

If the apparatus is properly arranged, it will generate frequencies not only the same as that of the fork (which is accurately known) but frequencies of every multiple of the original. Thus, if the fork is vibrating 1,000 times per second, the frequencies of current generated by the tube will be 1,000, 2,000, 3,000,—15,000—100,000 etc. Every frequency will be some exact multiple of the fork frequency.

If now some other device, like the fork, were available which would vibrate at some accurately known frequency of about 100,000, then we could use it as we do the fork, for getting

many more and higher frequencies, each being a multiple of 100,000, so our wavelength standards would be extended right up into the broadcasting band of frequencies.

Certain crystals, notably quartz, Rochelle salt, tourmaline, and a few others, have the remarkable property of changing their shape when put into an electric field. The change in dimensions is not sufficiently large to be seen by the unaided eye, but this change nevertheless occurs. For example, if a small piece of Rochelle salt be put between the plates of a condenser which is receiving let us say, a 1,000,000-cycle signal, that little crystal will be changing its shape just that number of times per second.

This effect, which is covered by the term, *piezo-electricity*, has been known for many years, but no important application had so far been made of it. During the war several experimenters at Columbia University, as well as others working in Europe, showed that it was possible to use this phenomenon advantageously in building a

submarine detector and much more research was carried out to examine *piezo-electric* effects more closely.

A slab of quartz crystal, properly cut with respect to the axes of the crystal and excited by an electric field of the proper frequency, may be made to grow longer and shorter at this frequency to a remarkable degree. It may be made to vibrate so violently that the slab actually pulls itself into two pieces in spite of the rather high tensile strength of such a crystal. If the slab of quartz is ground smooth, with square edges, it is found that the frequency of the impressed electric field must be within a very small fraction of 1 per cent. of a definite value (this depending on the size of the slab)



GENERAL GUSTAVE FERRIÉ

One of the powers behind radio in France. He is head of French military radio and was instrumental in its rapid development since and during the war

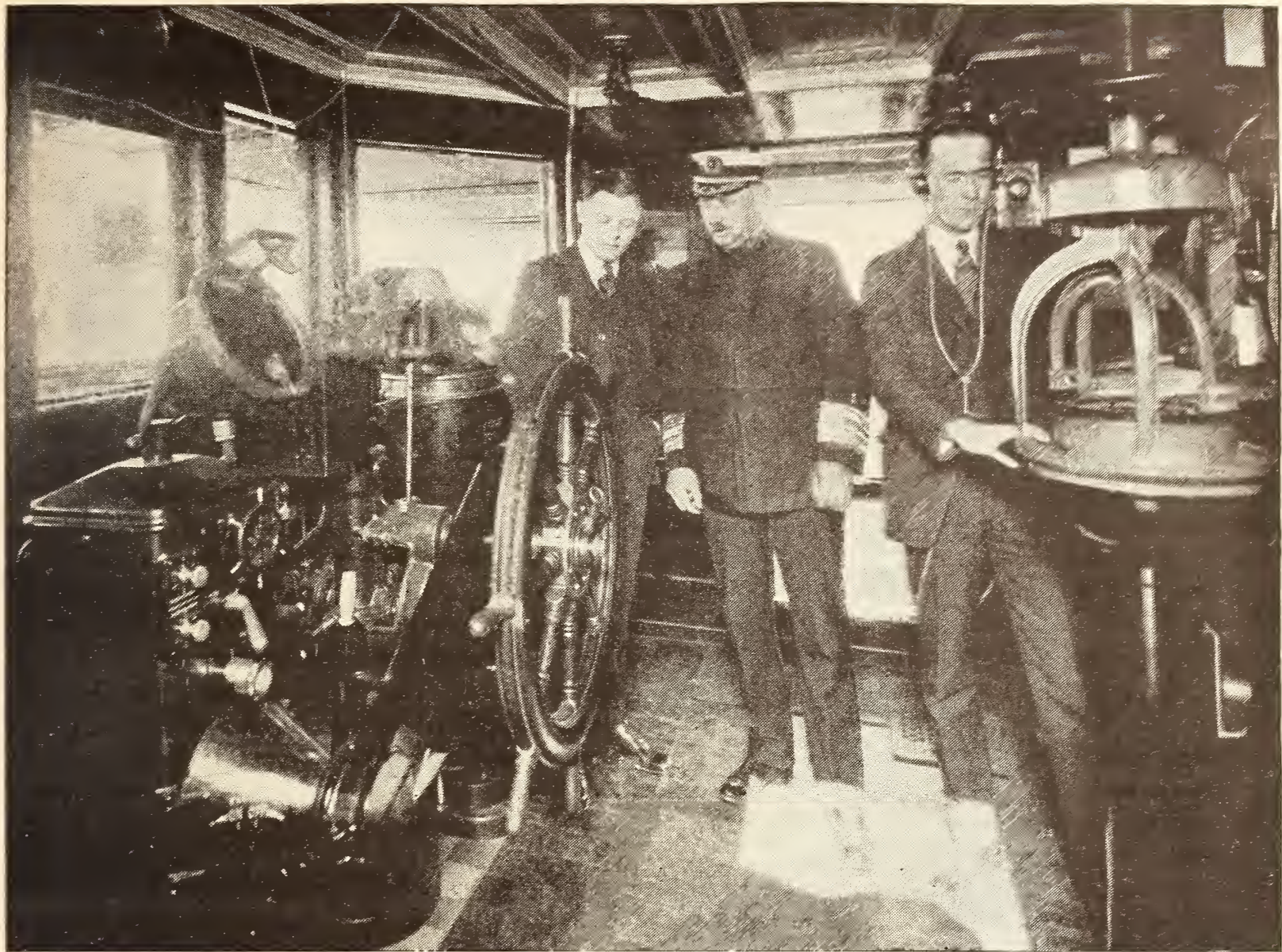

“METAL MIKE” AND THE KOLSTER RADIO COMPASS

Aboard the SS. *Mau*i, on the San Francisco-Hawaii run. “Metal Mike” is the affectionate nautical term for the Sperry gyroscope steering device. V. Ford Greaves is at the right, operating the Kolster radio compass and position finder. Elmer Sperry, Jr., who was recently drowned in the English Channel, is demonstrating his steering device to Captain Peter Johnson, commodore of the Matson Navigation Co. fleet

to get maximum amplitude of vibration of the slab. Thus with a certain slab about two inches long and half an inch wide, a frequency of the electric field of perhaps 50,000 cycles per second would give a scarcely perceptible vibration, but 50,500 cycles would result in vibrations so violent that the slab would break itself in two.

Evidently then a piece of this *piezo-electric* quartz might do as a frequency standard. Several workers in this field have recommended the adoption of quartz for this purpose, and a paper showing the feasibility of this was given before the Institute of Radio Engineers some time ago. More recently, a paper by Prof. Pierce of Harvard, gives the results of a very careful investigation of the possibility of such a frequency standard; he examined the effect of temperature, and other variables, on the natural period of oscillation of the quartz, and as

a result believes that these little slabs of quartz will give us our most reliable frequency standards. Once calibrated by the tuning fork method outlined above, they will remain permanent for all time. They will not be able to measure directly the frequencies used for broadcasting, but work well up to perhaps 500,000 cycles per second.

It is not at all impossible then that a laboratory will be sending to the Bureau of Standards, in the near future, a half dozen pieces of suitably cut pieces of quartz crystal, for calibration. They would be about the thickness of the lead in a pencil and perhaps  $\frac{1}{4}$  inch long. When these have once been accurately calibrated, they need never again be checked; in connection with a vacuum tube oscillator they will serve as the laboratory's absolute standard of frequency.

J. H. M.

# How to Increase Your Range

By Using a Simply Made, Simply Operated, and Very Cheap Tuned Radio-Frequency Amplifier that May be Added to Any Receiver

By ARTHUR H. LYNCH

**T**HERE are two very good reasons for the increasing popularity of the tuned radio-frequency amplifier. First it makes for reception over longer distances than are possible without it; and second, it increases the selection power or sharpness of tuning of the receiving system in which it is employed.

Then, too, it usually permits loop operation where an outdoor antenna would be required without it, and there are many advantages to be gained by receiving with a loop. So much has been written on this subject that we may well pass it over with little more than mention.

Another advantage of the amplifiers we are to consider is that in addition to improving reception for *you* they cut out one of the most serious sources of interference for people in your vicinity. By the addition of the radio-frequency amplifier it is possible to have your

receiver oscillating without re-radiating into the antenna. This remarkable result is brought about by taking advantage of the vacuum tube as a one-way valve. That is, it will pass current into your receiver but will not let it pass from your receiver back into your antenna. Thus, you may whistle and squawk to your heart's content without bringing the wrath of your neighbors down upon you.

But that is aside from the main issue, which is the improvement of your range and tuning, so let's get down to cases and find out how many ounces of efficiency comes wrapped up in the package of units for building our amplifier. First let us make a list of the necessary parts.

## WHAT YOU NEED

- 1 Panel (Unless there is room on your present panel)
- 1 Tube Socket

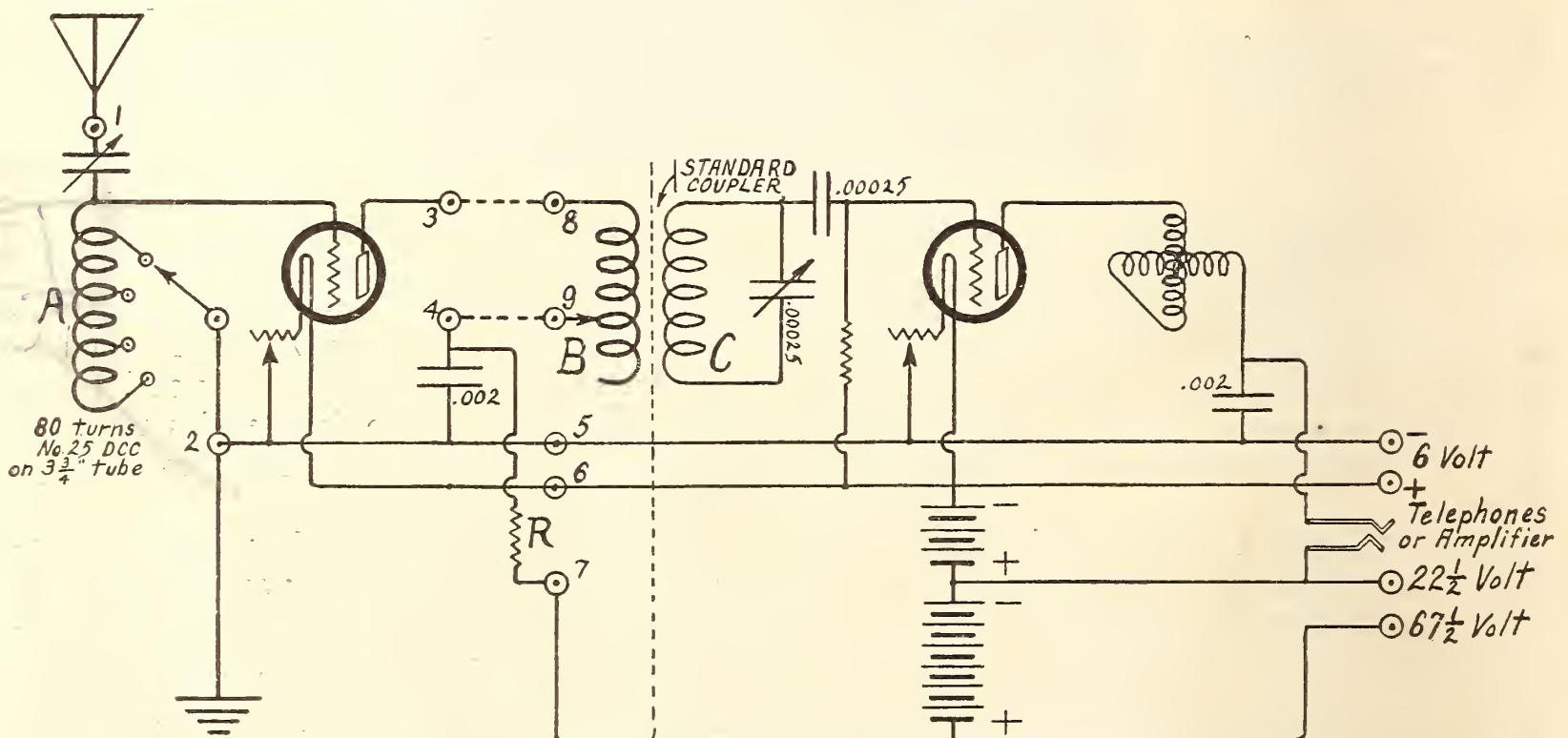

FIG. 1

This is the circuit arrangement for applying the stage of tuned R. F. to a loose coupled regenerative receiver such as the Paragon RA-10, the Zenith, the Grebe CR-3 and the Cutting and Washington. For loop operation it is but necessary to connect the loop between the binding posts 5 and 6, and for use with any of the honeycomb coil sets the antenna and ground posts are connected to the posts 3 and 4. Any single circuit receiver may be employed with the tuned R. F. amplifier by merely connecting the antenna and ground posts together by a piece of wire and placing the output coil on top of or beside the box as shown in Fig. 3



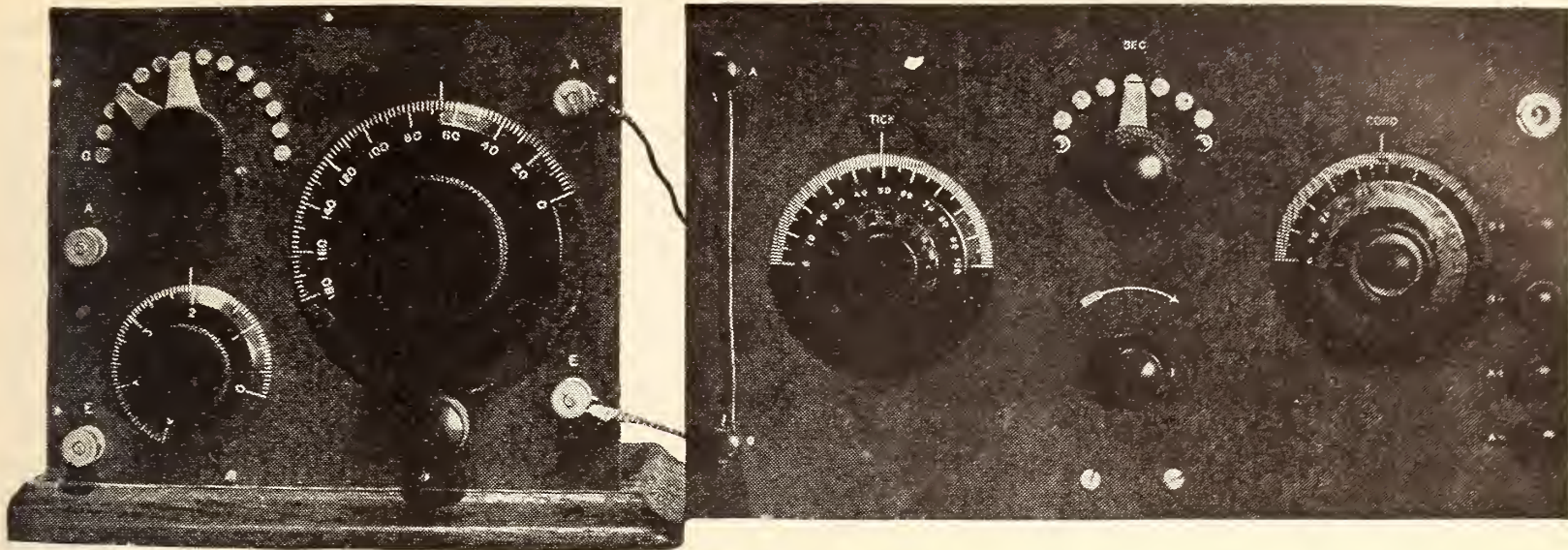

FIG. 2

With a single circuit receiver, the tuned R. F. amplifier is used with an easily made output coil. A piece of bus wire is then connected between the antenna and ground posts as shown here

- 1 Rheostat (25-30 ohm)
- 1 Variable Condenser
- 1 Cardboard or Formica Tube  $3\frac{3}{4}$ " O. D.
- 1 Baseboard
- 1 .002 Fixed Condenser
- 1 330 Ohm Choke (Or any 330 ohm inductive potentiometer)
- 1 .00035 Variable Condenser.

#### THE LAYOUT

IN A device of this kind there is a great latitude within which you may work, and the actual placing of the units is a matter of relatively little importance, depending upon just how you wish your amplifier to match up with your other equipment.

If you want a unit for application to any type of receiver, you may follow the layout illustrated in the accompanying illustrations. If, however, there is a certain amount of space into

which you desire to crowd the amplifier, you may change the position of any or all of the parts without experiencing any serious trouble.

#### WITH THE THREE-CIRCUIT RECEIVER

FOR use with any receiver employing a vario-coupler the arrangement shown in Fig. 1 is advisable. Here the primary of the coupler acts as the output coil for the R. F. amplifier and the secondary of the coupler is tuned by the variable condenser across it or the variometer in series with it, as the case may be.

#### FOR USE WITH OSCILLATING RECEIVERS

AS DESCRIBED in Mr. Bouck's article on page 365 the so-called single-circuit receivers are all of an oscillatory character. It should be understood that the use of a vario-coupler in such circuits does not make them loosely coupled. In fact, the vario-coupler in

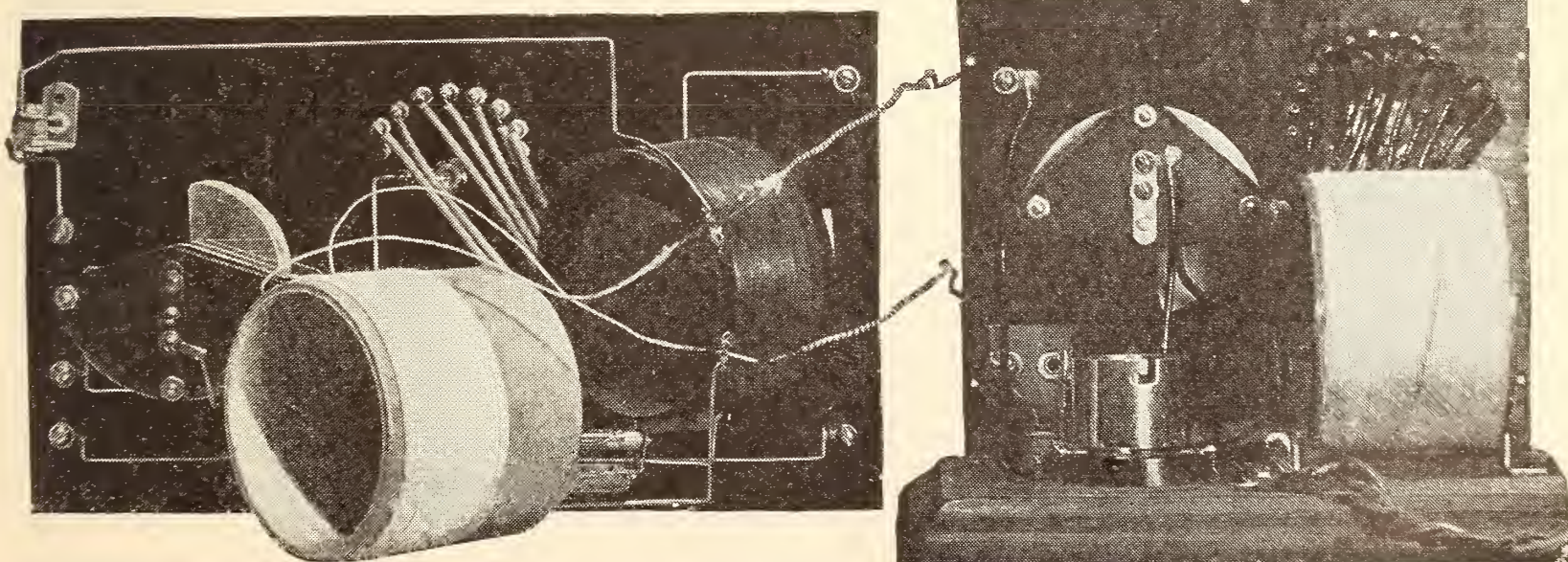

FIG. 3

Even as rudely constructed an output coil as the one above will perform satisfactorily. It need only be placed in inductive relation to what was previously the antenna coil of the single circuit receiver

such circuits is not technically a coupler in the usual sense, and the circuit arrangement illustrated in Fig. 3, should be used. In order to procure the proper coupling between the amplifier and any type of single circuit receiver, an output coil is used to replace the primary of the vario-coupler. (Coil B in Fig. 1).

The output coil is made by winding 45 turns of No. 25 D.C.C. wire on a cylinder having an outside diameter of  $3\frac{3}{4}$  inches. This coil should be equipped with a switch and 3 taps—one at 15 turns, one at 30, and one at 45 turns.

The antenna and ground posts of the single-

circuit receiver are then connected by a piece of wire as shown in Fig. 2 and thus a closed circuit, capable of tuning, is formed. It is, in effect, similar to the secondary circuit of Fig. 1 and the output coil acts as the primary.

An amplifier of this type is easy to build and easy to operate, it is worth its weight in gold for increasing the range of your receiver, increasing selectivity, reducing interference from undesired stations, and last, but not least, it prevents your receiver from "blooming" for which your neighbors will forever call you blessed.

## What We Think the Public Wants

BY E. F. McDONALD, JR.

Zenith-Edgewater Beach Station, WJAZ, Chicago

**T**HERE has always been a considerable division of opinion about what the public really wants in radio broadcasting. Many broadcasters thought most listeners wanted jazz, and others felt that a predominance of classical music would be most pleasing to their listeners, and so on. A survey of the daily radio programs gave proof that the station owners or operators had widely differing notions. They must have arrived at their judgments by some mysterious individual speculation. As for ourselves, we knew no just estimate could be arrived at through the desultory method of making inquiry here and there; nor could we rely much on the daily hundreds of letters from listeners. Constructive suggestions in letters were all too few.

So the idea of a scientific investigation developed among the three Chicago broadcasters. It was decided to put the question up to the entire radio audience. What kind of radio entertainment do you prefer? The three Chicago stations, Westinghouse Electric and Manufacturing Company Station KYW, the Chicago Board of Trade Station WDAP and the Zenith-Edgewater Beach Hotel Broadcasting Station WJAZ joined in the undertaking. Concretely the test took the form of "The Listeners' Vote Contest" and was staged during the recent Chicago Radio Show.

The public displayed interest which quite surprised all of us. It had an opportunity to

make its wants known, and did so in no uncertain fashion. For a period of twelve days, at frequent intervals, during each daily broadcasting period, the listening audience was asked their choice of classical, popular, jazz, instrumental, vocal music; of religious, political, educational talks, etc. Active participation on all sides was invited on the ground of influence which the general vote would have, not only on radio programs for the time being, but on the future of radio. That was the major inducement. The three stations also offered another incentive to the listener in many prizes such as complete radio sets and radio parts. A veritable flood of responses deluged the three stations. The personnel gasped at the tons of mail that had to be counted and sorted, tabulated and analyzed in several different ways. Office help was multiplied twenty times and mail order house activity reigned those twelve days where before had been the quiet repose and dignified atmosphere of the musical studio. A careful count places the number of letters received by all three stations at 263,410.

### ONE LISTENER OUT OF FIFTY ANSWERED

**C**ONSERVATIVE advertising men of broad experience with whom counsel was taken, agreed that not more than one person in fifty will respond to the most attractive advertisement or prize contest. Accordingly, the listening audience of the three large

Chicago broadcasting stations may be safely estimated at 13,170,500. WJAZ, the Zenith-Edgewater Beach Hotel Broadcasting Station, claims the largest audience — 8,534,950. The number of replies received by this station alone was 170,699 of the total of 263,410. In one day this station received 20,152 pieces of mail, representative of an army of listeners upward of a million, scattered in all directions, but yet, considering both intensity of population and degree of distance, pretty well represented every state of the union, the Islands, Canada, Greenland, Central and South America.

WHAT THE VOTE SHOWED

AN ANALYSIS of the vote revealed several things which surprised us. Perhaps the most outstanding is the marked taste of our "voters" for classical music. The partisans of classical music exceeded only by six per cent. (of the total voters) those who preferred the popular. More men than women voted. The proportion was 67.4 per cent. men and 32.6 per cent. women. This gives some color of reality to the frequently asked question of the irrepressible cartoonist as to whether the women of the land prefer their husbands at the club until midnight or at home listening to the radio until two.

In none of the announcements of the vote contest was reference made to old songs, yet 5.7 per cent. of the votes specifically asked for them in preference to all else.

Independent deductions can be made from the following tabulation of the vote.

- 2.7% desire Band Music
- 24.7% " Classical music
- 2.9% " Dance music
- .3% " Dramatic music
- 1.0% " Hawaiian Music
- 18.4% " Jazz
- .3% " Mexican music
- .3% " Male solos
- 5.7% " Old-time songs
- 1.7% " Grand opera
- .9% " Orchestra
- .5% " Pipe organ



A QUARTER OF A MILLION LETTERS

Are in these bulging mail bags and the wire cage. During the twelve days of the "Listener's Vote Contest" recently held in Chicago, stations WJAZ, KYW, and WDAP received letters from every state in the Union, Alaska, Canada, Mexico, Cuba, Bermuda, and Central America, each bringing its suggestion of what the radio programs should be. Miss King and W. J. Hermann, both of Chicago, are shown in the photograph

- 29.0% " Popular music
- .3% " Quartette instrumental
- .2% " Male quartettes
- .8% " Mixed quartettes
- .5% " Religious music
- 2.1% " Sacred Music
- .7% " Saxophone
- .6% " Symphony music
- 2.1% " Vocal selections

At WJAZ, we have from the first felt that a well balanced program over-emphasizing no one thing and one which gave particular attention to the best in music, was what the public, or at least our public wanted. And our previous estimate, together with the figures from the test vote shows that desire for the better music is growing stronger. Like a good book, good music unfolds additional beauty and charm in the repetition. The flimsy character of jazz and most of the cabaret type of music we generally acknowledge. All the music in that category serves its purpose, such as it is, and probably

will never lose popularity of a sort. But the real substance, what may well be called the meat and potatoes of the musical menu, is that which appeals to the higher intelligence and finer emotions. Thus we reasoned from the very inception of station WJAZ. The recent vote proved we were pretty nearly right. From its first day "on the air," the Crystal Studio of WJAZ was devoted entirely to the best in music, and eventually became known as one of the dependable sources of classical music in the realm of radio. The Oriole Orchestra in the Marine Dining Room which alternates with the Crystal Studio supplies entertainment in lighter vein, and furnishes whatever popular "relief" the program needs.

Greater familiarity with good music is developing partiality for it. The talking machine has been an important factor in music's advance. Popular bands insinuating better music at every opportunity have helped much. And now radio with its all pervasive influence, more than any other agency, is bringing classical music into its own. In former days, when only the well-to-do could afford to hear so-called artistic music, they alone evinced any general desire for it. But now radio gives equal opportunity to people in all walks of life, no matter how lowly, to hear the best music, there is a commensurate growth of general appreciation for it. When Miss Florence Macbeth of the Chicago Civic Opera sang a series of operatic selections on Saturday evening, December 23, more than 5,000 letters of thanks were written to her.

Here is a sample program from our station:

1. *Sobbing Blues*  
*Faded Love Letters* Orchestra
2. *My Lovely Celia* (Old English)—Munro.  
*The Pretty Creature* (Old English)—  
Storace Baritone Solos
3. *Souvenir de Moscou*—Wieniawski  
*Mazurka*—Mlyuarski  
Violin Solos
4. *Where 'Ere You Walk*—Handel  
Baritone Solo
5. *Berceuse*—Chopin  
*Ballade*—Chopin Piano Solos

6. *Silvery Moon*  
*Marcheta* Orchestra
7. *Do Not Go My Love*—Hageman  
*Minor and Major*—Spross  
Contralto Solos
8. *Sonata, D Major*—Mozart  
Violin Solo
9. *Sunshine of Mine*  
*Pekin* Orchestra
10. *My Heart At Thy Sweet Voice* (Samson  
et Delilah)—Saint-Saens  
Contralto Solo
11. *Liebestraum*—Liszt  
*Etude*—Chopin Piano Solos
12. *Retreat*—LaForge  
*Pirate Song*—Gilbert Baritone Solos
13. *Londonderry Air*—Kreisler  
*Rondine*—Beethoven-Kreisler  
Violin Solos
14. *Susie*  
*Wonderland of Dreams*  
Orchestra

Twenty years ago this program would have been branded as high-brow, and as intended solely for the ears of high society. Now it is every day diet, for the consumption of the radio audience in the lumber camps, on the plains, in the rural districts, in the tenements, and homes, and clubs of the city dwellers, the largest number of whom within the influence of the Chicago broadcasting stations, we think, pay radio allegiance to Station WJAZ. And we are sure our judgment of programs is responsible.

Even before the Listeners' Vote Contest, we had thousands of testimonial letters from all parts of the country, some written in aristocratic hand and on crested stationery; some on the letterhead of the business or professional man; some in pencil on soiled paper in illiterate fashion, but all giving testimony of how the human heart whether in the mansion or in the hovel beats response to good music. Those letters gave lively encouragement to us to continue as we had set out. But it could not be affirmed that these letters were representative of the majority opinion. Our judgment of popular approval, however, was definitely substantiated by the acid test; the Listeners' Vote Contest.

# 1923 Passes in Review

And in Passing Reminds Us that We Have Done a Business of \$150,000,000—That the Vacuum Tube Business Alone Is One Fifth the Value of the Incandescent Lamp Business—That Our Entire Nation Has Heard Three of Its Presidents Speak and Suggests the Question "Who Pays?"

By J. H. MORECROFT

Professor of Electrical Engineering, Columbia University

**A**S WE look back over the accomplishments of radio broadcasting during the year just closed we can certainly feel that the rosy predictions ventured at the beginning of 1923 have been well vindicated. It doesn't seem possible for radio to continue to develop at such a rapid pace during the next few years, but then, who can say? There are still many important questions to be solved, such as—Who is going to pay? but the lack of a solution for these problems apparently does not act at all to prevent continued rapid progress.

## INCREASE IN IMPORTANCE OF RADIO'S MISSION

**A**S WE try to put into their proper perspectives the various features of radio broadcasting which have shown development during the past year those broad questions dealing with the general utility of radio to the people at large loom big in the foreground. Is radio forcing itself upon the people of our country as a necessary part of their every-day life, or has it remained the plaything of enthusiastic youth and a source of income for a few small dealers in radio parts? The answer is, of course, evident. During the past year the people of the United States by the hundreds of thousands, have listened to the voices of three of their presidents, an event which RADIO BROADCAST spoke of a year ago as one of the great benefits

radio was sure to bring to the American people.

HARDING

**T**HE deep, resonant voice of the late President Harding was heard by more of his people than had been that of any former president. This may seem like an exaggeration when we think of the way the people used to flock to hear Theodore Roosevelt; always he spoke to crowded houses but even so, the number who heard him remains comparatively small. An audience of five thousand people is a large one; it takes a very powerful voice to be heard by such a group of people, yet when Harding spoke to the few thousands in the auditorium at St. Louis, for example, he had an invisible audience of five hundred thousand, conservatively estimated. This is as many people as Roosevelt could have addressed in possibly two hundred and fifty packed meetings, in the larger cities. In the words of the physicist, the size of the President's audience of to-day is of "a different order of magnitude" than it was three short years ago. It is five hundred times as great.

WILSON

**N**OT only did we hear President Harding plead with his countrymen to see the grave situation of the world with him, eye to eye, but we heard that great exponent of idealism, Woodrow Wilson, pour forth invective on

## Looking Back Over the Year

Says Professor Morecroft, "In spite of some disappointments, if the next few years give us as much improvement and advance in radio broadcasting as the one just ended has done, it passes our imaginative powers to predict what its status and service may become."

RADIO BROADCAST now presents this review of radio in 1923 after the accomplishments have had time to be soberly weighed and balanced. It is doubtful that any one person in the radio art is better able to picture for us what has gone on in radio during the past year. His treatment of this vast subject is concise, clear, and very much to the point. It will give you some idea of what has been and what may be done with our infant giant.—THE EDITOR.



THE FIRST PRESIDENTIAL BROADCASTING  
The late President Harding at the  
microphone in St. Louis, June 21, 1923

those responsible for failing to further the close international relations which he endeavored to bring into being. A remarkable example of what radio can do, was that short address of Woodrow Wilson. Due to the excellent engineering preparations of the telephone company's staff, his voice was carried by the ether ripples so faithfully that we could almost imagine he was in the same room with us. Never before (or since, it seems) have we had such a demonstration of radio's ability to conserve the quality of the human voice as it is thrown over hundreds of thousands of square miles of our country.

COOLIDGE

**M**ORE recently we heard our present Chief Executive deliver his message to Congress, in that cool, matter of fact, modest fashion, which so well exemplifies his character.

It is incomparably more interesting to hear the message delivered than to read it in the next morning's paper. We now regard it as an established custom that when any thing of great moment is taking place in the national capitol, or anywhere in the country, for that matter, we shall be "let in on it."

LLOYD GEORGE

**A**ND not only have we heard our own leaders but hundreds of thousands had the privilege of listening to one of the world's cleverest statesmen, the one man who was able to hold his high position secure during the entire duration of the World War. Lloyd George might have addressed possibly fifty thousand people in his tour of this continent, without the help of radio; as it was, probably one million Americans heard the persuasive voice and telling arguments of the little Welsh statesman.

All this has been accomplished in an art which, only a dozen years ago, was regarded as so undeveloped that several unscrupulous promoters were seriously in danger of a long term in the Federal penitentiary for trying to sell radio telephone stock; the enthusiastic circulars promised large returns from a field of such dubious possibilities that Uncle Sam regarded the men involved as either criminals or fools. Of course such a company as that which runs WEAf can still vouch for Uncle Sam's judgment being sound when he brought to the bar of justice the promoters who so glibly proved their anticipated profits from the radio telephone game. Most broadcasting stations, as a matter of fact, would be glad to-day to have these same promoters step in and show them how to make money on their stations. Most of them have their accounts on the wrong side of the ledger and there is no one to-day with vision keen enough to point out to us how some of the items may be shifted to the other side. This is one problem which 1923 has seen fit to leave to its successors.

INCREASING THE EFFECTIVE AREA OF BROADCASTING

**N**OT only have the events which radio has broadcast during the past year been of continually increasing importance, but the distances covered have almost equally been extended. In the deep Colorado canyon, the engineering explorers were able to tap the all-pervading ether and listen to the activities of their fellows in spite of the fact that 2,000 feet

of impassable cliff separated them from the earth's surface, and miles upon miles of falls and rapids lay between them and us, whether they proceeded down the river or returned. And from near the North Pole McMillan actually talks to his club members in Chicago and dedicates their new club house for them; at Christmas time he listens to the voices of those of his kin he has left behind. But at the same time another explorer has entirely disappeared, in so far as radio is concerned; although he had radio equipment to keep in touch with home, an impassable barrier of some kind throws back Amundsen's radio waves to the region whence they started. While McMillan seems only a short distance away from us, Amundsen has apparently sunk into such an ether pit that his signals cannot possibly get out.

#### AID TO EARTHQUAKE SUFFERERS

IN JAPAN'S earthquake crisis, radio was the only link by which these people could tell us of their trouble and needs. Cables were twisted and broken by the convulsed bottom of the sea. Only the unbreakable fields of the electrons remained to transfer communication over the thousands of intervening miles. Such prompt aid as we were able to offer must have been seriously delayed had it not been for this radio link which kept us in touch with stricken Japan.

#### HOLIDAY RUSH TO EUROPE

IT IS interesting to note that during the Christmas holidays the messages of good cheer from Americans to their European kin piled into the Radio Corporation's office at such a tremendous rate that even the ether seemed to be taxed to carry its burden. Thousands of those living in our land of plenty were trying to cheer their friends and relatives in Europe (especially those in Germany) during the season that should have been festive for everyone. The messages to Germany accumulated at such a

rate that the traffic manager surely would have been overwhelmed had it not been for the flexibility of the radio links. No sooner had the stations transmitting to England, Norway, and Poland been freed of their traffic than they were all put to the task of sending *Fröhliche Weihnachten* and *Glückliches Neu Jahr* to the German receiving operators. Five powerful stations all concentrated their ether missiles on that part of the earth's surface and so the abnormal traffic demands were easily taken care of. Such a rapid shift of channels would probably have been impossible with any other means of communication.

#### VOICES, SPAN OCEAN

OF EVEN greater significance than these feats of the powerful ocean-spanning radio channels is the successful attempt of the broadcasting stations, both professional and amateur, to throw the human voice across the Atlantic. Although the results were not as satisfactory as we had fondly hoped for, still they showed that such communication is possible under good conditions and that as we make the transmitting apparatus more powerful, and our receiving apparatus more free from disturbing influences, talking across the Atlantic will be an everyday occurrence. But a single month after the close of the trans-ocean broadcast tests English listeners heard



THE "BOWDOIN" FROZEN IN FOR THE WINTER  
It is in this icy expanse that radio has penetrated to "lift dread monotony"



#### RADIO STATION JAA WAS THE ONLY LINK JAPAN HAD WITH THE OUTSIDE WORLD

This antenna, strung on 660 foot masts, with 500 kilowatts behind it, saved unnumbered Japanese and foreign lives in the recent great earthquake. Land lines and cables alike failed, while radio carried on

a complete concert from this country and re-broadcast by their own stations.

#### GOVERNMENTAL ACTIVITIES

**D**URING the past year radio broadcasting benefited greatly from Government acts which were a long time coming. The re-allocation of wavelengths for broadcasting, even though confined to a much narrower band of frequencies than we think broadcasting is entitled to, was a great boon to those who want to hear distant stations, as well as to those who are situated close to several stations. The unbearable condition which existed when but 360 meters and 400 meters were available to the broadcasting stations has vanished, and, with the exception of a very few who live within the shadow of a powerful station, and a somewhat greater number who have yet to learn how to operate their sets selectively, interference has been practically done away with, in so far as it was due to the broadcasting stations themselves. We do occasionally hear a whistle due to the beat note between the carrier waves of two distant stations, but often one of the stations is operating at a frequency appreciably different from that assigned to it by the Government.

#### THE BUREAU OF STANDARDS' WORK

**T**HE Bureau of Standards has pursued a worthwhile work in trying to change our wavelengths to frequencies, our meters to

kilocycles. The advantages of speaking in kilocycles, instead of meters, has been well analyzed in RADIO BROADCAST on previous occasions, and is so evident that even though the radio public is loath to throw over any of its newly acquired radio terms, and replace meters with kilocycles, the change seems sure to come about, even though slowly. Especially to the technically trained radio engineer this change in terms is appreciated to be a forward step in radio nomenclature.

It wasn't long after the radio boom started before the Bureau of Standards was flooded with requests for the calibration of radio apparatus. Now, although this is exactly the kind of work the Bureau is supposed to carry out, the staff was altogether inadequate to satisfy the demands for calibrations, and it could not be sufficiently augmented by trained technicians because of the very meager salaries the Government offers to those entering the lower positions at the Bureau. Naturally most of the work called for was the calibration of wavemeters, for every responsible operator realized at once that he must know accurately the frequency his station was sending out.

Besides calling to its aid several of the University laboratories, in carrying out this calibration work the Bureau decided to follow the precedent established by the French during the war, of sending out, periodically, standard frequency signals; thus instead of the wavemeters being shipped to the Bureau of Stand-



ards for wavelength calibration the standard frequency was delivered direct to the customer, and he could do his own calibrating. Circulars were sent out recommending certain reliable methods of utilizing these standard frequencies.

This service is one of the most valuable, if not the most valuable, the Bureau has contributed to the radio art; it is still maintained on regular schedule, as it should be, and is now being further augmented by the Bureau sending out the frequency of those broadcasting stations which are maintaining their specified frequency within a reasonably narrow limit. This "standard frequency service" of the Bureau will do much to improve the situation in broadcasting in so far as it is affected by the beat notes between carrier waves of different stations.

#### BROADCASTING AID TO THOSE IN TROUBLE

**D**URING the past year radio has, on innumerable occasions, proved itself a genuine contributor to human safety. How many shipwrecks have occurred during the last twelve months in which radio has well played its assigned rôle? We must reckon by the hundreds, the lives of those shipwrecked passengers and crews who have been speedily picked up by a vessel which, perhaps a hundred miles or more away, was called to the scene of the accident by the appealing SOS call of the stricken ship. This, the greatest of all the services radio is carrying out for us, goes on now as a regular part of our daily life, and we know nowadays that, except under the most severe weather conditions, a wreck at sea does not necessarily mean the loss of a single life.

#### SERVICE TO THE INDIVIDUAL

**T**HE number of cases of service rendered to individuals by radio, and to the Government when it is seeking criminals, steadily mounts. The well known radio engineer, E. F. W. Alexanderson, himself, was well repaid for his contributions to radio's progress when his kidnapped son was found through radio broadcast messages. No longer can the criminal escape the law by booking, immediately after his crime, passage on a European-bound steamer. Even before she has passed from sight of our shores a description of the escaping man is being received in the ship's radio room and he is more securely trapped than if he had never left the country.

#### RADIO COMPASS

**I**N SPITE of the wonderful radio compass service the Government has adopted, a few months ago, our navy had the most disastrous accident ever put into its records. Six destroyers piled up on the rocky coast of California in spite of the fact that radio compass bearings were available and should have neutralized the risks of navigation which fog and storm had imposed. We have never had evidence however that radio did fail in this accident; it seems more than probable that the man responsible for the disaster depended upon his intuition rather than the certain guide of the compass bearings which were his for the asking. Thousands of ships are now safely navigated in foggy weather by the help of this service. The number of accidents averted by its use are beyond reckoning.

#### HEALTH OF BODY AND SOIL

**T**HE Government's health service talks, its spread of the news valuable to farmers telling of the weather to be expected and what products he can profitably dispose of in the morrow's market, its continued radio time service to ships at sea, all have an ever increasing importance in our daily lives.



C. A. HOXIE

Recording his own voice on his own invention — the pallophotophone



THE NAVAL RADIO STATION AT PT. ARGUELLO, CAL.

Near which six American destroyers went on the rocks in heavy weather last year. It was from the radio compass station here that the disputed bearings were asked for and received

#### IN THE RADIO BUSINESS INCREASES

TO THE business man of America, the radio industry is becoming a power to be reckoned with. According to reliable estimates the total sale of radio apparatus last year was one hundred and fifty million dollars. Only three years ago it was practically nothing. The radio public didn't exist; it was instead the phonograph public putting its money into machines and records, but in these same three years phonographs and records have suffered a terrible relapse. Losses and bankruptcy seem to face the talking machine manufacturers although it is not at all evident that this condition of affairs is necessary; it seems that radio and the mechanical reproducers might have prospered side by side, each aiding the other in getting its share of the public's money, but such wasn't the fact. It has frequently been stated therefore that radio has killed the business of mechanical

reproducers. Now it is likely that the real reason for the slump in the record market was due to the comparison we couldn't help making between the two methods of getting the voice and music. As even the phonograph manufacturers must admit, the ordinary record is a pretty poor imitation of the human voice; practically all of them give a very disagreeable scratchy noise and even when they don't the enunciation is seldom distinct enough for one to understand the words of a song, for example, unless it is repeated many times. Contrast with this the reception, with a good pair of head phones, using a crystal or non-regenerative receiver, from a well modulated station. Every word is at once understood, the words of a song, and even *patois*, are well reproduced.

Had the phonograph people been willing and able to improve the quality of their product to make it a reasonable competitor with radio, their business would not have been in the difficult straits it is in to-day.

The sale of vacuum tubes alone last year was about \$24,000,000, about one fifth as much as the electric lamp business, a business dealing with one of the necessities of life, about forty years old, whereas the triode business is in its third year.

The quality of the apparatus offered to the radio public was a great improvement over that sold the year before. Then, every small machine shop was turning out coils, condensers, rheostats and what not, and most of it was of quite disreputable quality. These fly-by-night concerns have largely disappeared, leaving more reliable manufacturers in the field, to the great improvement of the product. The company which furnishes most of the laboratory apparatus for radio experiments has improved its products. Practically all of it shows skill and care in design and workmanship.

#### DEVELOPMENTS IN THE THREE ELECTRODE TUBE

**U**NDoubtedly the one great improvement which the past year furnished to the radio art had to do with the triode, the

really essential part of any transmitter or receiver used in radio communication. The improvement with which most of us are familiar, naturally has to do with the small low powered receiving triode. Instead of requiring a storage battery of considerable capacity to operate our tubes, dry cells now serve. The amount of current required to heat the filament has been decreased to exactly one twentieth of what it was with the older tungsten filament triodes. And this great improvement, it should be pointed out, is really the contribution of pure science. Who would have thought that a layer of thorium only one molecule deep at its thickest part could so easily liberate the caged-up electrons which are needed to make the tube function? A dull-red, thoriated filament, heated with only one sixteenth of an ampere loses practically the same number of electrons as did the old white-hot tungsten filament requiring one and a quarter ampere at twice the voltage used for the new filament. These little dry cell triodes



Photo by Fairchild Aerial Camera Corp.

#### WHAT AN ETHER MAP LOOKS LIKE

The white lines show how the signal intensity, or field strength of WEAF, New York varies. In several sections of the city this station's signals are extremely weak. WEAF is located almost in the heart of the great canyons of the downtown high building district. These tall steel buildings seem to cast radio shadows. This aerial-ether-radio map shows the field strength of the station is reduced one fifth at the tip of Manhattan, hardly ten blocks away

are the greatest boon of the year, in the opinion of the millions of radio enthusiasts.

And not only in the small receiving tubes was remarkable advance made. Some experimenter with more ingenuity and common sense than the rest of us got the idea that the reason ordinary metal could not be sealed airtight into glass was because the glass pulled away from the metal as it cooled down, thus leaving a fine crack through which air could penetrate. And such being the fact why not make the metal sufficiently flexible at the place it joined the glass that when the cooling glass tried to pull away the comparatively weak metal would follow it? With this very simple analysis of the problem furnished, it was really solved. It is now possible to get airtight seals between big copper tubes and correspondingly large glass tubes, by making the copper very thin where it is to be stuck to the glass.

This simple and ingenious solution of a problem which has vexed physicists for years opened the way at once to the construction of very high powered transmitting tubes, the upper limit of which had previously been fixed by the safe heating of the plate, which was inside the tube just as it is in the ordinary receiving tube. But with the new construction, the plate could just as well be on the outside of the triode, so why not use a metal tube with the filament and grid inside, the metal tube itself being the plate? Such was done, and the plate can now be cooled by partly immersing the triode in running water, a very efficient cooling scheme. Thus at one fell swoop the possible output of high frequency power from the largest tubes was changed from one to one hundred, or even one thousand, kilowatts. A few of these water cooled triodes can replace, and indeed have replaced, one of the huge Alexanderson alternators used for transoceanic traffic.

#### TRANSMISSION OF POWER BY RADIO

MUCH has been said, not only last year, but in previous years, about the transmission of large amounts of power by radio and it is a most fruitful field for conjecture. Some thought that airplanes could be held in a powerful radio ray, from which it might extract the energy it requires to sustain itself. Again, it has been thought that radio rays might be used, so powerful that by concentrating one on the work of an enemy the undesired object would at once be consumed. No real advance

has been made in this problem, and none is likely, in spite of the late Doctor Steinmetz's predictions to the contrary. Last month Doctor Whitney, director of the General Electric research laboratory, where we might expect such things to be done if they were possible, showed how it was possible to light a small incandescent bulb by radio power. The lamp which was lighted was connected to a coil about two feet from a powerfully oscillating triode of large power output. This looks like the wireless transmission of power, and in fact, it is of course just that, but it wasn't the outcome of progress in the problem of power by radio at all. Every electrical engineer knows of many instances in which electrical energy is transferred from one circuit to another without connecting wires. The lighting transformers mounted on the poles of the electric company, in every suburban community, are just as good illustrations of the same thing Doctor Whitney showed. We ordinarily say that the energy gets from one circuit to the other by mutual induction, a phenomenon well known by Joseph Henry and Michael Faraday nearly a century ago, but they didn't ascribe it to the transmission of power by radio; neither should we.

#### NEW TYPES OF RECEIVING SETS

NEW receiving sets have been seeking the approbation of the radio public during the year just passed. With the coming of the low power receiving triode, many listeners decided that the much desired super-heterodyne receiver was within their reach. It seems certain that this type of receiver will be adopted by many of those who must travel great radio distances, who constantly seek stations farther and farther away. This type of receiver has been used in making practically all the long distance receiving records.

The difficulty of making a stable high frequency amplifier has long been recognized; due to the internal capacity of the triode, between the grid and the plate oscillations are almost sure to be set up when the amplifier is properly adjusted to amplify an incoming signal. An oscillating amplifier is useless; it will not amplify at all. So when Professor Hazeltine pointed out the way to neutralize the tendency of the high frequency amplifier to oscillate, a great step forward was made in this branch of radio. It now appears that the Radio Corporation had, in its files, a patent

which, they allege, covers the same idea, but it seems also that the engineers of the Corporation didn't appreciate the value of the idea. Credit for showing the value of this neutralization of the triode capacity, by employing a circuit properly designed to do it, rightly belongs to Hazeltine. This type of set is now on the market under the name he has chosen for it, the neutrodyne. This new set has been much in favor because it requires no fussy adjustment of rheostats or regeneration to make it perform at its best. A simple chart

of condenser settings, once obtained for all the stations within the range of the set, enables one to tune in on them at any time and get them if they are sending; no hair-splitting adjustment is necessary before the operator feels that the set is doing all it can to bring in the desired signal.

#### SINGLE CIRCUIT REGENERATIVE SET STILL HERE

THE now doubtfully famous single circuit regenerative set is still satisfying many and disgusting more. In the hands of one who knows how to use the set, it undoubtedly yields much satisfaction and does not necessarily annoy one's neighbors. After the Christmas holidays, however, when every new fan was making his Christmas present oscillate as violently as possible, "to increase the receiving range" we well realized the reasons for classifying it as radio's greatest nuisance. In the vicinity of the large cities, evenings were filled with such a collection of hums and whistles that a large and active swarm of bees would have been put to shame.

This type of receiver is surely due to be discarded, in spite of its efficiency and simplicity. Whereas it is conceivable that every one owning such a set will in time become sufficiently familiar with its behaviour to realize its shortcomings and not make it oscillate any more



HAROLD W. BEVERAGE

Whose work on the "wave antenna" for reception has won him the Liebmann Memorial Prize

than absolutely necessary, it is still easier to conceive a whistle-less ether if these sets are done away with.

A two-circuit regenerative receiver (if regeneration is advisable at all) gives only a small fraction of the interference that its single circuit brother does, and with a little practice can be made to perform about as well in so far as distance is concerned, and much better as regards the selectivity of the set. In spite of the great impetus this single-circuit receiver, due to Mr. Frank Conrad, gave to radio broadcasting as a result of its great sensi-

tiveness and ease of adjustment, it is time to dispense with its services. This is only a natural development and it should be done away with for the same reasons that steam engines are being supplanted in electric power houses by the more efficient steam turbine. The steam engine was a wonderful device and its originators cannot be given too much praise, but due to changing conditions, it is being supplanted by other apparatus which is more economical of coal. We need a set which is more economical of the ether than is the single circuit regenerator, and the past year has given us several to choose from.

#### PROGRESS IN KNOWLEDGE OF TRANSMISSION PHENOMENA

GREAT contributions have been made to our knowledge of how radio waves are propagated. Last year we had a hazy idea that stations did not transmit as well in some directions as in others, that there were apparently dead spots in the region surrounding a station, that the strength of a given signal did increase and decrease in an irregular manner, but all these ideas were merely qualitative only, and open to challenge.

The past year saw great advance made in the art of measuring radio signals. Trained

experimenters have actually plotted curves showing accurately the strength of signal to be expected in different directions from a given station and have developed the measuring scheme to such a state that a proposed location for a new station is now thoroughly mapped (electrically) to test its suitability. These electrical surveyors have already saved prospective station managers much chagrin and money.

Only last month Mr. G. W. Pickard gave a most interesting paper on the phenomenon of fading, as noted on page 374 of this issue. We now know exactly to what extent a signal waxes and wanes from minute to minute, and even though we have no way of preventing this, the information Mr. Pickard has given us is most welcome and valuable.

#### RADIO IN TRAIN CONTROLS

**I**N ANOTHER field, radio has made no progress where one might think it well adapted to function, and that is in automatic train control systems. One would think that radio would lend itself admirably to the automatic prevention of collisions, yet such application of radio is still to be made. While Government commissions are ordering railroads to put in automatic train stop devices of any kind that will work, the field seems to be occupied with cumbersome electromagnetic brakes and air pressure systems. A stalled train could use a vacuum tube transmitter to act on sensitive relays of approaching trains with ever increasing certainty as the distance between them decreased. The signal received on the approaching train would rapidly increase in intensity as the imminence of collision increased so that the scheme seems to have just the right characteristics. But the year just passed didn't show results of these conjectures that were of importance.

#### USE OF SHORT WAVES FOR RE-TRANSMISSION

**T**HE inauguration of double wave transmission at KDKA, the pioneer of broadcasting stations, marks a real step in the progress of broadcasting. Here they send out regular programs on the specified frequency of 920 kilocycles, and also transmit it on 3,200 kc. This radiation is picked up at KFKX, Hastings, Nebraska and used for modulating this station, thus making the high frequency radio wave connect the two stations just as the telephone company now operates several stations from

the same microphone by wire connection. It was thought that there would be less fading and less interference if this very high frequency wave was used as the connecting channel, but it seems that a much greater advantage in using the high frequency link lies in the possibility of directing and focussing the beam of radio waves. Marconi and Franklin have shown that by using a reflector at both sending and receiving stations such directive and focussing action is possible and that the received signal is increased hundreds of times over what it would be with the usual non-directive radiation. This kind of radio link between stations, where a comparatively narrow beam of waves is originated at the focus of one mirror and gathered at the focus of another, is a very likely development in the near future.



#### THE NATIONAL ASSOCIATION OF BROADCASTERS

**T**HE stand taken by the Society of Authors, Composers, and Publishers in demanding royalties where none were available, as well as the desire to answer the question—Who is going to pay? gave rise to the National Association of Broadcasters, as we have mentioned before in RADIO BROADCAST. This group of enthusiastic station managers has apparently succeeded in their scheme to popularize new music by broadcasting it for the authors themselves instead of letting some society, which would take most of the profits, handle the "plugging" of the new song or dance piece. The scheme of course takes time to get under way, but the prospects for its success seem excellent at this time, only a few months after the inception of the idea.

#### EDUCATIONAL RADIO

**E**DUCATIONAL radio, of real cultural value, has been tried in a small way, and those responsible for the venture feel justified in proceeding with more ambitious plans for the coming year. People will apparently pay for radio material when no coercion at all is exercised; the fact that they are being given something worth while makes them willing to pay for it, even though they might get it almost as well without paying a cent. This is a very interesting phase of the psychology of the radio audience which hasn't been at all utilized as yet.

## INVENTORS HONORED BY THEIR FELLOWS

**D**URING the past year two of radio's deserving workers have been publicly rewarded for their contributions to our art. For conceiving and putting into operation the wave antenna H. W. Beverage, one of the younger engineers of the Radio Corporation, was given a prize of five hundred dollars cash, by the Institute of Radio Engineers, and Dr. Lee De Forest, the inventor of the audion, was granted the Institute Medal of Honor. These two men had quite evidently well deserved the honor their fellow engineers were so glad to bestow upon them.

## THE PALLOPHOTOPHONE

**T**HE pallophotophone, developed by Mr. C. A. Hoxie of the General Electric Co., is one of the most striking illustrations of the application of the results of pure science to a directly useful purpose. This device photographs the voice on a moving picture film and so can be reproduced simultaneously with the projection of the picture, giving the voice as it would be heard in a real drama. Of course it doesn't have to be used with a moving picture. Solely as a recorder of the voice or other sound this device of Hoxie is a valuable contribution to our technical progress.

By it, the sound waves are made to impinge on a very small mirror, causing it to vibrate back and forth with a motion which truthfully corresponds with the sound wave actuating it. A beam of light reflected from this little mirror is thrown on to the edge of a moving film and as it vibrates gives a serrated shadow on the edge of the film after this is developed and fixed. The serrations correspond to the frequency and intensity of the sound waves which were acting on the mirror. Pioneer work on this device was done by Prof. Miller of Case School of Applied Science and the late Prof. Webster of Clark University.

In using this queer looking bit of film to reproduce the original sound, a beam of light is sent through the moving film and then falls on a sensitive photoelectric cell. This is where the application of pure science is more apparently evident. Physicists have known for years that light waves falling on a fresh surface of certain metals (such as sodium) were able to actually pull some electrons out from the surface and so make possible the flow of current (flow of electrons) from the light-affected sur-

face to another electrode in the tube. The number of electrons thus pulled out of the photoelectrically active metal depends upon the intensity of the light ray, hence so does the current flowing across the tube, or cell, as it is called. This effect has been principally used by scientists to help them learn more of the structure of matter, but Hoxie uses it in a different way. The flickering beam of light emerging from his film (flickering because of the serrated shadow across it) falls on the photoelectric cell, causes a weak current which pulsates in a manner corresponding to the original voice and this current, properly amplified, gives back the original sound and gives it back with remarkable faithfulness. In demonstrating his pallophotophone before a large meeting of engineers the inventor, concealed from the audience, spoke directly into the amplifier once and then gave the same speech from the pallophotophone; the audience couldn't tell which was the man and which was the film. This device is one of the year's important contributions and illustrates beautifully the value to every one of the truth-seeking labors of the pure scientist, the man who is interested not in inventions and patents, but in searching out Nature's truths.

## REDUCTION IN NUMBER OF BROADCASTING STATIONS

**T**HE year has seen the number of broadcasting stations somewhat decrease, not that new licenses haven't been granted but that a greater number of stations have been abandoned. This is as it should be; we shall not get the best out of broadcasting until but a few very powerful stations are in operation, stations which radiate kilowatts instead of watts and stations which can afford to get the best talent available. (We have heard some frightful singing during the past year). Fewer and better stations should be the slogan for improvement at the transmitting ends of the radio channels.

## THE PATENT SITUATION

**T**HE patent situation in radio seems, to the unbiased observer, somewhat disquieting; gradually but surely a most stringent monopoly is being obtained in this field by the Radio Corporation. This possible monopoly, of course, doesn't as directly affect the radio listener as it does the small manufacturer, whose factory doors are closed by patent de-

cisions in favor of his gigantic rival. In fact monopoly in itself isn't necessarily detrimental to the progress of radio any more than it is in the art of illumination, for example; in this field the General Electric Company controls about 99 per cent. of the incandescent lamp output of America yet we can't say that the art of illumination hasn't made progress. Of course we don't know whether it might not have made much more rapid progress if others had been in competition.

The effect of a monopoly on the public's interests depends entirely on the vision and fair mindedness of those responsible for directing the affairs of the monopolistic corporation, so that the Radio Corporation, in spite of the strong position it seems to be acquiring in the radio field, does not at once merit our condemnation. We hope its management will show the same "public be served" ("at a reasonable price," we add) spirit which most public service companies are now so anxiously putting forward.

#### SOME PROGRESS IN RADIO PHOTOGRAPHY

**S**PASMODICALLY we hear of the wonderful success of the transmission of pictures by radio. If we could believe the inventors' statements, the problem has been solved several times during the past year. But if it actually

had, we should undoubtedly have had ample notification. Could radio solve the problem of rapid and accurate reproduction of pictures, it would confer to the press of the country a boon not surpassed by the linotype or rotary press. There are many newspapers at the present time supporting laboratory work aimed at the solution of this problem so we must believe that as yet it is in the experimental and undeveloped stage.

#### PRIVACY IN RADIO COMMUNICATION

**I**N SO far as we know there has been no real progress made in securing privacy in radio communication. Directive radiation, synchronously tuned mechanisms at the transmitting and receiving ends of the channel, elimination of the carrier frequency and one side band, all tend to get secrecy for a time, but none of them approaches the secrecy obtainable with ordinary wire connection. Full secrecy may come some day, but the past year contributed little to the solution of the question.

When we look back over the year's accomplishments, it is certain that, in spite of some disappointments, if the next few years give us as much improvement and advance in radio broadcasting as the one just ended has done, it passes imaginative power to predict what its status and service may become.

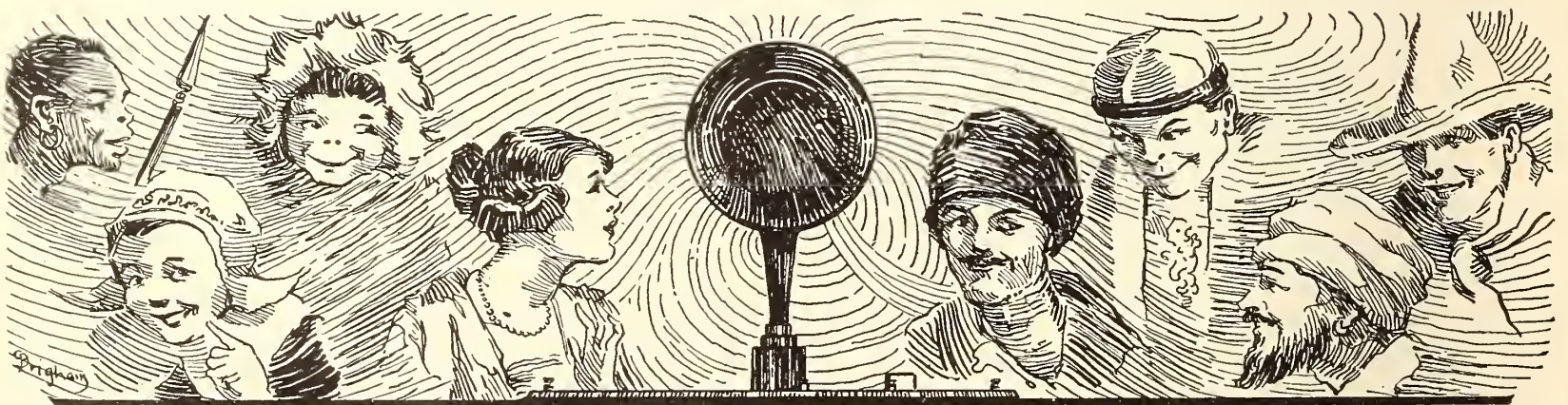



# Why No Receiver Can Eliminate Spark Interference



Presented Before the Radio Club of America as Part of the Report of the Committee on Interference

By L. A. HAZELTINE

Professor of Electrical Engineering, Stevens Institute of Technology

**W**E ARE accustomed to thinking of a radio wave as having a single wavelength, or a single frequency. Such a wave would be produced by

an unmodulated antenna current, as represented in Fig. 1a. The current here chosen for an example passes through a complete cycle in one millionth of a second, so its frequency is one million cycles per second, as represented by the single line in Fig. 1b; this frequency corresponds to a wavelength of 300 meters.

For signalling purposes, however, the radiating current must be modulated. In telephony, the modulation is by the voice; in continuous-wave telegraphy, it is by the sending key; while in other systems of telegraphy it is by some tone source in addition to the key.

## HOW MODULATION OCCURS IN CONTINUOUS WAVES

**T**HE simplest modulation would be that produced by a pure musical tone impressed on a telephone transmitter which controlled the radiating current. This current would then vary as represented in Fig. 2a, where the frequency of modulation is represented as 1,000 cycles per second. (In this figure and those that follow, it is not possible to represent

all time intervals to the same scale, as the radio frequency and the modulation frequency differ so greatly.) The effect of the modulation is equivalent to the introduction of two new currents having different frequencies called

“side frequencies.”

The side frequencies are respectively the sum and the difference of the original “carrier” frequency and the modulation frequency, and in the example chosen are therefore 999,000 and 1,001,000 cycles per second. The intensity of the radiation at the side frequencies is usually considerably less than the radiation at the carrier frequency, as represented by the three lines in Fig. 2b.

If the modulation is produced by a musical note which is not a pure tone, as for example the note of a

violin, it will have a fundamental frequency and harmonics, which are multiple frequencies such as 1,000 cycles per second for the fundamental and 2,000, 3,000, etc. for the harmonics. In this case two side frequencies are radiated for each harmonic, as 998,000 and 1,002,000 for the second harmonic.

In the voice, or in musical instruments played for a considerable interval of time, musical tones will appear having all frequencies between certain ill-defined limits. Tones whose pitch or frequency is above about 5,000 cycles per second are not appreciable, and this

## Why It Can't Be Done

Interference from spark stations is a subject that becomes of increasing importance with the sale of every broadcast receiver. Why the issue has been side-stepped so thoroughly is a matter of great conjecture. Some of the blame may be laid at several doors; but rather than place the blame, we find the Radio Club of America attempting to seek a solution.

At a recent meeting of the Club, Professor Hazeltine was asked to explain why even the most selective receiver would not eliminate this interference, even though it was receiving broadcasting on a frequency considerably above or below the code station. His most interesting and instructive analysis answers this question thoroughly.

We trust it may act as a stimulus to hasten some action whereby broadcasting and ship to shore radio service will be allotted waves sufficiently different to overcome this serious situation.—THE EDITOR.

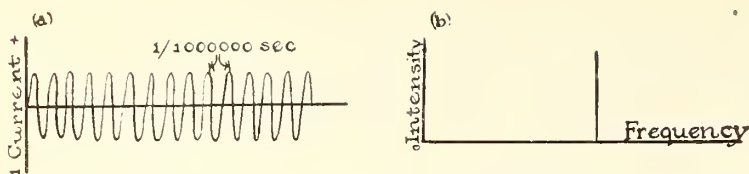

FIG. 1  
Pure, unmodulated continuous wave

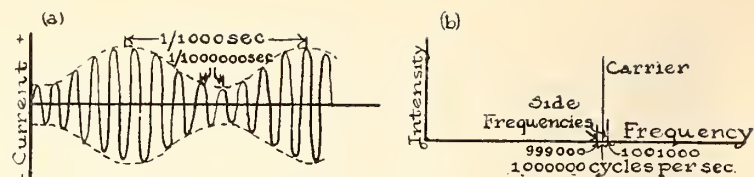

FIG. 2  
Continuous wave modulated by pure tone

figure may be taken as a safe upper limit. Hence a 300-meter broadcasting station will radiate waves having frequencies confined between 995,000 and 1,005,000 cycles per second, these extreme values having little importance. Fig. 3a represents such a voice-modulated current; and Fig. 3b represents the relative intensities of the component waves, which consist of the "carrier" and the two "side bands." Broadcast stations whose carrier frequencies differ by 10,000 cycles per second evidently have no overlap in their frequency bands and can be distinguished by sufficiently selective receivers, provided that their signal intensities are not too different.

HOW A "SPARK STATION" RADIATES ITS WAVE

A SPARK telegraph station, on the other hand, produces a radiating current in a succession of groups, each of which is of short duration, compared with the interval between groups, as represented in Fig. 4a. This is essentially equivalent to modulating a continuous wave by a variation in intensity which rises very rapidly to a maximum, then falls rapidly, and is sensibly zero for a large portion of the group cycle, as represented by the dotted envelope in Fig. 4a. Such a modulation curve is very rich in high harmonics. If the rate of building up of the oscillating current is very high and the decrement is at the legal limit of 0.2, a wave which nominally has the frequency of one million cycles per second will actually consist of waves of almost uniform intensity ranging from about 970,000 to 1,030,000 cycles per second, and of waves of rather slowly decreasing intensity extending down to very low frequencies and up to a few million cycles per second, as represented in Fig. 4b. Such a wide band of frequencies will over-

lap a great many broadcasting bands and is the cause of the great amount of interference from spark stations.

HOW THE RECEIVER RESPONDS TO VARIOUS WAVES

SO MUCH for the transmitted waves. Now let us see how the receiver responds. Selectivity is accomplished by *tuning* the receiver to a certain frequency. But the receiver will respond not only to that frequency but also to neighboring frequencies. The relation between response and frequency with a fixed tuning adjustment is represented by a "resonance curve," of which examples are given in Figs. 5 and 6. (As with the preceding figures, it has not been possible to draw these to scale.) For broadcast reception without sensible distortion of the music or speech, it is necessary that the resonance curve embrace a band of frequencies corresponding to that usefully radiated, as represented in Fig. 3b. On the other hand, the wider the band embraced, the greater will be the tendency to pick up interfering signals and atmospheric disturbances ("static"). For pure continuous-wave telegraph reception a very narrow band is best.

WHAT MAKES RECEIVERS SELECTIVE

THE shape of a resonance curve and the effective width of the frequency band are controlled in two ways: first, by the ratio of the resistance to the reactance in each tuned circuit; and secondly, by the number of successive tuned circuits.

The effect of changing the resistance of a tuned circuit is illustrated in Fig. 5. The middle curve represents conditions when the resistance of the coil and the condenser are kept low by proper design and construction,

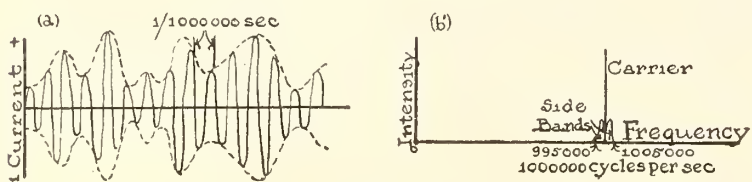

FIG. 3  
Continuous wave modulated by voice

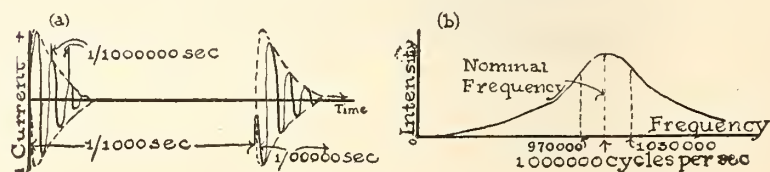

FIG. 4  
"Spark" or damped wave

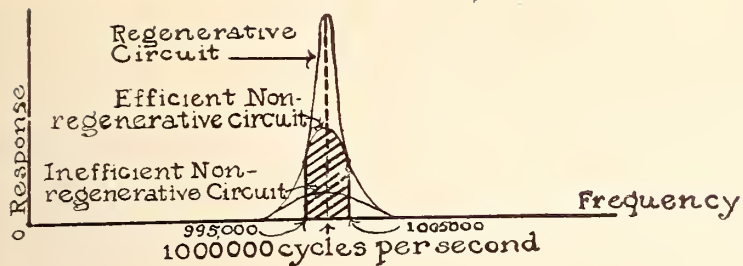

FIG. 5

Receiver selectivity with different resistances

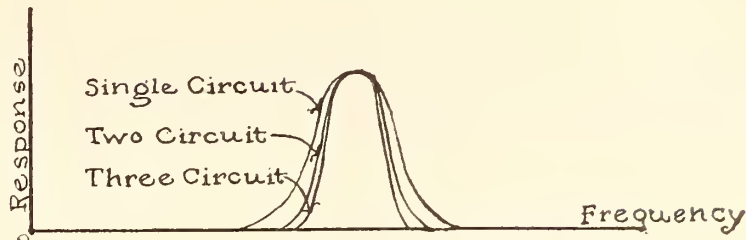

FIG. 6

Receiver selectivity with different numbers of successive tuned circuits

and gives a width of frequency band which covers the broadcast side bands satisfactorily. The moderate dropping off of the curve at the extreme frequencies is not important. The upper curve represents conditions in this tuned circuit when the effect of resistance has been artificially reduced by regeneration, and shows that distortion will thereby result. Here, the components of low audio frequencies (corresponding to radio frequencies very close to 1,000,000) are being amplified much more than those near the limiting frequency. The lower curve represents conditions when the coil and condenser have improperly high resistances. This arrangement gives a lower response to the broadcast music or speech, but the same response to interference as the other curves. It is a fortunate circumstance that for the allotted broadcasting frequencies it is feasible to design coils and condensers so as to nicely cover the frequency bands without the necessity of regeneration; for the use of regeneration is almost certain to be carried too far, resulting in distortion and finally in beat notes or "whistles" when the oscillating state is reached.

SELECTIVE TYPES OF RECEIVERS

THE effect of changing the number of successive tuned circuits is illustrated in Fig. 6. The single-circuit receiver gives a curve which drops off rather slowly outside the useful frequency band, and so is particularly subject to interference. The curves for the two-circuit receiver and particularly for the three-circuit receiver (which are drawn with

the same maximum point, for convenience) drop off much more rapidly outside the useful frequency band, though they do not differ greatly inside. This applies to receivers in which the successive tuned circuits are very loosely coupled, or not reactively coupled at all as in the neutrodyne. When the coupling is close, there is little gain in selectivity over the single-circuit receiver. It should also be noted that "three-circuit" here refers to three successive tuned circuits preceding the detector and not to a receiver having two such tuned circuits, plus a tuned plate circuit for regeneration.

ONE EXAMPLE OF INTERFERENCE EXPERIENCE

INTERFERENCE from a radio telephone broadcasting station is illustrated by the curves of Fig. 7, and is due to the fact that the response curve of the receiver overlaps the frequency band of the interfering station. This will occur only when the station is very powerful and near-by, or when its frequency is very near that being received, or when the receiver has little selectivity. To minimize this effect, the receiver should be made as selective as possible by employing more successively tuned circuits. In addition, it is frequently helpful to reduce the size of the receiving antenna or the amount of amplification.

Interference from a spark telegraph station is of a different sort and is illustrated by the curves of Fig. 8. It is not usually due to the nominal frequency of the station, but rather to those side frequencies which come within the response band of the receiver. It will be

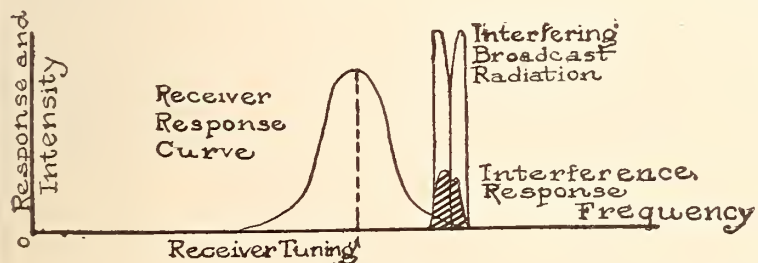

FIG. 7

Interference from telephone broadcasting station

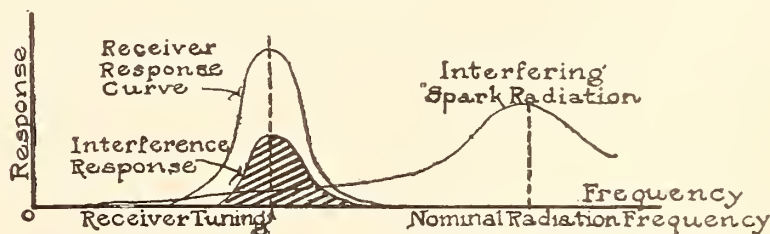

FIG. 8

Interference from spark telegraph station

reduced by narrowing the response band of the receiver as far as distortionless broadcast reception will permit; but this would be done anyhow in a properly designed receiver.

#### WHY SPARK STATIONS CAN'T HELP INTERFERING

**E**VEN if one uses more successively tuned circuits, it won't avail, *because the interfering frequency is the same as the frequency being received.* Obviously we cannot select between two waves which have exactly the same frequency.

Those who have used neutrodyne receivers, which ordinarily employ three successively tuned circuits, have observed that a strong spark station can be tuned in almost anywhere on the dials, provided only that the three dials are set for the same frequency. When the dials are set for different frequencies, usually the spark stations (and also atmospherics) are no longer heard. This is a direct proof that

the interference is not caused by the nominal frequency of a spark station, but rather by a portion of its side band.

It cannot be too strongly emphasized that the *interference from spark stations is scientifically impossible to eliminate at the receiving end.* It is also impossible to eliminate at the transmitting end unless the rates of building up and dying out of the spark oscillation can be slowed down so as to correspond with the rates of amplitude variation in modulated continuous waves. Such a result, however, has never been attained by any form of spark oscillator. The solution of the problem of interference from telegraph transmitting stations must therefore be the substitution of continuous-wave transmitters for spark transmitters. The pure continuous wave is by far the most preferable, as the modulation is at a low rate, corresponding to the keying. Modulated continuous waves, however, are not likely to be objectionable if the modulation is not abrupt.

## Sound: A Matter of Personal Opinion

By R. H. MARRIOTT

Radio Engineer, Puget Sound Navy Yard, Washington. Past President of the Institute of Radio Engineers

**B**EFORE the advent of radio broadcasting, different people selected the sound producers they thought they would like, for example, by patronizing certain types of theatres or buying certain types of phonograph records. Probably there were a million such audiences with from one to a thousand persons in an audience. But in radio broadcasting the broadcasters do the selecting of the sound producers and probably two hundred audiences containing from fifty to a million persons in an audience, do the listening.

One common idea seems to be that sound is something definite, mathematically exact. People think an expert can combine a number of long and short and big and little sound waves before an audience and that every one in the audience will hear the same sound. That idea is wrong. An expert can produce one set of sound waves, but the audience will hear as many different sounds as there are different people in the audience. Each person may hear a sound, but that sound will be different

from what a different person hears. That is one reason why different people choose different types of music.

#### EVERYONE DOES NOT HEAR THE SAME SOUND THE SAME

**I**F YOU have a regenerative radio receiver, you can probably perform some interesting experiments in sound. Tune in some amateur who is sending with a tube transmitter, and vary the pitch of the whistle while different people are listening. You will probably find, especially if you have a vernier condenser, that no two of the listeners will lose the signal at the same high note. And when each one listens alone and adjusts for himself you may find that no two of them leave the dial on the same setting if they are asked to pick the note that sounds best to them. Those experiments are best made on weak signals. By using louder signals you can probably find that certain notes or certain degrees of loudness are painful to certain people and not to others.

The greatest differences in hearing will

probably be found when comparing high notes. And the quality of sound, particularly from the violin, is said to be due largely to high notes or harmonics. And if a listener does not hear those high notes there is no sound from them so far as that listener is concerned.

By experimenting with the whistle from the radio receiver it may be found that some people soon learn to hear notes that they failed to hear at first. When head sets were first used in the early days to receive radio signals people said they could not hear plainly audible spark signals in the head sets. In 1902 it was difficult to get telegraph operators to operate wireless stations. Many wire telegraph operators said they did not hear the buzzing sounds. After they heard them, nearly all would say they could not learn to read long and short buzzes, although they were expert at reading the long and short intervals between the closing and opening of a sounder. The trouble was that these men never had heard such signals before and therefore their mental machinery was not regulated to hear them or to translate them or even to try to translate them. People may not hear sounds until after they are convinced that other people are hearing them or liking them.

Decisions as to what are good and bad sounds vary in so many ways. They vary with time and vary from the ridiculous to the sublime. When I was a boy, the boys and girls sang, "After The Ball." Now the boys and girls sing, "Yes, We Have No Bananas." Not long ago somebody put a rifle bullet through an automatic phonograph that was playing the latter song at the entrance to a Seattle music store. And recently, when I stopped for a day and night in an Indian Reservation, I did not hear a tom-tom or an Indian song, but I did visit a radio broadcasting station that was playing up-to-date popular music and classical music.

A dictionary says sound is "the sensation produced through the organs of hearing." Or in other words, sound is "a mental impression." From the foregoing and the variety of remarks different people make about the same piece of music, leads to the conclusion

that sound is largely a matter of personal opinion.

Considering those things causes one to sympathize with the listeners and the broadcasters and the makers and dispensers of radio equipment.

#### PITY THE BROADCASTER

**P**ITY the broadcaster, for how is he going to guess what his hearers want? He has but one personal opinion which is different from every other personal opinion that he broadcasts to. Evidently almost any broadcast will please somebody and no one broadcast will please everybody.

What the broadcaster needs is the opinions of everybody else. And he has to forget his own opinion, even though he has a high opinion of his own opinion.

In spite of more than one hundred million different personal opinions, we manage to elect one president.

And with many different personal opinions in one state or city we manage to elect one governor or one mayor. By the election process, many antagonistic personal opinions are molded into one more or less universal opinion or agreement.

#### ADD YOUR PREFERENCE VOTE

**E**VERYBODY can agree that the broadcaster wants to broadcast what the listener wants to hear. And we can agree that the broadcaster cannot know what the listener likes and dislikes if the listener does not tell him directly or indirectly. But indirect methods are slow. The direct method is to write letters to the broadcaster. If we tell him face to face or over the telephone he may forget it. And he isn't a mind reader. Plain, clear, direct communication is his specialty.

If the listeners vote for the kind of broadcasts they want by writing to the broadcasters, they probably will, in time, elect international sounds including international speech and international music, which can bring about international understanding.

Radio broadcasting is not for communication from one person to one other person or for the communion of a clan; it is for the communion of the human race.

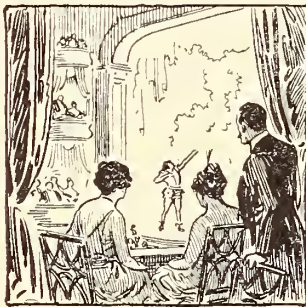

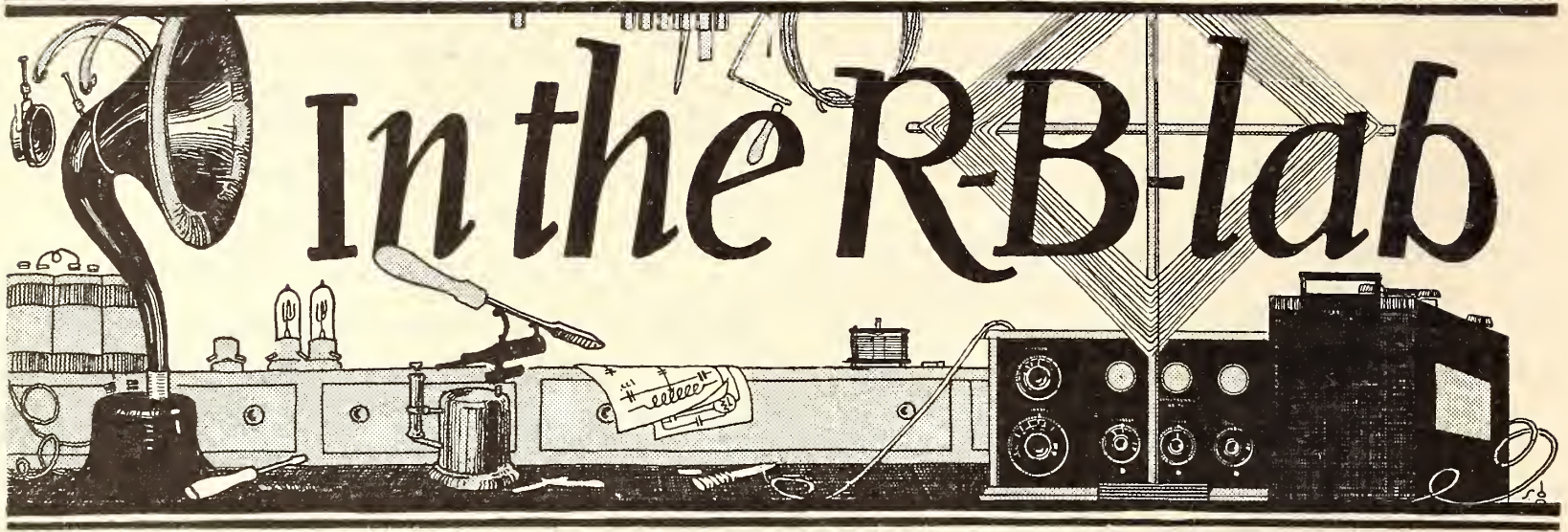

The "lab" department has been inaugurated by RADIO BROADCAST in order that its readers may benefit from the many experiments which are necessarily carried on by the makers of this magazine in their endeavor to publish only "fact articles" backed by their personal observations.

## ADDING R. F. TO A STANDARD THREE CIRCUIT SET

(Data by Russell Sheehy, Who Won His Receiver During Our Last Year's "How Far Have You Heard" Contest)

**A**S A general rule, the addition of radio frequency amplification to a standard regenerative set is not to be advised. These additions complicate the circuit and tuning to such an extent that commercial radio frequency amplifiers, built and sold as auxiliary equipment to standard receivers, have been rarely successful and have never acquired the popularity of circuits and sets especially designed for R. F. amplification. Mr. Russell Sheehy, however, has built a set which, according to the claims of its designer and our own observations, eliminates most of the draw-backs associated with apparatus of this type.

The circuit as shown in Fig. 3 is the result of several months of experimentation on the part of Mr. Sheehy, and the various refinements, such as condensers  $C_2$  and  $C_4$ , and the two potentiometers, are perhaps directly responsible for the excellent results, combined with stability, which Mr. Sheehy is experiencing. These additions, incidentally, are complicated only at first sight. They are stabilizing ele-

ments, having little effect on wavelength variation, and once set they need seldom be re-adjusted.

The three stage radio frequency amplifier, as indicated diagrammatically, may be added to

any three-coil honeycomb receiver, or to a vario-coupler, twin variometer set, such as the Grebe CR 8 with which Mr. Sheehy conducted his experiments. In the case of the honeycomb receiver, P and S indicate respectively the primary and secondary coils; and with the

variometer regenerator, the primary and secondary of the vario-coupler. When this addition of R. F. is effected in conjunction with the Grebe receiver, such as the CR's 3 and 8, the connection between the lower side of the secondary and the ground must be broken.

Figs. 1 and 2 show the combination built by Mr. Sheehy. The necessary parts for this addition are given below, the letters in parenthesis indicating the symbols by which the respective parts are represented on the diagram.

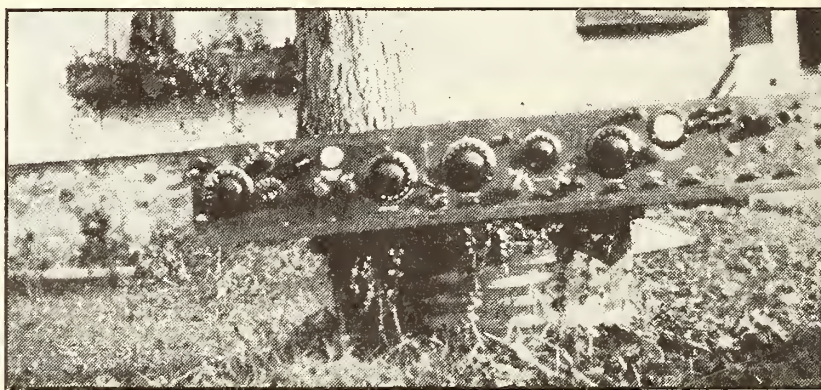

FIG. 1

Front view of the radio amplifier plus a Grebe CR8

THE PARTS

ONE tapped coil, 80 turns of No. 22 wire, wound on a 4-inch tube, tapped at turns number 20, 35, 50, 65 and 80 (L).

One switch arm with five points for coil L.

Three sockets.

Two Acme R.F. transformers, an R2 (T<sub>1</sub>) and an R3 (T<sub>2</sub>).

(Two vario-transformers could also be used to good advantage here, thus permitting each stage of R.F. to be tuned).

Two variable condensers, .0005 mfd. (C<sub>1</sub>) and .001 mfd. (C<sub>4</sub>).

Two Dubilier Micadons .0005 mfd. (C<sub>2</sub> and C<sub>3</sub>).

Two 400-ohm potentiometers (R and R).

Three rheostats (of proper resistance for tubes used).

Two dials for variable condensers.

Eight binding posts.

One 7 x 18 inch panel.

These parts can be bought on the average market at a price in the neighborhood

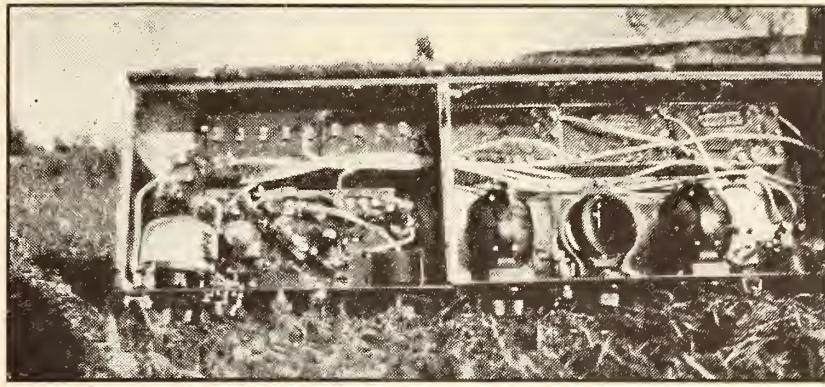

FIG. 2

Behind the scenes of the three step radio frequency amplifier

of twenty-five dollars.

As indicated in Fig. 3, Mr. [Sheehy has used for R.F. amplifying, in the sockets from left to right, a 201A, UV199, and UV199. Satisfactory results, however, should be secured by using the same tubes throughout—UV199s, 201A's, etc.

The R. B. Laboratory has found the old UV201's remarkably stable in amplifiers of this type—more so than the UV201A. The difference, however, does not justify the high current consumption when battery charging presents any sort of a problem.

In the preliminary tuning of this circuit, it is suggested that the experimenter place his usual tuning dials, those in the detector circuit, at such positions as would ordinarily tune in a station known to be transmitting at that time. Adjustments should then be made on condenser C<sub>1</sub> and the tapped coil L until this station is heard. It will be comparatively easy to pursue more elusive stations from this point. It might be mentioned, as a local station is likely to be the subject of the preliminary

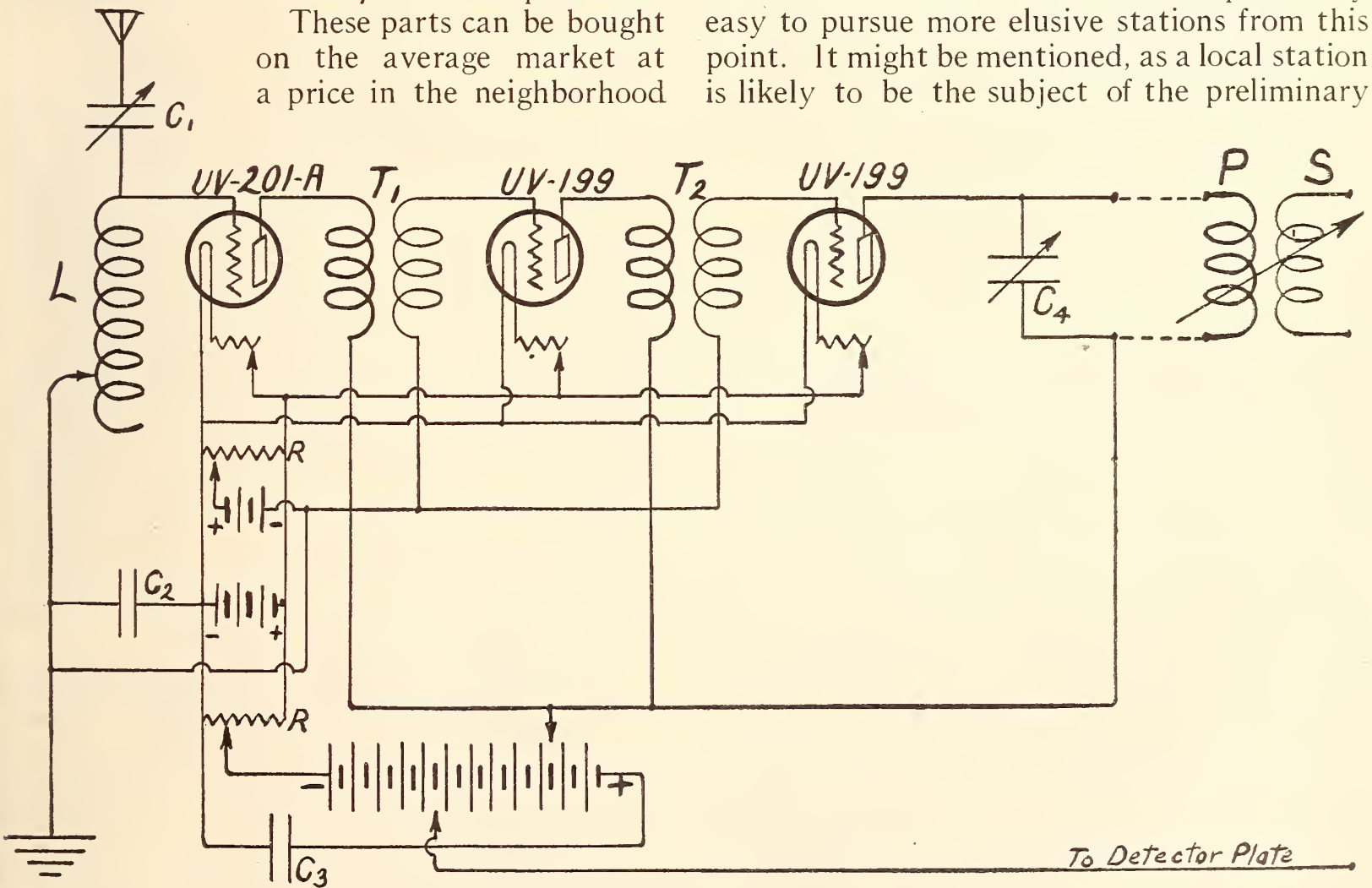

FIG. 3

The circuit for the three stage radio frequency amplifier that can be added to any inductively coupled receiver

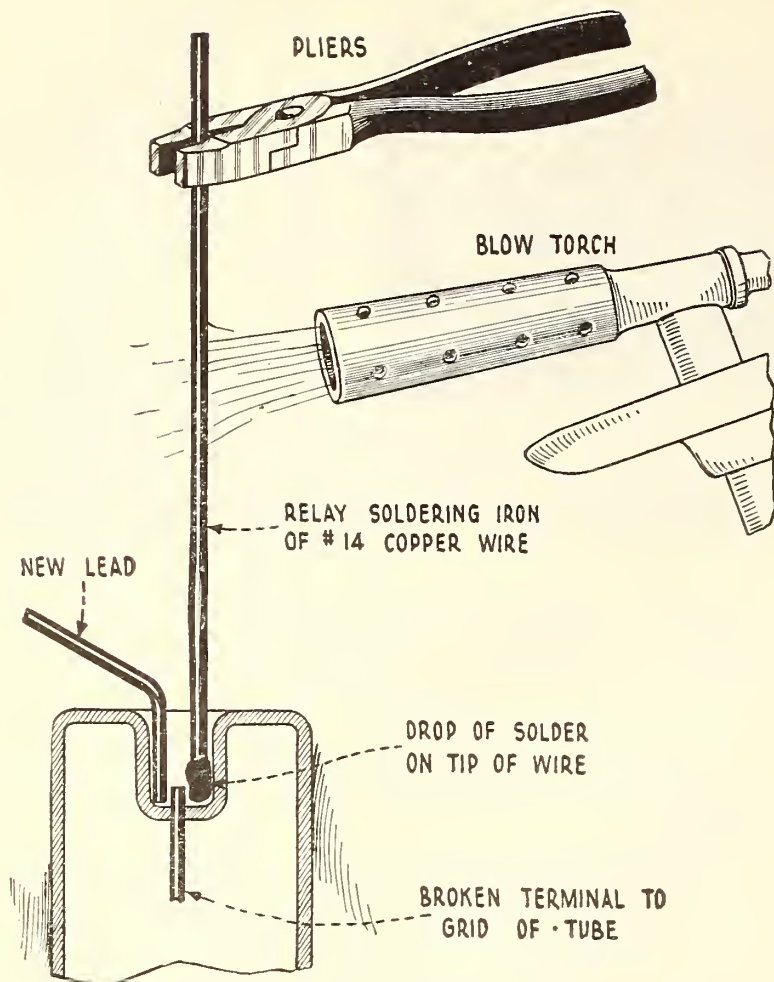

FIG. 4

A handy way of doing delicate soldering

tuning, that little or no amplification will be obtained on signals from near by stations.

The experimenter may, of course, eliminate one stage of R.F., merely adding two stages to his present regenerative equipment. Less than two stages of transformer coupled radio frequency, however, will not be very effective.

### A "RELAY" SOLDERING IRON FOR FINE WORK

By H. A. HIGHSTONE

SOME time ago we were confronted with the problem of soldering a lead to the grid terminal of an old Audiotron vacuum tube, the wire having broken off close to the glass. The Audiotron is cylindrical and the wires enter the glass at each end at the bottom of a depression which is but one quarter of an inch in diameter and a full half inch deep. From this you will comprehend that the task appeared to be almost impossible without resorting to the use of jeweler's tools. A happy inspiration however, saved the tube from the junk heap and the same method will doubtless solve a great many knotty problems which arise in the construction of home-made receiving equipment—especially when it is designed with an eye toward compactness.

A piece of No. 14 bare copper wire about six inches in length was tinned on one end (that is, it was covered with a liberal coating of solder) and a drop of solder left on the tip. The small piece of wire protruding from the glass having been previously scraped bright, a piece of No. 24 wire, also brightened, was placed next to it within the depression. The remaining portion of this last was wrapped around the outside of the tube to hold the end in position against the terminal. A very small amount of non-corrosive soldering paste was applied. Next, grasping the No. 14 wire with a pair of pliers, the tinned end was inserted in the opening and held to the two wires to be soldered. A flame from a small blow torch was then played upon the central portion of this improvised soldering iron (Fig. 4). The heat travelled along the wire and almost instantly fused the drop of solder at its tinned tip, firmly fastening the broken terminal to its new lead.

While this idea will probably find but little use for work on the fast disappearing Audiotron, it can doubtless be employed to great advantage in other parts of the receiving set, where the normal-sized soldering iron is too bulky.

### THE SINGLE CIRCUIT SET AND THE SODION TUBE

THE radio world is at last becoming aware of the selfish evils of regenerative receivers, particularly single circuit ones, which set up powerful outward radiations and often make reception from near by stations impossible. And, unfortunately, the single circuit set was the most practical receiver in the pioneer days of broadcasting. Because of its simplicity, it has worked its insidious way into the majority of radio homes. Realizing the evils attending the indiscriminate use of such receivers, RADIO BROADCAST has been campaigning for efficient substitutes and recently offered the radio public its "Knockout" one tube reflex. Non-oscillating, efficient reception is also achieved in the Sodian tube, which, for this reason, has been dubbed the "Golden rule tube."

By the use of this tube, the most malignant of the single circuits, that utilizing a variocoupler whose secondary functions as a tickler, may be converted into an equally efficient and a far more considerate receiver. The revised circuit is shown in Fig. 5. In Fig. 6 we have indicated the original regenerating set. The primary circuit survives unaltered, while the



tickler coil is returned to its normal functioning as the secondary.

Due to electrical characteristics of the Sodion tube, notably its low input impedance, the output of the tuning circuit should consist of relatively few turns of wire as compared with the usual high inductance secondary common to the conventional audion detecting circuit. Therefore, instead of loading the secondary circuit with the usual variometer, a high capacity variable condenser  $C_2$  is shunted across the coil.  $C_2$  should preferably have a maximum capacity between .0015 mfd. and .002 mfd. If more convenient, a lower capacity variable condenser such as a 43-plate type may be shunted with a .0005 mfd. fixed capacity.

The Sodion tube is best lighted from a four and a half volt battery through a ten ohm rheostat; it consumes slightly less than one quarter of an ampere.

The potentiometer,  $R$  may be of standard design, having a resistance between 200 and 300 ohms. A single twenty-two and a half volt  $B$  battery is about right for the best detection.

The terminals of the Sodion tube are as follows:  $C$  is the collector, which is analogous to the grid,  $F$  the filament, and  $P$  the plate

LEAVES FROM AN OLD TIMER'S NOTEBOOK

**D**RILLING large round holes: The obvious solution to the cutting of large round holes in panel materials, for ammeters, tube peeps, etc., is the drilling of circular series of small holes, and cutting out the disk. This last operation however, presents somewhat of a problem in itself, it being often difficult to join the holes without splitting the panel.

Try this: First drill the circle of holes, close, but not uncomfortably close together, with a

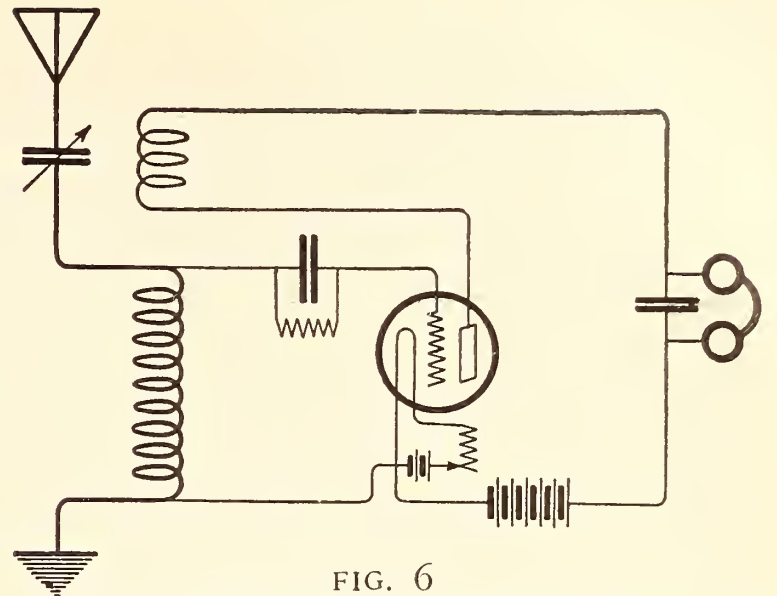

FIG. 6

A so-called single circuit receiver employing a tickler or feed-back coil for regeneration. Note that in Fig. 5  $S$  has been moved over to its rightful place as secondary. This circuit can easily be changed, then, to operate with a Sodion tube

No. 27 drill (passing a No. 6 screw). Then drill out with a larger drill, say No 19 (passing a No. 8 screw). If the spacing of the smaller holes has been rightly judged, the second drilling will widen them sufficiently to cut the disk out cleanly.

BUILDING YOUR OWN LABORATORY

**R**ADIO BROADCAST'S suggestion for March is a pair of tinner's snips, such as illustrated in Fig. 7. The very highest grade should be bought (this holds for all tools) and a medium size tool, about nine inches, will cost between two and three dollars.

They are indispensable for any heavy shearing work, such as the cutting and trim-

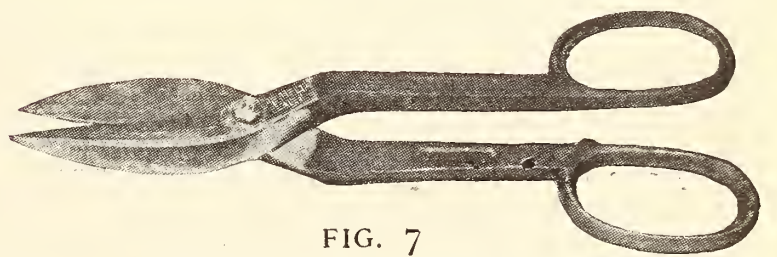

FIG. 7

Tinner's snips for this month's addition to the budding laboratory

ming of metal sheeting for panel shielding and the cutting of sheet iron into strips for transformer core construction. The uses to which these snips may be put are many, like that of most good tools, and will suggest themselves to the prudent possessor from time to time.

If you already have a pair of snips—good. Conserve your financial resources until next month when we plan to suggest a rather expensive purchase.

FIG. 5  
A circuit for the Sodion tube

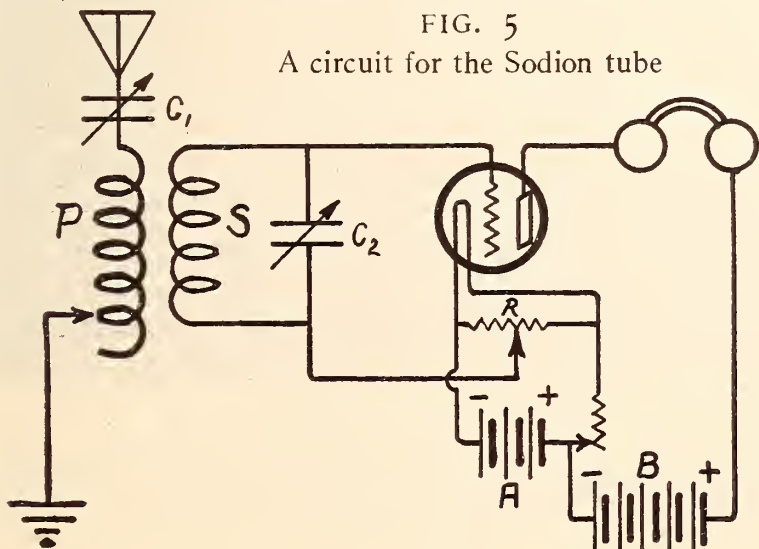

# Taking Ohms Out of an Antenna

A Description of Some of the Experiments Being Conducted  
by the Radio Frequency Laboratories to Improve Reception

By Dr. L. M. HULL

**T**O MANY an enthusiast in the alluring art of radio reception the antenna is a casual and frequently inconvenient appendage to the main body of his equipment; he feels that in a perfectly evolved mechanism it should be cast off altogether, like the tadpole's tail. This view may be justified, but the process of evolution in radio is still far from perfect. With most receiving equipment which is now commercially available, the antenna still assumes strategic importance in our endeavors to capture itinerant harmonies from Havana, Los Angeles, or 2LO. It is true that the enterprising vendor of radio contrivances may even now guarantee to give us "one thousand miles of clear reception for eighteen dollars" without specifying where, how, or what kind of an antenna is required to accomplish this marvel. But he cannot do this and retain any lingering atavistic sentiment for the eighth commandment. For the receiving antenna, comprising a ground connection and a more or less aerial portion, always serves as the most important collector of electrical energy from passing radio waves, whereby our receiver is given voice in direct proportion to the care and honesty with which this collector is built.

## WHY WE NEGLECT OUR ANTENNAS

**T**HIS simple fact, so apparent in the days when Marconi first irritated the ether with raucous sparks, has been somewhat obscured in later years by the tremendous increase in the extent and efficiency of our amplifying apparatus. Large solenoids ("loops"), water pipes, and even the tuning coils in our receivers are affected in minute quantities by passing electrical disturbances, which may be made perceptible by sufficient amplification. When our receiver yields beautiful results with a small loop or a wire laid carelessly about the picture moulding we are apt to lose sight of the fact that it would certainly outdo itself on the same incoming signals if fed by an outside antenna intelligently conceived and located. The ten-

dency toward simple but inefficient collecting structures is natural; we prefer to slight that portion of our equipment which is invariably large and occasionally unsightly if we can compensate for this neglect by buying things in convenient little boxes. But the time is not yet here for forgetting utterly the factors which tend to produce an electrically efficient collector of radio energy. For this reason some general interest may properly be attached to the details of a special low-resistance antenna system which this Laboratory has had occasion to construct for purposes of experiment and comparison.

## WHEREIN ANTENNAS DIFFER

**M**EASUREMENTS of signal intensity and practical tests of receiving apparatus have hitherto been made at this Laboratory with a 4-wire flat-top aerial, 75 feet long and 40 feet high, and a counterpoise of rather limited extent. A photograph of this aerial is shown in Fig. 1. It is directly over a steel-framed building for most of its length, and runs between a wooden mast and a tree. The lead-in is brought through the roof of the building in a composition insulator. This antenna system is believed to correspond in electrical efficiency to the average radio amateur's antenna and for purposes of comparison it was desirable to construct an aerial system which would approach the ideal design in small antennas as closely as can be done on dry land. A photograph of the completed structure which approximates this ideal is shown in Fig. 2. Before describing the details of this special antenna system let us consider briefly the factors which distinguish a good antenna from one which is electrically bad.

A simple antenna system operated, as is commonly done in radio broadcast reception, at wavelengths considerably above its fundamental, can with fair accuracy be regarded as a two-plate condenser; the aerial portion constitutes one plate, which is connected by a "down-lead" through the tuning apparatus

to the second plate which is the earth. There are two prime factors which determine the efficiency of such a structure as a collector of energy from incoming waves. The first is its electrical resistance and the second is its effective height. The second factor, the effective height, was of relatively little importance in the experiments for which this antenna was constructed, because there is no definite maximum of performance which can be attained by varying the effective height, other things being constant. This effective height is the distance between two mythical points called the centers of capacity of the system and in general varies directly as the actual distance of the top of the aerial above ground. The sky is literally the limit to the effective height, and in the special antenna in question the height was fixed at a point considerably above all near by structures, but calculated to keep the antenna resistance low, with the available materials.

Any practical antenna shares the common

failing of all condensers; it possesses not only electrical capacity but electrical resistance. This resistance is the first and usually the most important of the factors which determine the electrical efficiency. The antenna capacity offers no obstruction to the flow of currents induced in the antenna by incoming waves because it is balanced by a suitable inductance inserted in the down-lead. The adjustment of this inductance to compensate the capacity of the system constitutes the familiar process of tuning the antenna to resonance with the wave of the desired signal. But the resistance of this two-plate condenser remains in the receiving circuit after the antenna is tuned to resonance and opposes the ultimate limit on the amount of oscillating current which an incoming wave train can set up in the antenna, and hence upon the ultimate volume of sound in the received signal.

It should be remarked, in passing, that the oft-repeated saying that it is possible *entirely*



FIG. I

Although Dr. Hull tells us that we may consider the antenna in this photograph as an average one, we can hardly agree. Inspection discloses it to be considerably better than the average. It is as poor as one who is as familiar with the good things in radio as is Dr. Hull could tolerate

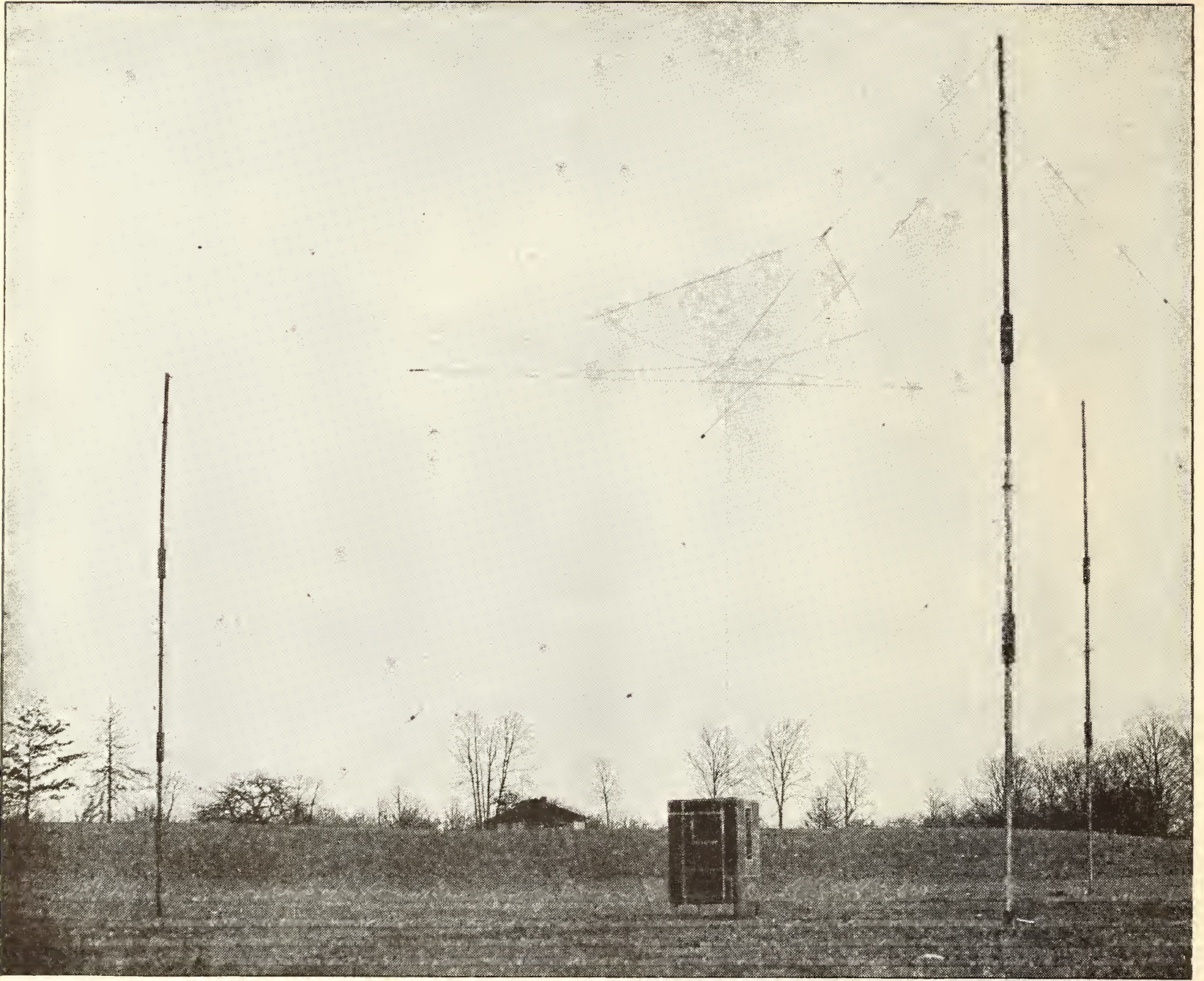

FIG. 2

This shows Dr. Hull's attempt to produce an ideal antenna. There are 3 masts 60 feet high supporting a phosphor bronze equilateral triangle 50 feet on a side crossed by 3 medians. A counterpoise of 6 wires 50 feet in length, each soldered to the copper shell of the receiving station pass out radially and act as the ground. There are two circular connectors around the counterpoise having 30 and 50 foot radii, respectively. The counterpoise is two feet above ground. The lead-in is a single phosphor bronze cable. *All the joints are well soldered*

to offset the effective resistance of an antenna by the use of regeneration in a detector or amplifier tube is fallacious. It is true that the received current in a high-resistance antenna can be increased by regeneration to an immensely greater multiple of its original value than the current in a similar low-resistance antenna with respect to its original value. But the "original value" in the low-resistance antenna is inevitably so much larger than that in the antenna of higher resistance that the net result is always a larger current in the former system, from the same incoming wave. There is a definite functional relation between the maximum received current which it is possible to obtain by regeneration (without local sus-

tained oscillations) and the resistance of the receiving circuit; this relation is practically the same for all types of regenerative circuits. It is of such nature that this maximum of current increases continuously with decreasing resistance. In all non-regenerative receivers, of course, the received current at resonance increases in exact inverse proportion to the circuit resistance.

#### LOW RESISTANCE MEANS BETTER RECEPTION

**A**LL this can be summarized in the following simple statement; the lower the resistance of the antenna the greater the signal intensity obtainable in any receiving set from a given incoming wave. The differences are not

always large; they may be imperceptible with a double-circuit tuner having a low-resistance secondary. But they always exist, and the antenna characteristic which is of greatest importance in connection with investigations of radio receivers is the antenna resistance.

This resistance of the condenser which comprises the aerial and ground arises from three main causes; loss by re-radiation, conduction losses in the wires of aerial and in the ground, and losses in any dielectric other than air in the electric field between the condenser plates. The first factor is fixed by the height of the antenna and is then irreducible. The second can easily be made negligible in the down-lead and in the elevated portion; in the ground, however, it is a different matter. Volumes have been written on the reduction of ground resistance. Most soil, if not too dry or rocky,

is a fair conductor of electricity. Its conductivity increases rapidly with the moisture content. It is a general principle that concentrations of current in such a conductor tend to raise the effective resistance of the whole mass; the problem is therefore how to make connection from the tuning apparatus to the ground without producing points where such concentration can occur. The third factor, losses in imperfect dielectrics in the field, is the most difficult to combat and it frequently supplies most of the effective resistance of an antenna. A vast majority of dielectrics come under the classification "imperfect." Building materials, including window glass, stones, trees, and—alas—most synthetic or "composition" insulators, all dissipate electrical energy at a surprising rate when placed in the high frequency field under or near an antenna. This is



FIG. 3

Dr. Hull is operating a tube transmitter which is putting 2 amperes into the loop. One of his assistants is inside the copper-clad receiving station trying to pick up energy from the transmitter. This is done to test the effectiveness of copper-shielding



FIG. 4

This is the shielded receiving house in the process of construction. Nearly 300 pounds of copper sheeting .03 inch thick were used before the shielding was completed

the reason why a total resistance of 13 ohms at 400 meters wavelength is considered low for an antenna built, as many of them must be, directly over a building. The resistance of many a receiving antenna is much more than this figure.

#### OVERCOMING THE LOSSES

**I**N THE special antenna shown at Fig. 2 the aerial portion consists of an equilateral triangle 50 feet on a side, crossed by three medians, the whole being formed of stranded phosphor bronze wire soldered at all intersections. This is suspended 55 feet above the ground from wire cables carried by three wooden masts. The insulators between the cables and the antenna wires are of glazed porcelain, 12 inches long, the dielectric losses in porcelain being very low compared with all other insulators having a comparable tensile strength. The down-lead consists of a single phosphor bronze cable. There is no conductive connection with the ground; the aerial is "coupled" to the ground through a counterpoise consisting of six wires, 50 feet long, passing

out radially from the central point where the building is placed which houses the operator and all instruments. This counterpoise has two circular connectors around it, of 30 and 50 feet radius, and is suspended at the six outside points by 15-foot cables supported by iron stakes. The counterpoise is two feet above the ground and is insulated from its supports by 6-inch porcelain insulators. A more uniform distribution of currents is secured in this way than could be possible with any but the most extensive conductive grounding system.

#### THOROUGH SHIELDING IS USED

**T**HE instrument house deserves special attention in that the materials of which it is built are completely shielded from the field of the antenna. It is cubical in shape and is covered on all six sides by copper sheeting 0.03 inch thick; the windows are covered with heavy copper screen, and the copper-clad door is provided with flaps so that when it is closed its covering is in electrical contact at all points with the rest of the shield. All joints and seams are soldered fast, so that the copper shell

forms a high-grade electrical shield for the walls and the interior. The effectiveness of this shield in preventing external fields in reaching the interior with its accompanying dielectric losses has been tested by placing a loop transmitter carrying a current of 2 amperes at different wavelengths just outside the structure, and exploring the interior for electrical leakage with a coil connected to a sensitive receiver. With the door closed the electrical leakage into the interior is inappreciable. Fig. 3 is a close-up view of the transmitting loop used in these tests, with an operator doing his best to send electric waves through the copper-clad walls of the building.

Fig. 4 shows this shielded house in the process of construction. Nearly 360 pounds of copper were sealed over the exterior before it could be made proof against penetration by electric fields from the outside.

The shielded house is insulated from the ground by 4-inch glazed porcelain insulators mounted on iron pipes which protrude 18 inches above the ground. The counterpoise wires partly shown in Fig. 3, are all anchored to the walls and make electrical contact with the copper shell. This shell is thus an integral part of the counterpoise. The down-lead from the antenna is supported by a porcelain insulator and is brought through a small circular opening in the copper screen over one window. Through the same opening a connector from the counterpoise is brought in to the interior, parallel to the antenna lead-in. When measurements are made, this opening is allowed to gape, so that no dielectric but pure air lies in the relatively intense field between the antenna down-lead and the counterpoise up to the point of connection with an instrument inside. This precaution is particularly important since the highest difference of potential in the whole antenna system exists between these two conductors, and a solid dielectric interposed here exerts more influence upon the total effective resistance of the aerial than at any other point between aerial and counterpoise.

## THE SYSTEM AS A WHOLE

REGARDED as a whole we see that this antenna system consists of a flat elevated conductor and a second flat conductor directly over the ground, with a highly conducting cube of copper in its center. No electric fields can penetrate this copper cube, so we are at liberty to place any arbitrary dielectrics such as wooden frameworks, instruments, and a more or less conductive man in its interior without affecting the constants of the antenna. (This heterogeneous but useful combination of materials is shown in Fig. 5, which is a view of the interior of the house). The only solid dielectric in the main field between aerial and counterpoise is furnished by the porcelain insulators at the edges. The only solid dielectric in the field of the large series capacity existing between counterpoise and ground is the porcelain of the insulators upon which the shielded house rests. The bulk of these dielectrics is of course

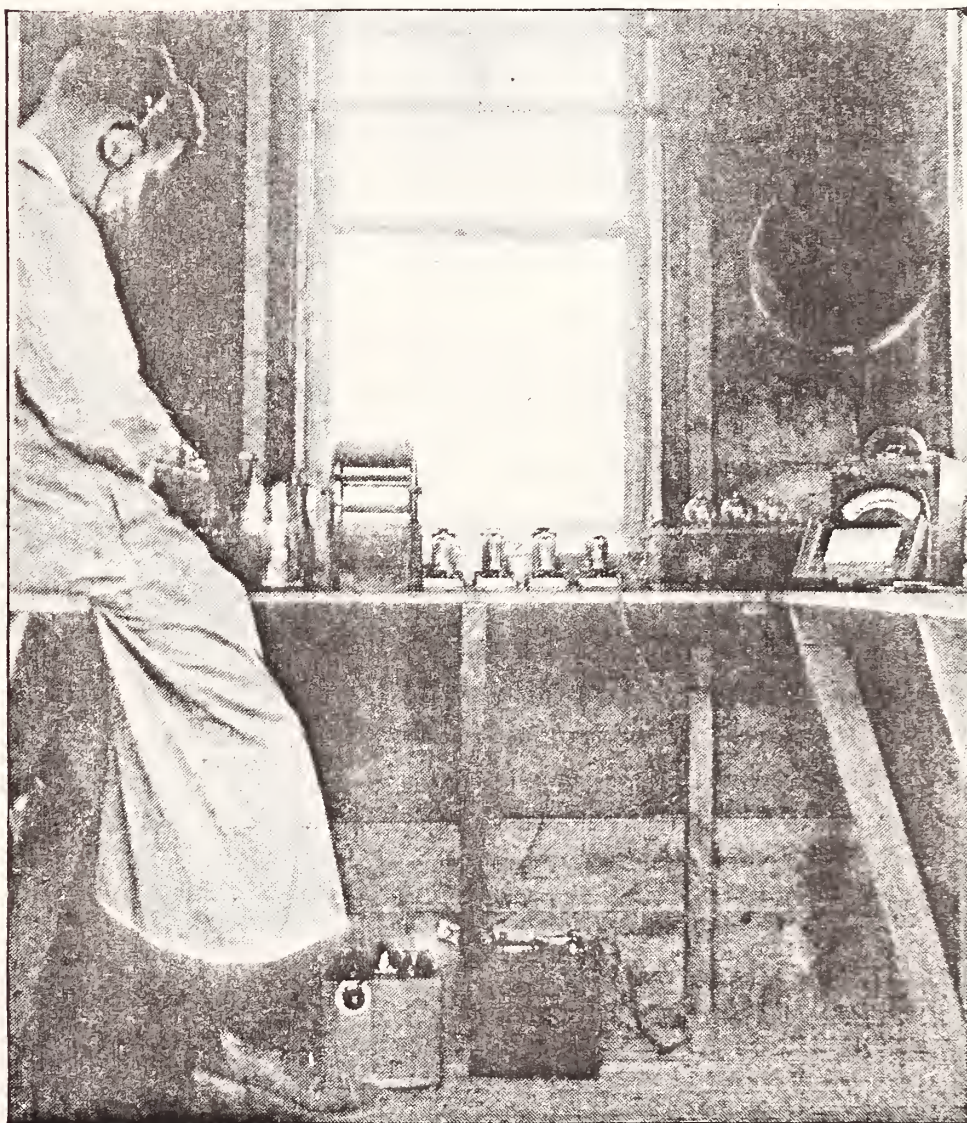

FIG. 5

Inside the ideal receiving station Dr. Hull uses three stages of tuned R. F., a tube detector and a two-stage power amplifier and loud speaker. He can make very accurate measurements of all kinds in this unique laboratory

very small compared with the whole volume of the electric field. The masts themselves are in the very edge of the electric field, but are separated as far from the aerial proper as is consistent with mechanical strength. Experience has shown that dry wood, painted, is no worse than metal towers from the standpoint of energy absorption.

The conductor resistance of the system, although small, could probably be reduced by a few tenths of an ohm by the use of a cage down-lead, which will be installed ultimately. The contribution of ground resistance to the total resistance is reduced by the use of the counterpoise instead of a direct ground connection. It is problematical whether a more extensive ground connection would produce less concentration of ground currents and hence lower the total resistance. An investigation of this point is being carried out at the present time.

The cumulative effect of all these structural refinements in producing a low effective resistance for the whole antenna system is shown graphically in Fig. 6. Here the upper curve, marked "Laboratory Antenna" is an experimental plot of the resistance of the "average" antenna which is pictured in Fig. 1. The resistance was measured at wavelengths between 200 and 800 meters. The rise in resistance at the short-wave end of the curve is due to radiation and is observed in all antennas at wavelengths approaching the fundamental or natural wavelength of the system. The

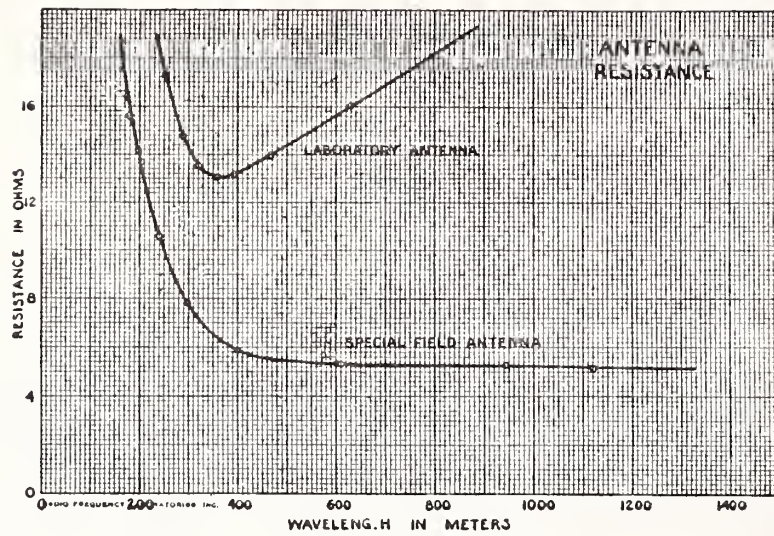

FIG. 6

Here is concrete evidence of the effect of using every effort to reduce antenna resistance to a minimum

rise in resistance above 400 meters is due almost wholly to absorption of energy by the building and other poor dielectrics under and near this antenna. The lower curve shows the resistance of the special antenna system as measured over a somewhat greater range of wavelengths by instruments entirely enclosed in the shielded operating shack. All

components of the resistance except the radiation resistance are conspicuously lower than the corresponding components for the other antenna. The minimum resistance is five ohms, corresponding to a minimum resistance of thirteen ohms in the other antenna. The important point, however, is that there is no increase whatever in the resistance at the longer wavelengths, indicating that in this particular operating range the effects of dielectrics in the antenna field have been reduced to insignificance. To the best of our knowledge the only short-wave simple tuned antennas (contrasted with multiple-tuned systems) in actual operation at the present time which show a lower resistance than this system are installed on board ships or in locations where a direct grounding system in salt water is possible. Criticisms or exceptions to this statement would be welcomed by the writer in the interest of further development.

The radiation resistance at 400 meters of the antenna under discussion is 3 ohms, which means that the actual conductor and ground losses are represented by only 2.5 ohms at this wavelength.





# Shooting Trouble in the Super

A Series of Concrete Remedies for Almost Any Ill a Super-Heterodyne May Develop During Construction or Operation

By A. J. HAYNES

Vice-Pres. Haynes-Griffin Radio Service Inc.

Since Mr. Haynes's article, describing a "Simplified Super-Heterodyne," appeared in the January issue of this magazine, both he and we have been literally swamped with mail in regard to this set, and, while attempts have been made to answer each of these letters personally (as far as possible) it has been impossible to do full justice to any of them. All of these letters may be divided into two distinct classes—they either contain praise for the circuit, expressing the writer's great satisfaction; or trouble inquiries from people who have not been able to obtain the expected results. Only a very few who have had trouble with one circuit have expressed doubt as to the merits of the set, and this, undoubtedly, can be attributed in a large measure to the confidence which the radio public has in the editorial policy of RADIO BROADCAST.

We believe that, during the last few months, Mr. Haynes has come in contact with almost every conceivable trouble that could be encountered in the super-heterodyne, and the following discourse on the adjustment of this receiver and the most common troubles encountered should be of assistance to any one building such a set. We can promise the radio enthusiast that, if this set is properly constructed and adjusted, it will be some time before he will wish to seek further for the ultimate receiving set; for quality of tone, selectivity, and distance the "super" reigns supreme.—THE EDITOR.

## WIRING

**D**ESPITE the many photographs and diagrams accompanying my article on the "Simplified Super-Heterodyne," published in RADIO BROADCAST for January, there have been many people who found difficulty in wiring the set properly. This was due in a large measure to their inability to combine the lay-out, as given, with the wiring diagram. For this reason, this article is accompanied by a diagrammatic view of the individual pieces of the apparatus used in this set, with their actual connections. This should entirely eliminate trouble of the foregoing nature.

It is advisable that no more spaghetti be used than is absolutely necessary; and, while *all* leads should be kept as short and direct as possible, this is particularly true in connection with the grid and plate leads from the radio frequency transformers.

## TESTING THE SET

### THE INTERMEDIATE FREQUENCY AMPLIFIER

**N**OW, let us suppose that we have the complete super-heterodyne assembled and wired and, supposedly, ready for operation. Let us start by testing the intermediate frequency amplifier. Snap on the filament switch and turn the filament rheostat on until the tubes assume approximately their normal

brilliancy. In the case of 201-A tubes, when a 6-ohm rheostat is used, this will be practically all the way around on the rheostat; but, if a low resistance power rheostat is used, it should be approximately three quarters on. Next, note the polarity of the potentiometer connections, and move the arm on the potentiometer completely over to that side which is connected to the positive A battery line. Plug the receivers into the detector jack and proceed as follows:

Move the potentiometer arm gradually around toward the negative end. At approximately half way around, the amplifier should go into oscillation with a slight "hiss" or "click." If a grating sound is heard in the phones as the potentiometer is varied, the potentiometer winding should be cleaned with a piece of fine sand-paper. The normal operation point of the amplifier is at the position just before the amplifier goes into oscillation, which is found by having the potentiometer arm just on the positive side of the click. If no "click" is heard and the wiring checks out O. K., look for trouble first in the potentiometer itself, making sure that there is an electrical connection between all three posts of the potentiometer, regardless of where the arm is placed. This may be tested with a pair of phones and battery in series, after disconnecting the potentiometer. If the trouble does not lie here, test out the trans-

formers by the same method. When phones and battery are connected across either the primary or secondary windings, a distinct sharp click should be heard—both when this connection is made and when broken.

Assuming that the amplifier is satisfactory, move the potentiometer arm just beyond the point of oscillation, toward the negative side. Now, the entire amplifier is oscillating, and, whenever the grid connection of any of the three radio frequency transformers is touched there should be a distinct thud as the finger touches and leaves the post.

#### THE OSCILLATOR

LEAVING the amplifier oscillating, test out the oscillator in the following manner:

Place the rotor of the oscillation coupler almost all the way in; that is, so that the windings of the stator and rotor are nearly parallel. Now, vary the oscillator condenser (at left of panel) slowly over the entire scale. If the oscillator is working properly—that is if it is oscillating—a succession of whistles or heterodyne notes should be heard in the

phones as this condenser is varied. If this is not the case and the oscillator wiring checks out correctly, the trouble can usually be found in the coupler itself. On the stator of this coupler there are two windings—one in the plate and one in the grid circuit. This means that there are four leads that are brought from this stator. If one of these leads, where it leaves the tube, has rubbed against the preceding turn of wire so as to short-circuit with it, it will prevent the oscillator from functioning. If this is the case, it will be well to remove one turn of wire from this end of this particular coil, bringing it back through the coil, as previously. In fact, there is sufficient leeway left in the coupler to remove one turn from each end of each of the two coils, if necessary, without reducing the wavelength range to any extent. *This is the most common cause of trouble I have yet found.* If, after convincing yourself that the coupler wiring is satisfactory, and it still does not oscillate, try varying the B battery potentials; also check up the B battery voltage and try turning the tube filaments a bit higher, to make sure that they are at the proper operating point.

With so many tubes controlled from a single rheostat, there will be no danger in burning out the filaments or injuring the tubes—even if they are turned all the way on for a short time.

Now, supposing you have both the oscillator and intermediate wave amplifier operating properly, turn back the potentiometer arm toward the positive side until the amplifier stops oscillating, and the set should be ready to receive signals.

#### OTHER SOURCES OF TROUBLE

THERE are several troubles that are sometimes encountered, even after the amplifier and oscillator are performing properly. The most common of these is defective tubes. A bad tube should be suspected above all else, as it is the easiest test to make and occurs quite often. I do not mean by this that the tube is necessarily worthless; but its characteristics may be so different from the other tubes used in the circuit that it will not operate satisfactorily with them. And, again, a tube which

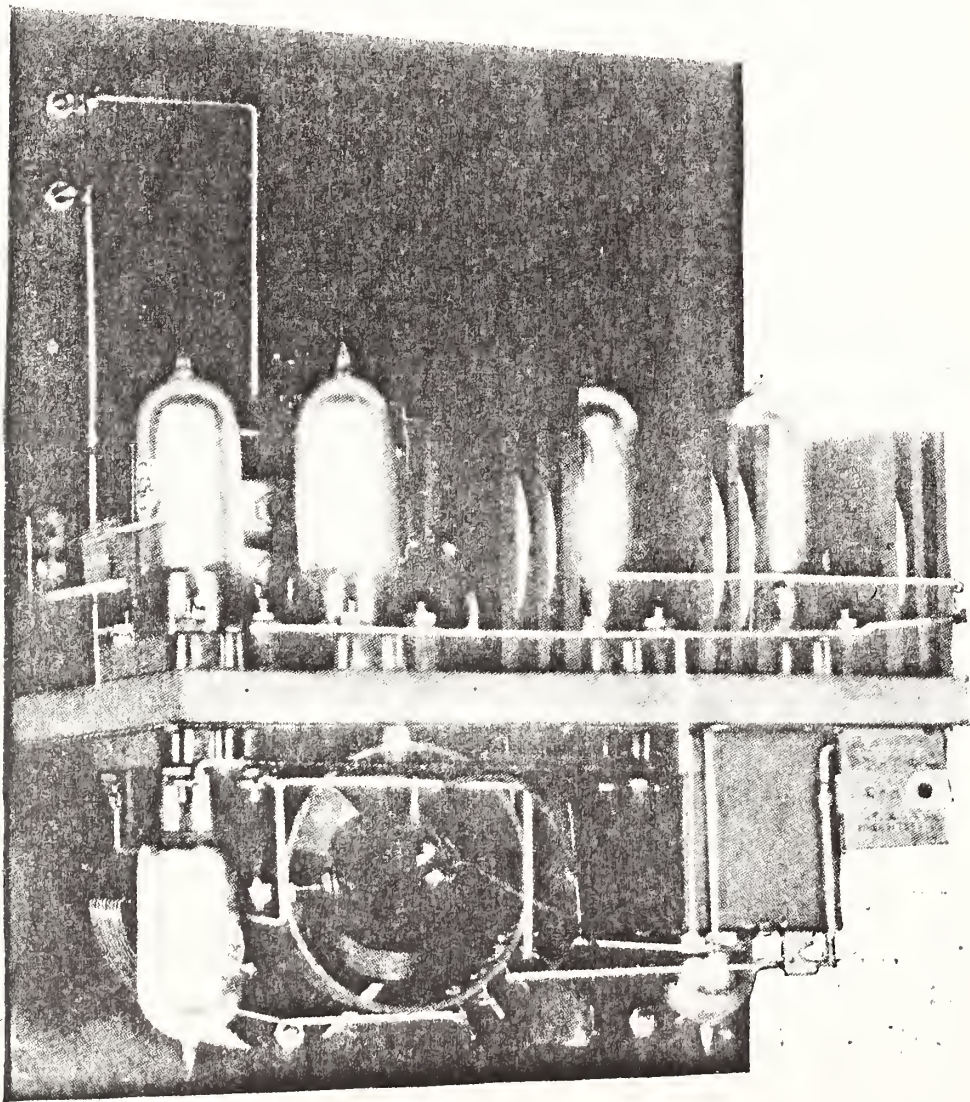

THIS IS THE REAR VIEW

Of the portable "super" built by Mr. Silver. It is an electrical masterpiece but is not recommended for general construction

might operate quite satisfactorily as an audio frequency amplifier or detector, might not work properly as an oscillator. Therefore, do not neglect to change tubes when hunting trouble in either the amplifier or the oscillator; and also, after the set is operating, change the tubes around until the best possible combination is found. One or two spare tubes are very valuable assets for this purpose.

A not infrequent source of trouble is found in the grid condensers and leaks, as either of these is liable to be defective or open-circuited, and occasionally, in the case of the condensers, short-circuited. As to the matter of grid leaks, there are so few reliable ones available on the market to-day that it is hard to give definite instructions regarding them. However, I recommend that good fixed leaks be used, and, as a general rule, it will be found that a value of about one megohm is satisfactory for both detector tubes—although sometimes for weak signals a higher value of leak may be used to good advantage. Do not omit the by-pass condenser from the plate to the negative filament on the last detector tube

—otherwise, the set will be unstable and hand capacity will be noticeable. If the set is operating properly, there should be absolutely no body capacity whatever, even with an entire absence of shielding.

If the set does not tune sharply, or a poor

volume is obtained, it can usually be traced to the .0005 fixed condenser, across the input transformer primary. These small fixed condensers are bound to vary somewhat in capacity, and a *small* variation in the capacity here will have no effect on the operation of the set; but occasionally a condenser is obtained which is *so far off* as to seriously affect the operation of the circuit.

This can be checked absolutely by placing a .001 variable condenser temporarily across the first transformer input, and tuning the condenser until maximum volume is obtained. Then, replace the variable with the fixed condenser and note if there is a difference in volume or tuning qualities of the set. Many questions have arisen in regard to the two 0.5 mfd. by-pass condensers, specified for use across the B battery and potentiometer. As a matter of fact, any capacity of .005 or greater may be used, but I would strongly recommend that these condensers should be either 0.5 or larger.

#### TUNING THE SET

**I**N TUNING this receiver, there are practically only two controls that need be used, although

there are two secondary adjustments that are available. The two principal controls, in order of their importance are—the oscillator condenser on the left end of the panel, and the loop tuning condenser next to it. It will be found that the oscillator tuning condenser will

### We Have Been Accused

By some of our more experimentally inclined readers of having failed to give them the necessary details for the building of various components of some of the circuits we have described.

“Since RADIO BROADCAST has been of such tremendous service in bringing the super-heterodyne from behind the door and removing the bugaboos heretofore associated with it,” says one reader, “we are surprised to find that mention is made of transformers built by certain manufacturers and no directions given for making them ourselves.”

Our answer is this: We believe most of our readers would rather buy certain parts than attempt their actual construction. We must be guided by the desires of the majority. It is sometimes necessary to experiment for months, in an effort to produce a satisfactory substitute for the parts described. We cannot keep the majority from deriving the benefit of a circuit until we can secure the required information for the minority. We will not publish information of this nature until we know it is correct—and *frequently the fault is that we have anticipated the need by a few months* and the reader fails to look over issues of preceding months.

For instance, in the case of the letter referred to, our correspondent mentioned an article prepared for us by Mr. George Eltz, appearing in our November, 1923, number. He failed to observe that Paul Godley had told how to build a resistance coupled super-heterodyne in our February, 1923, number and the very substitutes he desired had been completely described in an article entitled “A Practical Super-Heterodyne with 199’s” by Walter Van B. Roberts in RADIO BROADCAST for August, 1923.

We are doing our best to give you the best, and most of the reader’s time and vexation can be saved by an occasional perusal of past issues.—THE EDITOR.

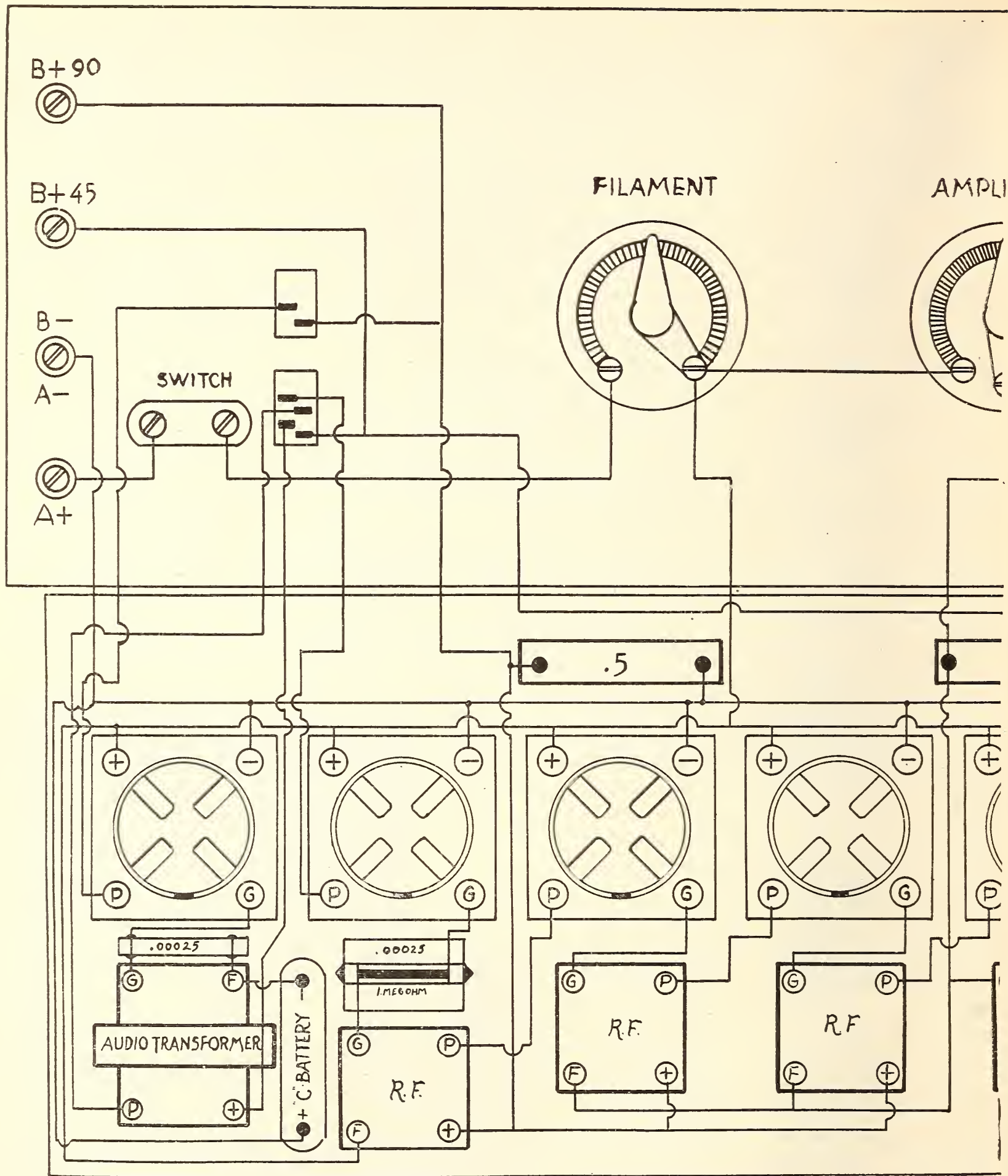

be much the sharper of the two in adjustment, although with a good loop its tuning condenser should tune fairly sharply. These two condensers must be varied more or less in unison, the general tuning practice being slowly to increase the oscillator control, or left-hand condenser, while the other condenser, which tunes the loop, is increased with it, or con-

THIS IS THE—  
 Of the seven tube super-heterodyne described—  
 be followed in detail and will reduce to a—  
 tinuously moved backward and forward over a small arc as the readings are gradually increased.  
 When the circuits controlled by the two condensers are in resonance, regardless of

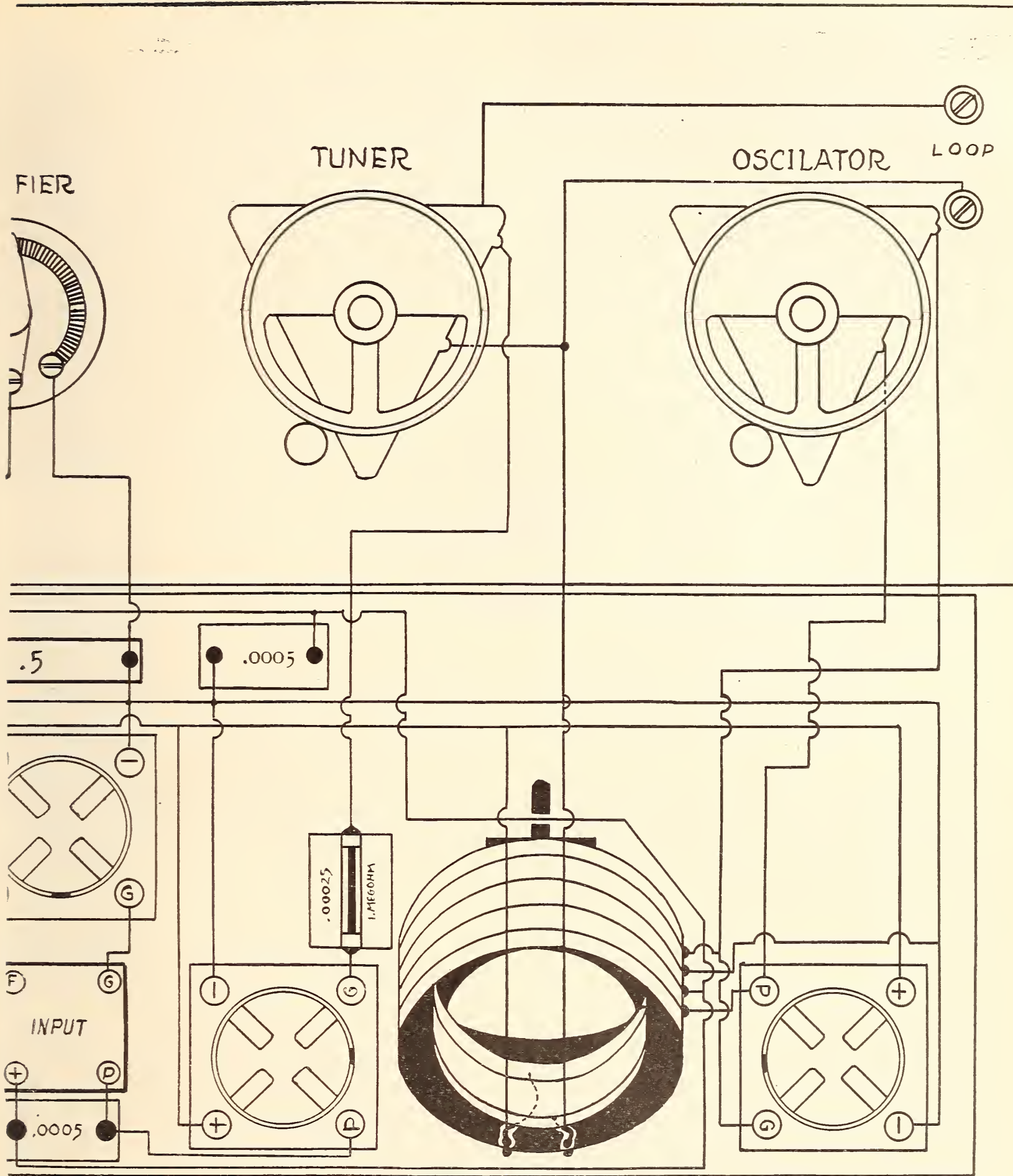

—DETAILED LAYOUT

—in RADIO BROADCAST for January. It may  
 —minimum the trouble encountered in assembly

whether or not they happen to be tuned to a signal, a certain amount of noise can usually be heard, particularly if there is any inductive interference in the neighborhood or if any static is present. It will be noted that, on a

low wavelength station, when both condensers are tuned to a station on the lower part of their dial settings, if the oscillator dial alone is increased to the upper part of its scale without moving the tuning dial, this station can be brought in again. This is due to the fact that the signal can be heterodyned with either the sum or the difference of the local and incoming

frequencies. However, this is more valuable than objectionable, due to the fact that the radio frequency transformers are designed for a comparatively high frequency, and these two points are so far apart that, by the time the upper point is reached on the oscillator condenser, the tuning condenser is so far from the fundamental wave of the station that, unless the signals are extremely powerful, they cannot get through. Just this, together with the fact that the higher the frequency range the sharper the tuning may be without a loss of quality, is the reason for employing this high intermediate amplifier frequency.

The secondary controls which were mentioned—or we might call them auxiliary controls—are the loop and potentiometer. The loop may be swung in different directions to receive with maximum efficiency from various stations, and this in itself is a great aid in eliminating interference, particularly that of spark stations. There is also the potentiometer adjustment, which controls the volume of the received signal. The further the potentiometer arm is moved toward the *positive* side, the *less* amplification is obtained, and *vice versa*, up to the point where the amplifier breaks into oscillation.

It will be noted that, after all other adjustments have been made, if the filament rheostat is touched, its controls will appear to be very critical. This is due to the fact that it reacts on the potentiometer control and that for every different filament adjustment a different potentiometer adjustment must be made if it is desired to maintain maximum amplification. On the other hand, the proper filament adjustment should be found and left for all time, and all adjusting done with the potentiometer. This filament adjustment should be as low as possible without sacrificing any amplification or quality. Do not lower the filament to the point where the set becomes unstable and the amplifier control becomes “sticky,” as we call it; that is, goes in and out of oscillation with a thud at different points on the potentiometer adjustment.

The potentiometer adjustment should not be materially affected by the tuning controls; that is, it may be adjusted for any degree of amplification and left without further adjustment, while the two condensers cover the entire wavelength range.

THERE is one statement I made in the last article which has caused quite a bit of comment. It was that I considered such a super-heterodyne as this easier to tune than a single circuit regenerative receiver, and I still maintain this to be the case. The reason is that this set has only two variable controls outside of the loop and potentiometer, which once adjusted may be left, and these two controls may be *calibrated absolutely and always remain the same*, providing the same tubes and loop are used. In fact, it is only necessary to calibrate one of the dials, and this should be the oscillator dial settings, in which case the set may be used with any loop; and, after adjusting the oscillator to the desired station according to the chart, it is only necessary to vary the loop condenser until the desired station is heard. In fact, as the oscillator consists of a fixed inductance and variable condenser (after the oscillator rotor is once adjusted) this circuit

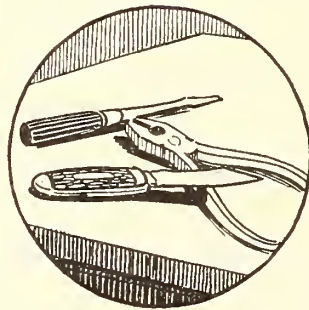

may be calibrated directly as a wavemeter, and a curve made on a sheet of graph paper with the wavelengths plotted against the oscillator dial settings. This particular set of dial readings and curve was made with one of these sets, using a General Radio .0005 geared vernier condenser, and, while these particular settings will vary somewhat with various condensers and oscillator couplers—even of the same type—they may be taken as approximations; and, if the oscillator dial is so set on its shaft as to correspond on any given station with the dial setting of this station on the accompanying chart, the remaining settings will be found to be very nearly correct.

In regard to the oscillator coupler rotor, this should be adjusted permanently before making any dial setting records. To do this, tune in a fairly weak signal and adjust the tuning condensers and potentiometer for maximum audibility. Now, make a small change in the position of the rotor. The effect of this change of position will be to throw the oscillator somewhat out of adjustment. Re-adjust the oscillator condenser and the potentiometer for maximum audibility again and continue this process with successive rotor settings until the setting for best signal strength is obtained. *Then leave the rotor alone.*

## THE PORTABLE SUPER

THE small portable set, mentioned in the previous article which appeared in the January issue of RADIO BROADCAST, has caused so much comment and I have received so many requests for further information on it, that I am giving, herewith, another photograph showing the back of panel of this set. However, as stated in the previous article, all of the equipment used was specially built for this set, and, except for such standard parts as rheostats, sockets, condensers, etc., the entire set was constructed from raw materials—that is, wire, hard rubber sheet, and machine screws. This, of course, is quite an undertaking and should not be attempted by any one who has not acquired a considerable amount of experience with this work.

## A CORRECTION

THE diagram given here varies in one respect from the original schematic diagram which appeared in the previous article. This is in regard to the oscillator coupler grid return which should connect, as shown here, to the common *negative* battery line. Due to an error, this was connected to the positive A battery lead in the previous diagram, and, while thus connected it will not in any way impair the operation of the set, it will cause a somewhat unnecessary consumption of B battery current.

## USING AN OUTSIDE ANTENNA

I HAVE received numerous requests for instructions for utilizing a straight antenna with this, or any other loop set. There are several ways of doing this, any one of which will work quite satisfactorily. Personally, I prefer to use the loop at all times and, if atmospheric conditions permit of the use of outside antenna, to couple this loosely to the loop by tuning it separately, this may be done by placing a DL-50 coil and .001 variable condenser in series with the antenna and ground; that is, the antenna should be attached to one end of the coil, the other end of the coil being connected to the fixed plates of the variable condenser, and the *movable variable condenser plates connected to the ground*. *Neither the antenna nor the ground is connected to the set proper*. Then, by



placing the honeycomb coil on the table beside the loop, or even by running the antenna lead-in past the loop within a few inches, sufficient coupling will be attained, when the antenna circuit is brought into resonance by tuning the variable condenser. However, I do not recommend that this apparatus be incorporated in the same cabinet with the set itself.

Another way of doing this is to run an extra single turn of wire around the loop, connecting the ends of this turn to the antenna and ground respectively, in which case no extra tuning apparatus is necessary. Again, a considerable increase in signal strength may be obtained by merely connecting the antenna to one of the loop terminals without the use of the ground, although this method is not advisable in congested localities where interference prevails. If it is desired, a small separate unit may be built consisting of a standard variocoupler; the secondary being connected in place of the loop to the two input posts at the left of the panel, and the primary being brought out to a series of taps, connected to the antenna and ground in the usual manner.

It will be found, however, in most cases, that an antenna is not necessary unless one wishes to do extremely long-distance work, or very loud signals from long-distance stations are desired; although there are some locations such as a large steel building, etc., where an antenna must be used for consistent long-distance reception.

## THE COMPARATIVE MERITS OF THE SUPER-HETERODYNE

THERE is one question that still seems to be unanswered in the minds of many radio enthusiasts, and this has been caused somewhat by recent extravagant claims made for certain circuits. In my opinion—and I feel sure that I am far from being alone in this respect—there is to-day no circuit within the limits of practical use which will give greater sensitiveness, or sharper tuning without sacrificing quality than the super-heterodyne.

For giving us this remarkable circuit, the radio world owes a debt to Major Armstrong, the real extent of which we are only beginning to appreciate.

# How Far Have You Heard?

## Announcing Radio Broadcast's Second Prize Distance Contest

**T**HIS year our contest is to be in two sections—one for home-made and the other for ready-made receivers.

Each year the automobile has its speed trials, which largely determine the desirability of certain designs and prove the inferiority of others. The Editors of RADIO BROADCAST believe that a similar race for radio receivers is not only interesting but serves the very useful purpose of proving the over-all effectiveness of one type of receiving equipment over others.

These are about the best radio receiving months of the year and it is possible to pick up stations over great distances. Consistent performance, during an entire month should result in many contestants piling up a very great score. Now is the time to prove the real worth of your receiver.

### THE PRIZES

**T**WO sets of prizes are offered. For the ready made sets some of the best sets which can be obtained will be given. For those winners who own home made sets, complete sets of parts for excellent receivers will be awarded as follows:

#### *Ready Made Sets*

FIRST PRIZE	Mu-Rad, Type MA-15
SECOND PRIZE	Neutrodyne, Fada 160
THIRD PRIZE	Sonochorde Loud Speaker, Type C

#### *Home Made Sets*

FIRST PRIZE	Complete set of parts for the Haynes super-heterodyne, described in January RADIO BROADCAST
SECOND PRIZE	Complete set of parts for a "Knock-Out 3-tube Set," described in February RADIO BROADCAST
THIRD PRIZE	Complete set of parts for "Knock-Out 3-tube Reflex Set" with the Sodian tube.

### NO "BLOOPERS" ALLOWED

**N**O REPORTS from owners of oscillating receivers will be considered, because attempts to receive over long distances with such outfits cause a great deal of annoyance to other receivers in the neighborhood and threaten to deal the entire radio broadcasting industry a severe blow. Some of the reasons for this decision are outlined in the article beginning on page 365, which, by the way will tell you whether or not *your* receiver is in the *pest* class.

### TESTS TO LAST A MONTH

**T**HE test period will begin at midnight February 19th and last until midnight March 20th. During this time it is but necessary for you to log your reception as follows:

<i>Date</i>	<i>Time</i>	<i>Call letters</i>	<i>DX</i>	<i>Remark</i>
-------------	-------------	---------------------	-----------	---------------

It is merely necessary to list the call letters *but hearing only the call letters is not sufficient*. The reception from any station listed should be clear for a period long enough to hear a complete musical selection, the call letters, and location of the station. If this cannot be done—do not list the station. The report of possible winners will be checked with the broadcasting station managers and an *optimistic guess* may lose the contest for you. Play the game!



Under remarks you should include the type of entertainment received during the time your log indicates and a note about the volume, quality and interference.

In listing your time be sure to mention whether it is Eastern, Central, Mountain, or Pacific. Under DX, give the distance from your receiving location to the broadcasting station listed. This distance may be measured on any standard map, but a very simple method of measuring is found in the Radio Scalometer and the map.

ADDING THE DX

AT MIDNIGHT of the last night add up the mileage indicated on your log and make the following notation at the top of your first sheet:

Stations Heard	Total Distance	Greatest Single Jump	Shortest Distance
38	51,348 miles	3,200 miles	200 miles

RULES

FOR THE HOME-MADE SETS

To win a prize you must send us in addition to your log:

- (a) A photo of yourself
- (b) One or more photos of your receiver
- (c) Complete diagram and working plans for building and operating your set
- (d) Complete list of the accessories used, including number and types of tubes, size and kind of A and B batteries.

FOR THE READY-MADES

Same as above except that (c) should merely include the manufacturer's name and type of set you are using. Put name at top of each log sheet and on back of each photo or diagram sent in.

Leave four-inch space at top of first page of description. Use typewriter and double spacing. Keep a carbon copy for yourself. Mail report not later than midnight, March 23rd. Reports carrying a later post-mark will not be considered.

Write your description of set while tests are on so that it can be mailed as soon as the contest is closed.

SAMPLE LOG SHEET

Stations Heard	38	John Doe
Total Distance	51,348 miles	335 West End Ave.
Best Single Jump	3,200 miles	Chicago, Ill.
Shortest Distance	200 miles	

Date	Time	Station	DX	Remarks
Feb. 20	12:05 A. M. (c)	KDKA	680 miles	Test program to England —loud—interference from "bloopers."
	12:35 A.M.	—	—	—
			Total 51,348	



## The Amateur and the B. C. L. Get Together

ON MARCH 3rd to 7th, an opportunity will be given for the broadcast listener and the telegraph amateur to meet on common ground and to discuss common radio problems at the Second Amateur Radio District show and convention. This will be held at the Hotel Pennsylvania, New York City.

The amateur is not such a fearful soul after all, and the broadcast listener is more amenable

to reason than is often thought. The amateurs are planning a program of lectures and meetings which should be instructive to broadcast listeners and certainly to amateur operators.

Amateur radio clubs and district associations in other sections of the country can learn of the plans being made for this convention and radio show by writing the president of the amateurs in the second district care RADIO BROADCAST.

# Hams Across

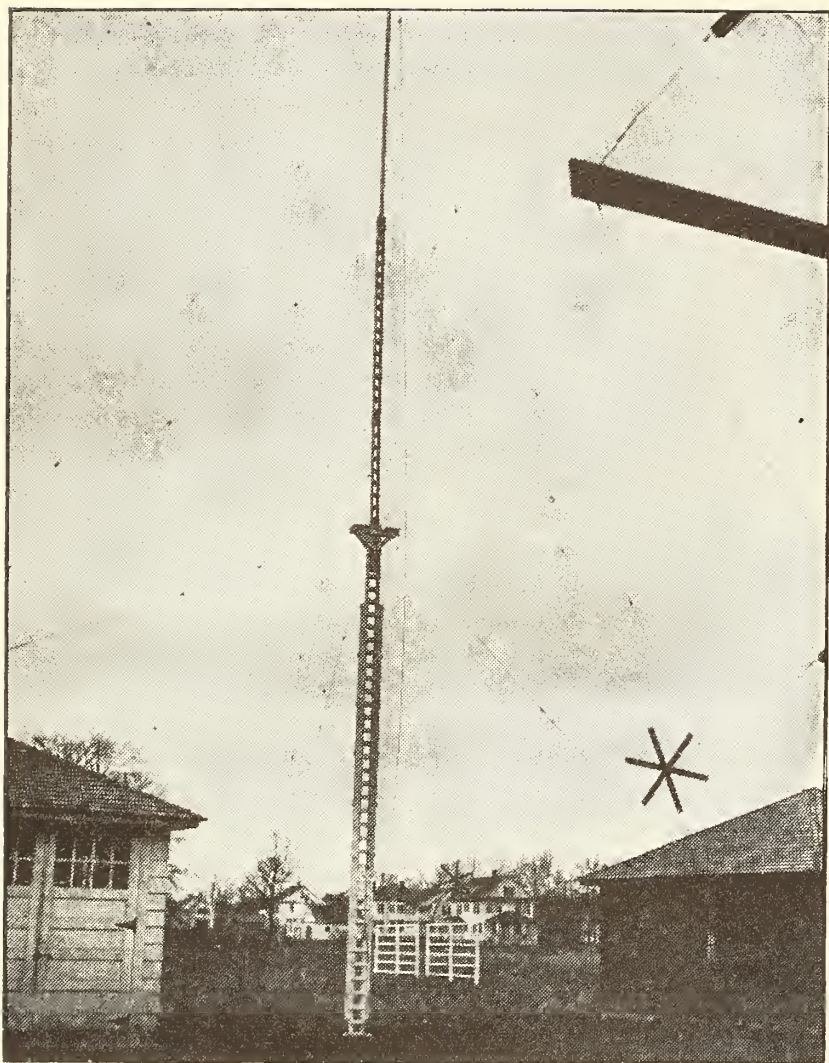

These amateur radio stations in France and America established two-way communication on 100 meters for the first time in radio history during the last months of 1923. TOP: The neat antenna and counterpoise of 1MO, operated at Hartford, Conn., by F. H. Schnell, traffic manager of the American Radio Relay League. CENTER: Mr. Schnell and his 110 meter receiver. LOWER LEFT: The 110 meter transmitter at 1MO. RIGHT: Receiving and broadcasting station at Haverford College, where signals from Leon Deloy's amateur station at Nice, France were brought in on a loud speaker

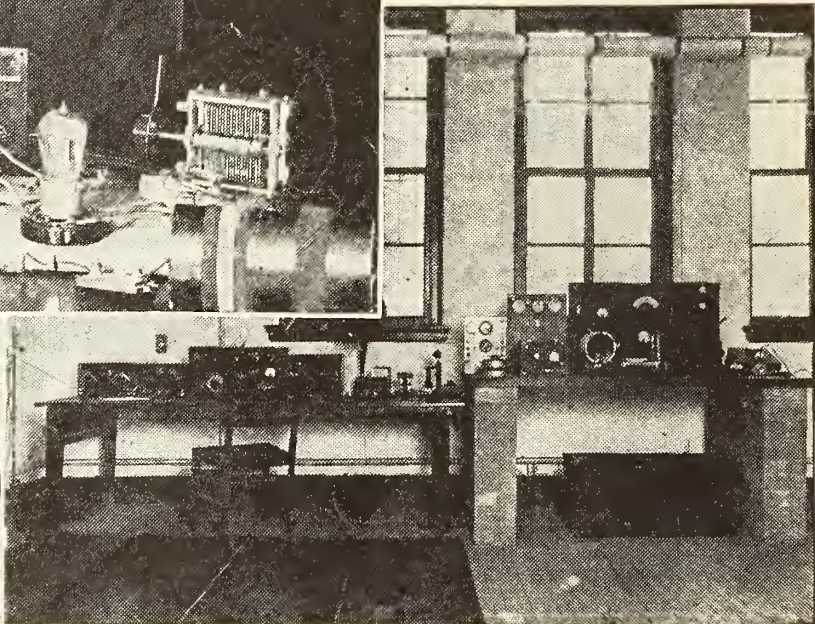
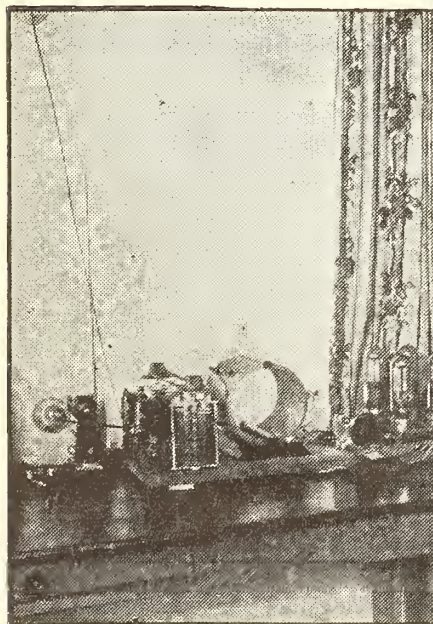
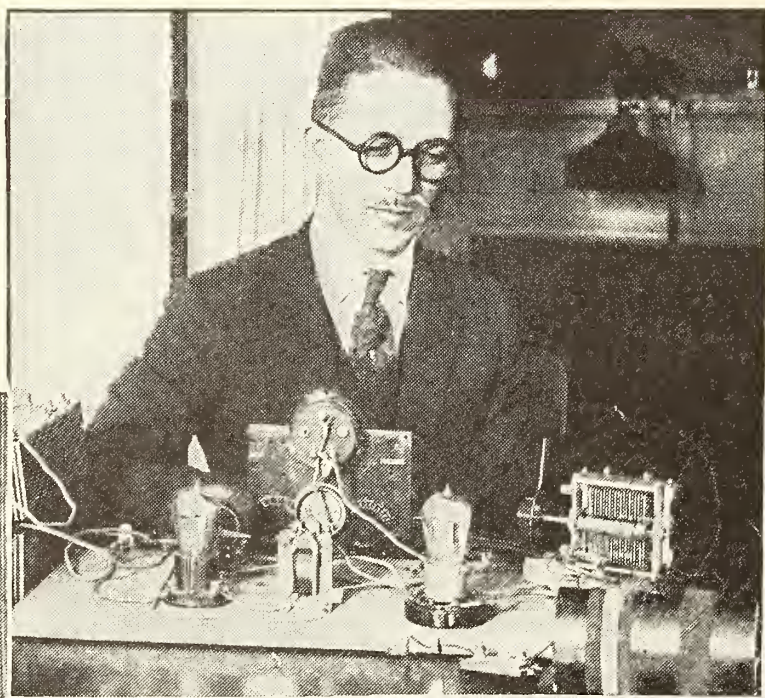

# The Sea

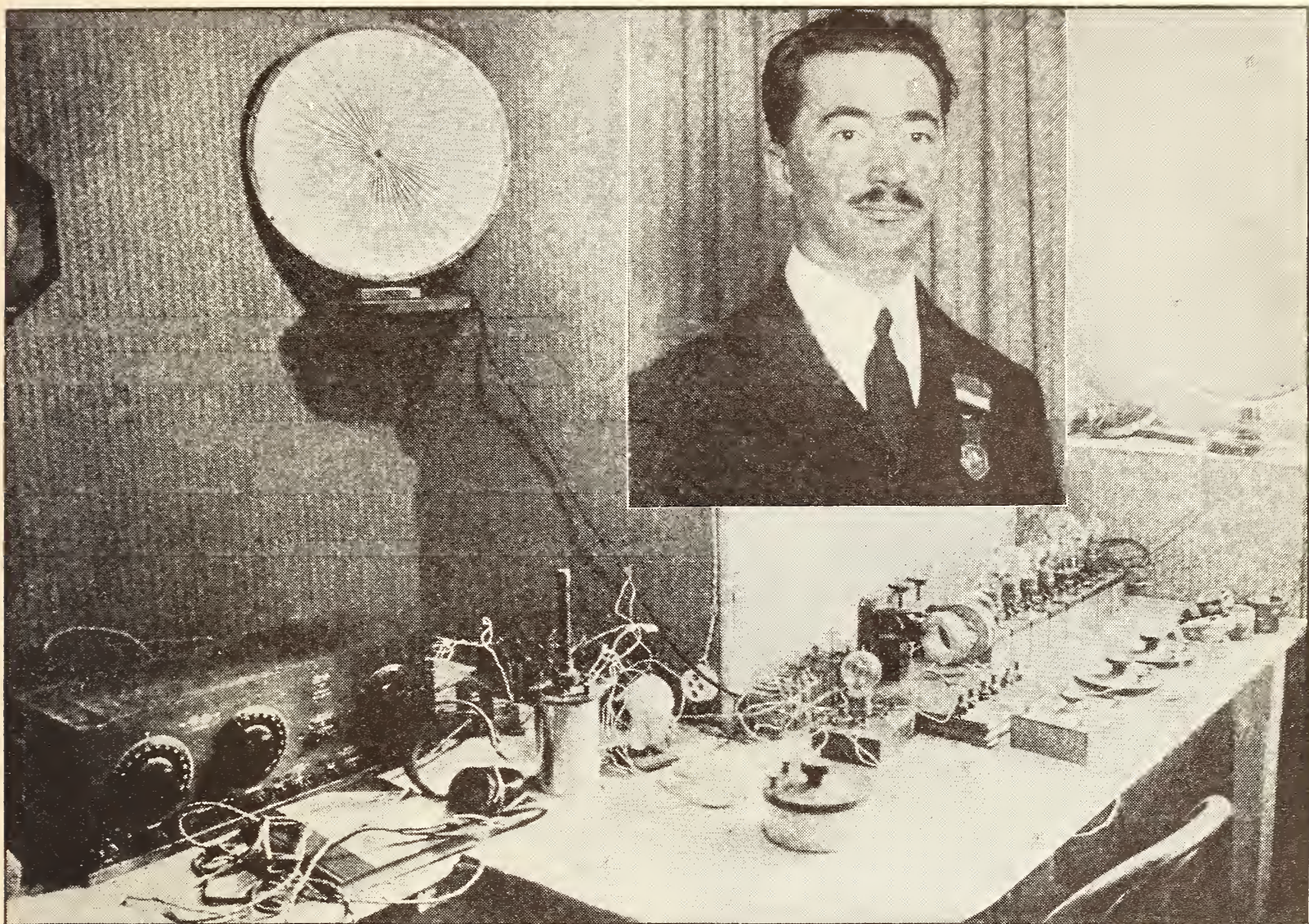

M. LÉON DELOY, OF NICE, FRANCE

Who was the first French amateur radio telegrapher to attain two way communication with American amateurs. UPPER PHOTOGRAPH: M. Deloy and his receiving apparatus. LOWER PHOTOGRAPH: The efficient tube transmitter at French 8AB, Nice

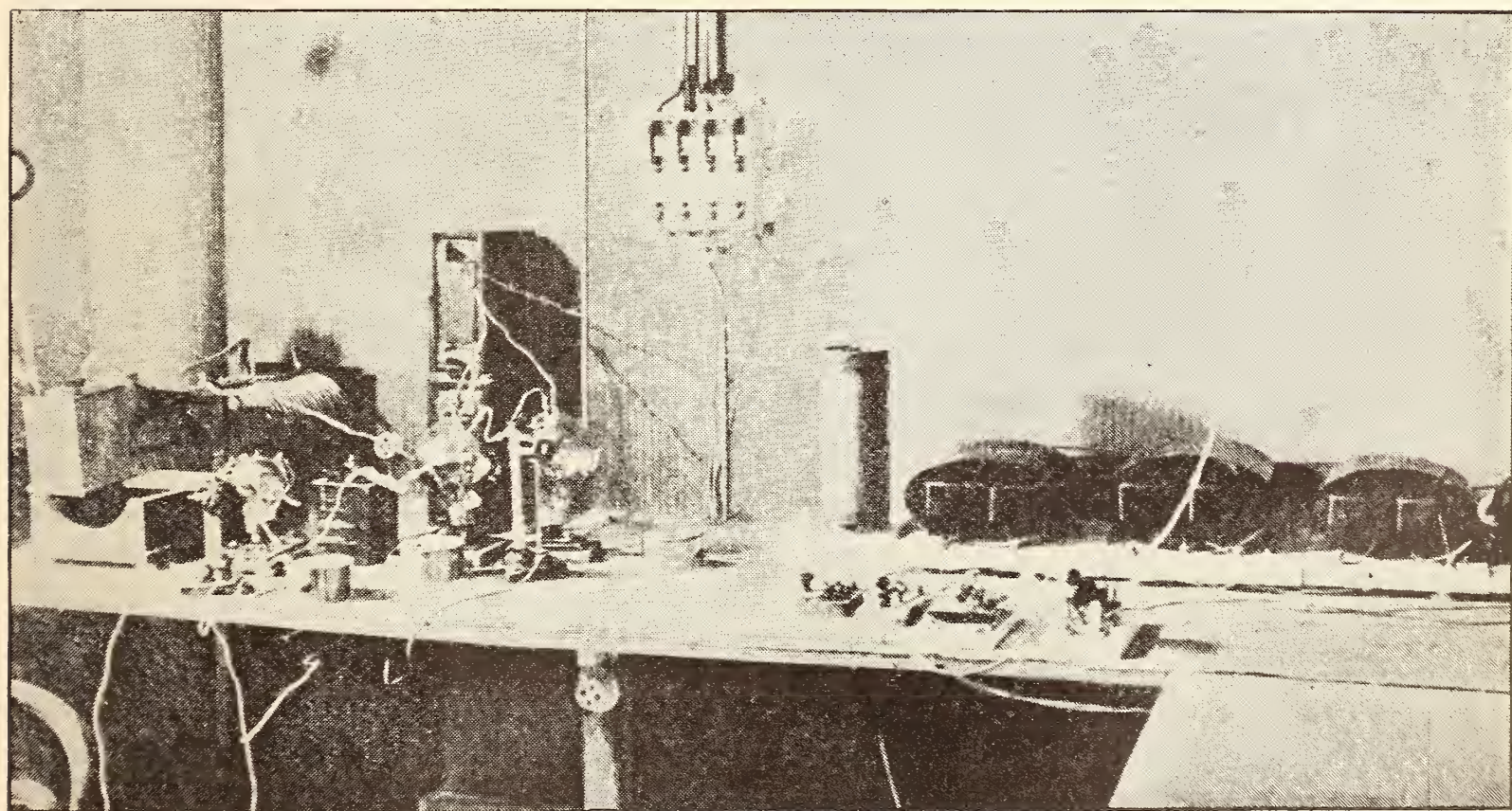

# Is the Broadcast Listener at Fault?

By CARL DREHER

**I**N MY article last month, dealing with the telegraph amateur, I called attention to the fact that as an art or industry becomes more complex and diversified, restrictions necessarily multiply, and that it is the part of wisdom to modify one's attitude accordingly. And, as it is fair to treat a man according to his pretensions, my argument was addressed to the amateurs as good technicians, in short as an engineering-minded group. With this in mind, I tried to give my view of the conflict between the amateur and the broadcast listener against a historical and political background.

Before going on I should like to restate my belief that the interests of the telegraph amateur and the broadcast listener will never be merged. They will remain separate groups, following their separate aims and desires.

Amateur radio will recruit a certain number of adherents from the ranks of the broadcast listeners, but the percentage will be small compared to the number of BCL's who will never learn the code or finger a telegraph key or own a transmitting set. For this we should be thankful, for if everyone wanted to transmit, the mechanism of radio, creaking a little even under present conditions, would certainly break down entirely. There is no more reason to believe that improvements in the art will enable ten thousand people to talk where one talks to-day, than to expect that if that number of individuals crowded into a hall, all could speak at once without confusion. The cost of transmitting sets, the special and by no means widespread appeal of this form of adventure, the difficulty of learning the code, and many other factors, will keep the two classes segregated substantially as they are now. Why, indeed, should a man who wants to hear the opera be invited to become a brass-pounder?

INTELLIGENCE, WHERE ART THOU?

**I**F THE principal trouble with the amateurs is that they do not know where they get off, the main difficulty with the broadcast fans is that they do not know, as a class, how to get

on the car, and expect miracles from the conductor once they have been hoisted aboard. It is nowhere written, to be sure, that one must have technical qualifications in order to be a good citizen. It is reasonable, however, to expect the exercise of intelligence, which consists, fundamentally, in seeking the easiest means of getting what one wants, without bothering other people, and availing oneself of all the facilities at hand. But many of the broadcast listeners do just the opposite of this.

For example, the larger broadcasting stations receive inquiries every day from people who want to know what station they heard the preceding night playing "Down on the Swanee River," or some such rare musical selection. They usually know the approximate wavelength, and sometimes a portion of

the call letters. On being told that all the radio periodicals publish, each month, a list of broadcasting stations with call letters, wavelengths, and other data, not to speak of the programs printed in the daily papers, and that on the basis of this data their own conjecture will be as good as any one else's, they not infrequently express great surprise that they have to play their own guessing game. In fact, a good many people, probably otherwise sensible, display a sort of infantile helplessness when it comes to radio. Not long ago I read a series of inquiries addressed to a broadcasting station, asking, among other things, how many feet correspond to a meter.

It would seem that any person interested in radio, who wishes to be reasonably well informed regarding what he tackles, should read at least one radio periodical—preferably a monthly, since the monthly magazines are much less given to featuring transitory circuits and news than the newspaper radio supplements. Radio conditions alter rapidly and many problems remain to be solved; one cannot get an intelligent view of the field without spending a small amount of time reading one of the magazines every month. This reacts directly on each reader and largely determines what he will get out of his radio



experience. Yet it is doubtful whether the radio publications number more readers, in proportion to the total number of people interested, than sporting magazines and other papers in comparatively stabilized fields. Tennis playing or duck shooting have not altered so much in the past decade that a man could not keep up with the crowd merely through his activities in the field, but radio, in its present state, is in a different position. A man reading a well established radio magazine regularly would not be apt to write such an inquiry as the one below, which was addressed to a broadcasting station:

"Will you kindly send me any information you have as to the right way to 'tune in.'

"I have a one-tube set and get the stations quite clear but I get interference."

In the course of a few months he would no doubt have read such a description. He would know how to tune his set with a minimum of trouble for his neighbors and a maximum of satisfaction for himself. And that brings up the somewhat hackneyed, but urgent as ever, question of oscillating receivers.

"THE DESTRUCTION THAT WASTETH AT NOON-DAY" AND "AT EVENTIDE"

I AM listening to Dvorak's New World Symphony, using slight regeneration. One of the neighboring B.C.L.'s comes along, his receiver oscillating merrily. He makes a few preliminary flourishes, passing rapidly through the wavelength of the broadcasting station with agonizing squeals; finally he locates on zero beats. He is not satisfied with the result, so with his receiver still oscillating full blast, he detunes somewhat and holds a 2000-cycle note for several minutes. When I am almost used to this, he changes his mind and recommences adjustments, filling the room with howling crescendos and diminuendos; and this clamor lasts for the next five minutes, when, happily, my neighbor decides to go to the movies and shuts off his receiver-transmitter for the night. But I am never safe against him.

It is doubtful, in this case, if there is any other remedy than education of the public. Transmitters may be regulated by law, their number being within reason. Receiving sets are so common that the enforcement of a law

against oscillating sets is enough to daunt any legislator. Of course the commercial manufacture of receivers capable of oscillating could be forbidden, but the problem would remain of dealing with the make-your-own group (which would correspond to the home-brew gentry, and would no doubt be quite as numerous).

The problem is fundamentally an economic one. Regeneration is the cheapest form of radio-frequency amplification. It may be carried on in the same tube that is used for rectification. The amplification realized is roughly equal to one step of radio frequency.

The price of a vacuum tube is an important consideration to most people, and naturally, when they can get the equivalent of a two-tube set from one tube, they do not hesitate to use the invention which makes this possible, even though they complicate the interference problem in so doing. Means are of course known whereby re-radiation can be prevented. One method is to forbid the use of regeneration. Another is to use a coupling tube, or one-way

repeater, between the aerial and the regenerating tube, to act as a valve, preventing the local oscillations from getting out into the air. But this wastes a tube. The most simple scheme is for everyone to use regeneration only to a limited extent. But that requires the general exercise of discretion and considerable respect for the rights of others. Till we get to that point, the wailing of the damned will be mingled with every symphony.

#### CHARITY, CHARITY FOR THE AMATEUR

FINALLY, every fair-minded person must deprecate the setting up of scapegoats, and there is no denying that many of the broadcast listeners are trying to make scapegoats of the amateurs. Amateurs are blamed for the interference of leaky high-tension transmission lines, X-ray machines, commercial stations, and any other noise that happens to interfere with a broadcast listener. The amateurs, knowing themselves in many cases to be unjustly accused, develop the feeling that they are being persecuted, and become bitter-enders and irreconcilables. Thus, into a situation which requires clear thinking and scientific adjustment, the psychology of conflict is injected, and belligerency takes the place of reasoning. A prominent amateur writes to a



current radio periodical, "I believe I speak for every amateur in America when I say that I hope the amateur may see the day when he can tramp on the grave of the nighthawk broadcaster, and kick his tombstone into perdition beyond recall." Simultaneously a broadcast listener declaims in another place, "If that is the station that is broadcasting code . . . my suggestion would be that instead of hiring a lawyer the matter be placed in the hands of a vigilance committee for action." These excited metaphors, and the familiar demand for a "vigilant" committee, will not solve the problem.

The amateur and the broadcast listener are parties to a situation that is by no means

simple, and which must be considered from several angles. Their interests are, I believe, fundamentally opposed, and it is idle to deny that a conflict of increasing proportions is in progress between them. But I also believe that an amicable compromise is possible, and will eventually be arranged. The prerequisites to this are, first, readiness on the part of the amateurs in the cities to surrender some portion of their present freedom; and secondly, willingness to learn what it is all about on the part of the broadcast listeners. The spirit of toleration and good will, the desire to understand the other man's motives, and an objective view of the technical problems involved, are badly needed in radio at the present time.

# What Makes the Wheels Go 'Round

## ONE SYLLABLE ELECTRICAL THEORY. I

Removing the Terrors From the Common Elementary Electrical Theory—The Basis of Radio

BY WALTER VAN B. ROBERTS, B.S. E. E., A. M.

### I. ELECTRONS

**J**UST as sand comes in tiny grains, electricity comes in almost unimaginably small units called electrons. These can be assumed to be round, and about a tenth of a trillionth of a centimeter in diameter. They are all exactly alike and the weight, even of billions of trillions of them, is entirely negligible. In some fashion not yet completely understood, they manage to flow through solid metal wires fairly easily, although insulating substances such as glass, rubber, porcelain, dry wood, etc., even air very effectively block their passage.

### 2. FREE ELECTRON THEORY OF CONDUCTION

**A** WIRE, not connected to anything, may be supposed to contain about ten billion trillion electrons per cubic centimeter that are free to travel. There may be a great many more in the wire, but we are mostly interested in the "free electrons" because they are the ones that start moving when an "electromotive force"

is applied to the wire by connecting its ends to the poles of a battery or dynamo.

### 3. ELECTRIC CHARGE

**T**HE actual total number of electrons normally present in a gram of any substance is about six hundred billion trillion. If more than this normal quota are present the substance is said to be *negatively* charged. (It is very unfortunate that in the days before much was known about electricity the term *negative charge* was arbitrarily picked to designate what we now know to be an excess of electrons. A great many words will have to be wasted trying to keep clear of confusion resulting from this unlucky choice of terms.) If less than the normal number are present the substance is said to be *positively* charged.

### 4. ELECTRIC POTENTIAL

**I**F A tank of compressed air is connected by a pipe to another tank containing air at a different pressure, air will flow from the tank where the pressure is higher to the one where the

pressure is lower, no matter what the relative sizes of the tanks. This analogy should make clear the term "electrical potential" which corresponds exactly to the air pressure. For if two bodies are connected by a wire, electrons will flow, from the one having the greater electron pressure, to the other. But due to the unfortunate convention that electrons are negative electricity, a large electron pressure is called a large *negative* potential, while less than the normal number of electrons causes a positive potential. Except for this reversal of the terms "positive" and "negative" in the electrical case, the analogy can be made complete by introducing the term "negative pressure" or vacuum for the amount below normal atmospheric pressure in the analogy. See Fig. 1.

What You Can Learn From This Series

There is a growing desire on the part of our readers to have a more definite understanding of what goes on in a receiving set when the dials and knobs are turned. Many have rather fantastic ideas about radio in general and radio receivers in particular. It is a very difficult matter to find an author who really knows this subject and is gifted with the happy faculty of telling what he knows in language within the understanding of other than scientific minds. Mr. Roberts is such an author. His articles on super-regeneration and the super-heterodyne have won him many friends among our more technically and experimentally inclined readers.

In the series of articles, of which this is the first, he has covered the entire field of radio in a most interesting, intelligent, and capable manner. He understands his subject well enough to cut the corners without leaving the reader to take any of the facts for granted, merely because they are given as facts. Mr. Roberts has proof for everything, and very interesting proof at that.—THE EDITOR.

5. ELECTRIC CURRENTS

FIG. 2 shows how a continuous flow may be obtained. A fan maintains the air at a higher pressure at A than at B so that a current of air flows from A to B through the pipe. In the electrical case a dynamo or battery is the electrical pump. It is conventional to pretend that an electric current is the flow of positive electricity, and the direction of the current is the direction of this flow. This explains the well known rule that current flows from the positive pole of a battery through the external circuit

back to the negative pole. Actually of course it is the electrons that are moving, and in the opposite direction. The strength of the current, which is called the number of amperes of current, is the number of units of electricity that pass a given point in the wire per second,

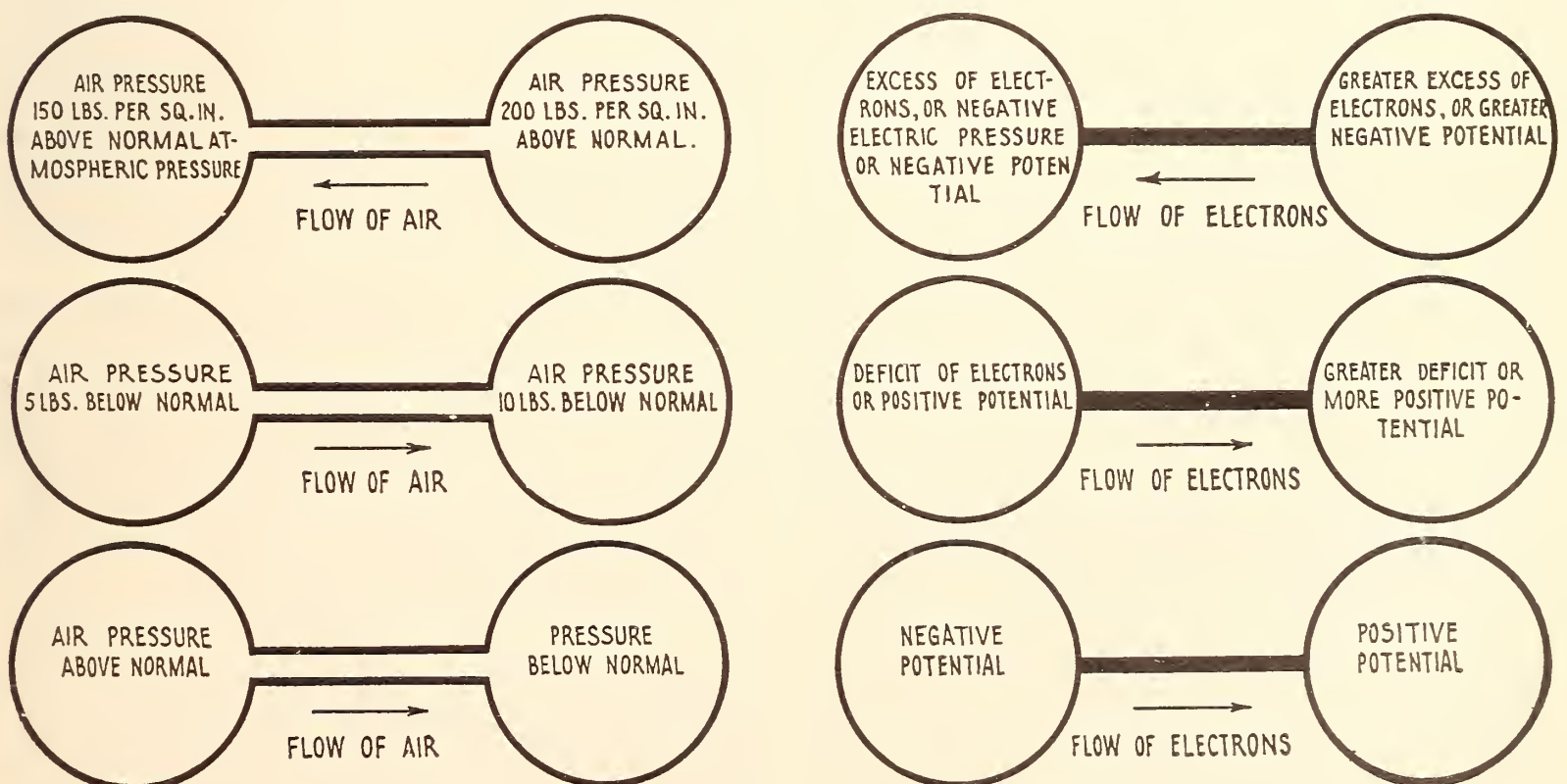

FIG. 1 How electrical pressure is like air pressure

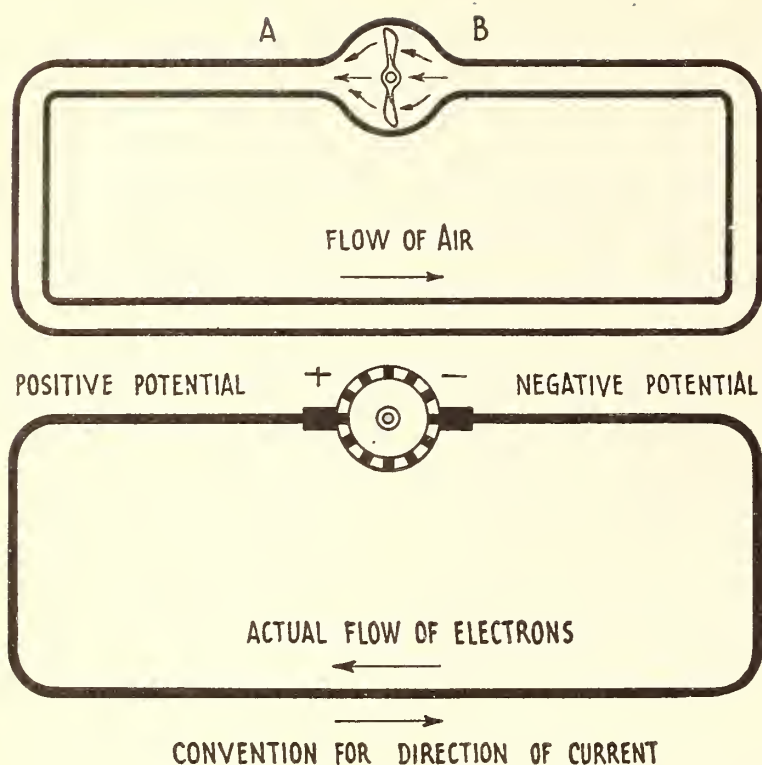

FIG. 2

Showing graphically how a continuous flow of current is maintained

just as the amount of flow of water is the number of gallons passing a given point in a pipe per second. It would be very reasonable to measure an electric current by simply stating the number of electrons that pass a given point per second, but it would be very awkward because even with so small a current as one ampere flowing more electrons go by per second than there are grains of sand visible on all the sea shores of the world.

#### 6. SPEED OF ELECTRICITY IN WIRES

CONTRARY to general belief, electricity flows very slowly through wires. There are so many electrons free to move that a large current results from their very slow motion, just as a large current of water is caused by a very slow motion of the water in a wide, deep river. It is thought that the average rate of drift of electrons along a copper wire one centimeter in diameter carrying one ampere of current is about the same as the speed of the minute hand of a clock. What does travel with terrific speed when a current is started, is an electric "wave"—a thing ahead of which there is no current, and behind which the electricity has begun to flow. When a freight engine starts a long train the engine starts first, then the first car is yanked into motion, the latter in turn starts the second car and so on. Likewise, if we connect a battery to the ends of a wire many miles long, within a fraction of a

second the electrons even in the most distant parts of the wire will be on the move.

#### 7. ALTERNATING CURRENTS

WE HAVE been speaking of direct currents, or currents where the electricity flows steadily along without stopping. If, however, the electricity does not on the average move along the wire at all but merely goes back and forth, the current is called alternating. We often say that an alternating current flows "through" a wire: it would obviously be more exact to say that an alternating current flows *in* the wire. A direct and an alternating current can be considered to flow in the same wire at the same time, in which case the resulting motion of the electricity would give somewhat the effect of a man walking two steps forward and then one step back. The frequency is the number of times per second that the electricity vibrates from one end of its path to the other and back again. This round trip is called a cycle, hence the frequency of an alternating current is expressed as so many cycles per second. Sixty cycles per second is usual for house lighting, fifteen to twenty-five cycles for electric railway power, thirty to five thousand for current representing the human voice, and currents of frequencies above about ten thousand are classed as radio frequency currents. Currents of five hundred kilocycles to a thousand kilocycles (500,000 to 1,000,000 cycles) flowing in the antennæ of broadcasting stations are the immediate cause of the radio waves. An interesting point to note about these high frequency currents is that the electricity must barely quiver, for, moving with a speed comparable to that of the hand of a clock, and reversing its motion a million or so times per second, the path traveled would be ultra microscopic.

Either direct or alternating current will heat a wire. If an alternating current heats a certain wire exactly the same amount as three amperes direct current would do, then the "effective value" of the alternating current is likewise three amperes. The effective value is also sometimes called the heating value and the root mean square value.

#### 8. CONDENSERS

FIG. 3 shows a condenser and a hydraulic analogy for it. The crank and piston arrangement, when rotating, produces an alternating current of the water filling the system.



The diaphragm prevents any direct current, but by bending back and forth allows alternating motion of the water. The greater the area of the diaphragm, and the thinner it is and the more flexible the material it is made of, the easier it will be to turn the crank. In the electrical case, corresponding to the diaphragm we have a sheet of some insulating substance separating two sheets of metal. This prevents direct current but allows alternating current. The greater the area of the metal sheets, the closer they are together, and the greater the "dielectric constant" of the substance between them, the less powerful need be the source of alternating current to produce a given current. (To save space, condensers usually have one plate cut up into small pieces and connected together, interleaving with the pieces of the other plate, as shown in Fig. 3.) Returning to the hydraulic case, if the connecting rod is hitched to point No. 2 instead of No. 1, only half the force will be required to turn the crank as the diaphragm will only be stretched half as much. Also the current will be only half as great. But if, then, the crank be turned twice as fast, the speed of the water will be doubled so that the current is the same as before. This establishes a relation that holds good in the electrical case, namely, that if the frequency be doubled, or trebled, etc., the electromotive force required to produce the same current will be only one half, or one third, etc., as great. The "capacity" of condensers used in radio circuits is usually expressed in microfarads, and if air is used as the insulating substance between the plates, the capacity in microfarads, is approximately equal to the area of one of the plates (measured in square centimeters) divided by 11,300,000 times the distance between the plates (measured in centimeters). If other insulating material is used, multiply by its dielectric constant. The dielectric constant of mica, for example, is about 6.

9. INDUCTANCE

**I**NERTIA or mass is the mechanical analogy of electrical self inductance, but in this case the mechanical analogy does not give anything like the complete picture of the electrical phenomenon that it does for the condenser. If a certain length of wire, say a thousand feet, has its ends connected to a source of alternating electromotive force, such as the house lighting circuit, we might expect that the same current would be produced in the wire whether it were

coiled up or lying around strung out all over the floor. Yet as a matter of fact, if the wire is wound into a compact coil very little current will flow; while if uncoiled so much current might flow as to blow out a fuse. The mere coiling up of the wire produced the same effect as if the electricity in the wire became very heavy and hence difficult to make oscillate back and forth rapidly. There is no exact mechanical equivalent for this experiment, but the balance wheel of a watch has somewhat similar properties: if its weight be concentrated at the rim it will be more difficult for the spring to make it oscillate and hence the watch will run slower. The electromotive force required to produce an alternating current of given strength in a coil of wire, or inductance, is greater the greater the frequency of the current. If the frequency is doubled or trebled etc. the e.m.f. required will be doubled, trebled etc., or exactly the opposite to what was found to be true for a condenser.

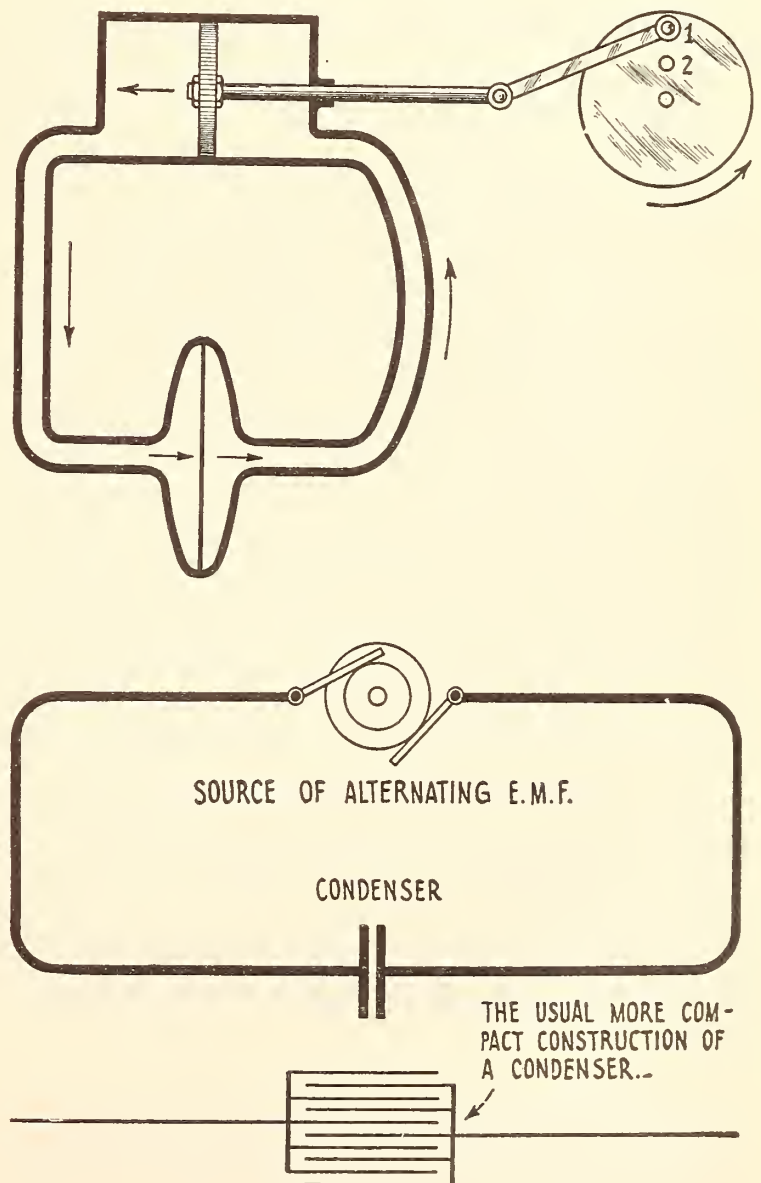

FIG. 3

A water-analogy to the action of a condenser

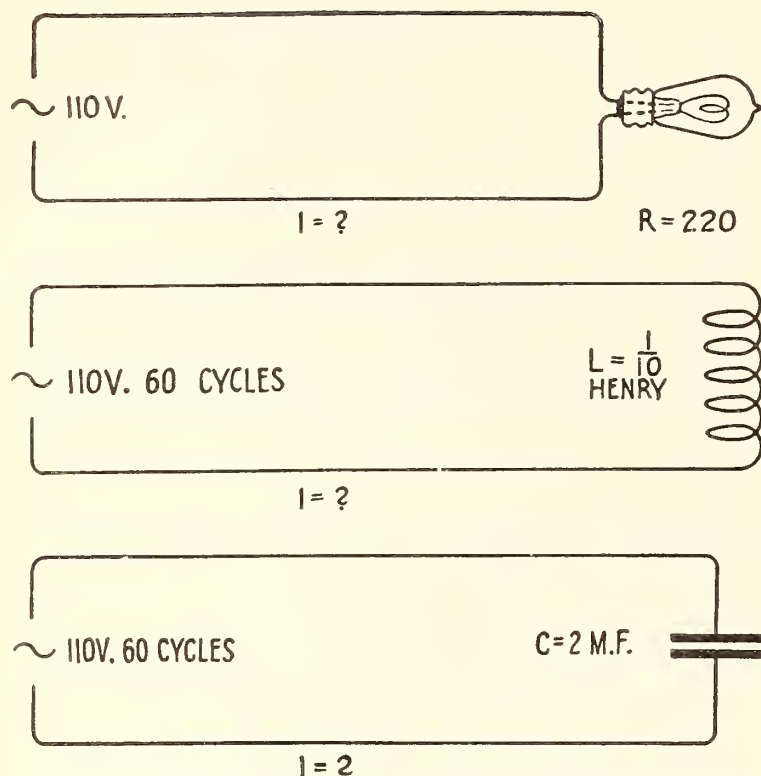

FIG. 4

A simple circuit in which we apply Ohm's law

#### 10. THE VOLT AND OHM

WHAT we call a source of electromotive force is any machine (such as a dynamo, battery, or transformer) that will maintain a difference of potential between the two terminals of a circuit. The amount of e.m.f. or potential difference is measured in volts.

If a source of  $E$  volts (either direct or alternating) produces  $I$  amperes of current in a certain wire, the number of ohms resistance in the wire is  $\frac{E}{I}$ , the number of volts required per ampere produced. This is Ohm's law and is usually written  $\frac{E}{I} = R$ . If any two of the quantities are known, this equation gives the third. For example, if an electric light bulb has a resistance of 220 ohms and it is connected to a 110 volt source of e.m.f. what current will flow? Substituting in the equation the values given we have  $\frac{110}{I} = 220\omega$  hence  $I = \frac{1}{2}$  ampere. (See Fig. 4) The resistance of a wire is equal to a constant whose value depends upon the metal used, multiplied by the length of the wire, and divided by the area of cross section.† Next to silver, copper enjoys the lowest value of this constant, and hence is the best conductor.

† Except that at very high frequencies, current tends to flow more and more nearly along the surface of conductors. Hence the resistance is somewhat the same as if the wire were hollow like a pipe. This phenomenon is called "skin effect." At frequencies sufficiently high for pronounced skin effect, the amount of surface of the conductor is more important than area of cross section.

#### 11. INDUCTIVE REACTANCE

IF A source of  $E$  volts *alternating* produces  $I$  amperes in a certain coil of wire (the wire being supposed so thick that its resistance is negligible) then the quantity  $\frac{E}{I}$  is the number of ohms of "inductive reactance" possessed by the coil at the frequency used. Unlike resistance, the amount of inductive reactance depends upon the frequency as mentioned in the paragraph describing inductance. The number of ohms of inductive reactance possessed by a coil at a frequency  $f$  is  $2\pi fL$  where  $L$  is a constant that depends upon the size and shape of the coil and the number of turns of wire on it. This constant is measured in henrys, and is called the coefficient of self inductance of the coil. An illustrative problem is to calculate the current in a coil whose coefficient of self induction is one tenth of a henry and which is connected to the house lighting current supply (110 volts and a frequency of 60 cycles). We start by calculating that at 60 cycles the inductive reactance is  $2\pi \times 60 \times \frac{1}{10}$  or 37.7 ohms. Then putting the known values in the formula  $\frac{E}{I} = \text{ohms}$  we have  $\frac{110}{I} = 37.7$  whence  $I = 2.92$  amperes. (See Fig. 4.)

#### 12. CONDENSIVE REACTANCE

IF A source of *alternating* e.m.f. of  $E$  volts produces  $I$  amperes when connected to a certain condenser, then the quantity  $\frac{E}{I}$  is the number of ohms of "condensive reactance" possessed by the condenser at the frequency used. The amount of condensive reactance depends upon frequency in a different way from inductive reactance. The number of ohms of condensive reactance at a frequency  $f$  is  $\frac{1}{2\pi fC}$  where  $C$  is a constant called the capacity, and must be measured in farads in order to use in this formula. Illustrative problem: what current will flow if a condenser of 2 microfarads capacity is connected to the house lighting circuit? First, the capacity is  $\frac{2}{1,000,000}$  farads, hence the reactance at 60 cycles is  $\frac{1}{2\pi \times 60 \times \frac{2}{1,000,000}}$  or 1,325 ohms. Then  $\frac{110}{I} = 1,325$  so  $I = .083$  amperes. (See Fig. 4.)

The total resistance when two resistances are connected in series is simply the sum of the two resistances. Likewise, if two condensers are connected in series the condensive reactance of the combination is the sum of the separate condensive reactances of the two. And if two coils are connected in series the inductive reactance of the combination is the sum of the

SYMBOLS ADAPTED BY I. R. E.	OTHER SYMBOLS	NAME
		VARIABLE COUPLING
		INDUCTION COUPLING OR AIR CORE TRANSFORMER
		AUTO-TRANSFORMER
		IRON CORE TRANSFORMER
		AMMETER
		VOLTMETER
		WIRES CROSSED JOINED
		WIRES CROSSED NOT JOINED
		ANTENNA
		GROUND
		TELEPHONE RECEIVER
		COIL OR LOOP ANTENNA
		LOUD SPEAKING TELEPHONE RECEIVER
		THREE ELECTRODE VACUUM TUBE

SYMBOLS ADAPTED BY I. R. E.	OTHER SYMBOLS	NAME
		BATTERY
		SINGLE CELL
		DIRECT CURRENT GENERATOR
		ALTERNATING CURRENT GENERATOR
		RESISTANCE (NON INDUCTIVE)
		VARIABLE RESISTANCE OR RHEOSTAT
		CONDENSER FOR AUDIO FREQUENCIES
		CONDENSER FOR RADIO FREQUENCIES
		VARIABLE CONDENSER (THE DOT IS ON ROTATING PLATE)
		INDUCTANCE
		IRON CORED INDUCTANCE
		VARIABLE INDUCTANCE OR VARIOMETER
		INDUCTANCE VARIABLE BY TAPS
		CRYSTAL DETECTOR

COMMON SYMBOLS USED IN RADIO CIRCUITS

inductive reactances of the coils. (Here however the coils must be far enough apart, or set at such an angle with each other, that currents in one coil have no effect on current in the other)

SERIES COMBINATION OF DIFFERENT KINDS OF REACTANCE

WHEN we try to figure the effect of connecting dissimilar things together we have to use a new and more difficult set of rules. The first of these is, if an inductive reactance is connected in series with a condensive reactance, the reactance of the combination is the number of ohms of inductive reactance *minus* the number of ohms of condensive reactance. Thus a coil and condenser in series work against each other, and if the proper relative values are chosen, will exactly cancel each other so that the combination has zero reactance at the frequency in use. (See Fig. 5)

13. IMPEDANCE

BUT when a resistance is connected in series with a reactance what is the total number of ohms? It is not simply the sum, or the difference, but lies somewhere between the two. It is  $\sqrt{R^2 + X^2}$  where X is the number of ohms re-

actance. This quantity which has both resistance and reactance in its make up is called an impedance. If a source of alternating e.m.f. of E volts produces I amperes when connected to a pair of terminals leading into a box which is sealed up so that we have no idea what is inside, what is the quantity  $\frac{E}{I}$ ? we can't call it resistance unless we know that the box contains only resistances—we can't call it condensive reactance unless the box contains only condensers—we can't call it inductive reactance unless the box contains only coils of negligibly small resistance. Impedance is what we call it *whatever* is in the box. Thus resistance and the two kinds of reactance are merely special cases of the more general term impedance. It is impossible to say how impedance varies with frequency unless we know all about the arrangement of resistances, capacities, and inductances that make up the particular impedance under consideration.

For most purposes we want everything either one thing or the other. That is, we want our condensers as free as possible from resistance, we want our inductances to have as little resistance and distributed capacity as possible, and our resistances to be non inductive and to have the least possible distributed capacity.

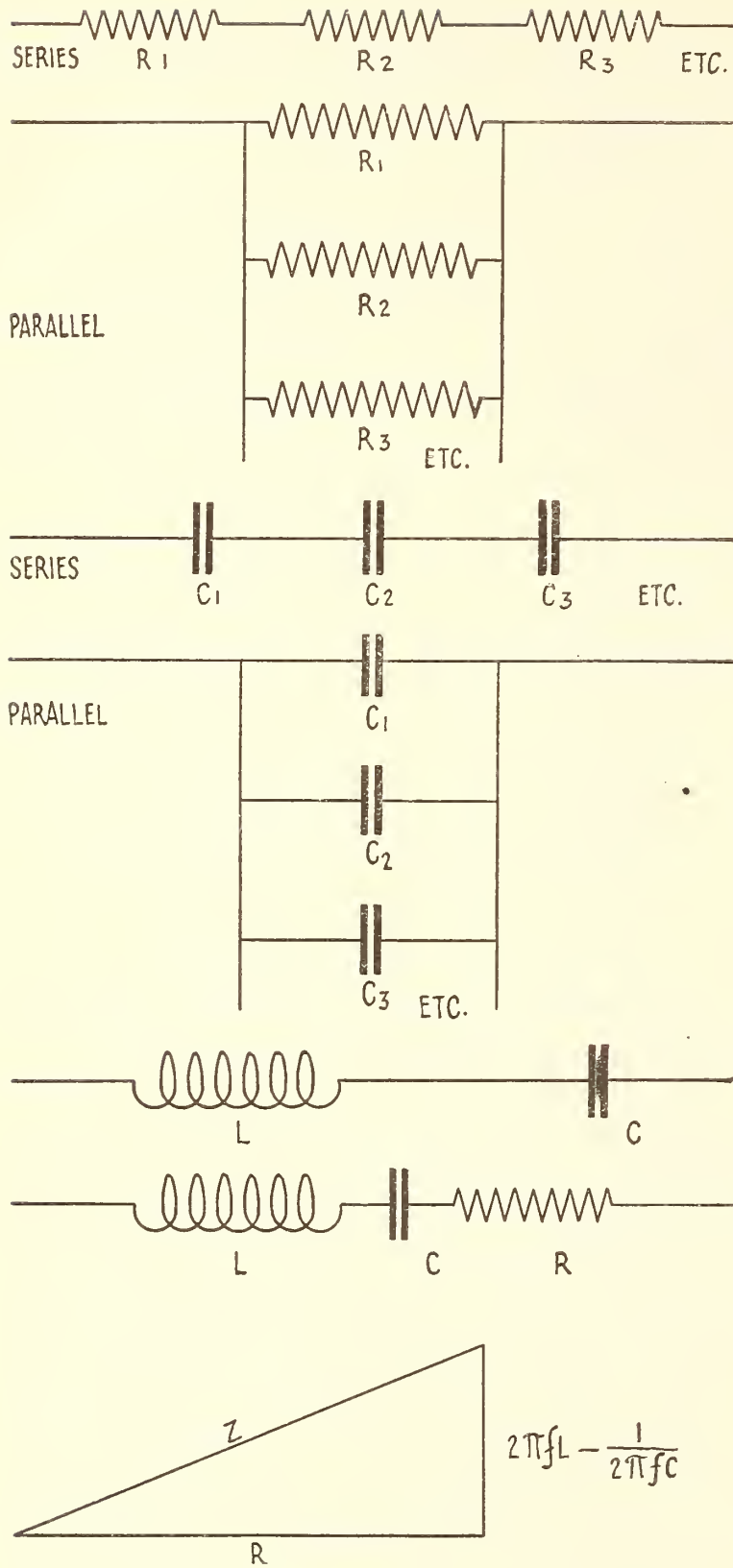

FIG. 5

Simple connections of resistances and capacities

14. RESONANCE

REFERRING to Fig. 5, if L and C are chosen so that at the frequency f their reactances exactly cancel each other (that is,  $2\pi fL = \frac{1}{2\pi fC}$ ) then the only thing left to limit the amount of current that will flow is the resistance of the wire out of which the inductance is made. If care is used to make this resistance as small as possible, the current obtained will be enormous compared to what it would be if only the condenser, or only the coil, were present, or if they had different relative values, or if the frequency

Important Formulæ for Simple Combinations of Resistances and Reactances

Total resistance,  $R = R_1 + R_2 + R_3 \dots$   
 Effective resistance given by  $\frac{1}{R} = \frac{1}{R_1} + \frac{1}{R_2} + \frac{1}{R_3} \dots$   
 Total reactance,  $\frac{1}{2\pi fC} = \frac{1}{2\pi fC_1} + \frac{1}{2\pi fC_2} + \frac{1}{2\pi fC_3} + \dots$   
 Effective capacity, C is given by  $\frac{1}{C} = \frac{1}{C_1} + \frac{1}{C_2} + \frac{1}{C_3} \dots$   
 Total capacity,  $C = C_1 + C_2 + C_3 \dots$   
 Effective reactance,  $\frac{1}{2\pi fC} = \frac{1}{2\pi f(C_1 + C_2 + C_3 + \text{etc.})}$   
 Total reactance =  $2\pi f = \frac{1}{2\pi fC}$  { If this comes out a negative number, the total reactance is condensive, i.e., the combination acts as a condenser at frequency f

The total reactance, if any two of the three quantities f, L and C are given, may be made zero by proper choice of the third. Thus if L = 1 milhenry, C .001 mfd; then the reactance will be zero for  $f = \frac{1000000}{2\pi}$

The impedance of this combination,  $Z = \sqrt{R^2 + (2\pi fL - \frac{1}{2\pi fC})^2}$  and may be obtained graphically by laying out a right triangle. The length of the sides are proportional to the resistance and reactance, and the hypotenuse to the impedance.

were different. All the peculiar effects that occur on account of a condensive reactance in a circuit becoming equal to an inductive reactance are classed as "resonance" phenomena. In the case just described a noticeable current would result from the application of a voltage so small that it would not cause enough current to detect at all if the circuit had not been "tuned" to the resonance condition. There are many mechanical analogies for this condition of resonance. The usual one is soldiers going over a bridge. If the effect of the mass of the bridge just cancels the effect of its stiffness or springyness for the frequency with which their feet come down, violent swaying will result. Another example is the response of a piano string to a note of its own natural frequency sung at it. This response of a tuned system almost exclusively to impulses of its own natural frequency is the basis of all methods of tuning radio receivers to pick up signals of one frequency, and practically no others.

15. MUTUAL INDUCTANCE

MECHANICAL analogies for mutual inductance are so far fetched as to be more difficult to understand than the real thing. The basic fact of mutual induction, and one that is

best taken as an experimental fact and let go at that, is that if alternating current flows in a coil of wire, then an alternating e.m.f. of the same frequency will be discovered to exist in a near-by coil. If the ends of the near-by coil are connected to an ammeter it will be seen that current flows. If the ends of the coil are connected to a voltmeter, it will indicate the number of volts e.m.f. that are "induced" in the coil by the existence of current in the first mentioned, or primary, coil. With a given primary coil and a given current flowing in it, the number of volts induced in the secondary depends upon a number of things. The induced voltage will be greater in direct proportion to the frequency, and to the number of turns of wire in the secondary coil. It will be less if the two coils are far apart, and can be made zero by turning the coils at right angles to each other or into any of a number of different relative positions. The maximum voltage will be induced when they are as close together as possible, and then even this maximum can usually be greatly increased by inserting a core of iron through both coils.

16. TRANSFORMERS

THE ordinary commercial iron cored transformer is simply two coils of wire wound on the same iron core. So long as the secondary of such a transformer is open circuited, or connected to something of impedance so high that not much current flows, we have the very simple relation that the voltage delivered by the secondary bears the same relation to the voltage applied to the primary as the number of turns in the secondary bears to the number of turns in the primary. A ten

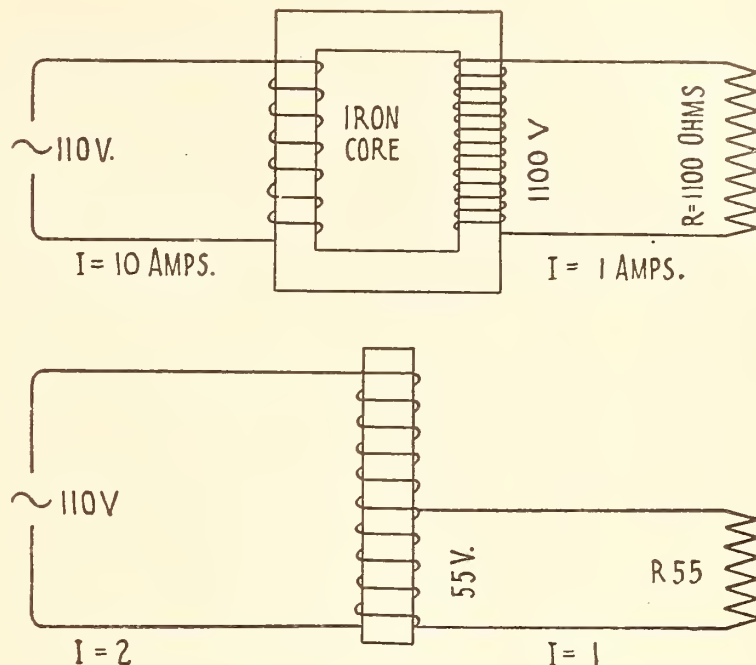

FIG. 6

A simplified drawing of a closed core transformer and (below) an auto transformer

to one step up transformer would be one whose secondary had ten times as many turns as the primary.

A transformer corresponds to gears in mechanics. If by an arrangement of gears or levers we increase a mechanical force ten times, we know instinctively that we must expect the part of the arrangement that is exerting the "stepped up" force to move ten times as slowly as the part where the original force is being applied. If we choose to gain in force we lose correspondingly in speed or else we could get "something for nothing." The electrical transformer is not a source of power. It merely changes the power put into it at one voltage into the same power (less a small percentage loss) at a different voltage. Hence

ELECTRICAL PREFIXES

PREFIX	MEANING	EXAMPLES
meg	million	1 megohm = 1 million ohms
micro	millionth	1 microampere = 1 millionth of an ampere
kilo	thousand	1 kilocycle = 1 thousandcycles 1 kilowatt = 1 thousand watts
milli	thousandth	1 milliampere or = 1 thousandth mil-amp of an ampere

CONVENTIONAL USE OF LETTERS TO REPRESENT VARIOUS QUANTITIES

R	Resistance, measured in ohms
X	Reactance, measured in ohms
Z	Impedance measured in ohms
L	Coefficient of self-induction, measured in henrys
C	Capacity, measured in farads
f	Frequency, measured in cycles per second
p or w	Periodicity, (= 2π f), measured in radians per second
E or V	Voltage or potential difference, measured in volts
I or i	Current, measured in amperes

just as the speed went down in the mechanical case, so the current is less in the high tension or high voltage side of the transformer. The ratio of currents is exactly the opposite to the ratio of voltages. An auto transformer is no different except that the winding having the fewest turns is merely a part of the other winding. Thus only one coil is required. (See Fig. 6).

It was stated previously that any current in a resistance heats the resistance just as a rope sliding through a pipe would heat the pipe on account of friction. If a current of  $I$  amperes flows in a resistance of  $R$  ohms, electrical energy is dissipated at the rate of  $I^2R$  watts. If an electric toaster has a resistance of 22 ohms and is connected to a 110 volt circuit, then by Ohm's law we know that 5 amperes will flow. Hence  $I^2R$  or  $5^2 \times 22$  or 550 watts is the rate at

which electrical energy is being turned into heat.

#### 17. POWER

IF A battery of  $E$  volts causes a current of  $I$  amperes, then the battery is working at the rate of  $EI$  watts. This power may be all dissipated in resistances in the form of heat, or may be driving a motor, but whatever happens to it, the battery is delivering  $EI$  watts. In the case of an alternating current generator of  $E$  volts producing a current of  $I$  amperes the power delivered by the generator is  $EI$  times a constant called the power factor which depends upon what the generator is sending the current through. This constant is never greater than unity and will be less if there is anything in the circuit that does not absorb power, such as a condenser or an inductance.

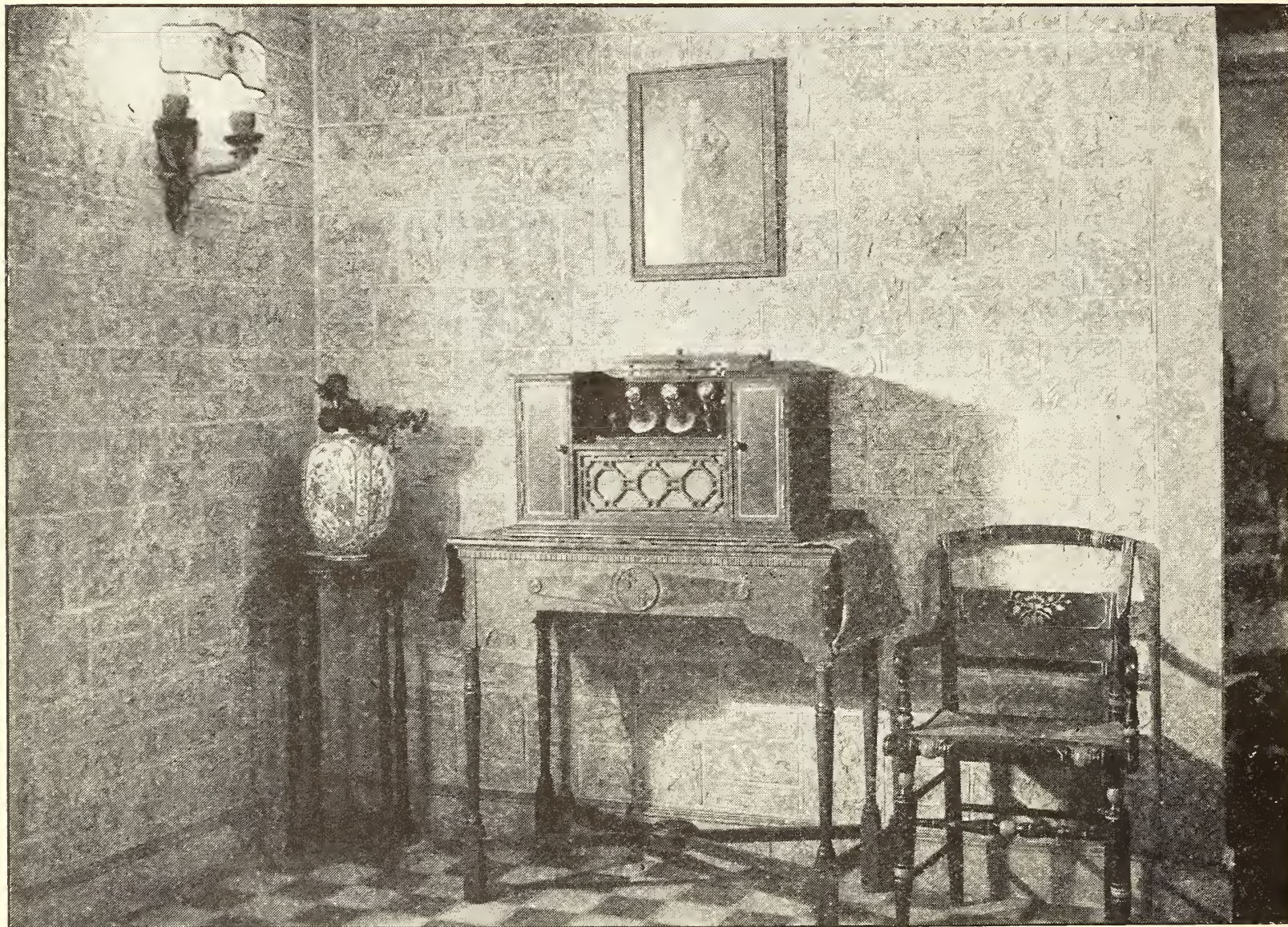

A BEAUTIFUL RECEIVER IN A BEAUTIFUL ROOM

It is a three-tube set with a loud speaker, built-in beneath the tuning panel. The A and B batteries are enclosed in the panels at either side. This set is made by the Colin B. Kennedy Company

# Supplemental List of Broadcasting Stations in the United States

LICENSED FROM DECEMBER 15 TO JANUARY 18, INCLUSIVE

CALL SIGNAL	STATION	FREQUENCY (Kilocycles)	WAVE-LENGTH	POWER WATTS
KFAE	Pullman, Wash.	908.6	330	500
KFMS	Duluth, Minn.	1090	275	100
KFMT	Minneapolis, Minn.	1300	231	5
KFMU	San Marcos, Texas.	1250	240	20
KFMY	Long Beach, Calif.	1310	229	20
KFMZ	Roswell, N. M.	1200	250	500
KFNC	Los Angeles, Calif.	1080	278	500
KFNG	Coldwater, Miss.	1180	254	10
KLX	Oakland, Cal.	589	509	500
WABW	Wooster, Ohio	1280	234	20
WABX	near Mt. Clemens, Mich.	1110	270	150
WABY	Philadelphia, Pa.	1240	242	50
WABZ	New Orleans, La.	1140	263	50
WBBE	Syracuse, N. Y.	1220	246	10
WBBF	Atlanta, Ga.	1110	270	500
WBBG	Mattapoisett, Mass.	1250	240	100
WBBH	Port Huron, Mich.	1220	246	50
WBBI	Indianapolis, Ind.	1280	234	20
WCBC	Ann Arbor, Mich.	1070	280	200
WFAT	Sioux Falls, S. Dak.	1160	258	50
WFMW	Houghton, Mich.	266	1130	50
WFMX	Northfield, Minn.	283	1060	500
WGV	New Orleans, La.	1240	242	100
WJAG	Norfolk, Nebraska	1060	283	250

## LIST OF BROADCASTING STATIONS DELETED NOVEMBER 1 TO JANUARY 1

CALL	STATION	CALL	STATION
KDYS	Great Falls, Mont.	WEAG	Edgewood, R. I.
KDZK	Reno, Nevada	WFAT	Sioux Falls, S. Dak.
KDZT	Seattle, Wash.	WGAR	Fort Smith, Ark.
KFAP	Butte, Mont.	WGAU	Wooster, Ohio
KFCL	San Antonio, Calif.	WHAC	Waterloo, Iowa.
KFDB	San Francisco, Cal.	WHAI	Davenport, Iowa
KFDP	Des Moines, Iowa.	WHAL	Lansing, Mich.
KFEP	Denver, Colorado	WHAQ	Washington, D. C.
KFFA	San Diego, Calif.	WHD	Morgantown, W. Va.
KFFP	Moberly, Mo.	WIAH	Newton, Iowa
KFGP	Cheney, Kansas	WIAT	Tarkio, Mo.
KFHQ	Los Gatos, Cal.	WKAS	Springfield, Mo.
KFHU	Mayville, N. D.	WKAX	Bridgeport, Conn.
KFIV	Pittsburgh, Kansas	WKC	Baltimore, Md.
KFJA	Grand Island, Neb.	WLAC	Raleigh, N. C.
KFJH	Selma, Cal.	WMH	Cincinnati, Ohio
KFJJ	Carrollton, Mo.	WNAM	Evansville, Ind.
KFJU	Kearney, Neb.	WOOA	Ardmore, Okla.
KLN	Monterey, Cal.	WOAK	Frankfort, Ky.
KNJ	Roswell, N. Mex.	WOAQ	Portsmouth Va.
KQI	Berkeley, Cal.	WOAZ	Stamford, Texas
WAAH	St. Paul, Minn.	WPAD	Chicago, Ill.
WABF	Mt. Vernon, Ill.	WPAR	Beloit, Kansas
WBBC	Sterling, Ill.	WQAR	Springfield, Mo.
WBU	Chicago, Ill.	WQAZ	Greensboro, N. C.
WCBB	Greenville, Ohio	WRAP	Winter Park, Fla.
WCR	Minneapolis, Minn.	WRAU	Amarillo, Texas
WDAD	Lindsborg, Kans.	WSAK	Middleport, Ohio
WDAI	Syracuse, New York	WSAP	New York, N. Y.
WDAL	Jacksonville, Fla.	WTAP	Carthage, Ill.
WDBF	Youngstown, Ohio	WWAX	Laredo, Texas
WDM	Washington, D. C.	WWB	Canton, Ohio
WDT	New York, N. Y.	WWZ	New York, N. Y.
WEAB	Fort Dodge, Iowa		

# The Grid

## QUESTIONS AND ANSWERS

The Grid is a Question and Answer Department maintained especially for the radio amateurs. Full answers will be given wherever possible. In answering questions, those of a like nature will be grouped together and answered by one article. Every effort will be made to keep the answers simple and direct, yet fully self-explanatory. Questions should be addressed to Editor, "The Grid," RADIO BROADCAST, Garden City, N. Y.

### ABOUT YOUR GRID LETTERS

Judging from the rapidly increasing demands made upon this section, it is performing a valuable service—but it is getting to be a very serious problem.

As a general rule replies to letters addressed to the GRID require the drawing of a diagram or two and a considerable amount of research. Similar service, if purchased elsewhere, would cost a very tidy sum. We are pleased to offer this service to our readers without charge but feel that it is up to our readers to cooperate with us to the extent of sending, with their requests for information, a self-addressed, stamped envelope. Unless our request is complied with the GRID will be unable to consider these inquiries.—THE EDITOR.

#### ADDING R. F. TO ANY RECEIVER

The Grid has received many requests concerning the adaptability of radio frequency amplification to the particular circuits used by the inquirers. The questions may be summed up in the following order:

1. Can R. F. be added to any existing circuit?
2. If it is possible, how should it be added to the variocoupler twin-variometer regenerative receiver? . . . to the three coil honey comb set?
3. How should it be added to the single circuit tuner?
4. Can additional stages be combined with sets already equipped with radio frequency amplification?

1. In general. There is no reason why radio frequency amplification cannot be added to any existing circuit. As usual, it is merely a matter of a principle of theory and easily mastered fundamental that can be applied to the majority of circuits with which our broad-

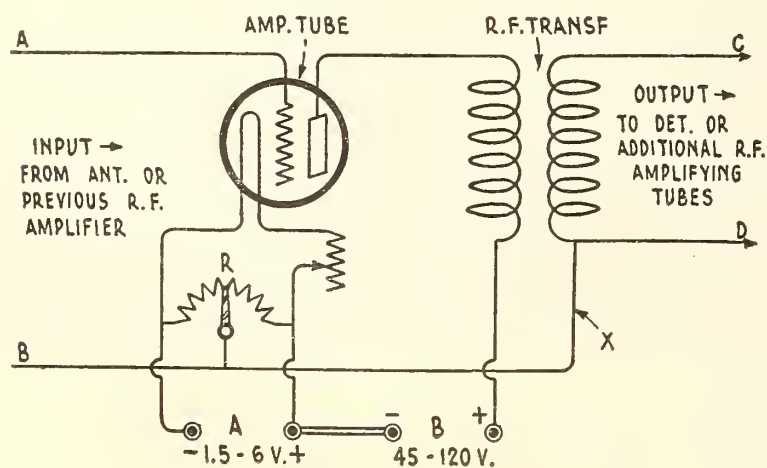

FIG. 1

What you need for an R. F. amplifier to use with any tube set except a single circuit regenerative outfit

cast enthusiasts are confronted.

The most easily understood system of R. F. amplification (as well as the most fully developed practically) is that employing the intervalve transformer coupling. THE GRID suggests that those readers for whom this article is written confine themselves to this form of R. F. intensification.

The amplifying unit in this case then consists of a single tube, the output of which flows through the primary of an R. F. transformer. Fig. 1 shows such a unit.

To R. F. amplify any circuit whatever, it is only necessary to include one (or more) of these units between the source that it is desired to amplify and the detecting circuit. In the majority of radio circuits, the unit, or units, will be placed between the antenna circuit and the detecting tube. Some means, either a tuning coil or a variocoupler, must be employed for transferring energy from the antenna to the first R. F. circuit. The former and more simple method is shown in Fig. 2, while Fig. 3 indicates the conventional detecting circuit. Fig. 2, 1, and 3, connected together in the order given, would result in a complete receiver comprising detector and one stage of radio frequency amplification.

In Fig. 2, L may be a double-slide tuning coil, or a coil wound with one hundred and five turns of about number

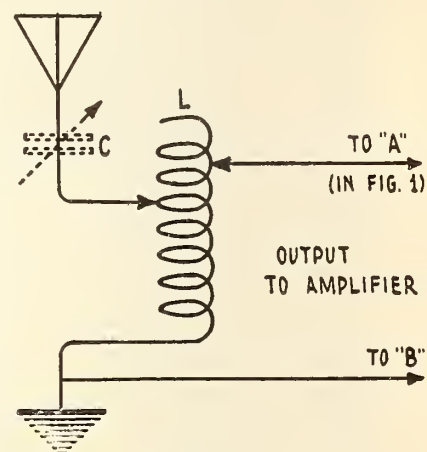

FIG. 2

The simplest means of coupling an antenna to the R. F. transformer unit. "L" may be a two-slide tuning coil or a winding of 105 turns of No. 22 DCC wire, tapped every seven turns, wound on a 3½" tube. If the tapped coil is used, a shunt condenser of .001 mf. is needed



A NEW



PRODUCT

The compact, panel mounted set is the established practice of to-day. It is no longer considered good design to construct a set that will operate over the entire commercial radio wave length range. The popular set is one designed particularly for broadcast reception. There are many circuits that may be used, and the enthusiastic radio man usually desires to try several at least.

Standard guaranteed parts designed particularly for the broadcasting band of wave lengths enable the experimenter to get the maximum results when new circuits are tried. The General Radio Company products with a decade of proven quality insure the results you desire.

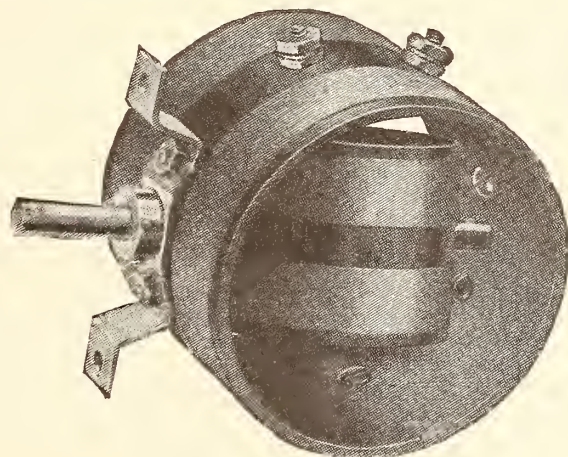

Type 268

## VARIO COUPLER

In order that General Radio products may be used throughout on your set, a new vario coupler has been designed. This instrument is compact, rugged, has low losses, and a wide wave length range. The forms are of bakelite, not a substitute compound, the bearings are tight and very smooth running. The stator is provided with a center tap. Like every other General Radio product it is fully guaranteed.

**PRICE . . . \$3.50**

*Send for Bulletin 917-B*

**GENERAL RADIO COMPANY** ★

Manufacturers of Electrical and Radio Laboratory Apparatus

MASSACHUSETTS AVENUE AND WINDSOR STREET

CAMBRIDGE

MASSACHUSETTS

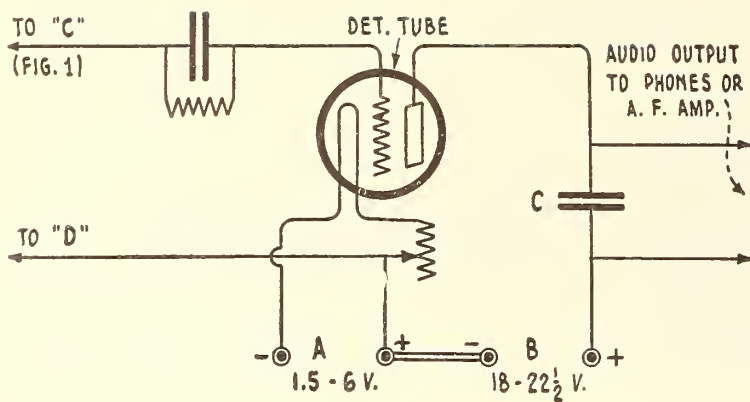

FIG. 3

The detecting circuit. By connecting leads shown in Figs. 2, 1, and 3 (in that order) you have a complete receiver—detector and one stage of R. F.

22 insulated wire on a three or three and a half inch tube. If this latter coil is used, it should be tapped every seven turns, and the antenna tuning condenser, C, of from .005 mfd. to .001 mfd. is desirable.

In Fig. 1, any standard R. F. transformer, such as advertised in RADIO BROADCAST may be used. R is a grid biasing potentiometer, generally of about four hundred ohms. The selection of the amplifying tube rests with the builder, but the GRID suggests either the UV-199 or the UV-201-A. The A and B batteries will of course vary with the tubes selected, and the reader is advised to use the voltages specified by the manufacturer of the tube he obtains.

The same A and B batteries may be used in Fig. 1 and 3. In Fig. 3, an adjustable tap, in the neighborhood of 22.5 volts, is taken from the common B battery. As explained in the preceding paragraph, the potentiometer R in Fig. 1, is employed to correct the grid bias on the amplifying tube or tubes. The resulting grid potential, favorable to R. F. amplification, however, may not be conducive to the most efficient detection, and the return from the grid of the detecting tube generally runs to the plus side of the A battery. For this reason, in making the indicated con-

nections between Figs. 1 and 3, the wire marked X, running from the secondary of the R. F. transformer to the arm of the potentiometer is broken, and the lead made directly to the plus side of the A battery as in Fig. 3. If the output lead of Fig. 1 runs to an additional stage of R. F., the connection, of course, is left as originally suggested in Fig. 1.

It is not practical to add more than three of these amplifying units to a receiver, and two stages of R. F. amplification generally gives very satisfactory results. One step is seldom sufficient.

2. The addition of R. F. to honeycomb and variometer regenerative receivers has been covered very completely in the Lab Department of this issue of RADIO BROADCAST. However, there is another method by which transformer-coupled radio frequency amplification can be combined with the variocoupler twin-variometer set, which utilizes the original antenna tuning equipment, rather than the extra tuning coil suggested by Mr. Sheehy. We refer to the arrangement shown in Fig. 4. The shaded portion of the diagram shows the parts carried over from the straight regenerative circuit. The unshaded lines indicate the required additions to effect two stages of radio frequency amplification. The various parts called for are identical with those designated in our previous paragraphs. The set, as shown in Fig. 4, employs a first stage of tuned amplification, with regeneration achieved by means of the variometer in the plate circuit of the detector.

3. There is no practical way of adding R. F. to the tickler regenerative single circuit tuner, without radically altering its form. The experimenter may either add an additional primary coil, transforming the circuit into the standard three coil tickler feed-back arrangement, to which amplification may be added according to the directions given in this month's Lab Department, or utilize the variocoupler as shown in Fig. 4.

It will, of course, be necessary to procure at least one variometer for tuning the secondary, and still another if regeneration is desired.

The Colpitts oscillator (the single circuit tuner employing a single antenna coil with a feed-back condenser, known by various names such as "The Flivver Circuit," the

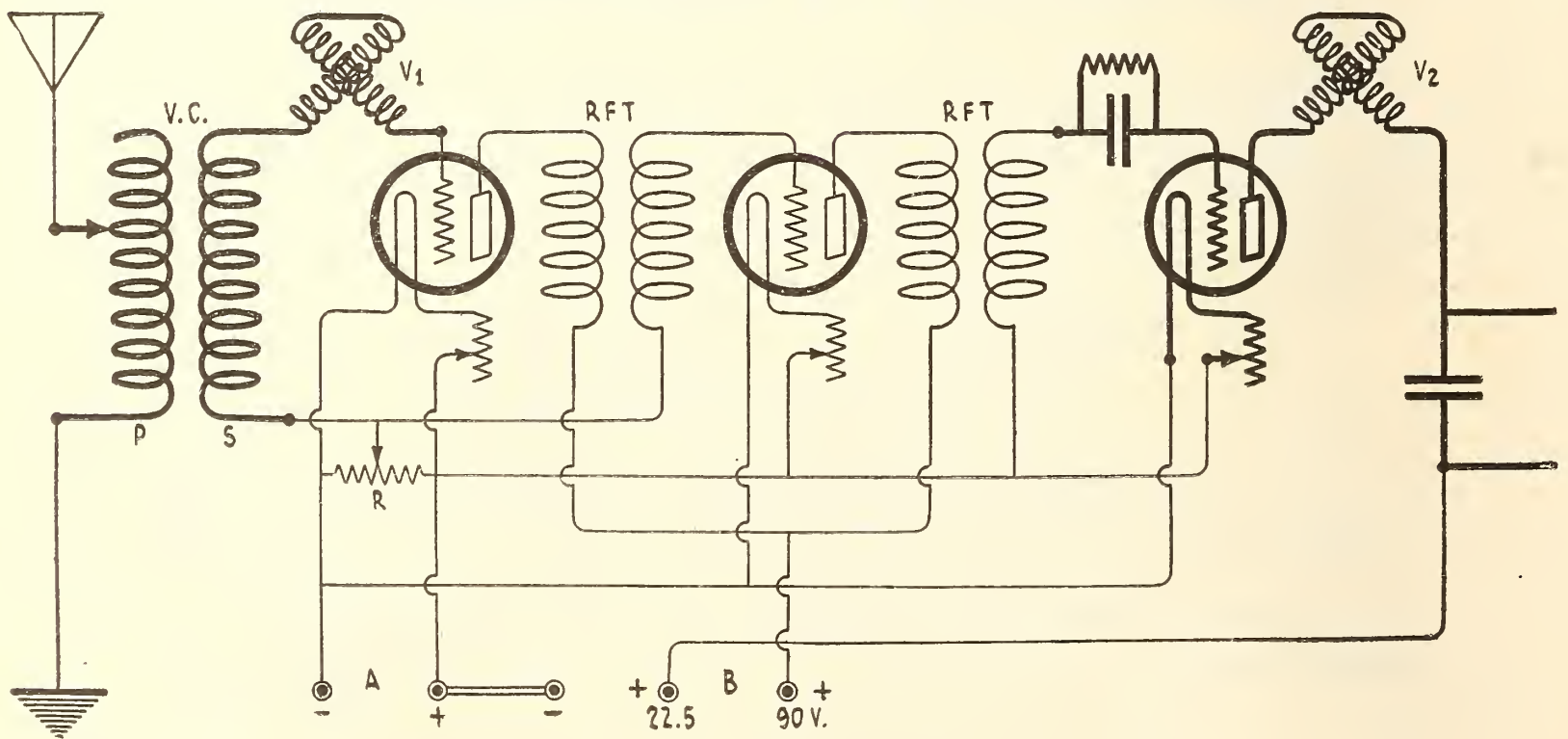
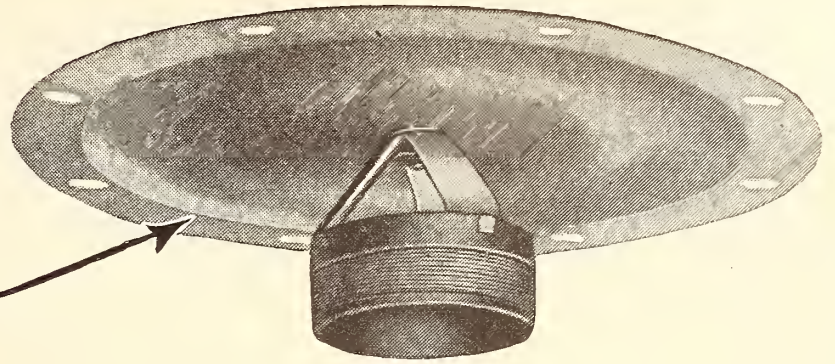
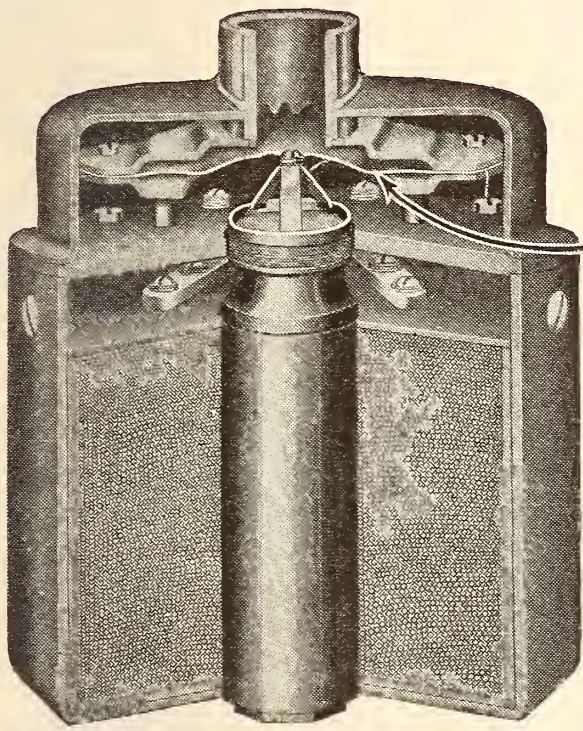

FIG. 4

Adding two stages of R. F. to a twin-variometer, variocoupler receiver. The shaded part of the diagram shows the original circuit and the lighter lines, the added R. F. unit.



THE illustration at left shows the interior construction of the Magnavox *electro-dynamic* Radio Reproducer, a type representing the greatest advance ever made in radio reproducing equipment.

The diaphragm (shown above) is of special interest, as explained in the body of this advertisement.

## MAGNAVOX— The true Radio Reproducer

THE basis of the operation of a Magnavox Reproducer is its diaphragm, the importance of which can be seen from the fact that it is required to render an almost human service in recreating every tone and quality of instrumental music as well as speech.

This diaphragm (as illustrated above) has been designed and constructed in accordance with entirely new principles. Its shape, size and special character make it capable of responding to the widest range of tones.

But even this highly efficient diaphragm might be handicapped by operating restrictions—every diaphragm must have a vibrating force applied to it, and the inherent ability of any diaphragm will be injured if it is affected by mechanical operation or other foreign influences.

The use of the electro-dynamic principle of operation (found only in Magnavox Reproducers) removes all objectionable influences. This principle, utilizing the famous “movable coil” permits the Magnavox diaphragm to respond in perfect unison to the original tone.

*There is a Magnavox for every receiving set: Type R for storage battery sets, and M1 for dry battery sets.*



A1-R—\$59.00

This instrument (Magnavox Combination Set) consists of Magnavox *electro-dynamic* Reproducer combined with a Magnavox Power Amplifier in one unit.

**THE MAGNAVOX COMPANY**  
Oakland, California

New York Office: 370 SEVENTH AVENUE  
PERKINS ELECTRIC LIMITED, Canadian Distributors  
Toronto, Montreal, Winnipeg



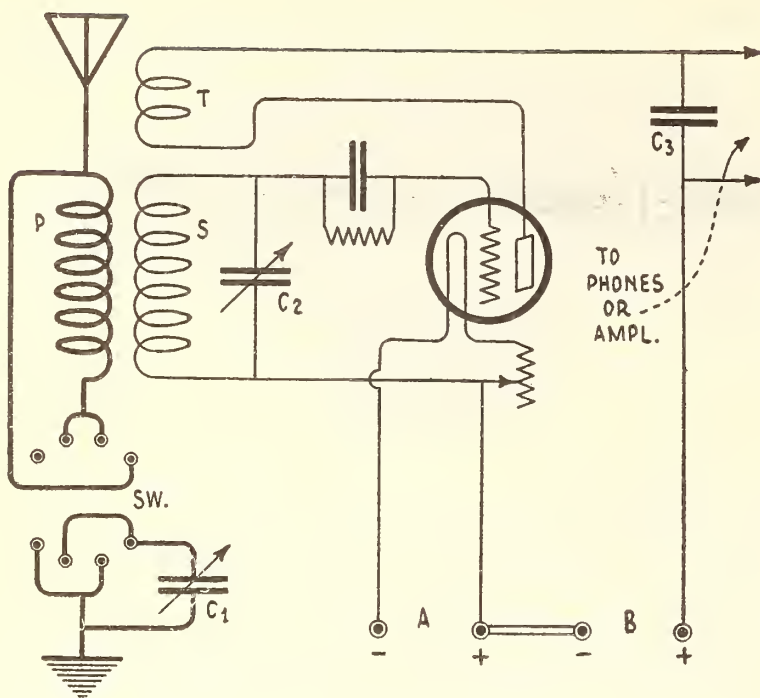

FIG. 5

The three-circuit regenerative receiver with honeycomb coils. The GRID recommends this as a standby set while experimenting with other circuits

“Automatic Regenerative” etc.) may also be made over into an R. F. set, and how to do this has been explained in THE GRID of the February RADIO BROADCAST.

4. As a rule, it is not advisable to add radio frequency amplification to a set already equipped with it. However, where the transformer coupled system has been used, the reader may, as an experiment, add another such stage as outlined in our opening paragraphs.

A STANDBY SET

*I have a standard three-circuit regenerative receiver, which is giving me excellent results. However, I have heard and read a great deal about the super-heterodyne receiver, and I desire to build one. Do you advise me to break up my present set, utilizing the parts as suggested by Mr. Eltz in his second “super” article?*

O. Y., Philadelphia, Pa.

**N**O, THE GRID suggests that you keep your present set intact, using it as a standby, while you experiment with the super-heterodyne, or any other circuit which your fancy prompts. And, moreover, we suggest that such of our readers whose chief radio delight is experimenting, and who divide their electric light bills between the upkeep of electric soldering iron and storage battery, supply themselves with such a standby set, preferably a three-coil honeycomb receiver, this type of set being the least likely to permit a sudden change of circuit.

The editor of THE GRID has experimented with many circuits, but there has never been a time when through the failure of some particularly outlandish circuit, or for the sake of comparison, a three-circuit regenerative receiver could not be thrown in by the turn of a switch.

The honeycomb set is, perhaps, even more trustworthy, for it responds to every wavelength on which wireless is transmitted—excepting those in the neighborhood of one hundred meters. Fig. 5 shows the circuit for this set.

The three honeycomb coils, which plug into the standard three coil mounting, are P, S and T (primary, secondary and tickler). SW is a series parallel switch, for throwing the primary condenser in those two positions, as well as shorting it on the middle position. C1 and C2 are 23-plate condensers, with or without vernier adjustment. C3 is the usual telephone shunt capacity.

B BATTERY TROUBLE

*I have a set which, three months ago, worked perfectly. However, it has recently developed unpleasant scratching noises, and the second stage of the amplifier howls. Do you think I need new B batteries?*

A. O. T., New York City

**W**HEN trouble of this nature develops after the B battery has seen considerable service, it should always be the first consideration as the possible source of the difficulty, particularly if the “unpleasant scratching noise” is audible on detector and on each step when tested separately. Worn out B batteries often cause such sounds. Howling can frequently be traced to weak B batteries.

However, if testing shows that the difficulty is confined only to one tube, the trouble is obviously more local. The experimenter may then test for broken transformer windings, dirty prongs on tubes or sockets, poor rheostat connections, etc.

A good 45-volt battery should give a fairly hot spark on a momentary short-circuit.

OSCILLATION OF AN R. F. AMPLIFIER

*Is there any way of stabilizing a radio frequency amplifier, other than by biasing the grids and neutrodyning? My amplifier oscillates very readily, and I have experienced little success using the two methods mentioned above.*

R. O. C., Hartford, Conn.

**T**HE neutrodyne is, of course, the most efficient method of stabilizing these circuits. It is, in effect, the ounce of prevention, as it neutralizes the capacity which is responsible for the regeneration and oscillation. Other systems are comparable to the pound of cure.

You might try including a resistance of about 3,000 ohms in the plate circuit of the bothersome tubes, i. e., place the resistances between the plates and the primaries of the transformers. Ballantine has found this method quite effective in stabilizing the circuit without reduction or distortion of signals.

The resistance should be non-inductive—that is, it should not act as a loading coil in the plate circuit. The best type of resistance would be in the form of a carbon rod of the correct ohmage. The experimenter might also wind the resistance on a small wooden bobbin, using 250 feet of No. 38 insulated German Silver wire. This wire, before winding, should be bent over in the middle, giving the effect of two strands, 125 feet long, connected at one end. The common end is fastened to the bobbin, and the coil wound with the two wires. This manner of winding will give the desired non-inductive effect.

RADIO BROADCAST will be pleased to hear from its readers who experiment with this method of stabilization.

# RODYNE

## Radio Receiver

NO OTHER RECEIVER  
CAN EQUAL

“THE ROLLS-ROYCE OF RECEPTION”



### MODEL "C" SUPER-HETERODYNE

Wavelength Range 160 to 850 meters. Tubes, 2 Detectors, Oscillator, 3 Tuned Radio Frequency Amplifiers, 2 Audio Amplifiers

The Super-Heterodyne is the most efficient method of short wave radio frequency amplification known. It is used extensively by the Commercial radio companies and various governments, when it is necessary to receive over extremely long distances without interference from near-by stations.

The remarkable results are due to the Super-Heterodyne action, which is briefly as follows: the incoming signal, which may be any wave from 160 to 850, is changed through the use of a local oscillator, to a wavelength of 10,000 meters. At this wavelength an exact duplicate of the original signal is amplified at radio frequency with the very highest efficiency possible, rectified and amplified at audio frequency.

During this change a very high degree of selectivity is secured, due to the amplifier, which is designed to pass nothing but 10,000 meters. Accordingly while there may be ten or more signals in the loop, only one will be received at a time, the one that the oscillator heterodynes through the amplifier.

and Two Sheets 27x21", Our Numbers 30141-145. \$2.00 Postpaid

*Designers of the Highest Class Radio Apparatus in the World*

476 Broadway

NEW YORK CITY

CATALOGUE No. 64.

# Here is the Man—Here is the Receiver

The amazing story of continued communication with the MacMillan Expedition, on the Steamer Bowdoin—frozen somewhere near the North Pole—and with other distant points is here told by Mr. Len Weeks, Radio 9 DKB, Minot, N. D.

December 30, 1923.

"I submit the following account of the use of the Ace Type 3 B and the Ace Type V radio receivers for DX work, especially with WNP.

"Using the Ace Type 3B or Type V have heard the schooner Bowdoin radio WNP a total of seventeen times during November and December. On thirteen of these occasions communication was established. Thirty-four messages totaling several thousand words were received from the Bowdoin, including a 1,500 word press dispatch, taken in 3 hours and 30 minutes. Twenty-two messages were sent to MacMillan and members of the crew. The greatest length of time between communications was nine days, of which four were spent away from the station. Signals were unusually readable and often uncomfortably loud on two steps.

"During the month of December Canadian 9BP, Jack Barnsley, has been on a vacation. During this time my station has been the main, but not the only, link between the North Greenland expedition and the United States. Most of the credit



for this is due to the fine control of regeneration and ease of adjustment on the Ace sets. Having a wave length range that completely covers the amateur band, it was easy to quickly shift wave length in order to avoid interference. "In addition to the above reception 7AHB in Alaska and 6CEU in Hawaii have been copied several times. Of course stations on both the east and west coast are heard every night. It is nothing unusual to copy stations from every district in a night's work. I have discarded a higher

priced, three circuit set, for I honestly believe that the ACE sets give greater receiving range both in miles and kilocycles."

January 5, 1924.

"Last night my second operator, Homer Stenson, a man comparatively inexperienced in amateur work, successfully established communication with WNP, giving him a message and getting an acknowledgment. Many people seem to think that the results are due to expert manipulation. This is not the case, for on several occasions I have had other amateurs listening for WNP while I took a much needed sleep. Nearly always they were able to pick him up and hold him till I got on the job."

The above communications are merely samples of the continued proofs, voluntarily sent to us, of the superiority of Crosley instruments. We believe that for bringing in distant stations they cannot be equaled. And the prices are Remarkably Low.

The ACE TYPE V—\$20.00

The ACE TYPE 3-B—\$50.00

*Write for Complete Catalogue*



## THE CROSLEY RADIO CORPORATION

Powel Crosley, Jr., President

*Formerly*

THE PRECISION EQUIPMENT COMPANY AND CROSLEY MANUFACTURING COMPANY  
320 Alfred Street

Cincinnati, Ohio

*The Ace Receivers mentioned above are now known as Crosley Receivers*

★ Tested and approved by RADIO BROADCAST ★

# The AFRICAN "Drum talk" of TODAY

**BOOM! BOOM! BOOM! BOOM!**

Thus the drum talk of the natives of Africa broadcasts to a radius of fifty or sixty miles the departure of white men leaving one village for another. To the weird Boom! Boom! of the huge drum, the travelers with their porters commence the perilous journey, knowing that their arrival is expected at the next village.

What a far cry this crude method of sending messages is from our modern, useful, pleasure-giving radio. And how very backward it seems when we consider the rapid strides made in the radio industry in just a few years time as exemplified by the Crosley story.

Three years ago Crosley Radio Receivers were unknown. Today, The Crosley Radio Corporation is the largest manufacturer of radio receivers in the world. In every part of the United States, happy users are enjoying the beautiful concerts, useful lectures and valuable news that Crosley instruments un-faillingly bring in from the distant points desired.

Real Merit at moderate prices has brought about this Crosley popularity. Crosley engineers have continually kept abreast and perhaps a little ahead of the rapid advancement that radio has made.

We Firmly Believe that Crosley Radio Receivers Are the Best that have Ever Been Offered to the Public.

*Insist upon Crosley Radio Apparatus  
For Sale by Good Dealers Everywhere*



*The Crosley Radio Corporation owns and  
operates Broadcasting Station WIW.*

## THE CROSLEY RADIO CORPORATION

**Powel Crosley, Jr. President**

*Formerly*

The Precision Equipment Co., and The Crosley Manufacturing Co.

320 Alfred St.

Cincinnati, Ohio

Following is a list of the Most Popular Crosley Receiving Sets with Their Prices.

- Crosley Type V (formerly Ace) One tube regenerative.....\$20.00
- Crosley Type 3 (formerly Ace) three tube regenerative.....\$50.00
- Crosley Type 3C (formerly Ace) Console Model \$125.00
- Crosley Model VI, two tube incorporating radio frequency.....\$30.00
- Crosley Model X-J, four tube, incorporating radio frequency.....\$65.00
- Crosley Model X-L, four tube Console.....\$140.00

The Crosley regenerative receivers formerly called Ace, listed above are licensed under the Armstrong U. S. Patent No. 1,113,149

**CROSLEY**  
Better - Cost Less  
Radio Products

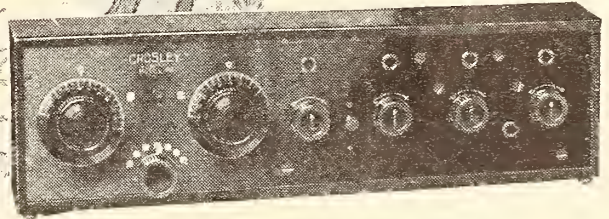

**CROSLEY MODEL X-J—PRICE \$65.00**

A 4-tube radio frequency set combining one stage of Tuned Radio Frequency Amplification, a Detector, and two stages of Audio Frequency Amplification. A jack to plug in on three tubes for head phones, the four tubes being otherwise connected to the loud speaker, new Crosley multistat, universal rheostats for all makes of tubes for dry cells or storage batteries, new condenser with molded plates, filament switch and other refinements add to its performance and beauty.

We believe that for bringing in distant stations it cannot be equalled.

Cost of necessary accessories from \$40.00 up.

MAIL THIS COUPON TO-DAY

**THE CROSLEY RADIO CORPORATION**  
320 Alfred Street, Cincinnati, Ohio

Gentlemen: Please mail me free of charge your complete catalogue of Crosley instruments and parts.

Name .....

Address .....

★ Tested and approved by RADIO BROADCAST ★

# For Only 10¢

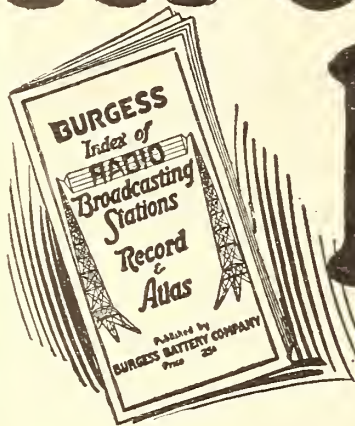

**T**HE Stations you hear—who are they? Where are they? Who operates them? What are their wave lengths?

This new Burgess Index of Broadcasting Stations, Record and Atlas answers those questions. It contains in part a revised list of every broadcasting station in America. There are maps of the United States, Canada and the World, together with accurate charts showing time divisions of the world.

**Keep A Record Of Every Station Tuned In**

Several pages of this booklet are devoted to space for a record of the stations you tune in, the date, call number, location, time, distance and dial positions.

**The Size Is Handy  
The Price Is Handy**

This booklet fits the pocket—takes up little table space and the information you want is easy to find. It only costs a dime. This forty-eight page Index and Atlas was compiled to sell for 25 cents but in keeping with our policy of furthering the interests of radio enthusiasts, we are glad to distribute these booklets at cost. We believe you will be glad you secured your copy.

**Mail this Coupon now**

Send us your dealer's name and ten cents and we will send your copy of the new Burgess Index of Broadcasting Stations, Record and Atlas at once.

**BURGESS BATTERY COMPANY, ★**  
110 Washington Street, Madison, Wisconsin

Enclosed is.....cents for which send me.....copies of the new Burgess Index and Broadcasting Stations.

Name .....

Street .....

City.....State.....

Dealer's Name .....

Street .....

City.....State.....

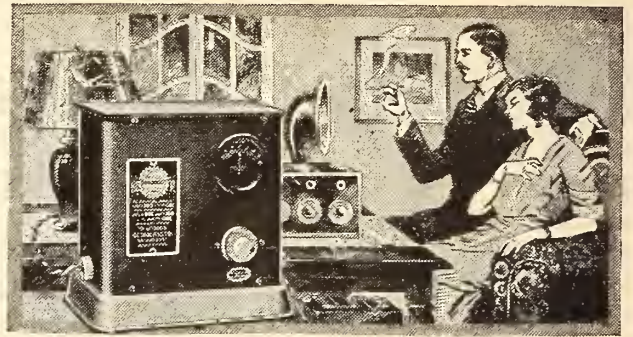

Charge Your Radio or Auto Battery at Home for a Nickel with the

**GOLD SEAL  
HOMCHARGER ★**

—the world's best as well as its most popular rectifier. Simple, dependable, practically silent and absolutely safe. Beautifully finished in mahogany and gold—an ornament for the finest living room.

**WHY PAY MORE—OR GET LESS?**

Why buy a 2 or 3-ampere rectifier without ammeter requiring from 40 to 50 hours to charge your battery and costing twice as much to operate when, for the same price, you can secure the genuine 5-ampere GOLD SEAL HOMCHARGER which does a better job in one-third the time and at half the cost? Fitted with high grade ammeter (eliminating guesswork) charging cable and battery clips—no extras to buy. For sale by all good dealers; \$18.50. (\$25.00 in Canada).

**INSIST ON THE GOLD SEAL**

It's your guarantee against substitution and appears on name-plate and package. No other charger is just as good.



**RADIO FANS ATTENTION!**

**FREE** Ask your dealer or send direct for free HOMCHARGER list of broadcasting stations and GOLD SEAL bulletin.

**The Automatic Electrical Devices Co.**  
128 West Third Street Cincinnati, Ohio  
Largest Manufacturers of Vibrating Rectifiers in the world

**CARTER JACK SWITCH**



Compact—durable—mounts like jack; heavy phosphor-bronze springs—silver contacts. Westinghouse "Micarta" insulation. Furnished complete with "On and Off" Name Plate, Knob and Pointer. Made in four styles. Write for catalogue of complete line of Carter Quality Radio Products, including special hook-up for Jack-Switches.

**Carter Radio Co. ★**  
1806 REPUBLIC BUILDING  
CHICAGO



HOW TO GO ABOUT BUYING A SET

APRIL 1924 **RADIO** 25 CENTS  
**BROADCAST**

Why You Should Have a Wavemeter

A Knock-Out Two-Tube Set

The Listener's Point of View

“C Q D”





# Look for the name on the carton

**Insist on Cunningham Radio Tubes—there is no higher Quality**

THE primary purpose of a trade name is to identify a product or firm in the mind of the buyer. Ask the next Radio enthusiast you meet to state one of the best known names identified with Radio and he will say: "Cunningham."

The presence of the word "Cunningham" on Radio Tubes tells the character and quality of this product—the ideals, engineering skill and service given to the Radio field since the year 1915 by E.T. Cunningham, Inc. It is the radio tube that has made possible the broad and far reaching application of radio telephony, and that plays the most important part

in the operation of your Radio Receiving Set. Cunningham Radio Tubes, standard for all makes of receiving sets, built by one of the world's largest manufacturers with unlimited resources, are the product of years of manufacturing experience and the creative genius of the engineers of the great scientific organization, the research Laboratory of the General Electric Co.

**Patent Notices** Cunningham tubes are covered by patents dated 2-18-08 and others issued and pending. Licensed for amateur, experimental and entertainment use in radio communication. Any other use will be an infringement.

**New Prices on CUNNINGHAM TUBES Now in Effect**

- C-301A—5 Volts 1-4 Ampere filament. . . . . \$5.00
- C-299—3 Volts .06 Amp. Dry Battery Det. and Amp. . . . . \$5.00
- C-300—5 Volts Gas Content Detector . . . . . \$5.00
- C-11—1.1 Volts .25 amp. Dry Battery Det. and Amp. Special Base. . . . . \$5.00
- C-12—Similar to C-11 with standard base. . . . . \$5.00

*The care and operation of each model of Receiving Tube is fully explained in our new 40-page "Radio Tube Data Book." Copies may be obtained by sending ten cents to our San Francisco office.*

*E.T. Cunningham Inc.*

**HOME OFFICE**  
182 Second Street  
SAN FRANCISCO

154 W. Lake Street  
CHICAGO

30 Church Street  
NEW YORK

# An Easy Way to Cut Out Interference

Add a Ferbend  
Wave Trap  
to Your Set

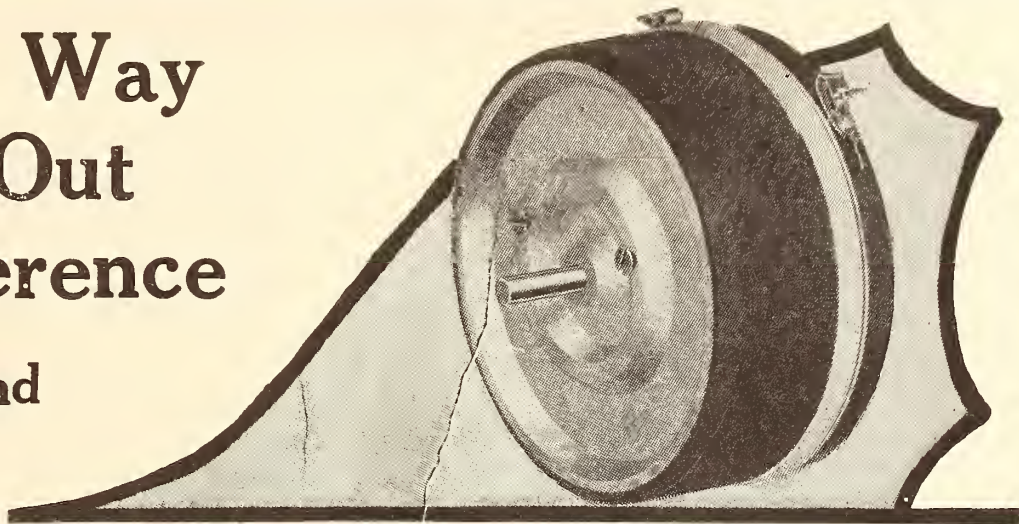

## WHY LISTEN TO THREE STATIONS AT A TIME?

Why rebuild and enlarge your set to the last pitch of refinement just to get better selectivity, when you can get a Wave Trap which, connected by two wires to your old set, will TRAP OUT the powerful waves from the interfering station, and leave the voice you want to hear just as "clear as a bell"? The Ferbend is the Original Wave Trap, designed and manufactured complete by us, after years of careful experimenting. Do not confuse it with imitations, hastily assembled from ordinary radio parts.

## THIS MAN TAKES HIS CHOICE WHY DON'T YOU?

FERBEND ELECTRIC Co.  
19 E. South Water St.,  
Chicago

I have installed the WAVE TRAP I purchased from you sometime ago and given it a thorough tryout. There are five broadcasting stations in this city, four of them I can trap out by moving dial ten points, the other, KFI, the most powerful one, I can silence by changing the dial twenty points. This station is heard on the Atlantic coast and Hawaiian Islands.

JOHN F. PARSONS  
109 N. Avenue 19,  
Los Angeles, Calif.

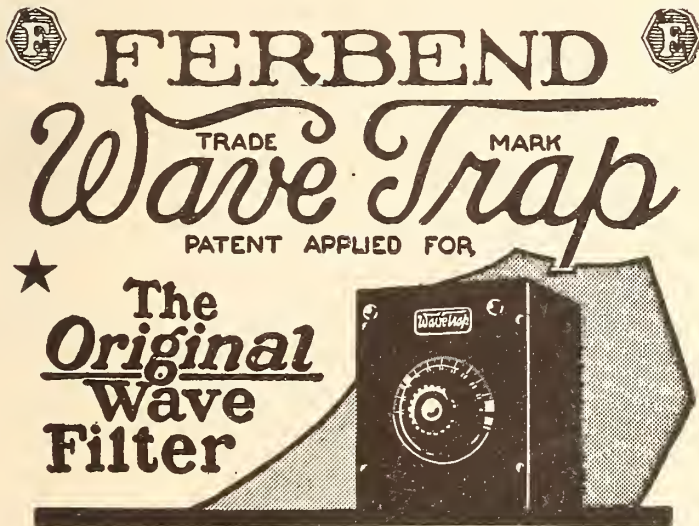

### GUARANTEE

Every FERBEND WAVE TRAP is warranted to be of best materials, designed and manufactured complete by the Ferbend Electric Co. (not assembled from stock radio parts). When connected to any workable radio receiving set, and properly adjusted, according to directions, we guarantee that any interfering broadcasting station can be tuned out, while the station desired continues to be heard as before.

## Use this coupon

—to double  
the pleasure  
from your  
RADIO  
SET

**Ferbend Electric Co., 19 E. South Water St., Chicago**

You may send me a FERBEND WAVE TRAP, subject to your definite guarantee as printed at the left. I will pay the price which I have marked to the postman when he delivers the Wave Trap to me, and will also pay him the postage. (If remittance is sent with the coupon, then the SAME EITHER WAY.) **THE POSITIVE GUARANTEE APPLIES JUST THE**

Check here for  
Ferbend Wave Trap,  
UNMOUNTED \$6.00

Check here for  
Ferbend Wave Trap,  
MOUNTED \$8.50

Check here for  
"Send Me Full  
Information."

Name \_\_\_\_\_  
Street \_\_\_\_\_  
City \_\_\_\_\_  
State \_\_\_\_\_

# Radio Broadcast

ARTHUR H. LYNCH, EDITOR

APRIL, 1924

COVER - - - - -	<i>From a Painting by H. A. Weiss</i>	
LOUIS ALAN HAZELTINE - - - - -	<i>Frontispiece</i>	
"C Q D" - - - - -	<i>Alfred M. Caddell</i>	449
A KNOCK-OUT TWO-TUBE SET - - - - -	<i>Walter Van B. Roberts</i>	456
MAN-MADE STATIC - - - - -	<i>A. F. Van Dyck</i>	461
A POWER COMPANY CUTS OUT "STATIC" - - - - -	<i>Earl C. McCain</i>	466
THE MARCH OF RADIO - - - - -	<i>J. H. M.</i>	468
THE LISTENER'S POINT OF VIEW - - - - -	<i>Jennie Irene Mix</i>	475
WHY YOU SHOULD HAVE A WAVEMETER - - - - -	<i>George J. Eltz, Jr.</i>	480
IN THE R. B. LAB. - - - - -		488
The Sodian Tube and Our "Knock-Out" Reflex	The Measurement of Radio Frequency Voltage	
The Portable Set and the Automobile	and Testing of Radio Frequency Transformers	
Hanging Your Antenna to Trees	Building Your Own Lab.	
Making Transformers for the Super-Heterodyne	How to Use the Super-Heterodyne on 100 Meters	
HOW TO MAKE A ONE-TUBE REFLEX SET THAT'S A "KNOCK-OUT" - - - - -		496
WHY SOME APPLICANTS FOR OPERATORS' LICENSES FAIL - - - - -	<i>Howard S. Pyle</i>	507
A BEGINNER'S C. W. TRANSMITTER - - - - -	<i>Zeb Bouck</i>	513
ADDITIONAL BROADCASTING STATIONS IN THE UNITED STATES - - - - -		519
HOW TO GO ABOUT BUYING A SET - - - - -	<i>William H. Cary, Jr.</i>	520
WHY RADIO WAVES TRAVEL—AND HOW - - - - -	<i>Walter Van B. Roberts</i>	524
WHAT OUR READERS WRITE US - - - - -		528
THE GRID - - - - -		532
Regeneration and Squealing	The "Super" and the Special Transformer	
Tuning the Single Circuit Tuner	Condenser Plates and Capacities	
Use Grid Bias Only When Necessary	Oscillator Dial Settings on the Haynes "Super"	
The Knock-Out Reflex on 200 Meters	Series-Parallel Connection for Dry Cells	
Making Reflex Sets Selective		
PRIZE CONTEST ANNOUNCEMENT - - - - -		536
AMONG OUR AUTHORS - - - - -		538

Copyright, 1924, by Doubleday, Page & Co. All rights reserved

TERMS: \$3.00 a year; single copies 25 cents

F. N. DOUBLEDAY, Pres.

RUSSELL DOUBLEDAY, Sec'y.

ARTHUR W. PAGE, Vice-Pres.

S. A. EVERITT, Treas.

NELSON DOUBLEDAY, Vice-Pres.

JOHN J. HESSIAN, Asst. Treas.

DOUBLEDAY, PAGE & CO.

THE WORLD'S WORK

COUNTRY LIFE

THE GARDEN MAGAZINE

SHORT STORIES

EDUCATIONAL REVIEW

CHICAGO: People's Gas Bldg.

GARDEN CITY, N. Y.

NEW YORK: 120 W. 32nd Street

BOSTON: Tremont Bldg.

LOS ANGELES: Van Nuys Bldg.

# There's a Radiola for every purse

New and Revolutionary Radio Achievements in the new Radiolas

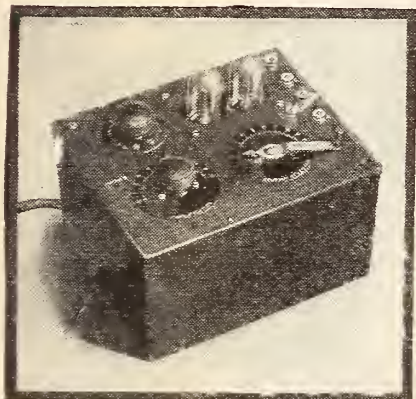

**Radiola III**, an improved two tube receiver of antenna type, sensitive and selective. Complete with two WD-11 Radiotrons and headphones (everything except batteries and antenna) . . . \$35.

**Radiola III-a**, which is Radiola III and its balanced amplifier complete in one cabinet; including four WD-11 Radiotrons, headphones, and Radiola Loudspeaker (either type FH or UZ 1320.) Everything except antenna and batteries . . . \$100

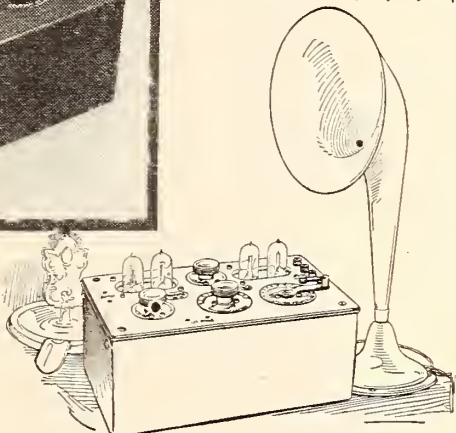

**Radiola X**—selective and non-radiating. Remarkable for distance reception. Built-in type loudspeaker. Complete with four WD-11 Radiotrons—everything except batteries and antenna.

\$245.

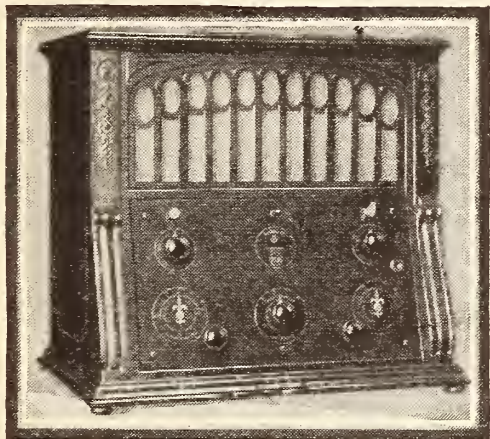

This symbol of quality is your protection.

**Radiola Super-VIII**—an improved Super-Heterodyne. Selective and non-radiating. With no antenna, and no ground connection, it receives far distant stations, even while local ones are operating. Loudspeaker built in. Complete with six UV-199 Radiotrons—everything except batteries . . . \$425.

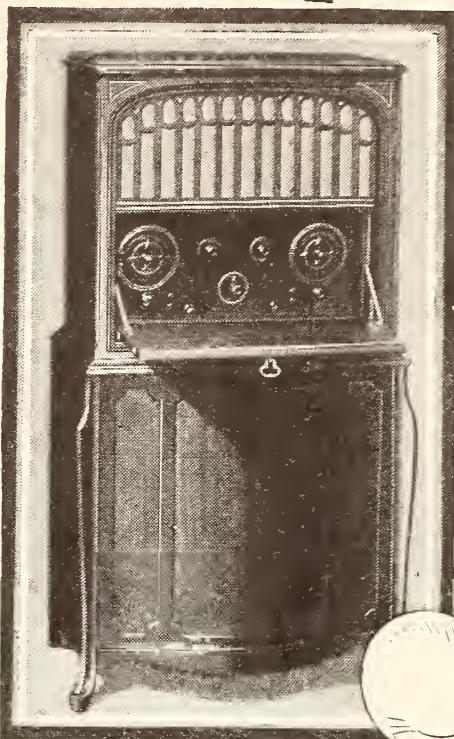

**Radiola Super-Heterodyne**, same as Super VIII but semi-portable in mahogany finished cabinet, with Radiola Loudspeaker. With six UV199 Radiotrons, but without batteries . . . \$286. Same as above, but without Radiotrons or Loudspeaker . . . \$220.

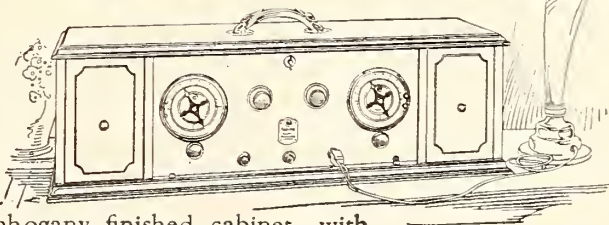

**Radiola Regenflex**, a modified Radiola X. With four WD-11 Radiotrons and Radiola Loudspeaker but less batteries and antenna . \$206. Same as above, but without Radiotrons and Loudspeaker \$150

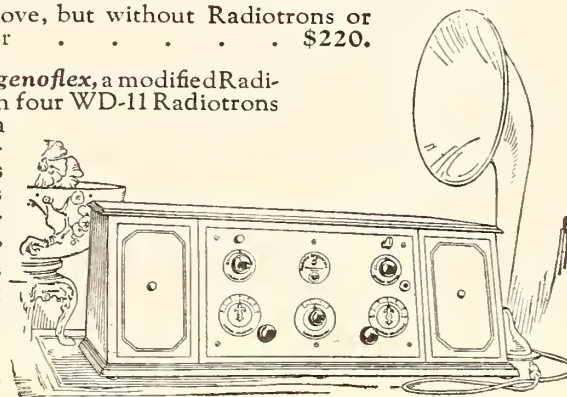

Radio Corporation of America

233 Broadway  
New York

Sales Offices  
10 So. LaSalle Street  
Chicago, Illinois

433 California Street  
San Francisco, California

Send this coupon for an illustrated booklet that tells the story completely, with detailed description of every set.

# Radiola

REG. U. S. PAT. OFF.

RADIO CORPORATION OF AMERICA  
Dept. 34 (Address office nearest you.)  
Please send me your free Radio Booklet.

Name \_\_\_\_\_

Street Address \_\_\_\_\_

City \_\_\_\_\_

State \_\_\_\_\_

★ Tested and approved by RADIO BROADCAST ★

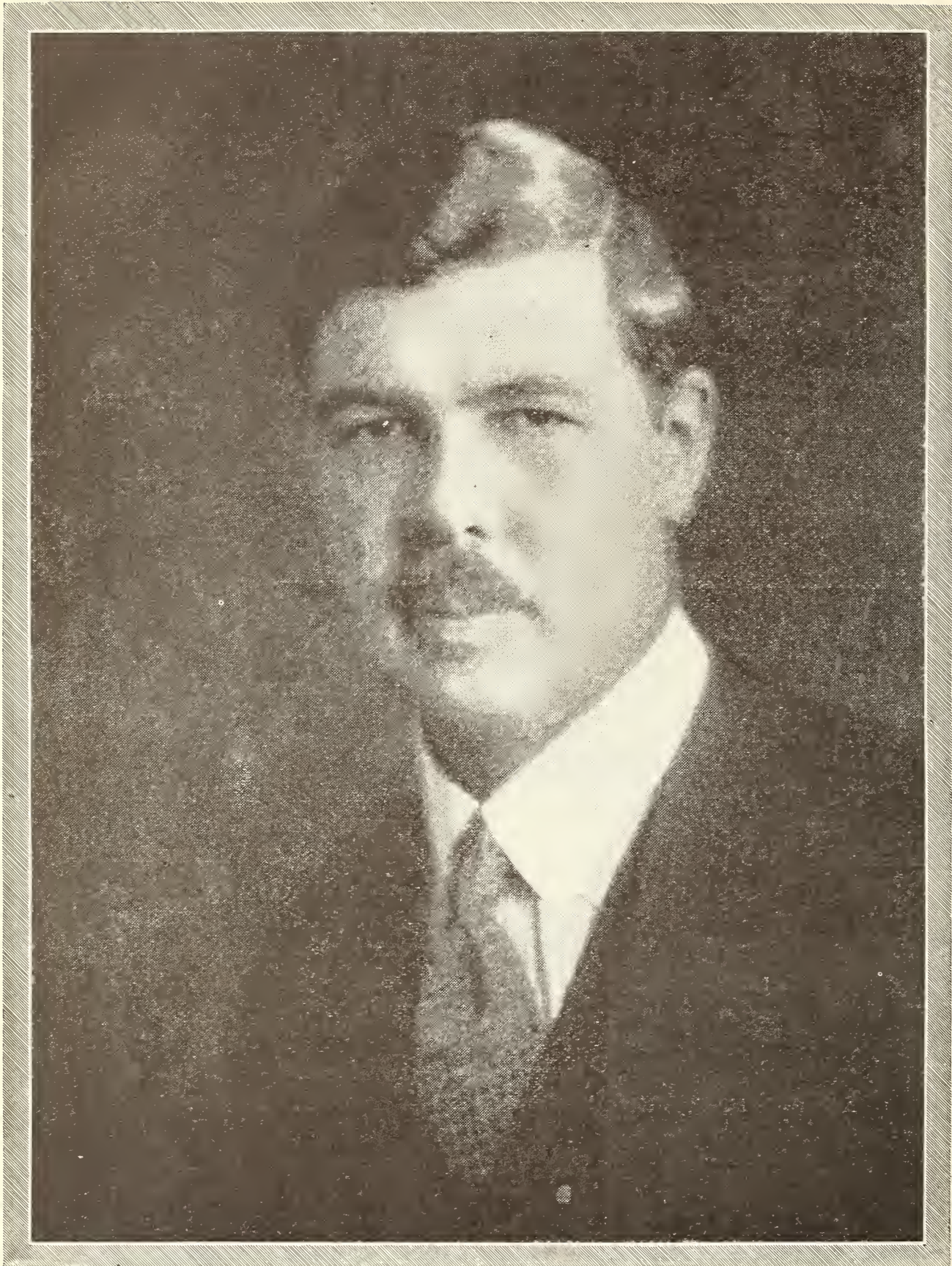

© Bachrach

LOUIS ALAN HAZELTINE

Who patented the neutrodyne circuit. He is Professor and head of the Department of Electrical Engineering at Stevens Institute of Technology at Hoboken, New Jersey

# RADIO BROADCAST

Vol. 4 No. 6



April, 1924

## C Q D

The Story of the First Sea Rescue by Radio as Told by Jack Binns Who Became a Radio Hero in the Old Days when Radio Was Wireless and a Ten-Inch Spark Coil and a Magnetic Detector Was the Ultimate in Apparatus

By ALFRED M. CADDELL

Serious accidents on passenger liners at sea are rare enough these days. Just stop for a moment and see if you can remember when the last great disaster at sea occurred. The war years should not be counted, for the sinking of the *Lusitania*, for example, was not due to faulty navigation or the luck o' the sea.

The fact is that radio has so aided navigation that real accidents simply don't happen. Every big vessel is in constant touch with both shores of the ocean during the entire passage, the ship's chronometers are corrected twice daily by radio time signals, and the radio compass guides the big ships in time of fog or heavy weather. The shore radio compass is available on almost every coast for every ship, small or large.

We have grown to take radio almost for granted, as far as its use in marine telegraphy goes. The public expects great things of the radio now—and isn't disappointed. But it was not so long ago that the radio waves had to prove their usefulness. Then, even the big ships boasted but one operator who could be at his set only a part of the day. Sets would not send very far, and the apparatus was not too dependable. The public, if it gave much consideration to radio at all, was somewhat skeptical.

But when radio saved the lives of thousands at sea in January, 1909, when Jack Binns at the key of the *Republic*, sent out distress calls which gave him the aid of the land station nearest him and the many ships around the scene of the disaster, Americans began to feel that maybe this radio thing had something to it after all.

Jack Binns has given me this fascinating story of the *Republic* himself, exactly as it happened.—A. M. C.

**I**T WAS four o'clock Saturday morning, January 23, 1909. The steamship *Republic*, in command of Captain Inman Sealby, had left New York for Liverpool at five o'clock the evening before, with 1,600 passengers on board. Jack Binns was the one wireless operator on the ship. Almost immediately upon clearing Sandy Hook the ship had run into a thick fog bank, and the automatic fog-horn was set going. Binns was kept busy at the key until midnight, sending and receiving commercial messages, and exchanging "location" reports with other ships and stations on shore. And then he turned into his bunk for the night.

Like all ship operators Binns went to sleep with a more or less alert mind. All went well until eight bells, and then——

Awakened by the sudden change in the fog signals, Binns sat upright on the edge of his bunk, and listened. One second, two seconds, three——

A tremor ran throughout the ship. There was terrific crashing. Rushing from his bunk into the operating room which was situated on the aft-port side of the ship, he peered out through the darkness.

Crumpled up like the bellows of a concertina, the lower part of the colliding ship's

bow had hit the *Republic* full and square in her engine room compartment while the upper part, plowing its way through the cabins on the deck, hung over it, a menacing mountain of twisted steel. The roof of the wireless cabin collapsed; part of the cabin itself was wrenched away.

A strong current was running, swinging the colliding ship and the *Republic* around and twisting her davits, stanchions and beams. The telephone between the wireless cabin and the bridge was destroyed. At a glance—it all happened at once, it seemed—Binns took in the situation. He was standing between life and death. Unlike many others on the ship his intelligence was not numbed. He got into action.

Was his wireless set in working order? Was the antenna intact?

“The system we used at that time enabled me to find out very quickly,” said Mr. Binns, when the writer interviewed him in his office at the *New York Tribune*. “I had a transmitting apparatus consisting of a ten-inch spark coil which was run from the ship’s lighting mains and could be used either for untuned sending at

the natural period of the aerial or with a tuned circuit which was an inductance and condenser of Leyden jars. On the other hand, my receiving equipment consisted of a magnetic detector with a Franklin tuner which was one of the new pieces of apparatus of that day. But, judged from present standards, that tuner was very crude.

“We were transmitting with what is known as plain antenna, and unless the antenna was up and thoroughly insulated, it was impossible to get a spark. I had just time enough to work the key and find out that the antenna was still up when the lights went out. All the machinery of the ship, including the generators, had been almost immediately put out of commission.

“I had jumped to the key immediately—I think that not more than three seconds had elapsed since the vessel had struck us. Although I had a vague idea what had happened, I didn’t know the exact details. What I did know was enough. As the vessels were swung around by the current I saw my cabin being ripped away.

“When the ship’s lighting current went off,



THE “REPUBLIC”

Which was the scene of the radio drama in which Jack Binns was the chief actor one exciting day in January, 1909



I changed over to our storage batteries for transmission power. We carried these batteries as an emergency reserve. When we used the batteries to operate the spark coils, our range was limited to approximately sixty miles. It was still dark and foggy. The air was biting cold. I put on as many clothes as I could find, bundled an overcoat around me, and began sending out CQD, which at that time was the distress call.

C Q D

THERE was little on the air at that time of the night. We were, as I found out later, about sixty miles away from the Siasconsett station on Nantucket Island, just on the verge of communication with the shore and that was all. It seems that Jack Irwin, the man on watch at Siasconsett, had had a very quiet night and had dozed off to sleep. As a result his fire had died down and presently he

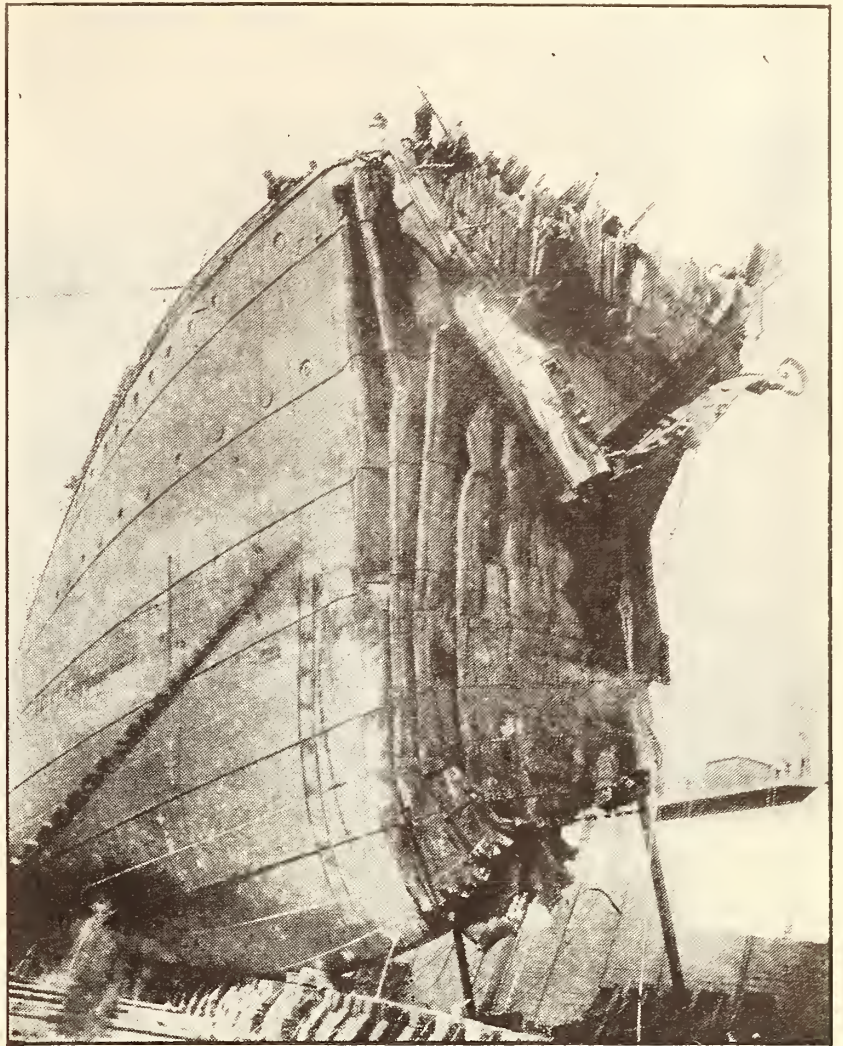

#### WHAT HAPPENED TO THE "FLORIDA"

This is all that remained of her bow after the collision. This photograph was taken in a Brooklyn dock

began to feel uncomfortably cold. He woke up with a start so suddenly, in fact, that he became wide awake. He was just in the act of putting on more coal when he heard my call. He dropped the coal, jumped over to the key and replied instantly. I told him we were in distress, that two vessels were in distress, that I did not know at that moment where we were, nor the extent of the damage to either one of us, but told him I would get the information from the bridge as rapidly as possible, and asked him to keep everybody off the air until I could get the information through. However, I had no sooner sent this message, than I received word from Captain Sealby, giving the damage done by the collision and the position of the ship. When I conveyed this message to Siasconsett, Irwin immediately sent out a general distress call. The steamship *Baltic* of the White Star Line was the first to answer the call.

"During this time we were drifting. The captain had absolutely no control of the ship. We had found the vessel which struck us, and learned that it was the Italian steamship *Florida* with immigrants bound for New



JACK BINNS

Photographed in 1908 in his uniform of an English Marconi ship operator

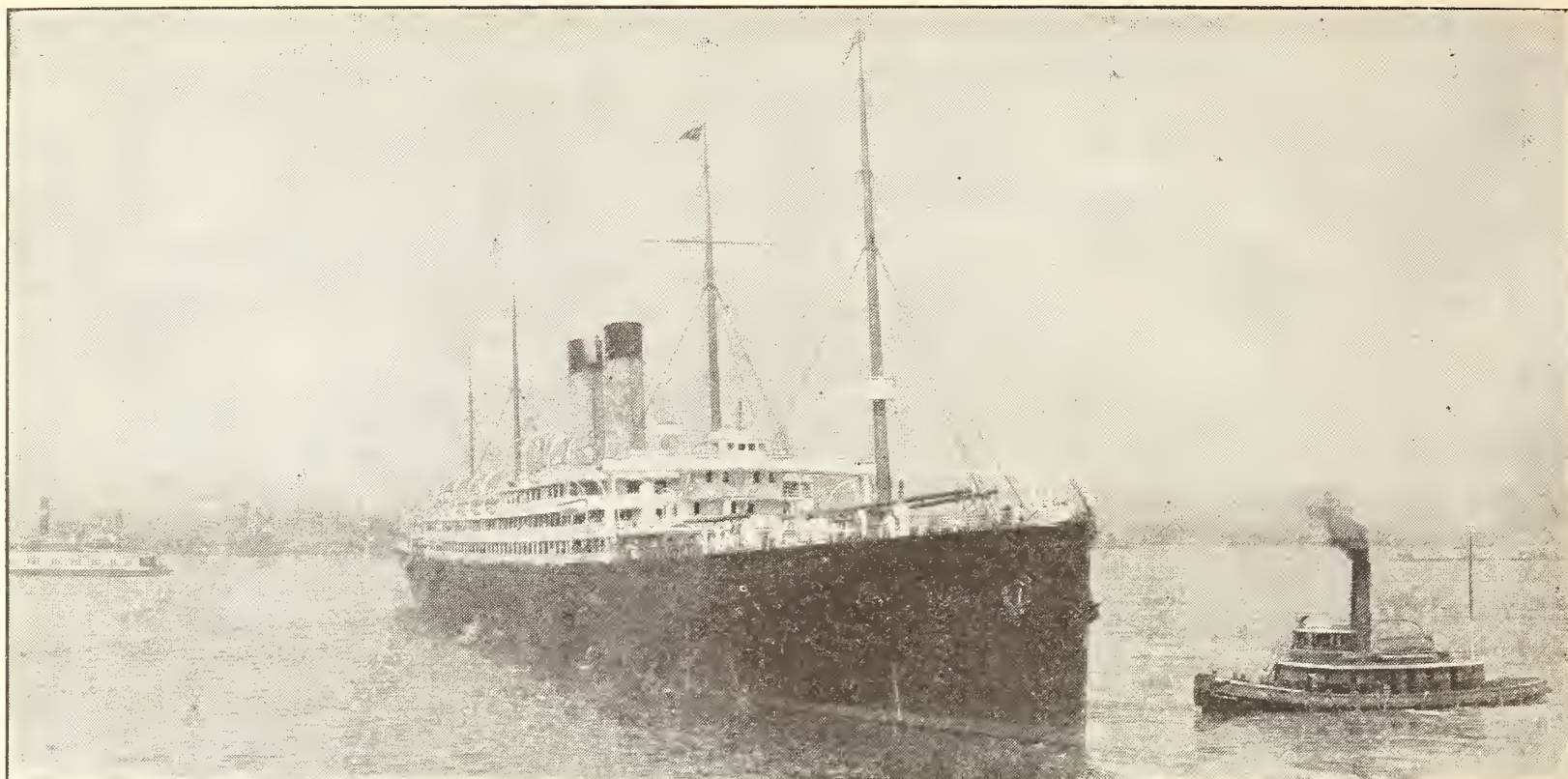

THE "BAL TIC"

Which aided in the first radio rescue

York. She had not suffered as much as the *Republic*, and it was decided to put all of our passengers and crew on board her. Her engines were undamaged and the ship was controllable. But transferring the passengers from the *Republic* was not an easy task, for the *Florida* was a very small ship and had nearly 2,000 passengers on board, the majority of them being refugees from the earthquake at Messina, in Italy. The captain of the Italian ship, a young man by name of Ruspini, handled the situation from his end with a surprising degree of coolness.

"About noon of that day—which was Saturday—the *Baltic* was within ten miles of the *Republic*. I could tell by the strength of her signals, although at that time we had no means of knowing definitely how far away any particular station or ship was, and I had to rely on the sensitiveness of my ears to arrive at that conclusion.

#### EIGHTEEN HOURS CONSTANT DUTY AT THE KEY

THE fog had, if anything, grown worse than it was at 4.00 o'clock that morning—and of course the *Baltic* had to reduce speed for fear of running into us before she could check her speed. From twelve o'clock until six in the afternoon I remained constantly at the key trying, in conjunction with the officers of both ships, to get the *Baltic* alongside. To accomplish this we exploded detonating bombs

and fired sky rockets. When one ship exploded bombs, the officers on the other would try to learn approximately the direction from which the sound came. We were doing this all afternoon on both ships, but although we were within an approximate radius of ten miles of each other, none of the explosions had been heard.

"Six o'clock came and it was still foggy and dark. Presently we had reduced the number of our bombs to where each of us had only one left. According to our soundings, we were aware that the *Republic* had been sinking steadily at a rate of about one foot an hour. Unlike the sound of the voice or other noise, wireless of course was not directional, and inasmuch as we had no electrical means of determining the exact location of each other we might just as well have been a thousand miles apart.

"At this point we checked up, carefully with each other the time on our chronometers. Each ship carried three chronometers, the mean average of which was taken as the accurate time. As soon as we had checked up on that it was decided that the *Republic* should fire her last bomb at a certain precise second, and they would listen very attentively to hear it. That second arrived, and Boom! went the bomb. But it proved in vain—they did not hear it. It looked like a forlorn hope. The *Republic* was gradually sinking, night had come upon

us, the *Florida* was floating somewhere in the neighborhood fearfully crowded with four thousand passengers and crew aboard that small ship. What were we to do?

"We made arrangements for the *Baltic* to explode her last bomb, and then I went forward on the bridge. By this time there were only eight on board the *Republic*. We had plenty of time, so seven of us formed ourselves in a circle with our faces outward while the quartermaster stood by the chronometer. He was to indicate to us by moving his arm upward the exact second the explosion of the last *Baltic* bomb was to take place. He raised his arm and—we listened.

"An operator's sense of hearing undoubtedly becomes more acute than another person's because of his constant training in straining his ears for faint code signals. Somehow or other, within about five seconds after the quartermaster had raised his arm, I heard very faintly what I thought might be the sound of a bomb. I turned to the third officer who stood next to me and he said he thought he had heard it too, although he wasn't exactly sure. It had been prearranged that none of us were to move in case we heard the sound, this in order that we could check the direction and get our bearings on the *Baltic*. Consequently, the officers took a bearing on the direction the sound came from, according to the third officer's and my own sense of hearing, and then I went back to the operating cabin to transmit steering directions to the *Baltic*, based on those bearings. We cautioned them to come very slowly because of our helplessness.

"Had we really heard the *Baltic's* last bomb? Were the steering directions I had just transmitted going to bring her alongside? Those were tense moments.

"In about fifteen minutes we heard the fog horn of the *Baltic*. The last bomb really had been heard beyond all doubt.

"'You are proceeding on the right course,' was the message that I then sent the *Baltic*. 'We can now hear your fog horn. Come very cautiously as we have no lights.'

"And then, fifteen minutes later I heard a tremendous cheer. I knew of course that it couldn't come from the members on our own ship, as there were only eight of us. I looked out of the cabin. There was the *Baltic* coming up right alongside of us. Her passengers had

lined the decks to keep a sharp lookout for us.

"It was then a little after seven o'clock Saturday evening. It had taken fifteen hours of the most trying and intensive work to bring the *Baltic* alongside during the dense dark fog, and considering the crude apparatus we had at that time I have always considered it a great achievement, for a more difficult set of circumstances could hardly be imagined.

"After our officers conferred with Captain Ransom of the *Baltic*, she proceeded to where the *Florida* lay, as Captain Sealby felt very anxious about the safety of his passengers, especially since the *Florida* was badly damaged and excessively overloaded.

"Just about this time the fog suddenly lifted and the weather turned into a nasty driving rain. The *Baltic* found the *Florida* and the combined crews of the ships immediately set about transferring all the *Republic's* and *Florida's* passengers to her own decks. Throughout the night in the cold, drenching rain these crews labored transferring 4,000 passengers through a dangerous long rolling swell. Thus within the short space of twenty-four hours there had been two major transfers of passengers at sea, and all accomplished without loss of human life.

And when daylight broke the next morning, Sunday, there was one of the greatest concourses of ships ever seen on the seas. Everywhere, as far as the eye could see were ships.

Every liner and every cargo boat equipped with wireless that happened to be within a three hundred mile radius of the disaster, overhearing the exchange of messages between the *Baltic* and *Republic* had gathered around and stood by ready to be of whatever assistance they could. It was a fine testimonial to the value of wireless. Shortly after daybreak the *Baltic* proceeded to New York and the *Florida* also proceeded at slow speed, convoyed by two or three other ships that were standing by. And then relief ships cared for the badly damaged *Republic*.

"During all this time, of course, the *Republic*, had been slowly sinking, and it was decided to tow her into the shallow waters off Nantucket. Two revenue cutters, the *Gresham* and *Seneca*, thereupon took line on the bow of the *Republic* in tandem fashion, and the Anchor Line *Furnessia* tied up on the stern to act as a rudder for the disabled ship. All available

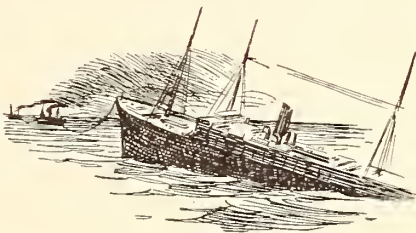

means were taken to keep her afloat. The tow started at ten o'clock Sunday morning and continued until seven o'clock Sunday night, but no actual progress had been made, for although the revenue cutters pulled her forward, a cross current was running against



them at practically the same speed, so that all four ships virtually stood still.

"Finally the *Furnessia* cast off, for the stern of the *Republic* was under water. The

water was already beginning to creep into my cabin and while I was wondering whether I should go forward or wait until the captain sent for me, the third officer came aft and said the captain had issued orders to get ready to abandon the ship and that I was to come forward. I didn't hesitate about that. The rest of the officers were there and we tried to persuade Captain Sealby to abandon the ship with us. But he refused to do so. Instead he asked for a volunteer to stay with him. Everyone volunteered. Captain Sealby then chose Second Officer Williams on account of his being the senior unmarried man in the group and also because Williams knew the Morse code and could signal with a lantern.

"At this time the *Republic* was attached to the *Gresham* by a steel hawser. As soon as we put off in the Captain's gig we pulled over to the *Gresham*, told the captain of that ship the condition of the *Republic*, and asked him to pay out a nine-inch rope hawser and stand by, ready to cut the rope hawser as soon as he got a signal from the bridge of the *Republic* that the ship was about to go under. It had been previously agreed that Captain Sealby was to flash a blue Coston light when that moment did arrive. This the captain of the *Gresham* did. He stationed a man with an axe over the hawser, with instructions to cut it the moment he saw the blue light. We stayed off in the life boat waiting for developments and holding ourselves ready to go to the rescue of Sealby and Williams the moment the ship went down.

"Fortunately there were four or five other ships in the vicinity watching the proceedings. Each one played its searchlight on the *Republic*. By the aid of the many searchlights the two lone figures could be seen pacing to and fro on

the uptilted bridge. And then came the signal of the blue light. Then we saw one of the men jump on to the rat-lines of the foremast, climb up to the top of the mast and wait. The other man ran forward, climbed up on the rail, and taking one last long look at the little cabin on the bridge turned and dove forty feet into the sea.

"For one minute more the bow of the *Republic* trembled above the waves and then sank.

"We rowed over to the spot where it went down. The light of each observing ship was trained upon the spot. Fortunately a quiet sea was running at the time, but even so it was most difficult to see very far from the open boat as the lights, intercepted by the crests of the waves, threw darkened shadows over most of the surrounding waters. We grew very anxious about Captain Sealby and Mr. Williams, for certainly no man could long survive the cold of those wintry waters.

"For twenty minutes we rowed around, earnestly but yet aimlessly, for we did not know where to go. On all sides we saw the glaring searchlights—but nowhere could we discern any sign of life in the sea. I don't think any more sorrowful moment ever came into the lives of the men in that open boat, not to mention those on the nearby ships, for Captain Sealby and Second Officer Williams had nobly upheld the tradition of the sea. But the length of time did not diminish our hopes.

"This collision at sea had indeed brought forth a series of climaxes. First the wireless apparatus, crude as it was, had brought Siasconsett to our aid; the very last bomb that the *Baltic* had come within an ace of being in vain, and now—

"Suddenly, to our right, from out the murky blackness of the waters of the sea, a revolver shot rang out. We pulled over in that direction immediately, and there we found Captain Sealby hanging on to a floating crate, so nearly exhausted that he had had just sufficient strength to pull the trigger of his revolver. 'Williams over there', he said, 'Get him.'



But we pulled the captain in then and there, and then rowed in the direction he had indicated. And sure enough we found Williams too, clinging to a hatch cover that had floated off the *Republic* when she went down."

It was fitting *denouement* to one of the greatest near-tragedies of the sea. And a tragedy indeed it would have been had it not been for wireless and an operator who had initiative, skill, and the fortitude to stick to his post for 48 hours without eating or sleeping.

Jack Binns was born in Lincolnshire, England, in 1884. Early in his teens, he became interested in the electrical sciences and attended the technical school of the Great Eastern Railway, where he obtained a thorough grounding in electricity and learned the Morse telegraphic code. About that time Marconi, having made his bow to the scientific world, was developing a company over in England. Binns made application for a position as operator and was quickly accepted. He became connected with the Belgian Marconi Company and was sent to sea on a German ship.

At that time there was competition between the Marconi system and the Slaby-Arco system, a German system in use on German ships, but the Marconi organization was better developed and they won out. About twenty operators were picked for service on German ships, Binns among them, and during his connection with that company he did considerable experimental work, chiefly in long distance reception from the so-called high power stations at that time—the Poldhu and Cape Cod stations. This experimental work took him not only across the Atlantic but up around Spitzbergen in the Arctic Ocean and down in the tropics on this side of the Atlantic, through the Caribbean Sea and along the northern coast of South America, all of which work was in addition to regular trips made as operator on German ships.

About 1907 there was a great deal of agitation in Germany over the presence of foreign operators on board German vessels, who included not only Englishmen but Americans, Italians, Belgians, Danes, and even one Icelander. Consequently, in June, 1908, the German Government notified La Compagnie de Télégraphie Sans Fil (Belgian Marconi Com-

pany) that all foreign operators would have to be replaced with German operators by the end of July that year. In August of that year, the German Government precipitated the second Morocco crisis. In its order, the German Government bluntly stated that in the event of war with Great Britain or any other European power the foreign operator on board a German ship would undoubtedly refuse to notify the commander of the fact that war had broken out and consequently those ships would be captured by

enemy cruisers. Therefore, Binns was among the operators replaced, and after one or two shifts to various positions with the Marconi company, was assigned to the steamship *Republic* which post he had held for a period of three months.

During the war years, he became so proficient in flying that he was engaged as instructor in the Canadian Flying Corps, and made his headquarters at Toronto. Here he taught not only piloting, but instructed aviators in radio and the code. Radio indeed has been the outstanding feature of his life's work. He was one of the first to prove its value in an emergency at sea. He was one of the organizers of the New York Newspaper Club, and is now the Radio Editor of *The New York Tribune*.



LT. MAYNARD, JACK BINNS, AND DANIEL FROHMAN

In 1920, ready to bombard New York with "broad-sides" on the Actor's Fund

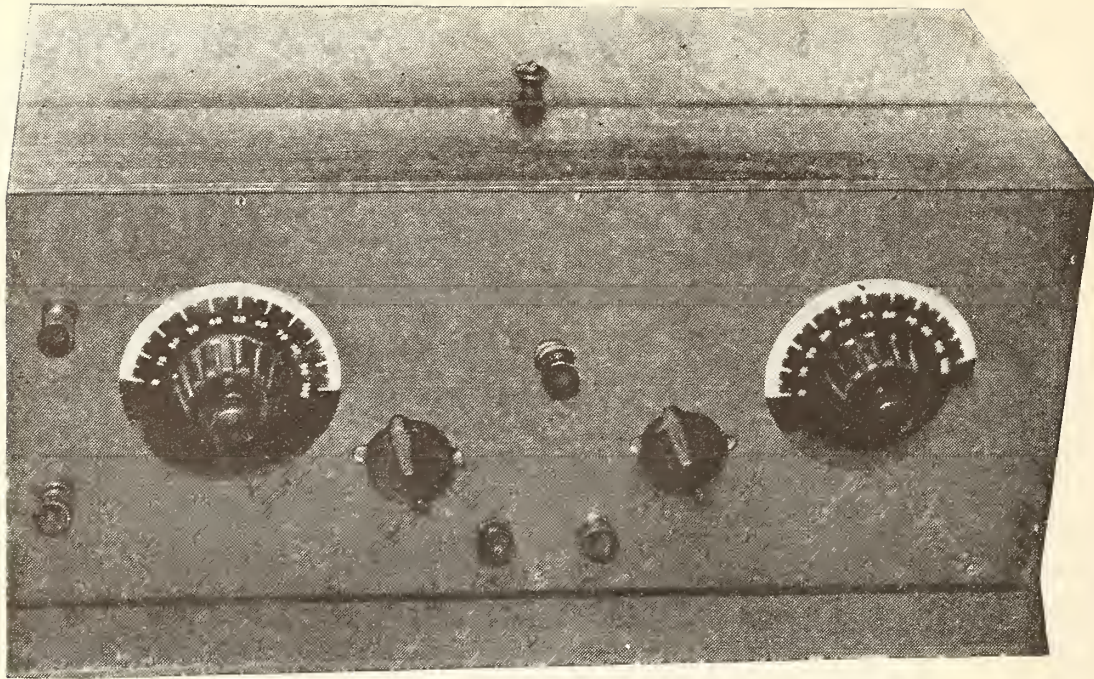

FRONT VIEW OF THE COMPLETED SET

This outfit can be built for less than \$50, uses a 201-A and UV-199 tube, is surprisingly efficient in operation and easy to build

## A Knock-Out Two-Tube Set

Combining the Advantages of Tuned Radio-Frequency Amplification, Audio-Frequency Amplification, the Neutrodyne Principle, Regeneration, and Reflexing and Loud Speaker Operation—All *Without Radiation*

By WALTER VAN B. ROBERTS

The set described costs less than \$50 for parts, including tubes and batteries; is fairly easy to make, and as Mr. Roberts says, will equal the performance of far more elaborate and expensive sets. This set is another of the series built under the direction of RADIO BROADCAST, the first of which was the "Knock-Out One-Tube Reflex," described in our November, 1923, number which we are printing on page 496 of this issue.

If the reader has the parts and has built the one-tube set described last November, it will cost him about \$10 more for the additional parts necessary for this set.

We are rushing the information on this set to our readers, and that explains why we do not show a panel lay-out. Next month, we will publish a complete "how-to-make-it" article on this new receiver.—THE EDITOR.

**T**HE circuit to be described is only one of many possible applications of the method which is used to obtain radio-frequency amplification without any tendency toward regeneration. This method is closely related to the ordinary neutrodyne system, but has the advantage that the coupling between primary and secondary of the radio-frequency transformer may be varied, thus allowing the maximum possible amplification over a large range of wavelengths.

The method employed by the writer for overcoming oscillation in the radio-frequency amplifier consists in winding the primary with a *pair* of wires, thus forming two separate windings coupled as tightly together as is physically possible. One of these windings is used as the primary in the ordinary fashion. The other one is used only to prevent regeneration. Fig. 1 shows the arrangement schematically. S is the secondary, P the primary, and N the neutralizing winding. The capacity C should be exactly equal to the capacity between the grid

and plate of the tube together with the socket and leads. Whatever alternating voltage exists on the plate must be due to alternating magnetic flux linking P. But the same flux also links the similar winding N, which is connected the other way around, and hence, acting through C, produces an effect on the grid which is equal and opposite to that produced by P acting through the grid-plate capacity of the tube. Thus the net "feed back" or tendency to regenerate is completely neutralized

(the coils P and S being of course set at such an angle with the coils in the grid circuit that there is no magnetic feed back) *whatever sort of secondary is used, however loosely it is coupled, and however it is tuned.*

If a transformer has a tuned secondary of low resistance, the coupling between primary and secondary should be varied with the wavelength in order to keep the amplification at its maximum value. Practically, however, it will be found sufficient to have two or three different degrees of coupling—for instance, primary and secondary as close together as possible for the long wave range, and about one inch apart for the short wave range.

#### USING REGENERATION INTELLIGENTLY

IF A transformer has a tuned secondary, the lower the resistance of the secondary is, the greater the voltage amplification will be, and the looser the best value of coupling. The easiest way to obtain a very low effective resistance is to employ regeneration in the tube to which the secondary is connected. The use of regeneration in this way will help most when the secondary is loosely coupled to its primary, and the set is then much more selective. By making this tube oscillate, signals are easily picked up by the squeals—the reason that the set is non-radiating is that if the capacity C of Fig. 1 is adjusted just right and there is no magnetic feed-back to the antenna, then no oscillations can get back from the oscillating tube through the amplifying tube to the antenna. The neighbors, bless 'em, won't hear any squeals.

Fig. 2 shows the complete circuit, while

Fig. 3 shows a simplification which is very satisfactory for strong signals, especially if great selectivity is not needed. Regeneration is omitted in the simplified circuit and all couplings are left fixed at a good average value so that only the two variable condensers are used in operating the receiver. Different methods of connecting the antenna to the set are shown in Figs. 2 and 3. The method of Fig. 3 is simpler but a slight hum is likely to be heard if there is alternating current supply in the house.

The outstanding features of this circuit:

1. It will run an hour or so a day for several months on four dry cells.
2. It will operate a loud speaker well enough for all ordinary purposes.
3. It does not radiate and cause squeals in the neighbors' receiving sets.
4. It offers a better combination of sensitivity, selectivity, and quality for the total cost than any other circuit the writer has ever used.

LOW COST AND HIGH  
COMPARATIVE PER-  
FORMANCE

THIS total cost is very little compared to what most sets giving comparable results would come to after all batteries and tubes are included. To keep down the cost and to make

it easier to build, the set is laid out on a flat board 2 feet by 1 foot. There is room for interesting experimental work in arranging this set behind a panel, and making the layout very compact. Results were more important at first than symmetry of construction.

#### WINDING THE COILS

COILS A, S, N, P, and T (the tickler) are all wound on the same size cardboard spiderweb coil forms. These are 5 inches outer diameter and have 13 teeth each  $1\frac{7}{8}$  inches long. Coils A, S, and T are all wound with No. 22 wire, going over two teeth, then under two, etc. There are 30 turns on A, a small loop being twisted in the wire at every fifth turn.

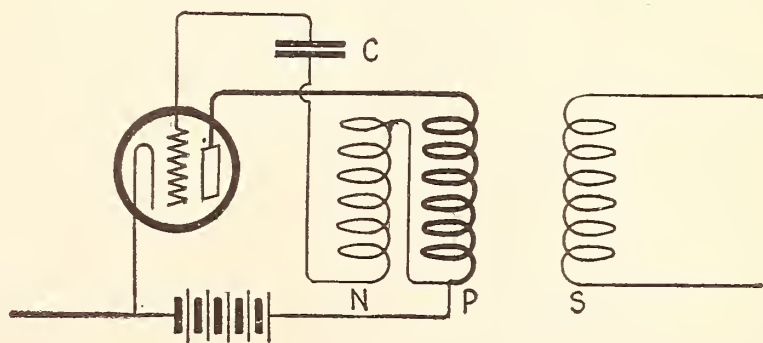

FIG. 1

Fundamental circuit of the method of winding the radio-frequency transformer for this set. N is the primary neutralizing winding and C the neutralizing capacity to balance the effect of the capacity between the grid and plate of the tube

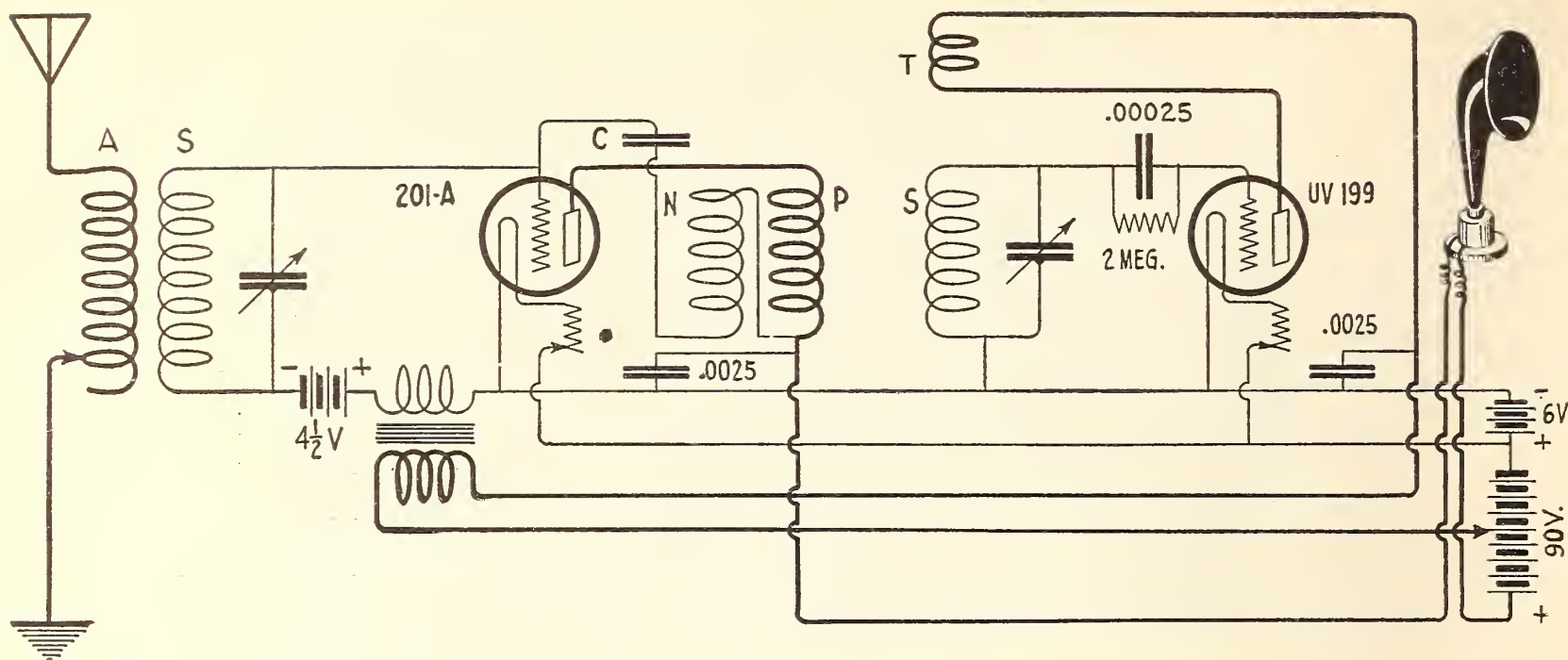

FIG. 2

The complete circuit of the Knock-Out Two Tube Set. This circuit is recommended over the simplified arrangement shown in Fig. 3

The insulation is scraped off these loops and contact is made by a voltmeter clip. S has 45 turns. Both of the coils "S" should be connected so that the lead from the inner turn goes to the grid. T should have 20 turns, or even less if oscillations occur too easily.

The tickler must of course be connected the right way around to get oscillations at all, and this is most easily discovered by experiment. Windings N and P are wound simultaneously on the same spider web form by winding with a pair of No. 26 wires, treating the pair exactly like one wire. In this case wind over one tooth, then under one tooth etc., going around 22 times. There are then two separate windings each of 22 turns. Connect the outer terminal of one of these windings to the inner terminal of the other.

The remaining pair of terminals go to the plate and to the capacity C and it makes no difference which goes to which. This self balancing primary of the three winding transformer is the novel feature of the receiver and to it is undoubtedly due the improvement over similar reflex circuits using other types of radio frequency transformers. The photograph shows how magnetic coupling between coils A and S at one end of the board and coils N, P, S, and T at the other end is avoided by setting them at right angles. The tickler is mounted on the end of a strip of wood that can be slid in and out between a pair of narrow guide strips. The coil containing windings N and P is not arranged to slide, but by loos-

ing up the single screw that fixes its position, it can be set up close to coil S or backed away about an inch and a half. The same arrangement is used for coil A. Both of the coils S are fixed in position.

#### USING THE NEUTRALIZER

THE capacity C shown in the photograph consists of two pieces of copper about the size of a penny separated by a sheet of mica. A piece of paper would do just as well, as the only purpose of the material between the pieces of copper is to prevent their touching, which would short circuit the B battery. Adjustment can then be made by sliding one piece of copper sideways. Another way of getting the capacity C is to have a couple of inches of bus bar stick out from the grid terminal, and slide a piece of spaghetti over it, the spaghetti being wrapped around on the outside with the wire coming from the neutralizing winding. The best way, however, to obtain the capacity C is to buy a little one-plate variable condenser, the plate being about  $1\frac{1}{2}$  or 2 inches in diameter.

The capacity C has to be considerably greater than in the usual neutrodyne arrangement. The adjustment of this capacity to exactly the correct value is of great importance for two reasons. First, to make the set non-radiating, and secondly, to make the operation of the two tuning condensers completely independent of each other. The ordinary way of getting the proper balance with the filament of the first



tube unlighted is impossible because the phones are in its plate circuit.

A simpler way is to make the second tube oscillate by pushing the tickler coil up, then pick up the carrier wave of some transmitting station by the squeal, and then adjust the capacity C. When the correct adjustment is obtained, it will be found that varying the setting of the antenna circuit condenser will not affect the pitch of the squeal from the carrier wave, but only its intensity. This proves that the antenna circuit is not coupled in any way to the oscillating circuit, and hence no oscillations can be produced in the antenna.

If the non-regenerative circuit of Fig. 3 is used, the adjustment of capacity C is even simpler—it is merely varied until a value is found such that the set cannot be made to squeal by any combination of settings of the two tuning condensers. It should be noted that too much neutralizing capacity will cause regeneration just as readily as too little.

#### GENERAL NOTES

**I**N ANY given set, it is advisable for the user to try connecting the grid return of the detector tube to the + side of the filament. This sometimes gives better results. Also, the best value of the voltage for the B battery should be found by experiment, although  $22\frac{1}{2}$  volts will usually do about as well as any.

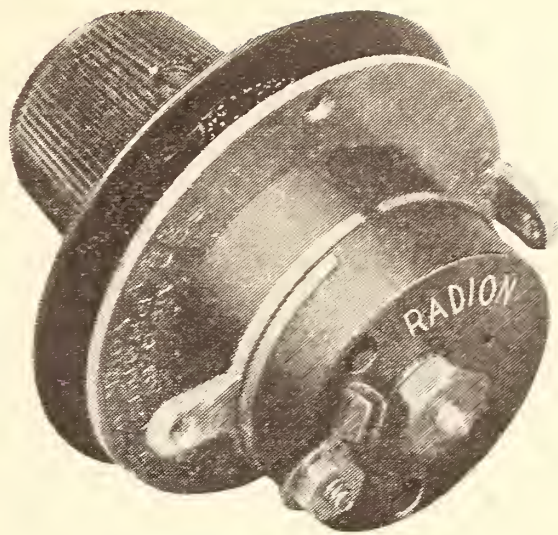

A NEUTRALIZING CONDENSER

Which may be used in place of the two penny-size pieces of copper suggested for the neutralizing capacity for the first tube

A good long antenna of low resistance is of much more importance in this set than in an ordinary regenerative set, because the resistance of the antenna circuit is not wiped out by regeneration. The ground lead should be firmly clamped or well soldered, and the antenna wire made of copper.

#### WHAT THIS SET HAS DONE

**A**FTER the set is working at its best, the results should be noticeably better than can be had from a first class single circuit regenerative receiver with one stage of audio ampli-

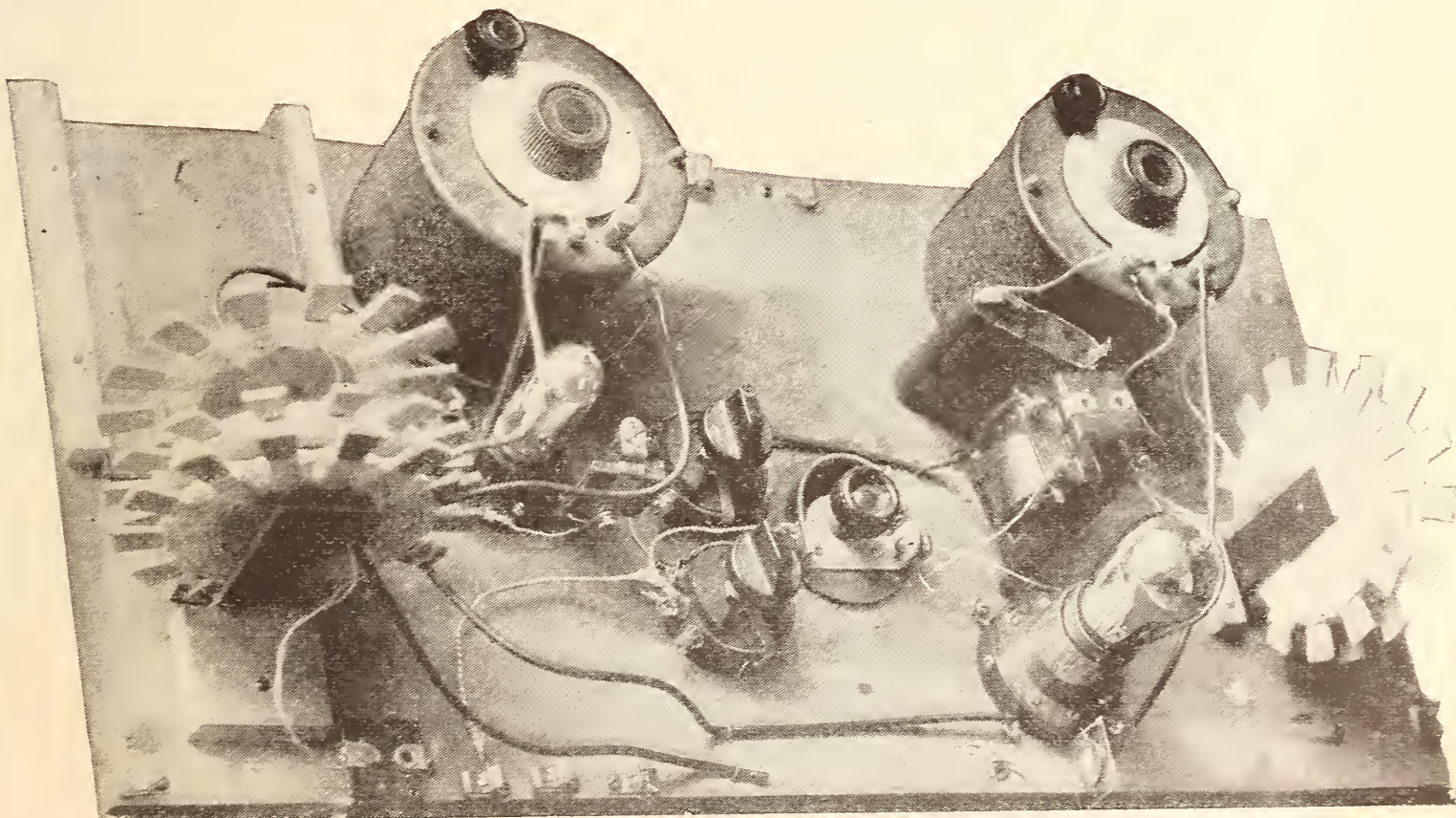

THE LABORATORY MODEL

Worked out by Mr. Roberts. With this simple layout, he was able to tune-in Havana on a loud speaker while Newark was operating, and WJAZ while WJZ was on the air. His experiments were conducted at Princeton, N. J.

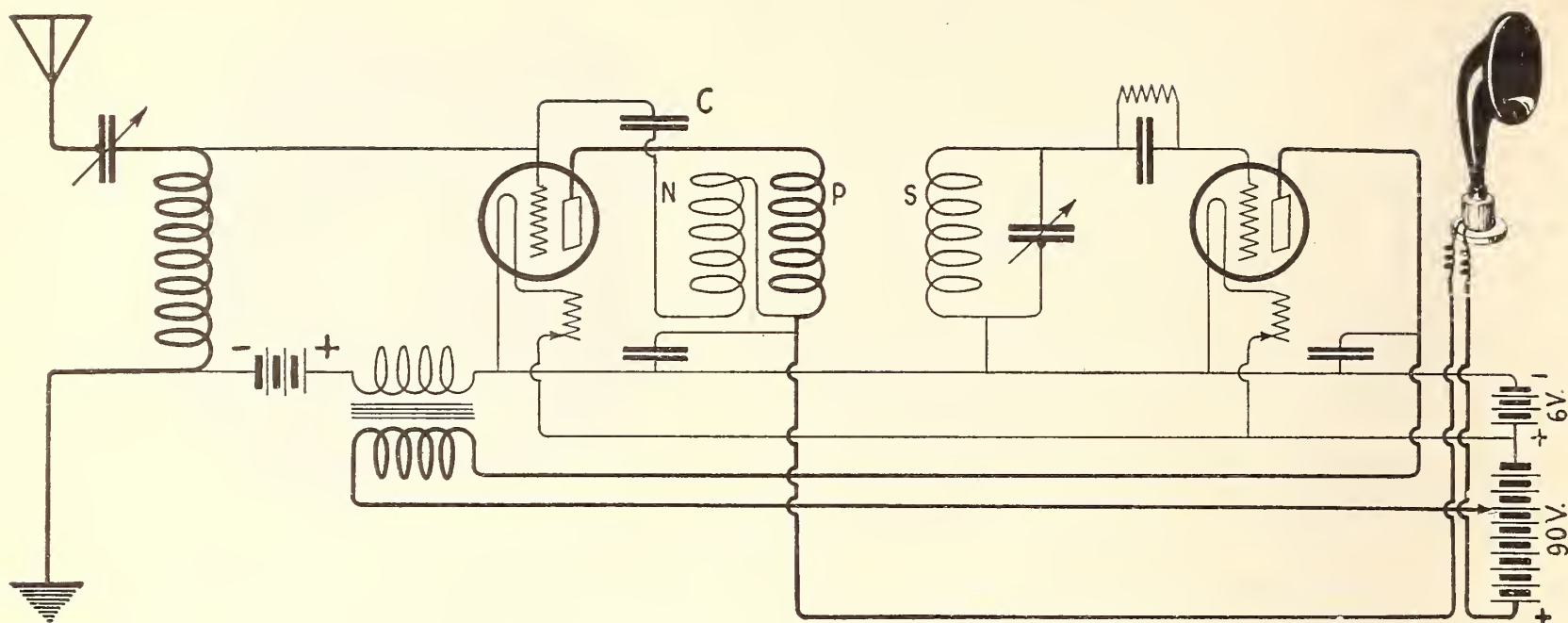

FIG. 3

A simplified circuit which may be used. The number of tuning controls is reduced to the two variable condensers. But the results obtained from the circuit shown in Fig. 2 are far superior to those secured from this circuit, although its adjustment is not quite so simple

fication. The selectivity should be better than that of a three-circuit regenerative receiver, and the tuning easier and less critical. The outfit shown in the photograph has been tried out against two well known makes of neutrodyne and gives about the same results (only one stage of audio being used in the neutrodyne sets, of course.) Using a single wire antenna 150 ft. long and about 20 ft. high

located in Princeton, N. J., WJAZ in Chicago was heard on a Western Electric 10D loud speaker without any interference from WJZ. PWX, Havana, was heard on the loud speaker while WOR, about 35 miles away, was working. These stations are too close together in wavelength to be separated completely, but the selectivity of the set was such that PWX was only slightly less loud than WOR.

The parts that have to be bought and the approximate list prices are as follows:

Two General Radio .0005 mfd. geared condensers ("table mounting") (or other good condensers)	\$12.00
One Amertran audio frequency transformer	7.00
One UV 201-A or C-301-A or DV-2 vacuum tube and socket	5.75
One 6-ohm rheostat.	1.00
One UV-199 or C-299 or DV-1 vacuum tube and socket	5.75
One 60-ohm rheostat (or two 30 ohm rheostats in series)	1.00
Two .0025 Micadon condensers	.70
One .00025 Micadon condenser with clips for grid leak	.45
One 2-megohm grid leak	.75
One 4½-volt flashlight battery	.50
Four dry cells	1.60
90 volts B battery	7.00
Five 5 and 10 Cent Store spider web coil forms (these may be made at home without difficulty)	.25
Screws, wire, wood, etc., about	1.50
Total	\$45.25

(Loud Speaker is not listed due to wide variation in prices)

# Man-Made Static

What Causes Interference to Radio Receivers—Some Easy Methods of Locating the Cause of the Trouble—and How to Stop it

By A. F. VAN DYCK

Engineer, Technical Division, Radio Corporation of America

**T**HE term "static" has been used, more and more commonly, to name the cause of many noises which are heard in radio receivers, and which sound like scratching, frying, clicking, or grinding. The word static is short for "static electricity." Real static electricity, or electrical charges deposited on the antenna, cause a very small part of the whole disturbance, and radio experts label all the causes of such interference as "atmospherics." However "static" seems to be a more usable and popular word, perhaps because it sounds so much like the short, sharp, vicious thing it stands for.

Now there is static and static—static caused by phenomena of nature, and that caused by

electrical disturbances due to man's own agencies. It is the purpose of this article to point out and describe examples of one kind of interference which is very common in broadcast reception, and which is quite mysterious in many of its manifestations. This form is often called "inductive interference." There are a great many industrial and other applications of electricity in use, and everyone of them can, under certain conditions, become a radio transmitter in effect, and send out radio waves which will cause interference

with the signals from radio broadcasting stations. Since the noise produced by such sources sounds very much like static, and yet is caused by human agencies, it is often called "man-made" static.

## "What Is that Scratching Noise?"

Well, if you are morally certain it doesn't come from your receiver itself, you have every right to be suspicious of almost everything electrical about you which might possibly be out of order.

Mr. Van Dyck shows that in actual practice, the interference comes from a few sources and that, by the exercise of a little intelligence, the trouble may be eliminated, and all be made again serene on the radio horizon.

—THE EDITOR.

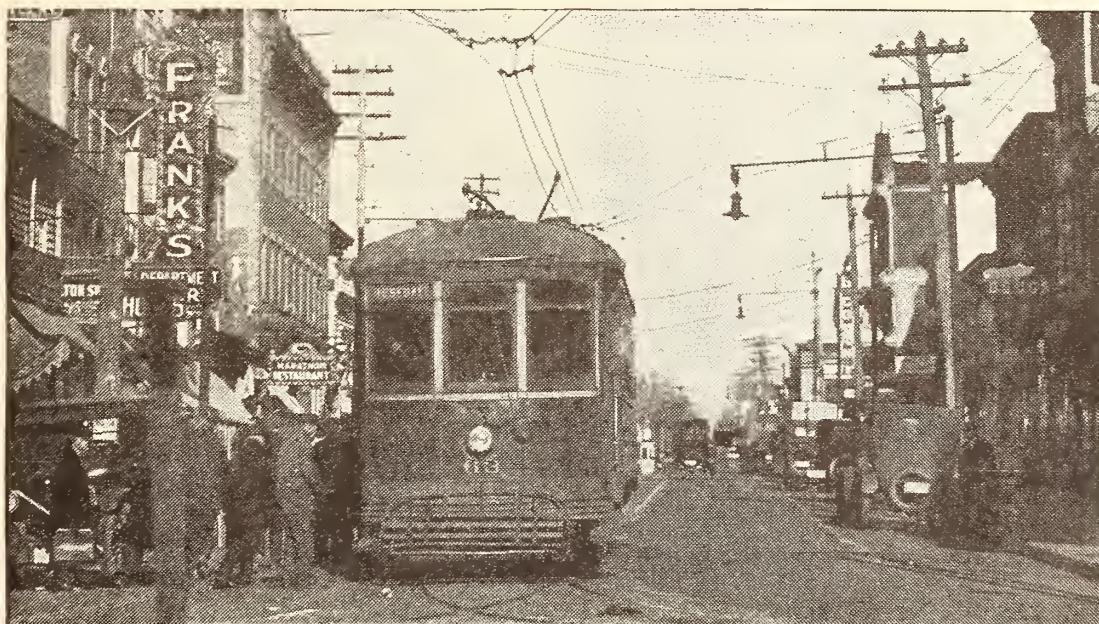

### LITTLE BURSTS OF "STATIC"

Are often caused when the trolley of this surface car makes sparks in following the wire. "Static" of this sort is not particularly bothersome, because of its short duration

## WHERE THE TROUBLE COMES FROM

IN MANY localities, man-made static causes far worse interference than does nature's own static. Fortunately, man-made static can always be eliminated, while nature's cannot by any means now known. The most difficult part of the process of elimination of man-made static is locating its source.

Some causes of "Man-made Static":

## Class 1. Power Circuits

- (a) Lines
- (b) Insulators
- (c) Lightning arrestors (on power lines).
- (d) Transformers
- (e) Generators and motors

## Class 2. Industrial Applications

- (a) Arc lights
- (b) Telephone and telegraph lines
- (c) Telephone ringers
- (d) Street cars and electric railroads
- (e) Factory motors
- (f) Store motors and barber shop appliances
- (g) Smoke and dust precipitators
- (h) Electric flashing signs

## Class 3. Household Appliances

- (a) Door bells
- (b) Light switching
- (c) Sewing machines
- (d) Vacuum cleaners
- (e) Flat irons
- (f) Electric refrigerators
- (g) Dish washing machines
- (h) Kitchen mixers
- (i) Violet Ray outfits
- (j) Heater pads.

## Class 4. Miscellaneous

- (a) X-Ray machines
- (b) Storage battery chargers
- (c) Electric elevators
- (d) Annunciator systems
- (e) Automobiles

- (f) Stationary gas engines
- (g) Tickers
- (h) Dentists' motors

The list given above contains only devices which actually have been reported as causing interference. Many other similar ones, although not mentioned in this list, may cause interference in other cases. Of course, some of these causes are more frequent offenders than others. Certain ones in the list have been reported hundreds of times, others but a few times, and a few but once.

If all electrical circuits and devices were always kept in perfect order, radio receivers would have but little interference. The following devices are exceptions, that is, these devices cause interference even when they are in perfect order.

Class 1. Lightning arrestors on power lines.

Class 2. Telephone ringers  
Street cars  
Motors (of some types).  
Smoke and Dust Precipitators

Class 3. Door bells  
Light switching  
Various motor driven devices  
Violet Ray outfits

Class 4. X-Ray machines  
Storage battery chargers  
Electric elevators  
Annunciator systems  
Gas engines with electric ignition

The devices which appear in the first list and not in the second, cause interference only when they are not in perfect condition. It is therefore possible to eliminate the interference from such devices merely by putting them in perfect condition.

It is also possible to eliminate in part the interference caused by devices mentioned in the second list, but it is usually difficult and requires study by an expert, or someone who has had previous experiences with that form of interference.

## THINGS WHICH MAY CAUSE INTERFERENCE IF OUT OF ORDER

LET us consider now those appliances which cause interference to radio because they are not in perfect order. First on the list are power lines, together with the insulators on the lines. It can be said, as a general proposition, that power lines are the cause of most "interference" in radio reception. This is not remarkable if one considers the great power of the energy which is transmitted over most electrical lines, and the very tiny power which

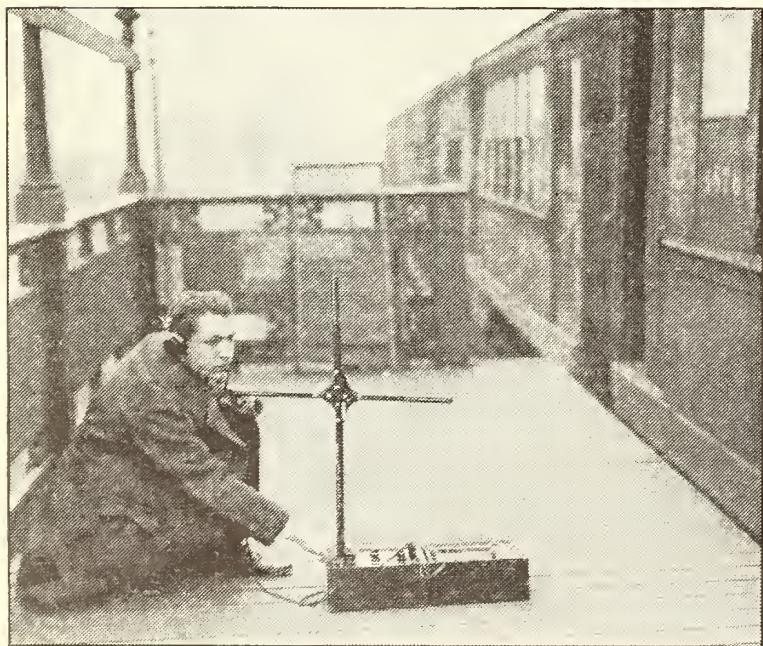

PASSING ELECTRIC TRAINS

Often annoy the broadcast listener who blames radio in general for the resulting "scratchy" noise in his receiver. A faulty contact-shoe on one car of a train can cause considerable, although not serious, trouble

is required to operate sensitive radio receivers. An electric power line needs to radiate only a ridiculously small part of its power to create very strong interference with radio.

How does the electricity carried by power lines differ from that which operates radio receivers? An understanding of this difference is essential before one can intelligently try to locate any case of interference.

The power carried by electric transmission lines is either direct current, flowing always in the same direction around its circuit, or it is alternating current of low frequency, "alternating" in direction around its circuit twenty-five or sixty times each second (called 25 or 60 cycle power). Both of these two forms of electricity are harmless to radio, provided the antenna and receiver are at least fifteen or twenty feet away from the power wires, and provided the power lines and all of the electrical devices connected to the lines are in normal condition, and none of the devices are of Class 2, as listed above.

#### WHEN AND WHY A POWER LINE INTERFERES

**T**O OPERATE a radio receiver at a distance, we must have electrical alternations of *very high* frequency, thousands of cycles per second at least, because electricity operating at such frequencies sets up waves which can travel without wires. Therefore, to cause waves of the same nature as radio waves, and thereby cause interference with *real* radio signals, the electrical power on transmission lines at low frequency must be changed to high frequency. Here is how that happens.

Whenever an electric circuit makes a spark, either by a bad contact between any two parts of the circuit, or by the use of a voltage high enough to jump a gap between two parts (like the ignition spark plug), high frequency currents are generated. In fact, this method of generating high frequency currents (a spark caused by high voltage of the ordinary sort) was the one used in all the early radio transmitters, and is still used in some, although better ways are now known. So whenever any electric circuit causes a spark, radio waves are generated. The wavelength, or frequency, of these waves depends upon the electrical characteristics of the circuit. The wiring of the circuit forms an antenna and the distance over which the disturbance can be heard therefore depends upon the size and form of the wiring of the circuit.

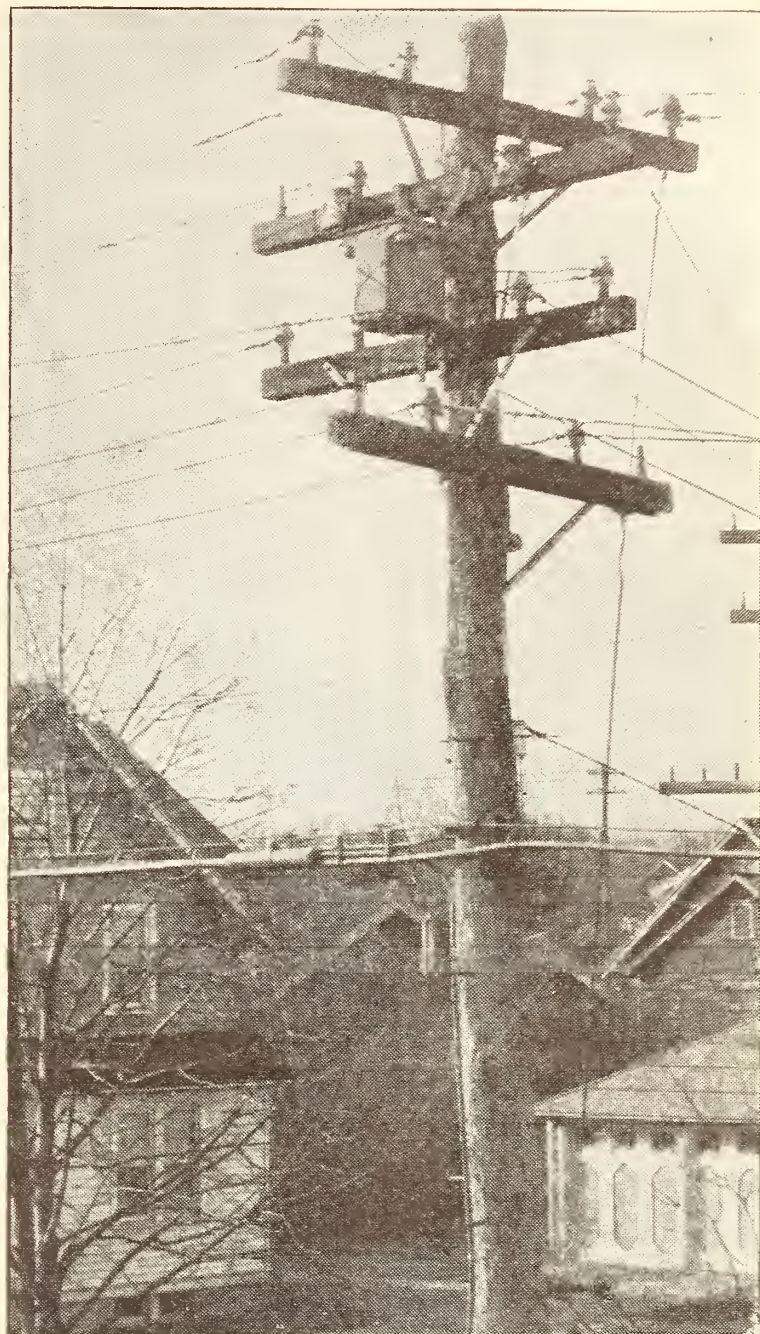

A POOR CONNECTION

Inside the metal case of this lighting transformer could make broadcasting reception in this neighborhood very difficult. And if one of these power wires were scraping its insulation bare against a tree, or if there were a leaky insulator on this pole cross-arm, unpleasant local interference would also be set up

The electric power line itself does not produce interference with radio, unless in some part of it there develops a bad contact or other means of creating a spark. The spark may be so small as to be invisible to the eye, and yet create disturbance. And whenever there is interference from this source, it can be removed by locating the spark and either removing it, or in some way preventing the spark from sending out radio waves.

Sparking can develop on power lines in many ways. The most common way is through "leaky" insulators, that is, ones which do not give perfect insulation, and allow the power to creep off in tiny jumps. Troublesome radio interference is often due to power wires

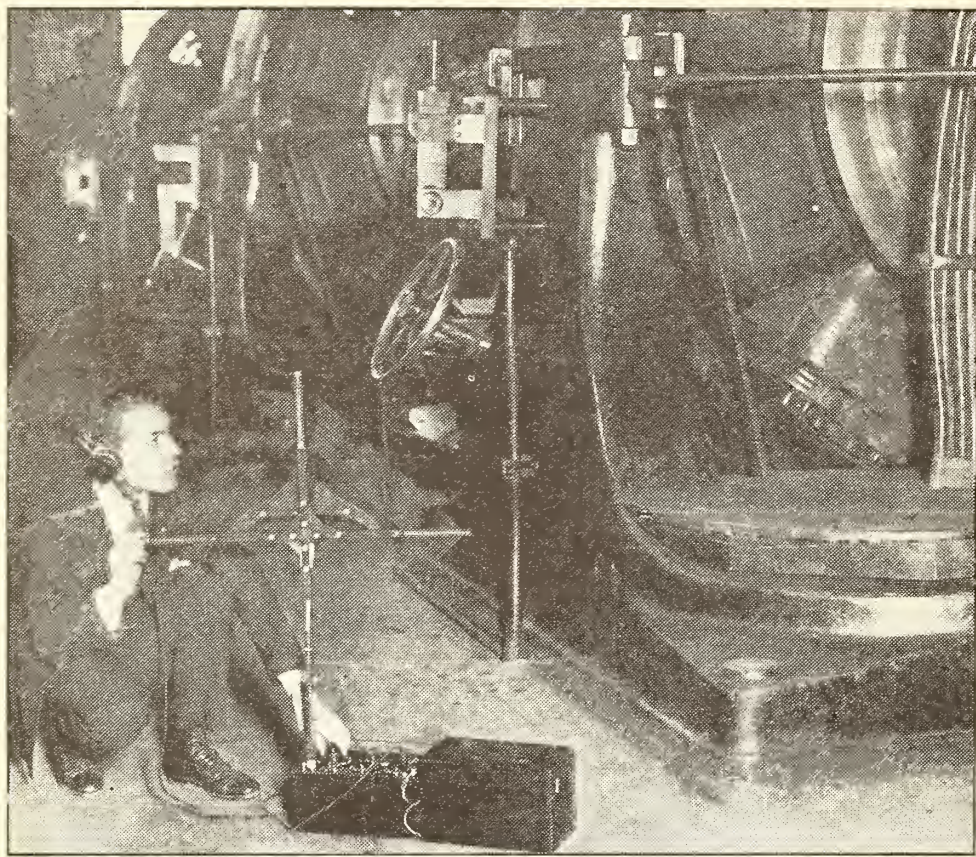

LARGE MOTORS AND GENERATORS

Frequently set up interference for the broadcast listener. Sparking commutators on motors and collector rings on generators are responsible. This difficulty is not usually hard for the power house to remedy. The operator with the loop receiver is verifying the cause of the trouble

touching tree branches. Also many cases have been traced to the distributing transformers, which are usually mounted on poles in the center of the neighborhood they serve. These unfaithful transformers develop defective internal insulation, poor contact at their terminals, etc.

#### HOW TO FIND THE INTERFERENCE

IT IS often difficult to locate the exact spot of such power line interference, because the antenna formed by the lines is extensive and the interference therefore heard over a large area. To locate the trouble, that section where it is worst can be found by listening to it on ordinary receivers at various locations, and when the area has been localized to a particular section, a direction finding set with loop aerial must be employed. This set should not be too sensitive, as the increase in loudness as one gets nearer to the trouble (which is more apparent on an insensitive receiver), is also a useful indication, in addition to the direction. Power companies are usually glad to cooperate in removing such interference, particularly since it is an indication of a fault on their system which is wasting power, and which may grow worse until it finally results in interruption of the power service. The

radio receiver, in fact, can be made use of by power companies as an effective method for locating line faults.

Generators and motors are somewhat different from power lines in that they may give interference while operating in a condition which is satisfactory from the mechanical and commercial point of view. Ordinarily, interference from machines is due to their commutators or slip rings, because sparks occur at these points. The sparks, just as described before, generate radio frequency currents, and the wiring to the machine acts as an antenna system radiating the waves. Obviously, the first step in eliminating this interference is to stop the sparking on the machine, or at least to reduce it as much as possible. It can not be stopped completely in all cases, as a certain small amount of sparking can not be avoided in most machines. However, the commutator

should be clean and smooth, the brushes in good condition and properly set, and the machine not overloaded. In extreme cases with direct current machinery, and where the expense may be justified, the interference can be stopped by putting large "choke" coils in the wires connecting the machine with the power line. These must be put right at the machine terminals and must, of course, be capable of carrying the full current of the machine. The low voltage winding of a proper size transformer will often make a suitable "choke". In some cases, connecting large condensers (having a few microfarads capacity) directly across the terminals of the machine alleviates interference, but this method is not always effective. When condensers are thus used, they should be insulated to stand at least twice the voltage of the line. The use of choke coils has been successful in many cases of interference from small motors, such as dentists' motors, and those used in dictaphones, cash registers, household appliances, etc. With small motors, the choke coils may consist of "honeycomb" type coils. The size of coil must be chosen to suit the particular case, and is usually a size between 500 and 1500 turns. The larger the coil the better it is for reduction of interference, but if the supply line is

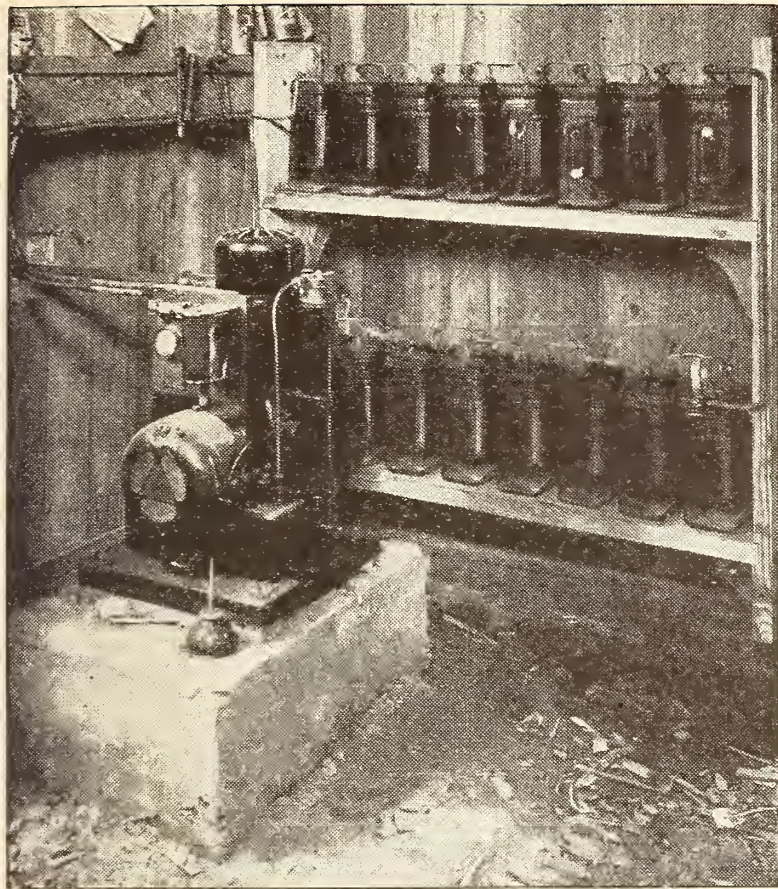

FARM CHARGING OUTFITS

Can make trouble for the broadcast listener. The usual cause is badly sparking brushes on the dynamo

alternating current, it can not be too large or it keeps too much line voltage away from the motor, thereby causing the motor to run slowly, or otherwise affecting its operation.

## ONE CASE IN POINT

LOCATING interference of the sort which has been described above, becomes a good deal of a sporting proposition, with plenty of opportunity for clever detective work and systematic experimenting. In one instance which has been reported, a broadcast listener who had good reception conditions for over a year, returned from his summer vacation to find that reception was quite impossible on account of terrific "interference." This noise was continuous and appeared to be from a power line. Whenever an interference is on continuously day and night, it is fairly safe deduction that it is due to some power line itself, because devices fed from a line are switched off and on at least occasionally. So this listener concentrated on the power lines in his neighborhood, and first asked all his neighbors if any changes had been made during his absence. One neighbor recalled having seen linemen at work upon a certain transformer. Inasmuch as the interference was loudest near this transformer, it seemed logical

to suspect this device. Inquiries to the power company revealed that the wood pole upon which the transformer was mounted, had needed replacement, and the transformer had therefore been taken from the old pole and mounted on the new one. This made the trail seem warmer, and the radio listener asked the power company to make examination of the transformer. The inspection was made, and in fact a second one, when it was found that one connection on the internal terminal block of the transformer had not been soldered. As soon as this was soldered the interference ceased completely.

## THE STRANGE CASE OF THE HEATING PAD

A RADIO dealer installed a very good radio receiver in a certain home, and it performed properly with satisfactory service for a period of several weeks. One day, however, the dealer received complaint of trouble. He investigated and found a bad case of interference which, after several days' observation, was noticed to be continuous except for an occasional short "silent" period. The quiet periods were erratic in time of occurrence although always in daytime, usually morning. The dealer



A WASHING MACHINE MOTOR

Such as the one shown here may produce enough "static" in radio receiver installed in the same house or very near by to spoil the incoming concerts. Remedy: clean the motor commutator and clean and adjust the motor brushes

looked for the source of the trouble and finally found it, but his success came only after a week of careful and logical work. The first tests, made with the coöperation of the power company, and by cutting off power in one section at a time, showed that the trouble originated in one certain small section. Further tests of the same sort showed that it came only when a certain transformer in this section was connected. Now it had been noticed every time the voltage was removed from the line during these tests that not only did the interference stop, but it did not start again until almost exactly ten minutes time after the power was turned on. It seemed quite reasonable to believe, therefore, as soon as the source had been narrowed down to one transformer, that this transformer became defective in some way after the power had been on long enough to heat it up to a certain temperature. So the power company went to the trouble of replacing the transformer with a new one. But, ten minutes after the new transformer was turned on, the interference came on as strong as ever. This was conclusive evidence that the trouble was not in the transformer but was somewhere on the lines going from the transformer, which as is usual, fed quite a number of houses in the neighborhood. When he tried a radio receiver with a loop antenna, he soon localized the trouble as coming from one particular house which was several hundred feet from the nearest radio receiver. When the main switch in this house was opened the in-

terference stopped all over the section. Further systematic search in this house seemed to indicate that the porch light was the guilty device and so it was taken apart and examined—but the noise continued even when the porch light wiring was disconnected. Then a member of the household remembered that there was a baseboard outlet in a front room on the second floor which was probably connected to the porch light wiring. Examination of this outlet revealed that it was used practically continuously for an electric heater pad in the bed of an invalid. When this heater pad was disconnected, the noise stopped. Ten minutes after this heater was plugged in, the noise would start. A variable contact in the heater element of the pad partially opened the electric circuit and therefore caused sparking, when it became hot. It took ten minutes for the pad to heat up to the temperature which caused the sparking.

#### IT ISN'T HARD TO FIND THE TROUBLE

THE incident just given has been described in detail because it shows the sort of detective work which is usually necessary in order to locate inductive interference. Expert radio knowledge is an advantage, and familiarity with electrical practice a still greater benefit in "shooting trouble," but the chief requisites to successful locating of inductive interference are common sense and the ability to see what experiments are most likely to give useful information, and second, to interpret the results of the experiments.

## A Power Company Cuts Out "Static"

One Lineman with a Loop Receiver Replaces Many Men and Saves Repair Costs, Current, and the Temper of the Broadcast Listener

By EARL C. McCAIN

 ON THE 66,000 volt Arkansas Valley power transmission line of the Southern Colorado Power Company between Pueblo and La Junta, Colorado, there are 28,530 insulators. And each insulator has to be inspected frequently so that the high tension current will not stray from its copper path.

No doubt you are asking yourself what this has to do with radio. Well, it has just this to do with those who nightly listen to the voice of the broadcaster. Large power lines which

"leak" current are certain to produce static in every radio receiver in the vicinity. The sound will almost always be continuous, and if the leak is bad enough, and your receiver is near enough the source of the trouble, you are going to have a pretty hard time of it. Distant stations simply can't be "pulled in" through the local artificial "static," and the more amplification you use, the louder it will come in.

Those who live in cities and those who don't, often encounter receiving trouble from this source. All that is necessary is for you to be



near a leaky power line.

The power companies don't like leaky lines any better than an irate broadcast listener does, for if the leak is sizeable, they are going to lose current, and in losing current, money.

George W. Hammill, superintendent of the Arkansas Valley transmission lines of the Southern Colorado Power Company, has had great success using a radio receiving set equipped with a loop antenna to detect faulty insulators and leaks of greater or less magnitude on the lines under his control.

A fairly sensitive loop receiver is quite directional, and the Power Company trouble shooters go out with their Ford and loop receiver, skim along the road and can note down each and every pole where there is trouble, without even leaving the car. It is perfectly possible for a lineman to inspect the line at a speed of sixty miles an hour, as far as the accuracy of the test is concerned. The loop receiving tester set has never shown a leakage without closer inspection revealing a broken insulator, and it has never passed a broken insulator without revealing it by sound. The officials of the Southern Colorado Power Company say they are very well satisfied with this method of testing and will use it on all their lines.

Insulators are subject to damage or failure from three sources: mechanical stresses, such as being struck by bullets or stones; electrical stresses, such as lightning or other excess voltage surges, and atmospheric stresses, due to sudden variations in the temperature. Any of these causes break the insulators and permit leakage of current, often sufficient to interfere with service and compel a shutting off of the power until the fault can be repaired.

In most cases, this trouble occurs at the top of the insulator, where it cannot be seen even when a lineman has climbed the pole. The use of field glasses sometimes helps to detect insulator breaks, yet even the glasses often fail to show the smaller breaks. In such cases, the only solution is to determine the approximate location of the leak, install a relay contrivance to carry the current past a

### Radio Clubs Can Help

We do not see why local radio clubs can't have a trouble squad equipped with a loop receiver to do electrical detective work on "power-line static" in the way described in this article.

By proper cooperation between the radio club amateurs, the broadcast listener, and the power companies, it would seem that radio life could be made more liveable for everybody.

—THE EDITOR.

certain point, and carefully go over all the poles in that area.

E. F. Stone, superintendent of power lines for the Southern Colorado Power Company, says: "While many experiments have been made to determine means of locating insulator leakage, this is the most satisfactory of

all. I believe this method is infallible, and power companies throughout the United States in the very near future will undoubtedly adopt this means of testing their lines."

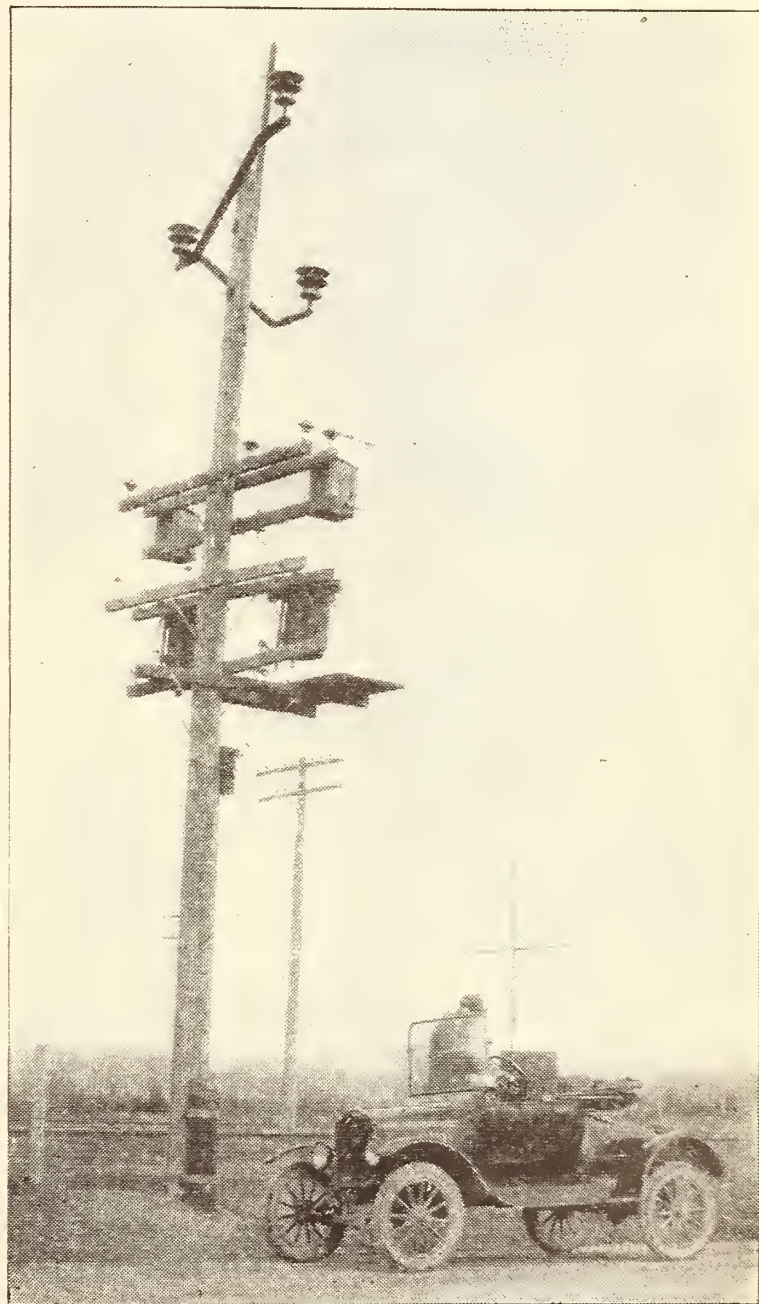

TESTING A TRANSFORMER

One lineman with this car and loop receiving set can inspect a 66,000 volt power line with 28,530 insulators where it took many linemen at a total cost of \$6,000 for salaries and replacements under the old system



A RADIO EQUIPPED CAR

Ready for a transcontinental trip these four men plan. Camping and cooking gear and the dog are stowed neatly on the side of the car. The receiving set will help them while away many a dull evening when they are camped along the roadside

## The March of Radio

### Real Information on the Size of Radio Audiences

**T**HREE well known Chicago stations recently called on their audience to send in votes as to the type of program they wanted, and the number of letters received furnishes some clue to the size of the radio audience of to-day. We are told that one station alone received 170,699 letters, a truly remarkable figure. Starting with this known quantity, the statisticians of the stations, ever enthusiastic and optimistic, calculated the audience of this station as 8,534,950—"some audience," as we say in our crude modern parlance.

Now how did they arrive at this astounding figure? Our guess is something like this. Let us say that accurate statistics show that of all the children born, 50 per cent. of them reach the age of twenty. Therefore, we say, as a mother codfish lays 9,000,000 eggs, 4,500,000 mature cod will be the offspring of each effort the codfish makes to perpetuate her species. Naturally the question is asked—what has the mortality among children got to do with codfish and the obvious answer is—nothing. By such logic however do our broadcast managers reach their fearful and wonderful results.

If a business man sends out circular letters, he receives a certain number of replies; by considering enough of such cases we arrive at the conclusion that in answer to circular letters perhaps 2 per cent. of replies may be expected. For other types of circularization perhaps a different return may be expected. For example, in the annual election of officers for our national engineering societies (carried out by mail) about one member out of four takes the trouble to send in a vote. From consideration of cases of this sort, the managers of the broadcast stations came to the conclusion that for every letter they got from the unseen audience there were at least fifty listening. On this basis the number of letters received, multiplied by fifty, gives the size of the audience.

This is a most flagrant example of misapplied methods. The number of replies received bears no more relation to the known figures of letter circularization than does the mortality of humans to that of codfish. From what we know of the appreciation of radio programs from the high class stations, we imagine that not only one out of fifty would answer such an inquiry as the Chicago stations sent out, but probably more likely one out of five. Using

the one to five proportion gives a radio audience of about 800,000 for one station. Even this figure, arrived at by reasonably conservative calculation, is enough to stagger any one used to treating figures with more respect than do the radio publicity men.

### Radio Maps for New York City and Washington

THE radio surveyors of whom we have spoken several times lately have just finished maps of New York and Washington, and their surrounding country. Their signal-measuring apparatus, mounted in an automobile, has made hundreds of measurements which, properly plotted on a map of the district, enables them to draw a radio map looking much like the relief maps of our physical geography days. By drawing lines through the points of equal signal strength, a map is obtained which resembles exactly the topographic maps put out by the geological department of the government. Instead of signifying points of equal height however, these radio contour maps show points of equal signal strength.

With the aid of one of these radio maps, our imagination, if at all active, can follow very closely the radio waves as they tumble and twist their way over the earth's broken surface. Behind mountain ranges we find but little signal, it having been absorbed by the hills; along sandy, moist country the signals travel straight, with the regular motion of rollers hundreds of miles out at sea; over the cities the progress of the waves resembles that of the ocean rollers as they approach a rocky shelving shore. Here their direction of travel changes and twists, the waves reflected from rocks and shore meet head on at some places producing extra turbulence while at others, perhaps behind a projecting rocky ledge, the water is still. No waves at all penetrate here—it is a dead region in so far as wave motion is concerned.

But perhaps further behind this rocky ledge, the waves which have been climbing shoreward twist around and meet, thus destroying the

“wave shadow” the ledge has set up. So it is with radio waves; absorbed as they travel over the cities' squares, piled high with steel structures which absorb the waves' energy, radio dead spots are found. But farther along the same course, in the same direction from the station, the waves from the two sides of the city pour some of their energy into the shadow space to such an extent that the signals actually get louder with increasing distance from the station. So it would be with water waves dashing against a small island; a boat resting in the lee of the island would find no wave

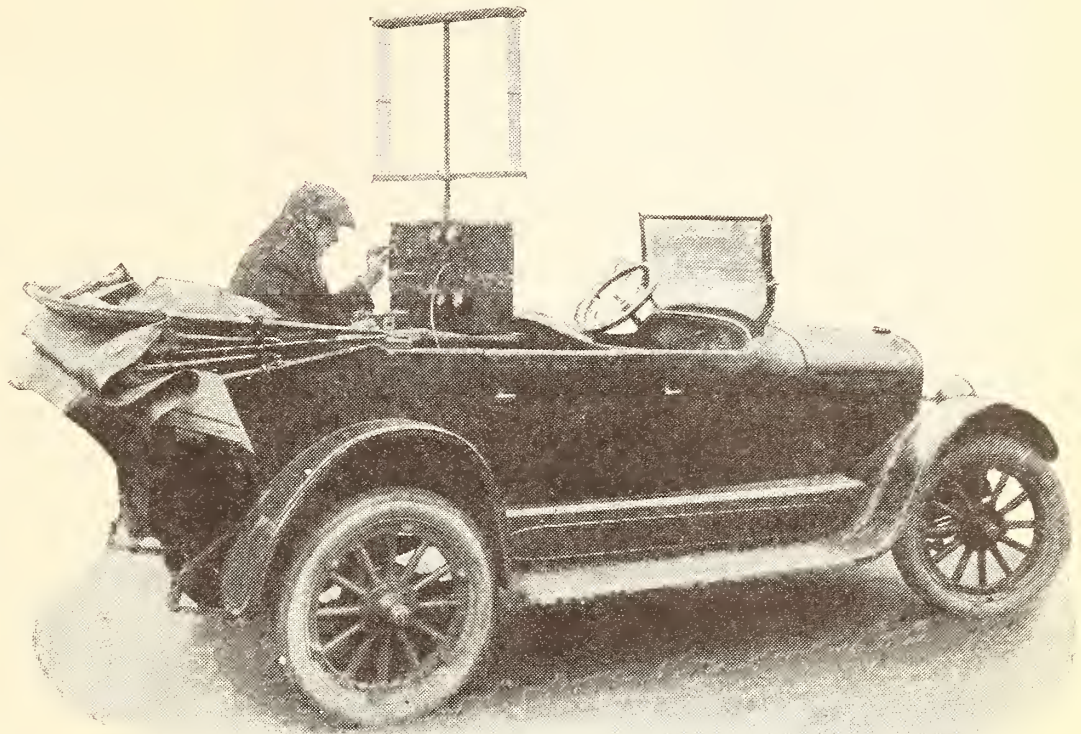

MAKING A RADIO MAP

With a special loop receiver equipped to make particularly accurate measurements the operator measures very carefully the signal strength of the station at various points. The radio map we printed in March of New York, was an equipment of this kind

motion, at all, but if allowed to drift with the wind, away from the protecting shore, the ocean soon becomes rough and turbulent due mostly to the waves which have passed around the island on either side; they spread into the waveless region to destroy its calm.

You should get a radio map of your city as soon as you can; it may well be that the comparatively poor reception you are able to get is due to the fact that you are in a dead zone; your friend a short distance away, who boasts of the superiority of his reception, may have unknowingly picked out a very active radio spot for his residence. Perhaps in the future the landlords will talk of the radio features of their location as well as the exposure and other things we now hear about.

## Is the Radio Corporation a Bad Trust?

**I**N OUR last issue we gave a résumé of the Federal Trade Commission's report on the situation in the radio industry. The findings showed conclusively that a stringent monopoly existed in the radio field. In the report no recommendations were made as to how the

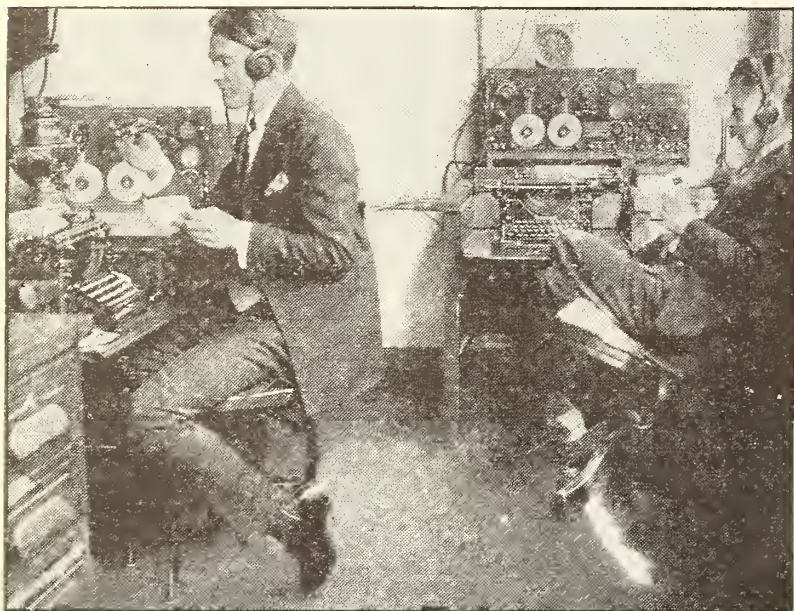

### WHERE THE "SHENANDOAH" GOT HELP

A corner in the office of Naval communications, Washington. These naval radio operators control NAA, Arlington, and NAL, Washington Navy Yard. When the Navy dirigible *Shenandoah* recently broke away from her mooring mast at Lakehurst, N. J., and fought high winds for nine hours, these two operators were in close touch with the runaway airship

situation should be remedied because the report requested by Congress was to give the facts only. But soon after the report was issued, the Trade Commission started court action to have the Corporation expose its alleged monopolistic workings.

The complaint specifies certain acts of the members of the Corporation which, in its opinion, were carried out "for the purpose of, and with the effect of, restraining competition and creating a monopoly in the manufacture, purchase, and sale in interstate commerce, of radio devices and apparatus, and other electrical devices and apparatus, as in domestic and transoceanic radio communication and broadcasting." The acts referred to are grouped under five headings.

The Corporation:

1. Acquired collectively patents covering all devices used in all branches of radio, and pooled their rights to manufacture, use, and sell, radio devices and then allotted certain of the rights exclusively to certain respondents.

2. Granted to the Radio Corporation of America the exclusive right to sell the devices controlled, and required the Radio Corporation to restrict its purchases to certain respondents.

3. Restricted the competition of certain respondents in the fields occupied by other respondents.

4. Attempted to restrict the use of apparatus in the radio art manufactured and sold under patents controlled by the respondents.

5. Acquired existing essential equipment for transoceanic communication and refused to supply to others necessary equipment for such communication and also excluded others from the transoceanic field by preferential contracts.

Now from what we know of radio it seems quite likely that the Radio Corporation has done practically all these things. Whether the actions have been carried out in such a manner as to warrant legal steps to dissolve the Corporation is not so certain. Government officials were present when the plans of incorporation and program of activities were made up and, undoubtedly, high legal talent has passed upon the legality of the plans of the radio trust which apparently comes dangerously near an infringement of law. Since the Federal Trade Commission has been so unsuccessful in many of its previous suits, the Radio Corporation is probably not much disturbed by their attempt to use the big stick.

Should the Corporation be haled into court and made to bring in books showing its activities, its financial schemes, its manufacturing and selling campaigns, etc., with costs of production and sales, the radio public would get much interesting information on the vacuum tube situation. What is the manufacturing cost of an ordinary triode, and what is the proper selling cost when reasonable profits and development charges have been cared for? In the old days of the De Forest audion, when hand work was the rule and tubes were turned out by the dozen, we can see that the proper selling price might have been the five or six dollars we had to pay even then for the audion. But now when tubes are machine made, and almost four million a year produced, can the reasonable cost to the public be the same as it was in the early audion days? We know of course about "development costs," the research laboratories must be well repaid for the time and material spent in developing the present tubes and for research into future improvements. We also know that patents have been well paid for in certain instances, and we know

that a high depreciation must be charged off on machinery and auxiliary apparatus used in making types of tubes which may be superseded to-morrow.

Granting this, should the public be obliged to pay five dollars for a triode whose actual manufacturing cost we venture to guess, does not exceed fifty cents at the outside? How much does the Radio Corporation take for its share, since the tubes nominally go through its channels? How much may the dealer keep for storing the tubes on his shelves a day or two and then passing them out over the counter? This information would be a very welcome outcome of any possible court action arising from the Trade Commission's complaint against the Radio Corporation.

Is there a monopoly in the manufacture of triodes? The answer is—Yes. Is this an illegal situation, one which warrants government interference with threats of prosecution if the trust is not dissolved at once? No—certainly not. The reason is because the government itself grants the monopoly. This point must be borne in mind by those who, disgusted with high prices, would give unlicensed manufacturers the right to manufacture triodes in spite of the patent situation.

A patent is an out-and-out monopoly granted to the inventor for seventeen years, as a reward for those diligent labors which have brought into being a new and useful device. Theoretically he can hold up the public for any price he decides to charge and he is doing nothing illegal. And if some company buys the invention the monopoly becomes theirs, legally, and they legally have the right to charge any price the traffic will bear. So that this "trust" situation, in so far as it affects the average listener-in, has no illegal aspects at all.

It frequently seems that this patent law itself is eminently unfair to inventors and prospective inventors, but it is not evident that any change would relieve the situation. This invention game has no second and third prizes; no matter how much such prizes may seem to be deserved.

We will say that A discovers, accidentally, how to make the audion oscillate, at ten o'clock on a Monday morning. He gets his idea certified by a notary so as to have an authentic record and in time files a patent application. On the same day, in another part of the coun-

try, B finishes a series of carefully planned experiments and succeeds, at eleven o'clock on the same Monday morning that his years' work is rewarded—the audion will oscillate. So he files a patent application and soon finds himself in interference with A. When the case is heard, A of course is decided to be the inventor and B gets nothing, although he is really a much cleverer and more capable experimenter than A. Such situations, apparently unfair, probably exist in most of the pathways along which striving man progresses.

### Argentina's New Station

RECENTLY there was opened a high power radio telegraph station at Monte Grande near Buenos Aires, Argentina. Messages of greeting were sent from the station to the rulers in The United States, Great Britain, France and Germany, the reason for the international greeting being the fact that the station is owned and operated jointly by the radio companies of these four countries. Although ownership is nominally vested in an Argentine corporation, the Transradio Internacional, this company is owned by the Radio Corporation of America, the Marconi Company, the Compagnie Générale de Télégraphie sans Fils



"BEHIND THE SCENES AT A BROADCASTING STATION"

Eight young artists resting after their juvenile program recently broadcast from WOR, Newark. The microphone was not on the air during the ice cream eating

and the Telefunken Company. Separate stations had been begun by the German and American companies when it was decided to pool interests and let in the other two radio concerns.

The station will communicate directly with the United States and Europe with probably

the same reliability as the Radio Corporation's present transatlantic links have shown. The cost of this station is about five million dollars, according to the report, so it is evident that a considerable radio traffic with South America must be built up if the station is to prove a profitable venture. This is another commercial bond south of the equator.

### New Standard Wavelength Stations

**I**N ADDITION to the stations we have recently cited, the Bureau of Standards now feels that the following stations have been holding to their specified wavelength with sufficient constancy to warrant mention as secondary standards of frequency. WWJ at 580 kilocycles has a greatest deviation of 0.2 per cent. and an average deviation of 0.1 per cent.; WCAP at 640 kc with a greatest deviation of 0.3 per cent. and an average of 0.1 per cent.; WOS at 680 kc with a maximum deviation of 0.2 per cent. and an average deviation of 0 per cent.; WSB at 700 kc has a greatest deviation of 0.3 per cent. and an average deviation of 0.2 per cent. These are in addition to WGY at 790 kc and KDKA at 920 kc.

With a few more stations well distributed throughout the broadcasting band, the accurate calibration of a receiving set will soon be a very simple matter.

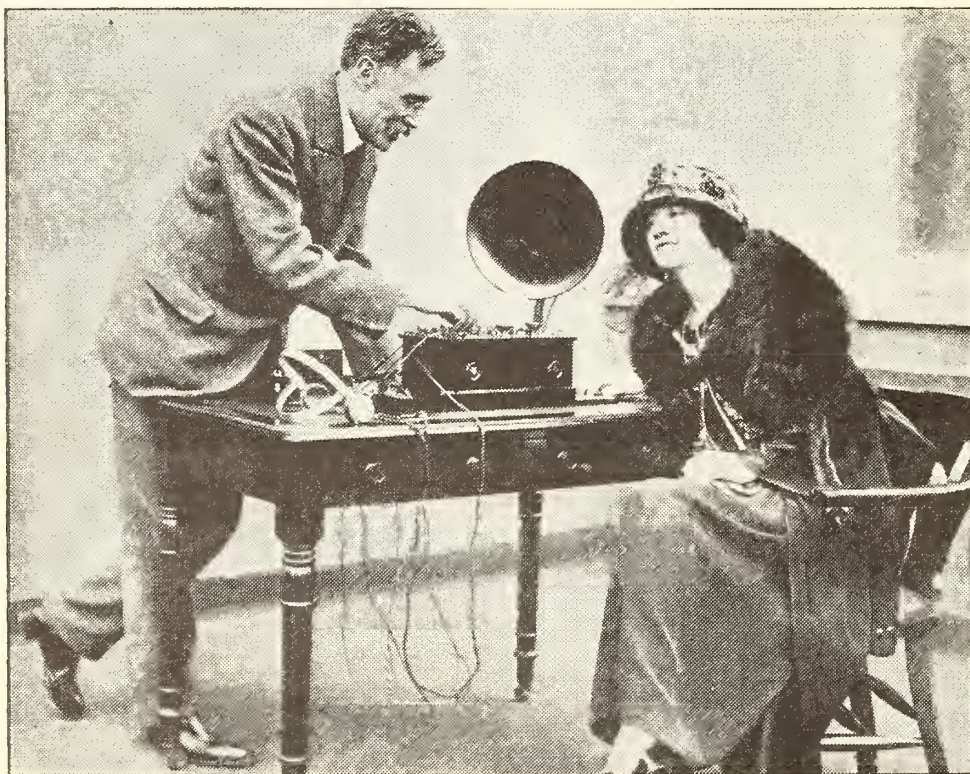

© Underwood & Underwood

LADY TERRINGTON, ANOTHER WOMAN MEMBER OF PARLIAMENT

Who was recently elected for Wycombe, Bucks, listening to what must be quite entrancing radio signals

### Keeping Close to Employees

**I**N A transcontinental railways system it is evident that those responsible for the detailed operation and maintenance of the equipment cannot but feel very far away from the executive officers, whom they perhaps never see, and hear of only occasionally through company bulletins. Feeling that a closer connection between the President of the road, and the men who do the work, will be beneficial to employees and road alike, Sir Henry Thornton, for some years a railway executive in the United States, but now President of the Canadian National Railways, has announced his intention to make it possible for a radio receiving set to be in the home of every one of his employees. The sets are not to be given away, but are to be purchased by the railway and sold to the employees at cost, with long time payments allowed.

It is his idea to broadcast from some central station (or several if necessary) his ideas regarding improvements in the operation of the roads as well as in the working and living conditions of the employees. It seems quite likely that information about the road and its aims and prospects, delivered by word of mouth of the President, will prove of much more interest to the operatives than the printed bulletins, often thrown away before being read.

And of course the fact that the receiving sets are perfectly good for bringing in entertainment of various kinds, as well as the talks of the road's President, will make him try to say something of real interest to his listeners—otherwise his voice will be dissipated over Canada's waste spaces without reaching the ears of a single employee.

The scheme has received quite favorable comment from the press and its results will be awaited with interest by other enterprises which are organized along the same line as is the railroad.

### Down to the Deeps with Sets

**T**WO or three items appearing recently add to our knowledge of the laws by which radio waves travel. At Bisbee, Arizona, a group of radio enthusiasts

descended 1,400 feet in the Junction mine with radio receiving sets "to see what they could see."

A radio wave does not stop at the surface of the earth, but penetrates into the surface according to a law well known to radio engineers. The penetration of the radiation into the earth is very much the same as the penetration of a beam of light into a fog, or the penetration of "cold" into the earth as the winter comes on. How far does a light penetrate into a fog? Evidently no definite distance. It gradually gets weaker and weaker as the distance into the fog increases. Furthermore the beam will surely penetrate much farther into one of our fogs, than if it has to force its way through one of London's "black" fogs. Similarly, the radio waves penetrate better into a dry non-conducting earth than they would into moist earth, or earth containing coal veins, or veins of conducting ores.

At the same time the experimenters in Arizona were getting signals 1,400 feet in the earth, others in a tunnel under the Hudson River were elated because they got signals 100 feet below the river's surface. This was perhaps a more remarkable example of radio's travel than the other because the river is salt water (a comparatively good conductor) and the waves had to penetrate the cast iron casing of the tunnel besides.

Neither of these occurrences violate the known principles of radio transmission, but rather confirm them. If one listens to the radio signal received in a submarine as she

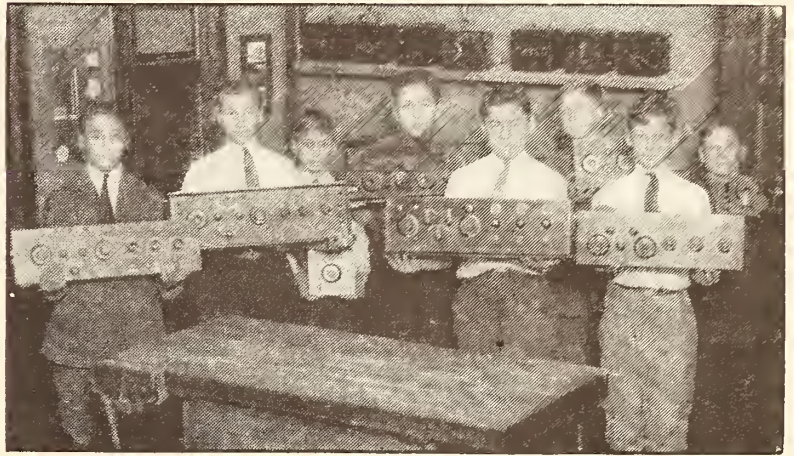

RADIO CRAFTSMEN IN SCHOOL  
Boys of Public School No. 6, New York,  
with radio sets they built themselves

submerges, antenna and all, and gradually goes lower the intensity of signal falls off just about as the beam from an arc lamp falls off as we penetrate a dense fog.

### No Political Broadcasting in England

ONE of the ancient customs of the English Government was called to our attention by recent press dispatches announcing that the King's speech to Parliament was not to be broadcast. This speech is prepared not at all by the King, but by the party to which the Government's affairs are temporarily entrusted; the King is however allowed to read it as though it were one of his own composition. How many boys in school wish that this King's privilege of using some one else's ideas might be extended throughout our democratic school system!

Now, as the speech has nothing to do with the King himself, but is really political propaganda for the party in power, the Cabinet, which had previously ruled that the broadcasting of political speeches in England was not to be allowed, decided that the King's speech might not be broadcast. Surely no one needs to fear the power of the King in this labor-controlled, democratic, monarchy; his officials even deny him the privilege of broadcasting the

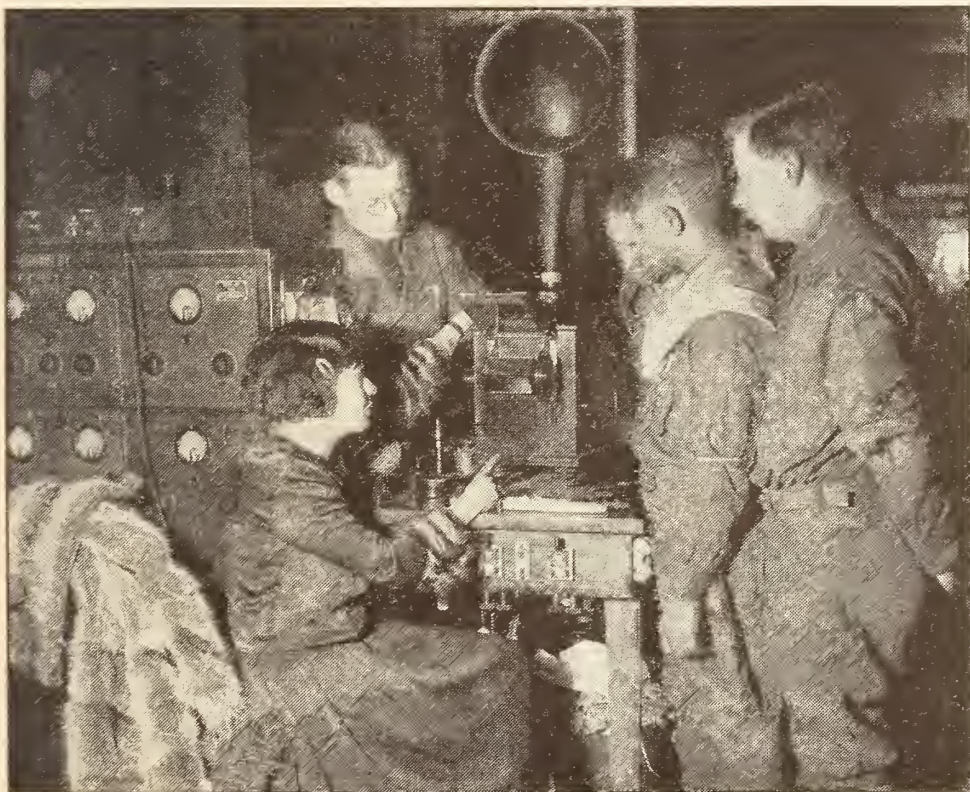

BOY SCOUTS CONTROLLED WJZ FOR A DAY

In their campaign for one thousand new Scout leaders in Greater New York. The boys announced and managed the station themselves. The group is examining the oscillograph, the instrument which enables the control operator to "see" what the station is sending, and so to check the quality of the broadcasting

speech which they themselves have written for him.

### Spark Interference

**I**F THERE is one source of annoyance more disturbing than another in broadcast reception it is that due to spark stations sending code. Of all the irritating and exasperating experiences we have suffered, the hoarse, rasping dots and dashes caused by the ordinarily musical note of the spark station interfering with the carrier wave of the broadcast concert is the worst. And many times it seems as though the spark operator must be actually asleep on his key. Again we can almost hear his sardonic laughter as he pictures to himself the hundreds of thousands of broadcast listeners, each of whom would like nothing better at the moment than to drop him to the floor of his cabin with a gleefully administered tap from a black jack.

Now these spark signals really shouldn't be so disturbing because a 500 kilocycle signal (600 meters) is far enough away from most

At a recent meeting of radio experts in New York representing the U. S. Department of Commerce, the Canadian Government, and the commercial radio companies, it was agreed that spark transmission should be done away with as soon as practicable (perhaps within a year) and that the 666 kilocycle frequency should not be used at all by ships in American waters. This is a most admirable achievement, and we are sure the radio public is much indebted to those responsible for the inauguration of this change in ship radio traffic.

### Radio Cures Tubercular Patients

**W**E HAVE heard of cases of the deaf being made to hear by radio—we have heard of radio being used in the delivery room of a hospital, in place of anaesthesia successfully to dull the pain Nature inflicts, but even then, we were astonished to read a report from a reputable physician that radio was curing his tubercular patients. Was it short waves or long waves? Were they applied internally or externally, or what was the scheme? we asked ourselves. Well, it all turns out to be very simple. The greatest enemy to the health of the tubercular patient is nervousness and worry. He of equable temperament can rest quietly and let Nature mend the destroyed tissues, but the nervous and irritable patient has practically no chance whatsoever. Now, lying in a hospital 24 hours a day, seven days a week, waiting to get better is not conducive to the elimination of worry.

The wise doctor has found that the radio concerts are so much appreciated by his patients, are so much anticipated and looked forward to, that tuberculosis is forgotten. Quiet untroubled rest follows and then Nature steps in to do her share in the reconstruction task. We cannot contradict this doctor's report that here radio is actually curing tuberculosis.



THE NEW YORK CONFERENCE

Which recently met at the call of Arthur Batcheller, Supervisor of Radio, second district, to decide how to reduce interference to broadcast listeners from ships and coastal radio stations. It was decided to eliminate the use of 450 meters, a wavelength in the very middle of the broadcast band, for ship and shore communication.

Four representatives from Canada attended the conference

broadcast frequencies so that but little interference should be experienced except by those who are very near the spark station. But most of the trouble doesn't come from this spark signal frequency. For some reason better known to others than to us, many spark sets near New York Harbor are operated on a frequency of 666 kilocycles (450 meters), right in the middle of the broadcast band.



# The Listener's Point of View



Edited by  
Jennie Irene Mix

## THE DETROIT NEWS ORCHESTRA

Every week day from 3:00 to 3:30 P. M. you can hear, via radio, a concert by this orchestra of eight men from the Detroit Symphony Orchestra. Every man is a virtuoso on his instrument. From left to right they are: Otto E. Krueger, flute and conductor; William Herrick, clarinet; Valbert Coffey, piano and viola; Eugene Braunsdorf, sousaphone; Maurice Warner, Herman Goldstein and Roy Hancock, violins, and Frederick Broeder, cellist

WHEN this prodigy they call "Broadcast Music" first came into existence, it was adopted by a thousand foster parents, nursed by millions of eager admirers. Now, after but three years, some of these foster parents have cast the prodigy aside as too expensive a protégé. Others, and their name is legion, have so spoiled the youngster, permitting him to perform

### By Way of Introduction

The impulse that leads one to brush up on his Shakespeare before going to see a Sothorn and Marlowe or a Jane Cowl interpretation of one of Shakespeare's plays; or that creates sale for librettos before an opera, is at one with the impulse that has prompted this new department. As the ranks of those who listen to symphony orchestras, operas, and all the varied forms of musical entertainment have increased a thousandfold overnight, as it were, so, we believe, there will be a similar increase of interest among our readers in whatever this department may have to tell of the best in broadcast music. Miss Mix has been writing interestingly and authoritatively, in newspapers and magazines, about music for many years.—THE EDITOR.

his tricks for anybody and everybody regardless of the company into which it throws him, that many who were once his friends will no longer have anything to do with him. They fail to see that his shortcomings and defects are due to wrong guidance rather than to himself.

Have you ever stopped to think of that, you who are daily sending out music through the radio to millions of listeners?

All the influence ever exerted by all the musicians who have ever lived, and by all their interpreters, is as nothing when placed against the influence exerted by broadcast music since it came into existence some three and a half years ago as a regular means of entertainment for the public.

And no one seems to know exactly what to do with it. Every hour of every day it is serving as a medium through which is disseminated an incredible amount of trash, even a small portion of which is enough to vitiate public taste. On the other hand, during this short existence, it has brought good music, sometimes even the greatest music, to hundreds of thousands, yes, millions, who otherwise could never hear such music at all.

What is to be the future of this musical giant that can penetrate in an instant to every nook and corner of the earth? This is a question so far from solution at the present time that to attempt an answer would be but a waste of words.

But to watch developments—to do what can be done to regulate this force for the pleasure and enlightenment of those brought into touch with it, and to make of it a constructive force—this is going to be to all who try it, one of the most interesting and fascinating experiences among the thousand and one interesting and fascinating experiences constantly available in this life.

### Can Voice Lessons Be Given Over the Radio?

**E**LEANOR McLellan, the first person ever to try it, says, "Yes." She has given a number of such lessons through the broadcasting station, WJZ, Aeolian Hall, New York. The returns in letters

have been such that she knows that many listeners all over the country not only were interested in what she had to say but understood what she was aiming to make clear to them.

"Of course, I do not think that one can develop a pupil into a singer through radio lessons," she said, when asked at her New York studio to talk about her broadcasting experience. "But there are certain laws," she went on, "governing the correct production of the singing voice that can be explained by radio to those who are anxious to learn these fundamental principles.

"I talked to these unseen students about the correct action of the breath and illustrated this point by explaining many incorrect ways of using it as taught to-day. Then I told them about the right adjustment of the palate and tongue and lips, how to get this adjustment and what happens to the tone when the opposite action is used. In making such points as these I could not but wonder how I was

'getting it across,' to drop into the vernacular. I confess I was astonished, when the letters began to pour in, to find that my radio listeners had listened with greater intentness to what I had to say and had comprehended it more fully than the majority of studio students.

"The reason for this must be that only a person definitely interested in the production of the singing voice would have the patience to listen to instruction on this subject from a teacher who is invisible, and distant from one mile to three thousand or more. As for me, I never thought, once I began to talk, of distance between my listeners and myself. On the contrary, the complete silence gave me an unconscious impression of an intent audience."



ELEANOR MCLELLAN

The first one to give instruction over the radio regarding the production of the singing voice

I should judge from my own experience that all one needs in talking over the radio to get rid of a feeling that no one is listening, is the use of imagination.

"Yes, I am unqualifiedly in favor of using the radio as a means of bringing the best in music to every section of the country. I am not at all in sympathy with the idea entertained by some that if an artist is heard over the radio he will not be in demand for appearances in person in these same localities. To me there is about as much sense in saying that if an artist has sung once in a town, no matter how well he is liked, he will never get a chance to sing there again. And then, too, there is the universal human quality of wanting to see what one has heard something about.

"Even more, there is the benefit to the artist in the encouragement and inspiration that come to him from the response by letter after he has been heard by a radio audience. And let me assure you that every artist, no matter how great, always feels the need of appreciative recognition. It heartens flagging enthusiasm, turns discouragement into ambition. The artist who sings or plays for radio listeners will realize as he never could realize otherwise, that the people capable of appreciating his art are in numbers far beyond what he had before thought possible."

A further proof that there are plenty of radio listeners who want to learn as well as be entertained is found in the fact that Miss McLellan has received many letters asking that

she read for her radio audiences portion of her book, *Voice Education*, published by Harper and Brothers and now being translated into French. The object of the requests is that while she reads she should stop when the opportunity occurs and give illustrations of the points brought out.

### What a Negro Spiritual Really Is

**I**T GOES without saying that those who made a special effort to hear the program of Negro spirituals recently put on by KDKA as a dinner hour entertainment will be shocked to learn that, according to John Powell, they are not Negro spirituals at all.

Many, in addition to being shocked, will be resentful at this bald contradiction by Powell of a long-cherished belief. But as this composer-pianist, whose fame is international, is considered the leading authority in this country on Negro music it is well to give some heed to what he has to say about it.

He tells us that Negro music is seldom heard by the

white man, and that these spirituals with which we are all so familiar and which the Negroes themselves sing for us with such fervor, are simply old hymn tunes modified and distorted by Negro rhythms. This is even true of the Stephen Foster melodies which are much nearer kin to German folk song than to Negro music.

As he was born and raised in "old Virginny," and still lives there when not on concert tours, Powell knows well what he is talking about. Three years ago when he toured Europe and

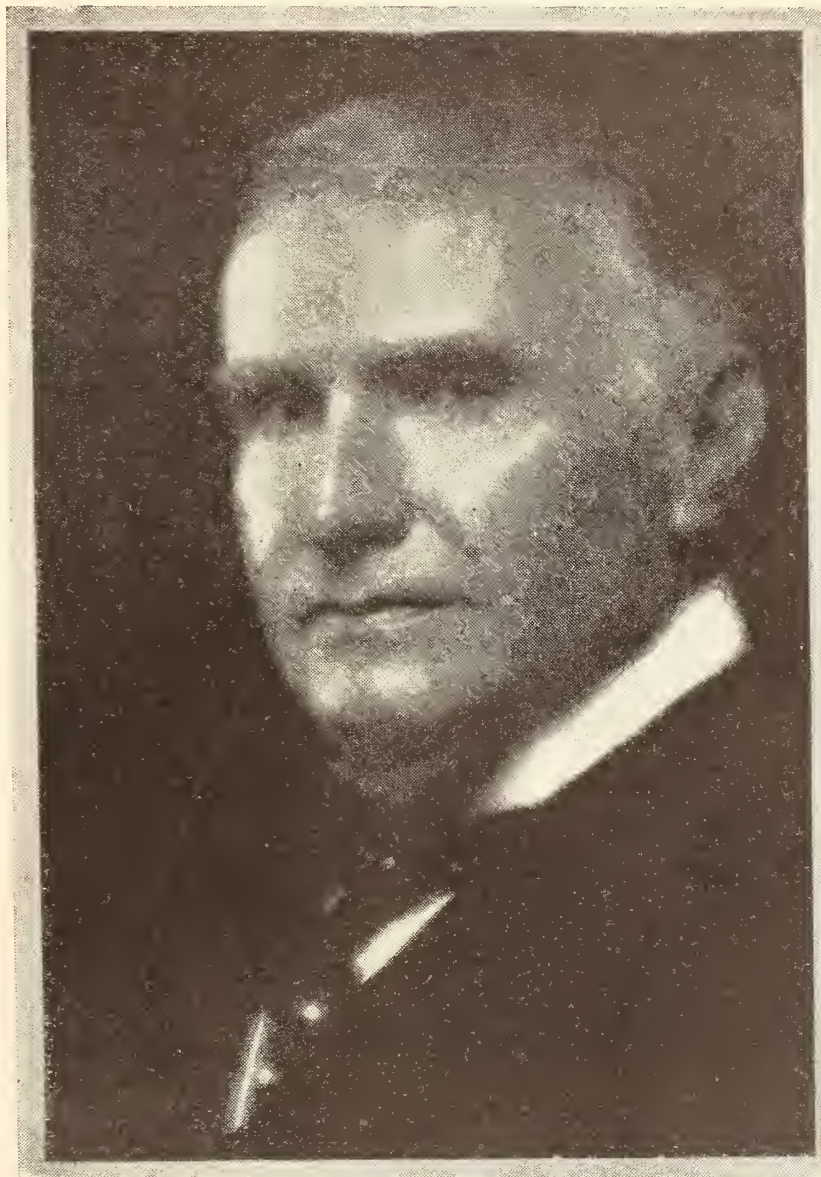

WALTER DAMROSCH

Are there enough people in this country interested in good music to justify broadcasting it? Ask Mr. Damrosch. His reply will be in the affirmative. His recent talks with illustrations at the piano on the Beethoven Symphonies, given at Carnegie Hall, N. Y. before subscribers to the Beethoven Cycle of concerts by the New York Symphony orchestra of which he is director, were broadcast from station WEA-F

England as soloist with Walter Damrosch and his New York Symphony orchestra, Mr. Powell created what was no less than a sensation with performances of his "Negro Rhapsodie" for piano and orchestra. This "Rhapsodie" is generally conceded to be a remarkable interpretation of Negro moods in addition to being mighty good music just as music.

Perhaps sometime Mr. Powell will "tell the world" via radio something more as to why Negro spirituals are not Negro spirituals. He ought to, considering the fact that he has shot a hole straight through a cherished popular belief. All those who listened to that KDKA program should demand that he explain his position to them fully.

How about it, John Powell? Come, it's up to you.

### Medlies

**S**PEAKING of radio, Ossip Gabrilowitsch, famed equally as orchestra conductor and pianist, said a few days ago:

"I seem to be the only man living who has never 'listened in.' Always when I tried to do something interfered. Either that thing you call static got in my way, or I had to get away to that place you call station. Yes, I know that eight men of my orchestra, the Detroit Symphony, play a daily program for radio, and that the concerts we give for children are broadcast. But I—alas! Yet wait! I'll listen in soon, then I'll tell you how it impressed

me—this broadcasting of music—and you can tell the readers of your magazine."

To which the "Listener's Point of View" conductor replied: "If you really do want to 'listen in' I won't have to wait long. You look like a man who can do what he wants when he wants to."

Expecting the announcer at a broadcasting station to get all the titles of the program right is probably asking more than any tongue can tell.

Names of authors, books, titles of lectures. Scientific terms, musical names and terms—

Which reminds us.

There's an announcer at a certain well known broadcasting station whose mind must dwell more on the delights of fishing than the delights of music. Whenever a soloist is a bass he pronounces the word in a way to make the listener want to ask:

"Black or striped?"

The word "bass"—not the fishing variety—again reminds us.

Because the tones of the double basses in an orchestra cannot be heard by radio owing to the low rate of vibrations, the parts written for this instrument are played by many broadcasting orchestras on the sousaphone.

A sousaphone, be it explained, is a huge brass horn which was made for and first used by John Philip Sousa in order that the foundation tones of his band might be



JOHN POWELL

Composer—Pianist. Ask this noted American musician what he thinks about Negro spirituals, and he will very likely reply in that charming Southern drawl of his and with that characteristic twinkle in his eyes: "Are you talkin' about the Negro spirituals what am, or the Negro spirituals what ain't? It must be the ones what ain't for I reckon you've never heard the ones what am."

deeper and more evenly balanced. It is said that the idea of the instrument originated with him.

While the sousaphone cannot, of course, produce a tone resembling the instrument it replaces in broadcasting, it serves an invaluable purpose, so say those who use it, by filling in the harmony as nearly as possible as originally written for the double bass, and it keeps the tone of the orchestra better adjusted than could otherwise be the case with these important stringed instruments out of commission.

After having seen a sousaphone, one cannot but wonder how any man can find breath enough to keep it going, or how, once it gets to going, it can be kept from drowning out all the other instruments with which it is associated.

### Who Will Pay For Broadcasting?

**A**N AMBITIOUS experiment is being conducted in New York to see if the listener is not, after all, willing to pay for the very best musical talent in broadcasting.

The "Radio Music Fund Committee," as they have called themselves, was formed with Clarence H. Mackay, Felix M. Warburg, Frederick A. Juillard, and A. D. Wilt, Jr. as members, and the Central Union Trust Company, 80 Broadway, New York City as depositary for the funds.

The plan, as announced, is to appeal to radio listeners to send in contributions, direct to the bank, of \$1 or more, to allow the Committee



OSSIP GABRILOWITSCH

Those of you who have not heard him conduct the Detroit Symphony Orchestra have probably heard him in recital. For he is equally famous as conductor and pianist. When it comes to the radio, however he's—well—see what he has to say about it elsewhere in this department

to engage the best musical talent—symphony orchestras and individual artists—to broadcast. The Committee announce that all of the funds received will go directly to pay the artists and that none of the contributions will be used to pay for administration expenses.

Station WEAJ of the American Telephone and Telegraph Company, 195 Broadway, New York City, was selected by this committee for the experiment, because, the Committee announced, "of the superior quality of their broadcasting."

There is some doubt whether the artists the radio public is eager to hear can be secured for broadcasting, since most of them are recording phonograph artists, and there is a clause in many contracts, made by phonograph companies which prohibits these artists from broadcasting.

The plan, at present, is by no means national in scope, and we are in some doubt whether it is wise to restrict the application of this fund to pay for the services of artists from one station alone. What are the managers of stations in Illinois, Texas, Nebraska, and California going to say to this?

We are by no means sure that now is the time to start a program of payment for broadcasting, because it will mean an additional burden on the broadcasters and many stations are already wondering where the money for them to continue is to be raised. The difficulty is a national one, and decidedly not local. Since contributions to this fund are invited, nationally, how are listeners at great distances from New York going to feel about the extreme localization of the disbursing of their money?

# Why You Should Have a Wavemeter

And How You May Build it from a Few Parts, Easily Secured and Assembled as Well as Directions for its Use as a Wave Trap and a Tuned Radio-Frequency Amplifier

By GEORGE J. ELTZ, JR.

Manager, Radio Department, Manhattan Electrical Supply Company

IT HAS been wisely stated that the development of a science can be gauged by the accuracy with which the quantities used in the science can be measured. Practically, the advance of the science, and the accuracy of its physical measurements go hand in hand, one reacting directly upon the other. In no particular branch of science has this been more strongly borne out than in radio.

Probably the first instrument developed and one which has been but slightly modified since its inception was the wavemeter. Although radio has advanced most rapidly, the operation of the wavemeter is, perhaps, the most valuable of the radio engineer's measuring instruments.

Every radio set, whether it be a transmitting set or a receiving set, consists essentially of a combination of inductances and capacities so arranged that by their combined action, resonant circuits are created. These circuits are acted on by the incoming signal in the case of the receiving set and fix the frequency of transmission in the case of the transmitting set. The wavemeter also consists of an inductance

and capacity suitably combined to resonate or tune over a band of wavelengths, which may be altered at will.

## TWO TYPES OF WAVEMETERS

WAVEMETERS may, in general, be divided into two classes. First there is the precision wavemeter, designed and constructed to give extremely accurate readings which can be duplicated any number of times. Second, wavemeters giving readings of fair accuracy whose calibration change slightly in use. The construction of the precision wavemeter is difficult and expensive to undertake. The condensers and coils used must be made with great care and must be mounted in such a manner that their physical dimensions will not change with temperature or use over long periods of time. They must also be constructed so that there will be no variation in the electrical characteristics with temperature. Precision wavemeters are of interest only to the scientific investigator who has considerable means at his disposal and who is interested in extremely accurate measurements.

## THE CONDENSER

FOR general measurement work, the ordinary wavemeter constructed of good standard parts is entirely satisfactory. Practically any good variable condenser of approximately .001 mfd. capacity is suitable for use in a wavemeter. The one requirement, which the condenser must meet is that it be one which will not change its capacity with use. This means that the mechanical supports and the construction of the plates must be rigid, so that there will be no shifting of the plates if the condenser is accidentally dropped or otherwise abused. Any number of condensers can be bought which meet this requirement. In addition, it is advisable, although not absolutely necessary, that the resistance of the condenser be low at the frequencies at which it is to be used. If this requirement is met,

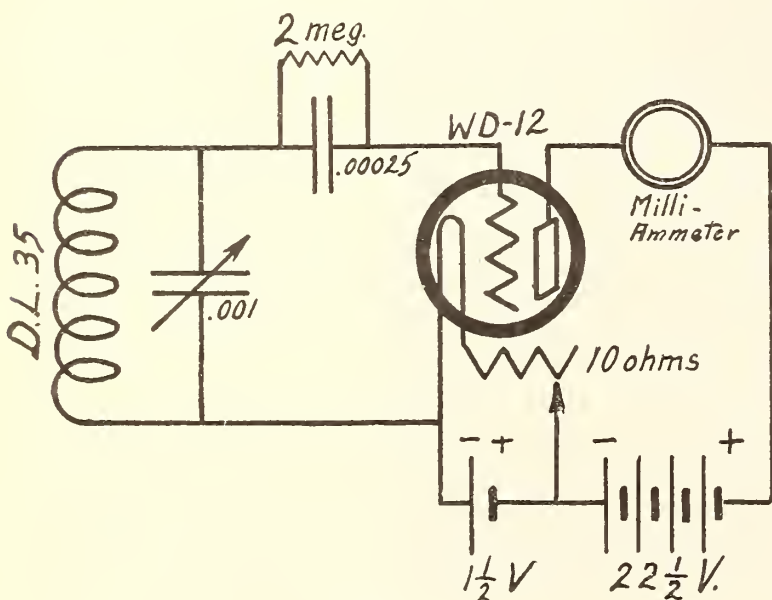

FIG. 1

Typical wavemeter circuit for detection. The tube used may be either UV-200, UV-201-A, WD-11 or-12, or UV-199 and corresponding Cunningham types. A WD-12 or UV-199 tube is most convenient as it permits dry battery use throughout. In the latter case, however, the A voltage should be increased to 3

the wavemeter will give more sharply defined resonant points than would otherwise be the case. Condensers provided with a movable plate vernier or other means of fine adjustment utilizing an extra plate, are not recommended for this service as they require two readings for each wavelength setting. If a vernier adjustment is desired, and sometimes this is desirable, the vernier should take the form of a small vernier knob attached to the dial of the condenser.

#### THE COILS

THE coils used in the wavemeter should be strongly constructed, and should not change their size or shape with temperature or with use. Coils either of the form wound type (duo-lateral coils) or coils wound on hard wood or bakelite forms are suitable for wavemeter construction. Perhaps the most convenient type of construction for the amateur is that employing the form wound coils, such as duo-lateral, De Forest, Remler or Curkoid coils. This type of construction is particularly good since it permits the easy construction of a wavemeter covering a wide wavelength or frequency range. The manufacturers of these coils have constructed a number of coils which are designed to cover the entire wavelength band when used in combination with a .001 mfd. variable condenser. If the coils are mounted on plugs, it is a simple matter to cover any particular wavelength band with great convenience.

#### MEASURING THE WAVE OF A TRANSMITTER

IN FIG. 1 is shown the circuit of a wavemeter designed to measure the wavelength of transmitting or receiving sets. This wavemeter consists of one duo-lateral coil suitably fitted with a plug shunted directly by the .001 mfd. variable condenser. Connected as shown in the diagram is a vacuum tube. This vacuum tube serves as an indicator to show when the wavemeter is in resonance or tune with transmitting or receiving set. In the case of a transmitting set, resonance is indicated by a deflection of the meter from the position at which it would rest if the transmitter were not operating. The wavemeter should be placed a considerable distance from the transmitter when the measurement is taken in order to permit of accurate measurement. When a wavemeter of this character is connected as shown in Fig. 3, it can also be used to indicate the wavelength at which any regenerative or

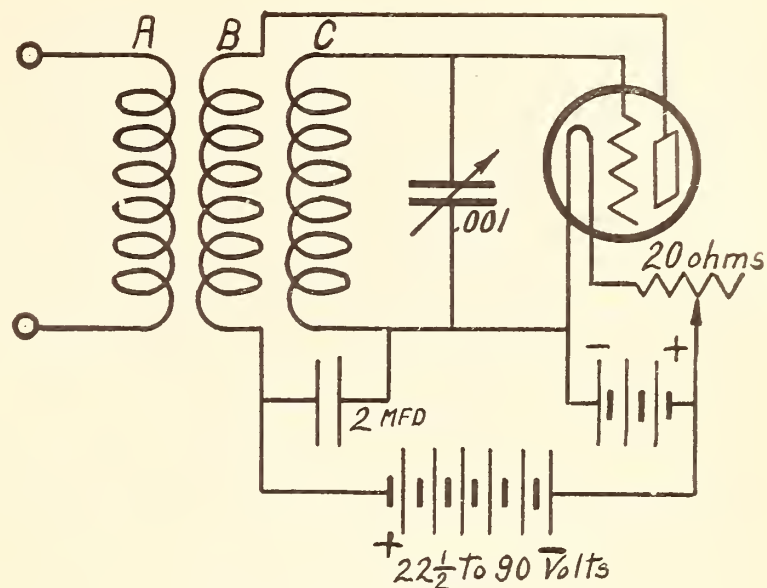

FIG. 2

Typical wavemeter circuit for the generation of oscillations. The use of a UV-201-A or WE-216-A tube is recommended although dry battery tubes will work

radio-frequency receiver is operating. In the case of a regenerative receiver the receiving set must be placed in an oscillating condition before any indication will be received on the wavemeter. The same oscillating condition must be obtained with the radio frequency receiver. The condition of oscillation of a radio-frequency receiver can, of course, be easily obtained by the manipulation of the potentiometer.

In Fig. 2 is shown the circuit connections for a wavemeter designed to create oscillations of a known frequency. This wavemeter utilizes the same coils and condensers used in the wavemeter of Fig. 1. Two coils are added—one a feed-back coil—the other a pick-up coil for use in transferring the energy from the wavemeter over to the circuit where it is desired. Coil C, together with the variable condenser, determines the frequency at which the wavemeter will oscillate. Coil B, the feed-back coil, serves to create the oscillation, the frequency of which is determined by coil C and the variable condenser. Coil A, which can be of the size of coil B, must be varied for best results as the frequency is changed. The same size coil will cover quite a wavelength band; but as the wavelength increases it is necessary to increase the size of coil A if any appreciable amount of energy is required for the measurement.

In constructing either of the wavemeters shown, dry battery or storage battery vacuum tubes can be used. The wavemeter in Fig. 1 will operate satisfactorily with any type vacuum tube. The wavemeter shown in Fig.

2 will operate satisfactorily with all tubes except soft detector tubes, such as the UV-200; but will work best with UV-201-A or Western Electric 216-A tubes. The use of WD-12 tubes in the wavemeter shown in Fig. 1 and a small size B battery permits the construction of a very neat self-contained wavemeter of small dimensions. The milliammeter used should have a range of from 0 to 5 milliamperes.

#### SIMPLE METHODS OF CALIBRATION

**M**OST experimenters and amateurs, who are sufficiently interested to construct a wavemeter, understand its general principles of construction and use, but are puzzled to find a suitable means of calibration. The establishment of broadcasting stations and the accuracy with which the wavelength or frequency of the broadcasting station is set, has solved this problem. The accurate calibration of a wavemeter from a reading obtained on even one broadcasting station is now possible, provided, of course, that the broadcasting station chosen is one of the larger size broadcasting stations, which has had its frequency or wavelength carefully fixed.

Before going into the method of calibration it may be advisable to explain briefly the relation between frequency and wavelength. The electro-magnetic disturbance in the ether travels through the ether at the same speed as light, namely, 300,000,000 meters per second. The frequency of oscillation does not affect the speed at which the disturbance travels through the ether, so that all waves, regardless of length, travel the same distance in the same time. This being the case the amount of space traversed by a single cycle of the electrical disturbance can be obtained by dividing the number of cycles per second into the distance traveled per second. If a radio set transmits at a frequency of 50,000 cycles, or as it is now more commonly called 50 kilocycles, the distance traveled by one cycle will be 50,000 divided into 300,000,000 or 6,000 meters. Conversely, if the wavelength of a station is given, by dividing the wavelength in meters into 300,000,000 the frequency of the electrical disturbance can be determined. The wavelength and frequency are, therefore, dependent entirely on one another.

With the facts above in mind, consider what means there are available for calibration using frequencies or wavelengths known to be associated with the various broadcasting stations. Take for example, station WEAJ of the American Telephone & Telegraph Company, located in New York City and operated on a wavelength of 492 meters or 610 kilocycles. Assume we desire to calibrate the meter shown in Fig. 1. Couple the wavemeter circuit as shown in Fig. 3 to a regenerative receiving set. Tune the receiving set to station WEAJ very carefully. This is best accomplished by causing the receiver to oscillate strongly and then adjusting to the exact point where the howl between the frequency of the broadcasting station and the frequency of the receiver disappears. This is commonly known as the point of zero-beat. Allow the receiver to oscillate strongly on this adjustment, tune carefully with the condenser on the wavemeter until a deflection of the milliammeter is obtained.

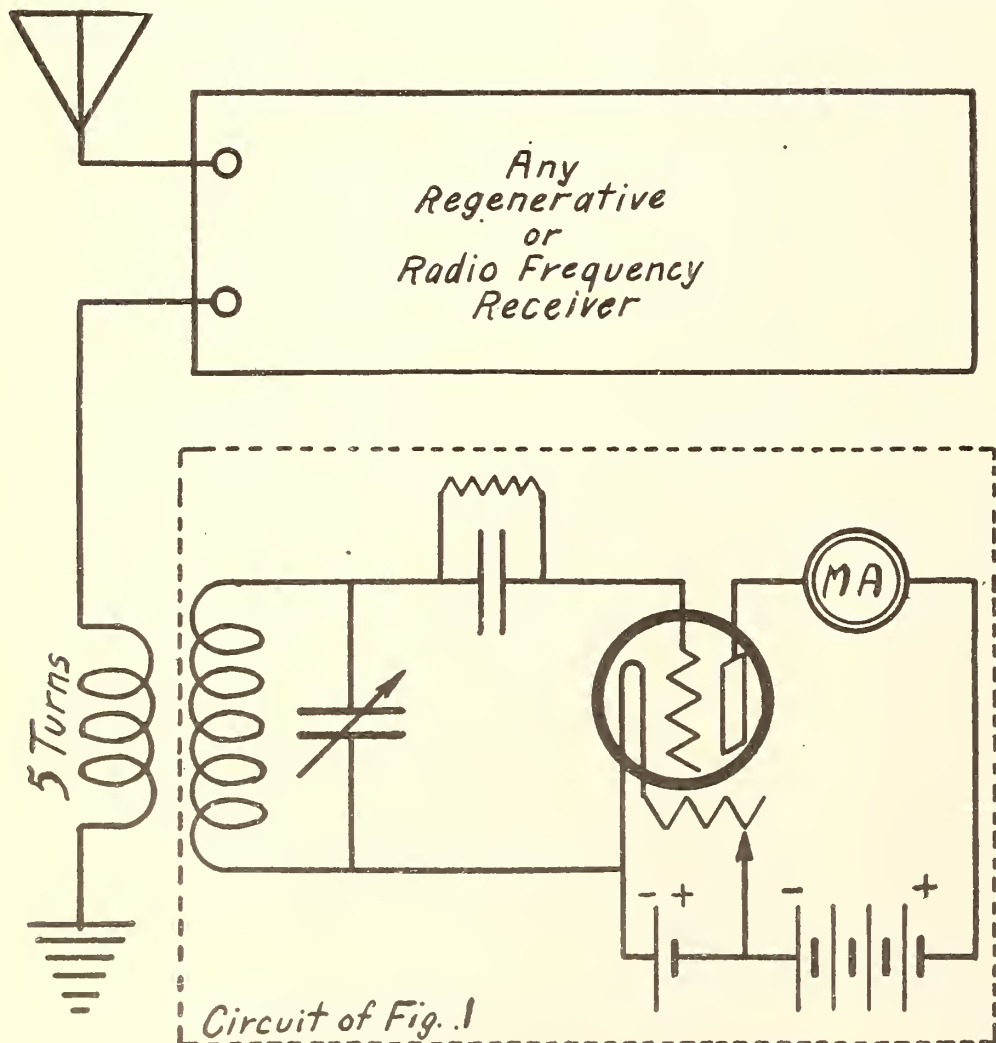

FIG. 3

Method of connection for calibration of receiving set using circuit of Fig. 1. Also method of calibration of wavemeter circuit. Here the wavemeter is shown within the dotted lines



Make a note of the reading of the dial at which this deflection is obtained, marking the reading as corresponding to 492 meters. Repeat this same process with other Class B broadcasting stations until a half a dozen different readings are obtained covering nearly the entire dial. A curve can now be plotted between these readings and the corresponding wavelengths, and the calibration of the wavemeter for intermediate wavelengths obtained from the curve.

If it is impossible to obtain more than one or two good readings on broadcasting stations whose wavelengths are known, use this method. We may use station WEAJ, as an example again. Tune the receiving set as before. Carefully determine as before the point at which WEAJ is obtained. This point will be around 80 degrees on the condenser dial. Decrease the capacity of the condenser in the wavemeter by turning the dial toward zero until a reading of the order of 20 is obtained. At this point, another deflection will be obtained which will be very slight and which will correspond to the second harmonic of 492 meters or 246 meters. Now, keeping the wavemeter set on 246 meters, increase the wavelength of the receiver still keeping it oscillating. At a point on the receiver dials corresponding to a wavelength of 738 meters, another deflection of the milliammeter will be obtained. The wavelength set on the wavemeter (246 meters) is then the third harmonic of the frequency of the receiver. We now have determined a new fundamental frequency (738 meters) to which the wavemeter may be tuned and also by making use of the second harmonic of 738 meters can obtain a wavemeter reading for 369 meters. By the single reading taken at 492 meters we have, therefore, obtained the following readings: 738, 492, 369, 246. These four readings alone are almost sufficient to give a good curve. The same process can be repeated for every broadcasting station obtained on the upper numerals of the condenser dial. So the complete calibration of the wavemeter is obtained. This method of calibration is very satisfactory when the setting on the original frequency is accurately made and when the frequency of the broadcasting station may be relied on. This is not in general as good a method to follow as that of choosing a number of different broadcasting stations. The liability of error by this latter means is not as great.

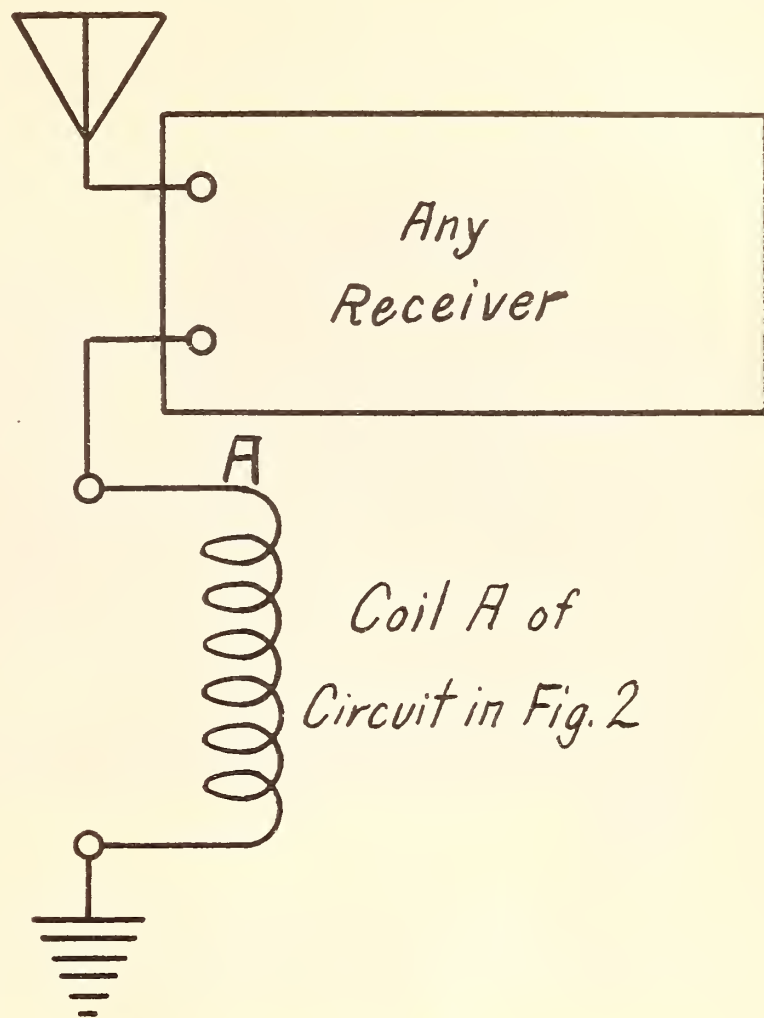

FIG. 4

How to calibrate any receiver using oscillator coil A of the wavemeter shown in Fig. 2 after the wavemeter curve has been made

If a neutrodyne receiver is used, it is not possible to use this method of calibration, and the wavemeter shown in Fig. 2 should be used. For broadcasting wavelengths, the coils should have the following values:

- |    |    |      |             |
|----|----|------|-------------|
| A, | 25 | turn | duo-lateral |
| B, | 25 | "    | "           |
| C, | 35 | "    | "           |

This wavemeter is, in effect, a small transmitting station and should be calibrated in the following manner. Adjust the receiving set accurately to the wavelength of the broadcasting station, turn on the vacuum tube in the wavemeter, and adjust the wavemeter until a squeal is heard indicating that the wavemeter is coming in resonance with the receiving set. Carefully adjust until zero-beat condition is obtained, at which point the oscillator will be exactly in resonance with the receiving set and in turn in resonance with the broadcasting station. Mark down this setting and the wavelength corresponding. Adjust until a sufficient number of readings are obtained to make a good calibration curve.

The manner in which the wavemeter should

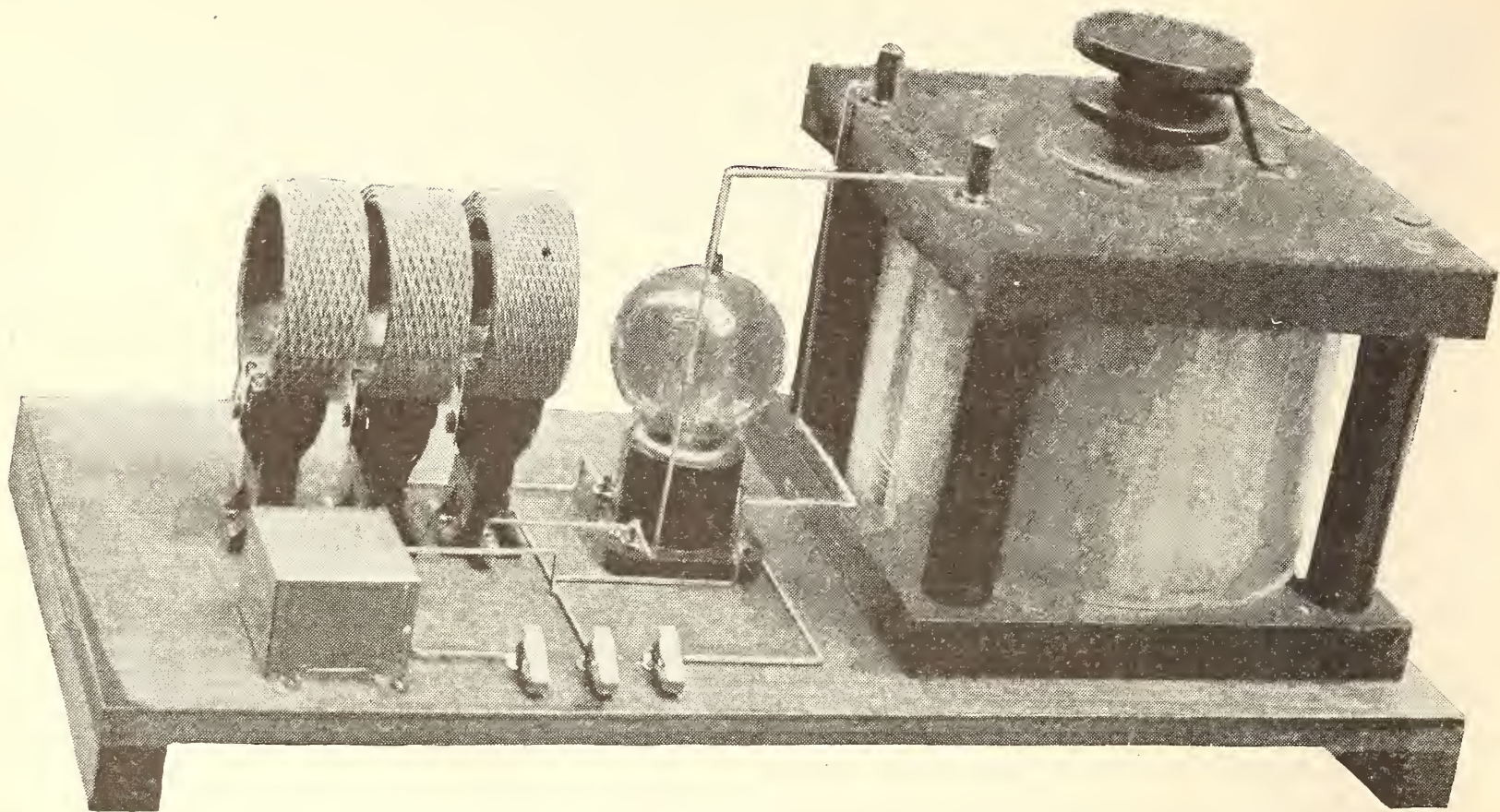

FIG. 5

This is the most convenient form of wavemeter oscillator or calibrated oscillator. This instrument covers a wave band of from 200–20,000 meters. The output may be as great as one or two watts depending on the frequency. The condenser shown is a large laboratory condenser, but any good condenser may be used

be constructed is a question of personal taste. The leads from the coils to the condenser should preferably be as short as possible; but there is no great objection to having the leads long if it is absolutely necessary. Where long leads are used, always use the same wires. Duo-lateral coils may be mounted directly on the condenser or may be mounted on a panel with the condenser underneath the panel. Three wavemeters are illustrated, showing satisfactory types of construction. The wavemeters shown using duo-lateral coils are the ones recommended, as they are most easily constructed and as all the parts necessary for their construction may be obtained from practically any good electrical or radio supply house. The manufacturers of duo-lateral coils have compiled a table showing the wavelength range covered by each coil when used as shown in either Fig. 1 or 2. A copy of this table is given. A wavemeter, such as that shown in Fig. 6, when once built up can be used to cover the entire wavelength range with good accuracy at a minimum expense.

#### MAKING YOUR WAVEMETER MODERN

**A** GREAT many wavemeters have been described in different periodicals showing a crystal detector and a telephone headset as an indication of the resonance point. A great

many other meters have been shown with a high frequency buzzer as a driver or source of energy. The first wavemeter corresponds to that shown in Fig. 1 and the second to that shown in Fig. 2. Present day radio does not permit this rather crude method of detection and generation. It is recommended that by all means a vacuum tube be used in either of the manners described.

For the owner of a regenerative receiver and transmitting set the wavemeter described in Fig. 1, will perhaps, be the most useful. For the owner of a receiving set only, the wavemeter shown in Fig. 2 will be the best. Either or both of these two instruments will be of great value to the owner of a modern receiving or transmitting station, as they permit him to know definitely how his receiving set is operating and what wavelength he is transmitting on.

Modern amateur communication is carried on at wavelengths from 150 to 220 meters. Very few standard wavemeters are supplied to operate at these short wavelengths, particularly if they are also intended for use at higher waves. The method of calibration by means of harmonics outlined above is of particular value in the calibration of wavemeters designed for short wave use. The amateur and operator of a transmitting station will find this method the best he can use to calibrate his wavemeter.

A PERFECT WAVETRAPH

IN ADDITION to using the wavemeter of Fig. 1 as illustrated, the instrument may be used as a wavetrapp for the elimination of an interfering station. A wavetrapp consists of a combination of inductance or inductances and capacities so arranged that the combination opposes the passage of any given frequency. To use the wavemeter shown in Fig. 1 as a wavetrapp connect it as shown in Fig. 8 and in Fig. 9. Fig. 8 shows the connection to be made in the case of a receiver connected to an antenna. Fig. 9 shows the connection where a loop receiver is used. The operation in either case is the same. Set the condenser of the wavemeter at maximum capacity and tune the receiver in the regular manner. When the desired station is received and interference is present vary the condenser of the wavemeter and readjust the receiver. A setting will be obtained where the interference will be entirely eliminated. Sometimes in tuning it is advisable to short circuit the con-

denser of the wavemeter. A test will readily determine if this is necessary. Be sure in

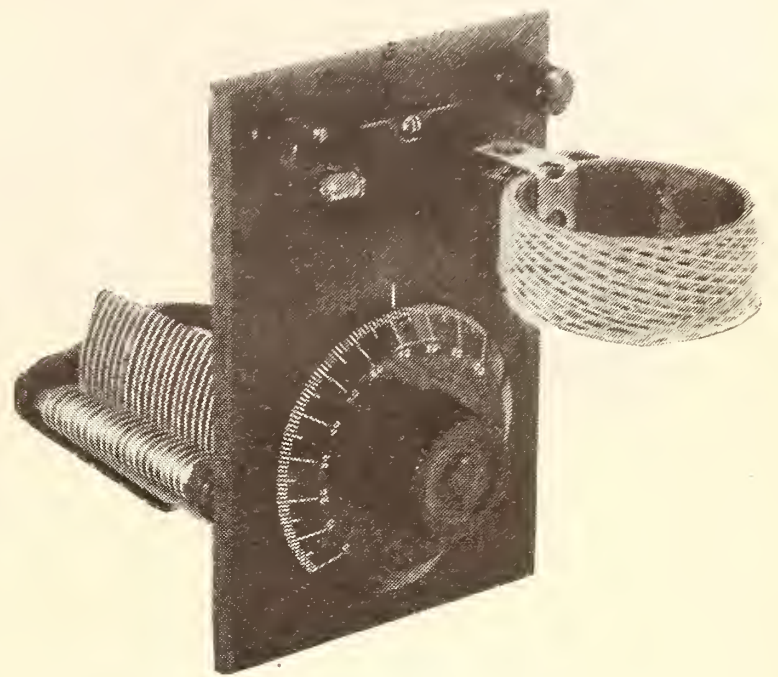

FIG. 6

Wavemeter constructed of form wound duo-lateral or similar coil and variable condenser. This wavemeter will cover any range by changing the size of the coils. The proper size coil to use is shown in the table given below

WAVELENGTH RANGE OF VARIOUS DUO-LATERAL COILS

		No. 200A 3 PLATE		No. 200B 5 PLATE		No. 200C 11 PLATE		No. 200D 21 PLATE		No. 200E 43 PLATE	
CAPACITY RANGE OF CONDENSER IN MICRO-MICRO FARADS	MAX.	49		91		208		418		877	
	MIN.	7		8		10		13		21	
COIL NUMBERS		WAVE LENGTHS IN METERS		WAVE LENGTHS IN METERS		WAVE LENGTH IN METERS		WAVE LENGTH IN METERS		WAVE LENGTH IN METERS	
		Min.	Max.	Min.	Max.	Min.	Max.	Min.	Max.	Min.	Max.
U S or M S	25.	75	105	75	130	75	180	120	245	120	355
U S or M S	35.	105	145	105	175	105	245	160	335	160	480
U S or M S	50.	145	205	145	250	150	355	220	485	220	690
U S or M S	75.	195	290	200	365	210	520	340	715	340	1020
U S or M S	100.	250	380	255	475	260	675	430	930	430	1330
U S or M S	150.	335	550	340	705	355	1020	680	1410	680	2060
U S or M S	200.	435	730	445	935	465	1359	900	1880	900	2700
U S or M S	249.	535	910	560	1170	575	1700	1100	2370	1100	3410
U S or M S	300.	680	1120	690	1430	720	2140	1400	2870	1400	4120
U S or M S	400.	830	1450	870	1880	890	2750	1800	3830	1800	5500
U S or M S	500.	1050	1840	1080	2390	1120	3430	2300	4870	2300	7000
U S or M S	600.	1270	2200	1300	2840	1360	4130	2800	5700	2800	8200
U S or M S	750.	1600	2760	1680	3570	1710	5100	3500	7200	3500	10400
U S or M S	1000.	2090	3660	2140	4750	2240	6900	4700	9600	4700	13800
U S or M S	1250.	2570	4670	2640	6000	2770	8900	6000	12500	6000	18000
U S or M S	1500.	3320	5800	3400	7500	3570	11000	7500	15400	7500	22100

NOTE—In making calculations of the 21- and 43-plate condensers a minimum capacity of 100 micro-micro farads has been assumed which includes the capacity of accessories in the circuit

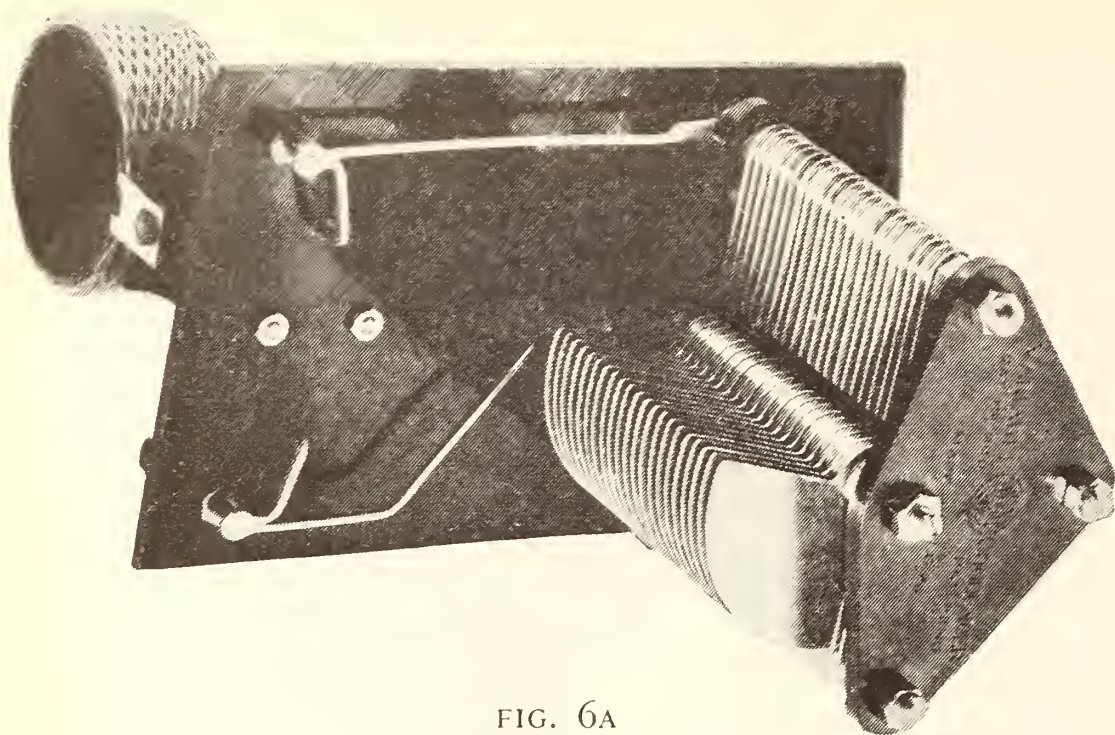

FIG. 6A  
Rear view of Fig. 6

searching for new stations that the wavemeter, when used as a wave trap is not tuned in such a manner that it interferes with the reception of that station.

#### A STAGE OF TUNED R. F.

IN ADDITION to the use of the wavemeter, of Fig. 1 as a wave trap, it may also be used as a stage of tuned radio frequency amplification in front of the receiver. The connections to accomplish this vary slightly with each receiving set, but in general, if the circuit shown in Fig. 10 is followed, good results will be obtained. When using the wavemeter as a stage of tuned radio frequency use only amplifier tubes and omit the grid condenser and leak. The use of a potentiometer on the grid return of the wavemeter is not always necessary, but is shown to make the set complete.

The output coil is shown in Fig. 9 as a 35 turn duo-lateral or similar coil. The input coil is variable between 25 and 50 turns, the exact value of this coil cannot be

set by placing the coil near the inductance in the grid circuit of the receiver. For this purpose the use of  $1\frac{1}{2}$  volt or 3 volt dry battery tubes is recommended as well as the use of individual A and B batteries for the radio frequency amplifier, thus making any changes in the wiring of your regular receiver unnecessary.

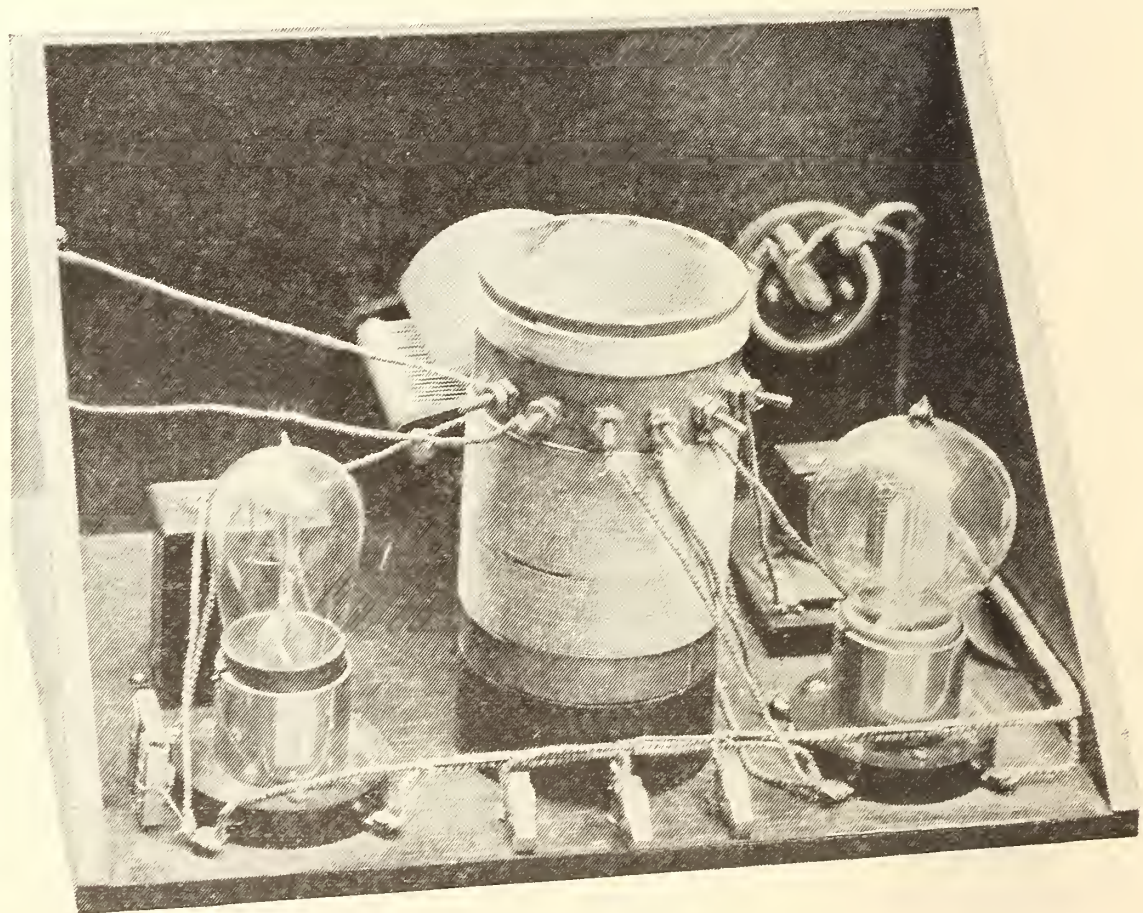

FIG. 7

Experimental type of wavemeter oscillator. The large coil is used as an oscillator, the smaller coil is a modulator creating an audible note. This type is not as convenient to construct as that shown in Figs. 5 and 6. This oscillator is made for use on a measuring bridge. It covers a wavelength band of 200 to 600 meters

given as it will vary with the receiver. The small fixed condenser shown in series with this coil may be omitted if the receiver is of the three-circuit regenerative type and has a variable condenser already in series with the coupler primary. In general, the coupling between the output and input coils is very loose. As a matter of fact the input coil may be entirely eliminated and the primary of the coupler used instead. Long leads may also be used in the output coil, and coupling obtained directly with the

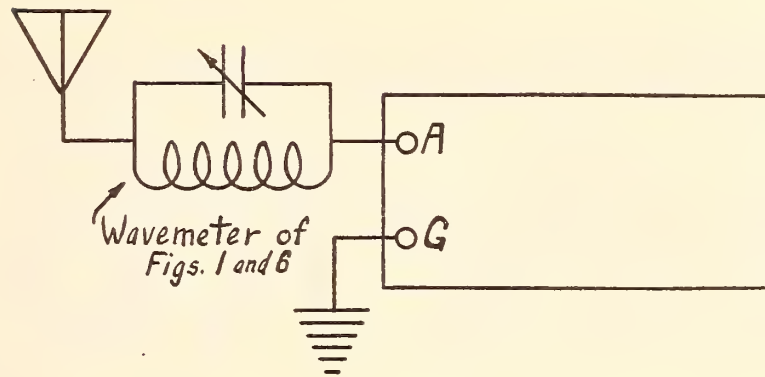

FIG. 8

Connection of wavemeter circuit of Fig. 1 as a wavetrapp. The meter vacuum tube circuit is omitted in this case

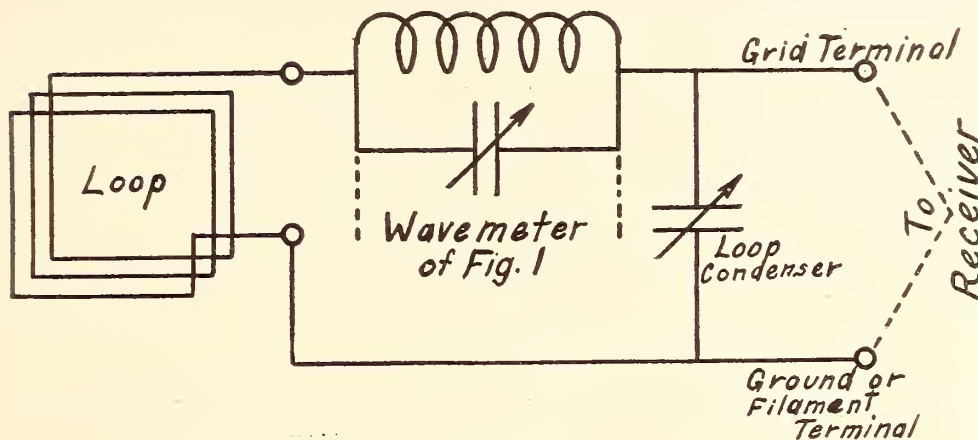

FIG. 9

Connection of wavemeter circuit in Fig. 1 as wave trap in loop receiver. The vacuum tube circuit is omitted as indicated by the dotted lines

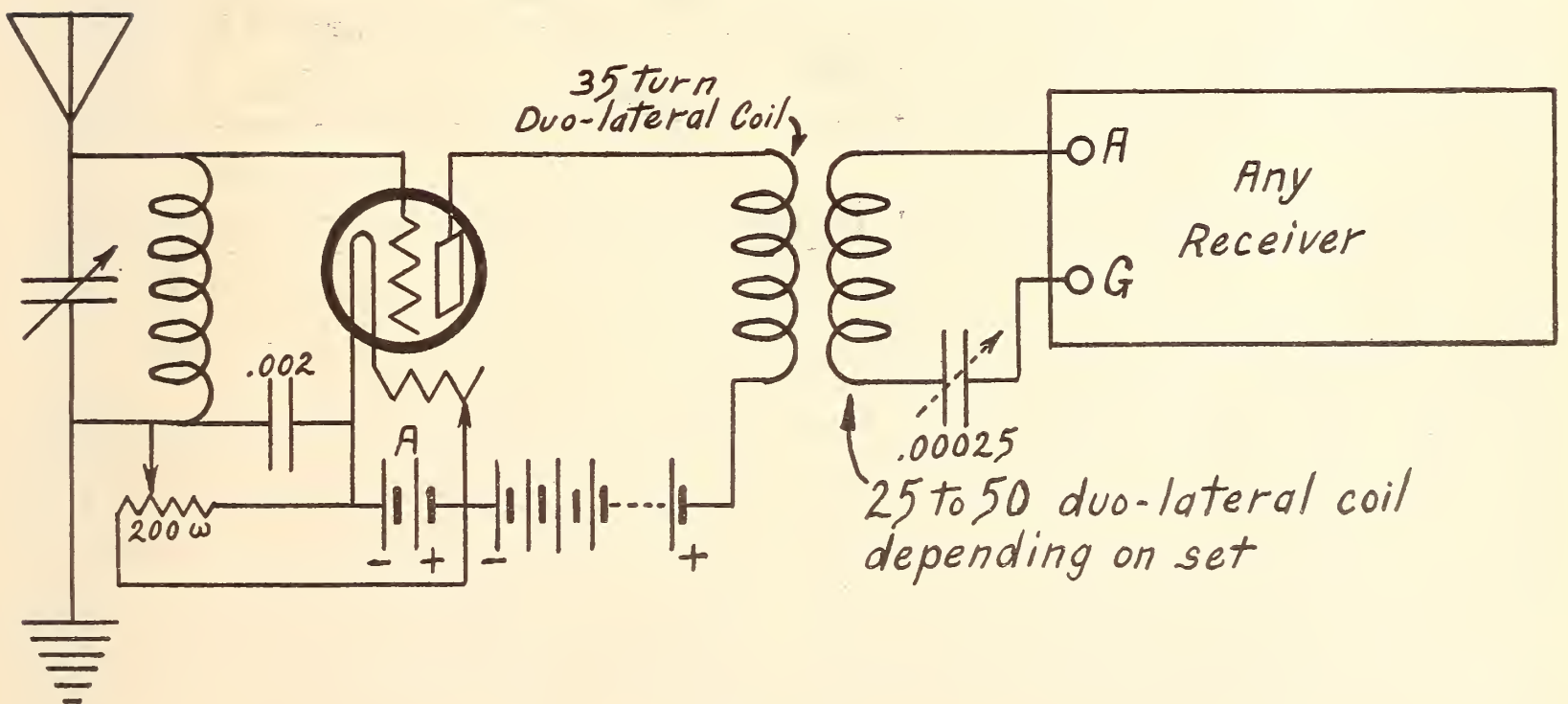
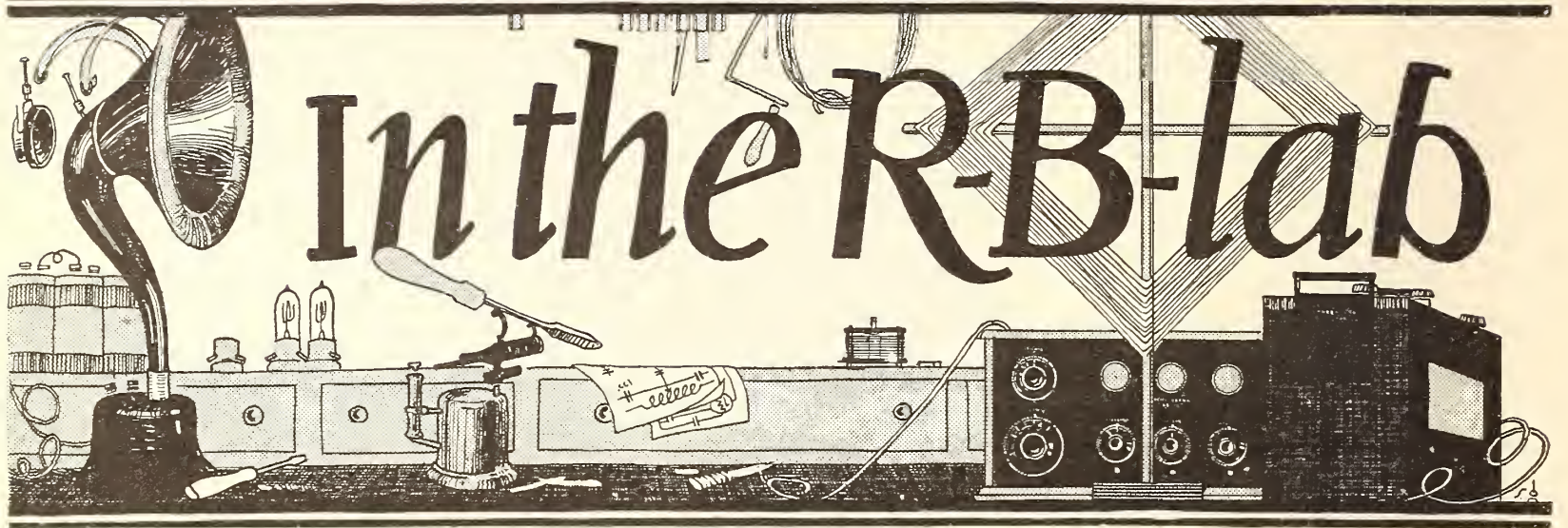

FIG. 10

By the addition of the units shown here the wavemeter of Fig. 1 may be used as one stage of tuned radio-frequency amplification with any receiver. The .00025 condenser may be variable, as shown by the dotted arrow



The "lab" department has been inaugurated by RADIO BROADCAST in order that its readers may benefit from the many experiments which are necessarily carried on by the makers of this magazine in their endeavor to publish only "fact articles" backed by their personal observations.

#### ERRATA

The following diagrams have appeared in recent issues of RADIO BROADCAST, with slight errors in the indicated connections.

January: Page 260, Single-tube reflex plus one stage of audio: A connection should be made between the ground and negative side of the A battery.

February: Page 305, "The Best Inverse Duplex Circuit We Have Yet Seen." The telephone receivers, or loud speaker should be connected in the plate lead of the second tube, just below the connection of the .001 condenser.

February: Page 326, "The Fundamental Circuit." A connection should be made between the ground and the negative of the A battery.

## THE SODION TUBE AND OUR "KNOCK-OUT" REFLEX

**N**O CIRCUIT ever published by RADIO BROADCAST has aroused such interest among its readers as the one-tube reflex set originally described in the November number. Stimulated by suggestions from the hundreds of readers who have written to us concerning this circuit, and by our own enthusiasm for this remarkable little set, this department has not given it up as devoid of further improvement and research. The use of the Ballantine Varioformer, in place of the home-wound T<sub>2</sub>, described in the January Lab, and the reflex plus two stages of audio amplification, in our February number, are the result of our continued investigation. And now we have some more good news.

#### DETECTION AND REFLEX CIRCUITS

**T**HE problem of detection in reflex circuits is one of the most serious involved in the design of such apparatus. As we have had occasion to state before, the three-element vacuum tube with its oscillating proclivities, complicates a reflex circuit to such an extent as to render this form of detection undesirable. This has left the crystal as the most satisfactory detecting medium, and the one which has been used, almost altogether, in commercial types of reflex apparatus.

The Sodian tube, however, being a stable and non-oscillating detector, will immediately suggest itself to the reflex experimenter as a detector. The R. B. Lab experienced little

difficulty in adapting this new tube to the erst-while single-tube reflex.

The Sodion detecting circuit is a simple one, and it was illustrated fundamentally in the Lab department for last month. The input and output circuits are similar to those of the standard tube, and Fig. 1 shows the manner in which the Sodion bulb is substituted for the crystal detector.

The output of the R.F. tube is impressed, through the transformer T<sub>2</sub>, on to the collector circuit (C), (analogous to a grid circuit in a regular tube), of the Sodion tube. The output of the Sodion tube, like that of the usual audion, is a varying plate current, and this is sent through the primary of the reflex audio transformer. The final amplified output, through the telephone receivers, is taken, as usual, from the plate circuit of the first and conventional bulb.

T<sub>1</sub> and T<sub>2</sub> are wound on 2½ inch tubes, the secondaries being wound first, with the primar-

ies on top of them, an insulating layer of paper being placed between. The secondary of T<sub>1</sub> consists of sixty turns of wire, and that of T<sub>2</sub>, of forty turns. The primary of T<sub>1</sub> has sixteen turns, and that of T<sub>2</sub> thirty-six turns. C<sub>1</sub> is a 17-plate variable condenser, and C<sub>2</sub> a 43-plate condenser. T<sub>3</sub> is any good make of audio amplifying transformer with a ratio of about four or five to one—such as the Pacent or Amertran.

The critical reader will observe that the specifications for T<sub>2</sub> and C<sub>2</sub> differ somewhat from those described in the November RADIO BROADCAST for the original crystal set. These changes have been made in consideration of certain characteristics of the Sodion tube (as outlined in this department last month). The Sodion tube works best, and is most selective, when the input has comparatively few turns of wire, the required wave range being secured by boosting with a high capacity condenser. For this reason, the Sodion detecting circuit is not

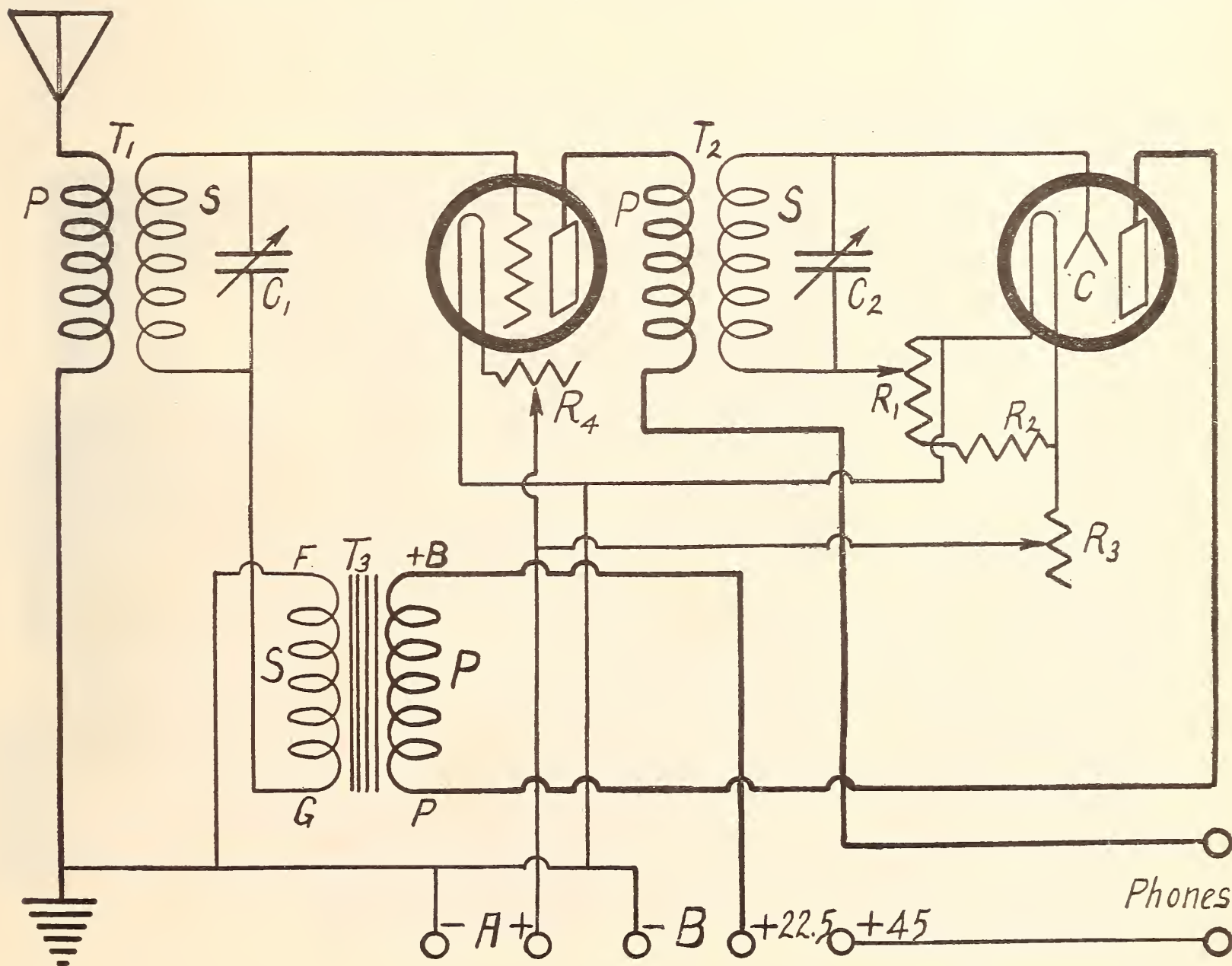

FIG. 1

The "knock-out" reflex circuit with the Sodion tube for detector

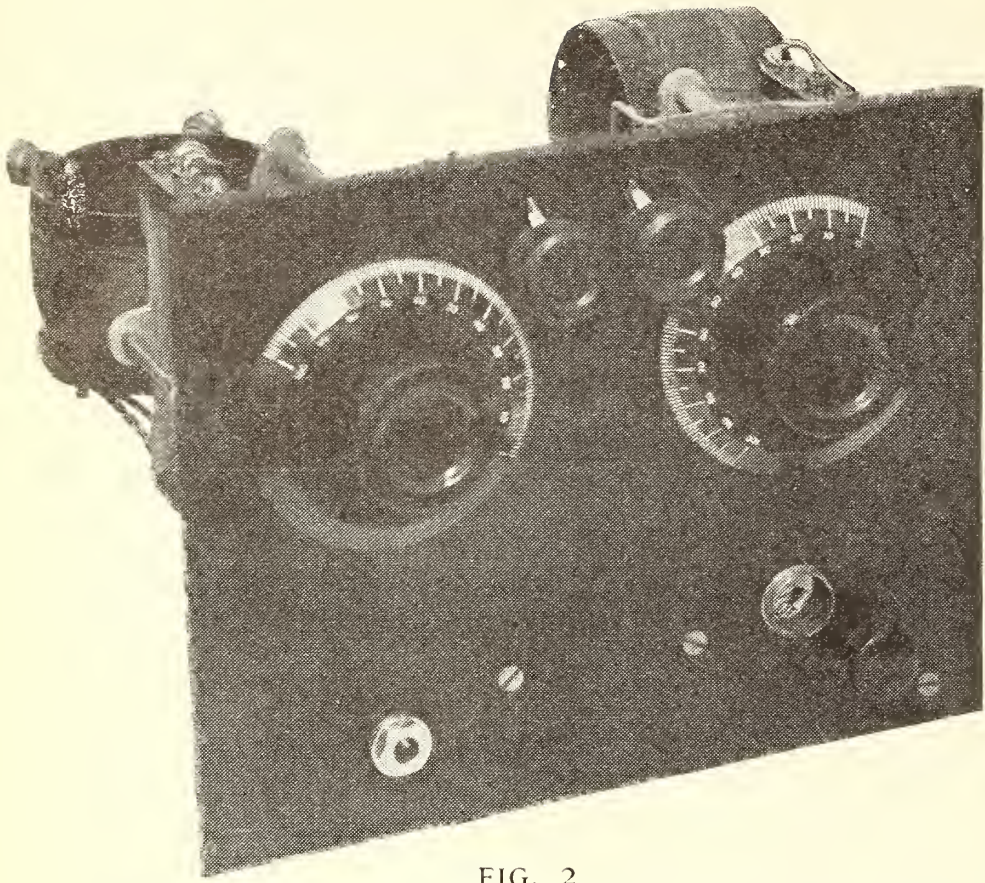

FIG. 2

The original reflex set plus the Sodian tube. Note the two small knobs, rheostat, and potentiometer, in the upper center

well adapted to the reflex set with the Ballantine Varioformer (where no C2 capacity is used at all) as described in the January RADIO BROADCAST. It will, however, work sufficiently well with the windings and capacity described in November, to justify the change from crystal to the Sodian tube, if the experimenter cares to alter slightly his set already made. Directions for doing this will be given a little later on.

Returning to Fig. 1: R1 and R2 may be a single resistance, a standard potentiometer of about three hundred and fifty ohms. But, as the required variation of resistance is generally confined to a comparatively small ohmage on the negative side of the potentiometer, the Connecticut Telephone and Electric Company, Meriden, Connecticut, has designed two resistances, a variable and a fixed one, respectively R1 and R2. The variable

resistance costs \$1.00, and the fixed unit \$.30.

R3 and R4 are rheostats, and, if the set is made up especially for the Sodian tube, it is suggested that they be of thirty ohms resistance each. This will make possible the correct filament voltages, on each tube, from a common filament source.

The plate potential for the Sodian Tube is 22.5 volts.

The Sodian tube can, of course, be applied to any reflex circuit as described above. The principle of the low input impedance should merely be carried in mind, and some form of a variocoupler, with a variable condenser across the secondary, substituted for the final output R. F. transformer.

#### ADDING THE SODION TUBE TO THE OLD CRYSTAL REFLEX SET

**I**F YOU have built up a set according to original description which appeared in November, the Sodian tube detector may be added to it in accordance with the circuit of Fig. 1, and as shown in Figs. 2, and 3,

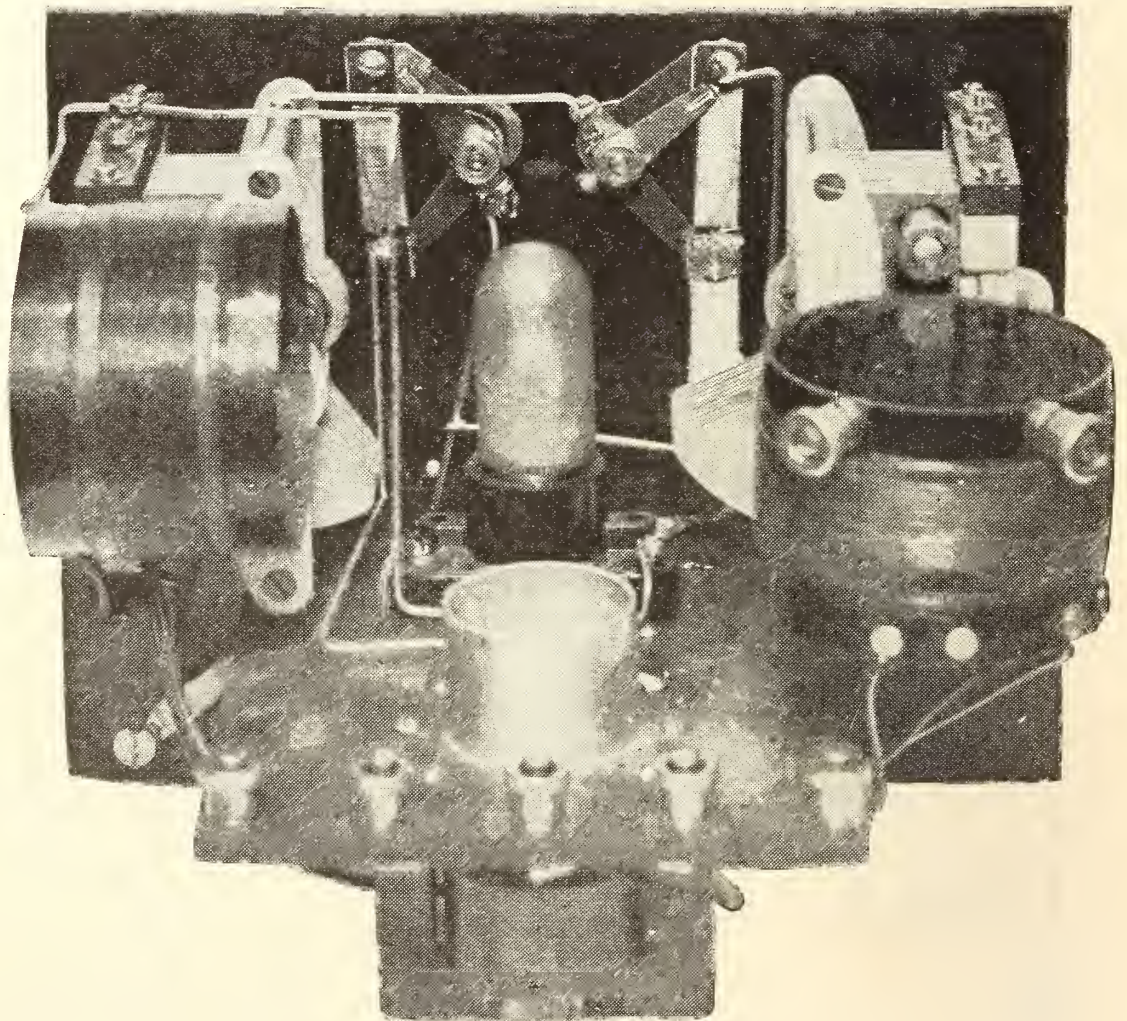

FIG. 3

Showing the back of panel work necessary to adapt the Sodian tube to the single tube reflex



In this case, the reader is advised to buy not merely the Connecticut Company's potentiometer units but also their Sodian filament rheostat. These resistances are most easily mounted in the remaining free space on the panel, and they are uniform in appearance. The socket of the Sodian tube is mounted on the shelf holding the standard tube, placing it close up to the panel.

The only necessary circuit changes are those connections to the secondary of T<sub>2</sub> and to the primary of T<sub>3</sub>. An additional binding post may be added for the 22.5-volt tap for the Sodian tube. The crystal detector is, of course, completely eliminated from the circuit.

#### FIXED CRYSTALS AND THE ONE-TUBE REFLEX

THE use of the Sodian tube, as described in the preceding article, by no means makes obsolete the crystal detector in this circuit. There are many to whom the simplicity and economy of crystal detection will continue to appeal, in fact we use it with great regularity and satisfaction. Readers in this category, who may at present be experiencing difficulty

with crystal detection, should not resort to the Sodian tube before thoroughly examining the possibilities of their present system.

Ninety per cent. of the troubles which have bothered the comparatively few interested enthusiasts who have not been able to make this set function properly, have been due to faulty crystal detection. The symptoms of such troubles are as follows:

Oscillation, as evidenced by the reception of a variable beat-note of the transmitting radio-  
phone.

Squealing.

Equal or better detection when the cat-whisker of the detector is lifted from the crystal.

These difficulties may be instantly and permanently remedied by the use of an efficient fixed crystal, such as the Erla, manufactured by the Electrical Research Laboratories, 2515 Michigan Avenue, Chicago, Ill., and the Pyratek, made by the Erisman Laboratories, Washington Heights Building, New York City. These fixed crystals will be supplied by the

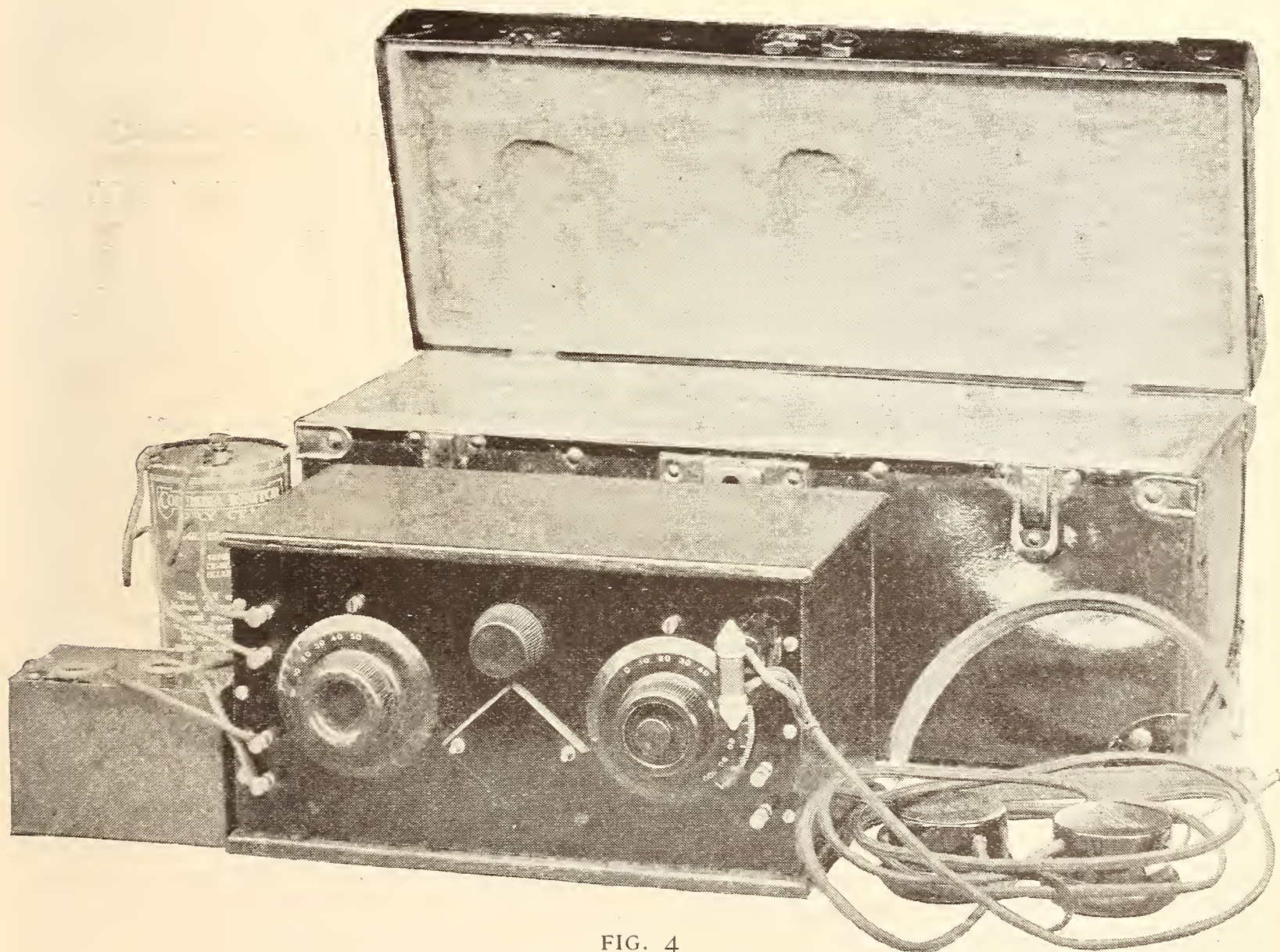

FIG. 4  
The ideal automobile radio equipment

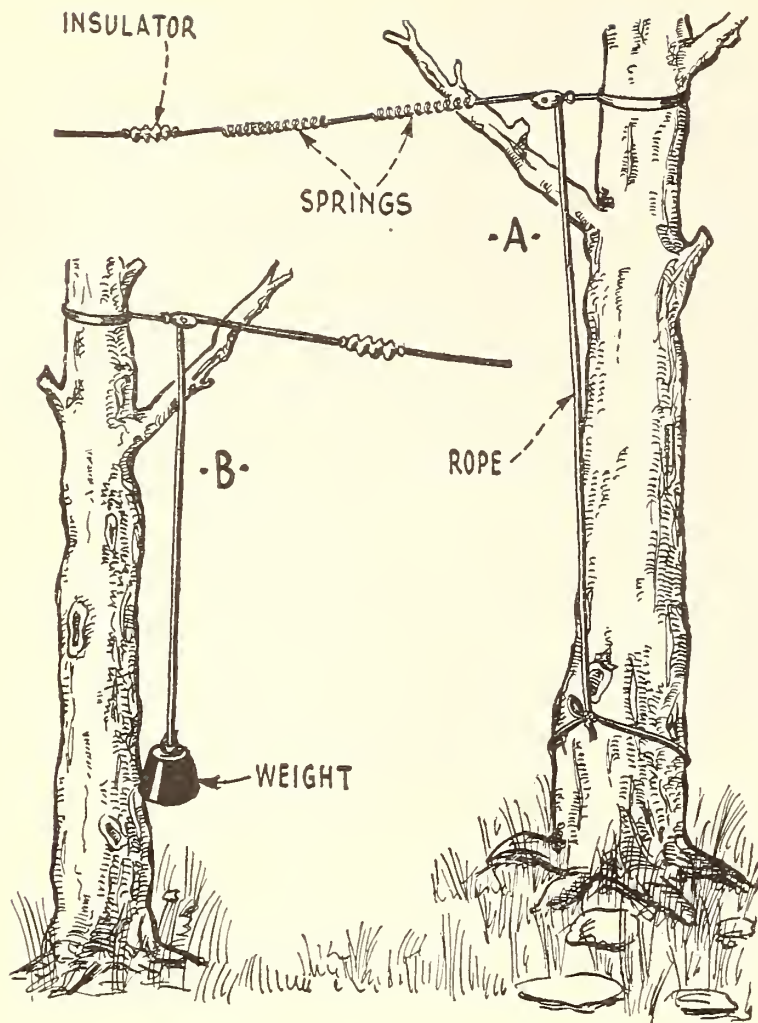

FIG. 5

Two methods of compensating for the sway of tree antenna moorings

manufacturers, if the reader is unable to obtain them from a local dealer, for \$1.00 and \$1.25 respectively.

## THE PORTABLE SET AND THE AUTOMOBILE

Photos by C. H. BROWN

WITH the coming of spring, and all that this season means to the motorist, the portable set, in its adaptation to the automobile, takes on considerable significance. But, as in all things (particularly in radio!) there is a right and wrong way of combining these two interests.

The wrong way is to throw the old set, with the necessary additional equipment (excepting those parts you forget) into the tonneau, cramp yourself by operating it on the running board or rear seat, and finally returning home minus a pair of 'phones, or a bulb—left a monument to inefficiency and lack of system—at your temporary location.

Fig. 4 tells the other story—how to derive unadulterated enjoyment from the orderly combination of two enthusiasms.

The set, in the first place, should be con-

structed purposely for automobile use. It is preferably a simple installation, sturdily built, with the fewest number of parts to shake loose and give rise to difficulties. For this reason, the single tube reflex is ideal. Certainly, if the enthusiast is one of these genuine motorists, who scorn the state-roads and suburban boulevards, a plurality of tubes is to be frowned upon.

A carrying case should be provided for the set, partitioned so as to hold the receiver firmly, and leave sufficient room for 'phones, aerial and connection wire, B and A batteries. This last may be dispensed with if it is desired to utilize the automobile storage battery.

The carrying case should not be bought to fit the set, but rather the set built to fit whatever size and shape case the experimenter may have on hand or can easily procure. The set and the parts should fit it snugly, and it is a good idea to cushion, with quilting, the top and sides. Fig. 4 shows the ideal portable equipment.

The antenna may be strung from the car to the branch of a tree, while either a nearby wire fence, all wires bridged, or a single long bare copper wire laid on the ground beneath the antenna, makes a fairly good ground. With some sets, the frame of the car makes an excellent counterpoise (ground substitute).

## HANGING YOUR ANTENNA TO TREES

By S. OLIVER

HAVING one end of my antenna fastened to the top of a large tree, I found that whenever the wind blew very hard, the tree would sway and often break the antenna.

To remedy this, I obtained three ordinary screen door springs (any similar springs will do) and fastened them, end to end. One end of the springs was fastened to my antenna insulator, and the other to a rope which ran through a small pulley in the tree-top and then down to the ground. The pulley makes it possible to adjust the tension of the aerial from the ground. The springs are strong enough so that I may pull the antenna wire quite taut, while still leaving sufficient elasticity for stretching with the movement of the tree in the wind. This arrangement is shown in Fig. 5A.

(Another idea, in some respects superior to that suggested by Mr. Oliver, has been employed by the editor of this department, not only to compensate for the swinging of tree moorings, but as a general convenience for

automatically regulating the tautness of the antenna, regardless of rope shrinkage, expansion, etc. Figure 5 B, explains this system, which merely consists of running the rope or mooring end of the aerial through a pulley to a weight, which the writer found most conveniently made up of two or three sash-weights from a window. An antenna, moored in this manner, may be left for months without even so slight an inspection as an anxious glance.)

### MAKING TRANSFORMERS FOR THE SUPER-HETERODYNE

IN THE development of the super-heterodyne, several designers deemed it expedient to get away from the long wave transformers designed to cover a wide band of frequencies in favor of another type for which certain advantages are claimed. This type requires no iron in its core nor does it require tuning. Its fundamental frequency is comparatively high, and it will not permit audio-frequency disturbances to pass through the radio stages.

A wooden spool  $2\frac{1}{2}$ " in diameter with two slots  $\frac{3}{16}$ " wide separated by  $\frac{1}{8}$ " and with a base diameter of  $\frac{3}{4}$ " is the winding form used for the windings. In the interstage transformers the primaries are wound with 800 turns of No. 32 DSC wire, and the secondaries with 1,000 turns of the same wire. The input transformer differs only in having its primary winding reduced to 300 turns so that with the .0005 condenser across this winding it resonates at approximately 2,400 meters.

The outside primary lead is run to the plate, the outside secondary to the grid. The inside primary goes to the B battery and the inside secondary to the stabilizer arm. The input transformer is used to feed from the first detector into the first R. F. tube.

### THE MEASUREMENT OF RADIO FREQUENCY VOLTAGE AND TESTING OF RADIO FREQUENCY TRANSFORMERS

By W. VAN B. ROBERTS

A WELL known method of measuring the alternating voltage (at any frequency) applied to the grid of a vacuum tube is shown in Fig. 7. In the absence of any A. C. input it will be found that the plate current can be reduced practically to zero by sliding the potentiometer contact sufficiently far over to the negative side. The voltmeter then reads the

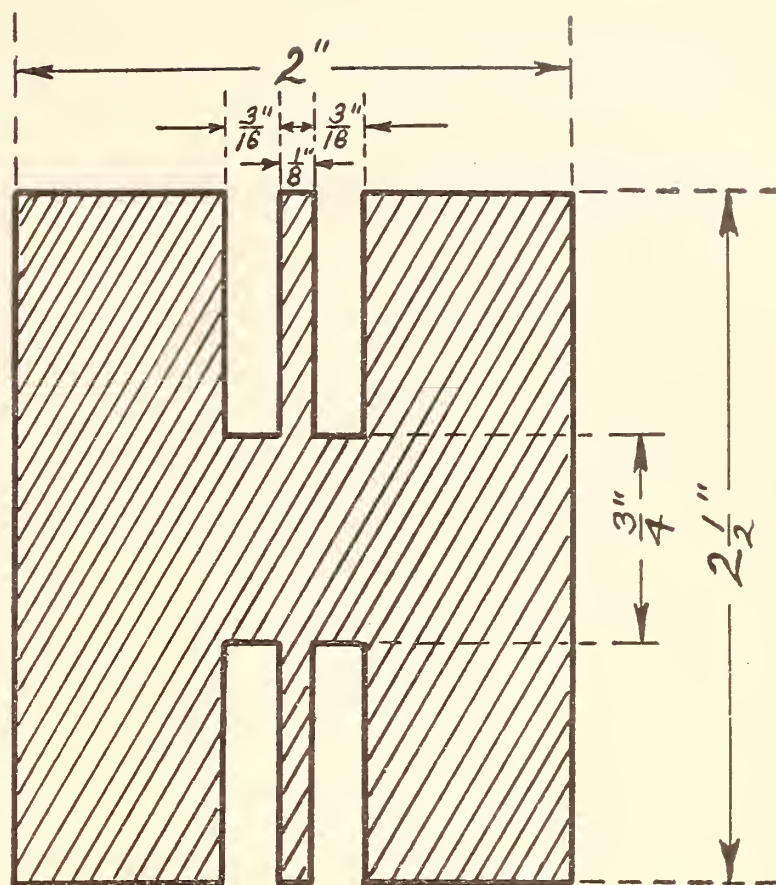

FIG. 6  
Working drawing for the home-made super-heterodyne transformer.

value of the negative grid potential that is just sufficient to shut off all plate current. Call this value  $V_1$ . ( $V_1$  is approximately equal to the plate battery voltage divided by the amplification constant of the tube). If, however, alternating voltage is applied to the grid in addition to the direct voltage of the potentiometer, the mil-ammeter in the plate circuit will show some current. This is because one half of the A. C. voltage cycle reduces the instantaneous value of the grid potential below the value  $V_1$  that was found necessary to shut off the plate current. By increasing the voltmeter reading by sliding the potentiometer contact farther to the left, the grid potential may be made so negative that the alternating voltage is at no time sufficient to bring the instantaneous value below the critical value  $V_1$ . Call  $V_2$  the voltmeter reading that is just sufficient to shut off the plate current in spite of the alternating voltage. Then  $V_2 - V_1$  is the maximum instantaneous value of the alternating voltage applied to the grid, or the peak value, or the amplitude, as it is variously called.

Fig. 8 shows a complete circuit for measuring the voltage amplification per stage of an amplifier coupled by means of the transformer T. The oscillator supplies the radio frequency voltage to the first tube. This supply

can be shut off by closing switch  $S_1$ . The double pole double throw switch  $S_2$  is arranged so that when thrown to the right the milliammeter measures the current in the plate circuit of the first tube, and vice versa. The procedure is as follows:

Close  $S_1$  and throw  $S_2$  to the right and put the plug in the left hand jack. Adjust the voltage of the flashlight battery  $F$  and the potentiometer  $P$  until the mil-ammeter read-

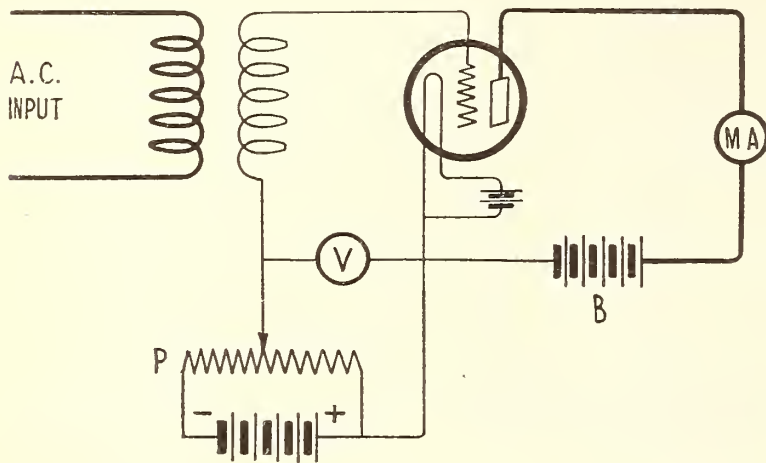

FIG. 7

Circuit showing method for measuring the alternating voltage applied to the grid of a tube

ing is just reduced to zero, or practically zero. Count the number of cells of  $F$  that are required and reckon 1.5 volts per cell and add to this the voltmeter reading. The result is  $V_1$ . Then open switch  $S_1$  and make the coupling between coils  $L_2$  and  $L_3$  sufficient so that the voltage  $V_2$  required to shut off the plate current is a couple of volts greater than  $V_1$ . The difference,  $V_2 - V_1$  is the A. C. voltage applied to the grid of tube No. 1.

Next, throw  $S_2$  to the left and put the plug in the right hand jack and measure the grid

potentials required to shut off the plate current of tube No. 2 with switch  $S_1$  closed and then with it open. The difference is the A. C. voltage on the grid of tube No. 2. This, divided by the A. C. voltage applied to tube No. 1, gives the voltage amplification per stage at the frequency and B and C battery voltages used.

The curve showing the amplification at various frequencies can be made by going through this whole process a number of times at different frequencies.

If the transformer is for use at the frequencies employed in broadcasting, the oscillator frequency can be calibrated by putting a pair of phones in its plate circuit and using it as a receiving set loosely coupled to an antenna and noting the condenser readings for various stations of known frequency. If the transformer is for lower frequencies, honeycomb coils can be used in the oscillator, which are of known inductance, the approximate number of mil-henries is usually marked on the label. If a General Radio Co. variable condenser is used, the approximate number of micro-microfarads is marked on the dial, and the frequency can be calculated approximately from the formula frequency (in kilocycles) =

$$\sqrt{\frac{5,000}{\text{No. of milhenries} \times \text{No. of micro-microfarads}}}$$

In using this measuring circuit great care must be taken never to have switch  $S_2$  closed unless it is certain that there is plenty of negative potential on the grid to keep the plate current down to a value low enough not to harm the mil-ammeter. A mil-ammeter that shows a large deflection on one mil-ampere is necessary. In particular, remember to open switch

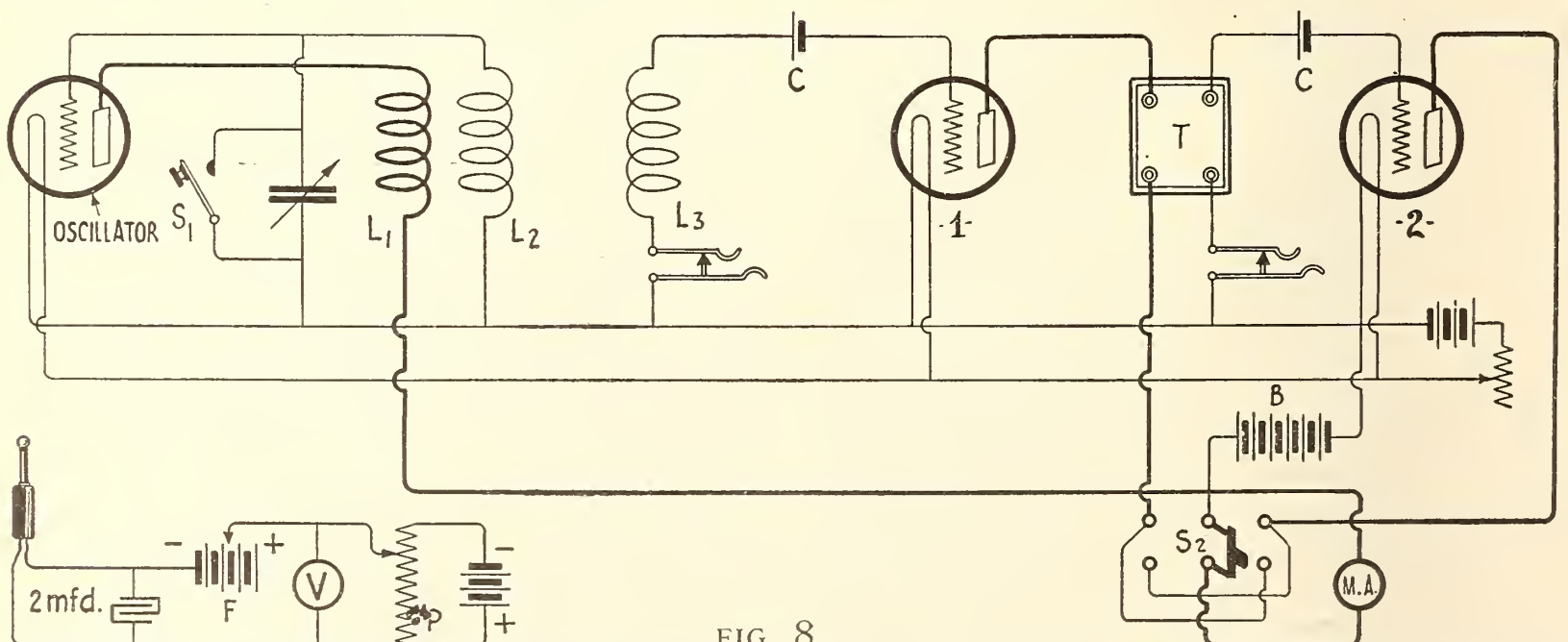

FIG. 8

Complete circuit showing how to measure the voltage amplification per stage of an amplifier coupled by the transformer T

$S_2$  when changing taps on the battery F. Coil  $L_3$  needs only to be big enough to pick up a couple of volts from the oscillator. For broadcast frequencies, a DL 50 will do, but for lower frequencies a larger coil should be used. The reason the battery F is not put across the potentiometer so that the voltmeter could read the whole voltage directly is that the resistance of the potentiometer is so low that too much current would be drawn from the flashlight cells for their good. A few six inch dry cells form the potentiometer battery and the potentiometer is only necessary to give a continuous variation of voltage between taps on F. The 2 mfd. condenser is a radio frequency by-pass.

### BUILDING YOUR OWN LAB

RADIO BROADCAST's suggestion for this month's addition to the growing laboratory, is an electric soldering iron. Such a tool, really *indispensable* to fine radio-craftsmanship, will cost from \$2.50 to \$6.00, depending on the quality. We strongly advise against a compromise with price when buying tools. Cheap electric soldering irons, more often than not, have serious faults such as slow heating and over-heating, and after use develop additional troubles, burning out, short-circuiting, etc. An excellent iron, such as that illustrated in Fig. 9 can be bought for about four dollars. A small iron is generally preferable to a larger one.

The electric iron is so vastly superior to the old fashioned externally heated type, that the experimenter who is still racing back and forth between his work bench and the gas stove, is still driving a prairie schooner in these days of airplanes and motor-cars. A good electric soldering iron gives a constant heat of the correct soldering temperature, insuring a perfect flow of metal and weld at every joint. The electric iron permits soldering in cramped places

inaccessible to the ordinary iron because of its bulk, made necessary for the retention of heat.



FIG. 9

An excellent electric soldering iron costing about four dollars

Only the owner of an electric iron can truly appreciate the actual handicap under which he labored with the old style, inefficient and sooty tool

### HOW TO USE THE SUPER-HETERODYNE ON 100 METERS

THE super-heterodyne which was described in RADIO BROADCAST in January may be used for 100-meter reception by a change of the oscillator coupler and loop.

The grid winding of the oscillator coupler should be decreased to 10 turns and the plate winding cut down to 15 turns. It will then be necessary to tune the oscillator with the condenser in shunt with the grid coil only; instead of in shunt with the grid and plate coils as is shown in the original diagram for 200 to 600 meter work. The coupling coil would remain about 15 turns, while the loop would probably have to be decreased to between 4 to 6 turns for operation to get down to 100 meters.

Then, too, it is possible to receive on 100 meters without making any changes whatever in the receiver itself. By using a two or three turn loop the capacity of the loop tuning condenser will be found low enough to function satisfactorily well below 100 meters. It is then but necessary to tune the oscillator to a harmonic of the incoming signal. Reception by this method is very satisfactory and for waves below 100 meters both the loop and heterodyne dials will be set somewhere between zero and fifteen.

*"How to Build a Resistance-Coupled Audio-Frequency Amplifier" will be one of the articles in the May number which you will want to read. Besides being a very quiet amplifier, the resistance-coupled type is quite inexpensive to build. The article will be complete with diagrams and specifications*

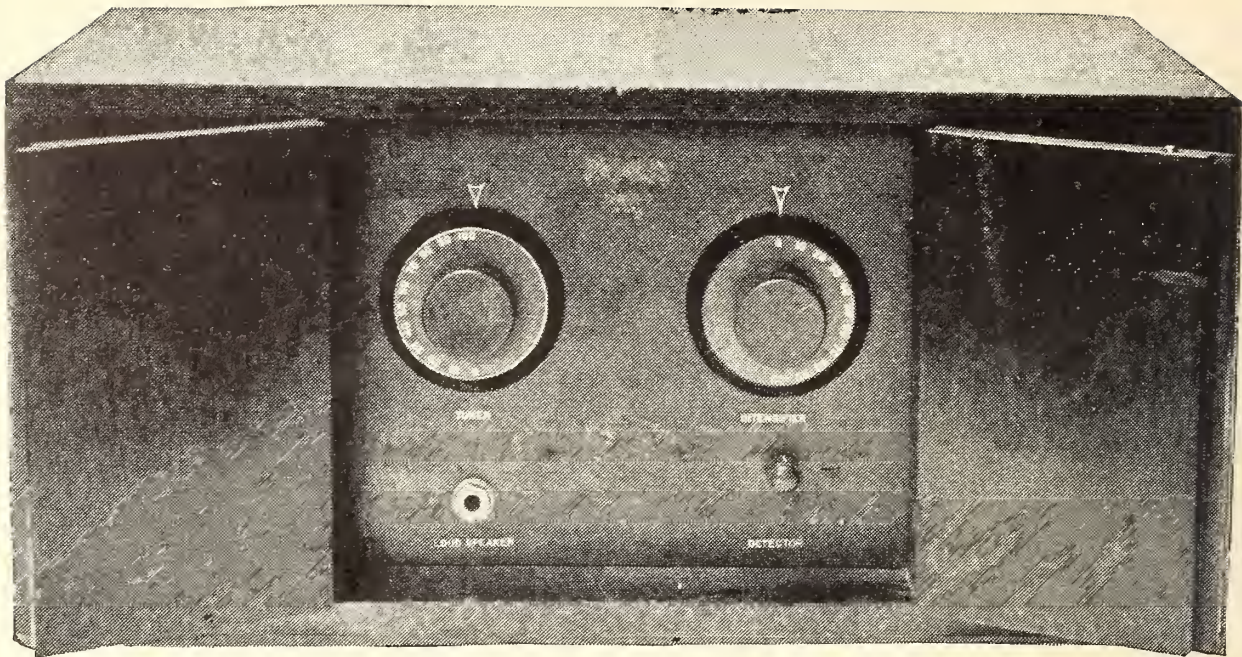

#### THE COMPLETE OUTFIT

Everything including the A and B batteries may be placed in an attractive cabinet. Some idea of the simplicity of operation may be had from a glance at the panel

## How to Make a One-tube Reflex Set That's a "Knock-Out"

Described in a Most Comprehensive Manner, with Complete Instructions for Building and Operating It. It Should Operate a Loud-Speaker over a Crystal Range and It Is not a "Bloofer"

By Kenneth Harkness

This article first saw the light of day in our November, 1923, number. Since that time we have designed and described various modifications of this fundamental circuit and several new developments are in the fire. As soon as the results we obtain are satisfactory these sets will be described. In this number there are two modifications of the receiver described below. Both are improvements. By confining our efforts to a single fundamental idea it is possible to provide our readers with the most reliable data on receivers *without making it necessary to discard any material previously purchased.*

We have had so many letters from enthusiastic supporters of this receiver and so many requests for extra copies of the November number that we feel that its reprinting will fill a rapidly growing need. The boiled-down digest of our readers' comment shows very plainly that the receiver really is what we have called it—a knock-out.—THE EDITOR.

**W**E HAVE often heard of one-tube receivers that will actuate a loud speaker, but seldom do we have the experience of listening to such a performance; and in radio—hearing is believing—so we are justly skeptical of these "wonder sets."

Indeed, the super-regenerative "flivver" receiver was the first loud-speaking one-tube set\* we had occasion to witness in actual operation, and although it made a remarkable showing in reproducing local stations, distant

reception appeared impossible and some rather complicated knob and dial juggling was required in the process of tuning.

Immediately after the super-regenerative craze died down, we were deluged with hashed-up versions of revived and rejuvenated but nevertheless ancient reflex circuits; but until recently we were still looking for a demonstration of a one-tube set that would make a loud speaker "percolate."

For this reason we spent many days and nights in an effort to produce such a single-tube receiver. Our work has resulted in an outfit that is simple and inexpensive to build, easy to install and operate as well as being compact

\*See "Operating a Loud Speaker on One Tube Without Batteries" in RADIO BROADCAST for June, 1923.

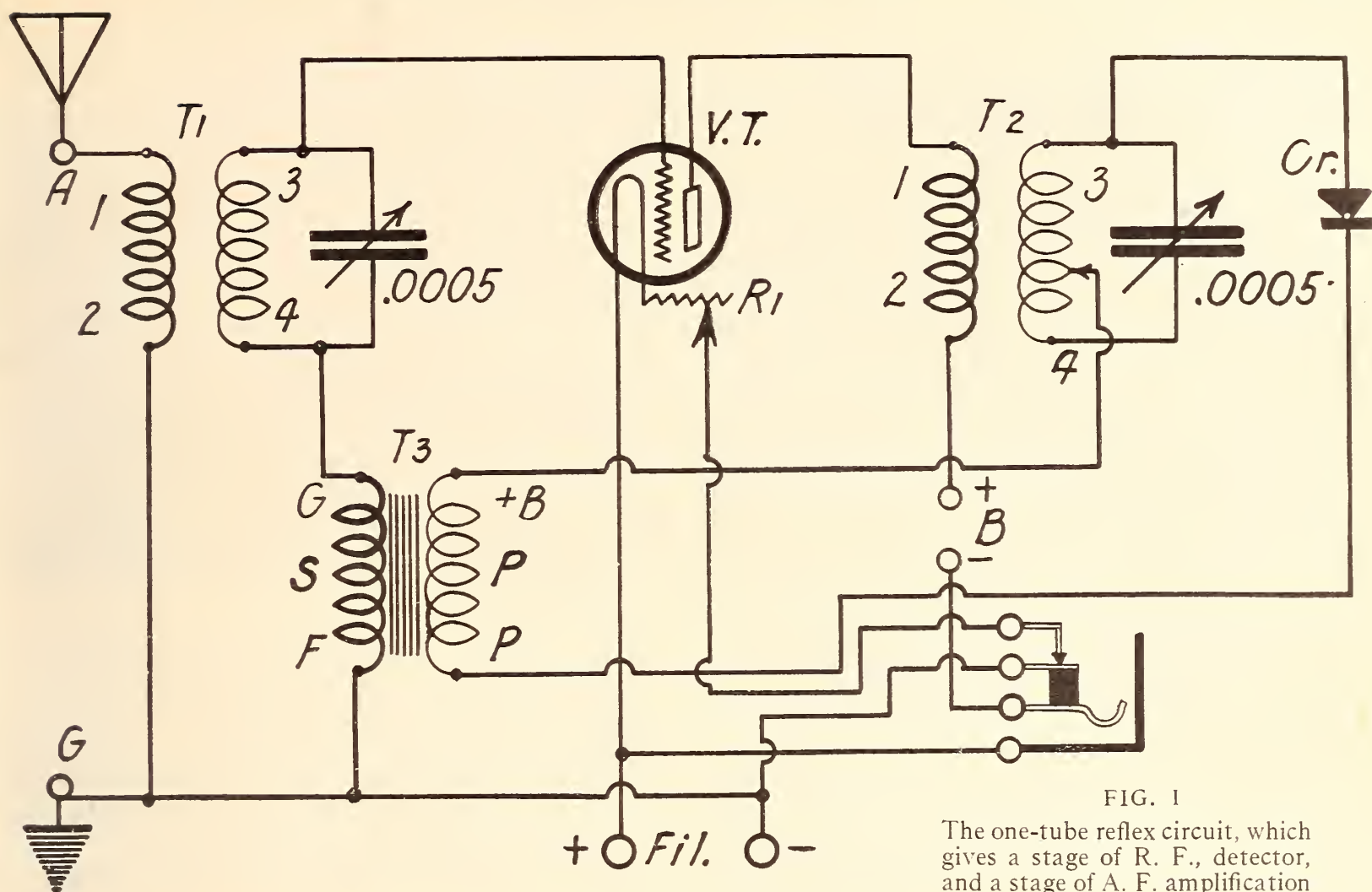

FIG. 1

The one-tube reflex circuit, which gives a stage of R. F., detector, and a stage of A. F. amplification

and portable. It will function with any kind of receiving tube now on the market and will operate a loud speaker over distances about equal to those it is possible to hear with the telephones on an ordinary crystal receiver. When used with a headset it is capable of very long distance reception, extremely sharp tuning, and exceptionally clear reproduction of speech and music.

The receiver is essentially a one-tube reflex outfit, but involves certain modifications that make for efficiency, sensitivity, volume, clarity, and ease of control. It is:

*Efficient*—because the one tube is made to do double duty and because an improved circuit with correct constants is employed.

*Sensitive*—because a stage of *tuned* radio-frequency amplification is provided before the *tuned* detector circuit.

*Volume*—because a stage of audio-frequency amplification is used to amplify the rectified impulses and because *both* the radio-frequency amplifying and rectifying circuits are *tuned*—giving maximum amplification with corresponding selectivity.

*Clear*—because a crystal is used for rectification: and because, when properly adjusted, the vacuum tube does not oscillate and the

howling and squealing so noticeable in regenerative receivers is totally absent.

So far, not so bad, eh?

#### METHOD OF PREVENTING SELF-OSCILLATION

ORDINARILY in a reflex circuit the tendency toward self-oscillation is so great that a potentiometer or similar device must be employed to impress a positive charge on the grid so that the resultant grid current will prevent self-oscillation.\* In a plain radio-frequency amplifier this would be quite satisfactory, but when it is desired to use the same tube for audio-frequency amplification it is necessary to operate the grid at a *negative* potential or else the A. F. amplification will be *nil!* It is evident then that reflex systems utilizing a potentiometer stabilizer are out of the question.

We could employ reversed inductive or capacitive feed-back to balance the self-oscillations, but each of these systems has certain disadvantages; especially in a circuit having a variable resistance element such as a mineral rectifier.† The adjustment would necessarily be tricky and unstable.

\*See "Radio-Frequency Amplification Without Distortion or Reradiation," RADIO BROADCAST for July, 1923, page 214.

†Several fixed crystals, such as the Erla and Pyratek have been used in the R. B. Lab with great satisfaction.

The method of preventing self-oscillation in the receiver to be described is not new, but, to the best of our knowledge, its application and dual functioning are original.

Briefly, if the grid and plate circuits of a vacuum tube are adjusted to the same frequency, even though they are not in inductive relation, the inter-element capacity of the vacuum tube is large enough to feed back sufficient energy to produce self-oscillation. If a third and independent circuit is closely coupled to either the plate or grid circuit and this independent circuit is tuned, it will cause a reduction in the amplitude of the local oscillations, and if the initial amplitude is *not too great*, the reduction will be effective in preventing self-oscillation. Further, the energy in the independent third circuit may be fed into a rectifying device, the damping effect of which will still further aid in preventing undesirable self-oscillation.

The practical application of this system may be noted in Fig. 1. The primary coil of transformer T2 is in close inductive relation to the tuned-secondary circuit—which latter functions

in the dual rôle of the *independent third circuit* and the *tuned detector input*.

The rest of the circuit is standard, but every endeavor has been made to reduce the number of controls without decreasing efficiency. Thus, the antenna circuit is made slightly aperiodic (i.e., requires no tuning over the range covered by the secondary); the filament circuit is "made" or "broken" by the automatic filament control jack, and a ballast resistance is used in place of an adjustable rheostat; the plate winding of T2 is sufficient to allow good transformation without direct tuning of the plate circuit; the grid and detector inductances are fairly widely separated and at right angles to each other so there is a minimum of inductive feed-back.

#### SIMPLE DESIGN AFFORDS EASY CONSTRUCTION

**A**N AMATEUR should have little difficulty in constructing a receiver of this type as the photographs afford constructional details which may be readily understood, even by the newcomer in the radio game.

In the top view, Fig. 2, the disposition of

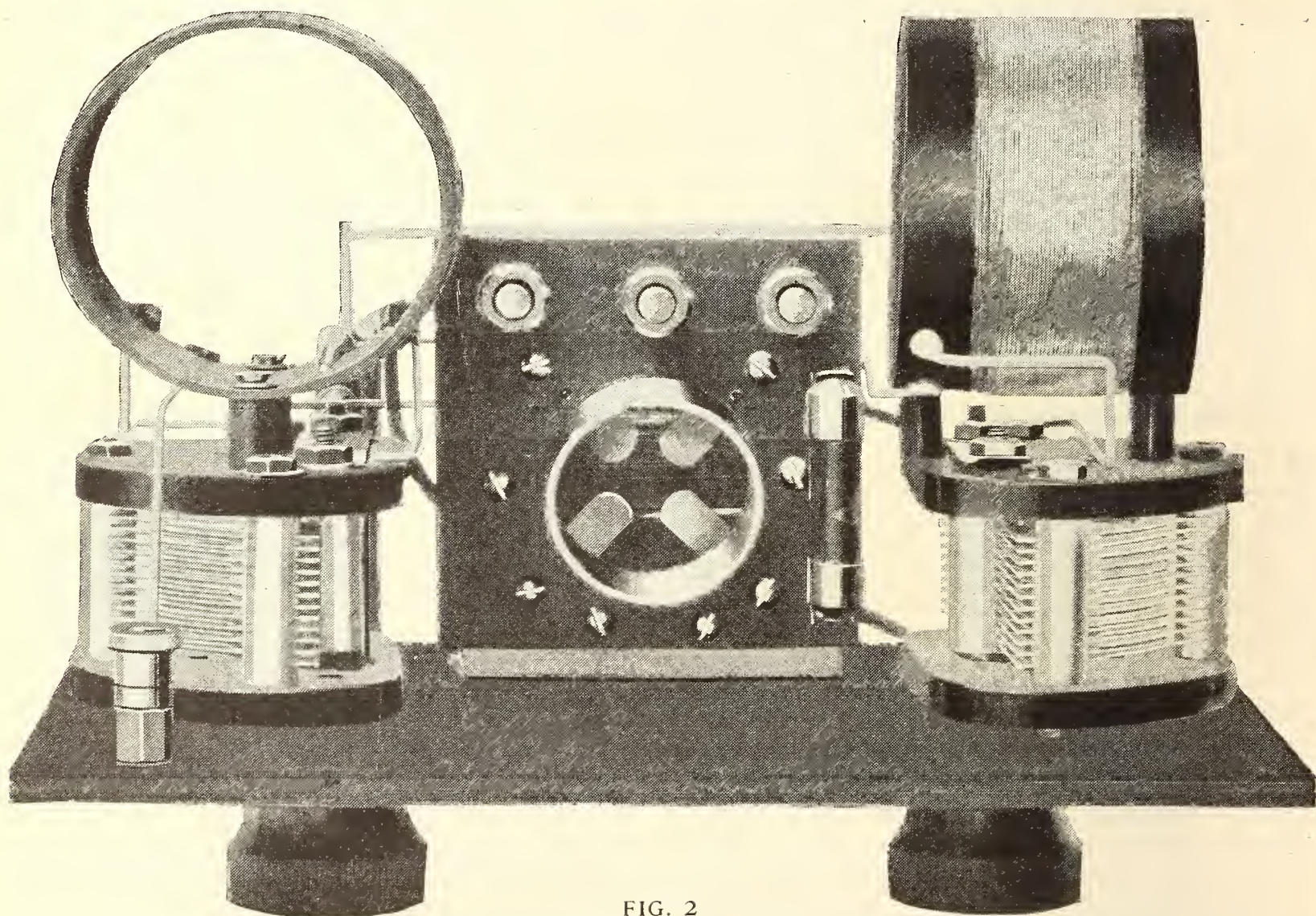

FIG. 2

This is how the receiver looks from above. Note that the two transformers (T1 at the left, T2 at the right) are mounted at right angles to each other



parts is clearly shown. The transformer mounted behind the left hand condenser constitutes, with the condenser, the tuned antenna, grid, radio-frequency transformer unit T<sub>1</sub>; at the right hand side is mounted the plate-detector, audio-frequency transformer unit (T<sub>2</sub>).

An "Amperite" or other fixed resistance is mounted at the right side and battery terminals in the rear of the socket strip.

In the front view, on page 496, may be seen the controlling knob of a mechanical crystal detector illustrated in Fig. 3. This detector has proved its excellence as to ease and stability of adjustment, two factors of prime importance which should be looked for in selecting this item; but any good crystal detector may be used.

The entire set is mounted within a special cabinet with provision for separate battery compartments. The top and center panels of the cabinet are hinged to allow access to the tubes and tuning controls. When closed, the instrument is completely protected from dust and injury.

Close study should be given the photograph of the empty cabinet, Fig. 4, which shows the proper measurements. It is advisable to secure all the material necessary before starting the actual assembly of this receiver.

#### LIST OF MATERIALS REQUIRED

- 1 Audio-frequency transformer, 4½ to 1 ratio
- 1 Panel-mounting crystal detector, mechanical adjustment preferred
- 2 Special tuned radio-frequency transformers, utilizing—
  - 2 .0004 mfd. variable condensers
  - 2 ¼" Formica forms, 2" long and 2⅝" dia.
  - ⅓ lb. No. 28 cotton and silk insulated wire
  - 2 8" strips of 1" cambric cloth

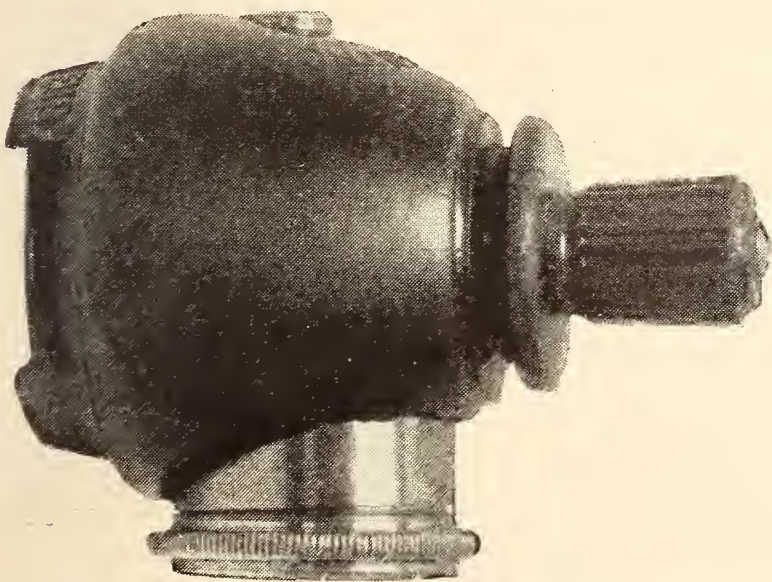

FIG. 3

A small French crystal detector which is gaining popularity in this country. Few are available at present, but they are to be marketed in quantities shortly. The cat-whisker and crystal are completely enclosed. Adjustment is accomplished by rotating the small knob shown at the right

- 8 Switch points and 8 hexagon brass ⅝" nuts for terminals
- 4 ¾" mounting pillars and 4 1" ⅝" round head machine screws for attaching the transformers to the condensers
- 2 dials to fit condenser shafts
- 1 Front panel 7½" high, 9" long and ⅜" thick
- 1 Sub-panel with spun-in socket 3½" x 5" x ⅜"
- 1 1" Brass angle 3½" long, ⅜" stock
- 1 Automatic filament-control jack. Micarta insulation
- 5 Binding posts, ⅝" screws
- 2 Spring mountings for Amperite or fixed resistance
- 4 Feet of bus bar
- 2 Feet of No. 23 bare copper wire
- 2 Feet of small flexible cambric tubing
- 8 ⅜" ⅝" round head machine screws
- 8 ⅜" ⅝" flat head machine screws
- 1 Vacuum tube, preferably a UV-201-A or C-301-A
- 1 45- or 90-volt B battery
- 1 A battery of 6 volts, either storage battery or dry cells
- 1 Headset or loud speaker

#### ANTENNA EQUIPMENT

- Either 1 light-socket antenna attachment or  
200 Feet No. 12 rubber-covered copper wire
- 3 5" glazed porcelain corrugated insulators
  - 1 Lead-in insulator
  - 1 Lightning arrester (not necessary when antenna attachment is used.)

#### CABINET MATERIAL

- 4 pieces 7½" x 8½" x ½"
- 1 Base 9½" x 18" x ½"
- 1 Top piece 2½" x 18" x ½"
- 1 Cover 7" x 18" x ½"
- 2 Doors 4½" x 7½" x ½"
- 2 Front pieces 7½" x 4½" x ½"

#### THE TUNED R. F. TRANSFORMER UNITS

SPECIAL care should be observed in constructing, or purchasing (if you do not care to build them), the tuned radio-frequency transformer units, as successful operation is greatly dependent upon them. For this reason exact specifications are given, and it would be well to employ similar material, follow the same constructional lines, and make all connections in accordance with instructions if duplication of the results mentioned above is expected.

Procure ⅓-lb. of number 28 single cotton (under) and single silk (upper) insulated soft-drawn copper wire and two formica forms ¼" inch thick, 2 inches long and 2⅝ inches in diameter.

Number 28, S.C.S.S. wire is chosen because it combines highest efficiency with exceptionally neat appearance. The double covering provides good spacing between the metallic conductors. The white cotton protective layer affords good insulation, while the silk layer is pleasing in appearance and does not allow the shellac to gather and harden between turns. The usual effect of increased distributed capacity resulting from the use of shellac or other dope

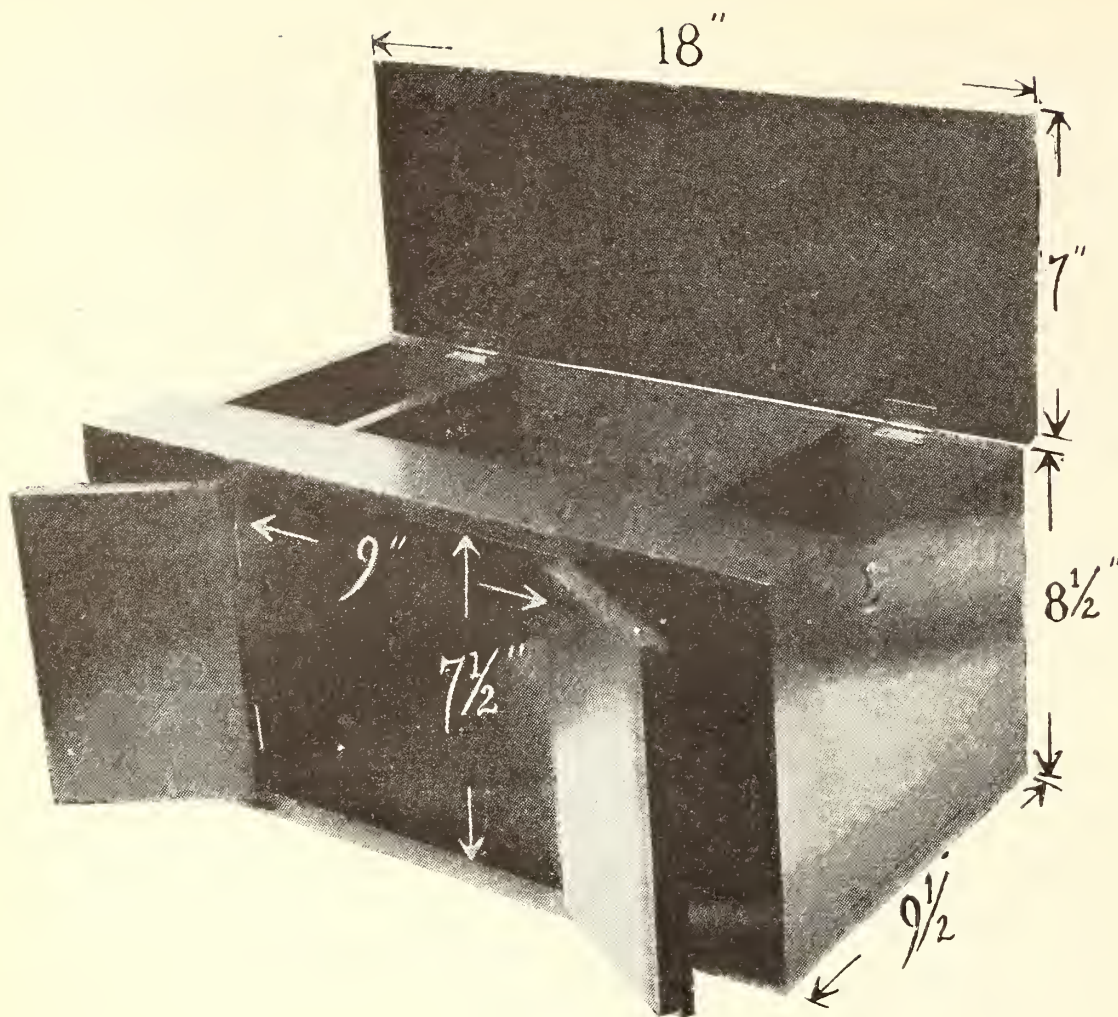

FIG. 4

The receiver slides into the middle compartment, the side sections being provided for the A and B batteries. If the constructor of the set prefers not to make the cabinet, it may be bought for a reasonable sum

on ordinary cotton covered wire is thus reduced. It is interesting to note that when coils, especially cotton covered, are not treated with some form of moisture-resisting material, a relatively great amount of moisture will be absorbed, the insulation between turns is materially reduced, and this fairly low-resistance shunt across the coil is extremely detrimental to sharp tuning.

The particular size wire is chosen because with it a relatively small length of wire is required for any given inductance and in addition the value of capacity between turns and therefore the total value of distributed capacity is lower than would be the case with heavier wire.

#### MAKING TRANSFORMER T1

ONE of the two Formica forms (see list of materials) should be provided with four terminals and two mounting screw holes, made with a No. 27 drill. The terminals are situated  $\frac{3}{4}$ " apart,  $\frac{1}{4}$ " from one edge. The mounting holes are  $\frac{1}{4}$ " from each edge on a line parallel to the axis and between the two center terminals. The terminals may consist of switch points with the heads outside and hexagon brass nuts clamping them to the form

inside. The projecting pieces of the screws are cut off and solder flowed over the nut to prevent loosening. Small holes to pass the wire should be drilled near terminals 1 and 3 (Fig. 1).

The secondary coil is wound on the form first; starting at terminal No. 3 to which the wire is soldered, 60 turns are placed evenly and tightly; the end of the wire is brought through the form at a point opposite terminal No. 4 and soldered to that terminal.

A one-inch strip of cambric cloth or other flexible sheet insulating material is wrapped over the secondary and held in place with glue.

The primary, of 15 turns, is wound on the insulating material, spaced in the center and in the same direction as the secondary.

The beginning is soldered to terminal No. 1 and the end of the coil is brought through the form at a point opposite No. 2 and soldered to that terminal.

The entire form may be given a light coat of thin shellac, collodion or airplane "dope" leaving only the terminal heads untouched for soldering. When thoroughly dry the transformer is mounted on its condenser—one method of accomplishing this is shown in Fig. 2. Two holes  $1\frac{1}{2}$ " apart may be drilled and tapped for  $\frac{6}{32}$  thread in the end plate of the variable condenser. Two  $\frac{6}{32}$  machine screws and small brass pillars are used to support the transformer away from the condenser. The arrangement should be similar to the illustration in order to retain short leads.

#### MAKING TRANSFORMER T2

THIS transformer is constructed in a manner similar to T1 with the difference that the primary (top coil) has 35 turns.

Referring to the diagram, Fig. 1, it will be seen that there are *five* connections to T2; the fifth connection is a center tap on the secondary and should be used only if the receiver is to be operated in the vicinity of an interfering

station. Otherwise this tap should *not* be provided as it reduces signal strength, although at the same time increasing selectivity because the damping effect of the crystal rectifier is effective over only half the inductance; if a vacuum tube detector were used, the value of this connection would be nil, the grid-filament resistance being so high. Although the volume would be diminished, selectivity would be neither greater nor less.

In most cases the lead from the positive B terminal of the primary of T<sub>3</sub> will be connected to terminal No. 4 of T<sub>2</sub> rather than to the tap.

Only a very light coat of dope or shellac should be placed on the primary of No. 2 as it is desired to keep the distributed capacity very low.

In mounting, T<sub>2</sub> should be placed on its condenser at right angles to that of T<sub>1</sub>. Fig. 5 shows the correct arrangement which should be followed.

The photographs of the back of the complete receiver (Figs. 2 and 6) indicate that the variable condensers face each other; this is not good practice because the dials must then be of different types, one reading left hand and one right hand. Therefore, in the panel layout, Fig. 7, and in the photograph of T<sub>1</sub> and T<sub>2</sub> (Fig. 5) corrections have been made so that both condensers are mounted in the same manner and both dials may be of the same type. All stated dimensions have been checked and corrected so that the drawings may be followed with perfect assurance that everything will fit.

These special transformer units, both T<sub>1</sub> and T<sub>2</sub>, may be purchased if the constructor wishes to save time and labor. They are priced at about \$6.00 each.

#### THE VACUUM TUBE STRIP

THE vacuum tube socket is "spun" into a sub-panel  $3\frac{1}{2}'' \times 5'' \times \frac{3}{16}''$  on which are located the filament resistance, mounting clips, binding posts, audio-frequency transformer and mounting bracket, but single sockets made for

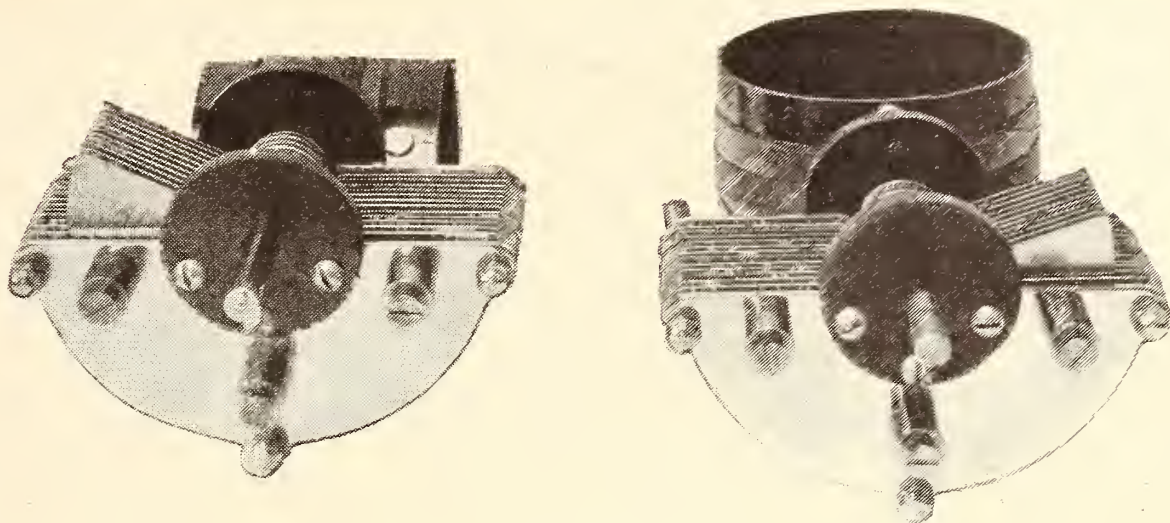

FIG. 5

The tuning units T<sub>2</sub> and T<sub>1</sub> (left to right)

panel mounting may be purchased for about \$1.50 and the assembly of the sub-panel will then be up to the ingenuity of the constructor himself. Figs. 10, 11, and 12 will help to show the proper arrangement of parts.

In assembling, care should be taken that the audio-frequency transformer is placed with its grid terminal adjacent to T<sub>1</sub>; the plate terminal will then be close to T<sub>2</sub> so all leads may be made very short.

Four binding posts are located on this sub-panel as indicated in the drawing Fig. 8. This is the correct method in contrast to the photographs which show a receiver with a slightly different wiring system.

Special attention should be given the springs of the tube socket as "dead" tension will in time cause a great deal of difficulty, chiefly characterized by noisy and spasmodic operation.

#### THE FRONT PANEL

THIS should be of Bakelite, Formica, or Radion, 9" long,  $7\frac{1}{2}''$  high and  $\frac{3}{16}''$  to  $\frac{1}{4}''$  thick. Bakelite or Formica should be sanded or grained on both sides, but Radion should retain its original finish. The panel is drilled in accordance with the front panel layout, Fig. 7, but the position of holes may be changed to suit any condensers.

#### ASSEMBLY

AT ABOUT this stage in the manufacture of a home made receiver, the amateur workshop, whether it be a real shop, the kitchen, parlor, or attic, has assumed an air of congested indecisiveness that hardly bespeaks the usually tidy habits of the constructor; coils, tools, condensers, dirt, sockets, wire, binding posts, solder, and some more dirt and

tools are indiscriminately mixed and thrown about. When it comes to assembling, some of us do not stop to clean up—we merely shove the cluttered mass to one side and with a clear space of six inches go right ahead.

How much better it would be if we were to stop for a few moments, clear up the dirt, put away unnecessary material, and leave before us only the essential parts for immediate progress. Surely the orderly surroundings would tend to create that orderliness of mind which enables better and more accurate work. Let's try it. We should have before us on an otherwise clear table the following parts:

- 1 T2 transformer unit.
- 1 T1 transformer unit.
- 1 Sub-panel with binding posts, tube socket, A. F. transformer, and resistance mounting clip in place.
- 1 Crystal detector.

1 Single-circuit automatic filament-control jack.

1 Front panel, drilled and sanded.

Also a screw driver and 3  $\frac{6}{32}$  flat-head machine screws  $\frac{3}{8}$ " long.

The vacuum tube strip is mounted first by threading two screws into the angle bracket (Fig. 9, and at the right in Fig. 10). The heads should be just flush with the panel. T1 is mounted to the left of the socket strip, T2 to the right (from the front). All screws should be driven with a firm and equal pressure in order to avoid unnecessary strain on the condenser shafts.

The aerial binding post is placed in the upper left-hand corner of the panel—this is arranged so connection is made from the rear, obviating an unsightly lead-in. The crystal detector and jack are mounted last; the frame of the jack should be facing down. As the final step

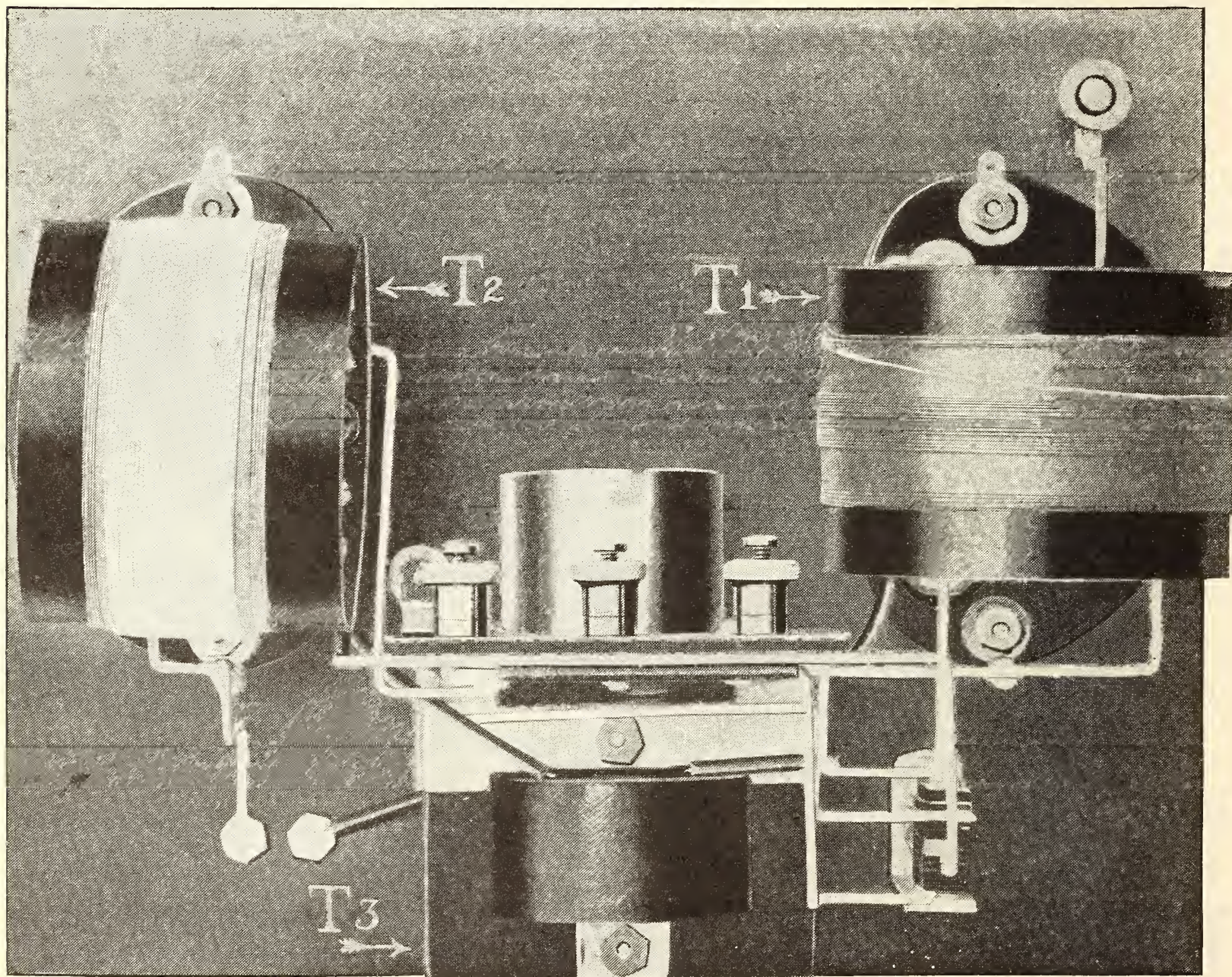

FIG. 6

The receiver as seen from the rear

in assembling, the dials are placed upon the condenser shafts and so arranged that the movable plates are all "in" when the indicating mark on the panel is in line with the highest mark on the dial.

#### NOTES ON WIRING

**A** GAIN there is need for a clear space, the proper tools, and, if possible, some experience. As every joint must be soldered, a soldering iron is quite essential. So also is a pair of  $\frac{1}{4}$ " flat nose pliers, a clean rag and bus bar wire. "50-50" bar solder is splendid, and soldering paste may be used if difficulty is experienced with rosin flux, though the excess should be removed with a little alcohol, after the soldering is completed.

Although each of us has his own way of doing things, the generally acknowledged method of wiring may be condensed in the following seven points:

1—Solder all joints. Soldering to a lug and screwing the lug to a terminal does not constitute a solder joint—the wire should be soldered direct to the terminal.

2—Flow the solder in all joints so they are perfectly smooth when cold. This requires a properly heated and tinned iron with sufficient flux.

3—Do not be too sparing in the use of flux, but immediately after soldering remove all traces of paste—with scrupulous care.

4—Use square tinned bus bar wire wherever possible.

5—Make  $90^\circ$  bends and run stiff connections only vertically and horizontally.

6—Wires more than a few inches in length should be run against the panel or other insulating support—they should not be left unprotected in space.

7—When soldering a wire to a terminal, aim the wire toward the center of the terminal—do not solder it to the side.

Wire the filament circuit first; the positive A

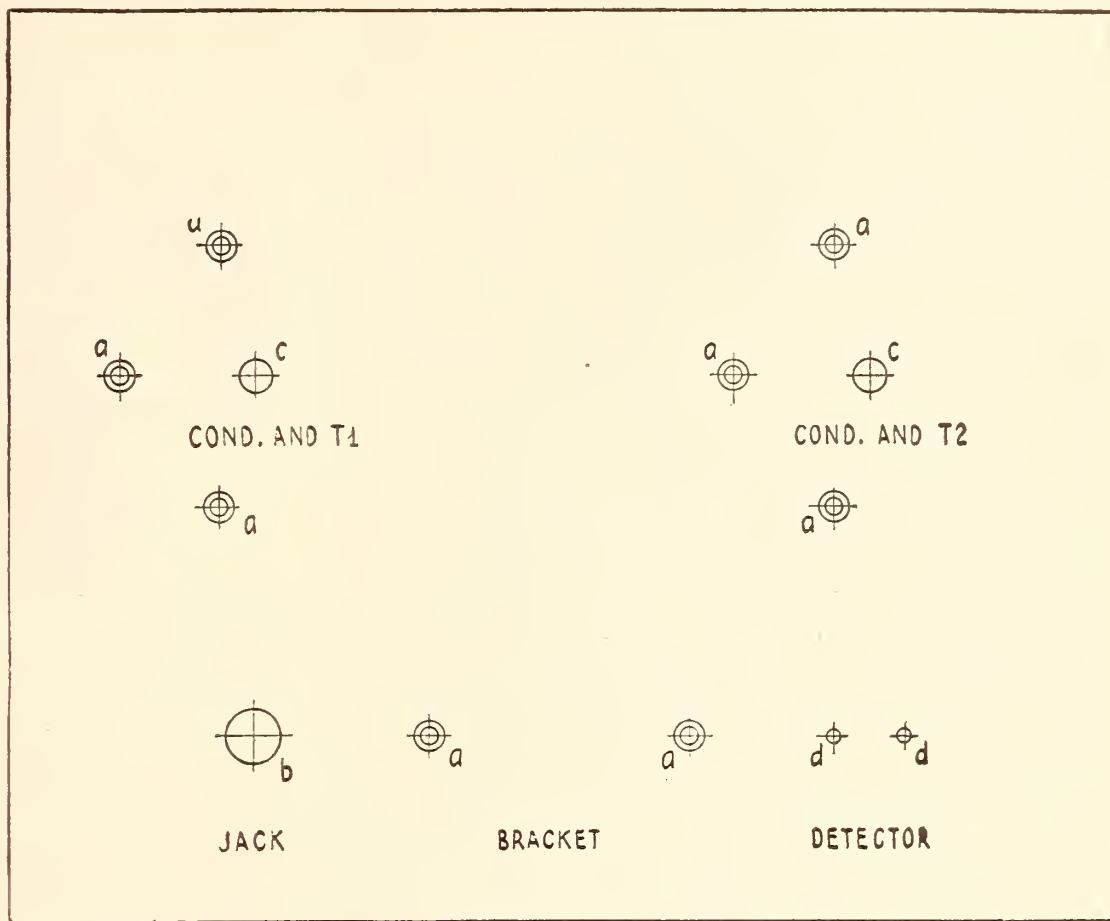

FIG. 7

This plan is  $\frac{4}{5}$  the actual size of the panel. For *a* holes, use No. 27 drill and countersink the holes to fit flat-head screws; for *b*, use No. 27 drill; for *c*, use  $\frac{5}{16}$ " drill; for *d*, use  $\frac{9}{16}$ " drill

battery terminal runs direct to one filament contact while the negative A battery terminal goes through the automatic filament control jack break and the "Amperite" mounting (R1) to the other filament contact, thus completing this circuit.

The transformers are connected as follows:

T1—No. 1 to the aerial binding post; No. 2 to the negative A battery terminal; No. 3 to the stationary plates of the variable condenser and then to the grid spring of the tube socket; No. 4 to the rotary plates of the variable condenser and to the "G" terminal of the secondary of the audio-frequency transformer, T3.

T2—No. 1 to the plate contact of the tube socket; No. 2 to the positive B battery binding post. No. 3 to the stationary plates of its variable condenser and to either terminal of the crystal detector; No. 4 to the positive B terminal of the primary of T3 and the rotary plates of the condenser.

T3—"F" to negative A battery terminal; P to the other side of crystal detector. Connecting the negative B battery binding post to the long curved spring of the jack completes the circuit and the receiver is finished!

## RESISTANCE STRIPS FOR DIFFERENT TUBES

"AMPERITES" or automatic ballast resistances may be purchased in two types; one (PT) for power tubes—that is, tubes drawing 1 ampere; the other (1A) for  $\frac{1}{4}$ -ampere tubes such as the WD-11, WD-12, all the "C" tubes and UV-201-A. The resistance of both types varies with the current in such a manner that light fluctuations above and below the normal battery voltage do not produce a corresponding change in filament current. This property of varying resistance is the chief asset and, strange to say, the greatest drawback of this type of ballast resistance. For, when a battery is applied to a circuit containing a fixed resistance (such as the filament of a vacuum tube) and a varying resistance such as an "Amperite" the initial current is governed solely by the sum of the value of the fixed resistance and the Amperite—when "cold." And, unfortunately, the resistance of an Amperite is much lower when "cold" than when heated by passage of current—therefore the in-

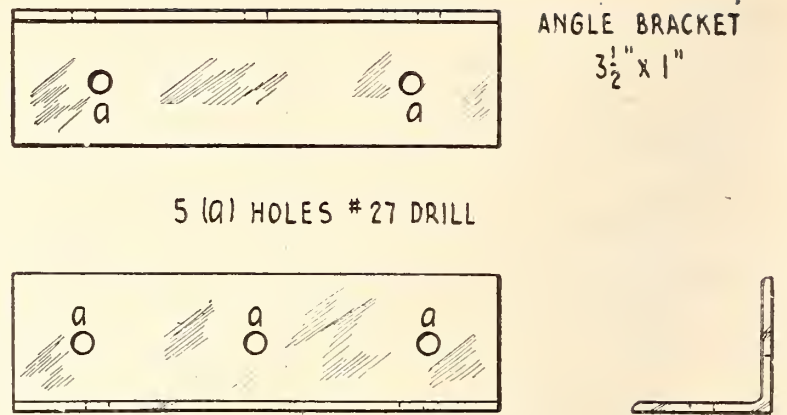

FIG. 9

This is the bracket (half actual size) that fastens the sub-panel to the main panel

itial current is in excess of the proper value and is quite harmful to the filament of a tube.

For this reason and also because ballast resistances are not made for all types of tubes, we have for some time been using fixed wire resistance strips which may be slipped into the regular mounting. They are easily made, and with the proper length and size wire may have any value of resistance.

The first few were made from portions of the resistance element of a regular 6-ohm rheostat. Each portion was 2" in length and utilized the resistance wire salvaged from the rheostats.

A much neater job can be made however if  $\frac{3}{8}$ " insulating rod cut into 2" strips is fitted with two metal end pieces and wound with the resistance wire, both ends of which are soldered to the end pieces. The rod should be threaded so the wire will not slip and short circuit adjacent turns. Small thumb tacks or similar devices have been employed as connecting end terminals.

It is necessary to know or determine the resistance per unit length of wire in order that the proper amount may be employed to offer the correct resistance.

Having selected a type of tube and the A battery voltage, reference to the table will enable selection of the proper resistance strip. Thus, if a UV-199 with 4.5 volts "A" are chosen, a strip of 30 ohms should be inserted in the sub-panel clips; a WD-11, WD-12, or W. E. "N" tube with a single dry cell will require a 2-ohm resistance, and so on.

Choice of tubes and batteries rests with the constructor; personally we prefer a UV-201-A with 4 series dry cells or a 6-volt storage battery. However, the UV-199 with 3 series dry cells very nearly equals the UV-201-A and is much more practical for dry cell operation. The

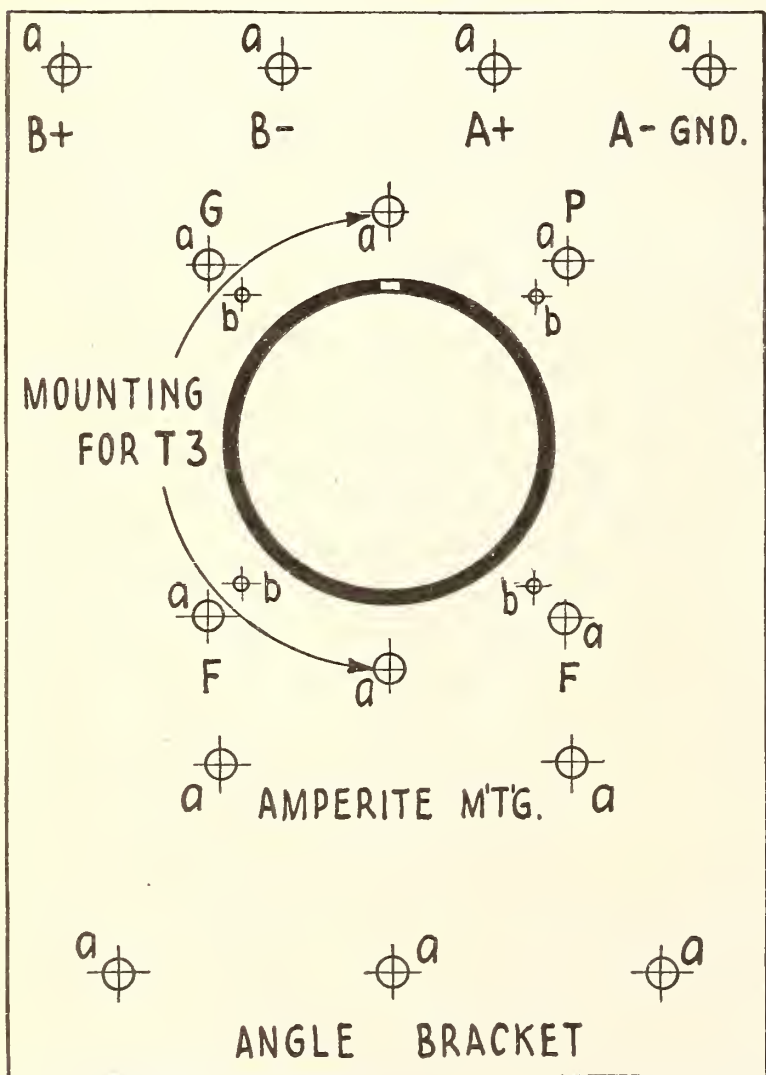

FIG. 8

Plan for the sub-panel. This is in correct proportion, but less than actual size ( $\frac{1}{4}$ ). For *a* holes, use No. 27 drill; for *b* holes, use No. 52 drill

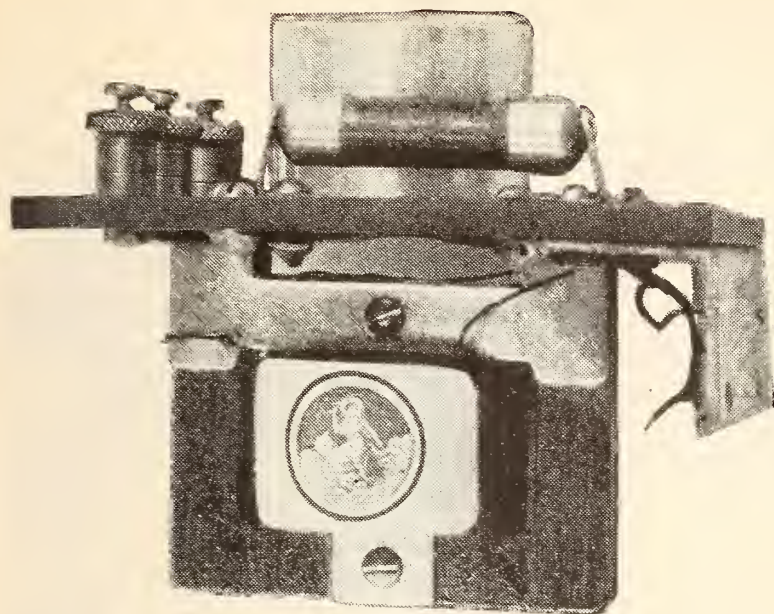

FIG. 10

The sub-base from the left

WD-11, WD-12, and W.E. "N" tubes are of the single dry cell type; they operate quite well, but it has been our experience that they come through very irregularly—some being good and others quite the opposite. The B battery voltage may vary from 45 to 90 although with this receiver as much as 300 volts has been applied to the plate of a UV-201-A; the resultant volume being comparable to the output of a single-tube super-regenerative receiver.

The following table shows the value of resistance for use with different A battery potentials on various tubes in order to restrict the current to a point slightly below the normal consumption rate.

TUBE	BATT. VOLTAGE (Representing 1, 2 and 3 storage cells and 1, 2, 3, and 4 dry cells.)	RESISTANCE	CURRENT
UV-201-A	6.0	6.0	.23
UV-201-A	4.5	0.*	.22
UV-201-A	4.0	0.*	.20
WD-12 } WD-12 } or-11	1.5	2.0	.23
	2.0	4.1	.23
UV-199	3.0	0.*	.06
UV-199	4.0	18.0	.06
UV-199	4.5	30.0	.06
UV-199	6.0	55.0	.06
UV-201	6.0	1.5	.92

## THE CABINET

THIS may be readily constructed at home if one is at all handy with wood working tools. Otherwise, it should be purchased.

The left-hand battery compartment is for the filament heating source, and the right-hand

\*Direct short. May be made like other resistance strips but has only a copper wire joining the end terminals.

compartment for the plate battery. Sufficient room is allowed to accommodate medium size B batteries and full size A dry cells without crowding.

The panel is set back in its compartment 2'' and is held in place with four flat head  $\frac{3}{4}$ '' wood screws driven into corner blocks  $\frac{3}{4}$ '' square and 2'' long.

Finish is optional, but a dull gloss seems to be popular.

## THE AERIAL

PARTICULAR care should be taken in the design of the aerial as, for best results, the resistance should be low. We advise a single-wire aerial, 100' to 150' in length, at least 20' above surrounding objects. The lead-in may be a continuation of the aerial wire and should be brought away at right angles to the horizontal portion. Glazed porcelain insulators are doubtless best for a small receiving system and should be used at all points of suspension.

In the event that an aerial cannot conveniently be employed, reception may be effected with a ground connection alone. This usually will give equal if not better results than a small aerial. The ground should be connected to the aerial terminal and the receiver tuned in the usual manner. Several grounds should be tried—the best type appears to be

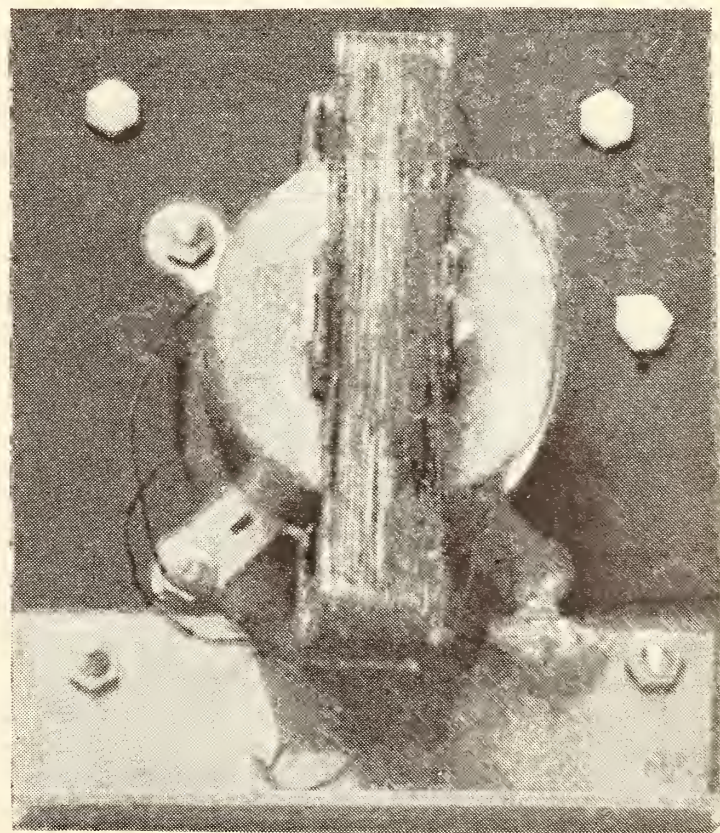

FIG. 11

The sub-base from below

one in which a rather long lead runs to a distant ground; this is, in effect, a grounded aerial with the receiver connected to the free end. The lighting system may be employed in a similar manner through use of an "antenna attachment"—if results are satisfactory the more or less cumbersome aerial may be dispensed with.

#### INSTALLATION

(A) Connect both A and B batteries to their respective binding posts—care being taken to have the polarity correct. Use number 18 or heavier rubber-covered stranded wire and keep all leads short and direct.

(B) Insert the vacuum tube and Amperite in their sockets and ascertain that positive contact is assured; it would be well to bend up the socket springs slightly in order that they may exert considerable force upon the vacuum tube pins.

(C) Connect a suitable ground to the negative A binding post and an aerial such as described above to the aerial binding post.

#### OPERATION

(A) Place the output plug in the jack; the vacuum tube should light instantly.

(B) Set both dials to the same point and adjust the crystal detector until a fairly strong "click" is heard.

(C) Slowly vary both dials between maximum and minimum position, maintaining them in approximately equal relation to each other.

(D) When a station is heard, turn the grid variable condenser and center it for stronger response, following this by adjusting the detector for better results.

(E) Further manipulation of the crystal for the most "sensitive" adjustment will improve both the quantity and quality of reception.

(F) With an average antenna, both dials will nearly coincide for any wavelength. No difficulty will be experienced in tuning both circuits to the same resonant frequency, as clicks (from crystal adjustment) are heard only when the grid and detector circuits are in

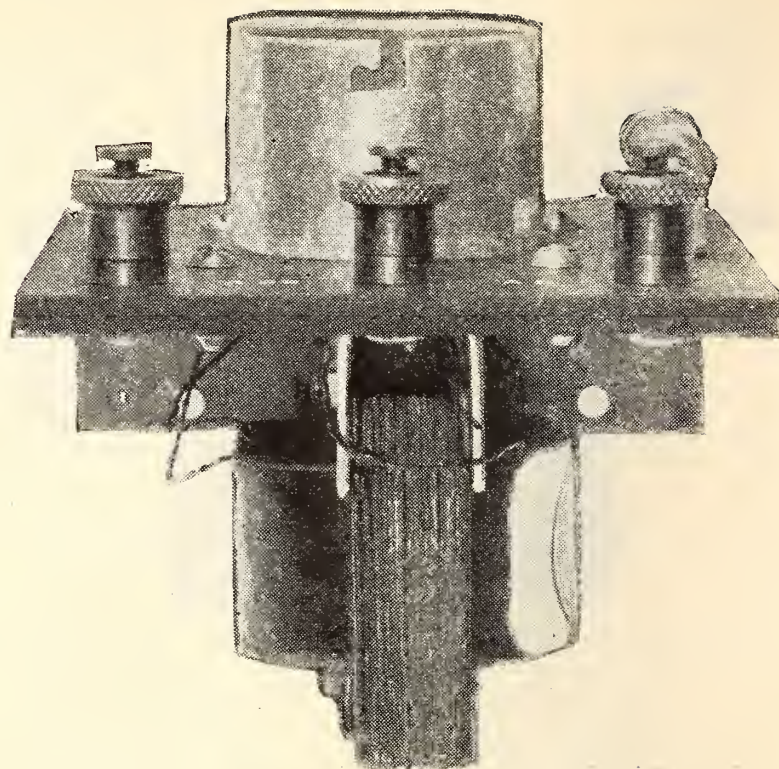

FIG. 12

The sub-base from the rear

tune with each other; being loudest when the circuits are exactly in resonance.

(G) When the crystal contact is "off," the receiver may oscillate, especially if headphones are used while tuning. There are a few methods of stopping this, but as it is rarely annoying special precautions are not necessary.

(H) On strong signals, the condenser in the crystal detector circuit is not very critical, but it has a well defined maximum resonant peak which may be passed over if this control is varied too rapidly.

(I) It is the *combination* of controls that makes for selectivity, and both are quite critical on weak stations.

(J) The crystal adjustment is important not only for strength and clarity of signals but also for selectivity.

(K) On a stiff piece of manila paper provide three columns to record:

(1) Stations call letters, (2) T1 dial settings and (3) T2 dial settings. This record may be permanently placed on the inside of the cover (under transparent celluloid, for example) and referred to when the program of a certain station is to be tuned in.

#### IMPORTANT NOTICE

For the broadcasting wavelength range we have found that variable condensers from .00029 to .0004 are preferable to .0005, but if you already have .0005 they will do very well. The coils described as T1 and T2 may be made by securing two 60-turn duolateral or honeycomb coils and winding the necessary number of turns for the primaries right on the outside edge. Arrangements have been made with several manufacturers to supply any of the parts by mail, if your local dealer cannot supply you.—THE EDITOR.



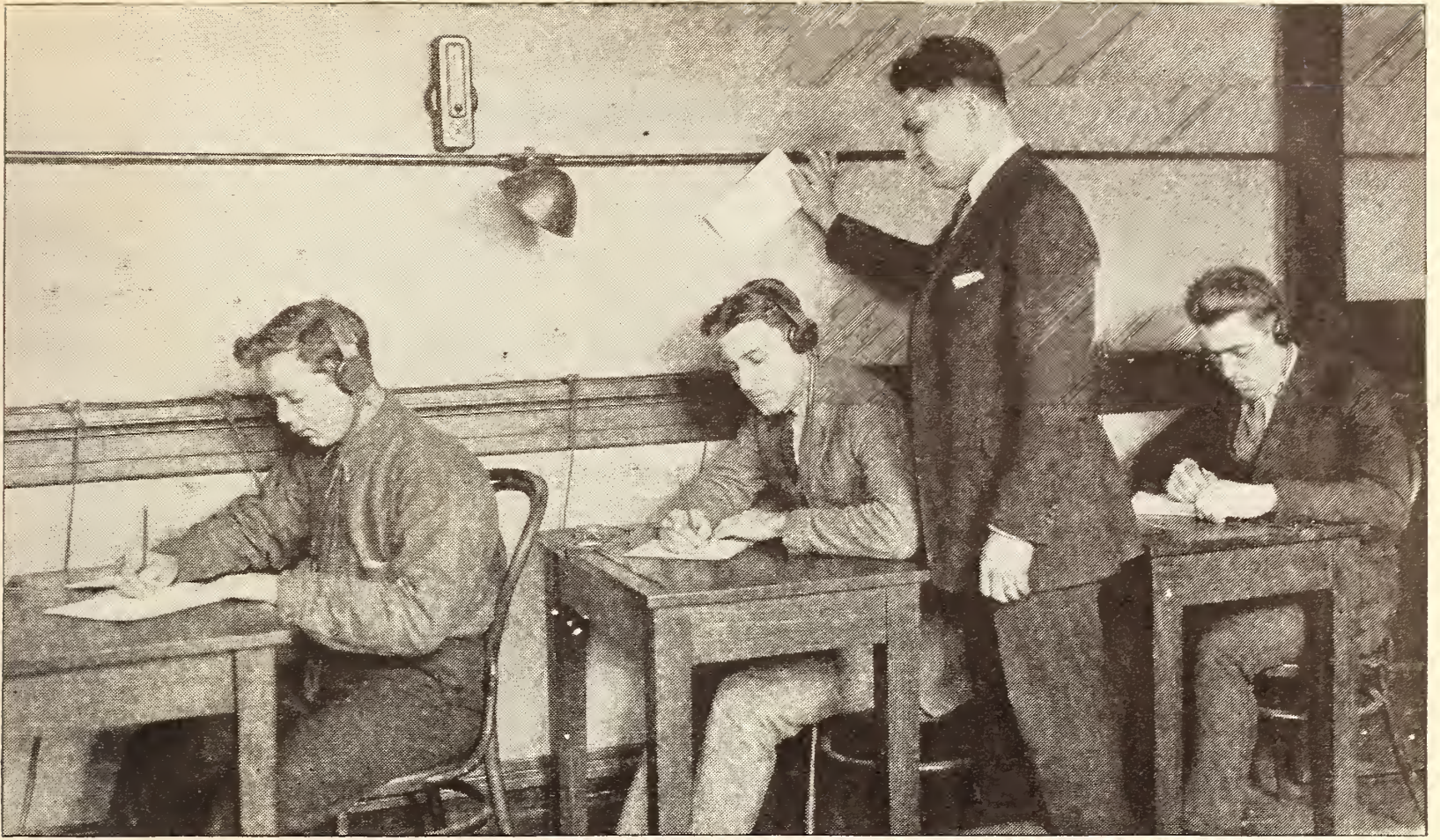

#### TAKING THE CODE EXAMINATION AT NEW YORK

Embryo operators in the office of the radio inspector copying the Omnigraph. The code examination must be passed before the second part—the theoretical—can be taken

# Why Some Applicants for Operators' Licenses Fail

By HOWARD S. PYLE

Assistant U. S. Radio Inspector, Eighth District

**I**N GLANCING over the results of recent examinations for radio operators' licenses, held by the writer in several large cities, a considerable number of failures were noted. This suggested an analysis of the probable causes for these failures and a determination on the part of the writer to offer his findings in an effort to bring about a more general understanding of how such examinations are given. Many possible failures may perhaps become successes, if the applicant profits by the mistakes of others.

Suppose we consider the various grades of licenses issued by the U. S. Department of Commerce and set forth briefly the qualifications required for each, taking up the probable causes for failure as we go along. Skipping the cargo grade (almost never issued), the

lowest class of operating license is the Amateur Second Grade. This is the only class of license issued without a personal examination. It is in reality only a temporary permit, issued for a period of one year, or, as stated on the form, until the applicant has been duly examined. Such license permits the operation of an amateur radio station at a point remote from a radio inspection office or from any of the points on the usual itinerary of a radio inspector. Where such licenses are issued, cards are always mailed to licensees, telling them when a radio inspector is to be in their vicinity, and informing them of the date and place of examination. It is then expected that all holders of Amateur Second Grade certificates will present themselves for examination. Failure to appear for such personal examination results in the cancellation

of the Second Grade license. It is realized, of course, that circumstances may actually prevent attendance of a few holders of the temporary certificate, and if satisfactory evidence is furnished to the Supervisor of Radio in the district controlling the examination that attendance was impossible, the licensee is excused, but he must appear at the next scheduled examination.

An applicant appearing for personal examination, who has held a Second Grade Amateur operator's license, has exactly the same standing as a man appearing for his first license. Rather than credit him with a few points for experience gained through operation of an amateur station, he is given an opportunity to demonstrate his superior knowledge and skill over the inexperienced man by what he writes on his technical examination.

#### THE AMATEUR FIRST GRADE LICENSE

**N**OW for the Amateur First Grade license: The amateur holding the First Grade operator's license has been personally examined by a representative of the Government and his knowledge has been found sufficient to warrant the issue of a more permanent grade of license than the second grade, which is only a temporary permit.

The code speed test is run first in conducting an examination of an applicant for an operator's license of any grade. The code ability of the applicant must be determined before he is allowed to take the test on "theory." Should he fail to attain the prescribed code speed, he is then dismissed and his papers filed in the district headquarters. Since he has failed, he cannot present himself for re-examination until three months have elapsed. The same penalty

is inflicted if the applicant fails to pass his theoretical examination.

THE OMNIGRAPH IS NOT AN "INFERNAL-MACHINE"

**T**HE characters comprising the Continental telegraph code, arranged to form sentences, words, and phrases, are transmitted automatically by a spring motor device known as the Omnigraph. This instrument reproduces the characters of the Continental code perfectly on a high-pitched buzzer. It is often contended that the machine-like transmissions of

the Omnigraph are unnatural and not true to the usual type of manual sending to which applicants are accustomed. This is true, to a certain extent. The automatic transmission is perfect, whereas hand sending is a bit erratic and always individual. The use of an automatic device, however, enables an accurate, even speed to be maintained and eliminates any possible chance of error. The writer

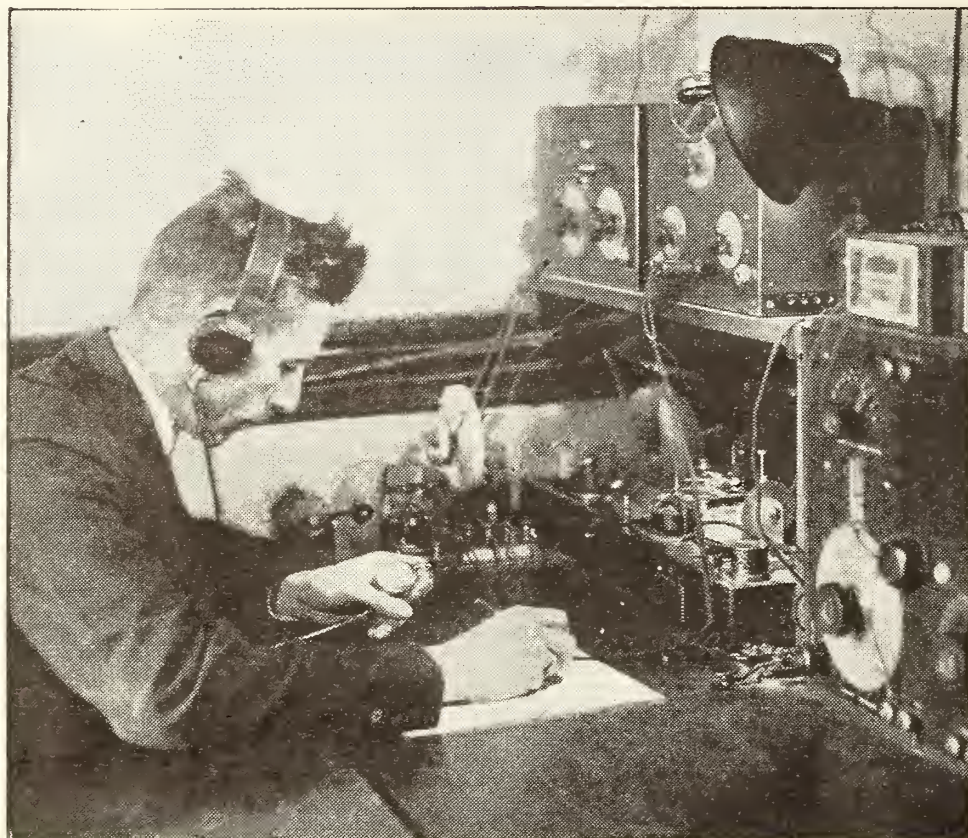

CHARLES T. MANNING

Conducting a code examination with the Omnigraph at New York. All code tests for licenses last for five minutes

much prefers to copy the even, precise transmissions of the Omnigraph or of an automatic tape transmitter than most styles of hand sending. The adverse sentiment toward the Omnigraph, however, has often frightened applicants for radio operator licenses. They are led to believe that it is a horrible instrument of torture—an infernal machine that simply cannot be copied. When the applicant comes up for his code examination he is frequently nervous and loses some control over his faculties and is unable to concentrate on the buzzer properly. So, one of the main reasons for failure is nervousness induced by fear of the Omnigraph.

We have digressed from our subject of Amateur First Grade licenses somewhat, and gone into generalities, but it is well, since a fear

of the automatic transmitter is evident among all classes of applicants. A man who can copy five words a minute faster than the required speed when actually operating a radio station, can come successfully through the code transmission. He should not attempt the examination unless he has this "safety margin."

The code speed prescribed in the examination for Amateur First Grade operator's license is ten words per minute, and, counting five letters, numerals and other characters to a word as in the commercial tests. To pass such a test the applicant must receive successfully fifty consecutive letters (ten words) from a group of two hundred and fifty characters transmitted. This, in reality, gives five opportunities to make the required transcription. The same opportunity is offered in the commercial tests.

Ordinarily, few amateurs who can successfully copy ten words a minute fail in their theoretical examination. During the period

the applicant has been learning the code, he mingles with his brother amateurs, visits their stations, and takes part in their conversations. In this way, he naturally acquires a fair knowledge of amateur equipment which is of great assistance to him in his examination.

The theoretical questions presented in an amateur examination take into consideration only the applicant's own station, or the station he proposes to operate. If he is reasonably well versed in the functioning of his apparatus, he will experience no difficulty. Few applicants fail the technical examination for the Amateur First Grade license, but almost invariably, those who do, fall down miserably on the questions regarding the radio communication laws and regulations. Apparently little or no attention is paid to the study of the laws. A copy of the Radio Communication Laws of the United States is readily obtainable by remitting fifteen cents in currency—



AN AMATEUR FIRST GRADE LICENSE

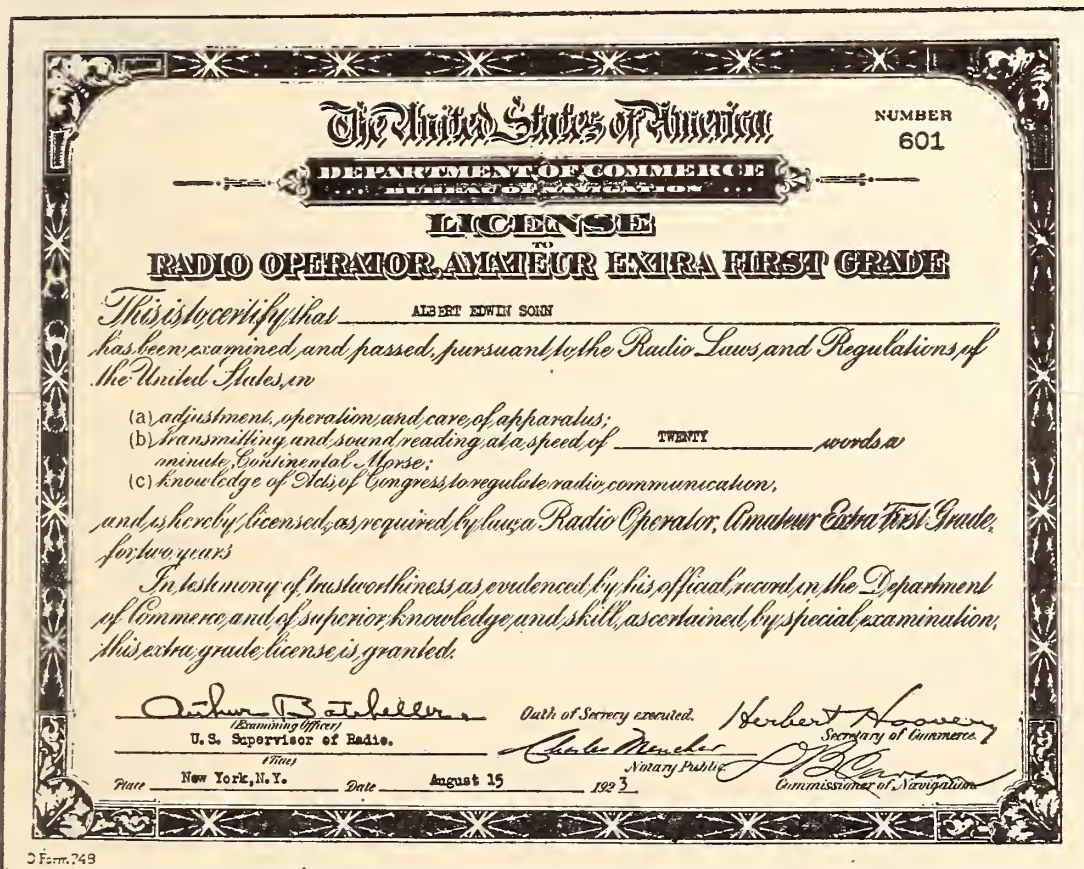

AN AMATEUR EXTRA FIRST GRADE "TICKET"

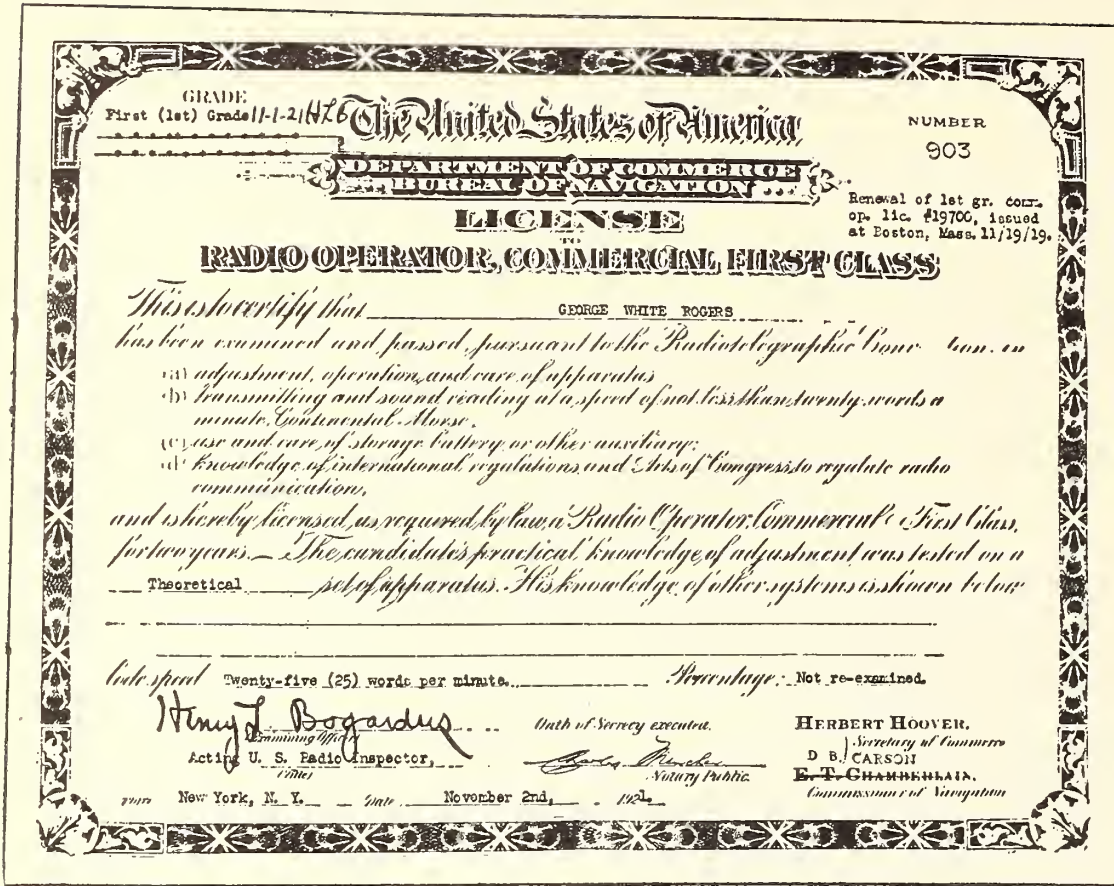

#### A COMMERCIAL FIRST CLASS, FIRST GRADE LICENSE

Ship and coast station operators must have a license of this class, grade one or two

not stamps—to the Superintendent of Documents, Government Printing Office, Washington, D. C. A copy of General Letter No. 252, setting forth the recent regulations governing amateur stations should also be secured from a district Supervisor of Radio. For the latter, no charge is made.

Study both publications thoroughly before you take the examination. It is well to familiarize yourself with the entire contents of the communication laws, paying particular attention, of course, to the sections devoted to amateur stations and operators. Learn the various penalties prescribed for violations.

When an amateur applicant can copy fourteen or fifteen words a minute at his station and is familiar with the functioning of his equipment, and has conscientiously studied the radio communication laws, he may be reasonably sure of success in his examination.

that the applicant must never have been penalized for any infraction of the radio regulations (as for instance, sending during quiet hours).

The theoretical examination for this grade of license deals with amateur continuous-wave

#### THE AMATEUR EXTRA FIRST GRADE LICENSE

THE Amateur Extra First Grade operator's license has recently been made available. This certificate was created at the request of representative amateurs of the country and represents a special award of merit to deserving amateur operators who are capable of meeting the requirements. A code speed, of twenty words a minute must be attained, and the applicant must have held an operator's license of some other grade for a period of two years before he is eligible for the Extra First Grade certificate. Perhaps the most important requirement is

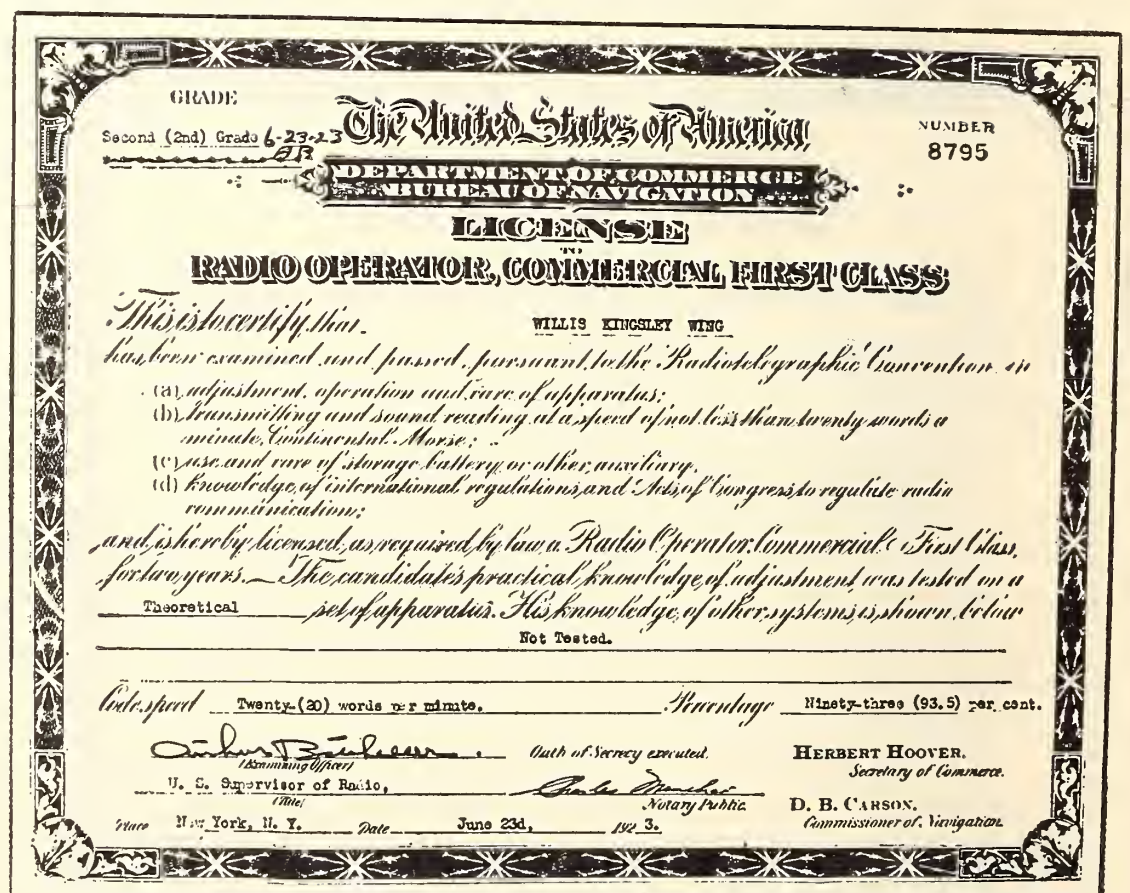

#### A COMMERCIAL FIRST CLASS, SECOND GRADE LICENSE

equipment exclusively, with a number of questions concerning the Department of Commerce radio regulations. If the applicant has a good working knowledge of amateur CW transmitters and receivers, he can ordinarily pass this examination. Inasmuch as comparatively few Extra First Grade licenses have been issued as yet, it is impossible to analyze reasons for possible failure at this time.

COMMERCIAL LICENSES: SECOND GRADE, THIRD CLASS

WE PASS now into the commercial grades of licenses. The lowest of this class is the Commercial Second Grade, Third Class. Holders of such certificates may serve as operators only in a restricted class of station—those not engaged in General Public Service communication, such as broadcasting stations and limited point-to-point stations.

The code speed required for this grade of license is twelve words a minute. An applicant successfully passing such a code test is then given a theoretical examination covering modern spark transmitting equipment as used in marine service; suitable receiving equipment; common radio measurements; storage batteries; motor-generators, and radio communication laws and regulations. Passing the code test and failing to pass the theoretical examination

INTERIM LICENCE. F 86009

WIRELESS TELEGRAPHY ACT, 1904.  
Licence to establish a wireless receiving station.

Mr. Walter Chahlin  
(Name in full)  
of 17 William Rd. N.W. 17  
(Address in full) is hereby  
authorised (subject in all respects to the conditions set forth on the back hereof) to establish  
a wireless station for the purpose of receiving messages at above  
address (Address of Station)  
for a period ending on the last day of the month  
of Sept 30th 1924  
(Date of expiration)  
The payment of the fee of fifteen shillings is hereby acknowledged.  
Dated 5th day of Oct 1923  
Issued on behalf of  
the Postmaster-General } G. G. G. G.  
for Postmaster.  
Signature of Licensee  
If it is desired to continue to maintain the station after the date of expiration a fresh  
licence must be taken out within fourteen days. Heavy penalties are provided by the  
Wireless Telegraphy Act, 1904, on conviction of the offence of establishing a wireless  
station without the Postmaster-General's Licence.  
Act 1904 194

AN ENGLISH LISTENER'S LICENSE

Each listener must be licensed in England and it costs 15 shillings

can be attributed to one or more of the following reasons: the applicant has been unfamiliar with the apparatus and circuits of a modern ship-board radio transmitter. The questions were answered too briefly or only in part; he was unfamiliar with the care and construction of the storage-battery; he had insufficient knowledge of motor-generator equipment; or he had no clear idea of radio communication regulations and penalties invoked for violations. A large number of failures are due to the last-mentioned question, while almost as great a number can be attributed to the applicant's inability to sketch in detail the complete circuits of a modern shipboard radio installation. All the above-mentioned points require a large amount of study and application to make the student thoroughly prepared for examination.

COMMERCIAL FIRST GRADE, THIRD CLASS

THE next step above the second grade commercial license is known as the Commercial First Grade, Third Class license. The holder of such a certificate is eligible to any position in the radio operating field; he may operate at any class of station—marine or broad-

The United States of America  
DEPARTMENT OF COMMERCE  
BUREAU OF NAVIGATION  
LICENSE  
RADIO OPERATOR, COMMERCIAL EXTRA FIRST GRADE

NUMBER 9

This is to certify that Joseph Allen Worrall  
has been examined, and passed, pursuant to the Radiotelegraphic Convention, in:  
(a) adjustment, operation and care of apparatus;  
(b) transmitting and sound reaching at a speed of thirty (30) words a minute Continental Morse and twenty-five (25) words a minute American Morse;  
(c) use and care of storage battery or other auxiliary;  
(d) knowledge of international regulations and Acts of Congress to regulate radio communication;  
(e) knowledge of United States Naval Radio Regulations,  
and is hereby licensed, as required by law, a Radio Operator, Commercial Extra First Grade, for two years.

In testimony of trustworthiness and efficient service, as Radio Operator for twenty-nine (29) months, of which twenty-nine (29) months were service at sea, and of superior knowledge and skill, ascertained by special examination, this extra grade license is granted

A. Sterling Sept. 23, 1914  
Commanding Officer, U.S. Navy, Navy Yard, New York  
Date of Service executed  
Secretary of Commerce  
Notary Public  
Commissioner of Navigation

EXCELSIOR

The highest grade license issued by the Government—the Extra First Grade Commercial. Only a few of these have been issued

cast—coastal or inland. He is required to attain a speed of twenty words a minute and pass a more comprehensive theoretical examination than that required for a second grade license. He must have a knowledge of several types of spark transmitters as well as a working knowledge of undamped wave generators. His knowledge of receiving equipment must comprise receivers suitable for use in both damped and undamped wave reception. A more extensive knowledge of storage batteries and motor-generators is called for; as well as a good understanding of the communication laws and the method of handling radio traffic. The causes for failure to obtain this grade of license are practically identical with those set forth under our discussion of the second commercial class. We might add one more point here, which would be equally applicable to all classes: carelessness in reading the questions, with consequent misinterpretation of the information called for. This, naturally enough, is no excuse and will not serve to pull you through what would ordinarily be a below-passing grade.

A system of grading commercial licenses according to experience is now in effect. The holder of a First Grade, Third Class commercial license, may have it raised to the First Grade, Second Class when his service record on the reverse of his license form shows six months satisfactory service on a General Public Service station, as attested to by the signatures of the master, manager, or superintendent of his employing companies. Similarly, when twelve months of such service can be proven by proper evidence, and a code speed of twenty-five words a minute attained, an applicant will have the status of his license raised to that of Commercial First Grade, First Class.

One additional grade of license is issued.

It is known as the Commercial Extra First Grade. This is the highest grade license it is possible to obtain and is issued as a testimony of efficient and trustworthy service as radio operator, and an acknowledgment of superior knowledge and skill, as ascertained by a special examination. A code speed of thirty words a minute in the Continental code, and twenty-five words a minute in American Morse is required, in addition to the special theoretical examination covering all types of radio equipment in use to-day.

Few of these licenses have been issued, and no data is available from which to construct possible causes for failure in this class.

#### IN GENERAL

IT MAY be said that failure to pass license examinations is due often to carelessness, the omission of some vital part in a circuit diagram, or the total omission of one or more of the sub-questions. Neatness is taken into consideration as well—your writing should be legible to the examining officer. He is forced to give you no credit for what cannot be deciphered. The use of pencil is permitted in all examinations, but only one side of the paper should be used. Attention to the instructions at the head of the question sheets may save errors.

An effort has been made in the foregoing paragraphs to clear up, in the minds of the aspirants to radio operator licenses, several misunderstandings that have existed in the past, and to remove the shroud of mystery that has apparently encircled such examinations. It is believed that an outline of the general requirements for the various grades of radio operator licenses, will enable the student to prepare himself more intelligently and to concentrate more readily on the more vital points of the examinations.



# A Beginner's C. W. Transmitter

## PART V

### Various Circuits and What They Mean

By ZEH BOUCK

IT IS inevitable that the majority of broadcast enthusiasts, at some time, and with more or less seriousness, consider the possibility of installing transmitting apparatus. They are very few who do not acknowledge the lure of radio intercommunication, whose fascination far exceeds that of passive listening. This is particularly true of our younger enthusiasts to whom the toy telegraphs and the tin can telephones of back-yard days are not very distant memories. But radio communication is a far more serious thing, involving infinitely deeper considerations, than a baking soda tin and a piece of string; and the experimenter, young or old, who enters upon this side of the game precipitately, injures not merely himself but the entire citizen radio world.

Mr. Carl Dreher, in his recent articles in this magazine dealing with the relation of the amateur to the broadcast enthusiast, has ably demonstrated the crucial situation with which citizen radiodom is confronted. There exists between these two factions considerable friction, a general rubbing of fur in the wrong direction, caused, chiefly by misunderstanding on the part of the BCL (broadcast listener). This feeling is certainly aggravated by a host of inexperienced amateurs, who are, however, *no less a thorn in the side of the experienced citizen operator*. These, the nation's radio experts acknowledge as a genuine asset. This lamentably large group of inexperienced operators, which has

grown to really tragic proportions in the last two years, has undoubtedly recruited, and continues to recruit its members from the ranks of the broadcast enthusiasts.

Our reader should therefore think more than twice before engaging a venture in which his lack of experience will gain him the active antagonism of the true blue amateur (upon whom his intercommunicative pleasure largely depends) and of his former friends among the broadcast enthusiasts. He will be the fabled crow in the feathers of the dove, unaccepted and scorned by the crows and doves of genuine plumage.

#### THE OPERATOR HIMSELF

THE first consideration of the prospective operator should be his own ability. The requirements need not be treated in detail, for one item alone implies proficiency in all others. *The amateur should not touch a key, on other*

*than a practice set, or a transmitting microphone, until he can send and receive twenty words a minute with ease.* This means months of constant practice—a half-year of code copying which almost invariably brings with it a knowledge of amateur ethics and traditions, the method of handling traffic, an appreciation of concise calling and signing—in short, a theoretical and practical knowledge of radio.

#### HIS FIRST SET

THE transmitting equipment with which our amateur

In his introduction to the accompanying article, Mr. Bouck has touched lightly but well on the amateur situation in its relation to the newcomer and the increasing number of transmitting stations. Mr. Bouck himself is a radio amateur, one of the most prominent in the East, and his ideas, are the result of many years of experience and observation.

It is suggested that our readers who are genuinely interested in building and operating a transmitter send to the Government Printing Office, Washington, D. C., for a copy of *Radio Communication Laws of The United States* and *The International Radio Convention*, which can be obtained for fifteen cents each. Knowledge of the contents of this book is essential to pass the government examination and the securing of a license, which, of course, must be had before one can transmit on even the simplest of apparatus. We regard this as one of the best "How to Make It" articles ever published in this or any other radio magazine.—THE EDITOR.

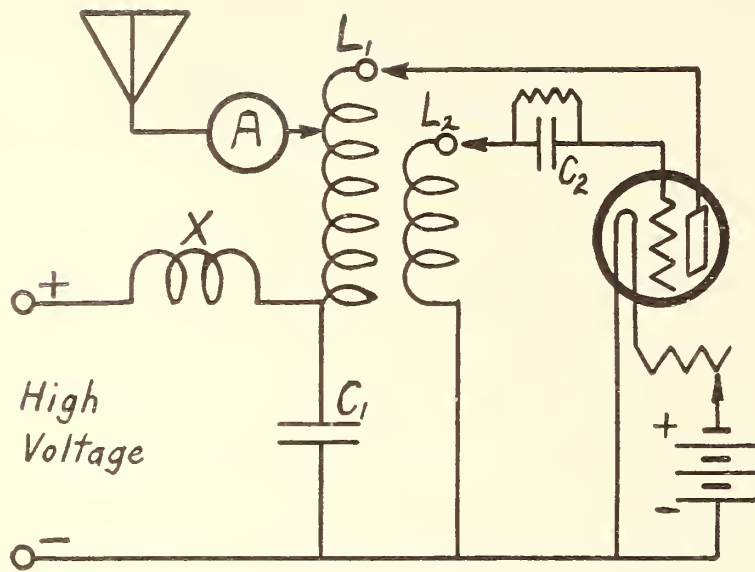

FIG. 1  
The Fundamental Circuit

makes his *début* must meet several exacting requirements. It must, in the first place, cause a minimum of QRM (interference) to the other amateurs, and none at all on broadcasting waves. This immediately eliminates all forms of spark transmitters such as the induction coil, which, because of its economy and simplicity, appeals to the budding operator. Likewise, excepting in the most isolated radio districts, all forms of I. C. W. (interrupted continuous wave, accomplished by the use of buzzer, chopper etc.), poorly rectified and filtered alternating current, and the radio telephone are frowned upon. This leaves us only pure continuous wave transmission, which, however, is the most efficient form of radio communication known, and which makes possible fairly long distance transmission on the low power apparatus to which the beginner is necessarily limited. Also, the operator of apparatus of this type finds the warmest welcome "on the air" from his more experienced brothers. A comparatively inexperienced operator with pure C. W. is tolerated, even welcomed, where, with a less sharply tuned transmitter, he would certainly be most unpopular.

Simplicity and cost are other considerations which quite decisively eliminate the motor-generator with its elaborate filter and high power apparatus. Only the B battery is now left to us as the source of plate voltage. So the ideal beginner's set resolves itself into the following:

A B-battery C. W. set, operating from the amplifying plate potential from the receiving set, using an amplifying tube as an oscillator, built entirely of easily procured and cheap receiving parts (excepting the "radiation" meter).

#### THE IDEAL BEGINNER'S SET

FIG. 2 is the front view of a C. W. transmitter built according to the conditions outlined above. Fig. 1 shows the fundamental circuit, which, in the category of various types of oscillators, is the tickler feed-back system with inductive grid coupling.

$L_1$ , the combined plate and antenna coil, is wound on a three and a half inch diameter tube with forty turns of wire, tapped every two turns. No. 18 annunciator is a convenient wire to use. The simplest manner of tapping,

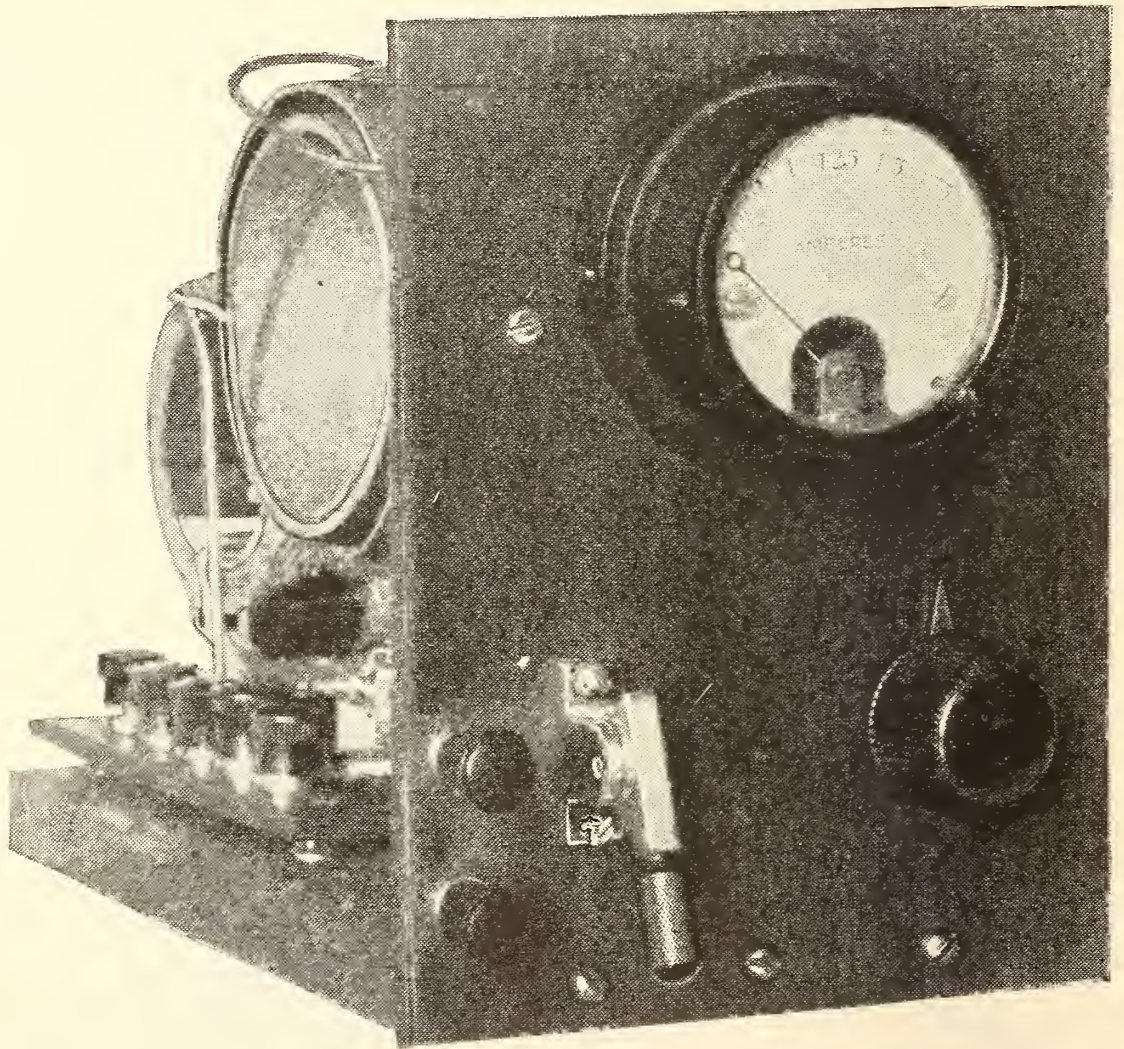

FIG. 2

The ideal beginner's C. W. transmitter which has a daylight range of about five miles and can be built for less than \$20



and that employed by the writer in building this set is to twist the wire into a half-inch projection every other turn, staggering the taps in a progression of four so that clip connections can later be made without crowding. When the inductance is completely wound, the insulation is burned from the taps. They are then given a tightening twist, scraped clean, and tinned with solder. L<sub>2</sub>, the grid coupling coil, or tickler, is wound on a three-inch tube with the same size wire. Twenty turns are wound, tapping at 10, 12, 14, 16, 18 and 20 turns. The taps on L<sub>2</sub> are brought through the tubing, and the ultimate connections are made from the inside. This permits L<sub>2</sub> to fit, without forcing, inside of L<sub>1</sub>.

C<sub>1</sub>, though a by-pass capacity for the greater part, will vary between .0005 mfd. and .002 mfd. for various wavelength adjustments. C<sub>2</sub> is a grid condenser, .0005 mfd. capacity (some times greater) shunted by a leak, the resistance of which varies inversely with the plate voltage. With voltages in the neighborhood of one hundred, it may be as high as  $\frac{1}{2}$  megohm, while with transmitting tubes, and on plate potentials in excess of three hundred and fifty volts, the resistance is often as low as five thousand ohms.

A is a "radiation" ammeter. X is a high frequency choke-coil, generally about two hundred turns of wire on a three-inch winding form.

#### THE SPECIFIC CIRCUIT

THE more experienced enthusiast can easily follow the circuit given in Fig. 1, adapting it to his individual requirements and wishes. The circuit exactly as employed in the set to be described, is shown in Fig. 3.

L<sub>1</sub> and L<sub>2</sub> are wound as described for the general circuit. The tubes on which the two coils are wound are each four inches long. If No. 18 annunciator wire is used, the forty turns on L<sub>1</sub> will cover exactly three inches, leaving a half inch margin on each side. In the center of the half inch margins, that is,  $\frac{1}{4}$  inch in from each edge, holes, passing an  $\frac{8}{32}$  machine screw, are drilled or punched. Later, these holes facilitate the fastening of brackets which support the inductances on the panel.

X, the radio frequency choke, is

a honeycomb, size DL200. (Incidentally, this coil is not necessary to produce oscillations in this circuit, but its presence permits the regulation of wavelength by condenser C, by preventing the short-circuiting of this capacity through the plate source.)

C<sub>1</sub> is a .0015 mfd. Micadon. Under some conditions, a different capacity, within the limits mentioned in describing the fundamental circuit, may be desirable.

A is a "radiation" meter reading from zero to 250 milliamperes. In the particular meter the writer used, approximately this range was secured by removing the shunt resistance from a higher range meter.

R is a six-ohm rheostat, which is about right for all six-volt tubes when used for transmitting.

A grid condenser was originally provided on the base of the transmitting set, but it was found undesirable on most tubes when the set was operated on voltages below one hundred and fifty, so, in the photographs it is shown shorted over. It is not shown at all in the specific circuit.

The tube may be almost any hard amplifier. The UV-201-A works nicely, though best results were obtained with a Western Electric J tube, or VT-1.

S is the antenna change-over switch. In the upper or transmitting position, the antenna is connected to the transmitter, and the filament lighted. In the down position, the antenna is thrown to the receiving set, and the filament circuit to the transmitting tube is broken. This switch may be any type that performs a double-pole, double-throw function. It may be an anti-capacity key, or a telephone cam switch such as used by the author. The anti-

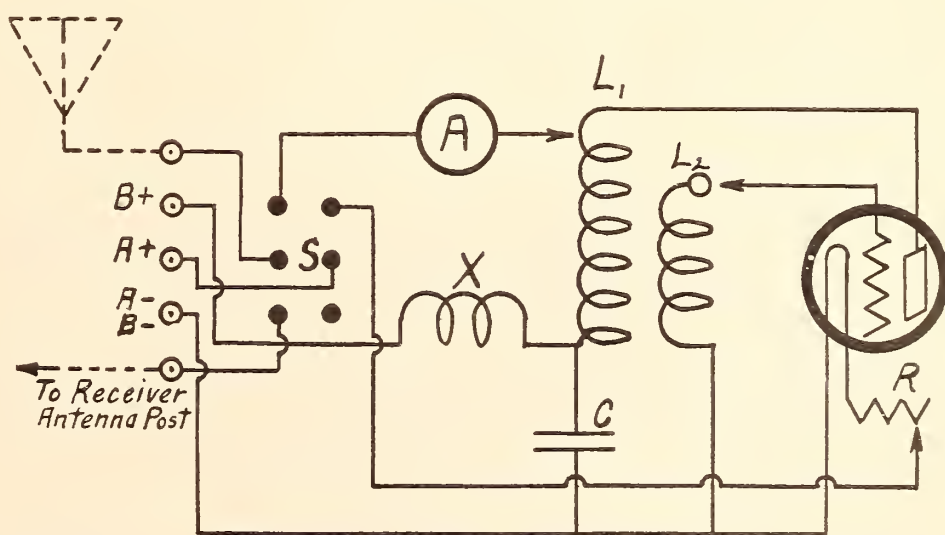

FIG. 3

The exact circuit used in the set



It will be observed that, in the specific circuit, no connections are indicated for the negative B battery or ground. This is because these connections are already effected through the writer's receiving set, a Grebe CR3, in which the positive of the filament is grounded and the negative B battery, of course, connected to the filament battery. Similar circumstances will be found in almost all receivers. Trace your circuit, and if you find the filament battery grounded, no similar connection should be made on your transmitter. If the A battery is not grounded, the negative terminal should be connected to the ground, through a switch for breaking the connection if it broadens the tuning while receiving, or otherwise complicates reception.

#### CONSTRUCTING THE SET

FIGS. 2, 5, and 6 show the completed transmitter as seen from different views. The panel is of hard-rubber,  $5\frac{1}{2}$  inches by 7 inches, a working drawing of which is shown in Fig. 4. All holes, excepting those designated as odd sizes, are drilled to pass a No. 8 screw. Two binding-posts are shown on the main panel, which are provided for making a front connection to the transmitting key if desired. If used, these posts are placed between the plate of the tube and the inductance. In the set the writer built, it was found more convenient to connect the key in the plus high voltage lead before it reached the positive B terminal on the transmitter. Incidentally, it is always a good idea, in view of possible later changes and expansion, to provide two extra binding-posts on any experimental apparatus.

The send-receive switch is on the left hand side of the panel, and the rheostat knob on the right.

The wooden base is  $\frac{3}{4}$  of an inch thick,  $5\frac{1}{4}$  inches wide and 9 inches long. The photographs, Figs. 5 and 6 show the placing of the various parts.

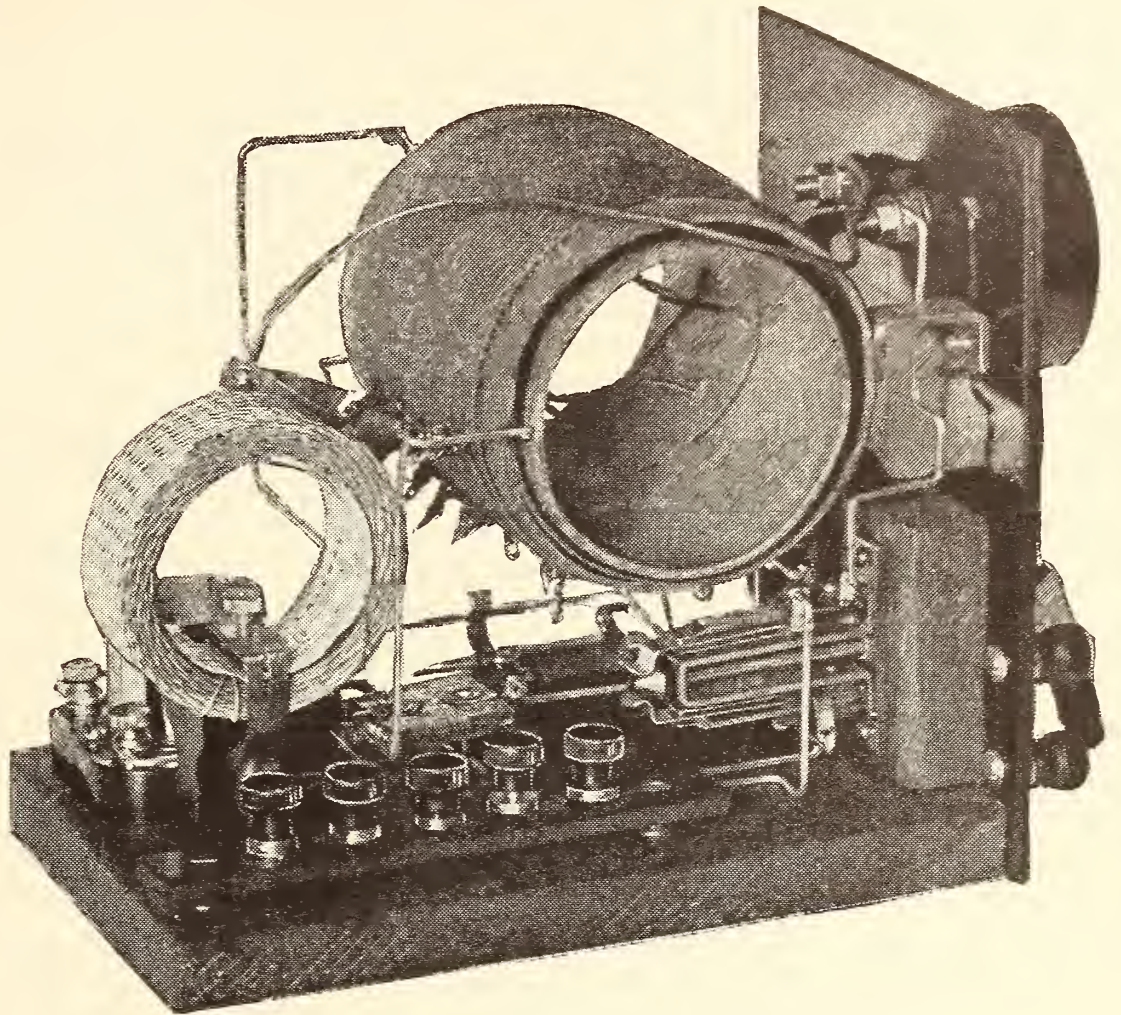

FIG. 5

The completed set from the left, rear

The honeycomb coil is mounted by drilling a small hole (passing a No. 8 screw) and forcing the single prong into it.

The binding-post strip is five inches long,  $\frac{3}{4}$  inch wide, with the posts spaced  $\frac{3}{4}$  inch between centers. This strip is cut from the same sheet of rubber as the front panel, originally a 7" by 10" standard panel which is carried by all dealers. A hack-saw, with a long blade, is used for cutting the hard-rubber. This is best accomplished by laying the panel flat on the table, cutting it as a slice of bread is halved in making a sandwich. This gives a much smoother and straighter edge than if you saw the material as you would a plank of wood.

After the binding-posts have been mounted, an inch and a half length of bus-bar wire is soldered to the nut or screw of each post. The strip is then screwed down to the base, two nuts taken from a dry cell, being used as washers to raise the connection strip  $\frac{3}{8}$  of an inch above the base. Connections are now made to the posts by soldering to the projecting stumps of wire.

All connections, excepting the direct leads to the inductances, are made as soon as the base instruments, the rheostat and change-over switch have been mounted.

When these have been completed (trace them and make sure that they are correct) the coils are mounted by means of the small brackets, fastened to  $L_1$ , and which are illustrated in Figs. 5 and 6. These brackets are made from  $\frac{3}{8}$  inch brass strips, two inches long, and bent over  $\frac{1}{2}$  inch in from each end. The two holes were drilled and tapped to take an  $\frac{8}{32}$  machine screw. If more convenient, they may be drilled to pass the screw and a nut used for holding.

The lower connection to  $L_1$ , that to the condenser C, is the only permanent connection to the inductances made before the transmitter is tuned. Flexible leads are provided for completing the circuit with test connections. The lead from the ammeter to the inductance is furnished with a clip for change of wavelength even after the set is permanently installed.

#### TUNING AND OPERATION

THE set is best tuned by observing the antenna current as indicated by the meter, and by listening to the transmitter on your own oscillating receiver. In doing this, the antenna is of course disconnected from the receiving set, by being thrown over, through the switch S, to the transmitter. Therefore, if you are using a single circuit receiver, connect a grid condenser, without leak, across the receiving antenna and ground binding-posts for the test.

Place the antenna clip on the 6th tap from the bottom, and connect the lead from the plate to the upper end of the coil. Now connect

### The Cost

The following is a list of parts required for building the set itself, and the approximate cost which the reader may expect to pay:

1 7" x 10" panel.....	\$ .85
1 Socket.....	.75
1 Change-over switch.....	1.00
1 Six-ohm rheostat.....	1.00
7 Binding-posts.....	.35
1 "Radiation" meter.....	5.00
8 Lengths of bus-bar wire.....	.32
1 Lb. annunciator wire.....	.90
Cardboard tubing.....	.40
1 Micadon condenser.....	.40
1 DL200 honeycomb coil.....	1.85
Total.....	\$ 12.82

the lower end of the grid coil to the negative filament, and the tap at the 18th turn, to the grid. Slip  $L_2$  inside of  $L_1$ , and light the transmitting filament quite bright. Make your receiving set oscillate, and tune, around 200 meters, for a beat note from the transmitter. If none is heard, reverse the connections to the grid coil.

Once the transmitting set is oscillating, it remains only to adjust it so that it oscillates

most powerfully at the desired wave (between 150 meters and 200 meters). This is accomplished by varying the plate and grid taps and soldering the leads at the most efficient adjustment. In the majority of cases, and with the average antenna, the plate tap will be kept

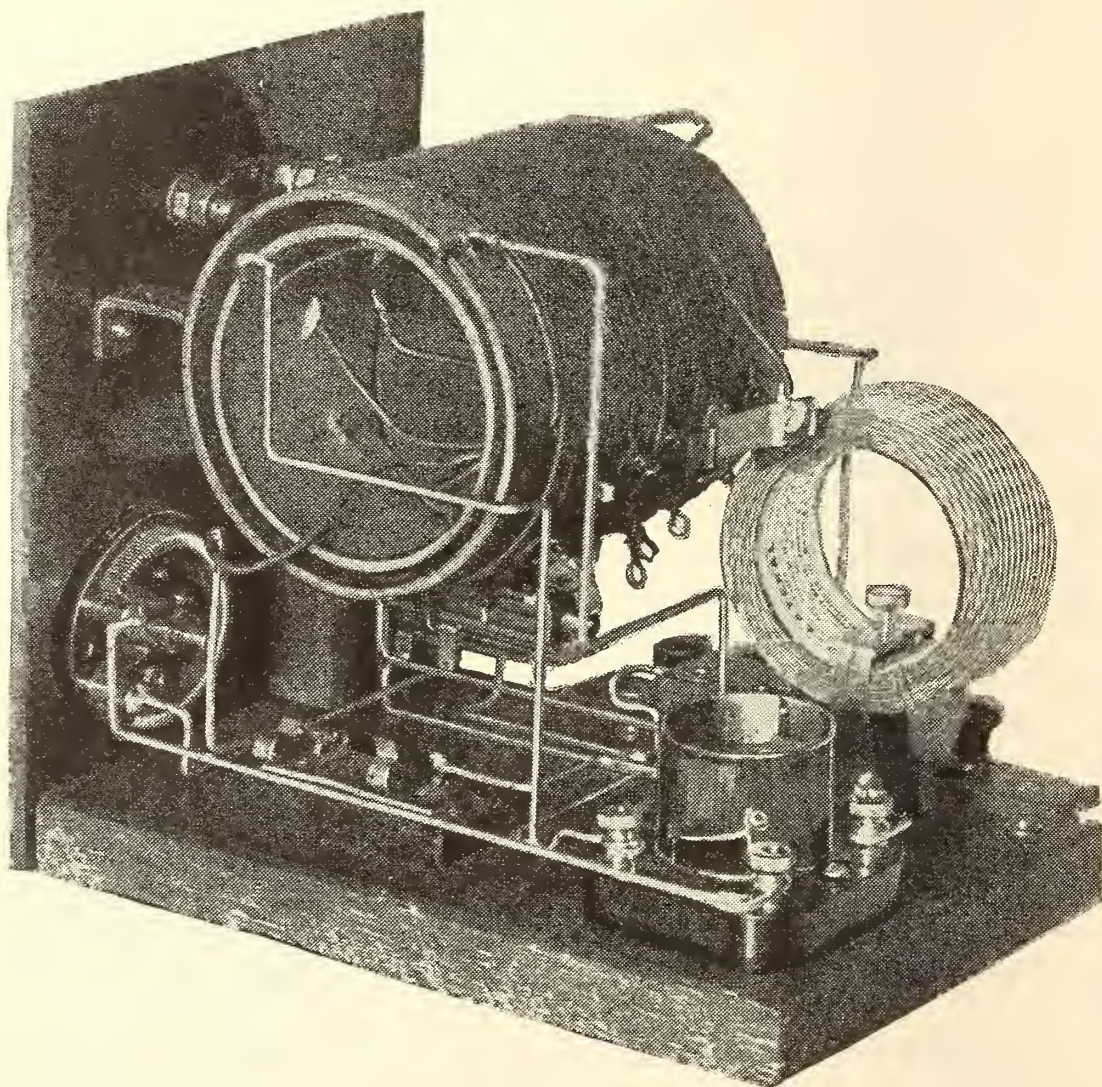

FIG. 6

Another rear view. Most of the wiring is completed before the inductances are mounted

at the upper end of the coil, and the grid tap at number 16 or 18. The antenna connection should be kept at about tap 6 or 8. If your antenna is more than 75 feet long, an antenna series condenser should be employed, and connected between the meter and the change-over switch. Size .0005 mfd. will be about right. During tuning, the wavelength can be checked continually on the receiving set.

The antenna current with this transmitter, using from 90 to 150 volts on the plate, will vary with the tubes and aerial systems. In some cases it may be in the neighborhood of only 20 milliamperes, while in others it may rise to  $\frac{1}{10}$  of an ampere. When the antenna current is very low (which does *not* necessarily mean that you are radiating very little power), the antenna meter, with its slight movement, will be an indication only that the set is working, and will be of little assistance in tuning. In this case, adjustments must be made at the

transmitter while listening for the most powerful beat in the receivers.

It is thus evident that the "radiation" meter is not altogether a necessity, and may be dispensed with by the experimenter if he desires. It is, however, very useful, and adds to the appearance of the transmitter.

RANGE

THE distance which this set will transmit depends on so many things, antenna, ground, location, tube, voltage, etc., that only a most general statement can be made. The author knows of similar sets which have freaked actual long distance transmission in excess of three hundred miles. The writer has personally found the set here photographed and described superior, in several instances, to a  $\frac{1}{4}$  kilowatt spark transmitter. The average experimenter should experience no difficulty in working stations five miles away in daylight.

Supplemental List of Broadcasting Stations in the United States

LICENSED FROM JANUARY 19 TO FEBRUARY 15 INCLUSIVE

CALL SIGNAL	STATION	FREQUENCY (Kilocycles)	WAVE-LENGTH	POWER WATTS
KDZE	Seattle, Wash.	1110	270	100
KFJQ	Grand Forks, N. D.	1070	280	5
KFNC	Corsicana, Texas	1280	234	20
KFNF	Shenandoah, Iowa	1130	266	500
KFNH	Springfield, Mo.	1270	236	20
KFNJ	Warrensburg, Mo.	1280	234	50
KFNL	Paso Robles, Calif.	1250	240	10
KFNV	Santa Rosa, Calif.	1280	234	5
KFNX	Peabody, Kansas	1250	240	10
KFNY	Helena, Montana	1150	261	5
KGO	Oakland, Calif.	960	312	1000
WBBJ	W. Palm Beach, Fla.	1160	258	50
WBBK	Pittsburgh, Pa.	1180	254	10
WBBM	Lincoln, Ill.	1330	226	200
WBBN	Wilmington, N. C.	1090	275	10
WBBC	Rogers, Michigan	1200	250	500
WBBP	Petoskey, Mich.	1220	246	10
WBBQ	Pawtucket, R. I.	1190	252	50
WBBR	Rossville, New York	1230	244	500
WBBT	Philadelphia, Pa.	1280	234	5
WBBU	Monmouth, Ill.	1340	224	10
WBBV	Johnstown, Pa.	1210	248	5
WDM	Washington, D. C.	1280	234	50
WMAW	Wahpeton, N. D.	1180	254	50

LIST OF BROADCASTING STATIONS DELETED JANUARY 1 TO JANUARY 31

CALL	STATION	CALL	STATION
KFAV	Venice, Calif.	WABC	Anderson, Ind.
KFCD	Salem, Ore.	WABJ	South Bend, Ind.
KFCK	Colorado Springs, Col.	WBAW	Marietta, Ohio
KFDU	Lincoln, Neb.	WDAX	Centerville, Iowa
KFIB	St. Louis, Mo.	WGAY	Madison, Wis.
KFIK	Gladbrook, Iowa	WJAB	Lincoln, Neb.
KFIY	Seattle, Wash.	WKAW	Beloit, Wis.
KFJD	Greeley, Colorado	WLAN	Houlton, Maine
KFKH	Lakeside, Colorado	WLAT	Burlington, Iowa
WAAZ	Emporia, Kansas	WOAJ	Parsons, Kansas

# How to Go About Buying a Set

Where to Go—How Much to Go With—What to Ask for When You Get There—and What to Do With the Unfamiliar Thing When You Get It

By WILLIAM H. CARY, Jr.

**L**ONG before the saying, "Well begun is half done" was translated from the original (whatever that was) into the English language, people must have appreciated pretty thoroughly

that "ill begun is underdone" — i. e., half-baked. And nowhere is this fact more evident to-day than in the gentle art (with a small "a" for a change) of broadcast receiving. Self appointed Radio Experts, cheap parts which refuse to "percolate," loud speakers operated at maximum volume (and maximum distortion), columns of text about "new" circuits ground out because the public expects a new circuit every week or so—

these are the sad results of poor beginnings, of the construction without instruction which has done so much to make the word "radio" connote "nuisance," in many quarters.

But, since "it is not in our stars, but in ourselves, that we are thus or thus," and since thousands of people every evening are deriving a real pleasure from their radio sets, those who lack experience in radio may in a measure make up for their lack by entering the game armed with the few plain facts.

For the sake of argument (and, paradoxically, hoping to avoid it), all people may be divided into four general groups:

1. Those who know *nothing* and care *nothing* about radio,
2. Those who know *nothing* and care *something* about radio,
3. Those who know *something* and care *something* about radio,
4. Those who know *something* and care *nothing* about radio.

The first group is by no means hopeless: many will be stimulated to active interest; but probably few of them will chance to read these words. The second group, those who know nothing about radio but are interested, is a very

large one. Perhaps you are in it. If so, it is for you that this is written. The group includes those who will grasp the principles quickly when once introduced to broadcast receiving, as well as those who—being busy, clumsy, very old, or very young (not so often this, however!) need repeated simple instructions. The third class—those already in the game—need not be content with the simple fare of this

article: other wholesome food is provided for them elsewhere in the magazine.

As for the last group—those who have gone through the mill and come out radio-electrically dead—their present apathy or haughty indifference toward radio may be due to the fact that they owned sets which didn't work, or which brought in programs of a kind or quality which did not suit them, or they heard a rush of noises, reminiscent of music, at a friend's house or at a radio store. This, of course, is too bad. So much might be said—and repeatedly is—on both sides!

SUPPOSE YOU ARE A NEWCOMER

**L**ET us suppose, that although you are a rank newcomer to the listening-in game, you are ready and willing to give it a fair trial. Let us suppose, also, that you are *buying* a set, not making it.

First of all, it is well to establish the *price range* you are willing to consider *for the set and*

## For Those About to Plunge

Hereby hangs a tale, a tale for the would-be, will-be, broadcast listener, who naturally enough at first, does not know what he needs in the way of receiving apparatus, nor how and where to acquire it, nor what he ought to pay. This article is an explanation of the fundamentals that should be understood by any one who is thinking of getting "a radio." Otherwise stated: if you know, in a general way, what you're "out for," this article will help you to know what you're "in for."

Next month, in an article: "Home Remedies for Indisposed Receivers," Mr. Cary will tell what to do with the ready-made set when it won't work.—THE EDITOR

*all accessories.* Comparatively few receiving sets are sold to-day complete. The "set" sold over the counter is a box full of tuning apparatus, sockets for the vacuum tubes, and a certain amount of other parts and wiring. Batteries, tubes, or head-phones do not come with it. To many, this state of affairs may seem like buying a phonograph spring in its case, for a certain price, then shopping around to pick up the crank, the record disk, and the horn, at added trouble and expense. The condition is evidently handed down from the days—not so long ago—when most of the people interested in amateur radio were electrical experimenters first and listeners second. In another year, we shall probably see many more receiving sets sold complete, so that you can pay one price, take the stuff home, and find everything present or accounted for.



"WELL, HOW MUCH DOES A GOOD RADIO COST?"

"HOW MUCH DOES A GOOD RADIO COST?"

HOW much does a good radio cost?"  
 O, question how often asked and how utterly unanswerable! Unanswerable, that is, until you have determined the *distance range* of the required set, and the *volume of sound* that it will be expected to produce.

Although it is a bit difficult to submit very definite prices, the table below is drawn up to give you a general idea of the cost of broadcast receivers and their effectiveness.

This is all very approximate, and does not take into consideration the *de luxe* sets, which are distinguished either by many stages of amplification, or by luxurious cabinet work, or both.

If you can make a visit to the receiving sets of several of your acquaintances, and see what results they give and at what outlay, it will be well worth your while. There is perhaps no better course of procedure for the uninitiated than to hear a satisfactory set at a friend's house, get one like it, and have the friend help install it—or more important still, have him go over its installation and adjustment with you after it is "hooked up."

THE CRYSTAL SET

IF YOU are within 15 or 20 miles of a broadcasting station, and do not insist on getting stations farther away than that, a crystal receiver may fill your needs. It requires no batteries, so that the up-keep is practically nothing. You will need the following apparatus:

<i>Type of Set</i>	<i>Mileage Range</i>	<i>Volume Sufficient for</i>	<i>Price (including everything needed)</i>
Crystal	up to 20	headphones only	\$10 to \$25
One-tube	up to 750	headphones only	50 to 125
Two-tube	up to 1000	loud speaker on local stations	75 to 175
Three-tube and all other sets	up to 1500	loud speaker on all but very distant stations	100 to 500

Crystal receiving set  
 Head-phones  
 50 to 125 feet of bare copper wire (solid or stranded) any size from about No. 14 to No. 22.  
 2 small antenna insulators (hard rubber or porcelain or glass).  
 Some insulated wire (No. 14 is good) to connect "ground" terminal on set with radiator or water-pipe.  
 Ground clamp, for fastening ground wire to radiator or water-pipe.  
 "Lightning arrester" or safety device (at any radio store).

In case you are very near a broadcasting station—so near that the signals from it are clear and loud—you might as well replace your adjustable crystal with a permanent one. Several kinds are on the market. They may cut down the volume a little, but are a source of great satisfaction in that they do away with the bother of keeping the crystal in adjustment.

As for the tools needed to install the crystal set, or practically any other type of set, only three are needed: jack-knife—screw-driver—pliers.

#### THE SINGLE-TUBE RECEIVER

**WARNING!** Please keep off the single-circuit grass! These single-circuit regenerative sets (and lo, there are many in the land,) when operated act as little transmitting stations, sending out radio waves of their own which cause squeals in the phones or loud speakers of your neighbors. "Reflex," "neutrodyne," "three-circuit," and other types of sets are available which do not cause this interference.

For a single-tube receiver, you will need the following materials:

Receiving set (generally with both tuning and detecting apparatus mounted in the same cabinet).  
 A-battery. (For WD-11 or WD-12 tube) A single 1½-volt dry cell.  
 (For UV-199 tube). Two dry cells, 1½-volt.  
 (For UV-200 or C-300 tube). A six-volt storage battery  
 B-battery. One 22½-volt dry battery (on sale at stores handling radio supplies).

Headphones and phone-plug (for connecting phones in the receiving circuit).

1 vacuum tube (see under A-battery).

Antenna wire, insulators, lightning arrester, ground wire, and ground clamp as listed under requirements for the crystal set.

#### THE RECEIVER USING TWO OR MORE TUBES

**I**F YOU want more volume than the single-tube set will give you—and especially if you wish to use a loud speaker instead of phones, you should go shopping with the following list:

Receiving set and amplifying unit (generally included in the same cabinet with the tuning and detecting apparatus) A-battery. (For WD-11 or WD-12 tubes). A 1½-volt dry cell for each tube used (this is only approximately correct. See article, "Dry Cells and WD-11 Tubes," in RADIO BROADCAST for July, 1923).

(For UV-199 tubes). Two or three 1½-volt dry cells for 2 tubes. Three 1½-volt dry cells for 3 or more tubes (the idea is to supply 3 volts to each of the tube filaments. Two cells connected in series will do this, or 3 in series when sufficient resistance (rheostat) is in the circuit).

(For UV-200, UV-201-A, C-300, or C-301-A tubes). A 6-volt, No. 80-to 120-ampere-hour storage battery.

B-battery. 2 to 5 22½-volt dry batteries (Three are generally sufficient for 2- and 3-tube sets).

Headphones and phone-plug. (If two or more pairs of phones are to be used, one of several makes of multiplugs or phone blocks should be purchased.)

Vacuum tubes. (See under A-battery.)

Antenna wire, insulators, lightning arrester, ground wire, and ground clamp as listed under requirements for crystal set.

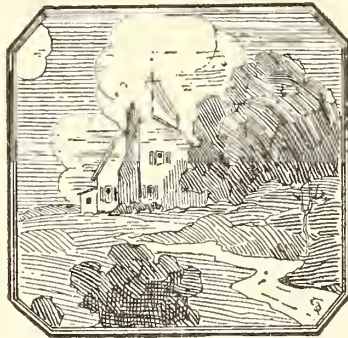

In all fairness, it must be said at this point that these parts and accessories "certainly do add up." Suppose, for example, you see a 3-tube set advertised in a store window for \$70. "Fine!" you exclaim, "\$70 is about what I'm willing

to pay to receive all this broadcasting that's going on nowadays." And you go in and look at the set and handle the knobs and peek inside and tell the salesman to wrap it up. He gives you the package and \$30 change from your hundred-spot, but—you have not bought a phonograph, which needs only a few needles and records to make it immediately useful. Let us determine, approximately, what your total initial expense for this \$70, 3-tube receiver will be (using dry cells for your A battery, not a storage battery.) Of course these prices will not hold everywhere, but you want to know what comes with your \$70 cabinet.

The set	\$ 70.00
A-battery (3 dry cells)	1.50
B-battery (3 22½-volt batteries)	9.00
1 pair head phones	6.00
Loud speaker	20.00
Plug for head phones	.75
Plug for loud speaker	.75
3 UV-199's	15.00
3 adapters for UV-199's	2.25
Antenna wire	.75
Insulators	.20
Lightning arrester	2.00
Ground wire	.20
Ground clamp	.10
<b>Total</b>	<b>\$128.50</b>





“DON'T EXPECT TO HEAR HAWAII THE FIRST TIME YOU TOUCH THE DIALS”

#### WHAT TO DO WHEN YOU'VE BOUGHT THE RECEIVER

SOME of you will discover suitable apparatus at prices lower than those given above. Others may have to pay more: but the list shows that the cost does indeed, add up. It is well to know the worst. Rest assured that the writer's idea is not to spread disappointment over this intriguing sport called radio, but rather to forestall it.

Once you have acquired all the apparatus you need for your set, and have got your treasure safely home, you will very likely be keen to do the work of installation yourself. If you are lucky enough to receive printed directions with your outfit—many manufacturers supply them, but some still don't—you will do well to study them until you have thoroughly in mind what you are supposed to do. It isn't hard: the binding posts are generally marked, and so are the B battery terminals. The set may not produce music the first minute you get all the

connections made, but what of it? Few sets do. Not that there is anything wrong with them, but a bit of experience is needed to determine the best battery voltages, and the proper positions of the dials for good volume without distortion.

#### WHO SHOULD INSTALL THE SET

TIME will be saved, perhaps, if you have someone install your set who has done similar work before. A friend who is already “in the know,” or a man from a radio store, can do the job with neatness and dispatch. But do not call up your electrician and say you want him to install your set. That is, not if he is only a lighting man. Electricians have in many cases taken up radio successfully, but because a man is familiar with lighting installations, it does not follow that he would be any better than yourself in installing your radio set. In fact, he might be worse, because he'd be less willing to disclose his lack of knowledge.

# Why Radio Waves Travel—and How

## WHAT MAKES THE WHEELS GO 'ROUND: II

What Antenna Is Best for Receiving, What for Sending—Clear Explanation of More Radio Terms

By WALTER VAN B. ROBERTS, B.S., E.E., A.M.

This series is written distinctly for the enthusiast—the man of good intellect, but untrained along electrical lines—who would like to know all about the workings of his receiving set. Not that this brief discussion pretends to completeness; it is merely intended as a stepping stone to put the reader in a position where he can profitably read the more complete treatments of different branches of the subject.

Simple mathematics is used, but only after a qualitative discussion of the subject has been made.—W. VAN B. R.

This article is the second of a series on "What Makes the Wheels Go 'Round." The first appeared in the March, 1924, RADIO BROADCAST. You can start this series now, since every article is a complete unit.—THE EDITOR.

**W**HEN high frequency alternating current flows in an antenna, energy is radiated (cf No. 7, article I, RADIO BROADCAST, March) in the form of radio waves in the "ether." We shall continue the custom of speaking of radio waves in the ether regardless of whether there "really is" an ether or not. A wave motion is the state of affairs when any quantity at a given point in space varies periodically with the time and also at any given instant varies periodically in space. A series of water waves satisfies this definition. The height of the water is the quantity that varies. If we watch the water level on an upright stick it will be observed to go up and down as the waves pass. At a given point the height of the water varies periodically with the time. On the other hand if we take a photograph to get the condition of the water at a given instant we see a periodic variation of height along the direction in which the waves are moving, hence at the given instant the height varies periodically in space.

### 19. LIGHT, RADIO, AND X-RAYS

**I**N THE case of radio waves we have two quantities, the electric field strength and the magnetic field strength, both of them varying in the fashion described above. Radio waves are merely a special case of electro-mag-

netic waves. Electro-magnetic waves of wavelength (measured from "crest" to "crest") of a few meters up to thousands are classified as radio waves. Those of wavelengths in the neighborhood of one ten thousandth of an inch are heat waves, those of about 2.8 hundred thousandths of an inch are red light, those of about 1.6 hundred thousandths of an inch are violet light (all other colors coming in between these values) while the still shorter ones are the ultra violet and X-rays. All of these waves move through empty space, or air, with the same speed, that of light, or 300 million meters (186,000 miles) per second.

### 20. IS THERE AN ETHER?

**N**OW the electric field strength at a given point in space is merely a number that tells us the force that would act upon a unit charge of electricity (say one electron), placed at that point. And the magnetic field strength at a point is the force that would act upon a unit magnetic pole at that point. In fact the whole conception of these terms is due to the desire of the early physicists to invent some unseen mechanism that would explain the observed fact that forces are sometimes exerted upon bits of electricity for no apparent reason. And the ether is the imaginary substance that acts directly on electricity. Certain stresses and strains in this ether are identified with the

electric and the magnetic field strengths. In one sense then, if the ether itself is merely a convenient figment of the imagination, then waves in the ether are, equally, not “really” existent. But if radio waves are considered only as waves in the mere *numbers* that measure the real forces that would act upon real electrons, then the existence of these waves does not require any ether. Whatever view we take of the nature of what we call waves in the ether, they certainly produce a very real effect when they hit a good receiving set.

#### 21. THE EARTH AS A CONDUCTOR

IF THE earth were a perfectly conducting surface, the direction of the electric field in radio waves would be vertical, while the direction of the magnetic field would be horizontal, and perpendicular to the direction of motion of the waves. As a matter of fact the resistance of the earth's surface causes the electric field to tip forward somewhat, like a man starting to run. This same sort of thing can be seen in the waves on the sea shore. When they get to shallow water the friction against the bottom holds back the water from below and the upper part goes ahead, leaning forward until the wave “breaks.”

#### 22. ANTENNAS: OPEN AND CLOSED

MERELY for the purpose of convenience, we will divide antennas into two classes, closed or loop or coil antenna and open or condenser antenna. This is because it is slightly easier to explain the working of loop antennas in terms of magnetic waves, while the open antenna fits in better with the idea of waves of electric field strength. The working of either kind of antenna can be explained in terms of either the electric or the magnetic waves, for these two are merely two different aspects of the same thing: the radio waves. In the last analysis, radio waves can always be detected in two and only two ways: (1) an electric charge placed in their path will tend to oscillate up and down: to ride on the waves so to speak, and (2) a magnetic pole (if there is any such thing) would be affected the same way, only sideways. It can be shown that these two effects are not independent; either of them necessitates the other. If then the magnetic wave is an

inseparable companion of the electric wave and can't explain anything that the electric wave alone will not explain, the question may well be asked, why do we take the trouble to imagine it? The only answer is that on the whole it is easier to invent this wave and assign properties to it and then reason about it than it would be to reason everything out from the idea of electric force alone. Fig. 7 is a representation of the way we imagine the radio waves split up into the two components.

#### 23. LOOP ANTENNAS

THE working of a transformer is usually explained by saying that current flowing in the primary sets up an alternating magnetic field which in turn causes the current in the secondary. This is the simplest way to explain the operation of a loop antenna too, the only difference being that the alternating magnetic field that causes the current in the loop comes along in the form of waves. The number of volts induced in a loop by the passage of radio waves is  $\pi\sqrt{2}HfnA \times 10^{-8}$  where H is the amplitude of the magnetic wave, f is the frequency, n the number of turns on the loop and A its area. This is on the assumption that the plane of the loop is vertical and perpendicular to the direction of the magnetic field, that is, pointing toward the transmitting station. If rotated about a vertical axis a quarter of a turn, no voltage will be induced at all. This feature is the most important advantage of a loop, for two stations using exactly the same wavelength may still be separated (provided that they do not lie in the same direction) by simply turning the loop at right angles to the one that is to be cut out. The other may not

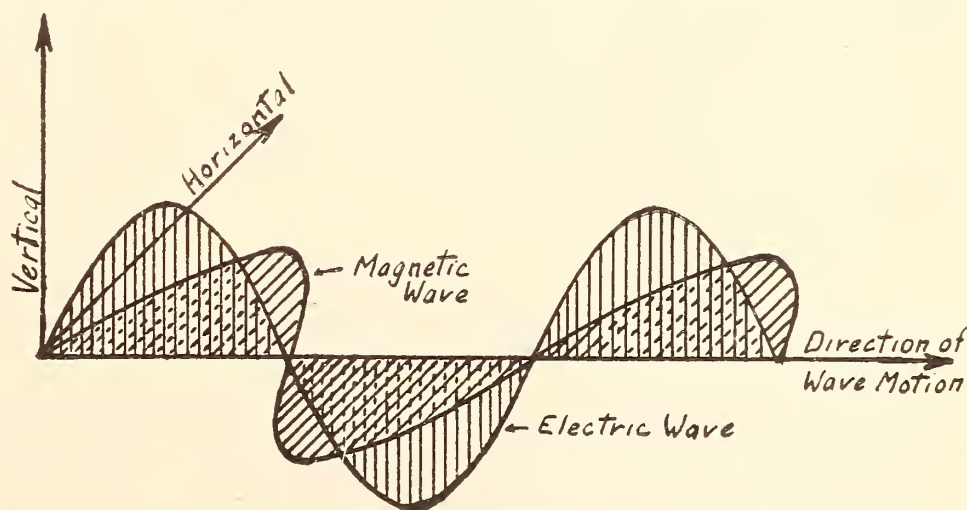

FIG. 7

How radio waves are theoretically imagined to split into magnetic and electric components

be heard as loudly then as if the loop were turned straight toward it, but it will be much louder than the interfering station.

#### 24. OPEN ANTENNAS

THE simplest case of an open antenna is a vertical wire. The waves of electric force hitting it cause the electricity in the wire to oscillate up and down. The voltage picked up by such an antenna would be proportional to the electric field strength and to the height of the wire. But as mentioned before, the electric waves are likely to come in with a considerable tip forward. Hence signals will be better received from a particular direction if we tip the wire away from that direction. This is approximately realized by making the antenna in the shape of an "inverted L." That is, a vertical section with a horizontal extension at the top. This will receive best stations lying farthest from the horizontal part.

#### 25. GROUND CONNECTION

IT IS usually desirable to couple the receiving set to the part of the antenna that has the most current in it. If a simple vertical wire, this would be the middle. Or, if an inverted L is used, a similar section may be connected as shown in Fig. 8 so that the vertical part all has comparatively large current in it and the receiving set can be located at the bottom. The section below the receiving set is called a counterpoise and is rarely used for receiving as it may be replaced by a connection to ground. The ground connection like the counterpoise, "gives the electricity some place to go" after passing through the receiving set and thus makes possible a good flow of current through the set. When a ground is used it is worth the trouble to make it a good one. The simplest is a connection to a water pipe by solder or a screw clamp squeezing a bright wire against a well scraped section of pipe.

#### 26. LOOPS VS. OUTDOOR ANTENNAS

HIGH outdoor open antennas are used at transmitting stations to get large amounts of power into the ether. At the receiving end, loops are coming into greater and greater use as the transmitting stations get more powerful, and will probably ultimately be used almost exclusively on account of the small space required, ease of installation, portability, lack of necessity to safeguard against lightning, and

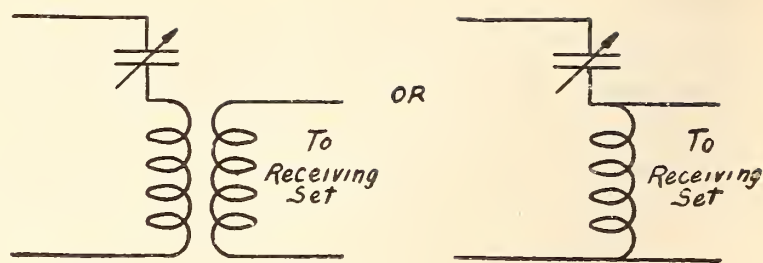

FIG. 8

The receiving set is coupled to the part of the antenna where the current is greatest

the improvement of the ratio of signal strength to interfering noises due to their pronounced directional quality.

#### 27. RADIATION RESISTANCE

AN ANTENNA can be defined as any circuit that will radiate energy in the form of radio waves when radio frequency current flows in it. Or, it is any circuit in which radio frequency current is caused by radio waves. Now if energy is radiated from a circuit, it has to be supplied by the mechanism that produces the alternating current in the circuit. Furthermore, the rate at which energy is radiated is proportional to the square of the alternating current, which is exactly the same law that governs the dissipation of energy in a resistance. In one case the energy goes out as radio waves, in the other case it changes into heat. From the point of view of the source of the alternating current there is no difference between the two. Hence it is natural to speak of the "radiation resistance" of an antenna, meaning the amount of ordinary or "ohmic" resistance that would absorb the power that actually goes out into the ether. It is obviously important to have as little "ohmic" resistance in an antenna as possible, for we are not interested in heating the antenna wires. The ratio of the radiation resistance to the total resistance (the radiation resistance plus the "ohmic" resistance) of an antenna is the efficiency, or the percentage of the total energy (supplied by the source of the current) that is radiated as ether waves.

#### 28. ANTENNA EFFICIENCY

EVEN if a receiving antenna had no resistance at all, the current produced in it by incoming radio waves would not be greater than a certain amount, for if it were greater than that amount the antenna would be radiating energy faster than it is receiving it. This is as impossible as it would be to have a mirror



"Products of Proven Merit"

# Amplification— undistorted

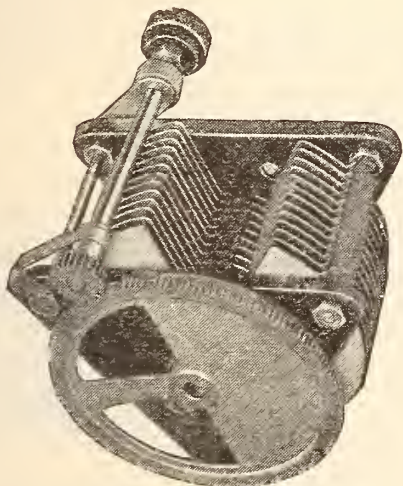

Type 247-H Condenser  
Price \$5.00

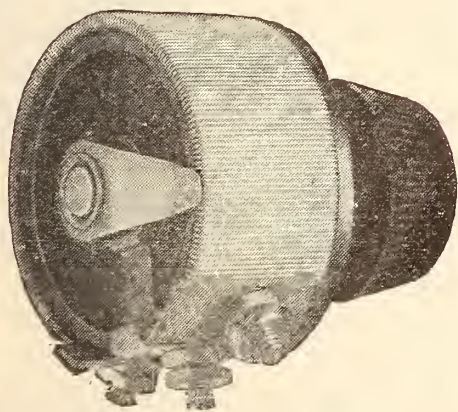

Type 301 Rheostat  
Price \$1.25

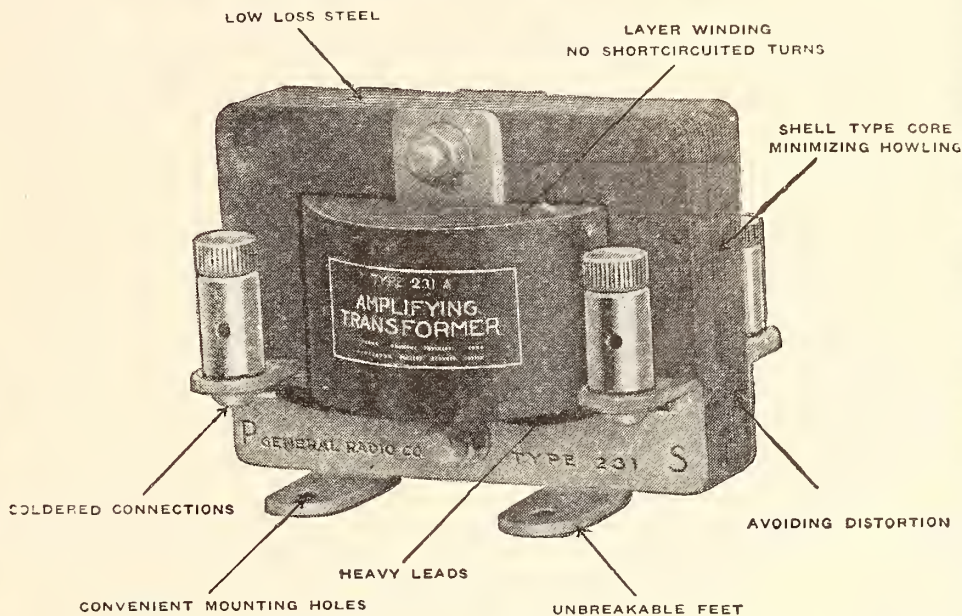

Type 231-A. Audio F. A. Transformer

The efficiency of a broadcast receiver is often destroyed by poor amplification—due to inferior transformers.

In buying transformers be sure to look well into the electrical and mechanical features, as well as appearance and price.

The features which have gained the GENERAL RADIO CO. Type 231-A Transformer its enviable position as a leader among Transformers are:

- Low loss steel* used in its core construction.
- Layer winding* prevents short circuiting of turns.
- Air gaps in core* avoid distortion.
- Unbreakable feet* with convenient mounting holes, make installation easier.
- Soldered connections* eliminate losses from poor contacts.

Not only has this Transformer a high amplification factor but the amplification is nearly uniform throughout the entire audio range, making it *best for all stages*.

**Turns Ratio 3.7 to 1. Impedance Ratio 10 to 1.**

**PRICE - - - - - \$5.00**

Carried in stock by all good radio dealers.

Write TO-DAY for Instructive Folder—"Quality Amplification" and Bulletin 917-B

## General Radio Co. ★

Manufacturers of Electrical and Radio Laboratory Apparatus

MASSACHUSETTS AVENUE AND WINDSOR STREET

CAMBRIDGE

MASSACHUSETTS

reflecting more light than falls upon it. This leads to the remarkable conclusion that in case of an antenna having no ohmic resistance the current produced may be independent of the size of the antenna. For although the voltage produced by the incoming waves may be greater in a large antenna, yet the radiation resistance is also enough greater to limit the current to the same value as that produced in a smaller antenna. Of course in actual practice we never can obtain an antenna with no ohmic resistance, for the wires must have *some* resistance even if very thick, and the receiving set connected to the antenna introduces resistance too. But this line of thought accounts for two observed facts that might seem puzzling. The first is that a good loop antenna tuned

with a condenser of low insulation losses will pick up signals much better than would be expected from comparing its size with that of a large outdoor antenna. The other fact is that a regenerative receiver will work almost as well on a short, low antenna as on a much larger one. In both cases the smaller antenna shows up well on account of having a high efficiency, or ratio of radiation resistance to total resistance.

To carry the thing to purely theoretical extremes, a single electron "tuned" by an imaginary spring to oscillate freely in space at the same frequency as the incoming waves, would absorb and re-radiate as much energy as comes in on a wave front comparable in size with the wavelength of the incoming waves.



## What Our Readers Write Us



### *A New Idea*

THE very novelty and originality of the "construction idea" in the letter below should inspire many a reader to go out and put up a new antenna himself.

Editor, RADIO BROADCAST,  
Doubleday, Page & Co.,  
Garden City, L. I.

DEAR SIR:

In putting up an antenna wire this week, it was necessary to attach one end to the branch of a tree, and it was almost impossible to climb this tree. The way we solved the problem might be of interest to somebody else.

I put a screw in a golf ball, and attached a string to the screw, then tied the other end of the string to my wire and took a mashie and drove the golf ball over the tree. Then, by hauling on the end of the string, the wire was drawn across the branch in the proper position—I think it took three strokes—no doubt one would be par.

CLYDE MARTIN  
High Point, N. C.

### *Radio and the Domestic Life*

NO ONE would be bromidic enough to say that radio has contributed much to the stability of the American home. That state-

ment is, however, true. Rightly used, it brings something to every member of the domestic democracy. But radio can be misused, and even before this interesting letter came in, listening-in on the domestic circuits, we had heard scattered reports of "radio divorces," and faint hints of "incompatibility of temperament"—apparently because of differing convictions about radio and how it should be used.

Editor, RADIO BROADCAST,  
Doubleday, Page & Co.,  
Garden City, L. I.

DEAR SIR:

No one denies the benefits of "radio culture". And since the craze for wireless has spread with even greater speed than an epidemic, and unlike an epidemic, been welcomed with joyful acclamation; high and low, rich and poor have hastened to the nearest carpenter, plumber, and electrician for the makin's.

The mysterious nomenclature of the science has invaded our speech so that we "stand-by," "sign off," "tune-in" or "fade out" without a qualm of a conscience hitherto devoted to pure English.

The most maddening, the most humiliating of all the jargon connected with the use of an active radio set is the warning "sh-ssh" of the interested operator. And so I rise to remark that we are slowly but



THE name Magnavox on a Radio Reproducer stands for the most careful workmanship, highest quality of material and also for a fundamental operating principle utterly distinct from that of ordinary "loud speakers."



The base of the new model Magnavox Reproducer R3, showing tone control

## *Important features now offered in Magnavox Radio—the Reproducer Supreme*

THE Magnavox electro-dynamic principle obviates the need of any mechanical adjustment to regulate the air-gap or change the position of moving parts. This famous principle of operation permits the use of an electrical tone control.

This control directly affects the character of the electrical circuit which creates the sound, controlling the sensitivity of the instrument and also its volume of reproduction.

Moreover, this electrical control produces a great saving of current

(already reduced in the new R3 and R2 to a maximum of .6 ampere) for, by its action, the current value can be reduced to a minimum of .1 ampere.

The new Magnavox electro-dynamic Radio Reproducers R3 and R2, in fact, are equipped with the first true sound controlling device ever designed. See them at your dealers and write us for catalog.

**THE MAGNAVOX COMPANY**  
OAKLAND, CALIF.

New York Office: 370 Seventh Ave.  
Perkins Electric Limited, Toronto,  
Montreal, Winnipeg, *Canadian Distributors*

surely becoming a nation of the speakers and the speechless. The art of conversation is doomed to desuetude, and our eager college boys will flock to courses in after dinner speaking and announcing, while their sisters assiduously devote themselves to bed-time stories in the hope of sometime broadcasting their melodious tones and attractive personality to the wide world.

There is not an hour in the twenty-four when the average receiving set can not reach out its electrical fingers and clutch a jazz orchestra, a pipe organ, Grand Opera, a talk on How to Cook Fish, or a bed-time story, out of the ether; to say nothing of the tremulo sopranos, soulful contraltos, and jovial basso profundos, wrestling with the "Rosary," "The Road to Mandalay," or "Pale Hands."

Now all of this outside entertainment insinuating its charms into the average family life around the evening lamp has a strong tendency to discourage family discussion, helping Betty with her home work, checking up the grocery account—all of which are necessary to maintain peace and balance in the family life and exchequer.

But when the head of the family is tuning-in and whistles are flying thick and fast, each signalling a station clamoring to be heard, a deathlike silence must prevail in the family circle. To break in on an announcement is a positive crime! And so the prattle of the children is hushed, necessary questions are answered in stealthy whispers, for if we all become too boisterous, father, with a muttered blessing, grabs the head-phones, shuts off the loud speaker and retires into his shell literally speaking. Then mother and the children, properly subdued and shown their place in the scheme of things, wait humbly until the station is successfully captured, when they are allowed to hear the results.

So, instead of discussing the League of Nations, Jim's need for a pair of shoes or a spanking, we all sit speechless while a symphony concert gives place to a market report, and that in turn, to an after-dinner speech from the annual banquet of the Laundrymen's Association—then, a jazz band, with its reiterated tom-tom—one scene from a play now running at the Regent, but not now appearing to arrive anywhere—truly a hodge-podge of information, amusement, and moral suasion. And all punctuated with whistles, groans, static, and fading.

One of the most important of radio developments is the radio widow. When the children are in bed, the local station finished with its program, father goes

fishing for those elusive long distance stations, which ought to be heard, but somehow, never are. Wife sits mum, consoling herself with a book, or solitaire, having at least the chill comfort of his physical presence, though his soul go marching on.

BESS B. HARRIS  
Belle Vernon, Penna

### *Two Good Announcers*

THE discussion about announcers and announcing is still going on. Every broadcast listener seems to have his favorite station and favorite announcer. The following letter contains some interesting observations.

Editor, RADIO BROADCAST,  
Doubleday, Page & Co.,  
Garden City, L. I.

DEAR SIR:

I have a radio log of about 130 stations, some as far distant as 2,500 miles away. The best two announcers I have heard are those at WSB and WOS. Some stations I have listened to played as many as five numbers without an announcement.

And very often when receiving from faint and far-distant stations, the station fades before the announcer gives the call letters, for so many give them so infrequently.

W. R. MOTTES,  
Coopersburg, Penna.

### *"Seeing" the Broadcaster*

Editor, RADIO BROADCAST,  
Doubleday, Page & Co.,  
Garden City, L. I.

DEAR SIR:

Here is a suggestion which may interest other broadcast listeners, of whom nearly every one subscribes to one or more radio publications (if he doesn't, he should). The writer has a scrap book with clippings and illustrations of the stations he has heard, which adds at least 50 per cent. to the enjoyment of the reception, as you are literally "seeing the broadcaster" and his station while you are enjoying his program.

CHARLES C. DRAKE,  
Detroit, Michigan.

*A complete revised list of Broadcasting stations in the United States will appear in the May number*



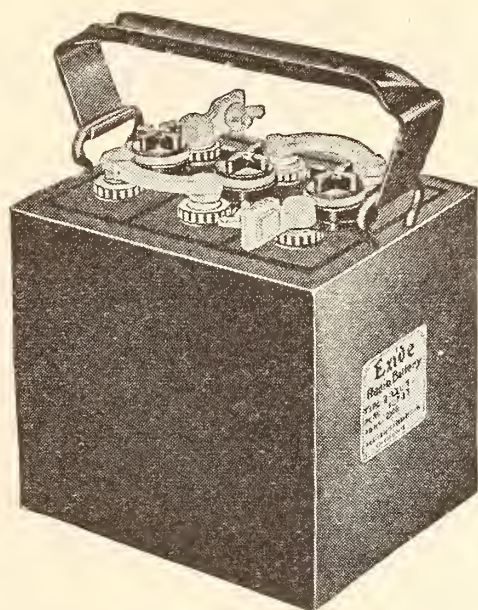

"A" Battery for  
six-volt tubes

## When is a battery cheap?

**A** BATTERY that allows your soloist to be accompanied by a noise like a thunderstorm is never a cheap battery; because it's certain that you will be dissatisfied and soon supplant it with a good battery.

Obviously, a battery that does not last long is not a cheap battery.

The battery that is really cheap is the one that gives perfect service and gives it a long time; one that does not have to be recharged too frequently—a silent, long-lasting battery, steady and dependable.

Because they give such good service and such long service, you will find Exide Radio Batteries cheap in the true sense of the word. They may cost you more than some to start with, but long life and freedom from repairs make the last cost low. And the added enjoyment you get from your set, through clarity and lack of needless bother, will be priceless.

In replacing a worn-out battery or when buying a new set, be good to yourself and get an Exide.

### Complete line of Exides for radio

There is a complete line of Exide Radio Batteries—batteries that give uniform filament current over a long period of discharge.

Apart from the 12-cell "B" battery there are three "A" batteries for whatever type tube you use. The Exide for 6-volt tubes

gives full-powered, ungrudging service. It has extra-heavy plates and requires only occasional recharging. It comes in four sizes, of 25, 50, 100 and 150 ampere hours capacity.

The Exides for low-voltage tubes are midgets in size but giants in power. The 2-volt battery weighs only five pounds, has a single cell, and will heat the filament of WD-11 or other quarter-ampere tube for approximately 96 hours. The 4-volt "A" battery has 2 cells and will light the filament of UV-199 tube for 200 hours.

### The dominant battery

On sea and on land the Exide plays an important role in the industrial life of the nation. In marine radio, Exide Batteries provide an indispensable store of emergency current. A majority of all government and commercial radio plants are equipped with Exides.

Exide Radio Batteries are sold by radio dealers and Exide Service Stations everywhere. Ask your dealer for booklets describing in detail the complete line of Exide Radio Batteries. Or write direct to us.

**Exide** ★  
**RADIO BATTERIES**

**THE ELECTRIC STORAGE BATTERY COMPANY, PHILADELPHIA**

In Canada, Exide Batteries of Canada, Limited, 133-157 Dufferin Street, Toronto

★ Tested and approved by RADIO BROADCAST ★

# The Grid

## QUESTIONS AND ANSWERS

The Grid is a Question and Answer Department maintained especially for the radio amateurs. Full answers will be given wherever possible. In answering questions, those of a like nature will be grouped together and answered by one article. Every effort will be made to keep the answers simple and direct, yet fully self-explanatory. Questions should be addressed to Editor, "The Grid," RADIO BROADCAST, Garden City, N. Y.

### ABOUT YOUR GRID LETTERS

Judging from the rapidly increasing demands made upon this section, it is performing a valuable service—but it is getting to be a very serious problem.

As a general rule replies to letters addressed to the GRID require the drawing of a diagram or two and a considerable amount of research. Similar service, if purchased elsewhere, would cost a very tidy sum. We are pleased to offer this service to our readers without charge but feel that it is up to our readers to cooperate with us to the extent of sending, with their requests for information, a self-addressed, stamped envelope. Unless our request is complied with the GRID will be unable to consider these inquiries.—THE EDITOR.

#### REGENERATION AND SQUEALING

*My receiver recently developed the unpleasant habit of howling as it went into and out of oscillation. And now, it howls even when a few degrees below the oscillating point. This makes it impossible to secure maximum regeneration on signals. Can you suggest a remedy?*

A. T. T., New Bedford, Mass.

THE trouble which our correspondent describes, becoming evident in a receiver which formerly functioned satisfactorily, and on which no changes have been made, is generally due to B battery deterioration—particularly of the cells between the negative terminal and the detector tap. The B battery detector voltage should be readjusted, or, if hopelessly gone, a new battery substituted. This latter course is, perhaps, the better one, for readjustments afford only a temporary relief, and reception, from then until the battery becomes altogether useless in a week or so, is likely to be marred by microphonic scratches and other annoyances.

A similar squealing often accompanies the changing of the circuit or tube. In most cases it can be remedied by readjusting the plate voltage as described, though sometimes it is necessary to vary the grid condenser and leak.

A tube should go into and out of oscillation quietly. There should be no squealing at the critical point, nor should there be a loud "plop" as the tube "spills over." Also, the tube should enter and come out of the oscillating state at practically the same reading on the regeneration control dial.

#### TUNING THE SINGLE CIRCUIT TUNER

*I have a single circuit tuner, and it has recently been called to my attention that this receiver is the cause of the whistling and squealing that mars the concerts every night. I have been*

*advised to dispose of this set, or make it over into the non-interfering variety for the good of radio. I understand perfectly that this is the right thing to do, but, at present, I am not in the financial position to invest in new apparatus, and I feel that there are many other fans desiring to do the right thing, who are in a position similar to mine.*

*Is it not possible to tune these single circuit receivers in such a manner that they will cause much less interference than they do at present?*

O. A. R., New York City

YES. Much can be done in the way of tuning reform to ameliorate the whistles and squeals that make enjoyable receiving impossible in congested radio districts.

This interference is caused by tuning when the receiver is oscillating. Tuning in this manner simplifies the finding of elusive stations, for the moment the wave of a broadcasting station is crossed the beat-note, or squeal, is heard. Then by a careful juggling of the controls around this whistle, the program of the station can be brought in. However, this system of tuning is a help, only in the angling for distant stations, and local stations can be tuned in more easily when the receiver is not oscillating. Moreover, as it is impossible to receive distant stations on a single circuit receiver, when the local broadcasters are transmitting, there is absolutely no reason for this interference from oscillating receivers, which constantly mars local programs. No operator who permits his single circuit receiver to oscillate during the transmission of local broadcasting gains anything in doing so, in fact he loses, and at the same time ruins the programs for hundreds of others.

In tuning for local stations, first set your regeneration control so that the set will not oscillate over the broadcasting wavelength range. It may be necessary to reduce the detector filament slightly to do this. Now tune for your station with the wavelength control. When you

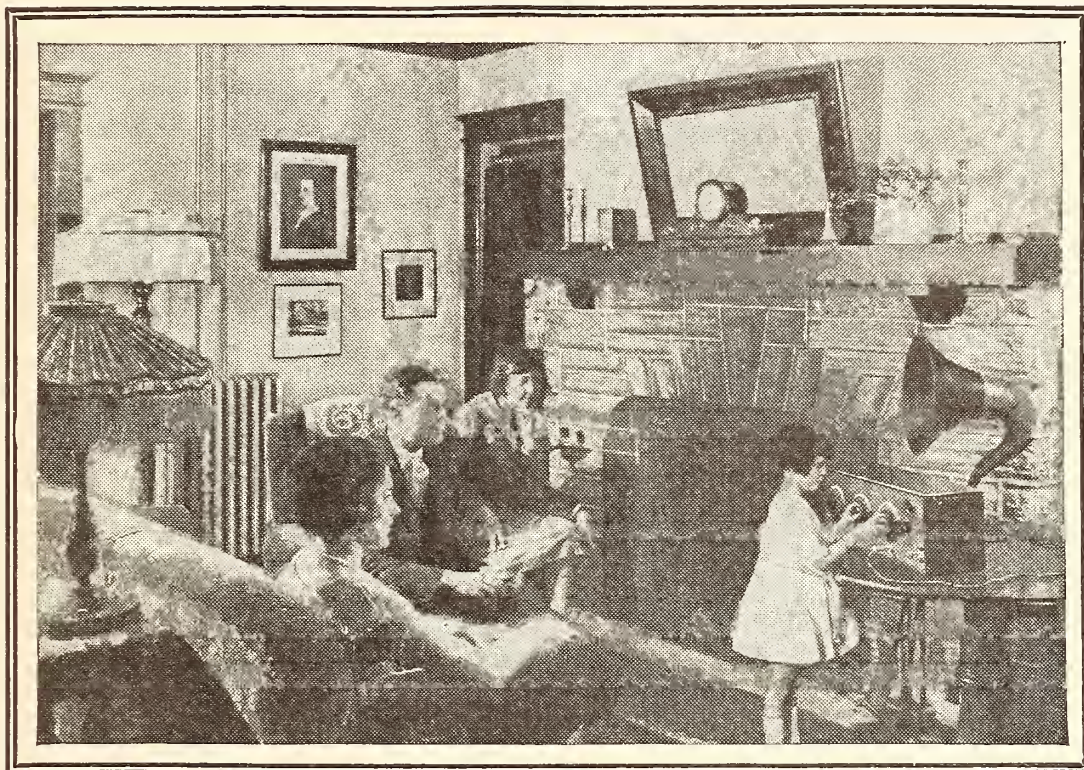

FADA "ONE SIXTY" NEUTRODYNE RADIO RECEIVER

## Simplicity

When a radio receiver is so simple that a little child can operate it as well as a grown person, then radio has reached a stage of development little short of perfection.

The Neutrodyne principle as applied to the FADA "One Sixty" has produced a radio receiver that is simplicity itself. Once the notations have been made of the dial settings of any stations, *anyone* can reset the dials in the given positions and listen to that station at will.

F. A. D. ANDREA, INC., 1581 Jerome Avenue, New York City

The FADA "One Sixty" four-tube Neutrodyne receiver is as selective, brings in distance and produces as great volume as any five-tube set. And, best of all, the FADA "One Sixty" can be depended upon to bring in most of the programs—local and far distant—on the loud speaker.

The pleasing design of the cabinet and its beautiful finish make it an ornament to any home. Price, exclusive of tubes, batteries and phones, \$120.

# FADA ★

## Radio

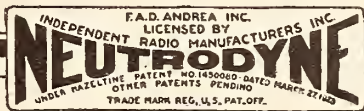

★ Tested and approved by RADIO BROADCAST ★

hear it, bring up regeneration slowly, varying the wavelength control slightly and at the same time to compensate for the detuning caused by regeneration. Bring regeneration up to just below the oscillating point. If it "spills over" little or no harm is done, for the chance is that the local oscillations, so perfectly is the set tuned at this point, will "lock" with the oscillations of the transmitting station, and a zero beat, or no sound, will be the result. Squealing, if any, will be but momentary.

If the air is to be cleared of this squealing, which has become a serious drawback to radio, every owner of a regenerative receiver must cooperate. It does no good to complain of the other fellow. If, for the time being, you must use a single circuit or any type of oscillating receiver, tune it as directed above, and then, as soon as circumstances permit, change to a non-oscillating set.

#### USE GRID BIAS ONLY WHEN NECESSARY

*After reading the very interesting article by Mr. Rider in the February RADIO BROADCAST, I built a bias battery into my two stage amplifier as he directed. Amplification had always been quite satisfactory, but, from reading his article, I hoped that the C battery would improve it. The results, however, have been just the opposite; the signals are now distorted. I have traced the connections, and everything is quite correct, the negative side of the battery running to the grid.*

*What is wrong?*

A. C. O., Albany, N. Y.

**T**HE difficulty in this case is that no C battery was needed. The grids were being operated at their most efficient potential in the original circuit, and, of course, any variation from this normal condition, on either the plus or minus side, would result in distortion.

A C-battery should never be used, except as a corrective measure—when there is something wrong with the amplifier, and then make sure that the difficulty is such that it may be remedied by a C battery. If your amplifier is working well, do not use a bias battery. The chances are that it will distort and weaken signals.

#### THE KNOCK-OUT REFLEX ON 200 METERS

*I built one of your Knock-out reflex sets, and must say that it is all that you claim for it. However, I experience difficulty in getting down to 200 meters. Can you explain this?*

A. B., Schenectady, N. Y.

**O**N ANTENNAS of the average size (under 120 feet), the experimenter should experience no difficulty in tuning down to 200 meters with the reflex set. However there is little to be gained by doing so, for 200 meters and the immediate neighborhood is the hunting ground of the amateur transmitting stations, which carry on 90 per cent. of their traffic and intercommunication on continuous waves. To receive this, an oscillating receiver is necessary, and the one tube reflex does not oscillate.

If it is desired to use this set for 200 meter reception, on other than phone and damped waves, some form of external oscillator should be employed. The experimenter might build up a small local oscillator such as that described in recent issues of RADIO BROADCAST for the super-heterodyne. This would use only the two oscillator coils (eliminating the pick-up coil), which should be placed near to the single tube reflex set.

Of course, any oscillating receiver, close to the reflex may be used for producing the local heterodyning oscillations; but this is rather inefficient, for probably better results would be secured using the oscillating receiver directly for reception.

#### THE SUPER AND THE SPECIAL TRANSFORMER

*In the articles on the super-heterodyne receiver which you have recently published by Messrs. Eltz and Haynes, I notice what appears to me to be two rather fundamental differences. I should like your advice concerning them.*

*Each writer, in addition to the standard transformers in the intermediate frequency amplifier, designates a special transformer which tunes considerably sharper than the conventional amplifying transformers, and which apparently acts as a filter.*

*Mr. Eltz uses this transformer in the last intermediate stage, while Mr. Haynes uses it in the first intermediate stage. Is there any difference?—and is one system better than the other?*

H. M., Detroit, Mich.

**T**HE two circuits to which our correspondent refers may be found, that by Mr. Eltz on page 72 of the November RADIO BROADCAST, and that by Mr. Haynes, on page 212 of the January RADIO BROADCAST.

As H. M. suggests, these special transformers are often designated as "filter transformers." They are so designed that they tune very sharply, excluding all but a very narrow band of desired frequencies. If placed in the final stage of intermediate frequency amplification, it is supposed to prevent all amplified impulses, excepting the tuned signal, from going through to the detector. In the first stage it permits only the tuned signal to pass on to the amplifier. This latter system, advocated by Mr. Haynes, is the most desirable for the following considerations.

In the first place, there is no sense in amplifying strays or side frequencies that are not going to be detected or used. It is, theoretically, a useless expenditure of energy. In the second place, if these strays are permitted to pass through the amplifier, by the time they reach the filter, or special transformer, they will be so amplified that some of them will force their way through and be detected.

#### CONDENSER PLATES AND CAPACITIES

*Some circuits describe condensers by the number of plates, while others designate the capacity in microfarads. It is often difficult for the novice to reconcile these specifications, particularly when it is desired to compare circuits.*

*Will you please tell me the relation of the number of plates to the capacity of the condenser?*

J. A. B., Chicago.

**T**HE only correct way of specifying the size condenser to be used in a circuit is by the capacity in microfarads. It is the specific capacity that is desired, and this varies, in the number of plates, for different makes of condensers. Naming the number of plates is only approximate. Very often an inexperienced experimenter will refuse a 23-plate condenser because the builder of a set specified 21 plates, when the capacity in each case was the same, .0005 mfd.

Condensers (variable) are built up in the following popular and standard capacities: .00025 mfd., .0005 mfd., .001 mfd., and .0015 mfd. Condensers with these maximum capacities have, approximately, the following number of plates (in the order given for the above capacities): 11 plates, 23 plates, 43 plates and 65 plates.

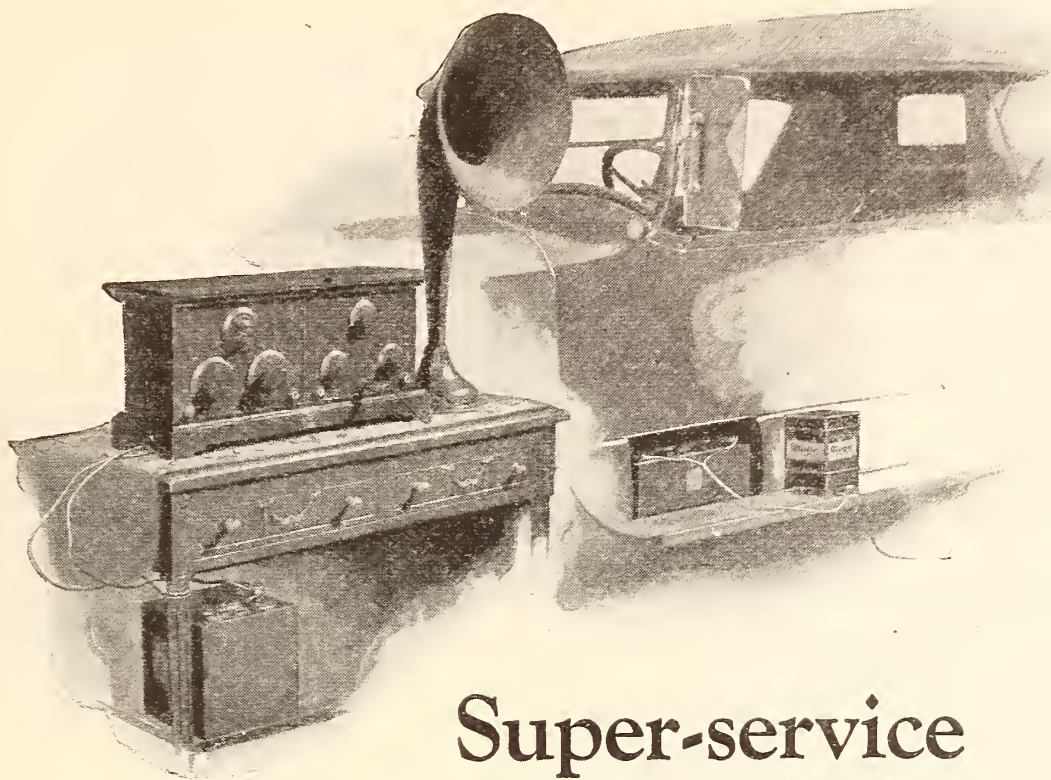

## Super-service

Wide-awake radio fans prepare for clear reception of all programs by keeping the storage battery full-powered with the Tungar. For super-service the Tungar is used to recharge both radio and auto batteries. The result is longer battery life and more "pep"—plus convenience.

In homes with electricity Tungar recharges the run-down radio or auto battery overnight at a saving. Sold by Electrical, Auto-accessory and Radio dealers.



**Tungar** is one of the many scientific achievements contributed by the G-E Research Laboratories toward the wonderful development of electricity in America.

*Tungar Battery Charger operates on Alternating Current. Prices, east of the Rockies (60 cycle Outfits)—2 ampere complete, \$18.00; 5 ampere complete, \$28.00. Special attachment for charging 12 or 24 cell "B" Storage Battery \$3.00. Special attachment for charging 2 or 4 volt "A" Storage Battery \$1.25. Both attachments fit either Tungar.*



# Tungar

REG. U.S. PAT. OFF.

## BATTERY CHARGER

*Tungar—a registered trade mark—is found only on the genuine. Look for it on the name plate.*

Merchandise Department  
General Electric Company  
Bridgeport, Connecticut

# GENERAL ELECTRIC

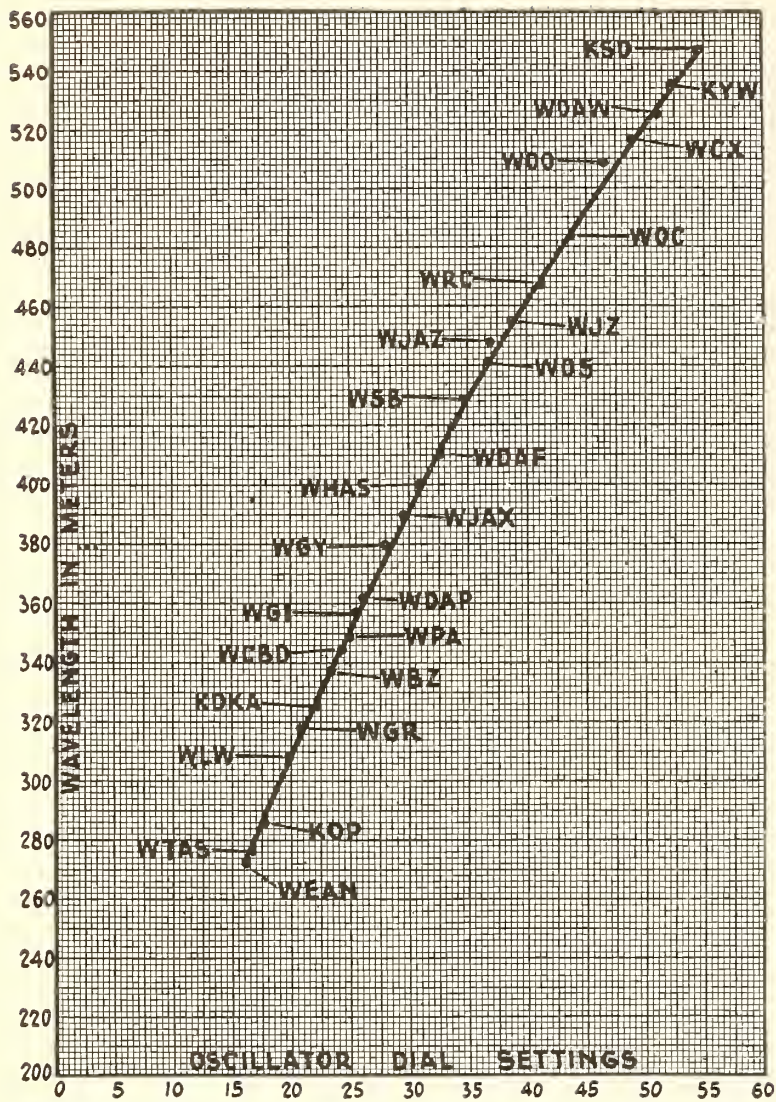

Oscillator Dial Settings for the Haynes Super-Heterodyne

OSCILLATOR DIAL SETTINGS ON THE HAYNES "SUPER"

Can you give me an idea of the approximate oscillator dial settings for various broadcasting stations for the Haynes super-heterodyne as described in January RADIO BROADCAST?  
N. T. M., Marietta, Ohio.

WE ARE glad to print a graph showing actual oscillator dial settings for 26 broadcasters whose wavelength settings are over the complete broadcast wavelength band.

This graph was omitted from Haynes' "Shooting Trouble in the Super" in the March RADIO BROADCAST.

SERIES PARALLEL CONNECTION FOR DRY CELLS

Will you please let me know if I can connect six dry cells in the manner which I have shown for use with the UV-199 tube, without blowing out my tubes? It seems to me that six batteries would give six times one and a half volts, or nine volts, which is twice too much for these tubes.

J. G. H., Hershey, Pa.

YES, the cells may be connected in the manner which you indicate, and no harm whatever will be done to the tubes. This connection is known as "series-parallel." Connecting a series of three cells in parallel with a series of three cells, halves the resistance of the complete

battery, making it possible to draw twice the current from it. And, inversely, dividing the current consumed between the two banks of three cells each, this arrangement makes the battery last about twice as long as three cells used alone.

The voltage is equal only to that of a single bank.

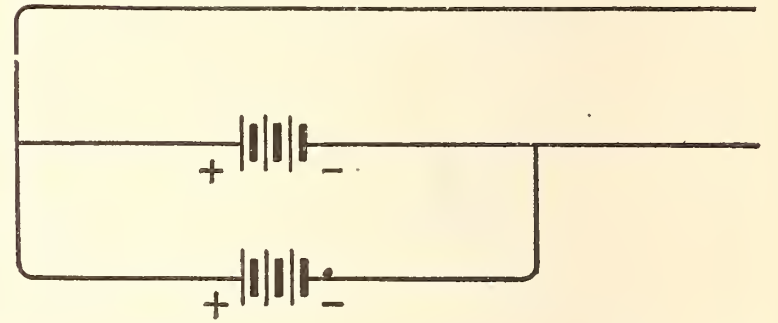
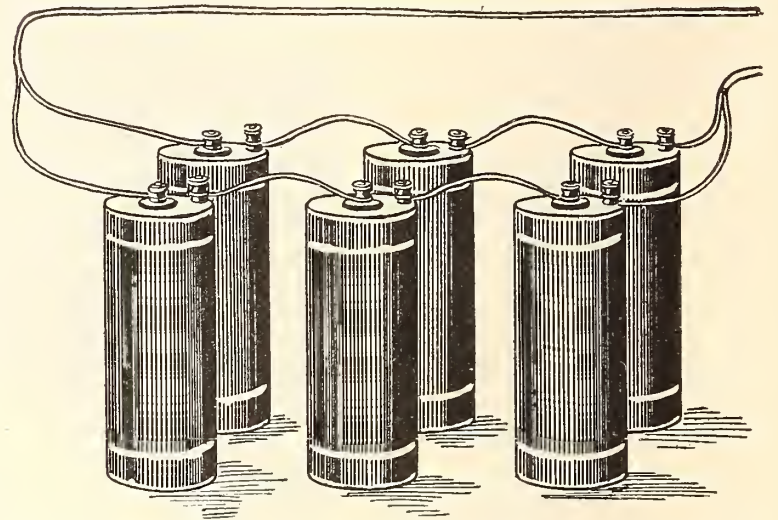

Dry cells connected in series parallel

MAKING REFLEX SETS SELECTIVE

The "knock-out" 3-tube set I built from the directions published in your February number is working marvels with a single exception. My station is within a short distance of WJAZ and I find it difficult to hear the New York stations when WJAZ is working—in other words, how may I improve my selectivity?

L. J. R., Chicago, Ill.

WHEN interference from a local station is experienced, it is usually advisable to purchase or build a wave trap. A very good one was described in RADIO BROADCAST for November, 1923.

Another simple and generally effective method of sharpening tuning is the use of a second aerial, commonly called a "counterpoise." A single wire between 50 and 100 feet in length and just high enough above ground to be out of the way and insulated in the same fashion as the regular aerial is used in place of the ordinary ground wire. The counterpoise may be run in any direction and at any angle with relation to the antenna. In apartment houses, the counterpoise may be strung around the picture moulding of one or two rooms. When a counterpoise is used, the ordinary ground connection is not connected to the receiver but the lead from the counterpoise is taken to the ground post and more volume may be had by using a wire about 150 feet long in the main antenna.

DX PRIZE CONTESTANTS

Must have their entry-reports in the mails by midnight, March 23 to qualify according to the terms of the contest, printed on page 420 of RADIO BROADCAST for March. No station may be logged more than once

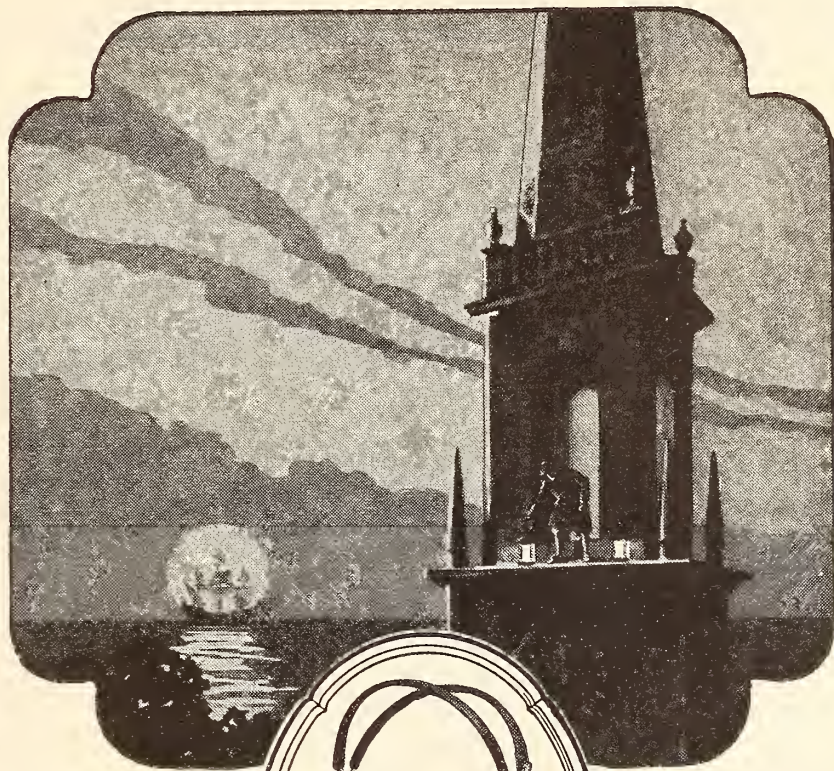

**PAUL**

ON the eighteenth of April in 1775 two lanterns were hung in the tower of the Old North Church in Boston signaling to Paul Revere in Charlestown the movement of the hostile troops. Thus began the famous ride which will always live in our history.

Paul Revere's broadcasting, although romantic and spectacular, seems crude to us to-day. The death of a president, an earthquake in far-off Japan, and many other instances



**REVERE**

which history may deem fully as important are now flashed almost instantaneously to millions of homes.

Only one key is necessary to gain access to this wonderland of Radio. The key is satisfactory receiving apparatus.

HOLTZER-CABOT Headphones and Loud Speakers enable your receiving set to give its utmost in sensitiveness, volume and quality.

The fullest enjoyment of Radio is yours if you own HOLTZER-CABOT equipment.

<b>Holtzer-Cabot Loud Speaker,</b>	<b>\$25.00</b>
<b>Loud Speaker Phonograph Attachment,</b>	<b>10.00</b>
<b>No. 2 Universal Headphones,</b>	<b>9.50</b>
<b>No. 4 National Headphones,</b>	<b>6.00</b>

*Write for booklets explaining how the exclusive features of these instruments enable you to enjoy the wonders of Radio*

**THE HOLTZER-CABOT ELECTRIC CO.**  
 125 Amory Street, **Boston, Mass.**  
 6161-65 South State Street, **Chicago, Ill.**  
 Dept. Ar



# Among Our Authors

**HUGO A. WEISS**, who is responsible for our cover this month, is the artist who originated "Dr. Mu" who "needs no introduction" to readers of radio advertising.

**ALFRED M. CADDELL** is a writer on radio whose name is not unfamiliar to readers of this magazine. He is pretty certain to be found wherever radio men gather in New York.

**WALTER VAN B. ROBERTS** is radio researching at the Palmer Physical Laboratories at Princeton University. His remarkable article this month on a "Knock-Out Two-Tube Receiver" is the result of his latest experiments.



A. F. VAN DYCK

noise forever." He is now a research engineer with the Radio Corporation and says, "I am married and have two children. See my family once in a while, thus upholding the traditions of those engaged in radio work. I expect to live to see radio a household necessity."

**EARL C. McCAIN** is a newspaper man in Pueblo, Colorado

and writes that nothing can compare with the sport of driving about the foothill ranches of Colorado. "I first camped in the woods when I was fourteen," says he.

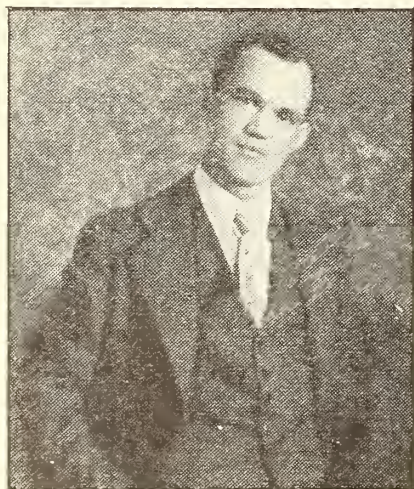

E. C. McCAIN

**J. H. MORECROFT**, whose editorial "March of Radio" is a monthly feature of this magazine, is Professor of Electrical Engineering at Columbia University. He has recently been honored by election to the Presidency of the Institute of Radio Engineers.

**JENNIE IRENE MIX** was the music critic of the *Pittsburgh Post* from 1904 to 1918 and since that time has been a freelance writer and has traveled extensively in this country covering important musical events. "I am greatly interested in the drama," writes Miss Mix, "—when it is good. I am not a club woman. I could never understand mathematics or politics."

**GEORGE J. ELTZ, JR.** is a native of New York City and one of the old radio guard. He had one of the first amateur radio sets in the city. He is now manager of the radio sales department for the Manhattan Electrical Supply Company.

**HOWARD S. PYLE** is one of the radio inspectors at the Detroit office of the Radio Service, Department of Commerce, and much of his time is spent trying to keep things running smoothly with broadcast stations, amateur operators, ship operators and land stations in the 8th District. He has been a ship and naval operator, manufacturer, and engineer.



W. H. CARY, JR.

**WILLIAM H. CARY, JR.** for many months helped guide the destinies of **RADIO BROADCAST** and is now traveling in England and on the continent. "Bill"

is full of quaint expressions and fairly radiates personality—which is entirely proper for a radio man. He has several more articles in his kit-bag which will appear in succeeding numbers.



# RADIO FREQUENCY AMPLIFICATION WITH Ballantine Variotransformers (Patents Pending)



Model 5 \$9.60

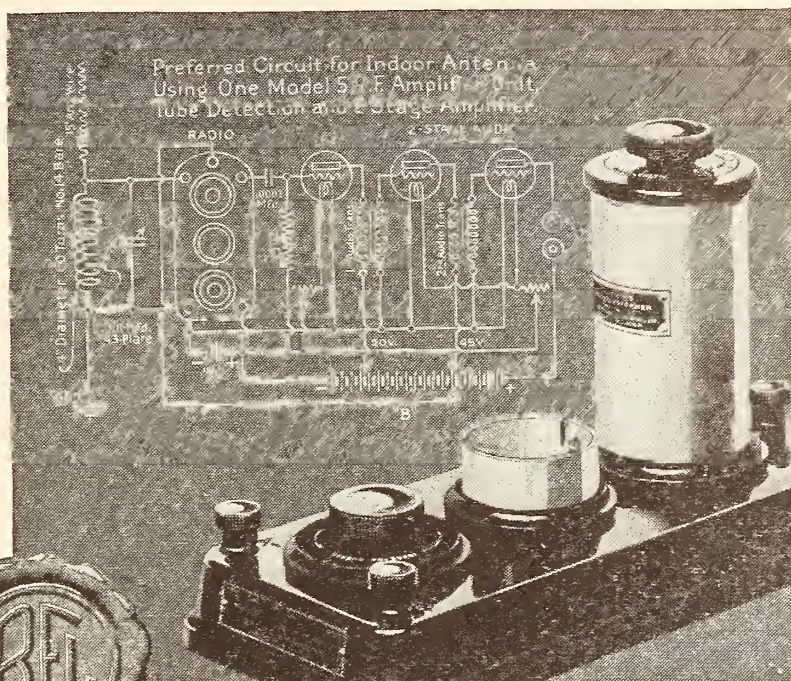

Complete Unit \$15.00

## “TURN THE KNOB”

1. Continuous variation in wave length.
2. Self-contained and shielded.
3. Control of regeneration and tuning by single knob: *no potentiometer.*
4. Fits your set — either base or panel mounting.
5. Improved tone quality.

“Radio Frequency Amplification with the Ballantine Variotransformers” — a 25-page booklet — mailed free on request.



**BOONTON RUBBER MFG. CO.**

*Pioneers in Bakelite Moulding*

324 FANNY ROAD

BOONTON, NEW JERSEY

# AMONG OUR AUTHORS

**WE** ARE glad to have another article this month by A. J. HAYNES. Readers will remember his articles, "A Simplified Super-Heterodyne" last month, and "How To Eliminate Interference with a Home-Made Wave-Trap" in the November, 1923, number.



**H**OWARD S. PYLE is Assistant Radio Inspector in the 8th District, with headquarters at Detroit. Mr. Pyle says that he "first gazed on the world in the late '90's, and soon afterward attempted to listen-in on other worlds, through the medium of an

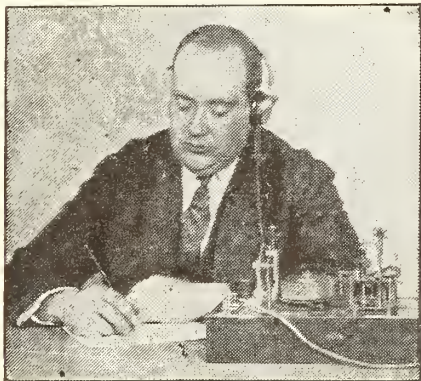

HOWARD S. PYLE  
Behind the official Omnigraph  
in Detroit

iron filings coherer. Been listening ever since." He says, further:

"Stirred up the ether around Northern New Jersey about 1911 with a conglomeration of rather weird spark apparatus. Tried it

on the West Coast a few years later, and finally became so infected with dots and dashes that I dropped everything, and treated the sea-going public to a self-imported young wireless operator in blue-and-gold."



**C**ARL DREHER qualified for his first grade commercial license nine years ago, in the days when radio music was broadcasted from spark coils. He is a graduate of the College of the City of New York, where he studied under Dr. Alfred N. Goldsmith. Until 1921, when he became receiving Engineer for the Radio Corporation, first at Chatham, Mass., and later, at Riverhead, L. I., he had done research work for the G. E. Company, the Marconi Company, and the Radio Corporation. He is now in charge of the RCA station, WJZ, at Aeolian Hall, New York.

**A** WORTHY ambition has JOHN F. RYDER. It is "to write a technical article without using a technical term." He also is an old-timer in the radio game. He tells us that he still possesses the crystal which was used in receiving the first regular radio program transmitted by Dr. Lee De Forest in 1916.



"ROBERT OLIVER"  
On a "Capital ship for an ocean trip." (Hi-lee, hi-lo!)



**R**O. JASPERSON, sometimes "Robert Oliver," had never wooed radio until a year ago. "Somewhere," he writes us, "I read that there were 20,000,000 sets in operation in the country. Mine refused to work. Perhaps it was better so. The more I failed, the more determined I was to build a set that would function. After three months, apparently without reason, I began to get everything on the map as far west as the Mississippi. I got the thrill of a lifetime, so I began to write about it."



PAUL MCGINNIS  
Not a radio store in sight

**P**AUL MCGINNIS is one of those who "used to give his pay check to a radio dealer every week, then stand outside and look in the window." He is at present Radio Editor of the New York *Evening Journal*.



**R**OBERT MARRIOTT is way out in Washington, and is a former president of the Institute of Radio Engineers. He is one of the wise old-young men of radio.

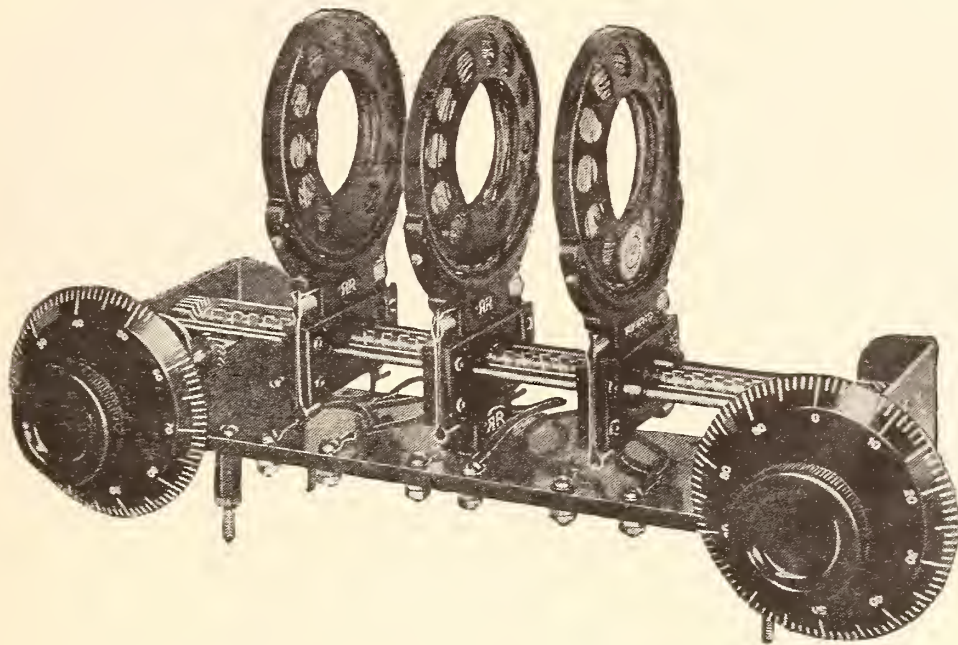

“Isn’t it great, fellows, that about every so often we drift into this out of the way eating place for lunch and hash over our radio experience? Here’s Gene! Say, old top, what’s new?”

“I have been fussing with a new radio frequency hookup, wound my own and set it up. It worked after a fashion, but the tone quality was poor and I did not seem to get the volume and distance I was accustomed to, so I communicated with Rieger and had them send me some of my old friends, Curkoids. Well, I took out the home made and put in their equipment. What a difference, such tone quality and volume and I could just feel that set reaching out into the distance.”

“Say, Dale! Get Silent Jim to open up; he is sitting over there with a sort of pleased, amused grin on his face.”

“Well, fellows, you don’t need to open me up with a crowbar to-day. I have been making up one of those radio frequency feed-back circuits. Talk about being fussy, well I spent four hours trying to get one of the inductances located where it would function. I tried other inductances and finally took a seventy-five Curkoid out of my pet, put it in a single mount and away she went. It didn’t make any difference to that little coil where it was or whether I was holding it or not. It just brought them in with a bang. So, I sort of settled down contented like and tuned away the rest of the evening. I traveled from Miami to Los Angeles and from Montreal to Porto Rico; kept on plugging in the loud speaker every little while and every night since then we pick the best from any part of the country.”

**CURKOIDS Prices**

Radio frequency coupler.....	\$2.75
Triple coupler.....	7.50
Dual coupler.....	4.50
20 K inductance.....	1.40
25 K “.....	1.50
35 K “.....	1.50
50 K “.....	1.60
75 K “.....	1.65
100 K “.....	1.70

(Made up to size 1,500 K)

**CURKOIDS**  
THE SUPREME INDUCTANCE

for Tuning Units and Radio Frequency coupling

**RIEGER RESEARCH CORPORATION**

100 Charles Street New York City

**Our New CURKOID Booklet**  
Send ten cents for the booklet which tells you how to make simple, single, two and three circuit receiving sets, regenerative and non-regenerative, super-regenerative and reflex circuits, including full construction data.

**UNITED**  
AMPLIFICATION

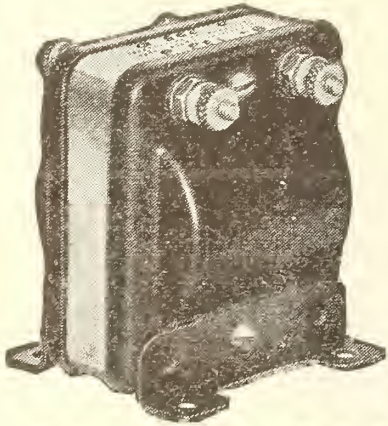

UNITED Audio Frequency Transformers: A-1, 5 to 1 and A-2, 3½ to 1—  
\$4.50 each

★  
**Fans favor the UNITED!**

So do radio engineers and manufacturers of nationally known radio instruments: General Radio Corporation, Michigan Radio Corp., Globe Electric, Joy-Kelsey, Walter Lytton, Inc., Wilson & Jaspert, Couch Mfg. Co., Harmony Mfg. Co., Donaldson Radio Co., Orator Radio Corp., Telmaco, United Dist. Co., and numerous others.

**You Take No Chance When You Buy "United"**

Unless "UNITED" Transformers, "UNITED" Variable Condensers and "UNITED" Units and Sockets satisfy you fully, your dealer is authorized to refund your money. Every "UNITED" carries a money-back guarantee.

**First by Test!**

Among the numerous tests which have conclusively demonstrated the excellence of "UNITED" Transformers is the one conducted by the University of California in which United Audio Transformers came out first!

The "UNITED" Radio Booklet is mailed FREE! Write us!  
Leading dealers sell and recommend "UNITED" Radio Apparatus. See your dealer first, please.

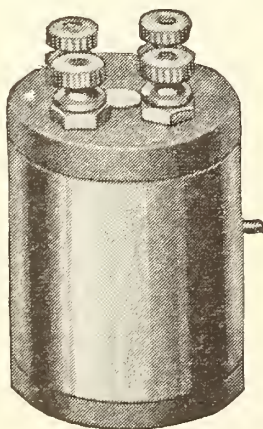

"UNITED" Radio Frequency Transformer: R-1,  
\$2.50

**United Mfg. & Dist. Co.**  
9702 Cottage Grove Ave. Chicago, Ill.  
New York Office: 145 W. 45th St., New York City  
San Francisco Office: 709 Mission St., San Francisco, Cal.



Get Better Results on DX  
Weston Filament Voltmeter

★  
It gives you the exact voltage required for best results, and at once. By maintaining a constant filament voltage, it will greatly prolong the life and usefulness of your tubes. Makes exact tuning quick and easy. Locates trouble instantly.

Write for booklet "J" describing the whole line of Weston radio instruments.

WESTON ELECTRICAL INSTRUMENT CO.  
179 Weston Avenue Newark, N. J.

**WESTON**

Electrical Indicating Instrument Authorities Since 1888

STANDARD—The World Over

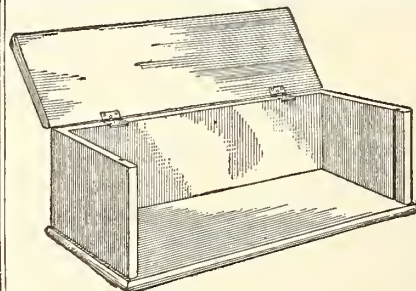

**A RADIO CABINET**  
For Your Home Built Set

Here is a cabinet made of clear Oregon Fir, knocked down, grooved for panel and with hinged lid, not painted that it may be stained to harmonize with any interior decoration.

7x7x16.... \$2.00 Each    7x7x26.... \$2.40 Each  
7x7x21.... 2.20 Each    7x7x28.... 2.50 Each

EXPRESS BODY CORPORATION  
CRYSTAL LAKE ILLINOIS

★ **CARTER**



**INDUCTANCE SWITCH**  
(1-15 Points)

Original design. Solder terminal and contact one piece. Numbered Knob dial. Pig tail connection. Positive contact. Only one hole to drill. Carter quality throughout.

**\$2.00**  
Send for catalogue



RADIO FREQUENCY AMPLIFICATION with the BALLANTINE VARIOTRANSFORMER

# Get distance that everyone can enjoy

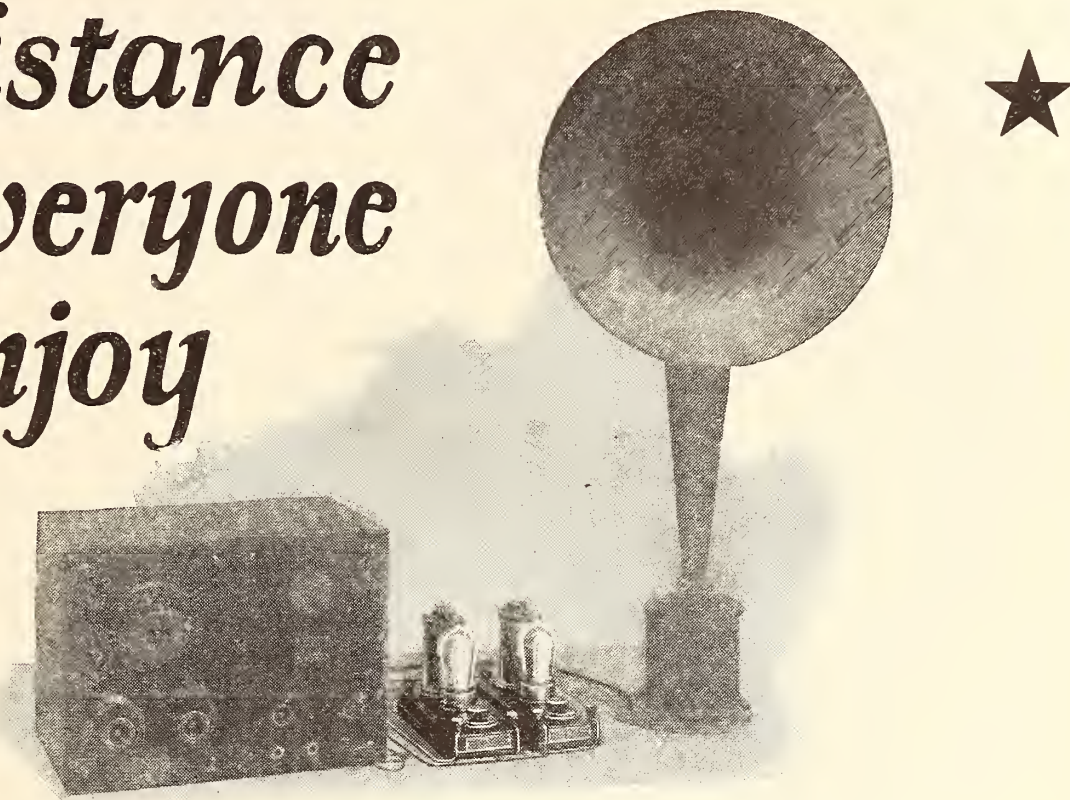

LET the whole family hear the announcer's "This is station ZYX, The Voice From 'Way off Yonder!" They can—by adding BALLANTINE Radio Frequency to your present outfit. Providing, of course, that you have a loud speaker. The voice or music will be clear and strong. And you'll find it easier to separate the various stations. Furthermore, squealing and distortions may be entirely eliminated.

### Any standard set

One or more BALLANTINE units may be hooked in between any standard receiver and its audio amplifier—as shown above. Easy changes in wiring adapt it to regenerative, non-regenera-

tive and even crystal sets. Besides, to reflex circuits the BALLANTINE brings the advantage of tuning each stage. Notable results have been obtained in the One-, Two-, and Three-Tube Reflexes as described in *Radio Broadcast*.

### All wavelengths

Pure tones at maximum volume for the number of tubes employed are assured by the *continuously variable* feature of the BALLANTINE transformer. For, by turning only one knob, this instrument tunes sharply throughout the range of 200 to 600 meters. Pigtail connections and full shieldings prevent stray noises. Theory and details of construction will be furnished to those interested in our 25-page booklet, *Radio Frequency Amplification*.

### A special service

Every user of BALLANTINE VARIOTRANSFORMERS is entitled to the experience and advice of the engineering staff of the Boonton Rubber Mfg. Co. Try the instrument first. Then, if there's anything you don't understand, write, giving full details of your complete outfit.

**BOONTON RUBBER MFG. CO.**  
*Pioneers in Bakelite Moulding*

224 Fanny Road, Boonton, N. J.

Complete radio frequency amplifier unit with socket and rheostat . . . \$15.00

Transformer only for panel or base . . . \$9.60

At dealers or postpaid

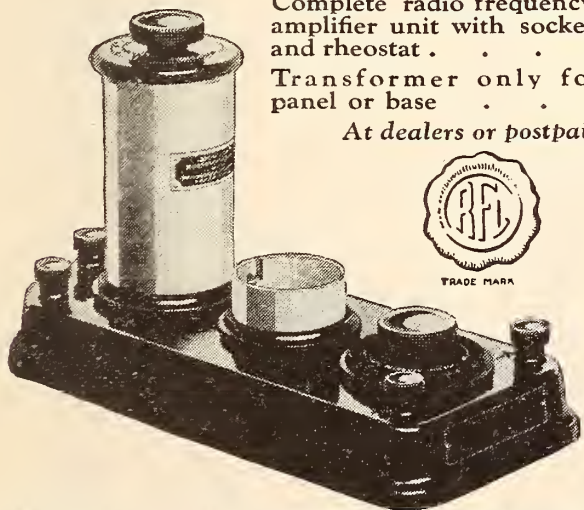

RADIO FREQUENCY AMPLIFICATION with the BALLANTINE VARIOTRANSFORMER

★ Tested and approved by RADIO BROADCAST ★



# SELECTIVITY and VOLUME

*Chelsea Parts Insure Both*

Insist upon a Chelsea condenser with pigtail connection to rotor. Bakelite insulation and die cast elements. Built in every size and capacity.

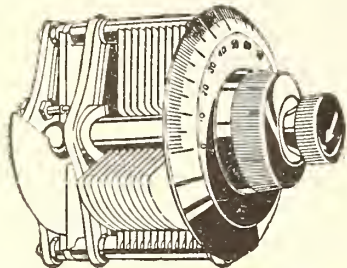

No. 10 with dial and vernier  
\$4.50

# Volume Without Distortion

Can best be secured by using Chelsea No. 50 amplifying transformers. Genuine bakelite insulation. Easy to assemble in your set. Ratio  $3\frac{3}{4}$  to 1. Absolutely guaranteed.

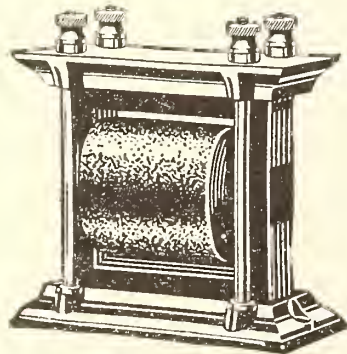

No. 50 Transformer  
\$4.50

Chelsea offers a complete line of sets and parts.

*At your dealers or write direct*

**CHELSEA RADIO COMPANY**  
151 Spruce St. Chelsea, Mass.

# World's Greatest BATTERY BARGAIN



Written 2 Year Guarantee  
Your Proof of Satisfaction

**FREE**

Hydrometer and "B" Battery

**SAVE 50%**

Thousands of RADIO BROADCAST Readers will profit by this amazing offer. They will buy the famous 2-year guaranteed, World battery at the lowest price ever quoted—They will get a hydrometer and a "B" Battery FREE. And they get the best battery built. It is "World" quality that makes possible our 2-year ironclad guarantee. It is "World" quality that makes "World" owners "tell their friends"—that's the best proof of performance any product can have.

**Compare These Prices:**

Special 200 Hour Rechargeable Storage Batteries	6 Volt 60 Amp. ....	\$8.50
2 Volt for W. D. 11 and 12 tubes. ....	6 Volt 80 Amp. ....	10.00
4 Volt for U. V. 199 tubes ...	6 Volt 100 Amp. ....	12.50
	6 Volt 220 Amp. ....	14.50
	6 Volt 140 Amp. ....	16.00

**Send No Money**

You need not send a penny. Just clip this ad and attach your name and address. The battery will be shipped to you the day your order is received. When the battery arrives, inspect it—read our 2-year guarantee before you pay one penny. Convince yourself you are protected from every angle—that the World battery price saves you 50%. Get the "B" Battery and hydrometer FREE. Order to-day.

**Special Offer**

Clip and mail this add with your World battery order and get this hydrometer and "B" battery free. 5% disc. for cash in full with order.



**WORLD BATTERY CO.**  
Dept. 24, 1219 So. Wabash Ave., Chicago, Ill.

**World**



**CHARGE YOUR BATTERY FOR A NICKEL**

**The Gold Seal Homcharger**

Charges Radio and Auto Batteries at home overnight for a nickel. Your dealer has it. Write for FREE booklet and list of broadcasting stations.

The Automatic Electrical Devices Co.  
128 West Third St., Cincinnati, Ohio

# 1500 MILE RANGE

## VACUUM TUBE RADIO SET READY BUILT



1,500-mile range attained in favorable weather with Atlas Wizard Single Tube Radio Set. Wonderful selectivity—clear tone reproduction—brings you melodies, music and market reports. Dials log with accuracy of a Neutrodyne.

**One ATLAS WIZARD Radio Set** completely built, to one person in each community, only **\$19.95**. Don't fail to take advantage of this amazing offer. Name and address brings set complete by express C.O.D. subject to examination. You take no risk so order this radio wonder today.

**Atlas Cut Rate Radio Stores** Div. 25, 345 S. Clark St., Chicago  
Send 35c in stamps for Atlas Wizard Blueprint. Big Radio Catalog FREE

**WHAT YOU GET**  
Atlas Wizard Receiver, mahogany finish; Head Phones; Vacuum Tube; A & B Batteries; Aerial; Ground Wire; Instructions.  
**READY BUILT**

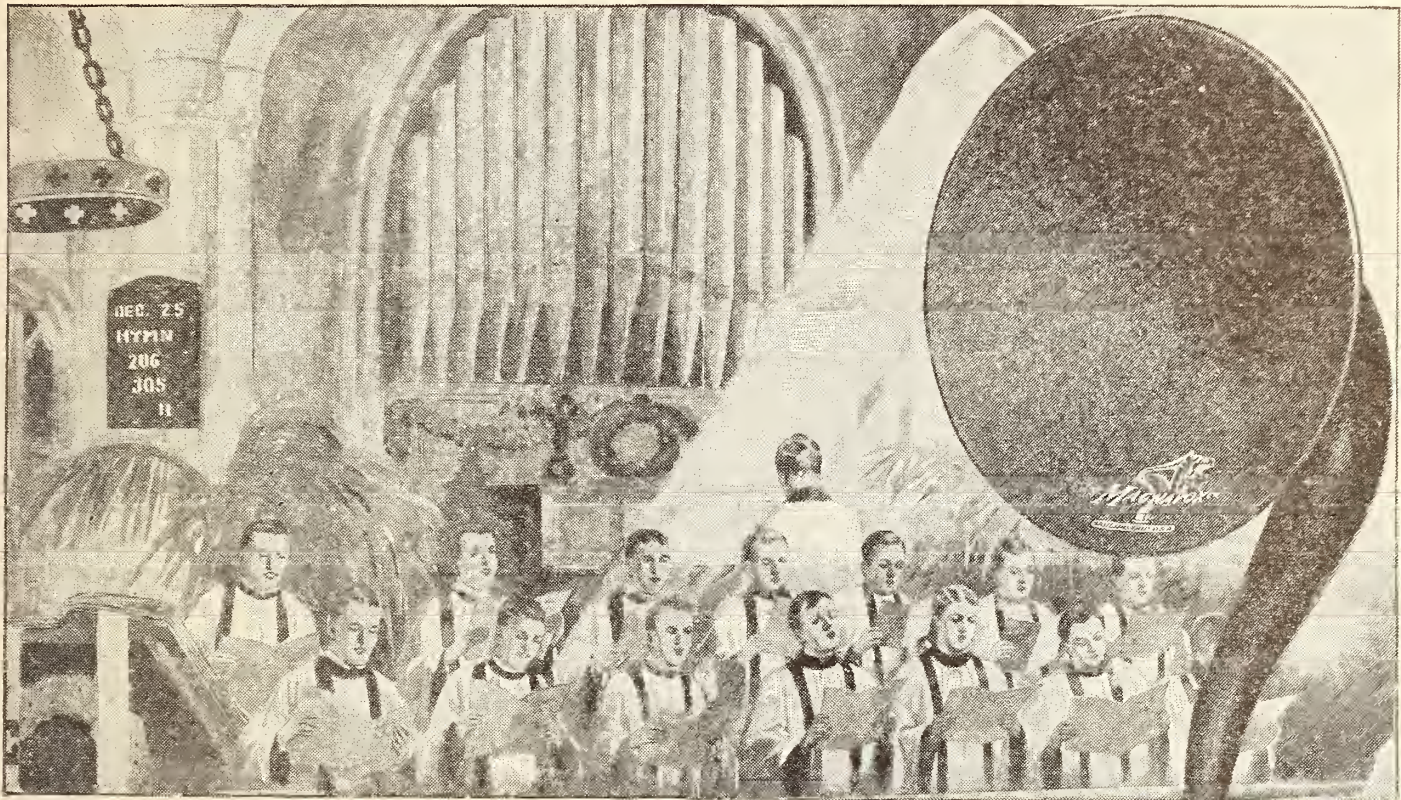

## *Magnavox brings you the Voice of all Christmastide*

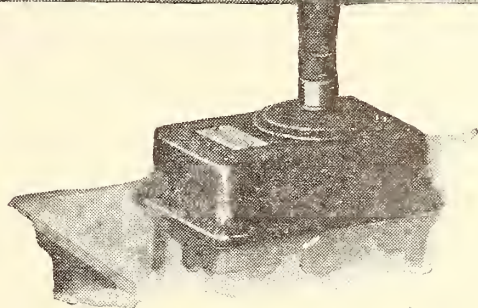

THE Art of Radio Reproduction is enjoyed by every Magnavox owner. Despite the ever-increasing quality and variety of Broadcast Programs, many a receiving set gathers dust unlamented because of insufficient sensitivity or an unsatisfactory "loudspeaker."

Every Magnavox owner is a master of the art of radio reproduction—the results obtained by the use of Magnavox Reproducers and Power Amplifiers cannot be equalled with apparatus constructed in the ordinary way.

The special attention of dry battery receiving set owners is called to the new Magnavox Reproducer M1, illustrated above.

### *Magnavox Reproducers*

R2 with 18-inch horn . . .	\$60.00
R3 with 14-inch horn . . .	35.00
M1 for dry battery sets . . .	35.00

### *Combination Sets*

A1-R Reproducer and 1-stage Amplifier . . . . .	\$59.00
A2-R same with 2-stage . . . . .	85.00

### *Power Amplifiers*

A1-One-stage . . . . .	\$27.50
AC-2-C-Two-stage . . . . .	55.00
AC-3-C-Three-stage . . . . .	75.00

*Magnavox Products can be had of  
good dealers everywhere*

**THE MAGNAVOX CO.**  
Oakland, Cal.

New York Office: 370 Seventh Avenue  
Perkins Electric Limited; Toronto, Montreal,  
Winnipeg, Canadian Distributors

★ **MAGNAVOX PRODUCTS**

*There is a Magnavox for every receiving set*

12R

# AMONG OUR AUTHORS

**L**IEUTENANT HAYDN PURCELL ROBERTS tells us that he signed "HA" on a spark coil back in 1911. In 1913, he completed the Marconi Radio School course and operated commercially on the Great Lakes in the summertime, taking courses in electrical engineering at the Case School of Applied Science during the winter. When America declared war, he enlisted in the Navy as Chief Radio Electrician, operated the Portsmouth, N. H., station, taught at the Naval Radio School at Harvard University, and then went to sea as a member of the "Armed Guard" aboard cargo transports. In 1921, he was commissioned in the Field Artillery, U.S.A., and transferred to the Signal Corps in 1923. At present, he is busy installing "Station AT9" at Fort Bragg, N. C.



LIEUT. ROBERTS  
"Ex-U. S. N."

**P**ETER TAYLOR is still vagabonding. By this time, he and his sister and Blanding Sloan must have completed their voyage across the Pacific and started on their tour of the Orient. We hope to publish more of their adventures later on.

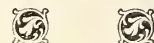

**H**ARRY IRVING SHUMWAY, of Dorchester, Mass., writes us as follows: "At some point chronologically between the Tut Dynasty and Roosevelt's second term I was a humble member of the Doubleday, Page & Co. Family when said Family was located in Union Square, New York. In fact,

I used to broadcast photos to the engravers, the type of machine being a pair of 6D's."

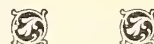

**G**EOERGE J. ELTZ, JR., whose picture appeared in this section last month, is Radio Sales Manager of the Manhattan Electrical Supply Company, in New York. He is a past President of the Radio Club of America.



**A**ALEXANDER NYMAN'S first work connected with radio was in 1918, when he designed a high-frequency generator for airplane spark sets. Later, with the Westinghouse Co., he developed pick-up and amplifying apparatus for broadcasting stations. He is now with the Dubilier Co.



**W**E EXTEND our hearty congratulations to Walter Van B. Roberts, whose marriage to Miss Margaret De Forest, of New York, recently took place. Mr. Roberts has been instructing at Princeton and doing special research work there. He is known to R. B. readers through articles appearing in our May, June and August (1923) issues.

**K**IMBALL HOUTON STARK spent eighteen years "back in the 'sticks' and close to nature and the starlit skies . . . . Maintained his country post office on a paying basis by keeping the



SIR NEUTRODYNE  
STARK

radio, mechanical, and electrical companies ever since 1912 sending him catalogs—to serve as textbooks. . . . Slung up his first antenna in 1913." As for hobbies, we are heartily in sympathy with his liking for "pulling speckled trout out of ice-cold mountain streams and hustling back to camp for a hot crisp piece of bacon drowned in steaming coffee."





## “Here’s the panel I want”

**T**HE panel is the “front door” of your radio set. The selection of the panel is an important step. You want a good-looking panel. And you want a panel that has high dielectric strength.

Your Celoron panel comes wrapped in a dust-proof glassine envelope. Dust and grit cannot scratch it. Human hands cannot leave greasy fingerprints on it.

Because of its high dielectric strength, Celoron, a bakelite product, is approved by the U. S. Navy and the U. S. Signal Corps.

Celoron radio panels are finished in *black, oak and mahogany*. They come ready to use in these standard sizes:

1—6 x 7 x 1/8	5—7 x 18 x 3/16
2—7 x 9 x 1/8	6—7 x 21 x 3/16
3—7 x 12 x 1/8	7—7 x 24 x 3/16
4—7 x 14 x 3/16	8—12 x 18 x 3/16
	9—7 x 26 x 3/16

Other sizes are cut to order from sheet Celoron. *Ask your dealer.*

An interesting booklet for the radio set builder is “*Getting the Right Hook-Up.*” This booklet is sent *Free* upon request.

*To radio dealers: Send for special dealer price list showing standard assortments*

### Diamond State Fibre Company

BRIDGEPORT

(near Philadelphia)

PENNSYLVANIA

Offices in Principal Cities

In Canada: Diamond State Fibre Company of Canada, Limited, 245 Carlaw Ave., Toronto

CONDENSITE  
**CELORON**  
 STANDARD RADIO PANEL



# Supplemental List of Broadcasting Stations in the United States

LICENSED FROM AUGUST 25 TO NOVEMBER 16 INCLUSIVE

CALL SIGNAL	STATION	FREQUENCY (Kilocycles)	WAVE- LENGTH	POWER WATTS
KFJB	Marshall Electric Co., Marshalltown, Iowa	1210	248	10
KFJU	Central Power Co., Kearney, Neb.	1280	234	10
KFJV	Thomas H. Warren, Dexter, Iowa	1340	224	10
KFJW	LeGrand Radio Co., Towanda, Kansas	1330	226	10
KFJX	Iowa State Teachers' College, Cedar Falls, Iowa	1310	229	50
KFJY	Tunwall Radio Co., Fort Dodge, Iowa	1220	246	50
KFJZ	Texas National Guard, Ft. Worth, Texas	1180	254	20
KFKB	Brinkley-Jones Hospital Ass'n, Milford, Kansas	1050	286	500
KFKQ	Conway Radion Laboratories, Conway, Arkansas	1340	224	150
KFKV	F. P. Gray, Butte, Mont.	1060	283	50
KFKX	Westinghouse Electric & Mfg. Co., Hastings, Nebr.	1050	286	500
KFKZ	Nassour Bros. Radio Co., Colorado Springs, Colo.	1280	234	10
KFLA	Abner R. Willson, Butte, Mont.	1060	283	5
KFLB	Signal Electric Mfg. Co., Menominee, Mich.	1210	248	20
KFLD	Paul E. Greenlaw, Franklinton, La.	1280	234	20
KFLH	Erickson Radio Co. Inc., Salt Lake City, Utah	1150	261	50
KFLP	Everett M. Foster, Cedar Rapids, Iowa	1250	240	20
KFLQ	Bizzell Radio Shop, Little Rock Ark.	1150	261	20
KFLR	University of New Mexico, Albuquerque, N. M.	1180	254	100
KFLU	Rio Grande Radio Supply House, San Benito, Texas	1270	236	20
KFLV	Rev. A. T. Prykman, Rockford, Ill.	1310	229	20
KFLW	Missoula Electric Supply Co., Missoula, Mont.	1280	234	10
KUY	Coast Radio Company, El Monte, Calif.	1170	256	50
WABA	Lake Forest University, Lake Forest, Ill.	1130	266	100
WABP	R. F. Weinlig, Dover, Ohio	1130	266	100
WFAV	University of Nebraska, Lincoln, Nebr.	1090	275	500
WJAK	Rev. C. L. White, Greentown, Ind.	1180	254	30
WRAM	Lombard College, Galesburg, Ill.	1230	244	250
WRAN	Black-Hawk Electric Co., Waterloo, Iowa	1270	236	10
WSAY	Port Chester Chamber of Commerce, Port Chester, N. Y.	1290	233	100
WSAZ	Chase Electric Shop, Pomeroy, Ohio	1160	258	50
WTAL	Toledo Radio & Elect. Co., Toledo, Ohio	1190	252	10
WTAM	The Willard Storage Battery Co., Cleveland, Ohio	770	390	1000
WTAN	Orndorff Radio Shop, Mattoon, Ill.	1250	240	100
WTAP	Cambridge Radio & Electric Co., Cambridge, Ill.	1240	242	50
WTAQ	S. H. Van Gorden & Son, Osseo, Wis.	1330	226	100
WTAR	Reliance Electric Co., Norfolk, Va.	1330	226	15
WTAT	The Edison Electric Illuminating Co., Boston, Mass.	1230	244	100
WTAX	William Hardware Co., Streator, Ill.	1300	231	20
WTAY	IODAR-Oak Leaves Broadcasting Station, Oak Park, Ill.	1330	226	15
WTAZ	Thomas J. McGuire, Lambertville, N. J.	1060	283	15
WWAB	Hoenig, Swern & Co., Trenton, N. J.	1330	226	10
WWAE	Alamo Dance Hall, Joliet, Ill.	1320	227	500
WWAF	Galvin Radio Supply Co., Camden, N. J.	1270	236	100
6KW	Frank H. Jones, Tuinucu, Cuba	904	332	100

## DELETIONS FROM AUGUST 1 TO OCTOBER 31

KFAQ	San Jose, Calif.	WHAY	Huntington, Ind.
KFDB	San Francisco, Calif.	WIAY	Washington, D. C.
KFDC	Spokane, Wash.	WJAK	Stockdale, Ohio
KFGY	Baudette, Minn.	WJAP	Duluth, Minn.
KFHI	Wichita, Kansas	WKAC	Lincoln, Nebr.
KFHL	Oskaloosa, Iowa	WLAY	Fairbanks, Alaska
KFHP	Kearney, Nebr.	WLAZ	Warren, Ohio
KFHY	Trinidad, Colo.	WMAM	Beaumont, Texas
KFIJ	Platte, S. Dak.	WMAT	Duluth, Minn.
KFJQ	Grand Forks, N. Dak.	WNAV	Baltimore, Md.
KFZ	Spokane, Wash.	WOAB	Grand Forks, N. Dak.
KGO	Altadena, Calif.	WOAR	Kenosha, Wis.
KMC	Reedley, Calif.	WPAF	Council Bluffs, Iowa
WAAP	Wichita, Kans.	WQAK	Dubuque, Iowa
WBAF	Moorestown, N. J.	WQAY	Hastings, Nebr.
WBAU	Hamilton, Ohio	WRAB	Savannah, Ga.
WDAJ	College Park, Ga.	WRAR	David City, Nebr.
WEAD	Atwood, Kansas	WRAS	McLeansboro, Ill.
WEAK	St. Joseph, Mo.	WRP	Camden, N. J.
WGF	Des Moines, Iowa	WSAQ	Dartmouth, Mass.
WGM	Atlanta, Ga.	WSAU	Chesham, N. H.
WHAO	Savannah, Ga.	WTAK	Steubenville, Ohio

*In an easy chair  
at home MAGNAVOX  
gives you the melody  
of concert and opera*

---

**MAGNAVOX**  
*Radio  
Reproducers and Amplifiers*

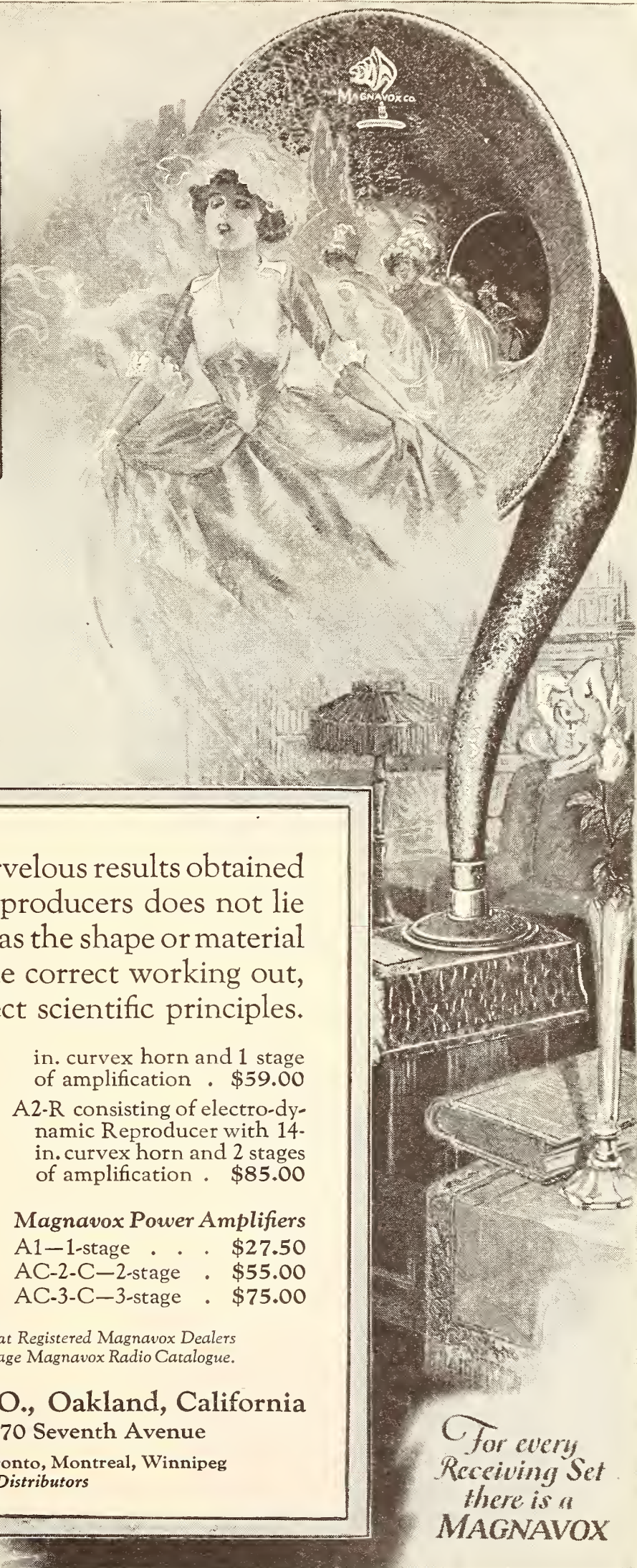

THE secret of the marvelous results obtained with Magnavox Reproducers does not lie in any one feature (such as the shape or material of the horn) but in the correct working out, in all features, of correct scientific principles.

- |  |   |
|--|---|
| <b>Magnavox Reproducer</b>                             |   |
| R2 with 18-inch curvex horn                            | in. curvex horn and 1 stage of amplification . \$59.00  |
| \$60.00  |   |
| R3 with 14-inch curvex horn                            | A2-R consisting of electro-dynamic Reproducer with 14-in. curvex horn and 2 stages of amplification . \$85.00 |
| \$35.00  |   |
| M1 with 14-inch curvex horn.                           |   |
| Requires no battery for the field . . . . .            |   |
| \$35.00  |   |
| <b>Magnavox Combination Sets</b>                       | <b>Magnavox Power Amplifiers</b>  |
| A1-R consisting of electro-dynamic Reproducer with 14- | A1—1-stage . . . \$27.50  |
|  | AC-2-C—2-stage . \$55.00  |
|  | AC-3-C—3-stage . \$75.00  |

Magnavox Products are for sale at Registered Magnavox Dealers everywhere. Write for new 32-page Magnavox Radio Catalogue.

**THE MAGNAVOX CO., Oakland, California**

New York Office: 370 Seventh Avenue

Perkins Electric, Ltd., Toronto, Montreal, Winnipeg  
Canadian Distributors



1R

*For every  
Receiving Set  
there is a  
MAGNAVOX*

# New Equipment

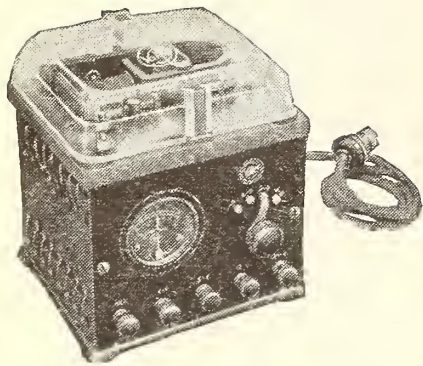

## ANOTHER CHARGER

Known as the Valley Radio Battery Charger and made by the Valley Electric Company, St. Louis, Mo.



## ADAPTER FOR UV-199

This adapter, made by the Eisemann Magneto Corporation, Brooklyn, N.Y., permits the use of the popular 3-volt tube in the standard socket

## EZ-TOON VERNIER DIAL

This dial gives very fine adjustment with any condenser, movement of the small dial producing a lesser movement of the main dial. Manufactured by The Butler Manufacturing Co., Indianapolis, Ind.

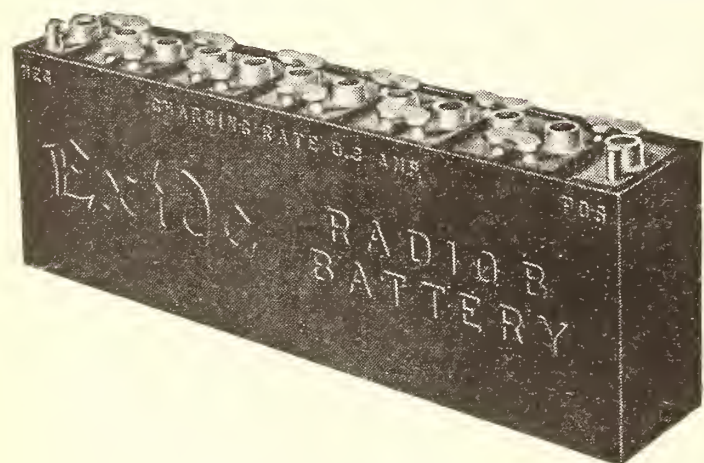
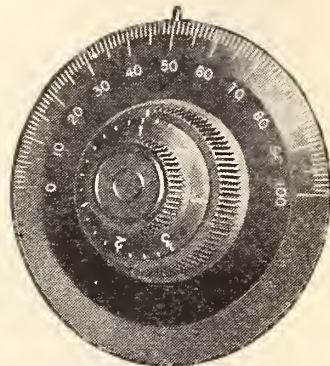

## A STORAGE PLATE BATTERY

For the plate of any tube. Made by the Electric Storage Battery Co., Philadelphia, Pa.

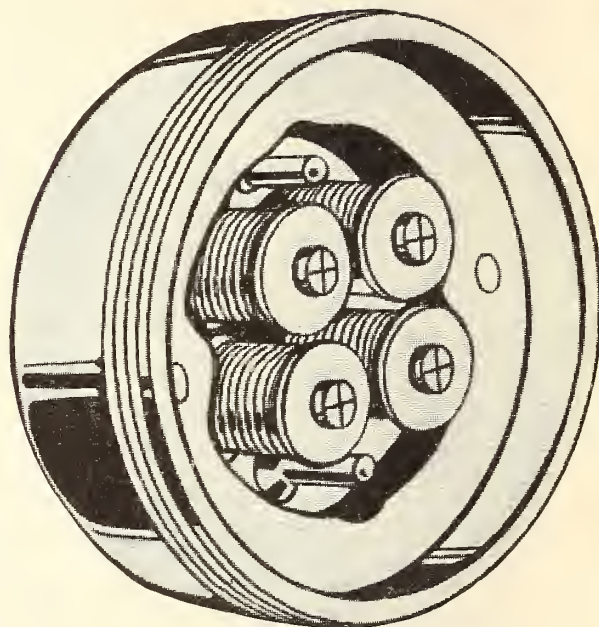

## PENBERTHY 4-POLE PHONE

Made by the Penberthy Injector Company, Detroit, Mich. This departure from standard head-phone construction is designed to give a more uniform magnetic distribution on the diaphragm, and is built to withstand a higher voltage than other types

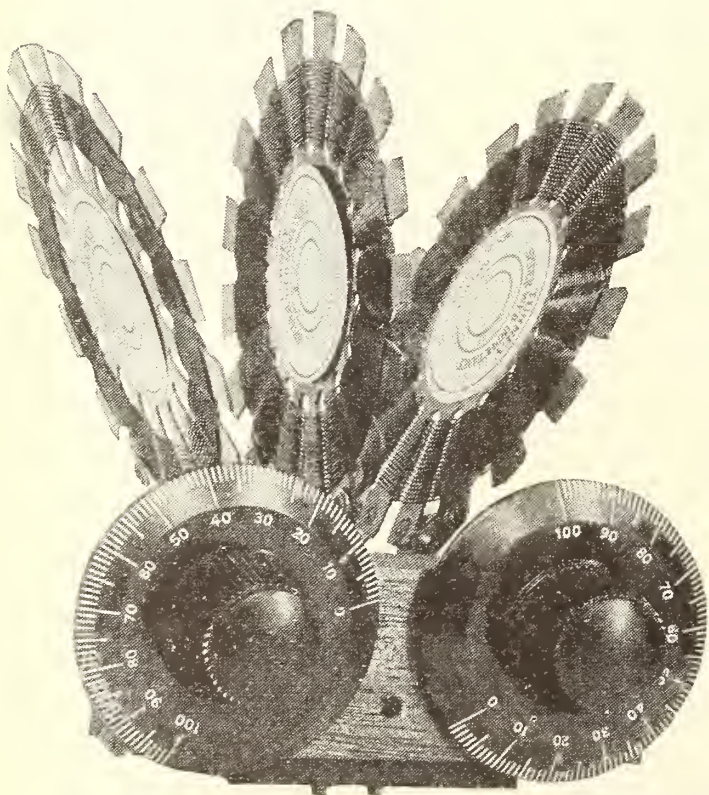

## COMBINATION TIP-JACK AND BINDING POST

It takes standard sizes of phone tips, and wire from No. 10 to No. 14. "Fork" or "spade-tip" terminals, as well as other sizes of wire can also be connected in the usual manner. The Globe Phone Mfg. Co., Reading, Mass.

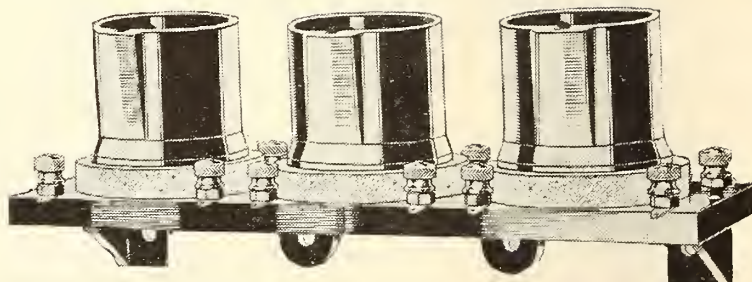
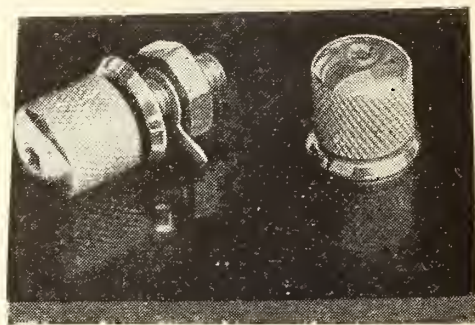

## FROST SHOCK-ABSORBER STANDARD SOCKET

Between the sub-panel and the bases of the three sockets in this Herbert H. Frost, Inc. product are cushions of sponge rubber, to offset microphonic noises experienced with some types of tubes. Herbert H. Frost, Inc., Chicago, Ill.

## TURNEY 3-COIL MOUNTING FOR SPIDER-WEBS

Sold by the Tristan Sales Corporation, New York

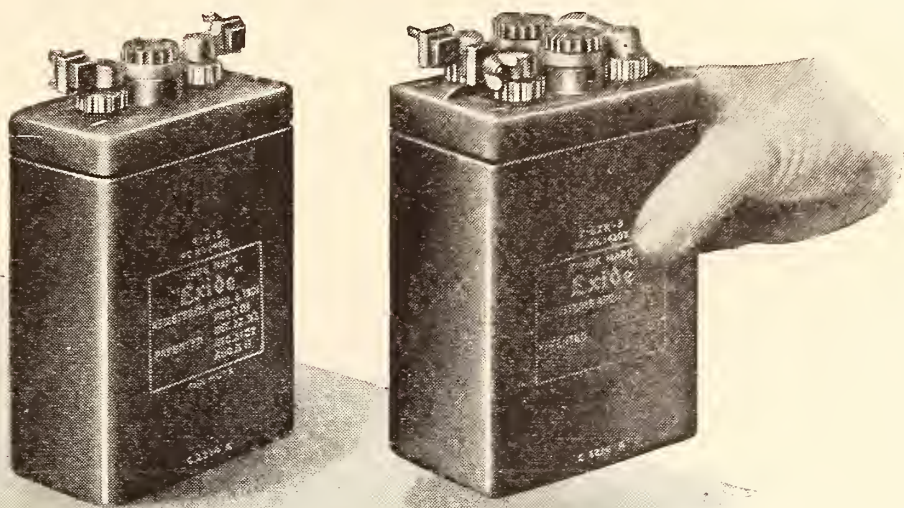

## What you have been waiting for

**H**ERE are two rugged little storage batteries designed particularly for low-voltage tubes.

Although they weigh only 5 and 6 pounds, they are of true Exide quality. Highly efficient and with ample power for long-distance receiving, these batteries will give you a type of service that you would find it hard to duplicate.

These sturdy little batteries are neat and compact. They were specially designed for WD-11 and UV-199 vacuum tubes, but can be used with any low-voltage tube. The two-volt Exide A Battery consists of a single cell. It will heat the filament of a WD-11 or other quarter-ampere tube for approximately 96 hours. The four-volt A Battery, having two cells, will light the filament of a UV-199 tube for 200 hours.

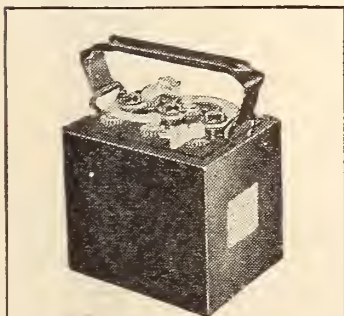

**For six-volt tubes**  
Like all Exide Storage Batteries, the Exide A Battery for six-volt tubes is dependable and long-lasting. It is made in four sizes, of 25, 50, 100 and 150 ampere hour capacities.

adjustment that make radio receiving an unalloyed pleasure.

As you know, any variation of current in the plate circuit produces weird sounds in your phones. With an Exide B Battery hooked up to your set, static is the only undesirable sound you will have to contend with. The Exide B Battery supplies steady, noiseless current. It permits the niceties of

The Exide A Battery for six-volt tubes has extra-heavy plates, assuring constant potential and uniform current over a long period of discharge. Like all Exide Batteries, it embodies the finest materials available.

### *In marine and commercial wireless*

On sea and on land the Exide plays an important role in the industrial life of the nation. In marine wireless, Exide Batteries provide

an indispensable store of emergency current. A majority of all government and commercial wireless plants are equipped with Exides.

Exide Radio Batteries are sold by radio dealers and Exide Service Stations everywhere. Ask your dealer for booklets describing in detail the complete line of Exide Radio Batteries. Or write direct to us.



### *Exide B Batteries*

give noiseless, full-powered service over a long period of discharge. Designed throughout to prevent electrical leakage. Capacity, 3 ampere hours.

# Exide<sup>★</sup>

## RADIO BATTERIES

THE ELECTRIC STORAGE BATTERY COMPANY, PHILADELPHIA

*Oldest and largest manufacturers in the world of storage batteries for every purpose*

Service Stations Everywhere

Branches in Seventeen Cities

★ Tested and approved by RADIO BROADCAST ★

# AMONG OUR AUTHORS

**A**SHLEY CLAYTON DIXON of Stevensville, Montana, is a rancher and fruit-grower whose "hobbies, 'till the spring of 1922, were guns and cameras." He and his son now operate a broadcasting station and two amateur stations. "Radio," he says, "is the greatest godsend to the rancher since the pony express and covered wagon were displaced by the railroad."



ASHLEY C. DIXON  
Rancher, Radio Fan,  
and Broadcaster

**D**URING the War, R. H. G. Mathews was a well-known figure around the Great Lakes Naval Training station, having every task from radio electrician in charge of the U. S. S. *Yantic* to head of the radio section of the Naval Intelligence Bureau of the 9th, 10th, and 11th Naval districts. Mr. Mathews is at present chief engineer and a partner in the Chicago Radio Laboratory.

**T**HOMAS M. PLETCHER a native Hoosier, has been watching the music industry grow—from the inside—for the last thirty years. He is president of the Q. R. S. Music Roll Company and director of the Musical Chamber of Commerce.

**C**ARL GOUDY is not only an engineer and radio man. He holds the world's record for the 300-mile motor-cycle race. Until recently, he has held practically all the records for the shorter distances. For several years he has been teaching mechanical engineering at Pratt Institute in Brooklyn, N. Y.

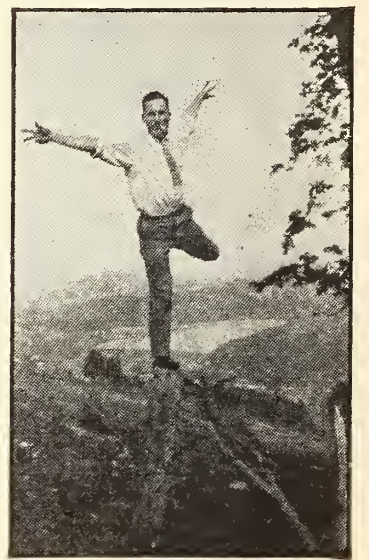

CARL GOUDY

**A**. J. HAYNES, vice-president of Haynes-Griffin Radio Service, New York, has been active in radio since 1910. In 1920 he had charge of the De Forest station, 2XG. at Highbridge.

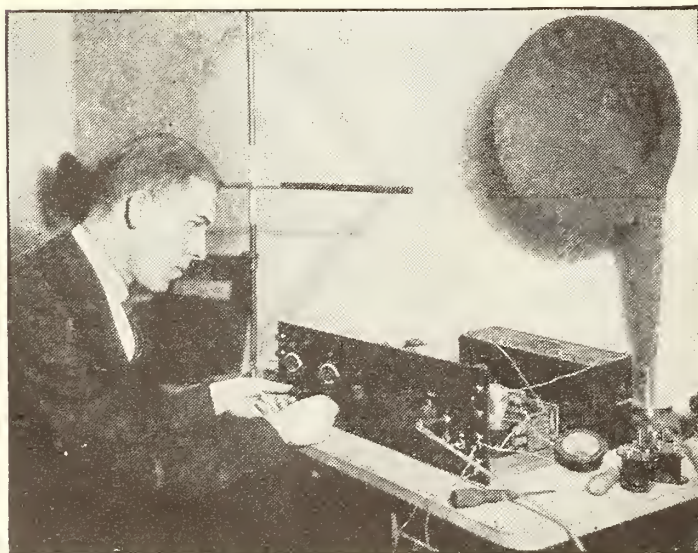

A. J. HAYNES

**T**HE talk turned, the other day, from radio to books. That energetic worker, Zeh Bouck, had just finished a series of experiments with a super-heterodyne and a one-tube reflex for the R. B. Lab., and he was resting up a bit. "I like Oscar Wilde," quoth he, "also Swinburne, Poe, Aeschylus, Sophocles, Villon, Beardsley, Whistler, de Quincy, and Tom Moore's Tavern. De Quincy has recently interested me in opium eating. My one true abomination is radio."

# The COURT JESTER of TODAY

"No wit to flatter left of all his store,  
No fool to laugh at, which he valued more."  
—Pope

SINCE the earliest days, laughter and gaiety have been the most sought after things in life. In ancient times stately rulers unbent, courtly knights forgot seriousness; beautiful ladies became more alluring as the clever quips and merry pranks of the court jester brought a sparkle to their eyes and drove dull care away. But they were limited to the clownish antics and slap stick comedy of the jester.

Moderns have unlimited sources of amusement. Every broadcasting station has its Jester; its humorous stories; amusing songs and clever comedies. Each night the air is filled with merriment.

With a Crosley Model X-J radio receiver, amusement may be brought clearly and distinctly to your fireside. Sitting comfortably in an easy chair you forget dull care. The magic wand of the radio sends worry scurrying.

The very moderate prices of all Crosley instruments bring radio within the reach of all. No matter which Crosley Model you may select you can be assured of the maximum results at the lowest cost.

Let a Crosley Radio Receiver bring fun, laughter and good humor into your home.

**CROSLEY**  
Better - Cost Less  
Radio Products



See the Crosley Line at Good Dealers Everywhere

Write for Free Catalogue. This fully describes the Crosley line of Radio receivers which range in price from the Model VI, a 2 tube set at \$30, to the graceful Console Model X-L at \$140. It also shows the complete line of Crosley parts.

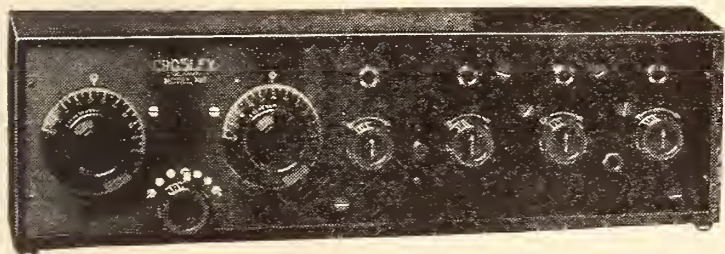

Crosley Model X-J—Price \$65

For tuning out local interference and bringing in distant stations this receiver is unexcelled. It is a 4 tube set combining one stage of tuned radio frequency amplification, detector, and two stages of audio frequency amplification.

*Nowhere can a better set be purchased at any price*

Cost of necessary accessories \$40.00 and up.

**CROSLEY MANUFACTURING CO.**  
Powel Crosley Jr., President  
120 Alfred Street Cincinnati, Ohio



**CROSLEY** \$  
*Model X-J* **65**

The Broadcasting Station WLW is maintained by the  
CROSLEY MANUFACTURING COMPANY

**MAIL THIS COUPON TO-DAY**

Crosley Manufacturing Co.,  
120 Alfred St., Cincinnati, O.

Gentlemen: Please mail me free of charge your complete catalogue of Crosley instruments and parts together with booklet entitled "The Simplicity of Radio."

Name .....

Address .....

★ Tested and approved by RADIO BROADCAST ★



MYRA MAY

Journalism, where she was recently graduated. Miss May is one of the first women to contribute to RADIO BROADCAST. And her article in this issue strikes a chord which we feel sure is of great interest to our readers.

MYRA MAY, whose article, "If You Like Them, Let Them Know It" appears in this number, is a New Yorker, although she is from the sunny South. She admits blushing to owning a sheepskin from Columbia University School of

YOU WILL WANT TO READ . . .

NEXT MONTH the story of what newspaper owners think of broadcasting. Some of the questions you have been asking yourself about who should broadcast and why are answered in this article.

You would like to know what the inside of a radio factory looks like, too. Howard S. Pyle, an old-time radio man, in Detroit has taken some excellent pictures and describes a model factory. You should know just how they wind your coils.

Have you ever wondered how much you *could* amplify signals? An article next month on the Limit of Amplification contains exactly the reason radio frequency amplification, beyond a certain point is useless. This article is a most intelligent answer to some of the puzzles heretofore given little or no attention.



## AMATEUR TRANSATLANTIC TESTS DECEMBER 22nd TO JANUARY 10th

*On the nights of December 22, 1923, to January 10, 1924, inclusive, American amateur operators will try to copy code messages from their brother amateurs in France and England. The time from 8 P. M. to 1 A. M., Eastern Standard time, has been set aside as a quiet period, and the American Radio Relay League is making an earnest effort to have all amateurs on this side of the water refrain from using their transmitters during these hours.*

*The test hours in Greenwich mean time are 0100 to 0600; in Central Standard time, 7 to midnight; in Mountain Standard time, 6 to 11 P. M.; and 5 to 10 P. M. Pacific time.*

*The French and British amateurs will not send faster than ten words per minute, and the American Radio Relay League, in charge of the test, will distribute over \$3500 worth of prizes for the best reception reports turned in to their headquarters, 1045 Main Street, Hartford, Connecticut.*

*Broadcast listeners who can copy the code can join in these receiving tests. The foreign amateurs will send on wavelengths from 180 to 220 meters. This series of tests will be the fourth that has been conducted to bridge the Atlantic with low power and short wavelengths.*

*Amateurs all over the United States and Canada have been looking forward to these transatlantic tests and waiting for the favorable months of mid-winter. It is simply a matter for all amateurs with transmitting sets to keep their sets silent on these nights. Those in charge of the tests feel that these European signals will get through to our North American stations only if the local air is not clogged with unnecessary signals.*

"Noblesse Oblige."



# "EVERYTONE"

(GUARANTEED)

## RADIO HEADSET

\$ **3.50**

2200 OHMS

3000 OHMS—\$3.75

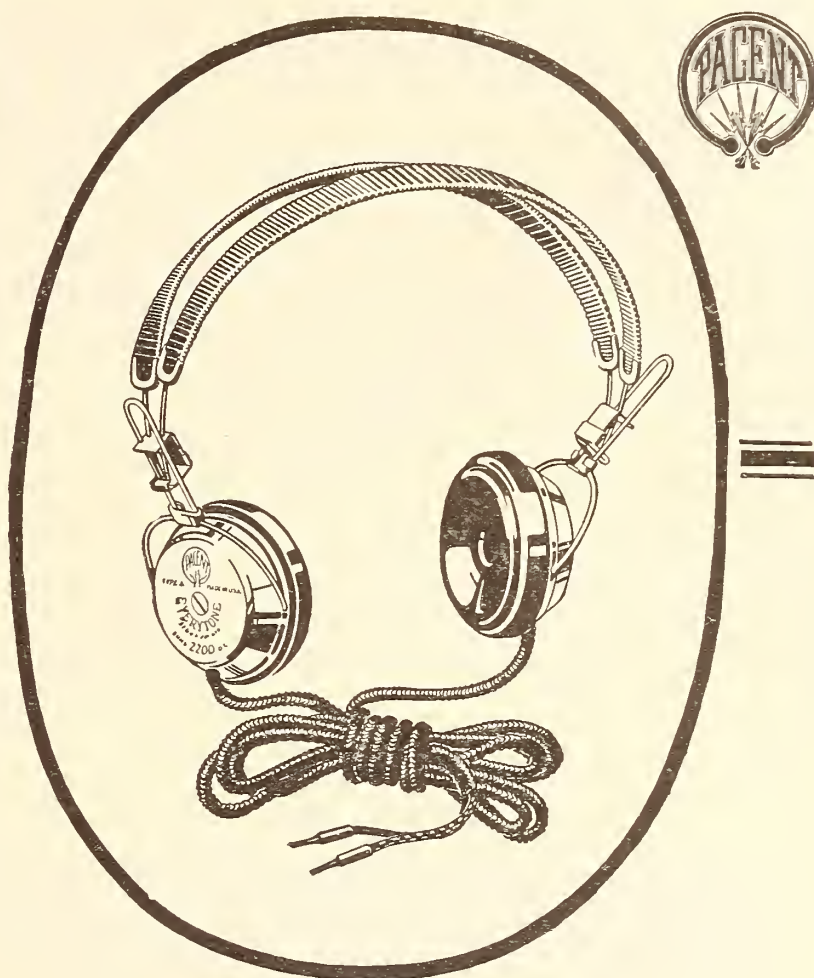

**A**N ordinary headset at this low price is not unusual—but the PACENT "EVERYTONE" is an unusual headset at a price that is low enough to enable you to own several pairs.

The greatest Radio Headset value ever offered the radio public. Backed by a written one-year Pacent guarantee.

The Pacent "EVERYTONE" Headset—endorsed by leading radio experts—is of superior lightweight construction, and embodies many new and distinctive features that insure clear and distinct reception without distortion, increase the comfort to the wearer, and guarantee complete satisfaction. Write for Catalogue (B-1) of Pacent Radio Essentials.

**PACENT ELECTRIC CO., Inc., 22 Park Place, New York**

SALES OFFICES: *Philadelphia, Washington, Minneapolis, Chicago, St. Louis, San Francisco, Jacksonville.*

*Don't Improvise, "PACENTIZE"*

★ **Pacent**  
**RADIO ESSENTIALS**

# Equal to All Demands

THIS IS NUMBER FOUR OF A SERIES

Every tube you add to your receiver makes it just that much more important for you to use Eveready "B" Batteries, for each additional tube increases the work the "B" battery has to do. It demands a more capable, long-lived battery.

Here is a table that shows just what each type of receiving tube draws from your "B" battery. The current is measured in milliamperes, or thousandths of an ampere.

Current (in milliamperes) Taken from the "B" Battery by Various Tubes

"B" Volts	WD-11 WD-12	UV-199 C-299	UV-201 C-301	UV-201-A C-301-A
22½	0.5	0.5	0.5	0.5
45	1.5	1.4	1.5	1.5
67½	2.5	2.4	2.5	3.5
90	4.5	4.0	3.9	6.0

*Above figures are at zero grid bias*

The table shows that the "B" battery current drain increases much more rapidly than the increase in voltage. For example, if the voltage doubles from 45 to 90, the current drain increases threefold in one case and fourfold in another case. This all means that the life of the "B" battery may be materially lengthened by not using a higher voltage than is necessary to obtain the desired results.

The most popular type of receiver today has at least three tubes, operating a loud speaker. As ordinarily employed, it places a fairly heavy drain on the "B" battery.

Under light and heavy service, Eveready "B" Batteries prove up. More and more fans buy them every day because they are the most economical. According to the work they have to do, so is their life.

You get most energy for your money in Eveready "B" Batteries—they last longer.

## "the life of your radio"



The Metal Case Eveready "B" Battery No. 766. The popular 22½-volt Eveready Battery in a new, handsome, durable, waterproof

metal case. At all dealers, \$3.00.

Eveready "B" Battery No. 767. Contains 30 large size cells, as used in the popular No. 766. Voltage, 45. Made especially for sets using detector and



one or more stages of amplification. The most economical "B" Battery where 45 volts are required. At all dealers, \$5.50.



Eveready Radio Battery No. 771. The Eveready "Three," the ideal "C" Battery. Voltage, 4½—three terminals permitting the use of 1½, 3, or 4½ volts. The correct use of this battery greatly prolongs the life of the

"B" Battery. At all dealers, 70 cents.

*Manufactured and guaranteed by*

NATIONAL CARBON COMPANY, INC.  
Headquarters for Radio Battery information  
New York, N. Y.

★  
**EVEREADY**  
**Radio Batteries**  
—they last longer

NOTE—This is No. 4 of a series of informative advertisements, printed to enable users to realize the utmost in battery economy. If you have any battery problem, write to G. C. Furness, Manager, Radio Division, National Carbon Co., Inc., 126 Thompson Avenue, Long Island City, N. Y. Ask for special booklets on "A", "B" and "C" batteries.

# RODYNE

## Radio Receiver

NO OTHER RECEIVER  
CAN EQUAL

“THE ROLLS-ROYCE OF RECEPTION”

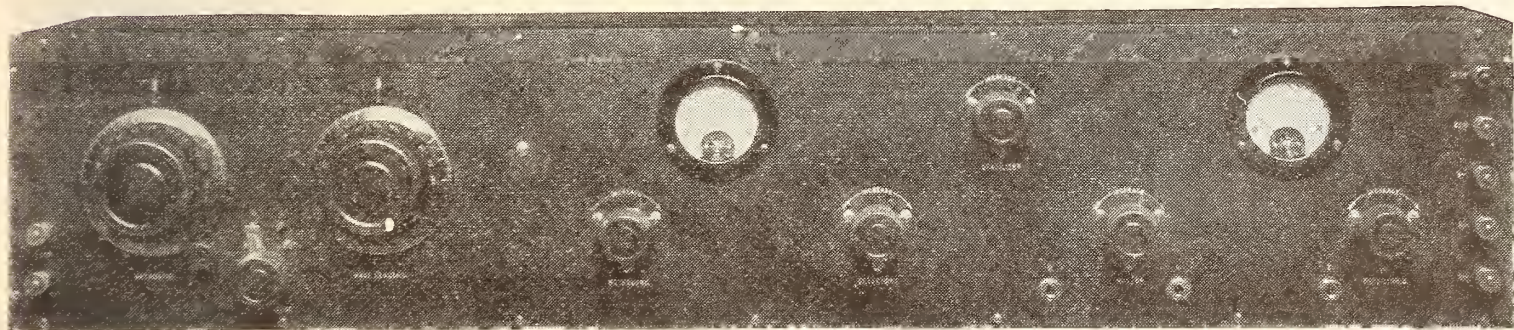

### MODEL "C" SUPER-HETERODYNE

Wavelength Range 166 to 850 meters. Tubes, 2 Detectors, Oscillator, 3 Tuned Radio Frequency Amplifiers, 2 Audio Amplifiers

The Super-Heterodyne is the most efficient method of short wave radio frequency amplification known. It is used extensively by the Commercial radio companies and various governments, when it is necessary to receive over extremely long distances without interference from near-by stations.

The remarkable results are due to the Super-Heterodyne action, which is briefly as follows: the incoming signal, which may be any wave from 160 to 850, is changed through the use of a local oscillator, to a wavelength of 10,000 meters. At this wavelength an exact duplicate of the original signal is amplified at radio frequency with the very highest efficiency possible, rectified and amplified at audio frequency.

During this change a very high degree of selectivity is secured, due to the amplifier, which is designed to pass nothing but 10,000 meters. Accordingly while there may be ten or more signals in the loop, only one will be received at a time, the one that the oscillator heterodynes through the amplifier.

and Two Sheets 27x21", Our Numbers 30141-145. \$2.00 Postpaid

*Designers of the Highest Class Radio Apparatus in the World*

476 Broadway

NEW YORK CITY

CATALOGUE No. 64

# It's the contact that counts



Na-ald Special Socket No. 499, for U. V. 199 Tubes and C-299. Price 50c

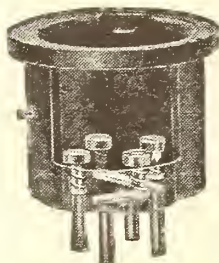

Na-ald Adapter No. 429, for 199 Tubes. Price 75c



Na-ald DeLuxe, No. 400 for 200 Series Tubes. Price 75c



Small Space Socket, No. 401, 35c, 3 for \$1.00.



Na-ald W.D. 11, No. 411, Price 75c

Weak reception due to inferior contacts is banished when Na-ald sockets are placed in a set. Na-ald contacts exert a strong, wiping pressure on tube prongs over a broad surface, regardless of frequent removal of bulbs or variation in the length of prongs.

You can count on Na-ald sockets under all conditions. They are moulded of genuine Bakelite, with uniform cross-section and cure. These features prevent plate-to-grid-losses and insure full efficiency from tubes.

Insist on Na-ald sockets and put an end to weak reception. All good dealers carry them.

### NA-ALD INSIDE INFORMATION No. 400

Have you ever had the experience—the failure of your set to operate, and, although the filament in the tube lighted, signals refused to come in because the socket clips were not pressing against the plate and grid prongs of your tube? And after finding out that this was the case, did you hunt for a button hook or other device in an endeavor to bring the socket prong back into its proper position?

If you are using No. 400, Na-ald De Luxe, this trouble is over. The dual-wipe contacts of this socket press on both the sides and ends of the tube prongs, and the strips are laminated like an automobile spring to insure continued resiliency. A DeLuxe socket, but priced at 75c! In comparison to the cost of other parts of your set, can you afford to use substitutes? Becoming the standard of particular set manufacturers.

### Alden Manufacturing Company

Largest Makers of Radio Sockets and dials In the World—Why?

52 Willow St. Springfield, Mass.

Dept. B Cable Address: Aldenco



# AFTER EXTENSIVE TESTS AND COMPARISONS—

We Offer: ★

## The Branston-Quality—Guaranteed Audio-Transformer!

YOU can now get rid of noisy or otherwise unsatisfactory transformers and, with perfect confidence, replace them with this fully-tested-and-proved audio frequency transformer. The results will delight you and your "audiences."

You can now make up new sets, with the certainty that you have the maximum possible amplification and best tone quality without distortion.

If your dealer has not yet secured his supply, send check or money order for as many as you need, @ \$6.50 each, or order parcel post C.O.D. Mention your dealer's name please.

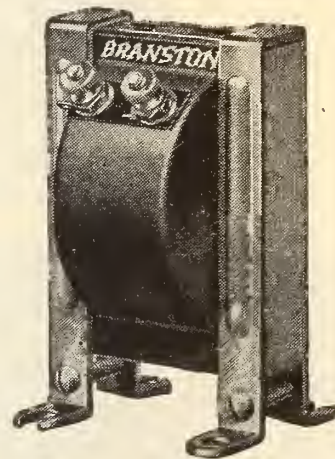

Branston-Quality—Guaranteed Audio Frequency Transformer. Neat, compact, efficient. It gives the results you want. Each \$6.50

## Use Branston "Broadcast Coils" for Closer Selectivity

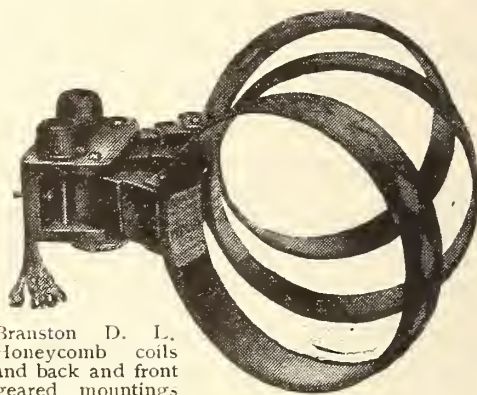

Branston D. L. Honeycomb coils and back and front geared mountings are "Standard of the World."

VERY fine adjustment, close selectivity and clearer reception for all wave lengths between 250 and 600 meters. Wound on Formica Tubes 5" diameter. Equipped with standard coil plugs. Fit any Honeycomb coil mounting. Furnished only in sets of three, Primary, Secondary, Tickler. In attractive carton, per set, at dealer's or by \$5.00 mail.



Look for this trademark card in your dealer's window or salesroom.

### Send 2c. Stamp for New Honeycomb Coil Hookups

Compiled by experts and includes five good honeycomb Coil "Hookups" and complete catalogue of famous Branston Radio Apparatus. Write to-day. Give us name of your radio dealer. If he cannot supply you, write

CHAS. A. BRANSTON, Inc. Manufacturers of Branston Violet Ray High Frequency Generators

813 Main St. Buffalo, N. Y.

In Canada—Chas. A. Branston, Ltd. Toronto

## Model X

**\$285 Fully Equipped With  
Built-in Loud Speaker**

This radio receiving unit is a newly perfected development of the Kennedy Engineering Staff. It is unusual in that it combines extreme simplicity of operation with the same scientific accuracy and selectivity that characterized the earlier Kennedy models. After an initial setting is made only one dial is required for all tuning. And, when a dial setting of a station is once determined, that station will always "come in" at its own setting regardless of where the receiver is used.

It is stable in operation, reproduces music and voice with remarkable faithfulness and has established some unusual distance records. Responds to all broadcast wave-lengths—operates on any antennae, outside type preferred. "Re-radiation" has been practically eliminated.

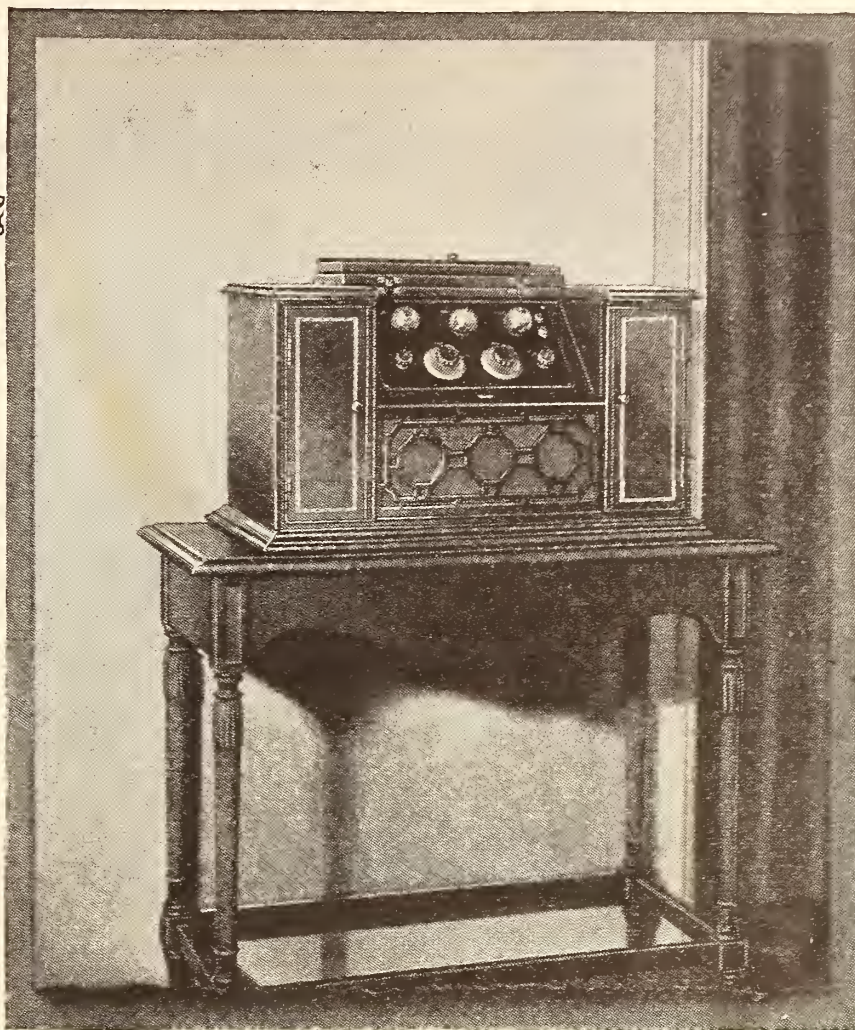

## Beautiful Radio Furniture = the New Kennedy Receiver, Model X

As a graceful piece of furniture, the Kennedy Radio Receiver, Model X, makes a charming addition to any home. The cabinet is of mahogany, hand rubbed to a beautiful finish—with its delicate inlay of satinwood and ebony and the grill at the front, it is truly typical of the Sheraton design. A loud speaker of superior quality is built into the cabinet—by this means faithful reproduction of music and voice is available to an entire family or assembly of guests.

The control panel is symmetrically balanced and immediately indicates the remarkable ease with which the receiver may be operated—the angle at which it is set is the result of much study to provide greater comfort while tuning.

The receiving unit in Model X is every-

where recognized as one of the most noteworthy achievements in radio development—particularly since it sets a new standard of operating simplicity in combination with the precision and selectivity that have always been a feature of Kennedy radio receivers.

The price of Model X, completely equipped with all tubes, dry batteries, built-in loud speaker and individual Kennedy 3,000-ohm phones, with plug, is \$285.00. Other models range from \$125.00 to \$825.00, completely equipped.

Ask your dealer to show you the new Kennedy Radio, Model X, or write us direct for fully illustrated literature.

THE COLIN B. KENNEDY COMPANY  
St. Louis San Francisco

*All Kennedy receiving sets are regenerative.  
Licensed under Armstrong U. S. Patent No. 1,113,149.*

# ★ KENNEDY

The Royalty of Radio



★ Tested and approved by RADIO BROADCAST ★

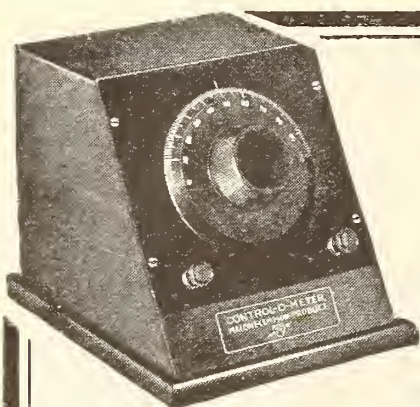

PAT. APP. FOR

We are putting forth every effort to make the Control-o-meter easy to get through local dealers, but should you be unable to secure a Control-o-meter, we will ship you one postpaid on receipt of price.

**\$12.50**

# --one at a time

with a ★

## CONTROL-O-METER

YOU can select the programs you want to hear if you equip your set with a Control-o-meter, and you don't need technical knowledge to get results. Just turn the dial to a number indicated on the individually calibrated chart supplied with each Control-o-meter and the interfering program dis-appears.

**That's all there is to it**

No matter what kind of set or antenna you have or where you live, the Control-o-Meter will allow the reception of one program without interference from another. Moreover, the addition of a Control-o-meter will not decrease the volume of distant stations.

*Kindly Address Dept. D*



### MALONE-LEMMON PRODUCTS

Made by STEPHENSON LABORATORIES  
342 MADISON AVENUE  
NEW YORK CITY



**An Absolute Guarantee**  
with every instrument  
*made them famous!*

**SHAMROCK**  
FOR SELECTIVE TUNING

**180°**

**Vario-Coupler**  
*list price,*  
**\$3<sup>50</sup>**  
*each*

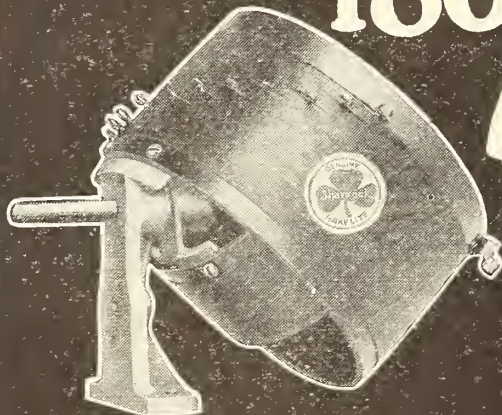

**DOUBLE  
DUTY  
PIG-TAIL**

**Variometer**

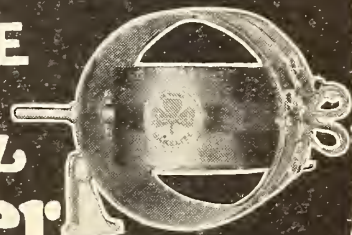

**SHAMROCK MFG. CO.**  
316 E. Market St. ~ Newark N.J.

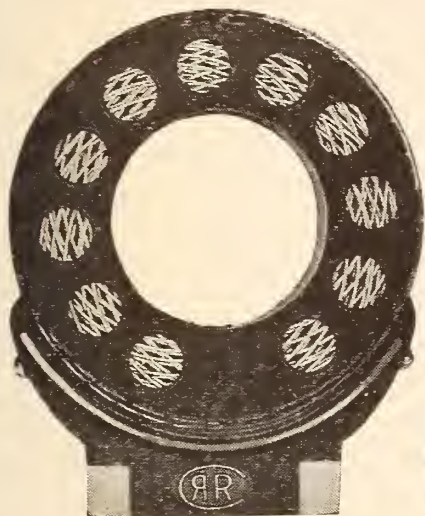

**THE  
STORY OF  
CURKOIDS**  
THE SUPREME INDUCTANCE

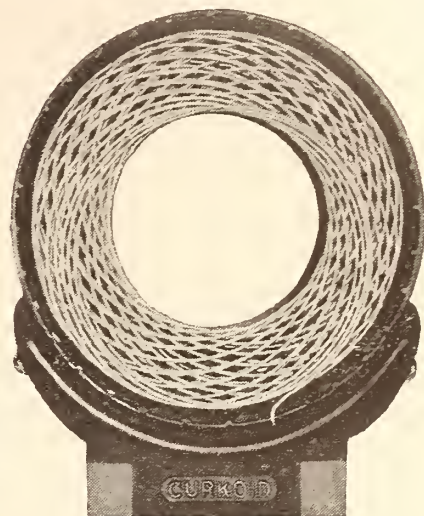

A crowd of us were sitting around discussing the results we obtained with the various devices and hook-ups we have used the past year.

Gene and Dale came in and told their stories, how with a Triple Coupler and Curkoids they had traveled all over the map, and how with the use of Curkoid Coupled Radio Frequency, they had brought in everything this side of the Rockies on a loud speaker, the same as on local stations.

Dave spoke up and told us of his reception of 2LO London three successive nights during the test. And how on one night, while clearing up 2LO, he tuned into Havana and it came in on the detector so loud, he had to move his 'phones off his ears.

Silent Jim hadn't said a word, he is always slow to speak. "Well, boys, Curkoids got me, I have three stages of Curkoid Coupled Radio Frequency tuned with a Dual Coupler and two of audio with a single 'phone unit in my own speaker. Last Saturday night we had a dance at the house. Our local stations signed off just when every one was most enthusiastic. We tried the old phonograph but it seemed to lack the pep and punch and personality the radio had given us, so I tuned a bit and picked up a dance number by a corking good orchestra. We danced and danced and through the encores—we were glad to get the announcer for a breathing spell—'Art Hickman's orchestra, Los Angeles.' Say boys, it almost killed the party dancing to music from

a way across the country. And so boys, I am shouting for Curkoids."

**CURKOIDS Prices**

Radio frequency coupler.....	\$2.75
Triple coupler.....	7.50
Dual coupler.....	4.50
20 K inductance.....	1.40
25 K ".....	1.50
35 K ".....	1.50
50 K ".....	1.60
75 K ".....	1.65
100 K ".....	1.70

(Made up to size 1,500 K)

**RIEGER RESEARCH  
CORPORATION**

114 West 44th Street

New York

**Our New CURKOID Booklet**

Send ten cents for the booklet which tells you how to make simple, single, two and three circuit receiving sets, regenerative and non-regenerative, super-regenerative and reflex circuits, including full construction data.

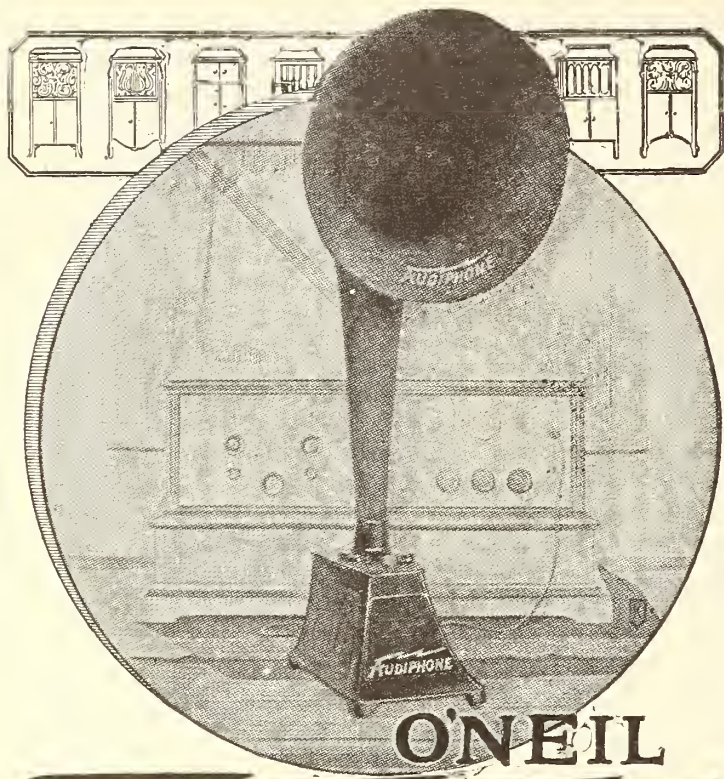

# O'NEIL AUDIPHONE

**T**HE highest standard of music reproduction, the phonograph, now equalled by the O'NEIL AUDIPHONE. Designed and built on phonograph principles by phonograph craftsmen and radio acoustic engineers. A radical improvement over the old earphone type of loud speaker. The entire voice or instrument is transmitted through the "laminated voice core." Diaphragm adjusted by exterior thumb screw.

No extra batteries needed

Complete, with connecting cord

**\$25.00**

Model in Antique Bronze

**\$30.00**

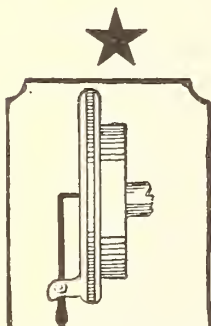

Absolute "money-back-if-not-satisfied" guarantee on every O'Neil Audiphone. Should your dealer have none on hand, order direct, C. O. D., mentioning your dealer's name. Write for booklet.

Note the similarity of construction between the phonograph reproducer (illustrated in the upper panel) and the reproducer of the O'Neil AUDIPHONE (below): both have a mica diaphragm set in a sound-box chamber and actuated by an elbow stylus bar.

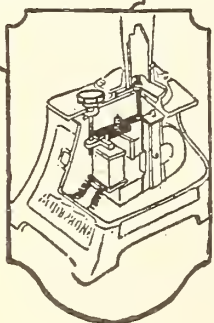

**O'Neil Mfg. Co.**

715 PALISADE AVE.  
West New York, New Jersey

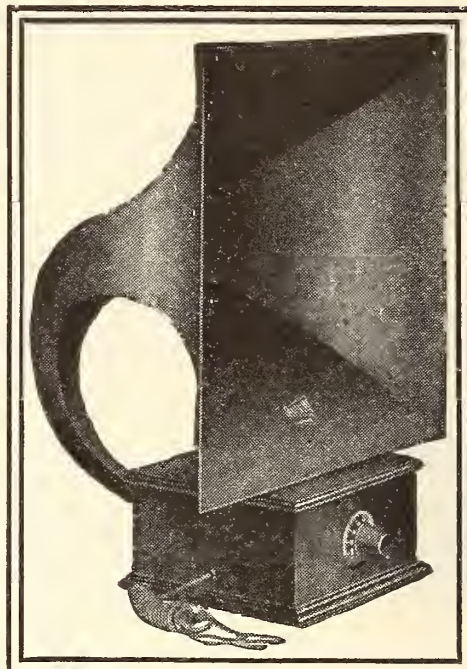

## *The Voice of the Callophone*

—rich, clear, natural—faithfully reproducing the true voice of the artist. Any undertone or metallic vibration is quickly cleared by a turn of the dial controlling the diaphragm—an important feature, because of the varying strength of different sets. No batteries required.

Although little is generally known of the "Radio" Callophone—Callophone loud talking commercial equipment has been recognized for years as the best procurable.

The price of the Callophone is \$35.00, delivered. Send for one to-day—if it does not prove entirely satisfactory, return it within ten days and your money will be refunded.

*"None Can Compare"*

**CALLOPHONE COMPANY  
OF NEW YORK, INC.**

216-222 Mercer St., New York, N. Y.



# You Can Fill One of These Big-Pay Positions Waiting in Radio!

**\$2500 to \$10,000 a Year**

**N**O other training offers such opportunity for success as a Certified Radio-trician. Honor, power, position, wealth—all are easily possible for those who enter this great new profession NOW, while it is growing.

## Now the Fastest Growing Business

Radio has jumped into the front rank of the world's great industries, yet it is only in its infancy. Its vast, amazing possibilities are as yet undiscovered in a large measure. And great as it is to-day, it will be a thousand times greater to-morrow! The man who gets into Radio to-day—who prepares NOW to grow up with this wonderful new science—will have a great share in its glorious future.

## Master Radio at Home

To the ambitious man, Radio offers greater opportunities for success than any other profession or trade. It offers you a wonderful position, interesting work, and a fine salary. Radio spells SUCCESS.

The National Radio Institute, known the world over as the largest Radio Training Organization, will prepare you quickly in *your spare time at home* to qualify for the position you want. Hundreds of our graduates are to-day reaping big returns from their instructions. Some of them are radio inspectors and engineers. Others are in charge of land and sea stations. Still others are in charge of radio departments in stores or are in business for themselves.

## Big Money — Easy Work

Most of our graduates when they started our course, knew little or nothing about Radio. Yet, in a few short months, our instruction qualified them to earn big money as Certified Radio-tricians. The same instruction, the same help that brought quick success to these men, is now offered to you. You have the same opportunities, you have the same prospect they had. Take advantage of them. Get into Radio NOW. Grow up with it. Advance with it.

## Send for FREE Book

We have just prepared a wonderful book which is filled with the latest information about

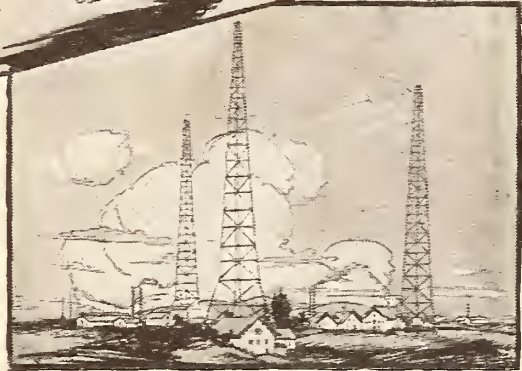

## Pick Out the Job You Want. We Will Help You Get It.

**Brief list of the positions in the radio field to-day and the salaries paid.**

- Broadcasting Station Operator, \$125 to \$250 a month.
- Commercial Land Station Operator, \$150 a month and up.
- First-Class Ship Operator, \$105 a month in addition to all expenses paid.
- Radio Engineer, up to \$10,000 a year.
- Radio Inspector, \$1,800 to \$4,500 a year.
- Radio Salesman, \$2,000 to \$10,000 a year.
- Radio Mechanic, \$1,500 to \$4,000 a year.
- Radio Instructor, \$150 to \$250 a month.
- Radio Draftsman, \$7 to \$15 a day.
- Radio Executives up to \$10,000 a year.

the wonderful opportunities in this newest and fastest growing profession. It will be sent to you absolutely FREE. Send for this book. It will tell you all about how we prepare you for, and help you to get or secure the wonderful positions open in this fascinating field. Mail coupon for this book NOW! National Radio Institute, Dept. 31AB, Washington, D. C.

National Radio Institute, Dept. 31AB, Washington, D. C.

Send me your wonderful book "Rich Rewards in Radio" with full particulars about the opportunities in Radio, and how you will quickly train me in my spare time at home to become a Certified Radio-trician. Also tell me how your free Employment Service will help me to a position and particulars of your special short-time offer.

Name..... Age.....  
 Street.....  
 City..... State.....

## WorkRite Neutroformer

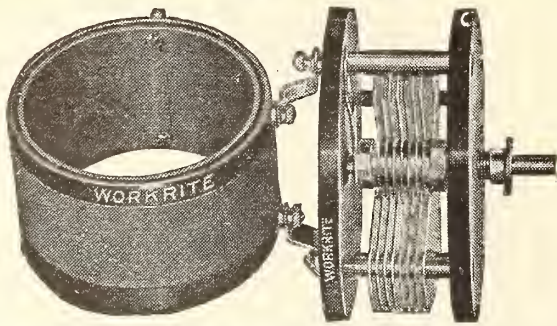

This instrument is made up of one WorkRite Variable Condenser and one WorkRite Neutrodyne Transformer mounted together. Very efficient.

# WORKRITE KIT

New Model 25  
Neutrodyne

(Licensed under Hazeltine Patent No. 1450080)

The Kit you want for your Neutrodyne Receiving Set. All parts are latest design and guaranteed to give best results. This Kit is packed in a most attractive box. The following parts are included in it.

3 WorkRite Neutroformers  
(New design)

2 WorkRite Neutrodons  
(New style)

3 WorkRite E-Z-Tune Dials  
Panel Layout and complete instructions.

# \$25.00

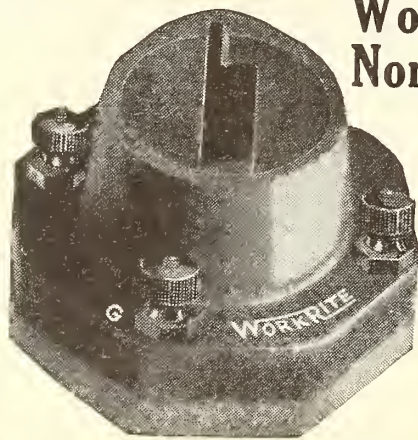

## WorkRite Nonmicrophonic Sockets

These Sockets are made with a sponge rubber base which prevents ringing in the set due to jarring the tubes. Very attractive and efficient.

No. 199 for Uv199 and C299 Tubes 75c

No. 200 for all regular tubes 90c

No. 200 Panel Mounted \$1.15

## OTHER WORKRITE RADIO PARTS

- WorkRite Super Variometer - - \$3.50
- WorkRite 180° Super Variocoupler 3.50
- WorkRite Vernier Rheostat - - 1.00
- WorkRite Hydrometer - - - - .75
- WorkRite Resistance Cartridge - .40

Send for our complete catalogue and then you will be sure to use all WorkRite Parts for your set.

Thousands of Radio Fans testify to the truth of our slogan;

"WorkRite Radio Parts WorkRite" ★

THE WORKRITE MANUFACTURING CO.  
1823 E. 22nd St. Cleveland, Ohio

INSURE  
CLEAR, SILENT OPERATION.  
DISTORTIONLESS RECEPTION

DAVEN RADIO  
PRECISION  
RESISTANCE  
UNITS

ACCURACY GUARANTEED  
INDIVIDUALLY TESTED  
MOISTURE PROOF  
CONSTANT IN VALUE

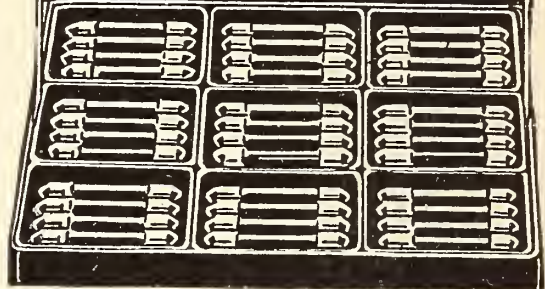

## PRECISION RESISTANCE UNITS

Amateurs and Radio Engineers who have experimented in the building of Radio Receiving Sets have found that the RADIO RESISTANCE UNITS are unexcelled. They positively insure quietness and pure tone reception—for satisfaction sake try one and note the difference in the purity of the tone reception in your Radio Outfit.

If your Dealer cannot supply you, write

THE DAVEN RADIO COMPANY

RADIO RESISTOR SPECIALISTS

144 Bleecker Street

Newark, N. J.

# EDSON

Tone Tested  
Radio Headsets

\$3  
POST PAID

2000  
OR  
3000  
OHMS

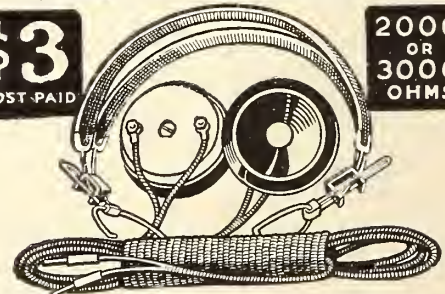

THE lowest-priced first quality headset on the market today. Compare with headsets costing twice our price. Return ours if not satisfied. Our written guarantee protects you. Send \$3 by registered mail or money order. Buy direct of us and save the difference. We ship postage prepaid, same day order is received. Ask for our

Free Catalogue of Radio Parts  
EDSON RADIO SALES CO.

1 Elmwood

Providence, R. I.

# Reduce Tubes by Half With Erla Synchronizing Transformers

Vacuum Tubes  
in ERLA Duo  
Reflex Circuits

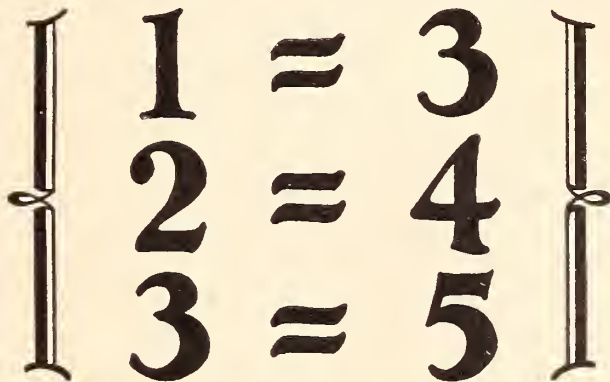

Vacuum Tubes  
as Ordinarily  
Employed —

## Nation Wide Loud Speaker Reception With Only Three Tubes

Greater range and volume with fewer tubes than ever before are attained through Erla Duo-Reflex circuits, using Erla synchronizing radio and audio transformers.

In Erla circuits, tubes do triple duty, as simultaneous amplifiers of received radio frequency, reflexed radio frequency, and reflexed audio frequency currents. Through accurate superimposition of currents identical in phase and frequency, by means of Erla synchronizing transformers, this triple function is flawlessly performed, resulting in tremendously magnified amplification without distortion.

Even one tube provides excellent loud speaker reception over a wide range; two tubes blanket the zone ordinarily covered by four, while three tubes bring in stations on the loud speaker from coast to coast.

Other notable improvements, contributing vitally to the superiority of Duo-Reflex circuits, are the Erla fixed crystal rectifier and Erla tested capacity condensers. Combining advanced characteristics for reflex work with unduplicated uniformity, they are indispensable to complete stability and purity of reproduction.

Detailed diagrams and descriptions of Erla Duo-Reflex circuits are presented in Erla Bulletin No. 16. Ask your dealer, or write, giving your dealer's name.

★ **Electrical Research Laboratories**  
Dept. B 2515 Michigan Avenue, Chicago

# ERLA



Increased amplification and elimination of distortion inevitably follow installation of Erla transformers. Reflex and cascade types. \$5



Crystal troubles vanish on installing an Erla rectifier. No adjustment required. Proof against jolt and jar. Lasts indefinitely. List \$1



Look for the words "tested capacity," found exclusively on the labels of Erla fixed condensers. Made in eleven sizes, 35c to 75c ea.



Erla audio transformers add tremendously to the purity and volume of any receiving unit in which they are used. Ratios 3½ and 6 to 1. \$5

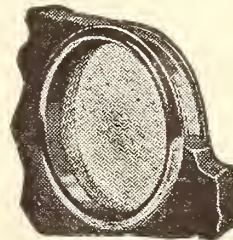

Screen unsightly openings for tube ventilation with Erla bezels, made in 1" and 1½" sizes, in bright nickel or dull enamel. List, 20c

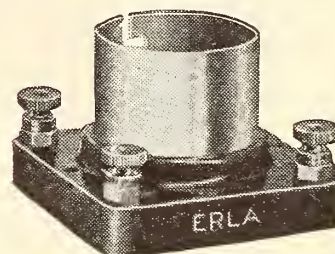

Erla sockets combine maximum beauty and strength, with heavy, nickered shell cast into moulded Bakelite base. Many other advantages. 75c

## LEARN THE CODE AT HOME with the OMNIGRAPH

"Just Listen — The Omnigraph will do the teaching"

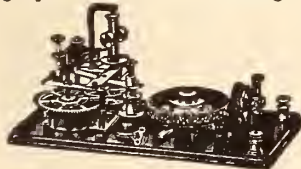

THE OMNIGRAPH Automatic Transmitter will teach you both the Wireless and Morse Codes—right in your own home—quickly, easily and inexpensively. Connected with Buzzer, Buzzer and Phone or to Sounder, it will send you unlimited messages at any speed, from 5 to 50 words a minute.

THE OMNIGRAPH is not an experiment. For more than 15 years, it has been sold all over the world with a money back guarantee. The OMNIGRAPH is used by several Depts. of the U. S. Govt.—in fact, the Dept. of Commerce uses the OMNIGRAPH to test all applicants applying for a Radio license. The OMNIGRAPH has been successfully adopted by the leading Universities, Colleges and Radio Schools.

★ Send for FREE Catalogue describing three models, \$14 to \$30. DO IT TO-DAY.  
**THE OMNIGRAPH MFG. CO., 16K Hudson St., New York City**

If you own a Radio Phone set and don't know the code—you are missing most of the fun

★ Tested and approved by RADIO BROADCAST ★

**WEIGHS  
ONLY  
8 OZ**



**A \$200,000.00 COMPANY**  
stands squarely back  
of the guarantee on  
every *Scientific* headset

**SEND NO MONEY!**

**20,000 TURNS  
EQUIVALENT TO  
3,000 OHMS**

**Order TODAY  
by Postcard  
and Pay  
Postman  
on arrival**

**\$2.95**  
**POST-PAID**

**THE  
PHONE  
IT  
TOOK  
A SOLID YEAR  
TO DESIGN**

**LOUD  
SPEAKER  
UNIT \$1.95**

**We Guarantee** The *Scientific* Headset to be the greatest value on the market. Try it for five days. If not satisfactory send it back and your money will be refunded immediately. Circular on request. Dealers wanted.

**THE SCIENTIFIC ELECTRIC WORKS**  
98 Brookline Ave. DEPT. 1 BOSTON, MASS.

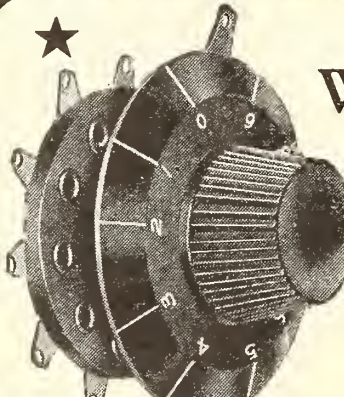

The New  
**WALNART**  
Inductance  
Switch

List Price **\$1.25**  
Complete with Dial

Only with positive contacts can you get good reception. Switch points are unsightly and the contacts are poor. A Walnart Inductance Switch, 1-10 points, gives positive contact and better reception. Bakelite numbered dial shows exact position at all times.

Both instruments have Condensite CeloroN bases the perfect dielectric insulation.  
(Made under Bakelite patents).

**WALNART**  
Variable Grid  
Resistance

List Price **\$1.00**

Gets the best results from every tube. Cleans up hissing and brings in signals clear and strong. Nothing to wear out, lasts a life time.



**WALNART ELECTRIC MFG. CO.**

1249 W. Van Buren St. Dept. 305 Chicago

**"WHERE I GO BY RADIO"**

**NEW**, Original, Handy and Complete Radio book for Easily Recording for Reference When, Where and How You "listen in," and what You Hear. Makes Immediate Hit. List All Stations, corrected to November 15, 1923.

**SPECIAL OFFER**—2 Copies Popular Edition, \$1.00; One Holiday Edition, \$1.00, or all three **ONLY \$1.75** Start New Year Right. Keep accurate permanent records, and have real satisfaction.

**RADIO BROADCAST DEPARTMENT**  
PROGRESS PRESS, Union, South Carolina, U. S. A.



**CARTER**  
**"HOLD-TITE"**  
JACK

CODE NO. 101

Phosphor-Bronze Springs. Westinghouse "Micarta" insulation. Pure silver contact points. Ask your dealer. Write for catalogue.

**Carter Radio Co.**

1806 Republic Bldg., CHICAGO

"3,000  
mile"



RADIO "B" BATTERIES

At Factory Prices

Greatest radio "B" battery on market. Full number voltage taps; Quality Guaranteed; Lowest Prices; brings in concerts Louder and Stronger; will work on any tube or loud speaker. Order by number TO-DAY with check, money order or pay postman C. O. D.

No. 722B 22½ volt variable, regularly \$2.25	\$1.52
No. 722A 22½ volt variable, regularly \$3.00	1.85
No. 745A 45 volt, 8 taps, regularly \$5.50	3.25

AYRES BATTERY CORPORATION, Cincinnati, Ohio



**An Absolute Guarantee**  
with every instrument  
*made them famous!*

**SHAMROCK**  
FOR SELECTIVE TUNING

**180°**

**Vario-Coupler**

*list price,*

**\$3<sup>50</sup>**  
*each*

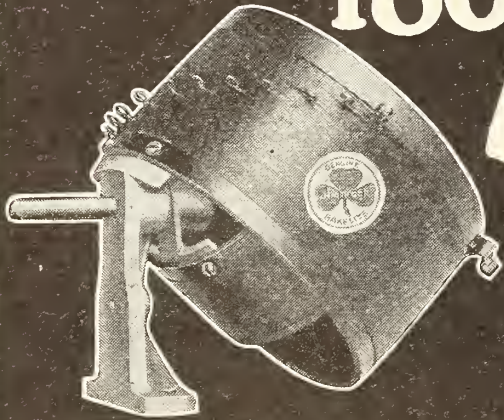

**DOUBLE  
DUTY  
PIG-TAIL**

**Variometer**

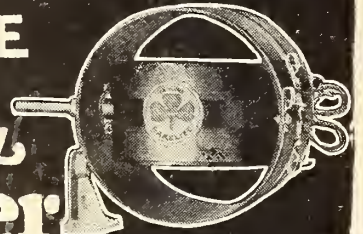

**SHAMROCK MFG. CO.**  
316 E. Market St. ~ Newark N.J.

**KC MOULDED  
MIDGETS**

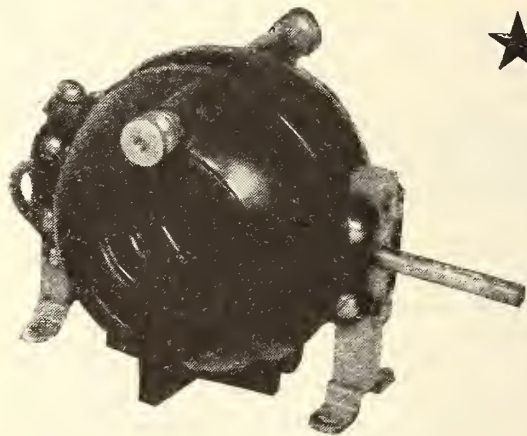
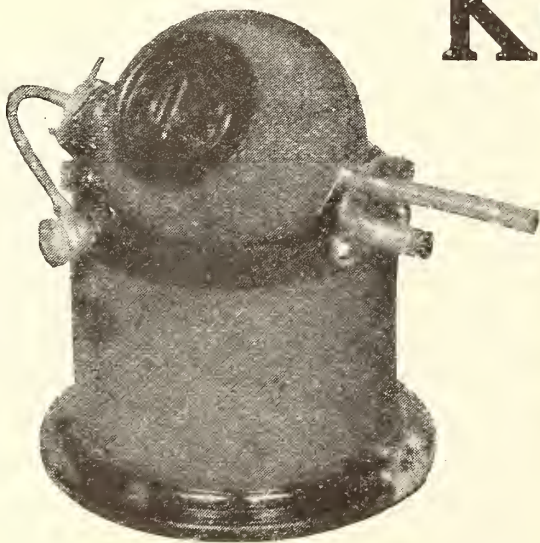

Moulded in high-grade Bakelite. Double-covered, green silk windings. Flexible braid connections to rotors. Windings designed for minimum capacity. Wavelength 100-700 meters with .0005 mfd. cond.

**VARIOCOUPLER**

Prim. Induct. 327 M. H.  
Sec. Induct. 228 M. H.

**\$5.<sup>50</sup>**

Dimensions 4" high x 3½" x 4½"

**VARIOMETER**

Max. Inductance 556 M. H.

**\$6.**

Dimensions 3" high x 3" x 4½"

**KILBOURNE & CLARK MANUFACTURING CO.**

Head Office and Works, Seattle, Washington

**BRANCH OFFICES:**

Portland, 305 Larrabee St. Phone East 6156  
San Francisco, 591 Mission St. Phone Sutter 40

Los Angeles, 1103 W. 10th St. Phone 581-002  
New York City, Repr. Steelman, Inc. 24 Murray St.

★ Tested and approved by RADIO BROADCAST ★

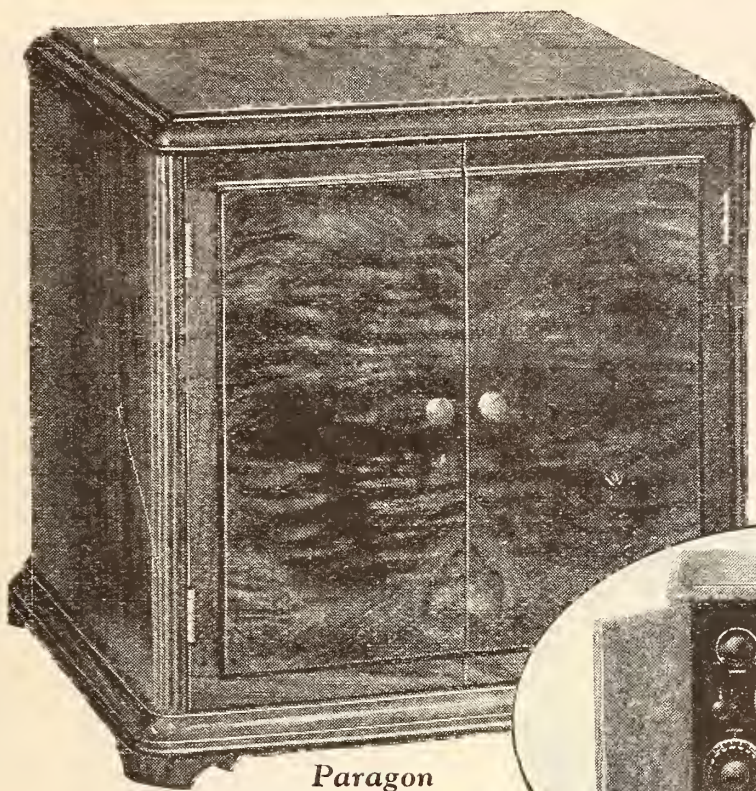

Paragon  
Model III \$175.00

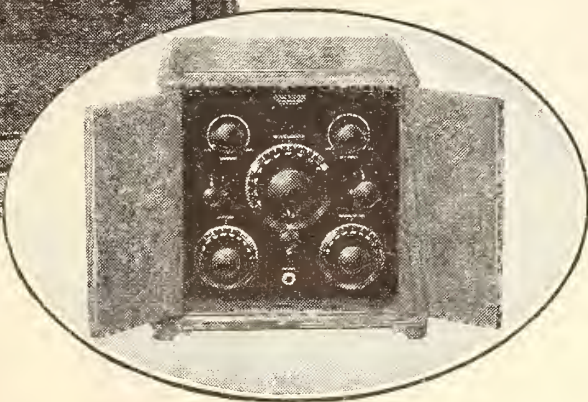

## The Last Word In a Paragon Receiver for the Home

At last—a radio set that not only harmonizes with your furniture but adds to the attractiveness of any room in which it is placed. And not an ordinary radio set but a PARAGON.

Paragon Receivers are famous for the long distance records they hold which include the reception of the first trans-continental amateur message and the first trans-Atlantic message. It is a Paragon that keeps the world in touch with the MacMillan Expedition, frozen in north of Greenland.

Paragon Receivers, because of their superior selectivity and sensitivity, are equally famous for the ease with which they can be operated and the clear results obtainable.

The Model III, pictured above, has all the advantages of the other models but is housed in a mahogany or burl walnut cabinet which is a work of art.

In appearance, the Paragon Model III Receiver now matches up in every way to the perfection of the instrument itself.

*Write for illustrated catalog of Paragon Radio Parts*

*Dealers:* We believe in the proper distribution of Paragon Radio Products. Our Exclusive Distributors are particularly interested in territorially protected dealers, who will concentrate, solicit and serve the consumer in the sale of Paragon Radio Receivers. If interested, write us for details.

ADAMS-MORGAN CO., 10 Alvin Avenue, Upper Montclair, N. J.



# PARAGON

Reg. U. S. Pat. Off.

## 3-CIRCUIT RECEIVER



### The De Forest Audion

is commended on Jack Binns' Radio Page of the New York Tribune as "an excellent tube around which to build a set." Such expert endorsement and the satisfaction of thousands of users of De Forest Audions is what you naturally expect from this product. Remember that De Forest invented the three-electrode vacuum tube which makes all present-day radio possible. ★

**DE FOREST RADIO  
TEL. & TEL. CO.**  
Dept. R.B. 7 Jersey City, N. J.

Use  
**De Forest  
Audions**

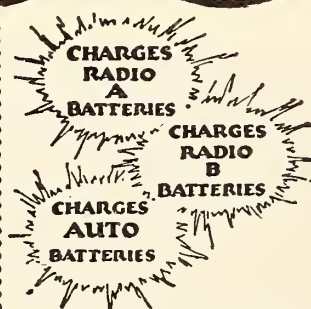

## Triple Duty

The type A-B, F-F Battery Charger charges up to 120 volts on "B" battery as well as 2, 4 or 6 volt "A" or auto battery.

No fuss or trouble—anyone can operate successfully. Simple and Fool proof. The pioneer battery charger—a success for over ten years. Type A-B, price \$20, West of Rockies \$22; Type 6 for "A" battery or auto battery charging \$15, West of Rockies \$16; B battery charging attachment \$2.50 extra.

Write for literature with data on battery maintenance, station calls and wiring diagrams of basement installation of batteries. Send name of nearest dealer.

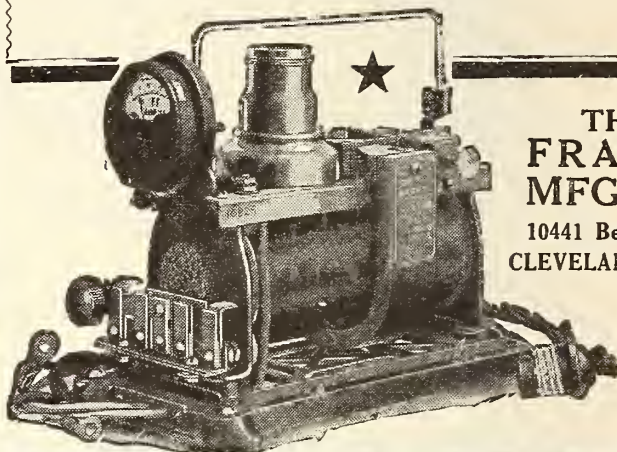

**THE  
FRANCE  
MFG. CO.**  
10441 Berea Road  
CLEVELAND, OHIO

### A Pleasant Surprise Awaits the User of the A. C. H. Sharp Tuner Dials

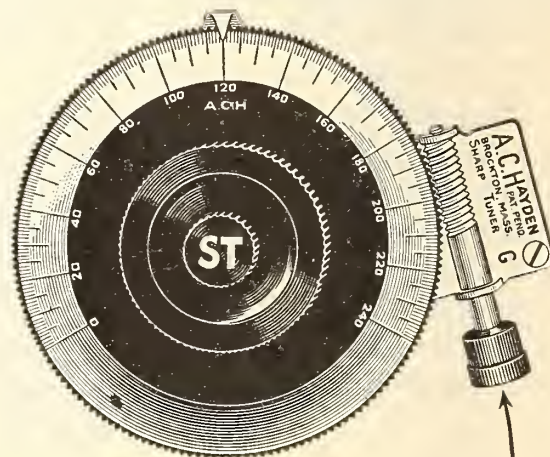

#### Why the A.C.H. is different

3 in. DIAL → A.C.H. → 156-10-1  
4 in. DIAL → A.C.H. → 215-10-1

Will improve any receiving set, making difficult tuning easy

#### Money Back Guarantee

Price 3-inch size.....\$2.50 Price 4-inch size..... \$5.00  
Regular fitting 5/16 shaft. 1/4 and 3/16.....5c each extra

#### Extra Advantage of the A C H

1. Can be attached or removed from any instrument.
2. Rough tuning same as any dial.
3. Movement so fine that the eye cannot detect but the ear can.
4. Automatically locks instrument so no jar can disturb it.
5. Dial grounded reducing the body capacity to a minimum.
6. Special dial 2 graduations where ordinarily one. ★

MAIL ORDERS SENT PREPAID IN U. S. A.

**A. C. HAYDEN RADIO & RESEARCH CO.**  
BROCKTON, MASS., U. S. A.



# To get best results with low-voltage tubes

**F**OR perfect clearness you must use a storage battery with uniform current. This is particularly true if you are a fan for long distance. When signals are weak the steadiness of a dependable A storage battery is indispensable to good receiving.

There are two tiny but sturdy Exide A Batteries designed specially for WD-11 and UV-199 vacuum tubes, and they give fine service with any low-voltage tubes.

You can carry one of these little batteries in the palm of your hand, yet they are powerful enough for long-distance receiving and have the true Exide ruggedness built into them.

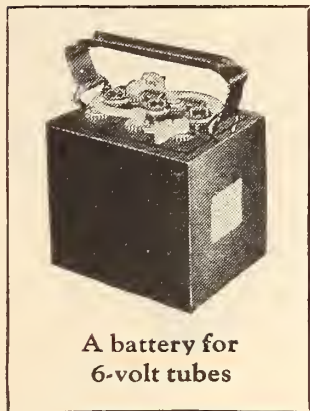

A battery for  
6-volt tubes

## Three sizes of A batteries

The 2-volt battery has a single cell and weighs five pounds. It will heat

the filament of a WD11 or other quarter-ampere tube for approximately 96 hours. The 4-volt battery has two cells, weighs six pounds and will light the filament of a UV-199 tube for 200 hours.

## A battery with a pedigree

The Exide A Battery for 6-volt tubes is made in four sizes, of 25, 50, 100 and 150 ampere-hour capacities. These batteries have extra-heavy plates, assuring constant voltage and uniform current over a long period of discharge.

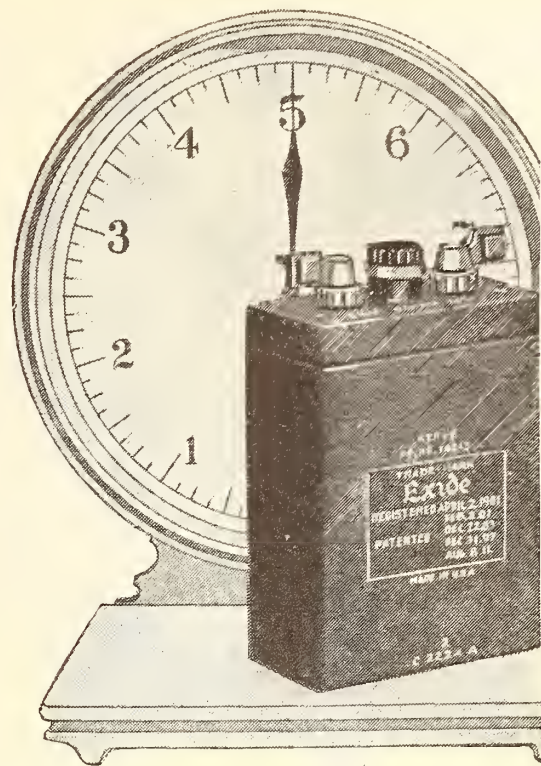

This 2-volt A Exide Storage Battery  
weighs only five pounds

A good storage battery does not just happen. It is the result of long experience. The skill acquired and the resources developed in making batteries for every purpose since the beginning of the storage battery industry thirty-five years ago are built into the Exide Batteries made specially for your radio.

Wherever batteries *must* be reliable—such as on submarines, in the telephone system, in firing the guns of our battleships, in the central power stations of our great cities—there you will find Exides doing their unfailing duty. A majority of all government and commercial radio plants are equipped with Exide Batteries.

Exide Radio Batteries are sold by radio dealers and Exide Service Stations everywhere. Ask the dealer, or write direct to us, for booklets describing the complete line of Exide Radio Batteries.

# Exide

RADIO BATTERIES

THE ELECTRIC STORAGE BATTERY COMPANY, PHILADELPHIA

Manufactured in Canada by Exide Batteries of Canada, Limited, 133-157 Dufferin Street, Toronto

★ Tested and approved by RADIO BROADCAST ★

# New Equipment

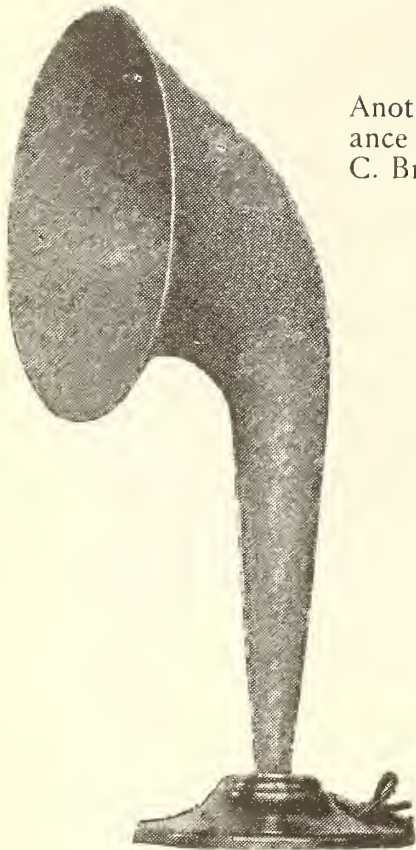

## BRANDES TABLE-TALKER

Another loud speaker. Neat in appearance and very satisfactory in operation. C. Brandes, Inc., 237 Lafayette St., New York City. Price \$10

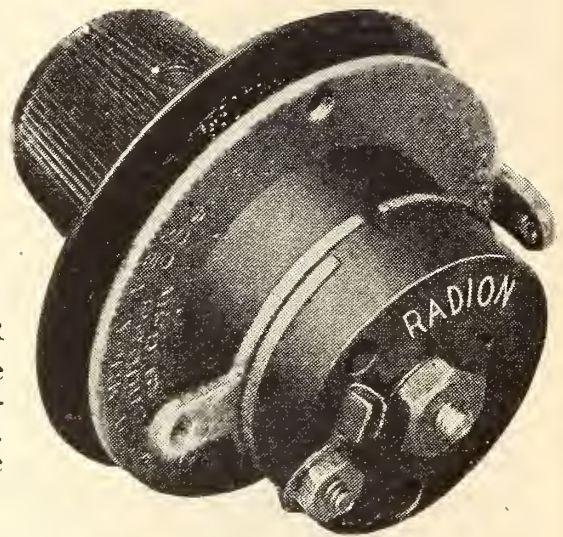

## AMSCO COMPENSATING CONDENSER

A very efficient means of neutralizing the tube capacity in R. F. amplifiers, also eliminates the necessity for a potentiometer. Amsco Products, Inc., Broome & Lafayette Sts., New York City



## CARTER JACK SWITCH

One of the many types made to serve various purposes. The switch illustrated closes two contacts and may be used to cut in a second headset, also for adding a second cell in parallel. Carter Radio Co., 209 S. State St., Chicago, Ill.

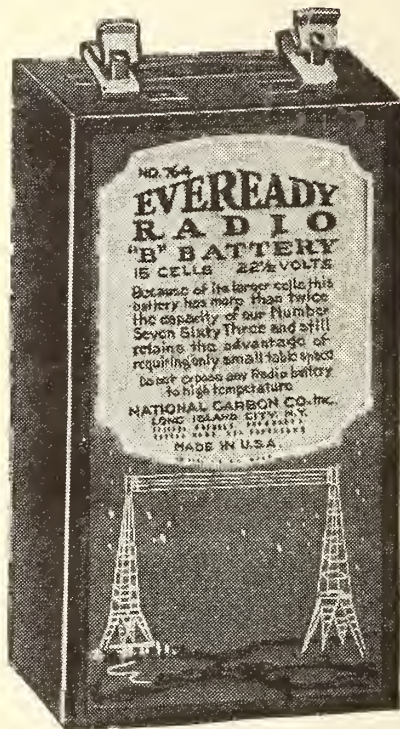

## EVEREADY "SKYSCRAPER" B BATTERY

A new development in B batteries which allows larger capacity for the small space it requires. National Carbon Company, Inc., Long Island City, New York. Price \$2.25

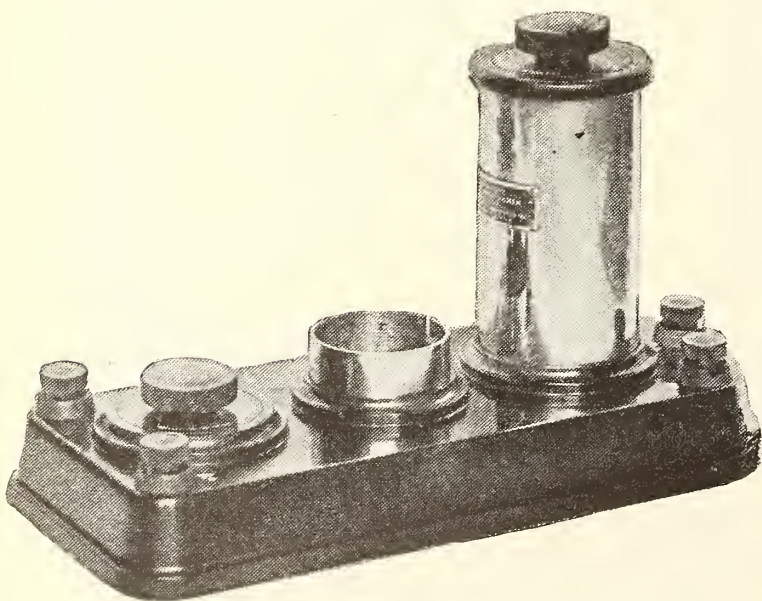

## RADIO FREQUENCY AMPLIFIER UNIT

The Model 5 Ballantine R. F. Amplifier Unit. A very compact and efficient unit comprising the variotransformer, tube socket and rheostat wired to make a complete stage of R. F. amplification. Boonton Rubber Mfg. Co., Boonton, New Jersey. Price \$15

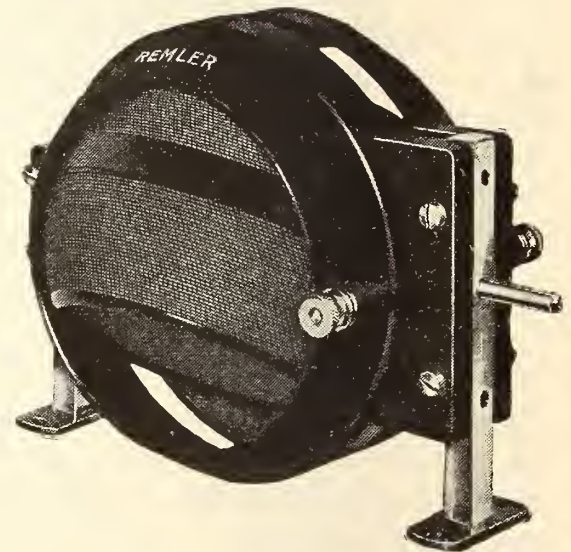

## REMLER VARIOMETER

Made by the Remler Radio Mfg. Co. It has a fairly wide wavelength range, is ruggedly built, and may be used for either panel or table mounting. Price \$7.50

# BAKELITE

TRADE MARK REG. U. S. PAT. OFF.

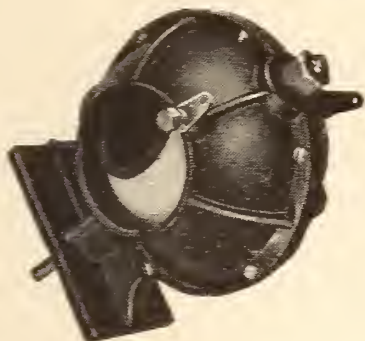
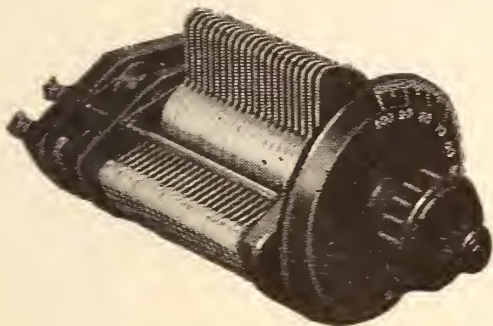
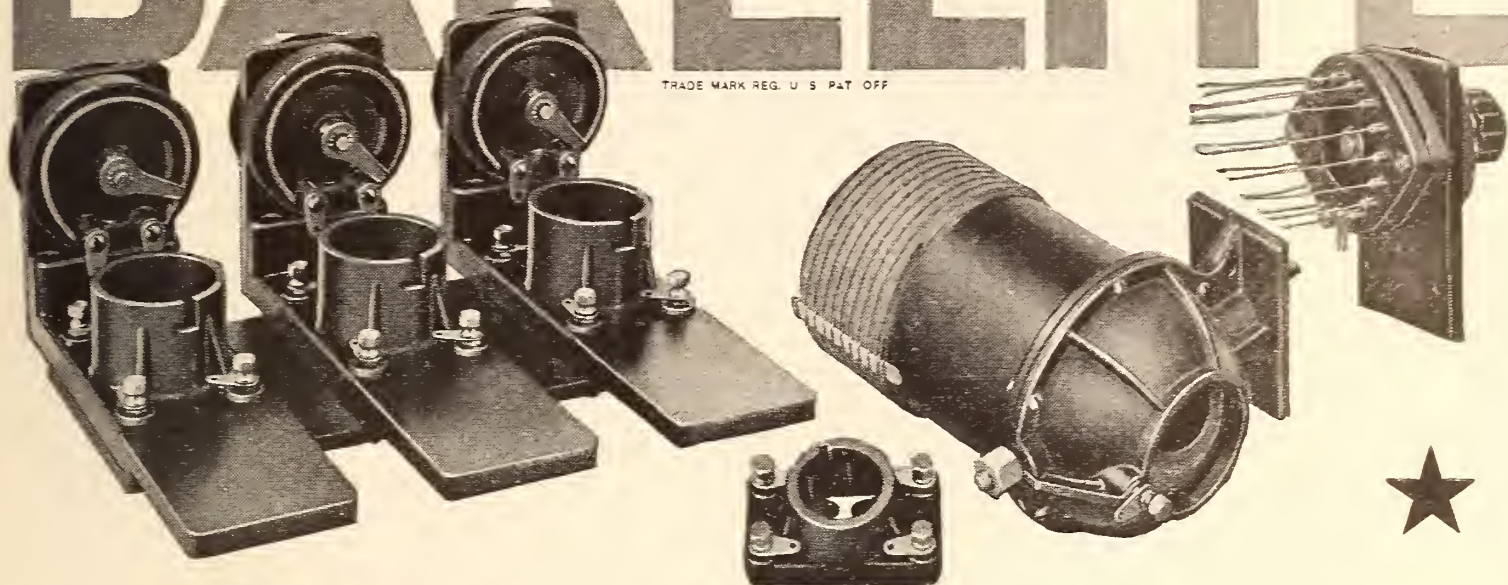

## Gilfillan and Bakelite

All the molded insulation of these Gilfillan radio parts is 100% Bakelite.

In the words of the manufacturer, BAKELITE "insures positive insulation and absolute permanency." And that's the story in a nutshell.

Nothing else equals Bakelite in the combination of all its desirable properties such as insulation resistance, mechanical strength, permanence of color and indifference to all weather conditions.

The outstanding merit of Bakelite is its durability—its freedom from deterioration.

Every day, radio men are finding new applications for this "Material of a Thousand Uses," for parts made of molded or laminated Bakelite possess properties that successfully meet the most exacting demands of radio work.

Write for a copy of our Radio Booklet R.

### Send for Our Radio Map

Enclose 10c to cover mailing cost and we will send you a large Radio Map which lists the call letters, wave length, and location of every broadcasting station in the world.  
Address Map Department.

## BAKELITE CORPORATION

247 Park Avenue, New York, N. Y.  
Chicago Office: 636 West 22d Street

**BAKELITE**  
**Condensite**  
*REDMANOL*

are the registered  
Trade Marks for the  
Phenol Resin Products  
manufactured under  
patents owned by

**BAKELITE**  
**CORPORATION**

---

THE MATERIAL OF A THOUSAND USES

---

★ Tested and approved by RADIO BROADCAST ★

“THE AIR IS FULL OF THINGS YOU SHOULDN'T MISS”

★ **EVEREADY**  
**Radio Batteries**  
*- they last longer*

*The radio dry cell triumphant*

For economical, satisfactory radio, light the filaments of your dry cell tubes with the Eveready Dry Cell Radio “A” Battery. Will unfailingly outlast any other at 1/8 ampere current. Full instructions for getting this Economical Eighth, on labels and in our booklets. This battery will exceed your expectations in economy and performance.

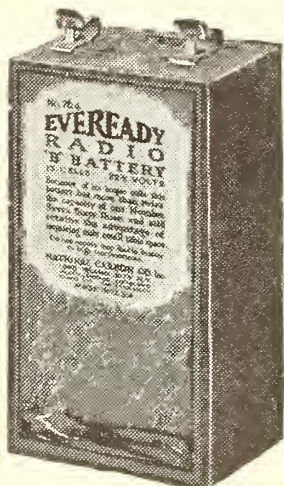
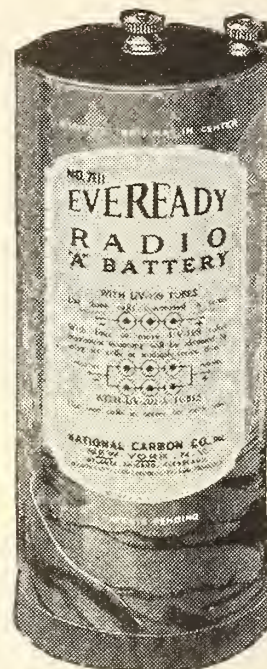

*Equal to all demands*

Power flows from your “B” Battery, power that gives life to your head-phones or loud speaker. Some tubes draw more “B” Battery current than others, but whatever the tube or tubes you use, Eveready “B” Batteries will give you maximum results. Eveready “B” Batteries are made in six sizes, for all possible uses. Always use the biggest possible battery, for it contains more energy in proportion to cost, and lasts longer. Where table space is limited, use the compact vertical 22½-volt “B” Battery No. 764. Its power is packed in small space.

*This battery is a wonder worker*

Eveready’s biggest contribution to economical and more satisfying radio is the Eveready “C” Battery, a triple-use, universal battery. It will make the loud speaker respond with a new fullness and naturalness of tone, and save much money by making the “B” Battery last still longer. Connect it with the grids of audio frequency amplifiers and notice the big difference. Can also be used as an “A” Battery for 199-type tubes in portable sets, and as a “B” Battery booster. Eveready Radio Battery No. 771—use it!



' 'THE AIR IS FULL OF THINGS YOU SHOULDN'T MISS' '

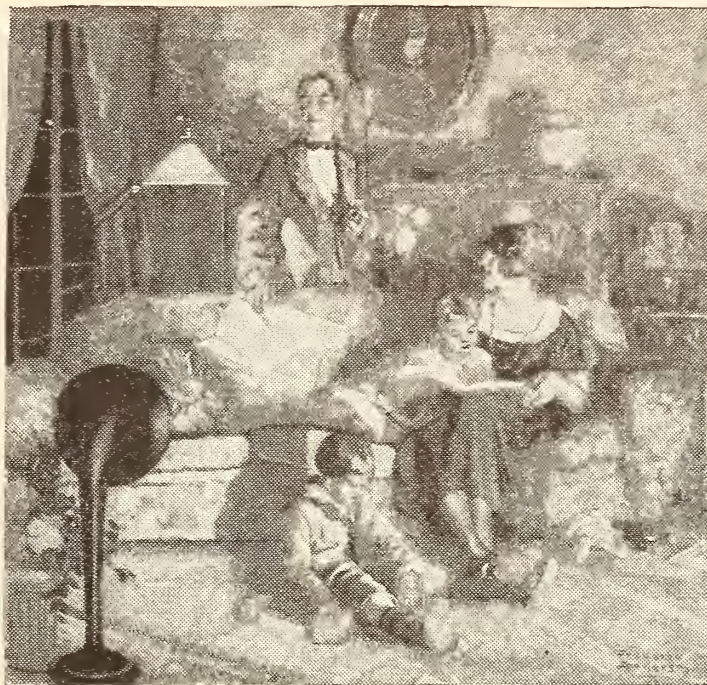

## Eveready gives you the right battery for every radio use!

**E**ACH Eveready Radio Battery represents thirty years of battery building experience. Each Eveready Battery represents millions of dollars invested in men, methods and machinery. Overseeing Eveready production is the greatest battery laboratory known to science, where every particle of raw material is required to pass Eveready's exacting tests. To insure Eveready serviceability, batches of Eveready Batteries are constantly being set aside for performance tests. And, finally, daily shipments keep dealers supplied with fresh Eveready Batteries, packed full of power.

To be certain of battery satisfaction, insist on Eveready Radio Batteries—they last longer.

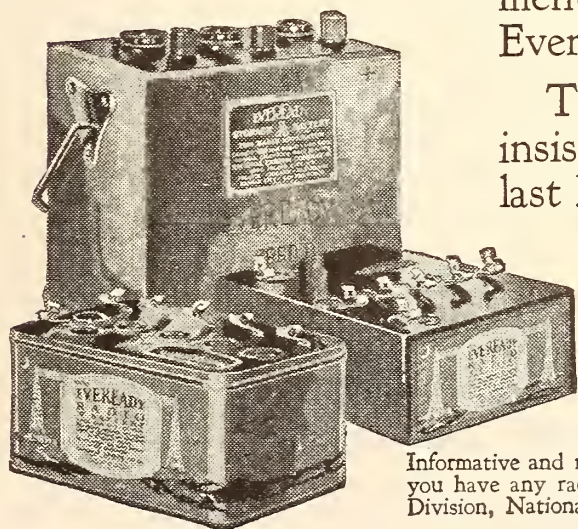

NATIONAL CARBON COMPANY, Inc.

New York San Francisco

Headquarters for Radio Battery Information

CANADIAN NATIONAL CARBON CO., Limited

Factory and Offices: Toronto, Ontario

Informative and money-saving booklets on radio batteries sent free on request. If you have any radio battery problems, write to G. C. Furness, Manager, Radio Division, National Carbon Co., Inc., 126 Thompson Ave., Long Island City, N. Y.

Morrison

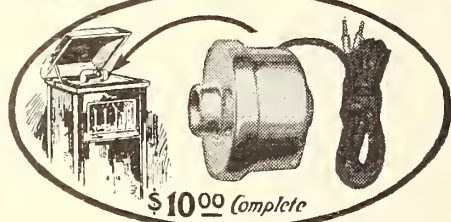

Loud Speaker

Use Your  
Phonograph  
For Radio

To really enjoy radio you require a loud speaker that reproduces all broadcasting in full volume with rattle, vibration, and distortion eliminated. Your phonograph has a sound-box that cannot be excelled. So attach a Morrison Loud Speaker to the tone-arm of your phonograph and you have a perfect combination—a scientifically developed loud speaking unit reproducing Radio's wonderful concerts through your phonograph's incomparable sound-box. It is the refinement of radio enjoyment.

A little dial on the Morrison enables you to adjust the tone, soft or loud, to suit your taste. Further than that, Morrison is fool-proof—requires no technical skill nor constant adjustment to operate.

This remarkable loud speaker complete with a 5-foot cord costs only

**\$10.00**

Nickel-Plated Model

Every Morrison Loud Speaker is sold on a satisfaction or money-back guarantee.

*Our 2 color catalogue describes Morrison fully—we would like to send you one free*

Dealers

Our merchandising plan to help you sell Morrison Loud Speakers assures you a profitable business. Every sale you make brings many more. Let us tell you about this plan.

**Morrison Laboratories Inc.**  
347 Jefferson Ave., E., Detroit, Mich.

Controlled Reception

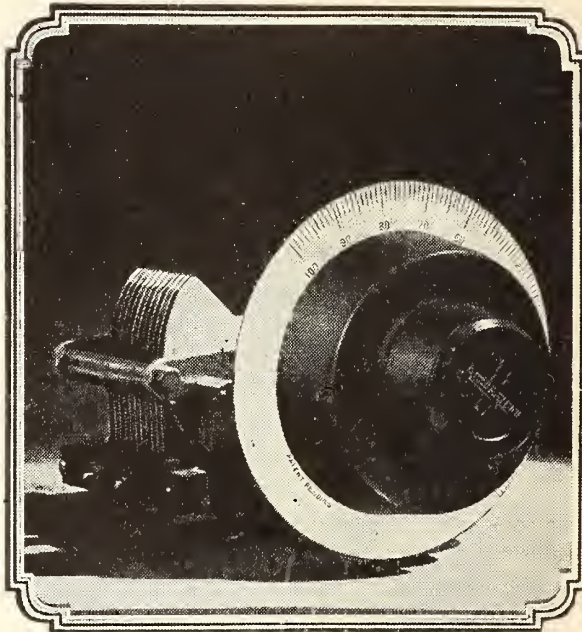

Tune out Local  
Interference

The Accuratune is not a mere dial, but an actual micrometer tuning control ten times more efficient than various tuning devices. With any good condenser, the Accuratune action is so precise that local stations can be tuned out completely, and station after station brought in that you never received before.

Even a person with little knowledge of radio can easily tune a receiver with the precision and accuracy of a radio amateur.

The Accuratune is designed for both coarse and fine tuning without the use of vernier attachments. Fits standard condenser shafts.

This unusual tuning efficiency amply repays you for the slight addition in cost over ordinary dials. Price \$3.50.

THE MYDAR RADIO COMPANY  
9-D Campbell Street Newark, N. J.

**ACCURATUNE**  
MICROMETER  
CONTROL

# More Money for YOU in Radio

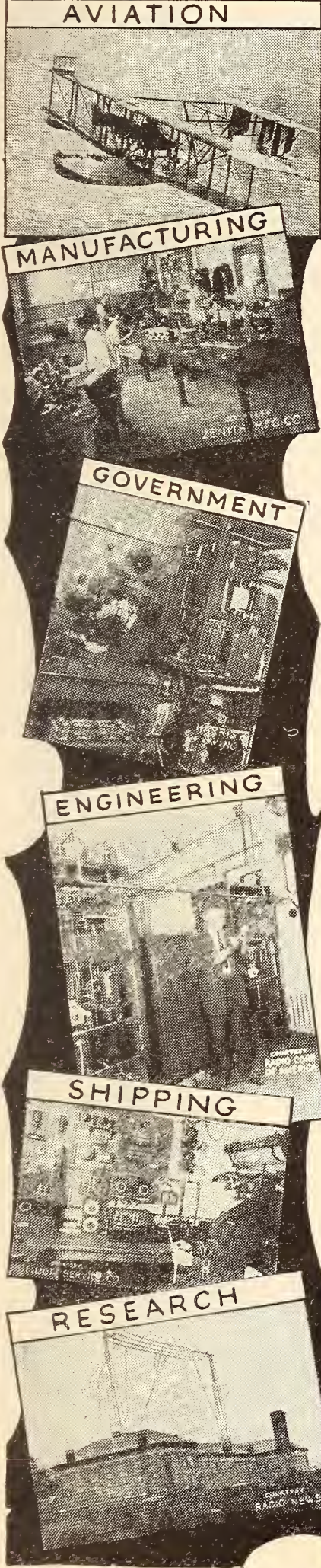

Austin Riu, one of our graduates, is now an operator of broadcasting station PWX of Havana, Cuba, and earns \$250 a month. Merle Wetzel, of Chicago Heights, Ill., another graduate, advanced from lineman to Radio Engineer, increasing his salary about 100 per cent. *even while taking his training!* Emmett Welch of Peculiar, Mo., right after graduating started in Radio, earning \$300 a month and expenses.

Not a week goes by without our receiving urgent calls for our graduates. "We need the services of a competent Radio Engineer"—"We want men with executive ability as well as radio knowledge to become our local managers"—"We require the services of several radio demonstrators"—these extracts of letters from radio firms to us give some indication of the great variety of opportunities open to our graduates!

## Easy to Learn at Home

Are you "cashing in" on your Radio Knowledge? If you're not you are passing up the best bet that has ever come your way. It's entirely up to you. There's nothing impossible in Radio for the man who has the ambition to try. In a few months at home, you can learn Radio. To make your training doubly practical we now include circuits and parts for building the latest receiving sets *absolutely free* with course. With this training you can easily become a *recognized radio expert*—and to these radio specialists, Radio offers remarkable salaries, easy, fascinating work, short hours—and a wonderful future!

## Earn \$2400 to \$10,000 a Year

You can earn bigger pay than you probably ever dreamed possible. Only don't let yourself stay in a rut. Sit up—look up—make up your mind that if others can make big money and big successes in Radio, so can you. The National Radio Institute has a sound practical radio course that defies comparison. It has a record of successful graduates that is unquestionable evidence of its ability to qualify you quickly for a big money position in Radio.

Our Free Book "Rich Rewards in Radio" tells all about the amazing opportunities Radio offers *you*, and describes how you can become a recognized radio expert at home in an astonishingly short time. Now—while your ambition is warm—mail the coupon for this big-money Free Book!

**NATIONAL RADIO INSTITUTE**  
Dept. 31-DA Washington, D. C.

**THIS FREE BOOK**  
Points The Way  
To Your Success



**National Radio Institute**  
Dept. 31-DA  
Washington, D. C.

Without obligation send me your book "Rich Rewards in Radio," and details of your Free Employment Service.

Name.....Age....  
Street.....  
City.....  
State.....

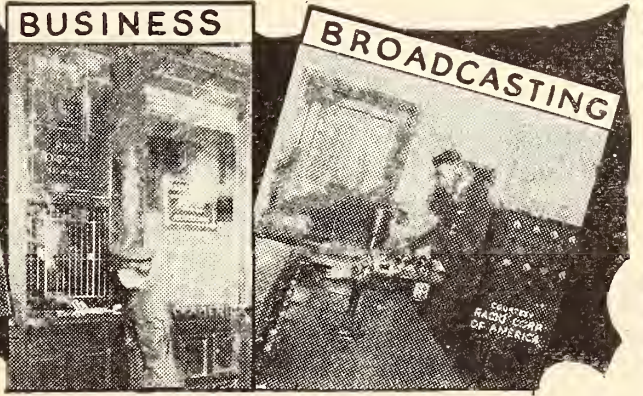

5,000,000 Owners of  
Single Circuit Sets Are  
Waiting to Buy this  
*Copp Vario-Selector*

Price  
\$11.50



Patent  
Applied for

*Because:*

1. *It Will Change* any Single Circuit Set to a Double Circuit Set, without rewiring and without re-building. Simply connects to antenna and ground and it is done.
2. *Eliminates Re-Radiation.* This will be a great boon to Broadcast Stations and to all owners of Broadcast Receiving Sets.
3. *Gives Selectivity* to a Single Circuit Set equal to any three circuit tuner, preserving the Single Circuit simplicity of tuning.

*Note:* The Copp Vario-Selector is *not* a Wave-Trap.

The *Copp Vario-Selector* is sold in a Sealed Cabinet, beautifully finished with engraved bakelite panel, and is guaranteed by us absolutely. Signed guarantee with every instrument. Order from your dealer or direct. Circular on request.

*Jobbers and Dealers write us  
for samples and discounts*

**The A-C ELECTRICAL Mfg. Co.**  
Dayton, Ohio

*Makers of Electrical Devices for Over 20 Years*

*The choice of foremost  
Engineers  
for over 17 years.* ★

Sold by  
all dealers

**BRACH**  
VACUUM  
RADIO PROTECTOR

Approved by the National  
Board of Fire Underwriters

*Ask YOUR Insurance Agent*

L.S. BRACH MFG. CO.,  
Newark ~ New Jersey

**SOLDERALL**  
Metal in Paste Form

Handy Tubes 25¢  
Every Electrical  
Connection Needs  
Solderall for Perfect Reception.  
*The Only Convenient Metal Solder*

**ALL-AMERICAN**  
Amplifying  
**TRANSFORMERS**

- are the largest selling transformers in the world
- are standard on the better sets
- are endorsed by the leading radio engineers
- are recommended by all the better dealers.

Over half a million  
in use and giving  
real satisfaction. ★

**THE BEST  
~ PAY NO  
MORE!**

Audio Freq. 3-1, \$4.50,  
5-1, 10-1, \$4.75. R.F.  
\$4.50. Power \$6 ea.



# Send For This Handy Book Today

*Contains  
Description  
and  
Illustrations  
of all  
Radio Parts*



*Explains  
Functioning  
of the  
Apparatus in  
the Different  
Circuits*

## *This Pocket Size Edition Gives:*

Variable Condenser Capacities — Variometer construction — Illustrations and description of radio symbols. Q Why rheostats should have greater contact surface. Q Advantages of light weight receivers. Q Why Bakelite is the best insulation for radio. Q New and ingenious inductance switch and knob — Defines radio terms — Explains importance of good aerial and ground. Q But — most of all — It shows the beginner, why the highest class apparatus is the most economical and satisfactory — 54 pages of interesting information and illustrations.

THIS BOOK IS FREE



**Write for it today. Address Radio Dept. G.**

**KELLOGG SWITCHBOARD & SUPPLY COMPANY**  
1066 West Adams Street, Chicago, Illinois  
Columbus, Ohio    Kansas City, Mo.    Portland, Ore.    San Francisco, Cal.



# SUPER-HET

The World's Best

*By Performance*

## ADVANTAGES—

**1. UNIFORM EFFICIENCY** over the entire wavelength range of 160 to 850 meters. This means that all stations, Radiophone Broadcasting, Amateur and Commercial within this wavelength range, will be received with maximum intensity. This very desirable feature is not obtainable by any other practical method using Radio Frequency amplification.

**2. SELECTIVITY** by this system, greatly exceeds that obtained in all other methods of reception. Using the Model "C" with a loop in the Suburbs of New York, WOR 15 miles distant, operating on 405 meters, can be completely eliminated, and PWX 1300 miles distant, operating on 400, can be received on a loud speaker. This holds true on an average cool night. There is no telegraphic interference from 200 meter amateur stations or 600 meter ship stations.

**3. SIMPLICITY** to change from one station to another, there are only two dials to vary. The two dials can be calibrated for all the various stations, as there is only one best position for each station.

**4. AMPLIFICATION** is much greater than obtainable in any other standard receiver. Total is as follows: 1st the Heterodyne Amplification in the 1st Detector; 2nd, the Regenerative Amplification in the 1st Detector; 3rd, the 3 stages of Tuned Regenerative Radio Frequency Amplification, working at a low advantageous frequency; 4th, the second Detector action, and 5th, the two stages of low ratio distortionless audio frequency amplification.

**5. RECEIVING RANGE** other factors correct, the receiving range is in proportion to the effective radio frequency amplification applied. As this receiver has much greater effective radio frequency amplification than all others, the range is proportionally greater.

Complete Constructional Blue Prints Consisting of Two Sheets 50x21"

Experimenters Information Service,



WRITE FOR

★ Tested and approved by RADIO BROADCAST ★

# RODYNE

## Radio Receiver

NO OTHER RECEIVER  
CAN EQUAL

“THE ROLLS-ROYCE OF RECEPTION”

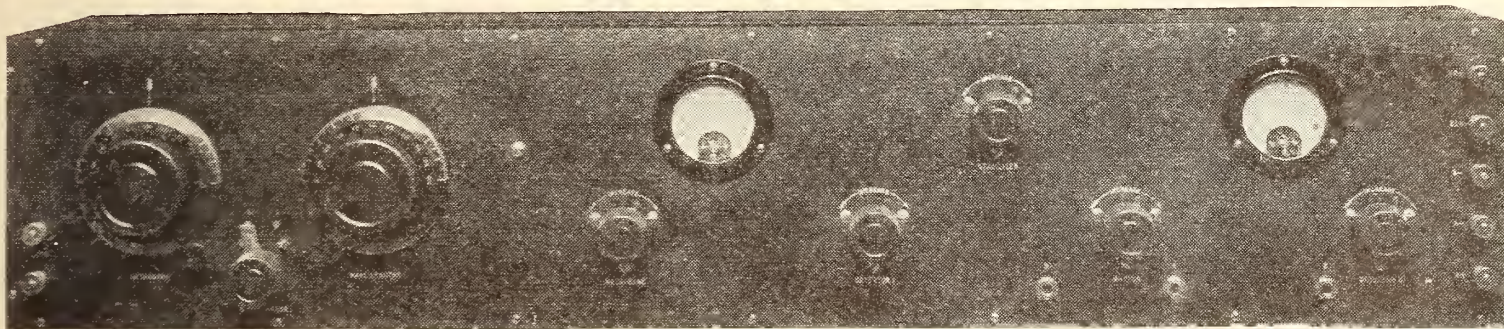

### MODEL “C” SUPER-HETERODYNE

Wavelength Range 160 to 850 meters. Tubes, 2 Detectors, Oscillator, 3 Tuned Radio Frequency Amplifiers, 2 Audio Amplifiers

The Super-Heterodyne is the most efficient method of short wave radio frequency amplification known. It is used extensively by the Commercial radio companies and various governments, when it is necessary to receive over extremely long distances without interference from near-by stations.

The remarkable results are due to the Super-Heterodyne action, which is briefly as follows: the incoming signal, which may be any wave from 160 to 850, is changed through the use of a local oscillator, to a wavelength of 10,000 meters. At this wavelength an exact duplicate of the original signal is amplified at radio frequency with the very highest efficiency possible, rectified and amplified at audio frequency.

During this change a very high degree of selectivity is secured, due to the amplifier, which is designed to pass nothing but 10,000 meters. Accordingly while there may be ten or more signals in the loop, only one will be received at a time, the one that the oscillator heterodynes through the amplifier.

and Two Sheets 27x21", Our Numbers 30141-145. \$2.00 Postpaid

*Designers of the Highest Class Radio Apparatus in the World*  
531 West 46th Street NEW YORK CITY  
CATALOGUE No. 32

# Quality Amplification

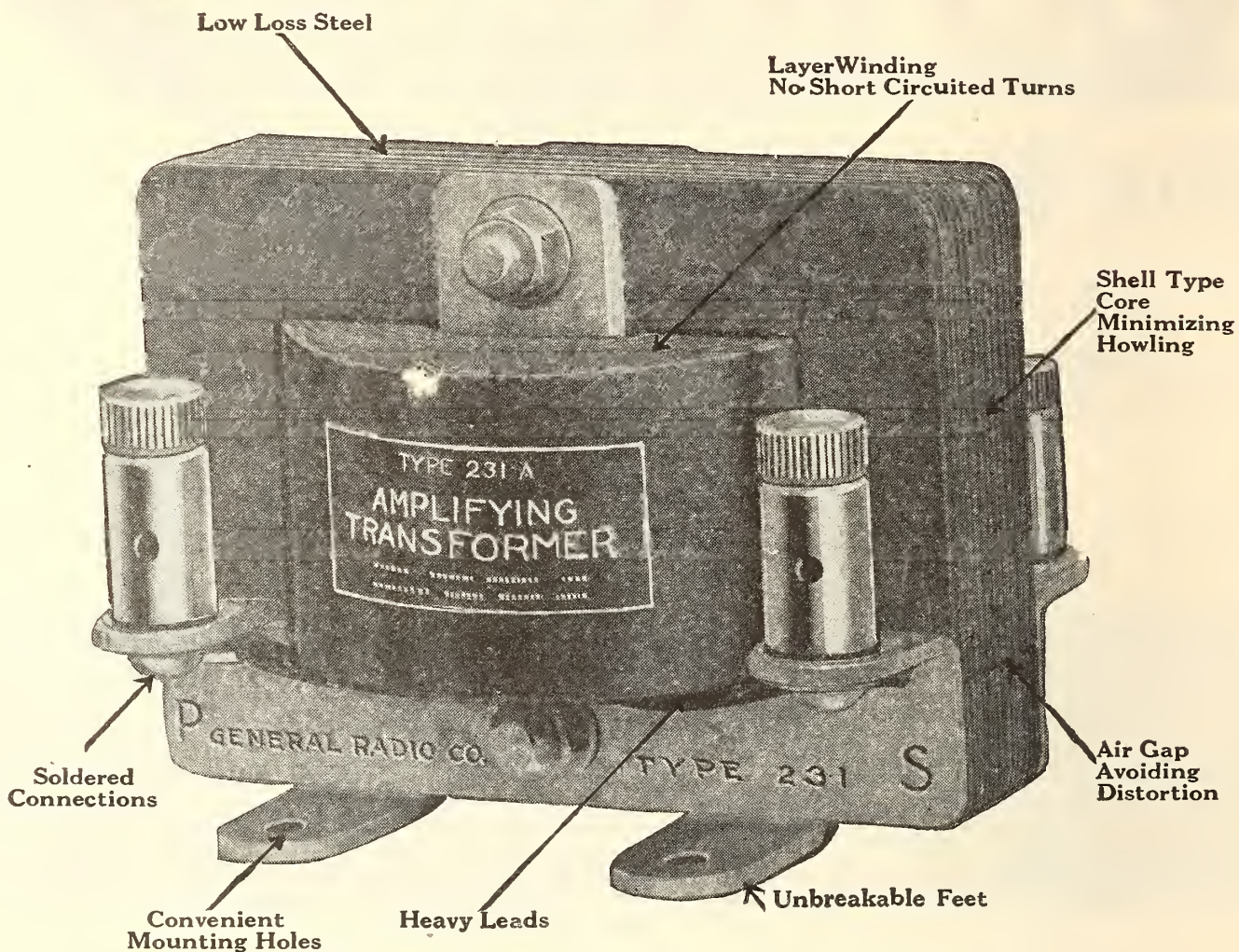

High mu or low mu, when you amplify you must be sure that you do not distort because maximum amplification by itself does not necessarily mean satisfaction. You *should* seek maximum amplification with minimum distortion over the entire audio frequency range.

This problem has been studied for nearly a decade in our laboratory. Its result is expressed in our Type 231A amplifying transformer. Not only has this transformer a high amplification factor but the amplification is nearly uniform throughout the audio range. This flat curve makes it unnecessary to employ the cumbersome method of using different makes of transformers for 2 stage amplification. Use an engineering designed transformer. It costs no more.

Turns ratio            3.7 to 1  
 Impedance ratio    10 to 1

**Price, Completely Mounted - - \$5.00**

*Send for free educational folder—"Quality Amplification," and Radio Bulletin No. 916-B.*

## GENERAL RADIO COMPANY

*Manufacturers of Electrical and Laboratory Apparatus*

Massachusetts Avenue and Windsor Street

Cambridge

Massachusetts

5878



★ Tested and approved by RADIO BROADCAST ★

# Guaranteed Radio

Results can only be relied on with standard make instruments that are guaranteed by a reputable manufacturer. The General Radio Company has been guaranteeing its instruments for nearly a decade. When you are adding to your set consider these guaranteed instruments.

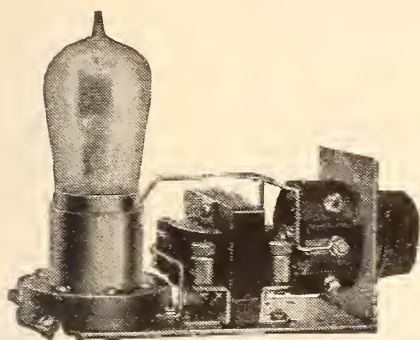

Type 300

A completely assembled and wired audio frequency amplifying unit for very little more than the price of the parts. This unit is ready for external connection, and is adapted to table or back of panel mounting.

- Type 300A Unit for WD-11 Tubes, - - - \$7.50
- Type 300C Unit for UV-199 Tubes, - - - 7.75
- Type 300D Unit for Standard Base Tubes, 8.25

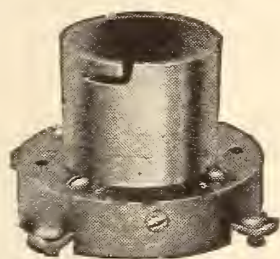

Type 156

A vacuum tube socket with positive contact springs. Base of real bakelite. Wall of heavy brass with high polished nickel finish. Will carry current of 5 Watt without arcing.

- Type 156, Vacuum Tube Socket, - - - \$1.00

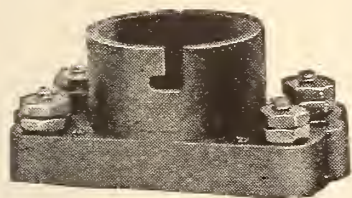

Type 299

A socket for UV-199 Tubes. Of moulded bakelite with stiff phosphor bronze springs.

- Type 299, Vacuum Tube Socket - - - \$0.75

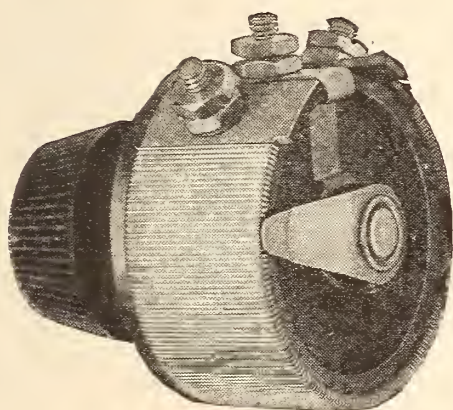

Type 301

A wire wound rheostat of real quality. Base of bakelite. Resistance wire finely wound on specially treated fibre strip.

- Type 301 Rheostat—Resistance 30 ohms, - - - \$1.25
- Type 301 Potentiometer—Resistance 200 ohms, - 1.25

## GENERAL RADIO COMPANY

*Manufacturers of Electrical and Laboratory Apparatus*

Massachusetts Avenue and Windsor Street

Cambridge

Massachusetts

5878



# HOMMEL PASSES 100%

## *What about your jobber?*

Q. Why is a radio jobber?

A. To give service to radio dealers.

Q. Does he retail and thus compete with his dealers?

A. Hommel does NOT retail, but refers users' inquiries and orders to his local dealers.

Q. Does he handle nameless products for his greater profit?

A. Hommel handles only nationally advertised—reliable apparatus.

Q. Can he ship all the dealer's requirements—tubes, sets, and parts?

A. Hommel can and does it promptly. His dealers need not split their orders.

Hommel's Illustrated Encyclopedia 235-B is free to dealers. Ask for it

DISTRIBUTORS FOR  
Radio Corporation of America



Westinghouse General Electric  
Acme Atwater-Kent  
Baldwin Brandes Burgess  
Chelsea Cunningham  
Cutler-Hammer  
Dubilier Fada Frost  
Freshman General Radio  
Grebe Homecharger  
Murdock  
Remler Rhamstine  
U.S. Tool Western Electric  
And other  
leading manufacturers

# LUDWIG HOMMEL & CO

530-534 FERNANDO ST.



PITTSBURGH, PENNA

# BURGESS BATTERIES



IN the experience of radio engineers, amateurs and experimenters there is a suggestion which clearly points the way to the battery buyer who desires the most fitting and practical combination of electrical energy, low cost per hour of service, long shelf life and uniformity of discharge.

## “ASK ANY RADIO ENGINEER”

More than a mere phrase these words express the preference of radio engineers who have learned the limitations of ordinary batteries and who have found in Burgess products the built-in efficiency which Burgess has achieved to an unequalled degree.

These batteries, the famous Burgess “B”—the new *double strength* Radio “A,” and our latest product, the Vertical “B” Battery are playing an important part in correct and dependable reception of radio broadcast. Each is

## “A Laboratory Product”

*Good dealers everywhere recommend and sell Burgess Batteries*

**BURGESS BATTERY COMPANY**  
 Engineers—DRY BATTERIES—Manufacturers  
 Flashlight—Radio—Ignition—Telephone

*General Sales Office:*

Harris Trust Building, Chicago  
 Laboratories and Works: Madison, Wisconsin

*Branches:*

New York Boston Washington St. Paul  
 Kansas City New Orleans

*In Canada:*

General Offices and Works: Niagara Falls, Ont.  
 Branches: Toronto, Montreal, Winnipeg, St. John



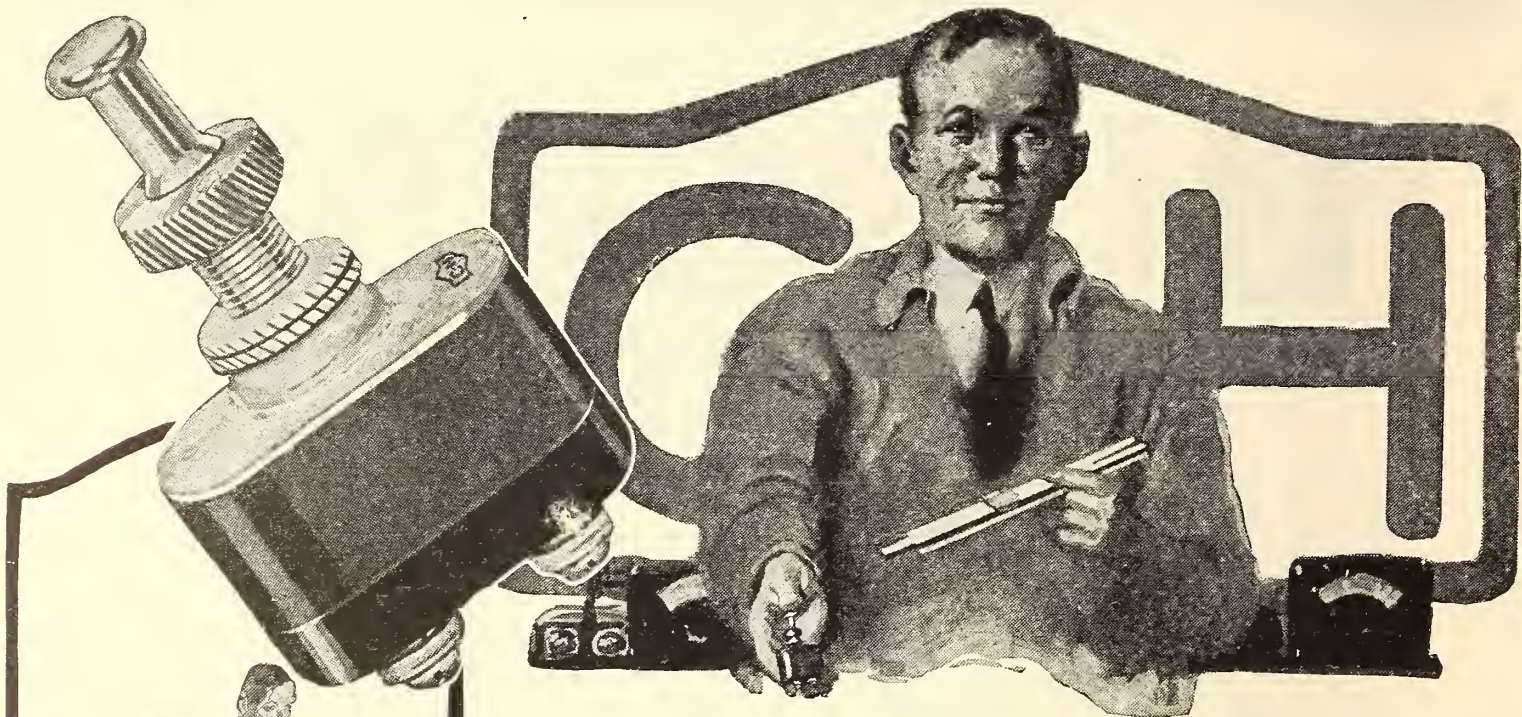

## A Switch by the Master Builder for Your Radio Panel

*Beautiful Appearance  
Correctly Designed—Easily Installed*

In the radio world the name Cutler-Hammer and its symbol the famous C-H trade-mark have become guide posts to quality. In only a few months after their introduction more than a half million radio rheostats with the little mark of approval of the master builders of all electrical control apparatus were purchased.

Now these specialists offer another necessity for your panel, the C-H Radio Switch embodying the same careful design and workmanship to provide more pleasant, convenient reception and protect your expensive equipment at a negligible cost. Its sturdy knife blade mechanism that snaps—not merely slides—is capable of carrying 3 amperes at 110 volts, yet is built with a precision that enables you to use it in your most delicate circuits without any microphonic noises.

It will control your "A" battery to positively indicate whether the tubes are *on* or *off*—your "B" batteries—parts of circuits—condensers—battery charger—practically any demand you may have for current control. It is fully adjustable for panel thickness and can be installed in any set in a few minutes—only a single  $\frac{1}{16}$ " hole is required. Carried by dealers everywhere—if yours has not yet been stocked, send 60c plus 10c carrying charges and you will be supplied direct.

**THE CUTLER-HAMMER MFG. CO.**

*Member Radio Section, Associated Manufacturers of Electrical Supplies*  
MILWAUKEE · WISCONSIN



Disconnecting a battery lead is one way of shutting off a radio set, but many tubes and batteries have been ruined by putting it back on the wrong post. A C-H Radio Switch costs 60c—if you save only a few dry cells it quickly earns its cost.

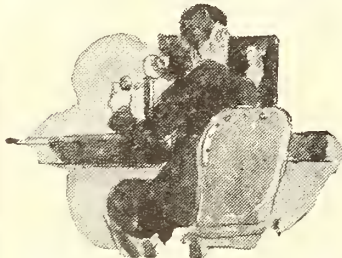

What do you do when the phone rings? Just push the C-H Radio Switch button—answer the phone—pull the button and the same program is back on. No turning back rheostats or disturbing your delicate settings when you have C-H convenience.



With the new tubes that operate at a dull red it is easy to forget to turn off the "A" battery—there is nothing to indicate whether the set is ON or OFF. The nickel button of a C-H Radio Switch sticks right out to say "I'm ON—don't forget me!"

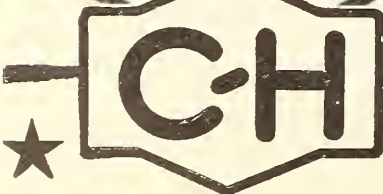

# RADIO SWITCH



# "Abroad at Home"



## Where Shall We Go To-night?



**CROSLEY**  
Better - Cost Less  
Radio Products

List prices on our equipment west of the Rockies 10% higher. In Canada add duty.

**CATALOGUE ON  
REQUEST**

To New York, Cuba, Atlanta, San Francisco or perhaps Honolulu? Far distant stations are continually being brought in clearly and distinctly with a Crosley Model X-J. Unsolicited letters from users telling of new distance records are received daily. You, too, at a very small cost, can enjoy the many pleasures and conveniences that this new Crosley Model affords.

**CROSLEY \$65  
MODEL X-J**

A 4 tube radio frequency set, incorporating one stage of Tuned Radio Frequency Amplification, Detector and two stages of Audio Frequency Amplification, with jack to plug in on three tubes for head phones; new Crosley multistats, universal rheostats for all makes of tubes; new condenser with molded plates; filament switch and other refinements of detail. This receiver is exceptionally efficient in long range reception. It will bring in stations at almost unbelievable distances clearly and distinctly.

We unhesitatingly claim the Model X-J is the best radio receiver ever offered, regardless of price.

The Crosley Model X-J together with the complete Crosley line of receivers ranging in price from \$28 to \$150 are for sale by best dealers everywhere.

**CROSLEY MANUFACTURING COMPANY**

*Powel Crosley Jr., President*

1120 Alfred Street

Cincinnati, Ohio

# Radio Catalogue Free—

**Write us  
a post card—  
Address Dept. 27-R**

and we will send you free this 52 page catalogue of radio sets and parts. It also contains explanation of radio terms, map and list of broadcasting stations and much radio information, including an explanation of successful hook-ups and circuits.

You will be amazed at the low prices Ward's quote. A complete tube set having a range of 500 miles and more, including tube, head set, batteries, and antenna equipment, as low as \$23.50.

This catalogue contains everything for the expert and amateur. Complete sets and every improved part for building sets, all the most up-to-date devices—at the lowest possible prices.

## **Headquarters for Radio**

Montgomery Ward & Co. is headquarters for Radio, selling everything direct by mail without the usual "Radio-profits." Why pay higher prices? Ward quality is the best and the prices will often save you one-third. Everything sold under our Fifty Year Old Guarantee—Your Money Back if You Are Not Satisfied. Write today for your copy of this complete 52-page Radio Book.

**Write to our house nearest you. Address Dept. 27-R  
Chicago    Kansas City    St. Paul    Portland, Ore.    Ft. Worth**

# Montgomery Ward & Co.

**The Oldest Mail Order House is Today the Most Progressive**





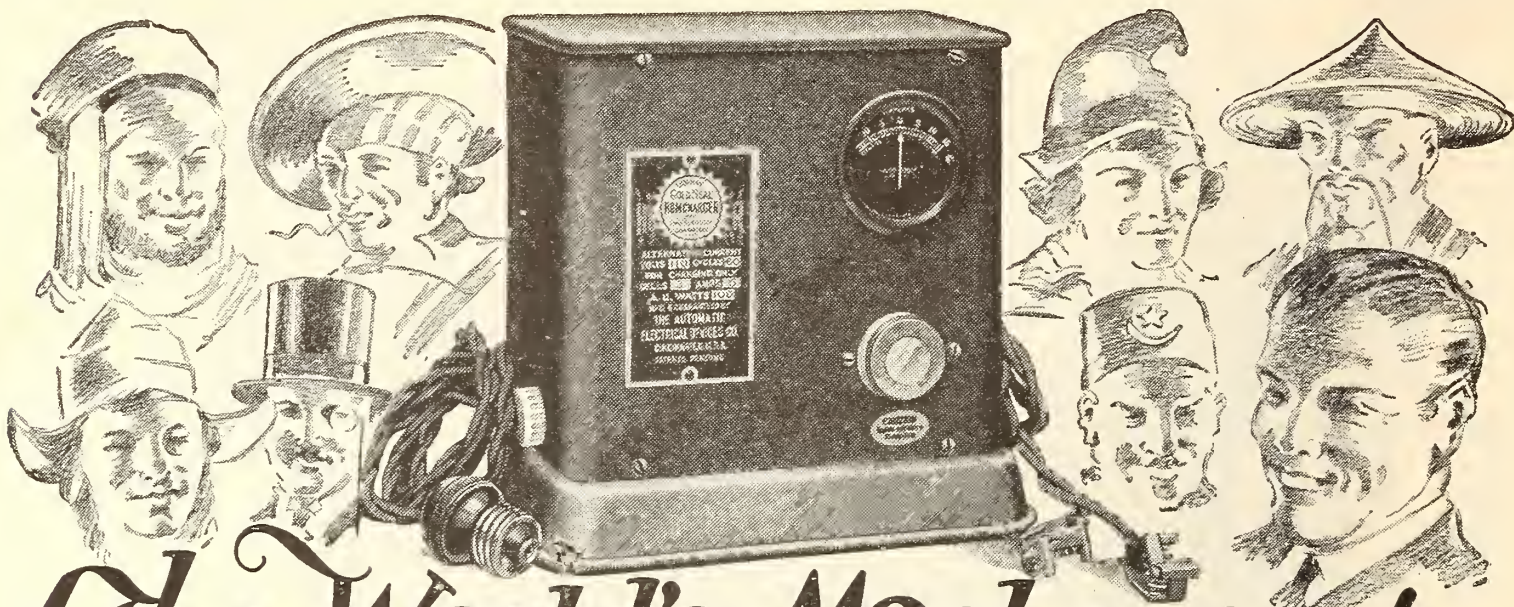

# The World's Most Popular Battery Charger

Nothing speaks so eloquently of HOMCHARGER satisfaction as the fact that thru sheer merit alone it has become the *standard* by which all other battery chargers are judged. Over 125,000 HOMCHARGERS already in use offer the most convincing proof that it is the most efficient, economical and fool-proof battery charger at any price.

**A NEW TRADE-MARK FOR A TRIED AND PROVEN PRODUCT**

Its phenomenal success has led to the introduction of many inferior and make-shift imitations. To insure our reputation and protect the buying public against substitution, the Radio De Luxe HOMCHARGER henceforth will be sold under a new Trade-Mark, viz.:



Retaining the same fundamentally correct operating principle and beautiful appearance of our Radio De Luxe model, it is a step nearer ultimate perfection through adoption of several construction refinements dictated by the policy of Progress.

**HOMCHARGER'S 10 POINTS OF SUPERIORITY**

1. **Simple**—Only one moving and wearing part, replaceable after thousands of hours use for \$1.00. Will last a lifetime.
2. **Efficient**—Uses less than one-half the current of any bulb or liquid type rectifier. Will charge any radio or automobile battery for a nickel.

3. **Quick**—Its high charging rate of 7 amperes eliminates long waiting for battery to become charged. Will charge any "A" or "B" battery over night, or three times as fast as a 2-ampere machine.
4. **Clean**—No expensive bulbs to break or acids to spill or replace. No acid fumes. Charges without muss, fuss or bother.
5. **Dependable**—Tungsten contacts insure continuous operation—prevent sticking and stopping.
6. **Fool-Proof**—Can be operated by anyone. Attach to lamp socket and connect battery either way, it will always charge. High-grade ammeter eliminates guess work.
7. **Safe**—No danger of shock or fire. Tested and approved by Fire Insurance Underwriters everywhere. Gives tapering charge—will not overheat or injure battery.
8. **Beautiful**—Mahogany and Gold Finish.
9. **Unqualifiedly Guaranteed.**
10. **Popularly Priced**—Retail at \$18.50 complete (\$22.00 Canada). No extras to buy. Sold by all dealers.

**FREE BROADCASTING LIST.** Send to-day for Free List of Broadcasting Stations, and Circular Describing the Gold Seal Homcharger.

**DEALERS! JOBBERS!**

GOLD SEAL HOMCHARGERS will outsell any other radio device this season. "GOLD SEAL Business Builders" illustrates many attractive sales helps and explains how we are prepared to co-operate with the Trade in making this a "HOMCHARGER Year." Send for your copy and Trade Discounts TODAY.

*Insist*  
on the **GOLD SEAL**



It is your protection against substitution. When buying order by name and verify by the GOLD SEAL, which appears on the carton as well as the nameplate.

**The Automatic Electrical Devices Co., 128 West Third St., Cincinnati, O.**  
Largest Manufacturers of Vibrating Rectifiers in the World



\$25

*Natural*  
*Re-PRODUCTION*  
*Atlas*  
**AMPLITONE**  
LOUD SPEAKER



**A**LL of the program, natural as the original, re-PRODUCED on the *Atlas Amplitone*. Faithfully responsive, not to just one small range of sound intensity, but to the *full scale* of tone harmonics. The "double diaphragm"—triumph of the radio and acoustic sciences—automatically accommodates itself to every pitch. Blast and distortion are entirely eliminated. The "double diaphragm" is adjustable to operate most efficiently with individual receiving conditions. Ask the nearest Atlas Amplitone dealer for a demonstration. Hear the difference this great innovation makes.

*Letters  
from Users  
Requested*

What have you accomplished with your Atlas Amplitone? Tell us about it!

*Write for Booklet "A"*  
Contains helpful information

*Sole Canadian Distributors*  
**THE MARCONI WIRELESS TELEGRAPH COMPANY  
OF CANADA, LIMITED**  
Montreal, Canada

**Multiple Electric Products Co. Inc.**

ORANGE ST. RADIO DIVISION NEWARK, N. J.



# LOUD SPEAKER

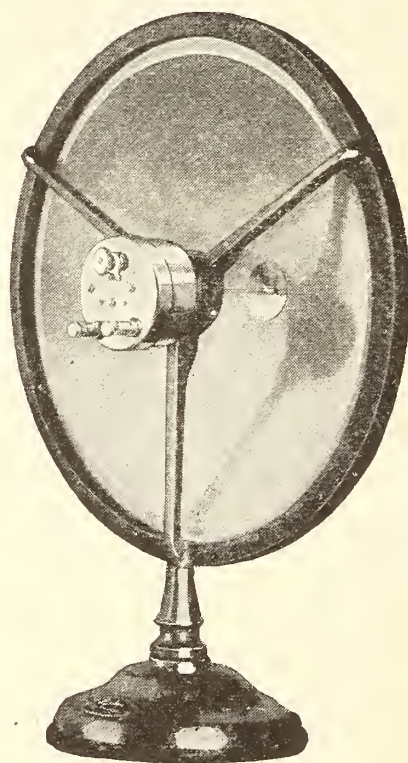

Price  
**\$22.00**

## *A Combination of Efficiency and Beauty*

The Pathé Loud Speaker is unexcelled for its clarity and faithfulness of reproduction. In the large sized diaphragm lies the secret. The music is thrown directly from the diaphragm into the air in all directions. That choked and distorted sound is eliminated. Only a beautiful pleasing tone is heard.

The beauty of the Pathé Loud Speaker has called for untold praise. Its design shows excellent taste. Its elegant finish of delicate Pompeian Green blends with the surroundings of any room. Not big, not ugly, just as sweet as the music it faithfully reproduces.

*Jobbers and Dealers write for Special Proposition.*

## **Pathé Phonograph and Radio Corp.**

20 Grand Avenue, Brooklyn, N. Y.

533 South Wabash Avenue, Chicago, Ill.



# Magnavox Radio

## The Reproducer Supreme

SO simple in operation that any Radio user can obtain perfect results—so sensitive and flexible in scope that the professional will find it fully responsive to every requirement—the new Magnavox Combination Set A1-R or A2-R brings a degree of radio usefulness and enjoyment never before attained.

Every condition in the art of radio reproduction is most successfully met by Magnavox apparatus.

### *Magnavox Reproducers*

- R2 with 18-inch curvex horn . \$60.00
- R3 with 14-inch curvex horn . 35.00
- M1 with 14-inch curvex horn.  
Equipped with binding posts  
and a five foot flexible cord;  
requires no battery for the field. 35.00

### *Magnavox Combination Sets*

- A1-R consisting of electro-dynamic  
Reproducer with 14-inch curvex  
horn and 1 stage of amplification 59.00
- A2-R consisting of electro-dynamic  
Reproducer with 14-inch curvex  
horn and 2 stages of amplification 85.00

### *Magnavox Power Amplifiers*

- A1—new 1-stage Power Amplifier 27.50
- AC-2-C—2-stage Power Amplifier 55.00
- AC-3-C—3-stage Power Amplifier 75.00

Magnavox Radio Products can be  
had of good dealers everywhere.  
32-page catalog sent on request.

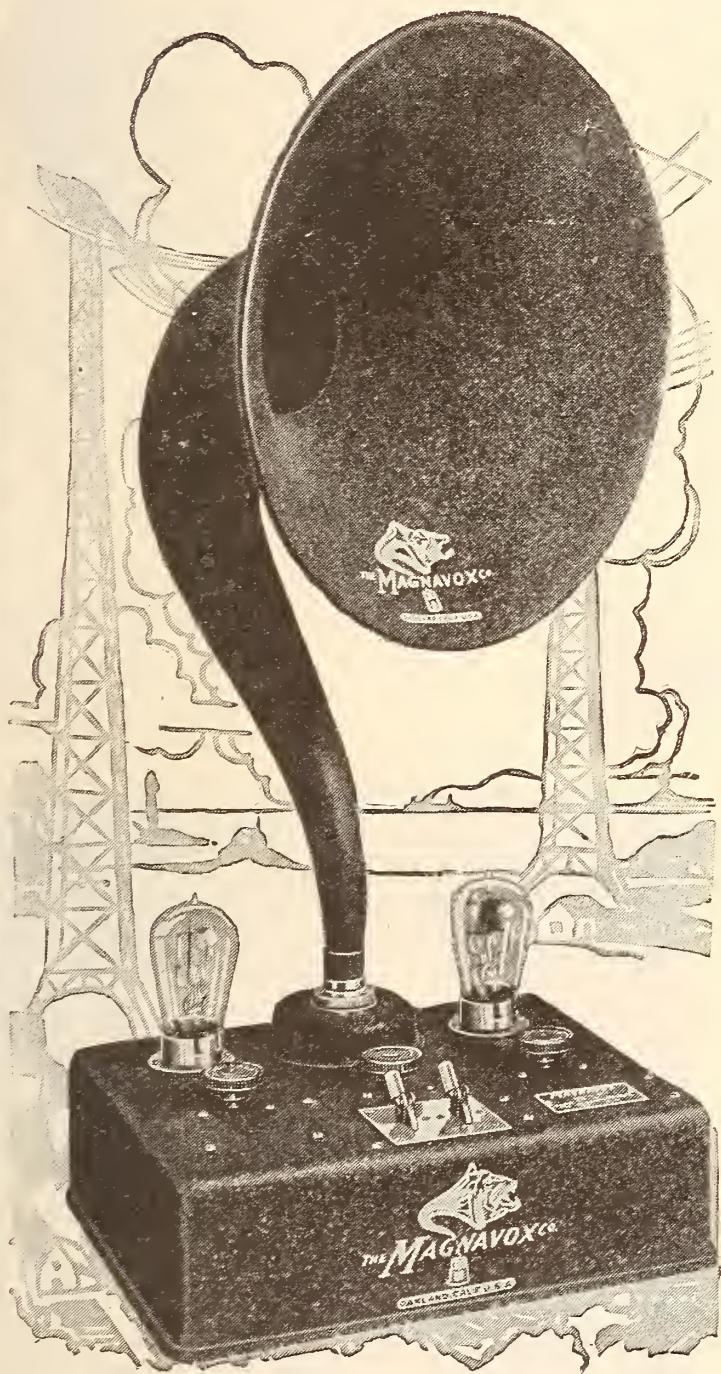

The New Magnavox Combination Sets  
A2-R [2-stage] and A1-R [1-stage] insure  
the utmost in convenient, home radio re-  
production.

## THE MAGNAVOX CO., Oakland, Cal.

New York Office: 370 Seventh Ave.

PERKINS ELECTRIC CO., LTD., MONTREAL, CANADIAN DISTRIBUTORS

# New Equipment



**THE MANHATTAN  
LOUD SPEAKER**

This is an instrument of fine quality, comparatively free from distortion. In the base of the horn is a concert modulator which regulates the volume to suit the requirements of the room where it is being operated.—Manhattan Electrical Supply Co., Inc., 17 Park Place, New York City. Price \$25

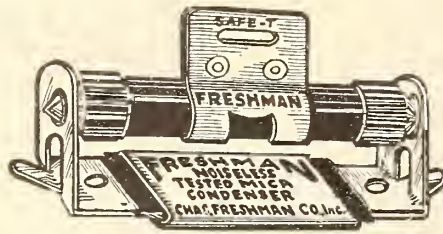

**THE FRESHMAN "FIX-O"**

A combination of grid condenser and leak with mounting. The plates of the condenser form the support for the leak, which is of standard cartridge size, fitted with the Safe-T handle. The complete unit may be attached without solder.—The Chas. Freshman Co., Inc., 106 Seventh Ave., New York City

**THE "IMPROVED" BATTERY  
SWITCH**

A neatly designed unit for connecting or disconnecting the filament battery.—Radio Improvement Co., 25 West 43rd St., New York City

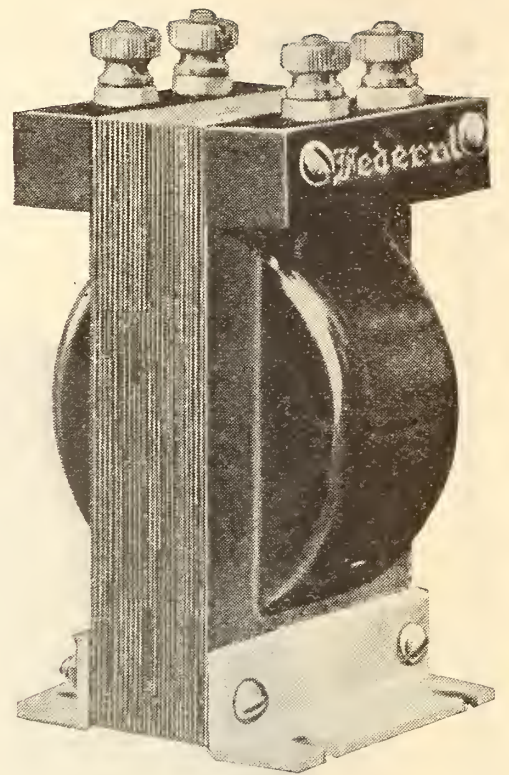
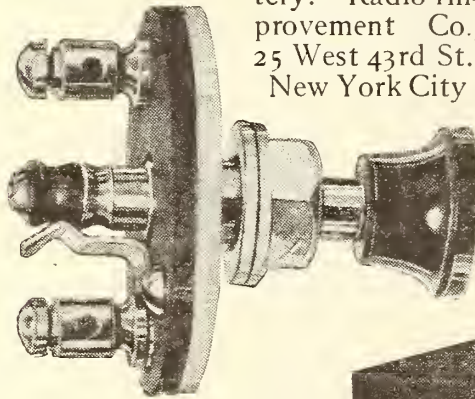

**FEDERAL NO. 65 TRANS-  
FORMER**

An audio-frequency transformer of good construction. The lower tones received special consideration in the design of this unit.—Federal Telephone & Telegraph Co., Buffalo, N. Y.

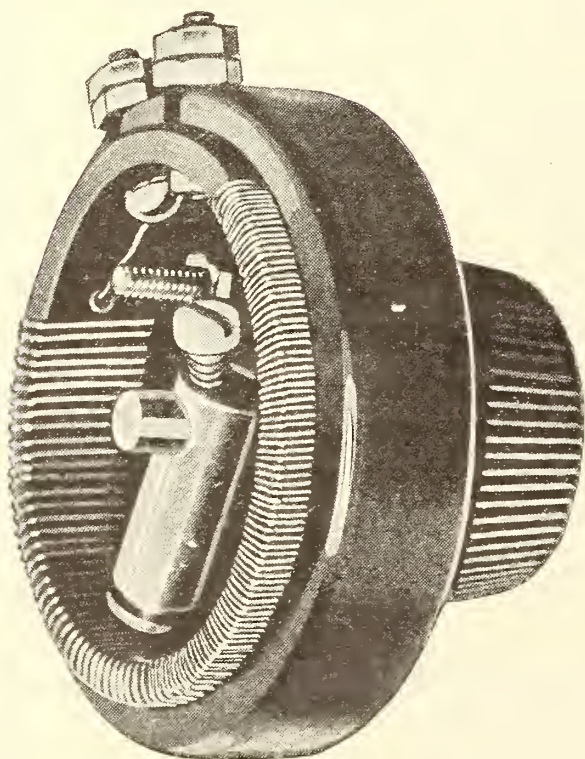

**THE CROSLY MULTISTAT**

A well designed rheostat for use with all of the vacuum tubes now in common use. Its total resistance is in excess of 20 ohms.—Crosley Mfg. Co., Cincinnati, Ohio. 85 cents

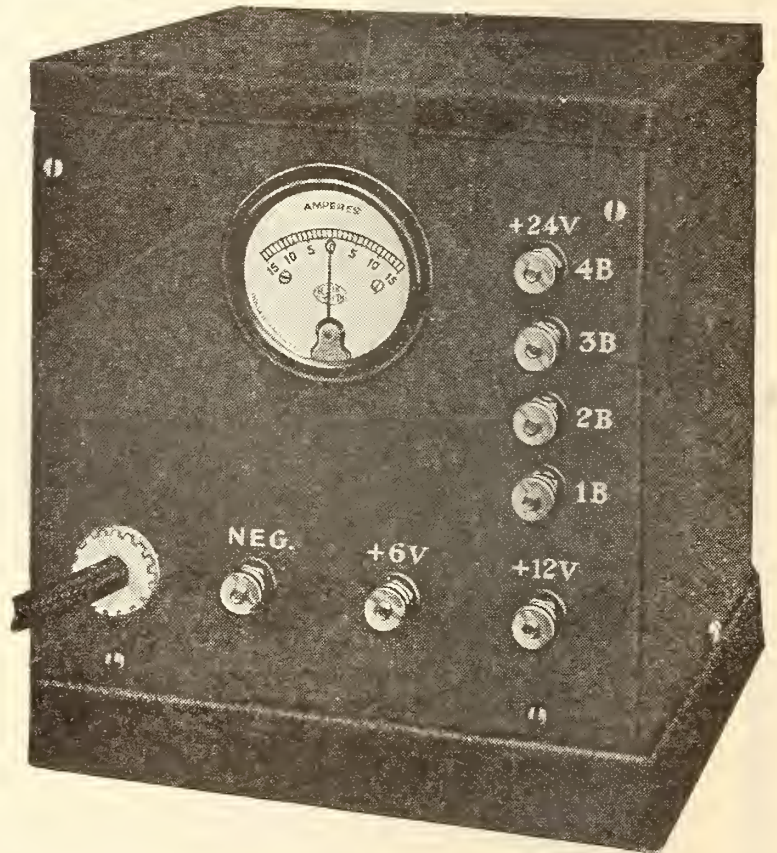

**THE HANDY CHARGER**

A convenient device for charging storage batteries from the lamp socket. It will fully charge the ordinary six-volt battery in from eight to twelve hours. Will also charge from one to four B batteries at a time.—Interstate Electric Co., St. Louis, Mo.



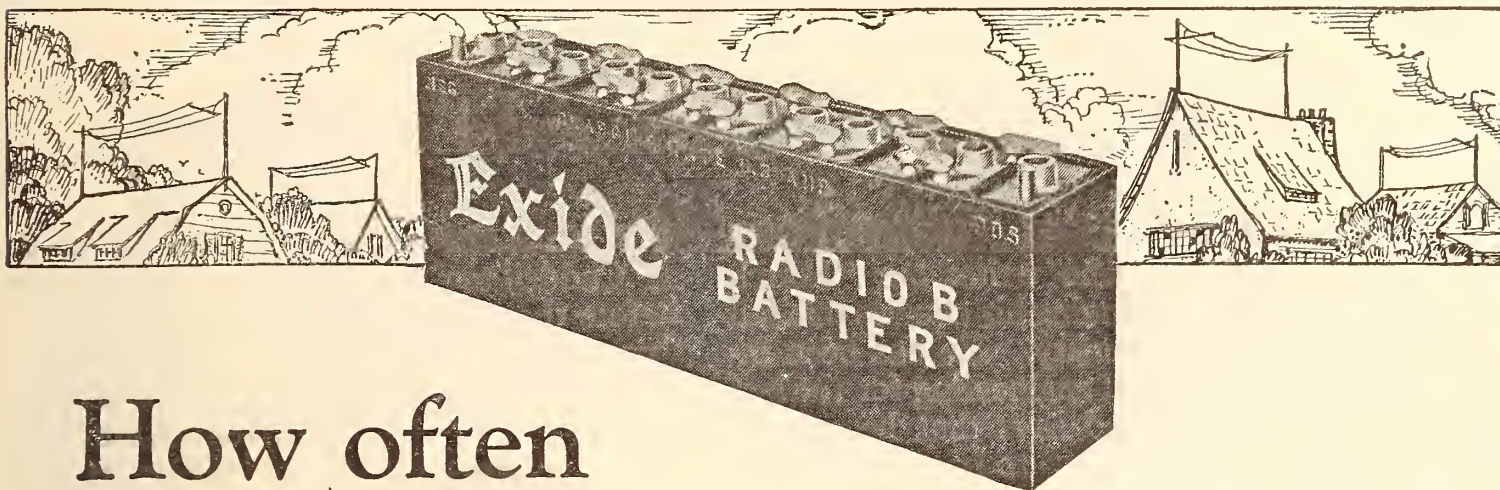

# How often do you get a new B battery?

**T**HE current from a B battery is relatively small. But it must be always on the job. B batteries that run down quickly are the bane of the radio fan's existence. Your B battery can help you get the most pleasure from radio, or it can be your greatest nuisance. It all depends on the kind of battery you buy.

The wise radio amateur knows it pays to get a good B battery in the first place. And that means an Exide. The new Exide B Battery is built with extra-heavy plates. That is one reason why it lasts so much longer than the ordinary battery. It can be recharged again and again, saving you the annoyance of frequent replacements.

Exide B Batteries give steady, noiseless current. They are strangers to the hissing, frying noises caused by internal discharge. The 12 cells are encased in rubber, with special vents to allow gas to escape when the battery is being recharged. They are designed throughout to prevent electrical leakage.



*Exide A Battery for six-volt tubes*

Supplies uniform filament current. Is dependable and long-lasting. Comes in four sizes, of 25, 50, 100 and 150 amp. hr. capacities.

the latest developments in radio receiving. The one-cell Exide A Battery will heat the filament of a 1.1 volt .25 ampere tube for 96 hours; the two-cell Exide A Battery will heat the filament of a 3 volt 60 milliamper tube for approximately 200 hours.

## Two low-voltage A batteries

If your set operates on low-voltage tubes, it will be worth your while to examine the new Exide two- and four-volt A batteries. They are right in line with

They are specially adapted to WD-11 and UV-199 vacuum tubes.

The Exide A Battery for six-volt tubes gives full-powered, care-free service. It requires only occasional recharging. Like all Exide Radio Batteries, it is built of the finest materials available, is sturdy and long-lasting.

When you hook up your set with Exide A and B Batteries, you are sure of getting maximum signal strength. You can reproduce broadcast selections in clear bell-like tones.

Wherever reliable storage batteries are required, you will find the Exide doing its work ungrudgingly. It is recognized as the leading storage battery in every field of industry. A majority of all government and commercial wireless plants are equipped with Exide Batteries.

Don't let inefficient batteries spoil your pleasure in radio. Go to any radio dealer or Exide Service Station and ask for Exide Radio Batteries.

If your dealer can't supply you with free booklets describing the complete Exide line, write direct to us.

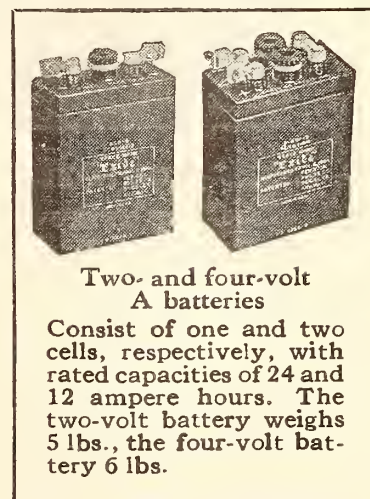

Two- and four-volt  
A batteries

Consist of one and two cells, respectively, with rated capacities of 24 and 12 ampere hours. The two-volt battery weighs 5 lbs., the four-volt battery 6 lbs.

# Exide<sup>★</sup>

## RADIO BATTERIES

THE ELECTRIC STORAGE BATTERY COMPANY, PHILADELPHIA

Oldest and largest manufacturers in the world of storage batteries for every purpose

Service Stations Everywhere

Branches in Seventeen Cities

★ Tested and approved by RADIO BROADCAST ★

# AMONG OUR AUTHORS

**P**ROFESSOR J. H. MORECROFT ("J.H.M."), who writes our "March of Radio", is continuing his courses this fall at Columbia University. He has been instructor in electrical engineering for the last seventeen years and says that he expects



**KENNETH HARKNESS**  
He rolls up his sleeves and plunges into a detailed description of how to build an excellent one-tube set

to be a teacher the rest of his life, as "contact with young enthusiastic men is wonderfully attractive." During the War, he was engaged by the Navy as scientific expert to develop special forms of submarine detectors.

to be a teacher the rest of his life, as "contact with young enthusiastic men is wonderfully attractive." During the War, he was engaged by the Navy as scientific expert to develop special forms of submarine detectors.



**KENNETH HARKNESS**, Chief Engineer of the Radio Guild, New York, has been engaged in the manufacture of

radio equipment for a number of years. He is author of a monograph on "The Construction and Operation of Super-Regenerative Receivers" and has recently had a book published—"Radio-Frequency Amplification."



**C. H. HUNTLEY**, formerly in newspaper work, joined the G. E. Company several years ago as a special writer, and has



done a number of interesting popular magazine articles on electricity and its uses. He has also been known to write verse.

**C. H. HUNTLEY**  
He reveals to us some of the tricks of the drama-broadcasting game as it is played at WGY

**I**T WAS not until 1919 that Alfred M. Caddell took up writing as a profession. Before that time, he had been, successively, "newsboy, farm hand, railroad man, ranch-owner, traction engineer, airplane mechanic, inventor, and lover of the great outdoors." At Stony Brook, L. I., he is at present "busy turning a piece of woodland into an attractive home place," and building a hydro-airplane to be propelled by a 16-h. p. motor-cycle engine.



**W. L. ECKHARDT**

The musical trade, he believes, will prove to be the logical organization to sell the complete radio receivers of the near future. However,—

which is at once his business and his hobby.

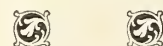

**CARL DREHER** has recently been put in entire charge of the Radio Corporation's "Broadcast Central" in New York. His instruc-

—**GEORGE ELTZ**

Doesn't agree with Mr. Eckhardt. He explains in detail why he thinks the electrical dealer is, and will continue to be, the proper and principal outlet for radio. Mr. Eltz has an article on the superheterodyne also in this issue. He is here shown hurrying home to his "super"—and supper



**JESSE MARSTEN** of New York City, is a dyed-in-the-shellac radio man who has done considerable writing in a field



Radiotron  
UV-199  
For detection or  
amplification  
\$6.50

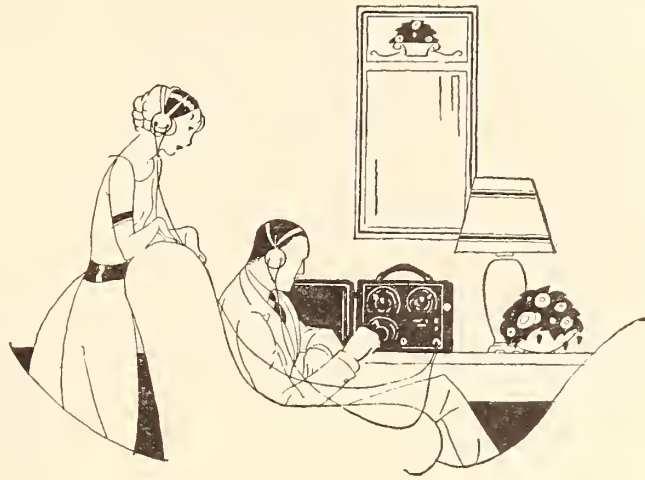

## Radiotron UV-199

### *A Small Tube That's a Big Performer*

The new UV-199 is proving a mighty popular member of the Radiotron family, particularly for portable sets.

Only three-and-a-half inches high. And drawing so small an amperage that it will work on flashlight batteries. It has been called the "tube with nine lives." Battery economy, long life and sensitivity are the big points of Radiotron UV-199. And if by accident it should be operated at too high a temperature, instead of burning out like other tubes, it becomes inoperative and can be brought back to normal operation all over again by disconnecting the "B" battery and lighting the filament for twenty minutes.

For quiet operation—great ruggedness—uniform operation Radiotron UV-199 is unsurpassed. Each new Radiotron has marked a big step in radio advancement. The RCA mark is the foundation of radio growth—and your protection when you buy. Ask for Radiotrons—and look for the mark.



This symbol  
of quality  
is your pro-  
tection

## Radio Corporation of America

Sales Dept., Suite 2066: 233 Broadway, New York

District Sales Offices:

10 South LaSalle St., Chicago, Ill.

433 California St., San Francisco, Cal.

# Radiotrons

## Radio Broadcast

tive and entertaining articles, "What Goes on at a Transatlantic Station" and "Making Radio Your Business" will be remembered by those who read the April and July, 1923, issues of this magazine.



**W**ALTER L. ECKHARDT, President of the General Radio Corporation, has been prominently identified with the talking machine industry for the last thirty years.



**G**EORGE J. ELTZ, JR., Radio Sales Manager of the Manhattan Electrical Supply Co., has been a radio amateur and experimenter since 1904. He is a charter member and past President of the Radio Club of America. In 1914, he worked with the Research Department of the W. E. Co. on the first transatlantic telephone tests. During the War, he was a naval aviator, engaged in radio development on airplanes, here and abroad. Motor-

ing, sailing, golf, and hunting are the recreations that appeal to him particularly.

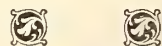

**F**RANKLIN CLEMENT, of Albert Lea, Minn., is instructor in mathematics at St. Olaf's College (Northfield, Minn.), the institution whose experiences in broadcasting he describes in this issue.

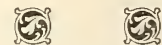

**A**. J. HAYNES, Vice-President of the Haynes-Griffin Radio Service, has been in the radio game since 1910, first as amateur and later as manufacturer. He left Yale University, where he was a student, in 1917, to enlist in the Naval Reserve, and after serving as operator aboard a destroyer, was sent back to Yale again as radio instructor. The September, 1923, issue of R. B. contains an article about Mr. Haynes—"A Little Foresight and a Big Success," by Alfred M. Caddell.

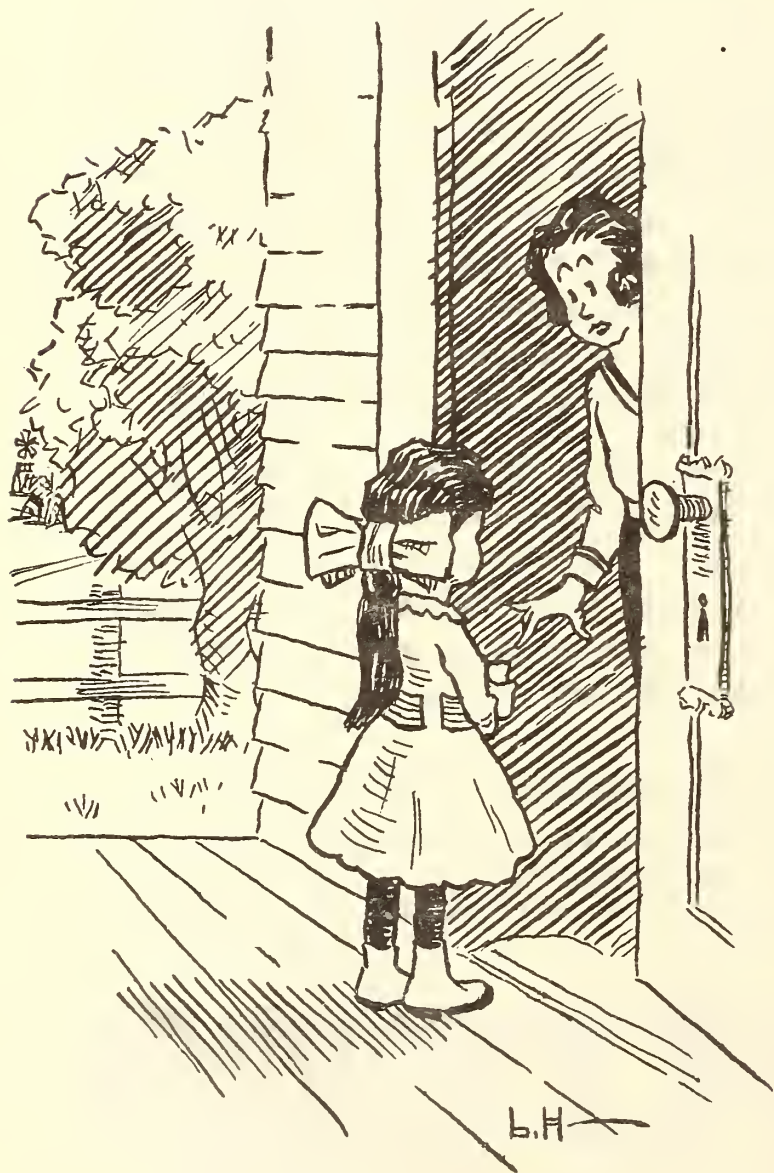

"HERE IS THE SUGAR WE OWE YOU, AND MA SAYS CAN SHE BORROW YOUR HEAD PHONES AND B BATTERY. WE'RE GONA HAVE COMP'NY TONIGHT"

## Among Other Things, Next Month—

We Have in Store for You:

*"What Receiver Shall I Buy?"*, an article by the Editor, helping those who want some kind of radio set but don't know just which, to answer this often perplexing question;

*The new Radio Club of America paper: subject, Loud Speakers; author, A. Nyman;*

*"Various Circuits and What They Mean,"* by Zeb Bouck. This will be an article for the newcomer to the radio game, the first of a series which will take up, subsequently, the more complex circuits in common use today;

*Complete instructions, with photos, circuit diagrams, and working drawings, for the building of a two-stage audio-frequency amplifier, with automatic (jack) filament control, for use with any receiver. This by Carl Goudy.*

*A tale of real radio adventure—no fiction about it, either;*

*AND—among the last but not among the least—a revised list of all active broadcasting stations in the United States and Canada. (What's that? Yes, with their wavelengths and kilocycles.)*

ONE OF THE  
**GERACO**  
PROVED RADIO PRODUCTS

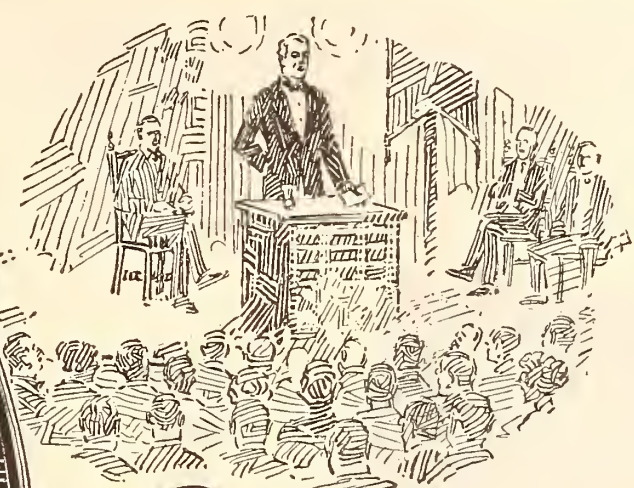
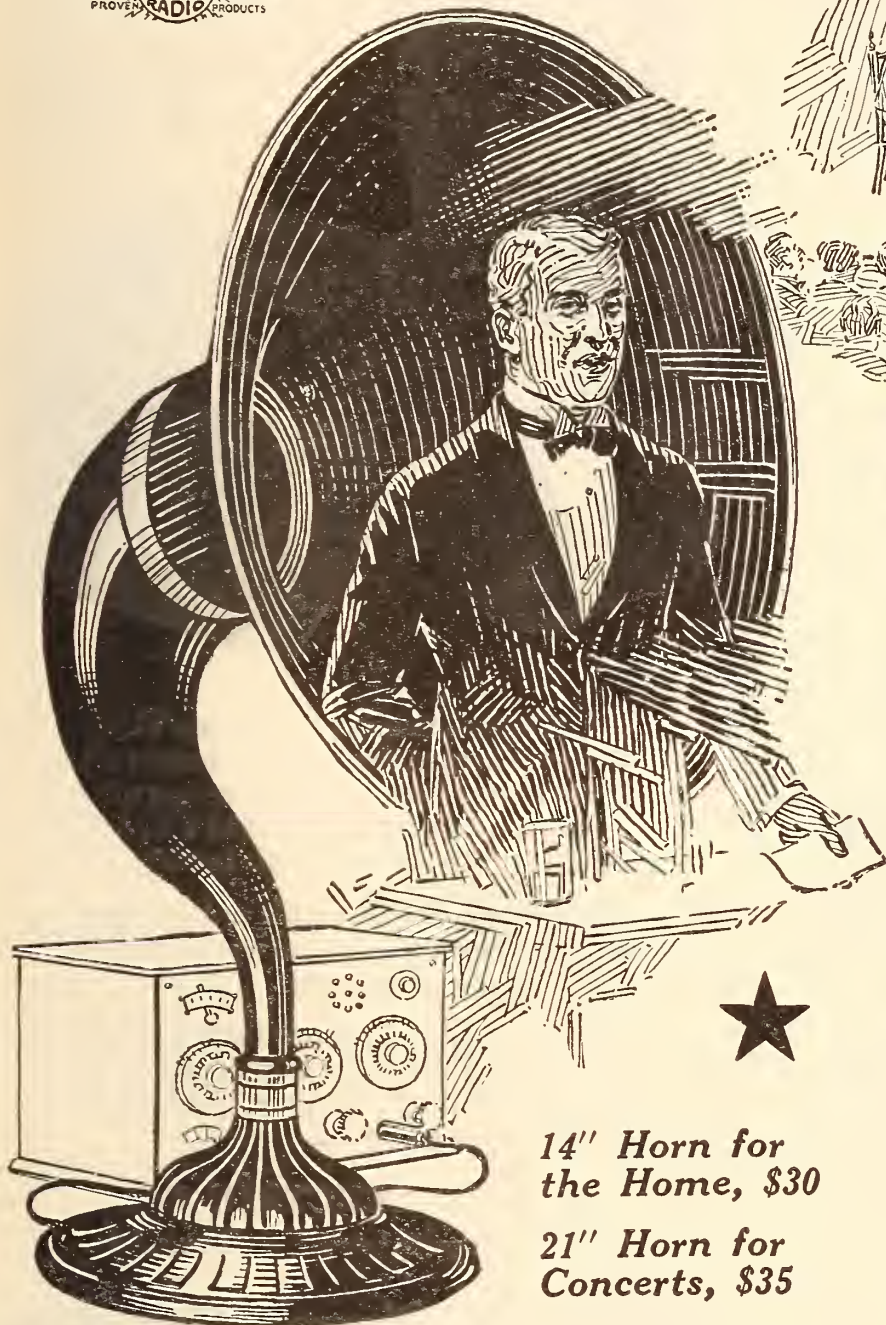

So far—  
yet so  
near!

THE Mayor—the Senator—the  
Governor—the President—or  
other prominent speaker.

Hear him in your own home as  
clearly and distinctly as he is heard  
by audiences, scores of cities away.  
With MUSIC MASTER!

Have the family pull up chairs and  
listen to discussions of national  
topics by leaders of the state and  
nation. Through MUSIC MASTER,  
the most natural of radio repro-  
ducers.

Attached to any good receiving set,  
MUSIC MASTER completes the en-  
joyment of radio. It is the com-  
fortable, the unselfish, way to hear  
radio. Hear MUSIC MASTER, with  
its unrivaled wood horn, at your  
radio dealer's.

14" Horn for  
the Home, \$30

21" Horn for  
Concerts, \$35

Dealers everywhere

GENERAL RADIO CORPORATION  
Makers and Distributors of High-Grade Radio Apparatus  
PHILADELPHIA  
S. W. Cor. 10th and Cherry Sts.

CHICAGO

PITTSBURGH

# Music Master

RADIO REPRODUCER

★ Tested and approved by RADIO BROADCAST ★

# Your pilot over the RADIO WAVES

Whatever the radio course you have set for yourself, here is your one best guide.

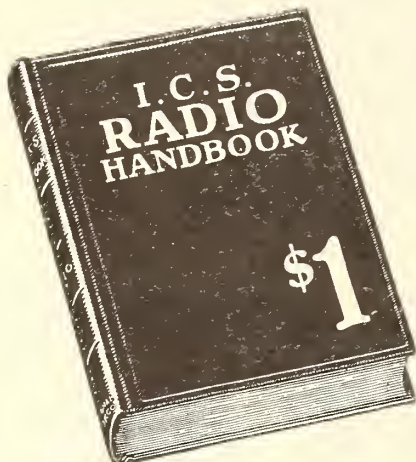

JUST  
OUT  
—  
514  
PAGES

Compiled by HARRY F. DART, B.S.E.E.  
Formerly with the Western Electric Co., and U. S. Army  
Instructor of Radio.

Technically Edited by F. H. DOANE

**T**HIS is what you want in a radio book. It answers your every question as it occurs to you. Look up the thorough index, turn to the page, and there you are! The most complicated facts about radio and electricity explained as easily as the most simple ones.

**Everything included.** Compiled by an expert formerly of the Western Electric Co., the organization that knows most about radio in the world, and edited by another famous engineer. Understood by thousands of laymen because written especially for them. Yet—and here is the real marvel of this book—the advanced amateur, constructor and experimenter also find in it the data they need for calculating the constants of transmitters, receivers and associated apparatus for all radio purposes.

**SOME OF THE FEATURES:** Electrical terms and circuits, antennas, battery construction and maintenance, generators and motors, vacuum tubes (really explained), every receiving hook-up, radio and audio frequency amplification, broadcast and commercial receivers, super-regeneration, codes, license rules, etc.

Send \$1 to-day and get this 514-page I. C. S. Radio Handbook—the biggest dollar's worth in Radio. Money back if not satisfied.

—TEAR OUT HERE—

INTERNATIONAL CORRESPONDENCE SCHOOLS  
Box 8298, Scranton, Penna.

I enclose One Dollar. Please send me—post-paid—the 514-page I. C. S. Radio Handbook. It is understood that if I am not entirely satisfied I may return this book within five days and you will refund my money.

Name.....

Address.....

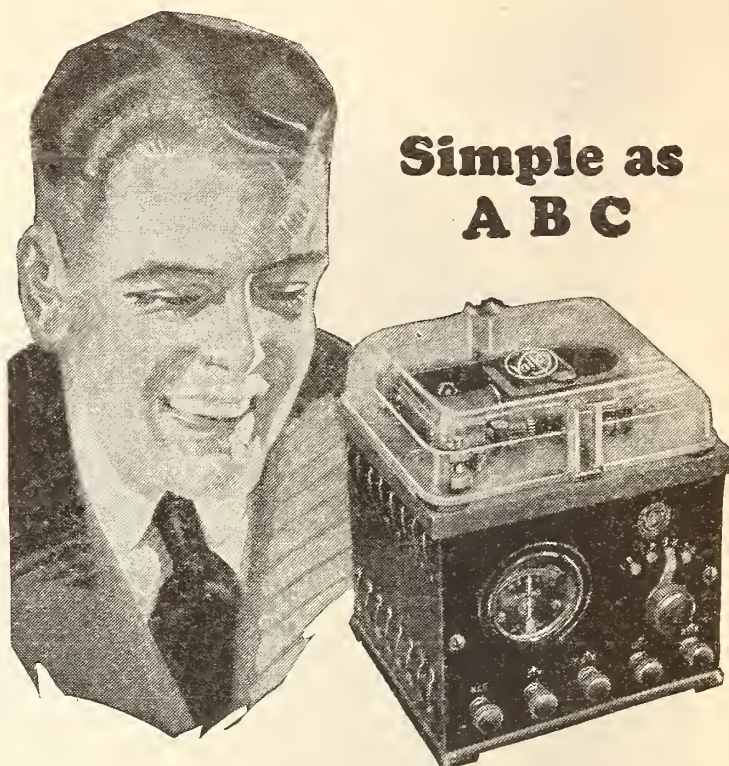

Simple as  
A B C

—And comprehensive, too. The new Valley Battery Charger, Type ABC, charges all Radio storage batteries—2-volt peanut tube batteries, 6-volt A Batteries, and 1 to 4 B Batteries. Also charges 12-volt batteries.

Plugs into regular electric light socket. Uses a negligible amount of current—a dime's worth for an average charge.

Unfortunately, production is limited. Don't miss out, and don't buy another until you have seen the Valley Type ABC Charger. At all good radio dealers.



VALLEY ELECTRIC CO.

3157 S. Kingshighway · St. Louis, Mo.

## Valley Battery Charger

### PERFECT CONNECTIONS

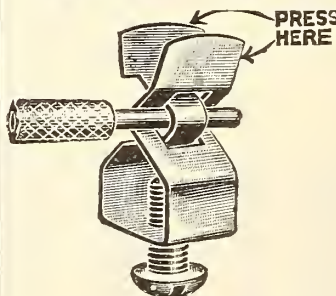

are always sure with

Fahnestock Patent  
Wire Terminal

Grips Like a Vise  
Eliminates Vibrations  
Easily Attached  
No Soldering  
Best of All for  
RADIO OUTFITS

Clip No. 45 (Illustrated) especially adapted for bus wire



Made in all Sizes and Shapes  
At your Dealer's

FAHNESTOCK ELEC. CO.  
LONG ISLAND CITY NEW YORK



# The Romance of Science

**C**ONQUESTS of science were the real achievements of Egypt's rulers. Instead of physical prowess, they sought the laurels of intellectual supremacy. Battles became experiments. Physics, astronomy, alchemy became the chessmen of their leisure. Where other nations plunged into wars and devastation, the Egyptians gave over their vigils to the investigation of natural phenomena.

To symbolize this intellectual power and their ability to create, they conceived the Sphinx, and with unparalleled skill and persistence engraved their triumph on the face of History.

If you assemble your radio parts from plan or book, take time to drink in the romance of radio art. Know on what laws the perfection of your receiving set depends. To acquire such knowledge is not a boresome study, but an

absorbing recreation. As you read, you will understand the impelling appeal of science which has ever tempted Masterbuilders to create craftsman-like products which are more than adaptations of existing designs.

By understanding the scientific basis of radio phenomena, you will begin to appreciate what every radio engineer knows concerning condensers:—that there are no condensers equal to Cardwell's.

Cardwell rotor-grounded condensers afford entire absence of body capacity effects and permit fine tuning of the most distant stations. They have such infinitesimal losses, no laboratory has been able to measure them. Their mechanical ruggedness insures long usage and freedom from annoying difficulties. Not only will Cardwells often add a thousand miles to your receiving range but they permit the entire elimination of interference.

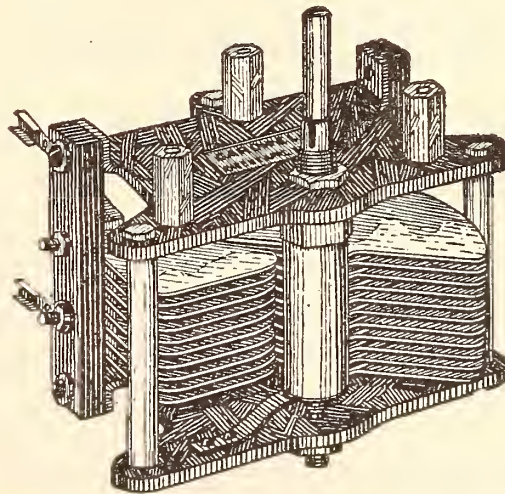

For Egyptian Nights' Entertainment,  
Read: "Cardwell On Condensers."  
Sent on Request.



**ALLEN D. CARDWELL**  
MANUFACTURING CORPORATION  
BROOKLYN, N.Y.

Prices Vary From Three To  
Three Hundred Dollars

Sold Only Through  
Responsible Dealers

18 Stock Sizes  
**RADION  
PANELS**

6 x 7	7 x 21
6 x 10 $\frac{1}{2}$	7 x 24
6 x 14	7 x 48
6 x 21	9 x 14
7 x 9	10 x 12
7 x 10	12 x 14
7 x 12	12 x 21
7 x 14	14 x 18
7 x 18	20 x 24

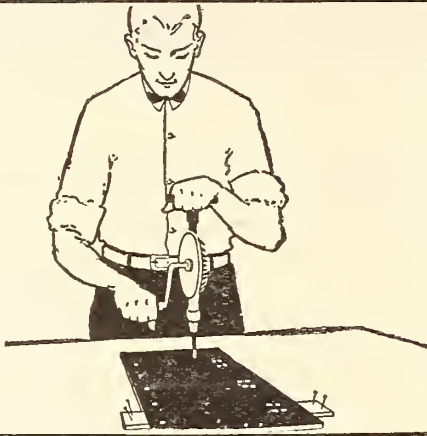

The Supreme Insulation  
**RADION  
Panels**  
are easiest  
to drill, saw  
or engrave  
with simple  
tools at  
home

★  
**18 Stock Size  
Panels**

Radion, being an insulation material especially made for wireless use, has the lowest phase angle difference, lowest dielectric constant, highest resistivity, and supreme moisture, gas, and acid repelling properties.

**American Hard Rubber Co.**  
11 Mercer Street New York

**RADION**

Panels - Dials - Knobs - Sockets - Insulators



The choice of foremost  
Engineers  
for over 17 years. ★

Sold by  
all dealers

**BRACH**  
**RADIO VACUUM  
PROTECTOR**

Approved by the National  
Board of Fire Underwriters  
Ask YOUR Insurance Agent

L.S. BRACH MFG. CO.,  
Newark - New Jersey

**SOLDERALL**  
Metal in Paste Form

Handy Tubes 25¢  
Every Electrical  
Connection Needs  
Solderall for Perfect Reception.  
The Only Convenient Metal Solder

**FERBEND**

TRADE MARK  
**Wave Trap**  
PATENT APPLIED FOR

★  
**The  
Original  
Wave  
Filter**

**Stops Interference!**

Eliminates interfering stations. Improves the selectivity of the set. Eliminates local broadcasting. Selects between conflicting stations. Simplifies tuning. Often increases signal strength. Reduces howling and squealing.

The WAVE TRAP is mounted on a Formica panel in a beautiful mahogany finished cabinet 6 x 5 x 6, and is a high grade instrument throughout, enhancing the appearance of the most expensive sets.

**850** Ferbend Electric Co.  
CHARGES PREPAID 19 E. SOUTH WATER ST.  
**CHICAGO**  
Circular on Request



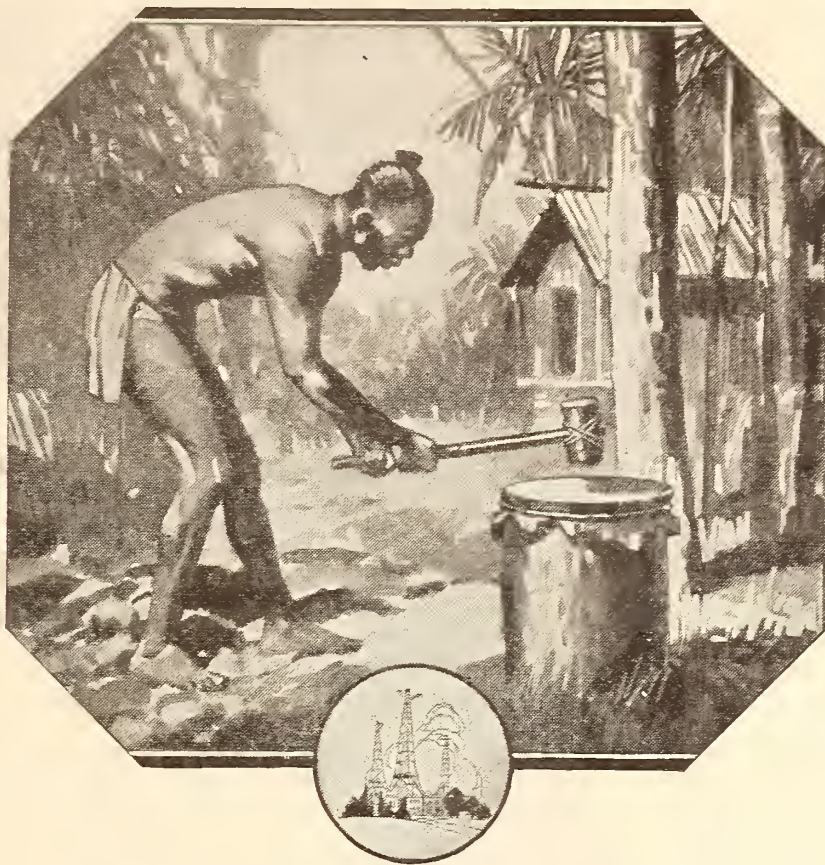

## BROADCASTING

**T**RANSMITTING delicate electrical currents has been highly developed. Receiving them as sent is vital to your enjoyment.

No matter how efficient your receiving set may be, it rests with the headphones you buy to transform these currents into sound. Beautiful, clear and distinctive tones of music or spoken words cannot be reproduced by inferior headphones.

Twenty-five years of research and painstaking manufacture by the Holtzer-Cabot Electric Co. has produced for you the supersensitive No. 2 Universal Headset.

This light weight, sanitary set reproduces positively and faithfully with an exceptional purity of tone and extreme sensitiveness.



**Holtzer-Cabot No. 2 Universal,**  
The supersensitive phone

**Holtzer-Cabot No. 4 National,**  
The quality phone at a minimum price

*Be sure to send for a copy of our booklet, "What You Should Know About Radio Reception"*

**THE HOLTZER-CABOT ELECTRIC CO.**  
125 Amory St. Boston, Mass.  
6161-65 So. State St. Chicago, Ill.  
Department A

*Holtzer-Cabot*  
BUSINESS ESTABLISHED 1875

**HEAD SETS**

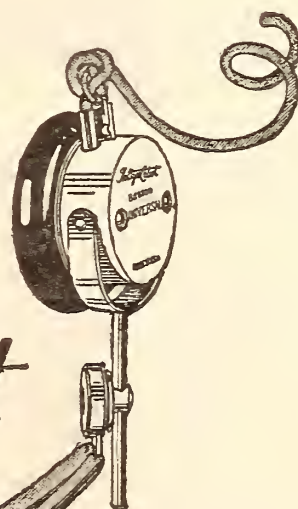
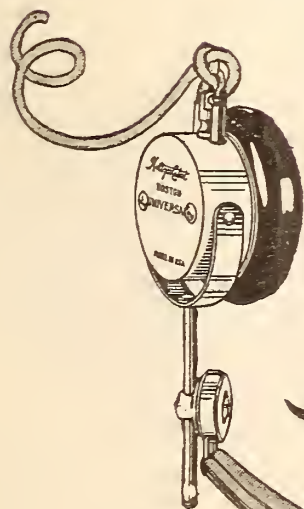

★ Tested and approved by RADIO BROADCAST ★

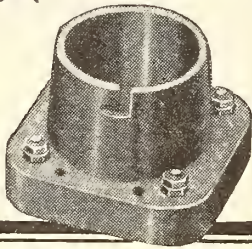
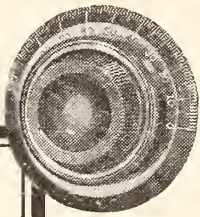
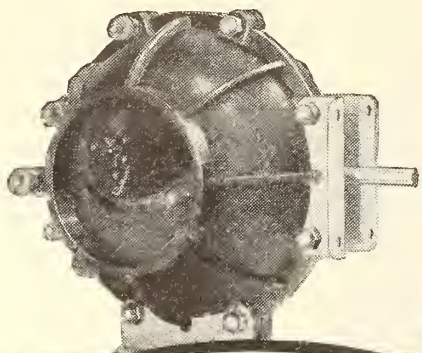

**BAKELITE  
Condensite  
REDMANOL**

are the registered  
Trade Marks for the  
Phenol Resin  
Products  
manufactured under  
patents owned by  
**BAKELITE CORPORATION**

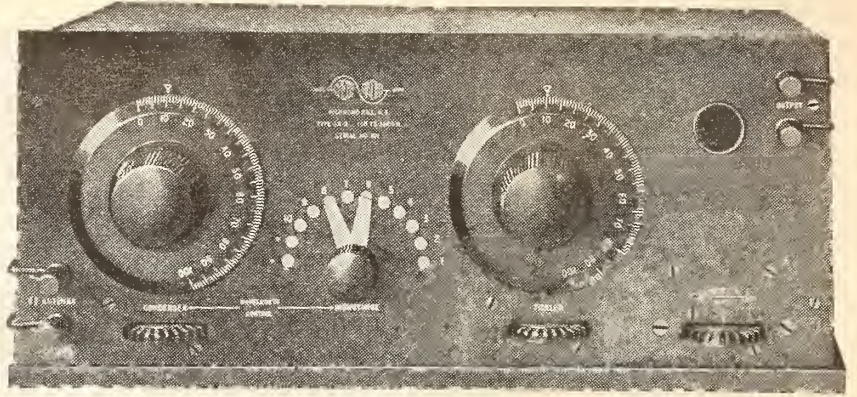

*Dielectric Strength that is constant under varying climatic temperatures is the property of phenol resin insulation*

Combined with this dielectric strength are the additional advantages of mechanical strength, freedom from moisture absorption, lasting beauty of finish and color.

**BAKELITE CORPORATION**

*Address the Divisions*

General Bakelite Company  
Condensite Company of America  
Redmanol Chemical Products Co

West 40th St., New York  
Bloomfield, New Jersey  
636 W. 22nd St., Chicago

**THE MATERIAL OF A THOUSAND USES**

for  
**PURE TONE QUALITY  
and MAXIMUM VOLUME**

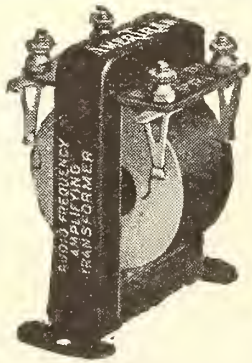

**Price \$7**  
Ask your  
dealer.

Or, sent carriage charges  
collect.  
(Wt. 1 lb.)

*The* **AMERTRAN**  
- REG. U.S. PAT. OFF. -  
**AUDIO TRANSFORMER**

—recognized by the Radio Profession as the  
**STANDARD of EXCELLENCE**

Turn ratio, 5:1. Amplification  
ratio, 30-40 times audibility in the  
flat part of the curve.

★ *Send for Circular 1005*

**American Transformer Company**

*Designers and builders of radio  
transformers for over 22 years.*

181 Emmet St., Newark, N. J.

**H&H Radio  
Material**

**Nutmeg Brand**

*Based on 30 Years' Manufacturing  
and Electrical Development-Work*

Try the new H & H Transformer W306—  
with a turn ratio of 6 to 1—in combination  
with our W303: turn ratio 3 to 1. The re-  
sult will emphasize to you the "why" of this  
latest addition to the H&H Radio Family!

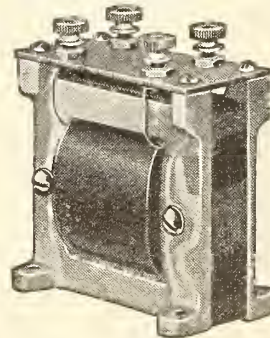

EVERY H & H (Audio  
Amplifying) Transformer  
is tested before shipping,  
with 1500 volts potential  
between the primary and  
secondary winding; also  
between these windings  
and the core. This test  
certifies to the durability  
and integrity of work-  
manship, though techni-  
cal data will be sent glad-  
ly if requested. Price of  
H & H Transformer:—

W303, Turn Ratio 3 to 1 : : : : \$4.50  
W306, Turn Ratio 6 to 1 : : : : 5.00

*Write for new 32-page catalogue showing complete  
Radio Line and three practical photographed hook-ups*

We will carefully fill your order direct if you can-  
not buy the goods locally. For advising us of your  
Dealer's name and address you'll receive a photo  
of an excellent one-step dry cell hook-up, free.

**THE HART & HEGEMAN MFG. CO.**  
HARTFORD, CONN.



**Full radio tones will not come from "empty" radio batteries**

Even the finest radio instrument will not give results unless the battery is doing its full duty. For complete and satisfying reception from near and far, no other combination equals the reliable storage battery and the Tungar for keeping it tuned up.

With Tungar in the house you are prepared for perfect reception always, without having to move the battery an inch. You renew again and again with Tungar and your regular electric light current.

Tungar attaches wherever there is a lamp socket or a convenience outlet. Just turn it on and leave it, any time, day or night. Its cost of operation is low. There are no moving parts to get out of order.

For years motor car owners have used Tungar for charging their automobile batteries. See one at any good electrical shop, or write for literature. Address Section RB 11.

Merchandise Department  
General Electric Company  
Bridgeport, Connecticut

*Tungar Battery Charger. Operates on Alternating Current.*

*(Prices east of the Rockies)*

*2 Ampere Outfits Complete—\$18.00*

*5 Ampere Complete—\$28.00*

*Special attachment for charging 12 or 24 cell "B" Storage Battery—\$3.00*

*Special attachment for charging 2 or 4 volt "A" Storage Battery—\$1.25*

*Both attachments fit either Tungar*

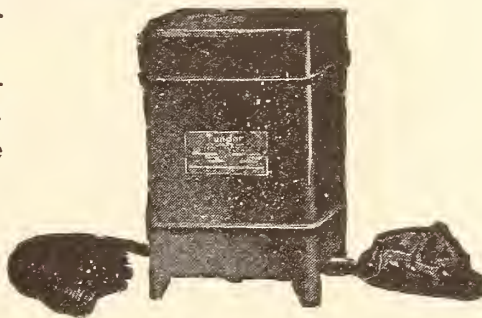

Charge 'em at Home, with



**Tungar**

**BATTERY CHARGER**

35A-1040

A GENERAL ELECTRIC PRODUCT

★ Tested and approved by RADIO BROADCAST ★

D-7-A Reflex Radiophone, \$125.00; D-10 4-Tube Reflex Radiophone, \$150.00. Prices plus approximately 6% for transportation west of the Rockies. These Reflex sets operate either on wet or dry cells with De Forest wet or dry cell tubes. Free Catalogue and Price List of sets, audions and parts sent on request.

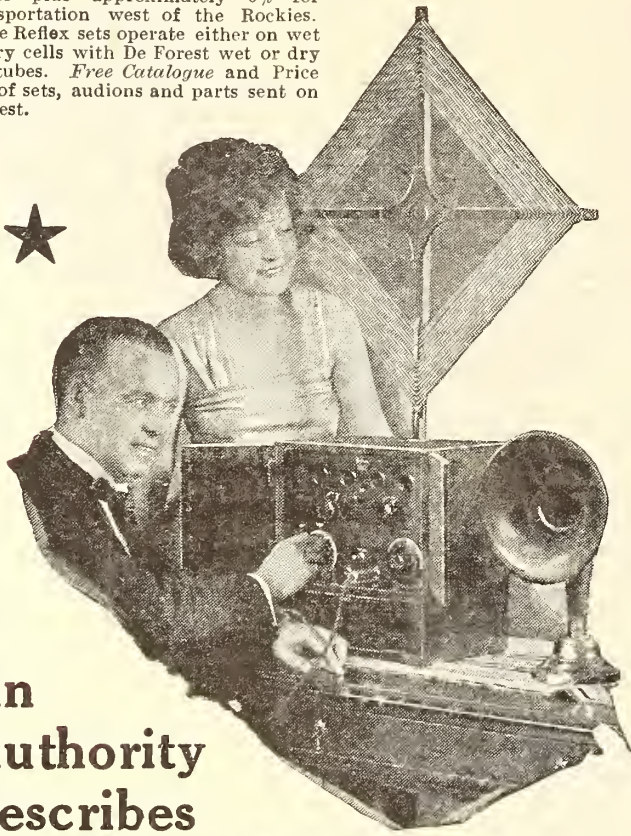

## An Authority Describes The Ideal Receiver

"It seems to us," says the Editor of *Radio Broadcast*, "that a set having radio and audio frequency amplification, without regeneration, must be possible in such a design that the only adjustment required is the one dial tuning the antenna circuit—the antenna being a loop. . . . To do away with the tinkering—simply to turn one handle to a definite marked point and get the station wanted . . . that is the kind of a set which will find favor in the future."

Yes, Mr. Editor, you are right. Such a set is already finding favor all over the United States. It is the De Forest D-7-A Reflex Radiophone, and the D-10 Four-Tube Reflex fills the same prescription, with the addition of a Vernier Variable Condenser for precision tuning.

In spite of new fangled circuits, the De Forest Reflexes are snatched up by the radio public faster than we can make them, because of their *simplicity* of installation and operation—the fact that they cost so little to operate—the elimination of the outdoor aerial, and their great selectivity—you can get the station you want, when you want it, without interference.

These features, with a range on indoor loop of from 1,500 to 3,000 miles according to atmospheric conditions, have made people prefer De Forest Reflexes at \$125.00 and \$150.00 to sets costing four times as much.

Whether you buy complete sets or build your own—  
"Rely on De Forest, the Greatest Name in Radio."

**DE FOREST RADIO TEL. & TEL. CO.**  
Dept. R.B. 3 Jersey City, N. J.

*If located west of Pennsylvania address*

**DE FOREST RADIO TEL. & TEL. CO.**  
Western Sales Division

Dept. R.B. 3 5680-12th Street, Detroit, Mich.

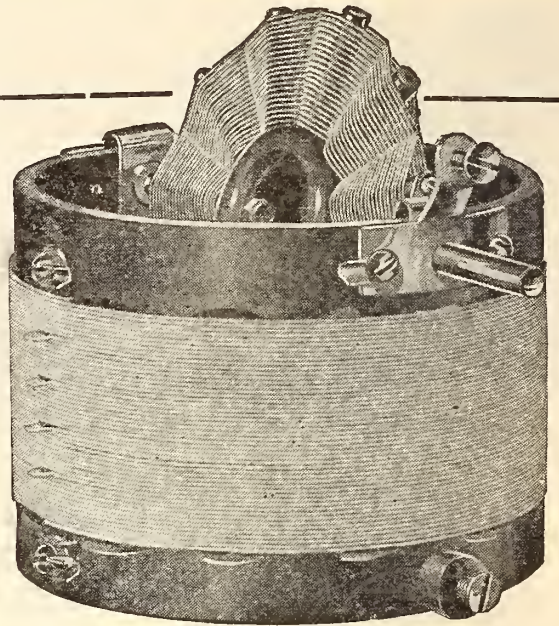
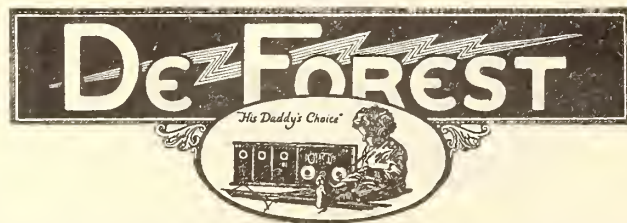

**\$6.50 VARIOCOUPLER \$6.50**

With **SPIDER WEB ROTOR Pat'd**

**MINIMUM COUPLING—SELECTIVE TUNING**

ROTOR—Spider Web design. 50 turns, No. 25 d. s. c. wire.  
STATOR—50 turns, No. 20 d. s. c. wire. 5 taps. **SHAFT LENGTHS**  
—for 1/8 in., 3/16 in. and 1/4 in. panels. Diameter—4 in. Height—  
4 1/4 in. Weight—1 lb.

**THE HARTMAN ELECTRICAL MFG. CO.**  
Mansfield, Ohio

## GAMBLING?

**YOU ARE IF YOUR RADIO TUBES ARE UNPROTECTED**

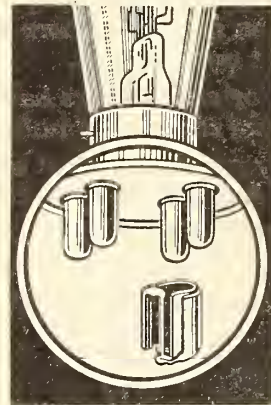

Your Vacuum Tubes are the most delicate parts of your Radio Set.

They are easily blown out—you have probably already had this exasperating experience—it is apt to happen at any time.

"B" Battery wires accidentally crossed for only an instant with the filament leads or sudden excess current from the "A" Battery will do it.

You can prevent this and save yourself money and inconvenience and relieve your mind at a trifling cost.

**INSTALL RADECO SAFETY FUSES**

on all your tubes. Applied in an instant to any one of the filament terminals. Will fit any standard tube going in any standard socket.

**Price 50 cents each**, sent postpaid and fully guaranteed. Do not delay. Order now. Specify type of tube used.

Dept. 3  
**RADIO EQUIPMENT COMPANY**  
Manufacturers and Distributors of Standard Radio Equipment  
630 Washington Street Boston, Mass.  
*New England's Oldest Exclusive Radio House*  
Dealers:—Write for our proposition

# MU-RAD ★ RECEIVERS

*The Ultimate  
in  
Radio  
Reception*

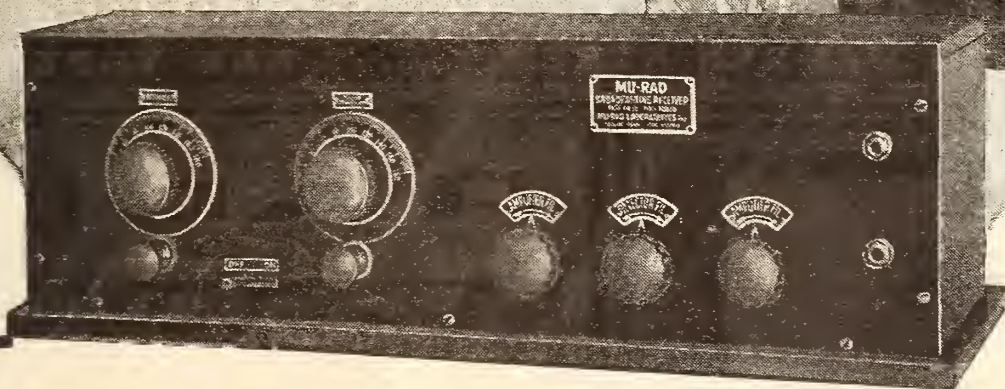

*The New  
Star in  
the Radio  
World*



“WHEN KNIGHTHOOD WAS IN FLOWER,” Crusaders in distant lands communicated with their own countries by carrier pigeon. The system, learned from the Saracens, was greatly perfected by the Crusaders. *Today*, ordinary radio reception has been excelled by a new perfection of the art—MU-RAD RECEIVERS. Swift as thought, clear as the voice, sensitive beyond belief! Cities, 4300 miles and more away, send their news and entertainment to the MU-RAD owner. Conservatively guaranteed for 1000 miles, using only a two-foot loop aerial.

WRITE FOR LITERATURE

**MU-RAD LABORATORIES, INC.**

803 FIFTH AVE. ASBURY PARK, NEW JERSEY

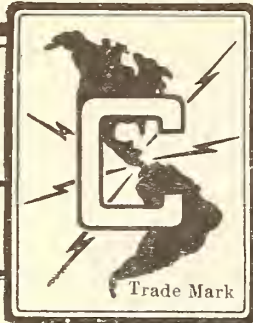

THE SYMBOL OF SERVICE

# CONTINENTAL

*"New York's Leading Radio House"*

## Grebe CR-12

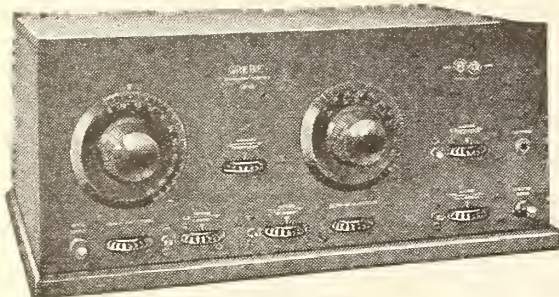

*Dealers! Quick turnover means profitable business. Grebe CR-12 will prove both to you.*

Is a receiver which is new to the radio public but old in the experimental laboratories of A. H. Grebe Co.

The CR-12 is the final result of ten years work by experts who have made a thorough study of radio both in this country and abroad. The receiver is designed for perfect local and long distance reception.

You can appreciate the many advantages and fine qualities of the Grebe CR-12, only by listening to a demonstration.

Step into our demonstrating room and we will gladly show you "How Simple it all is."



*Distributors for Grebe*

2058-Q

**CONTINENTAL RADIO and ELECTRIC CORPORATION**  
**SIX and FIFTEEN WARREN STREET NEW YORK, U. S.**

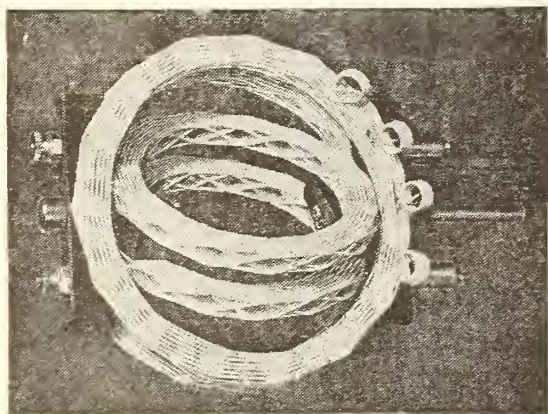

### R. M. C. Diamond Weave Variocoupler and Variometer

Due to diamond weave construction and the fact that  $\frac{7}{8}$  of the total area of windings are supported in mid-air, capacity and dielectric losses are reduced to a minimum in R. M. C. Variometers and Variocouplers. The rotor is continuously variable.

These products may be used in any circuit where a high grade coupler or variometer is required. All metal parts are nickel-plated. Panel mounting requires very small space. Screw holes covered by 2" dial.

R. M. C. products are built for the finest sets that can be constructed.

Variocoupler..... \$4.25  
 Variometer..... \$4.25

Write for catalogue of other diamond weave coils and Radio Frequency Transformer. ★

**THE RADIO MANUFACTURING CO.**  
 of Springfield, Massachusetts  
 Dept. B 97 Dwight St.

## Reliable RADIO Goods

**Results Are Sure With RELIABLE Goods**

And it's easy to get such goods—anything you want in radio equipment. Big, complete stock—everything guaranteed; quick service; right prices. And you're sure it's reliable when it comes from Andrae. Get our complete catalogue—free.

**JULIUS ANDRAE & SONS CO.**  
 112 Michigan Street Milwaukee, Wisconsin

**ANDRAE** *In Business Since 1860*

# MARKO

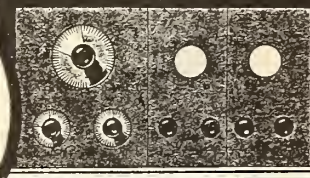

The Mark of Quality for **RADIO**  
**ALWAYS DEPENDABLE**

**MARKO STORAGE BATTERY CO.**  
 Atlantic Ave. Brooklyn, N. Y. ★



# Aladdin's Lamp Outdone

IN the fairy stories they asked Aladdin for music and by rubbing his wonderful lamp he produced it for them. No doubt if they had wanted crop and market reports or a bedtime story Aladdin could have produced them also. But these were fairy stories. Whoever thought they would come true?

## PARAGON

*Reg. U.S. Pat. Off.*

### RADIO PRODUCTS

Tonight if you sat down with a PARAGON Three-Circuit Receiver you could hear the music of a world-famous orchestra or the marvelous voices of opera singers just as clearly as if you were sitting in the same room with them. You can choose the program you want and enjoy it without interruption.

The name "PARAGON" on radio products means perfection. To listen in with a Paragon set is to experience the full fascination of the world's latest wonder.

*An Illustrated Catalog of Paragon  
Radio Products Is Yours For the Asking*

DEALERS: We believe in the proper distribution of Paragon Radio Products. Our exclusive Distributors are particularly interested in territorially protected dealers, who will concentrate, solicit and serve the consumer in the sale of Paragon Radio Receivers. If interested, write us for details.

ADAMS-MORGAN COMPANY  
10 Alvin Ave., Upper Montclair, N. J.

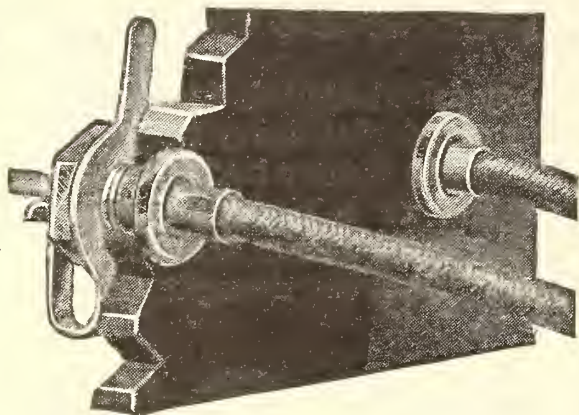

Illustration shows Type  
RD-5 Regenerative  
Receiver and Detector  
—\$60.00

Type A-2 Two-Stage  
Amplifier—\$40.00  
(Licensed under  
Armstrong Patents)

Quick, Positive Connections

# UNION RADIO TIP JACKS



Cost Only 25c a Pair

That they give you quick, positive temporary connections is only one of the many big advantages of Union Radio Tip Jacks. Just what you want when you build your own set or experiment with different circuits and hook-ups.

They can be attached to all standard thicknesses of panels. The bushing is  $\frac{1}{4}$ " in diameter and fits a  $\frac{17}{64}$ " hole. Will grip all wires from 24 B & S gauge up to antenna wire, battery leads, loading coils and vacuum tube lugs.

No parts to chip, lose, and deteriorate. All parts heavily nicked.

### Other Guaranteed Parts

Dial adjusters for minute variations in capacities of variable condensers. Price 60c.

Variable Condensers. Famous for performance. Without dials, 3 Plate—\$1.00, 13 Plate—\$2.00, 23 Plate—\$2.30.

Tube sockets of molded condensite highly polished. Phosphor Bronze contact springs. Reinforced bayonet slot prevents breakage. Accommodates all standard tubes. Price 75c.

Should your favorite Radio Store not carry Union Radio Tip Jacks and Guaranteed Parts send your order direct to us, also write for your copy of "The Union Radio Catalogue B."

### Retailers and Wholesalers

Samples of our guaranteed, reasonably priced "Quality Products" sent on request. Our terms and trade discounts are liberal. Write for our proposition.

UNION RADIO CORPORATION  
200 MT. PLEASANT AVENUE, NEWARK, N.J.  
NEW YORK OFFICE 116 WEST 32<sup>ND</sup> STREET.  
lllll

## ★ "UNITED" Radio Condensers and Transformers

NO matter what you pay for radio parts you generally get just what you pay for—cheap parts are cheap—not only in price but in materials and workmanship, and you can only expect to get cheap results.

"United" Radio parts are not built to meet a price—but to meet the exacting requirements of the radio set owner. The price is then figured. Large production, modern machinery and plant—good management—all combine to keep the price way down and yet the products are built as well both mechanically and electrically as it is possible to build them.

You take no chance when you buy "United" parts. We are so sure that they are correct that we will sell them on a money back guarantee.

### "UNITED" Variable Condensers without Vernier Dial and Knob

43 plate \$4.50	5 plate \$2.75
23 plate 4.00	3 plate 2.25
11 plate 3.50	Postpaid

With Vernier Dial and Knob  
46 plate \$6.50 26 plate \$5.50

If your dealer cannot supply, remit to us, sending in dealer's name.

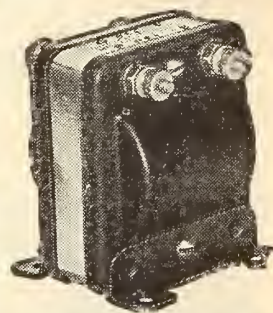

United Audio Frequency Amplifying Transformers \$4.50 Prepaid

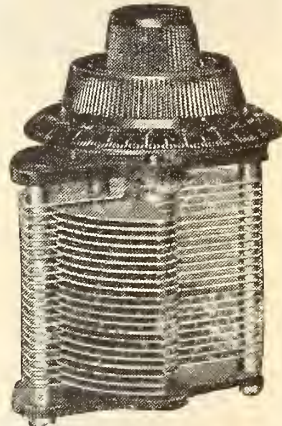

### UNITED MFG. & DISTRIBUTING CO.

9702 Cottage Grove Avenue Chicago, Illinois  
New York Office: 50 Church Street, New York, N. Y.  
San Francisco Office: 709 Mission St., San Francisco, Cal.

## \$1 Loud Speaker \$1 Radio Adapter

Hear all broadcasting through phonograph. Make your own horn. Attach B-R Phonadapter to YOUR phonograph. All can hear. Entire family, neighbors, guests can hear operas, lectures, latest news, with this adapter. Stretches over receiver of any standard type head-set and attaches to tone-arm of ANY phonograph. Made of soft, pure gum rubber. Quickly attached and removed. Thousands in use. Will not amplify or distort. For single receiver .50  
For pair of receivers (more than twice the volume) \$1



Go to your dealer. If he cannot supply you send money order, check or currency at our risk. Prompt delivery—postpaid. Also send us name of favorite radio dealer.

The Beckley Ralston Company  
1805 So. Michigan Ave., Chicago, Ill.

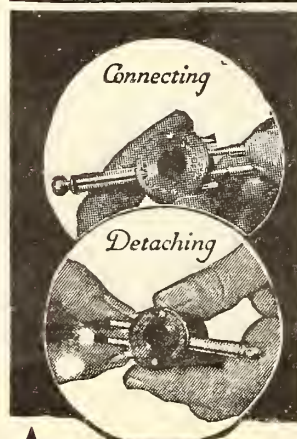

## Instant Change PLUG

New. Merely shove in phone cables to attach. Press triggers and pull out cables to detach. Perfect contact. No tools, inconvenience or broken fingernails. Experts everywhere admit its superiority.

At All Dealers—\$1.00

Sent upon receipt of price if your dealer cannot supply you



WESTON ELECTRICAL INSTRUMENT CO.  
179 Weston Ave. Newark, N. J.



# It's The Contact That Counts

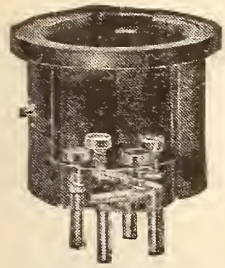

NA-ALD Adapter, No. 429 For UV-199 Tubes Price 75c.



NA-ALD De Luxe, No. 400 For 200 Series Tubes Price 75c



Small Space Socket No. 401 35c, 3 for \$1.00



NA-ALD WD-II No. 411, Price 75c

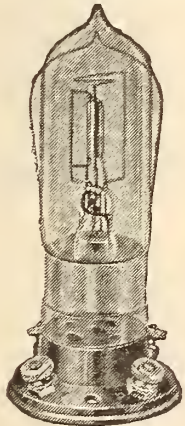

NA-ALD 2 in I Socket, No. 450, Price 50c. For WD-II and 200 Tubes

A careful examination will show that each contact in Na-ald sockets and adapters is of a wiping nature on a broad surface, and so designed that strong tension is permanent, no matter how often the bulbs may be removed or how much the connecting prongs in the tubes vary.

Na-ald Sockets are moulded of Bakelite with uniform cross-section and cure, and other engineering features incorporated to avoid plate to grid losses and to insure that each tube develops its fullest efficiency.

The new Na-ald dials combine rare beauty of design with highest efficiency in use. These dials are moulded from genuine Condensite in such a way that absorption losses are reduced to a minimum. Knobs are so shaped that fingers do not conceal clear numerals and graduation on the bevel of Na-ald dials.

Na-ald Circuit Booklet packed with each Na-ald product.

*Write for "Why a Bakelite Socket?" and other descriptive literature.*



**Alden Manufacturing Company**

*Manufacturers of sockets and dials for every radio requirement*

Dept. B, 52 Willow St. Springfield, Mass.

Cable address, Aldenco

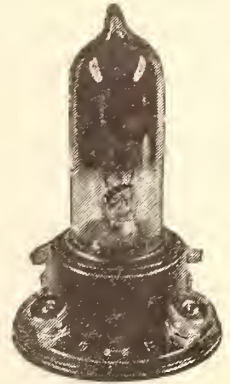

NA-ALD Special Socket, No. 499 For UV-199 and C-299 Tubes, Price 50c

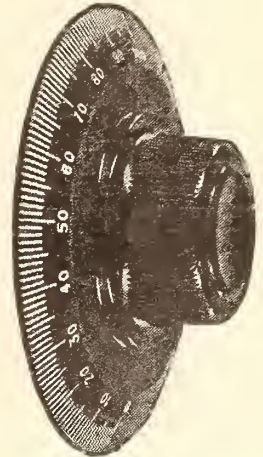

No. 3783— $\frac{2}{3}$  inch insert  
No. 3784— $\frac{1}{4}$  inch insert  
 $3\frac{1}{8}$  inch Dial  
Price 75c

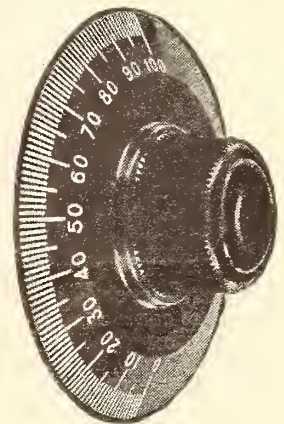

No. 3003—4  
3 inch Dial  
Price 35c, 3 for \$1.00

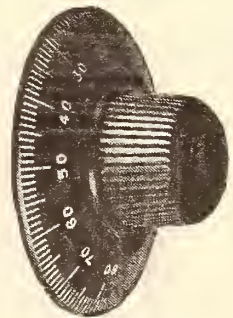

No. 3023—4  
2 inch Dial  
35c, 3 for \$1.00

**NA-ALD**

★ Tested and approved by RADIO BROADCAST ★

# Vacuum Tubes Do Triple Duty With Erla Synchronizing Transformers



Perfect synchronization of received and reflexed r. f. currents make Erla radio transformers indispensable in reflex work. List, \$5



Erla tested capacity condensers are unequalled in rigid, unvarying accuracy, so vital to success in reflex work. Eleven sizes, 35c to \$1 ea.

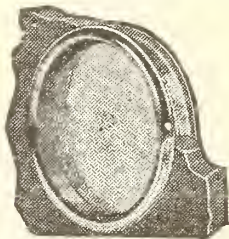

Erla bezels greatly enhance the finest cabinet assembly. Telescoping rim, in bright nickel or dull enamel, fits any 1/8" to 1/4" panel. List, 20c

Dealers and Jobbers—Erla progress constantly widens avenues of trade. Write for liberal terms and discounts

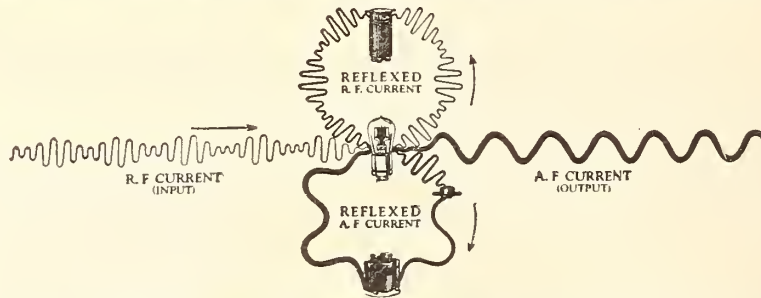

For the first time, the full efficiency of vacuum tubes is completely utilized and brought under control. In Erla reflex circuits, tubes do triple duty, providing simultaneous amplification of radio frequency, reflexed radio frequency and reflexed audio frequency currents. Yet, so precise is the manipulation of this complex current flow, that the tremendous gains resulting are achieved without a single drawback.

Not only do Erla reflex circuits demonstrate decisive superiority in range and volume, but they are also unequalled in selectivity, purity of tone, and ease of control. Even the single-tube circuit provides far-flung loud speaker range, while the three-tube circuit surpasses costliest multi-stage units in transcontinental loud speaker reception. And the two-tube circuit is close behind.

Essential to the operation of these circuits, and the secret of their success, are Erla synchronizing radio and audio transformers. Providing perfect synchronization of received and reflexed currents having the same phase characteristics, they assure tremendously magnified amplification without distortion.

Complete diagrams and descriptions of perfected Erla reflex circuits are set forth in Erla Bulletin No. 14, obtainable gratis from leading radio dealers. Or write us direct, giving your dealer's name.

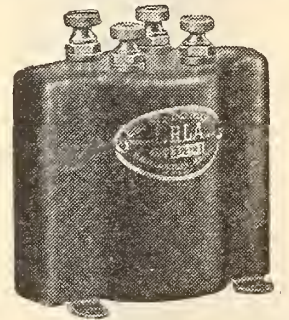

Rectified radio frequency and reflexed audio frequency currents are accurately synchronized by Erla audio transformers. List Price, \$5

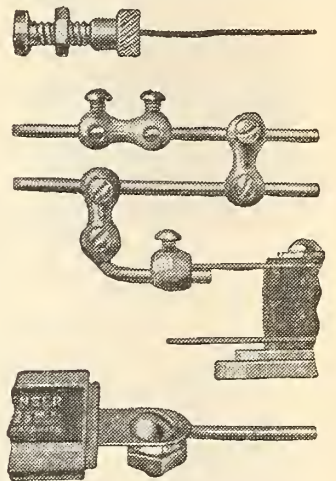

Difficult, dangerous use of soldering irons is eliminated by Erla solderless connections, saving time, temper and money. List, 5c ea.



Providing utmost sensitivity with perfect stability, the Erla fixed crystal rectifier is uniquely adapted for reflex work. List, \$1

Electrical Research Laboratories  
Dept. B 2515 Michigan Avenue, Chicago



**Ear-Joy**  
\$1.00 a Pair  
**HEADPHONE CUSHION**  
HUDSON-ROSS  
123 WEST MADISON ST.  
CHICAGO

**SEND NO MONEY** **Guaranteed!**  
3,000 OHMS  
**\$3.98**  
Money back if they do not satisfy after **5 DAYS TRIAL**  
SEND no money! Order by postcard and pay postman on arrival. If they do not excel any other phones you ever used regardless of price, return them and your money will be refunded at once.  
**GUARANTEED ONE YEAR**  
**AMBASSADOR LONG RANGE PHONES**  
TOWER MFG. CORP., 98 BROOKLINE AVE., BOSTON, MASS., DEPT.

# BRANSTON D. L. HONEYCOMB COILS AND MOUNTINGS

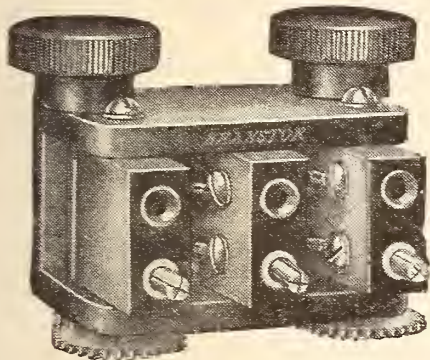

**R-61 Three Coil \$5.00**  
Geared Type. Front panel mounting. Substantial gears give vernier adjustment. Very neat appearance made of Genuine Bakelite, complete with flexible leads.



Study these mountings carefully. Our new No. R61 3-coil front panel mounting and No. R62 rear panel mounting are equipped with strong brass nickel plated gears, insuring smooth vernier adjustment with no chance of stripping gears. Back geared type is equipped with arrow knobs that show position of coils. Mountings are substantially constructed of genuine Bakelite and are equipped with flexible leads.

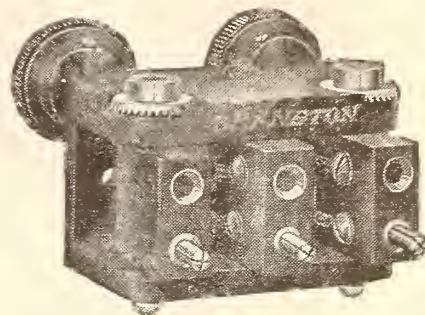

**R-62 Three Coil \$6.00**  
Bevel Geared type. Back Panel Mountings. Bevel gears provide very smooth operation and vernier adjustment. Made of Genuine Bakelite, complete with flexible leads. Arrow knobs show position of coils.

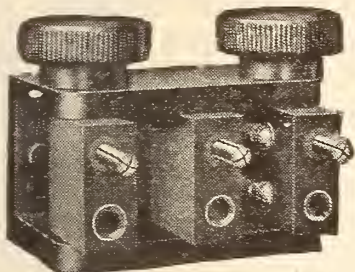

**R-73 Three Coil \$4.50**  
Bakelite Mounting. Neatest three coil mounting on the market. Made of Genuine Bakelite and complete with flexible leads.

Branston D. L. Honeycomb coils are accepted as standard in regards to superior construction and electrical units of measurement. Your dealer can purchase Branston Coils and Mountings from his distributor. Insist on the Genuine.

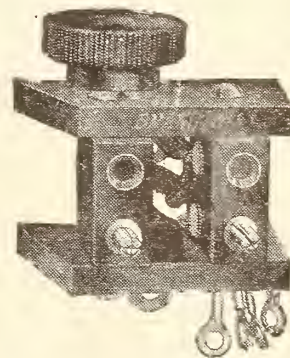

**R-71 Two-coil \$3.25**  
mounting. Very neat and capable of smooth operation. Only two mounting screws required. Complete with flexible leads.

Send 2c. in stamps for Series I "Hook-Up" circulars showing five good Honeycomb Coil Hook-Ups and Catalogue of famous Branston Radio Apparatus. Write to-day. Give us name of your radio dealer. If he can't supply you, write

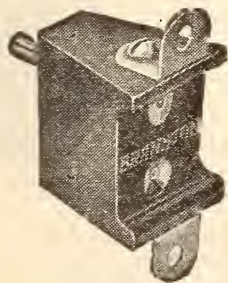

**R-77 Bakelite Mounting with 50c**  
brackets instead of screws for mounting.



**CHAS. A. BRANSTON, Inc.**  
813 Main St. Buffalo, N. Y.  
In Canada—Chas. A. Branston, Ltd.,  
Toronto, Ont.

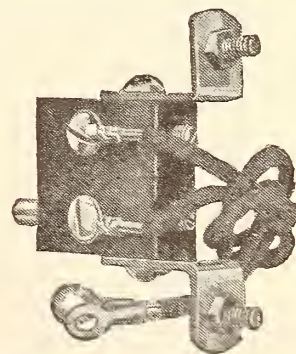

**R-68 Single movable 90c**  
Bakelite Plug with extension angle brackets and flexible leads.

**R-69 Same as No. 90c**  
R-68 only stationary.



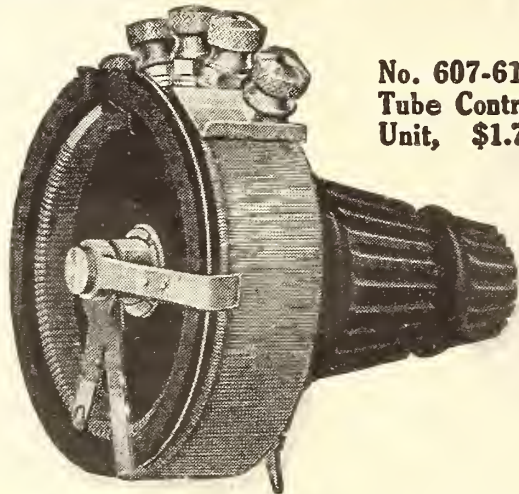

No. 607-610  
Tube Control  
Unit, \$1.75

**Tube Control Unit—**  
a new item of  
**FROST-RADIO**

**T**HE first practical solution of the problem of consolidating rheostat, with vernier, and potentiometer, in a single instrument. A Frost-Radio Quality Product. Has maroon bakelite base, polished, and fluted black polished bakelite knob. Single hole mounting, with locating tip to prevent turning. Nickel plated and buffed posts, lever and pointer. Supplied in 6 and 35 ohm rheostat, 400 ohm potentiometer styles.

Other new items of Frost-Radio you should see at your dealer's are Plain and Vernier Rheostats, and Potentiometers, in bakelite and metal frame; Bakelite Plain and Shock Absorber Sockets, Single and in gangs, Dials, Switches, Adapters and Resistance and Inductance Units. Your dealer has them or can get them for you. ★

**HERBERT H. FROST, Inc.**  
154 West Lake Street, Chicago  
30 Church Street, New York



*The Ideal Gift*

**\$15.00**

F. O. B. Cleveland

Type 6 charges 6 Volt Storage Battery from any 110 Volt 60 Cycle lamp socket at average rate of 6 amperes, or over if battery needs it.

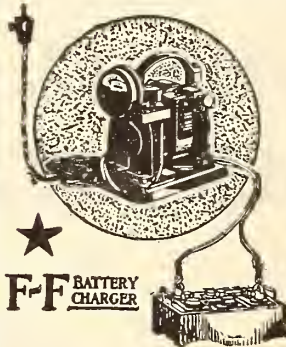

★  
**F-F BATTERY CHARGER**

**The Satisfactory Charger For Ten Years Past**

The F-F, the first successful mechanical charger, is now the most popular. F-F features are distinctive, its construction is simple, and the absence of breakable parts which are expensive to replace, is almost sufficient reason for you to own the F-F; but the satisfaction you will buy with the low purchase price of the F-F is further reason why you should insist on the F-F.

Buy from your dealer. There's a type for every need. If he cannot supply you, write for literature or enclose remittance covering express or postal charges on 9 lbs.

Write Immediately for Free Charger Bulletin

**THE FRANCE MFG. CO.**  
10441 Berea Road Cleveland, Ohio  
*Pioneer Manufacturers of Patented Battery Chargers*

**WE REPAIR RADIO TUBES**

WD-11.....\$3.50	UV-199.....\$3.50
WD-12.....3.50	UV-299.....3.50
UV-200.....2.50	UV-201-A.....3.75
UV-201.....3.00	C-301-A.....3.75
C-300.....2.50	UV-202.....4.00
C-301.....3.00	C-302.....4.00

MAIL ORDERS SOLICITED AND PROMPTLY ATTENDED TO  
Dealers and Agents Write for Special Discount

**H. & H. RADIO COMPANY**  
Clinton Hill Station  
P. O. Box 22-P NEWARK, N. J.

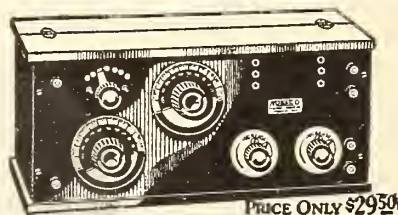

PRICE ONLY \$29.50



At the low prices shown below you get the efficiency of sets costing three times as much.

These radio frequency receivers—pick up stations over 1,500 miles away under good conditions—everywhere.

Operate either on DRY CELLS or storage battery. Cabinets of solid mahogany and workmanship the finest throughout. Order direct or send for bulletin.

Two tube outfit, as shown above, for use with headphones only \$29.50  
Four tube outfit for loudspeaker or headphones 54.50

Dealers, Agents—write for proposition quickly—it's a winner.

★ **THE MIDWEST RADIO COMPANY**  
806 Main Street Cincinnati, Ohio



## *Just off the Press*

Upon request, our latest radio catalogue will be sent to those interested in the construction of receiving sets—without charge.

Each part we manufacture is illustrated and described in detail.

*Write for it today.*



**EISEMANN MAGNETO CORPORATION**

William N. Shaw, *President*  
**BROOKLYN, N. Y.**

DETROIT

CHICAGO

SAN FRANCISCO

# "ALL-AMERICAN"

Sets another  
**World Record!**

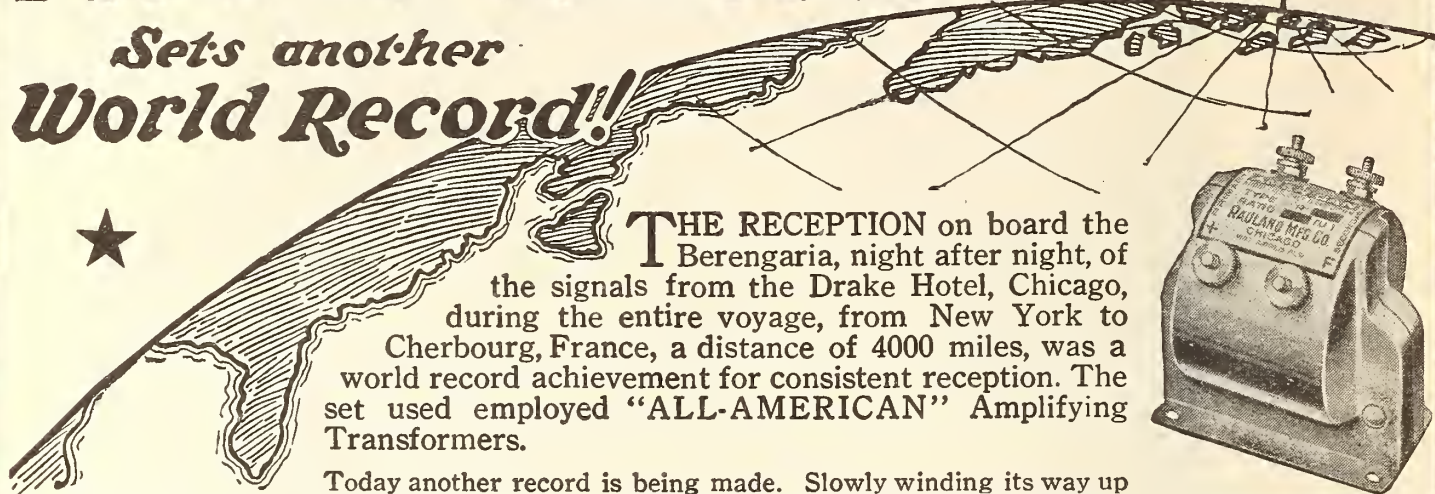

★ THE RECEPTION on board the Berengaria, night after night, of the signals from the Drake Hotel, Chicago, during the entire voyage, from New York to Cherbourg, France, a distance of 4000 miles, was a world record achievement for consistent reception. The set used employed "ALL-AMERICAN" Amplifying Transformers.

Today another record is being made. Slowly winding its way up into the frozen North is the Bowdoin, on board of which is Captain Donald B. McMillan, on a scientific expedition to the North Pole.

Night after night, up in the Artic Ocean, he is listening to the world thousands of miles south of him. Again "ALL-AMERICAN" Amplifying Transformers are being used, and again new world records are being achieved.

You, too, can set new records with your own set by the use of "ALL-AMERICAN" Amplifying Transformers.

Ask your dealer to show you these world record-breaking instruments. They are as attractive as they are efficient.

Book of Successful Hookups sent free on receipt of 2c for postage.

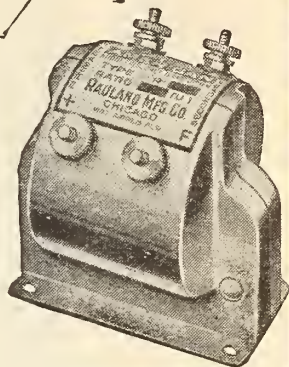

Audio Frequency Transformer



Radio Frequency Transformer



**RAULAND MFG. CO.**  
200 No. Jefferson St., Chicago, Ill.



## Free Your Set From INTERFERENCE



The U. S. Army Signal Corps use loops to obtain absolutely unlimited, uninterrupted radio communication. To really enjoy your super-sensitive set, banish interference from static, stray atmospherics by using a loop aerial the best you can buy—a Warren Radio Loop. More "persistent" than the dangerous, cumbersome old-fashioned outside aerial. Easier to tune. Built on stronger frame and protected from dust, dampness and meddling by tight cover. Types for all wave meter lengths from 175 to 18,000. Most compact, efficient loop perfected. Buy a Warren Radio Loop Now!

- Type-A-737 (300-700 meters) 6 inches square—non-directional.....\$10.
- Type-A-7236 (175-1000 meters) 6 inches square—non-directional.....\$12.
- Type-B-2537 (300-700 meters) 18 inches square—directional.....\$20.
- Type-BL-2520 (200-18,000 meters) with honeycomb coil mounting. 18 inches square—directional...\$25.

SEND FOR BULLETIN X-102

V-DE-CO RADIO MFG. CO., Dept. B, ASBURY PARK, N. J.

## RADIO PANELS

Cut exactly to size and a guaranteed 12 hour shipment. 1/4" thick .01 1/2c per square inch, 3/16" thick .01 1/4c. Made of the highest grade black fibre. This material possesses electrical strength of 200 volts per mil, is inexpensive, unbreakable, easy to work and takes a fine finish. We pay postage. RADIO INSTRUMENT & PANEL CO., 564 W. Monroe St., Chicago, Ill.

## W.T.501 DETECTOR TUBE

\$2

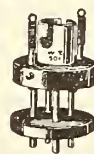

For tube sets, use our Special Adaptor, 75c extra. To convert crystal sets into tube sets, use Special Socket, 40c extra.

Radio Research Guild  
40 Clinton St. Newark, N. J.

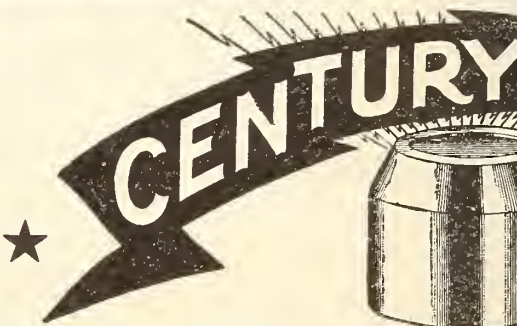

## THE WONDER-WORKER, THE RADIO SENSATION

Surface perfectly smooth and supersensitive everywhere  
**CENTURY MAXITONE DETECTOR, Price \$1**

Order from your dealer or direct from us

Century Products Co., 110 So. 13th St., Allentown, Pa.



## THE IMPORTANCE OF VARIABLE CONDENSERS

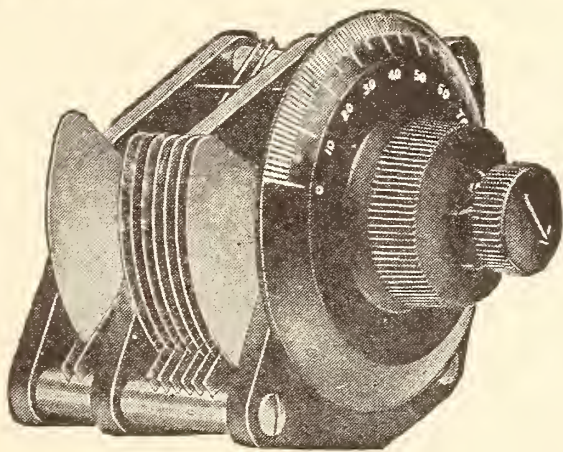

**N**EARLY all modern receiving circuits contain one or more variable condensers. Upon the performance of these vital parts depends largely the degree of success of your receiving set. It is easy to produce condensers which look efficient, but effectiveness in these parts is much more than skin deep.

### CHELSEA VARIABLE CONDENSERS

Enable any receiving circuit to give its best. Plates are die cast into solid units giving permanence of electrical and mechanical connections and rigidity at all times. This is the only sure method of construction which avoids corrosion and insures low resistance. Insulating material is the best obtainable—genuine bakelite—molded by Chelsea. This insures low electrical losses. Large brass self-aligning bearings eliminate all play and maintain the proper air gap at all times. Plates are of heavy stock of the proper design. These are some of the reasons why you should use Chelsea condensers to achieve the results you hope for.

Made in eleven styles, they form a complete line in which there is the proper type and capacity for any receiving circuit.

*Prices from \$2.50 to \$6.75*

#### OTHER QUALITY CHELSEA PARTS:

Variometer with Vernier . . . . .	\$8.00	Rheostats . . . . .	\$1.00 and \$1.40
Variocouplers . . . . .	\$8.00	Tube Sockets . . . . .	.50 and .75
Audio Transformers. . . . .	\$3.75 and \$4.50	Dials . . . . .	.40, .45, and .50

*Write to Department 6 for our large catalogue, which illustrates and describes the complete line of Chelsea Receiving Sets and Parts*



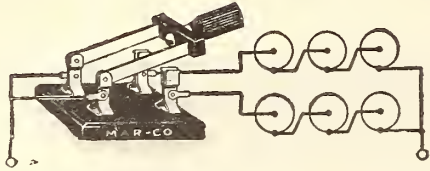

**E**CONOMICAL operation of UV 199 tubes requires a series-multiple connection of dry cells. Difference in age and voltage existing between separate series lines will cause current to flow through the multiple connections even when the battery is apparently standing idle, ruining the cells and causing them to disrupt and discharge electrolyte to cause damage.

The diagram shows a trouble proof arrangement for running UV 199 tubes on a series-multiple connection of six cells using a knife switch to open each series line of cells making interaction impossible when the battery is not in use. Similar arrangements will work with any multiple battery and any tubes.

No better circuit breakers can be had for such a purpose than MAR-CO MINIATURE KNIFE SWITCHES. They are made with one, two, or three blades, either single or double throw, are substantially made, handsomely finished in polished nickel and list from sixty cents to one dollar and a half.

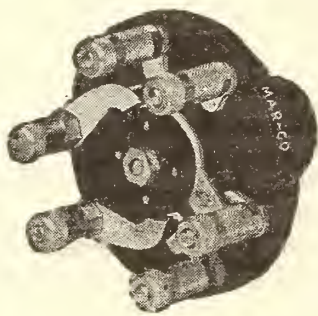

**F**OR the ordinary three tube panel mounted set the MAR-CO ROTARY DOUBLE POLE DOUBLE THROW SWITCH is well adapted where six cells are used as in the sketch. This instrument mounts through one drilled hole in the panel, is operated with a handsome bakelite knob and lists for one dollar and a quarter.

*See them at your dealers.*

**MARTIN-COPELAND COMPANY**  
PROVIDENCE, R. I., U. S. A.

*Approved!*

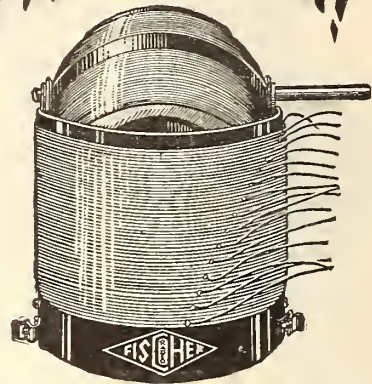

**Approved by Radio Experts  
for Radio Amateurs**

Approved because:—

Wave length is 550 Meters; 16 soldered leads; straight wound stator on genuine bakelite tubing; kiln dried rotor; Fahnestock spring clip connections; non-conductive adhesive; You can

**GET ONE FOR \$3.50**  
**20 DIAGRAMS FREE WITH EACH**

For sale at your dealer's—otherwise send the \$3.50 directly to the manufacturer and you will be supplied postpaid.

**G. H. Fischer & Co.**

123 Liberty Street

New York City

**Give it  
Every Chance!**

If you want your radio tubes to function at the highest degree of efficiency—totally free from body capacity effects—panel your set with this remarkable material.



**bakelite  
dilecto**

*(A Laminated Phenolic Condensation Material)*

The X-X grade of Bakelite-Dilecto is absolutely perfect for radio paneling. Unaffected by heat, cold, water, oil, solvents or milder acids. Highest in dielectric strength. Cannot warp or swell. Finished a handsome, sleek black. Amazingly tough, yet readily machined. Ask any electrical man to get Bakelite-Dilecto, X-X, cut to size for you.

**THE CONTINENTAL FIBRE COMPANY**

Factory: Newark, Delaware

Service from:

New York, 233 Broadway  
Chicago, 332 S. Michigan Ave.  
Pittsburgh, 301 Fifth Ave.

San Francisco, 75 Fremont St.  
Seattle, 1041 Sixth Ave., So.  
Los Angeles, 411 S. Main St.



# The "A" Battery's Power in Your ★ Radio Receiving Set

THIS IS NUMBER TWO OF A SERIES

**T**HE sole purpose of the "A" Battery in your Radio Receiving Set is to furnish current to heat the filaments of the tubes.

And this can be done satisfactorily only by an "A" Battery that supplies an adequate steady current.

Anticipating the popularity of the dry cell tube in Radio, and realizing that it required a Dry Cell capable of standing up under service conditions differing from what dry cells are called upon to meet in other fields, the National Carbon Company developed the Eveready Radio Dry Cell specifically for this new use.

A dry cell gives its maximum service only when designed especially for the work it is intended to perform. There are for dry cells several uses which are so alike that one type of cell serves for all. This is the field covered by the ignition or general purpose dry cell.

The conditions encountered in Radio are different from the conditions grouped together under the term "general purpose." And while the general purpose dry cell performs well as an "A" Battery, it was found possible to produce a Dry Cell "A" Battery capable of delivering more service on Radio loads.

Thirty years of dry cell experience and an immense research organization resulted in the superior Eveready Radio Dry Cell. One of the outstanding features of this special cell is that while it will last much longer when used as an "A" Battery, it is no larger than the standard dry cell.

The increased service life of the Eveready Dry Cell "A" Battery greatly offsets the slight increase in cost; so this battery is not only the best, but it is the most economical you can buy. "The Story of Eveready Dry Cell Radio 'A' Batteries," which tells how to use Dry Cells to the greatest advantage with the various dry cell tubes now available, will be sent to you free on request.

\* \* \* \*

The "A" Battery gives power to your Radio Receiving Set. Eveready Batteries—especially made for Radio—serve better, last longer, give better results.

*Note: This is number 2 of a series of informative advertisements which will appear in this magazine. They are designed to help users get the most out of their Batteries and their Radio Sets. If you have any battery problem, write to G. C. Furness, Manager Radio Division, National Carbon Company, Inc., 126 Thompson Ave., Long Island City, N. Y.*



## POWER

for Your Radio Set

Eveready Dry Cell  
Radio "A" Battery  
(No. 7111)

Directions and wiring on the jacket tell just how to use this battery with the different dry cell tubes.

This special Radio Cell is also available in two and four cell multiple batteries for receiving sets employing from two to four WD-11 or WD-12 tubes.

### Other Radio Batteries

Eveready Storage "A" Batteries—best suited for filament heating of all Radio Tubes not especially designed for dry cells. The quality storage battery with the long life plates, \$15 to \$20.

Eveready "B" Batteries—the life of your Radio.

Eveready "Three" Battery—3 cells, 3 purposes.

*Manufactured and guaranteed by*

**NATIONAL CARBON COMPANY, Inc.**

# EVEREADY

## Radio Batteries

—they last longer

**WEIGHS ONLY 8 OZ**

**The Scientific**

**A \$200,000.00 COMPANY stands squarely back of the guarantee on every Scientific headset**

**SEND NO MONEY!**

**20,000 TURNS EQUIVALENT TO 3,000 OHMS**

**Order TODAY by Postcard and Pay Postman on arrival**

**THE PHONE IT TOOK A SOLID YEAR TO DESIGN**

**\$2.95**

**POST-PAID**

**LOUD SPEAKER UNIT \$1.95**



**We Guarantee** The *Scientific* Headset to be the greatest value on the market. Try it for five days. If not satisfactory send it back and your money will be refunded immediately. Circular on request. Dealers wanted.

**THE SCIENTIFIC ELECTRIC WORKS**  
 98 Brookline Ave. DEPT. I BOSTON, MASS.



**R. M. C.**  
**Radio Frequency Transformer**  
**PRICE \$3.50**

A metal shielded, tuned transformer, very selective, easily tuned.  
 No high peak of amplification, efficient over the entire band of wave lengths.  
 Style A. for all Broadcast reception up to 700 meters.  
 Style D. X. for C. W. and spark stations to 350 meters.

*Write for catalogue on Reinartz Style and other Diamond weave coils.* ★

**The Radio Manufacturing Company**  
 Dept. C 97 Dwight Street Springfield, Mass.

**"DUTCH RADIO VALVE"**  
**Detector and Amplifying Tubes**

Buy the wonderful "Dutch Radio Valve" for your receiving set. They are guaranteed.

6 Volt Detectors	\$2.50
6 Volt Amplifiers	\$3.00
3 Volt Guaranteed	\$3.00
1½ Volt Detectors	\$2.50

Mail Orders solicited. Send Bank Draft or Postal Money Order

**D. R. V. IMPORTING CO.**  
 515 Orange St. Newark, N. J.  
**DEALERS: WRITE FOR DISCOUNTS**

**METALECTRIC SOLDERING IRON**  
 (The All-Metal Quality Instrument—Guaranteed)

**"A Solution to the small soldering problems of the discriminating assembler"**

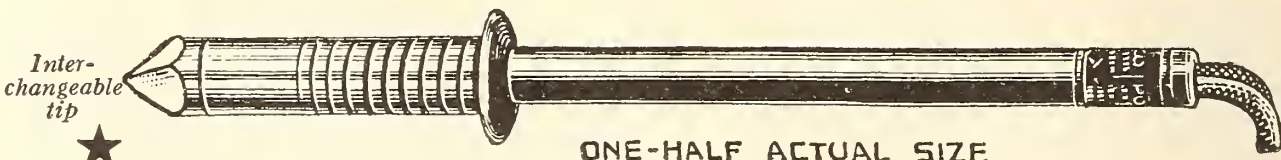

Inter-changeable tip ★

**\$5.50**

ONE-HALF ACTUAL SIZE

Unbreakable Construction—Economical Operation on any Electric Circuit  
 from your dealer or write

**POST ELECTRIC CO., Mf'rs.** (Radio Section) 30 East 42nd St., N. Y. C.

★ Tested and approved by RADIO BROADCAST ★

**New!**  
Westinghouse  
**CRYSTAL CASE**  
"A" Batteries

1 cell — 2 volts  
2 cells — 4 volts  
3 cells —  
6 volts

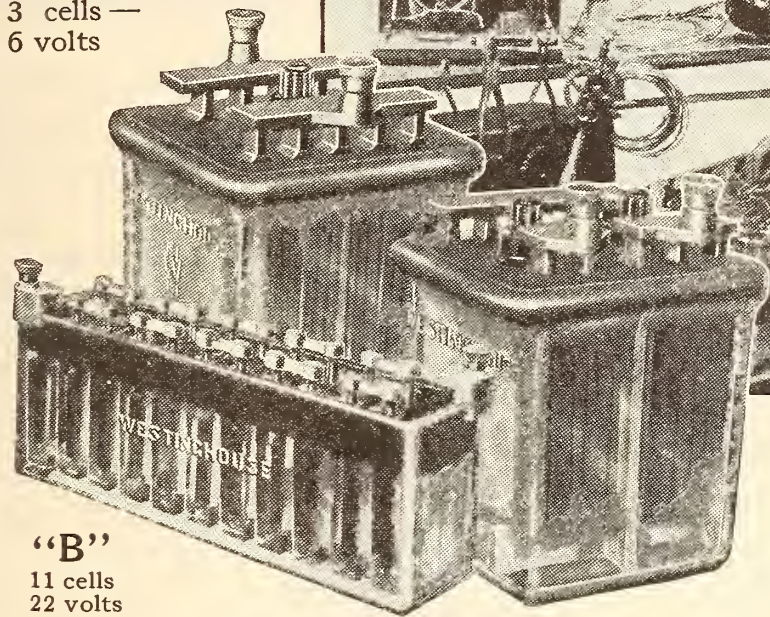

"B"  
11 cells  
22 volts



# Are You Improving Your Set This Fall?

**N**OW that radio broadcast reception has emerged from the early development stage natural with all great inventions; now on the eve of a long winter of radio treats more elaborate and finer than ever, thousands of radio fans are rebuilding or re-equipping their sets with units that have thoroughly proved their worth.

Batteries. You can't be too critical in choosing them. Westinghouse rechargeable storage batteries have won high favor everywhere. Even-powered, full-powered, slow-discharging, they've demonstrated their superiority for fine tuning, signal-holding, sound volume and operating economy. See your dealer and ask for Westinghouse **CRYSTAL CASE** Batteries. The line is complete—a type and size for every popular radio use.

**WESTINGHOUSE UNION BATTERY CO.**  
Swissvale, Penna.

Westinghouse  
**CRYSTAL CASE "A" Batteries**

One-piece glass case, with solid glass plate rests. Neat and durable. Visible interior—liquid level readily inspected. Easily recharged.

Westinghouse  
**CRYSTAL CASE "B" Batteries**

The 22-MG-2 (22 volts) is a marvel for steady, noiseless, full-powered service. Long-lasting—easily recharged. Larger types, too.

# WESTINGHOUSE

## CRYSTAL CASE

"A," "B" and "C"

# BATTERIES

★ Tested and approved by RADIO BROADCAST ★

# ANNOUNCEMENT

Genuine PACENT

\*Duo Lateral Coils Mounted

\*REG. U. S. PAT. OFF.

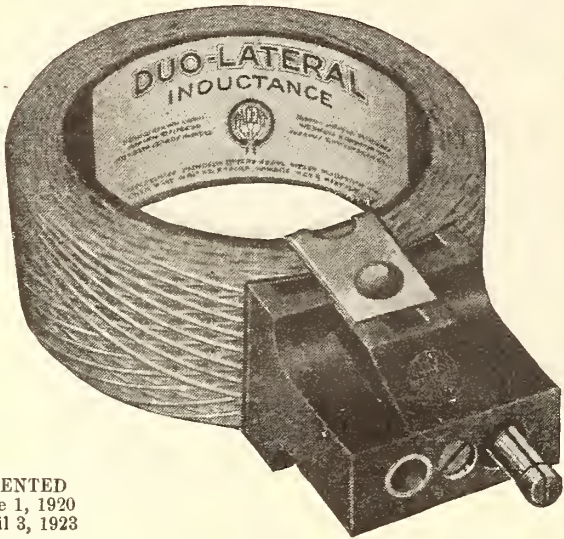

PATENTED  
June 1, 1920  
April 3, 1923

## A Complete Line of Improved Coil Equipment

- I. PACENT COIL PLUG—Quick to connect. Vise grip on coil. Set screw connections with coil leads. Cat. No. 110. Price \$1.00.
- II. COIL PLUG RECEPTACLE—an improved receptacle. Special Pacent feature to insure tight contact. Cat. No. 111. Price \$1.00.
- III. MOUNTED COILS—The genuine Pacent Duo Lateral Coils equipped with improved plug. Sizes MS 25 to MS 1500. The perfect combination. Prices \$1.40 to \$3.85.
- IV. MICROMOUNT—a de luxe 3 coil mounting affording fine vernier coupling adjustment. Cat. No. 115, with base, \$9.50. Cat. No. 115A, same as No. 115 less base and binding posts, \$8.00.
- V. MICROCOUPLE RECEPTACLE—a single receptacle permitting vernier adjustment of coil. Cat. No. 118. Price \$2.00.
- VI. PANEL RECEPTACLE—a fixed receptacle for panel mounting principally for use with Cat. No. 118. Cat. No. 119. Price \$1.50.

*Duo Lateral Coil Labeled PACENT is the GENUINE*

Don't Improvise—"PACENTIZE"

*Send for Booklet B-11 describing Pacent Radio Essentials*

**PACENT ELECTRIC CO., Inc.**  
22 Park Place New York, N. Y.

*Sales Offices:*  
Chicago, Philadelphia, St. Louis, Minneapolis  
Washington, D. C., San Francisco, Jacksonville

# Pacent

**RADIO ESSENTIALS**



**World Radio  
and  
Auto Batteries**  
**SAVE YOU**  
**50%**  
WRITTEN 2 YR. GUARANTEE

Never before have you radio fans been able to buy high quality batteries at such amazingly low prices. World prices are possible because it costs the World Battery Company only one-half as much to sell World batteries. That is the reason we can spend just as much to *build* our batteries as any other big company. That is the reason "Worlds of Performance" can be built into every World battery. That is the reason we can stand behind every battery we put out with a written 2-year guarantee. You take no risk when you buy a World battery—service is certain.

### Compare These Prices

AUTO PRICES	RADIO PRICES
6 Volt, 11 plate.....\$12.25 Ford, Chev., Mitchell, Hup., Grant, Elgin, Velie, Saxon.	Special 2-Volt Storage Bat- tery .....\$5.00 For W. D. 11 and W. D. 12 tubes. Will run 200 hours on one charge. Rechargeable.
6 Volt, 13 plate..... 14.00 Overland, Buick, Reo, Paige, Hudson, Nash, Stude., Dort.	Special 4-Volt Storage Battery 8.00 For U. V. 199 tubes. Same features as 2-Volt.
12 Volt, 7 Plate..... 17.00 Maxwell, Dodge, Regal, Frank., Briscoe and Crow- Elkhart. Give year and model of car.	6 Volt, 60 Amp..... 8.50 6 Volt, 80 Amp.....10.00 6 Volt, 100 Amp.....12.50 6 Volt, 120 Amp.....14.50 6 Volt, 140 Amp.....16.00

### Send No Money

We ship C. O. D. subject to inspection or will allow 5% discount for cash with order. Shipment made same day order is received. Save 50% on your next battery and get better service and longer life. Written 2-year guarantee is your proof of satisfaction. Order NOW!

**World Battery Co.,**

Dept. 24, 1219 S. Wabash Ave., Chicago, Ill.

## THE SONOCHORDE

TRADE MARK

RADIO LOUD SPEAKER

"IT SPEAKS FOR ITSELF"

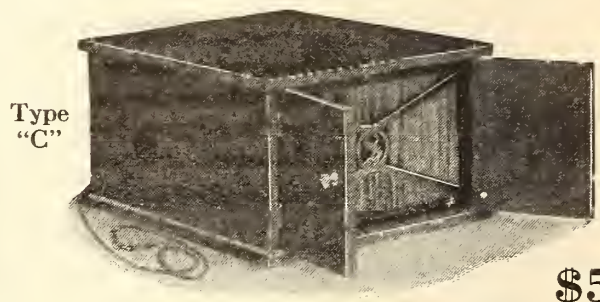

**\$50**

In Mahogany or Walnut  
Containing  
A NON-VIBRATING, NON-RESONANT  
HORN

A REPRODUCING UNIT WITH  
15 EXCLUSIVE FEATURES

In Design and Performance  
AMERICA'S BEST LOUD SPEAKER

*Write for 52 Points of Sonochorde Superiority  
Write for our proposition Jobbers and Dealers*

**BOUDETTE MANUFACTURING CO.**  
Dept. D 77 Beach St., Revere, Mass.

# Tells how to get those stations you read about but never hear



**BALLANTINE  
VARIOTRANSFORMER**

for  
Radio Frequency  
Amplification  
(Patents Pending)

On Sale at All Good Radio Stores  
or Postpaid, Price \$9.60

**CONTENTS**

	Page
Radio Frequency Amplification in the Modern Receiver....	6
Why R. F. Amplification?.....	7
Non-Regenerative <i>versus</i> Re- generative R. F. Amplification	8
Previous Methods of Non-Re- generative R. F. Amplification	8
Tuning the R. F. Amplifier..	10
New Method of Coupling—the Ballantine Variotransformer	10
Model 5 Variotransformer... 11	11
Mechanical Construction....	11
Mounting .....	13
Electrical Characteristics ....	14
Amplification	
Other Electrical Data	
Shielding	
Selectivity	
Model 5 R. F. Amplifier Unit.	18
For the Users of Crystal Sets.	21
For the DX Amateur.....	22
For the Broadcast Listener..	23

## “Radio Frequency Amplification with the Ballantine Variotransformer”

Here's a booklet that will help you get many stations that you've never heard before. Based on research of the Radio Frequency Laboratories, Inc., it gives the latest developments in tuned radio frequency amplification. Furthermore, it tells how to use the *continuously variable* BALLANTINE TRANSFORMER for both amateur and broadcast wave lengths—with amplification *uniformly high*.



Free for the asking, this 25-page booklet is full of facts, helpful information and practical diagrams. Edition is limited—better write for your copy at once.

**BOONTON RUBBER MFG. CO.**  
324 Fanny Road  
Boonton, N. J., U.S.A.

# ANNOUNCEMENT TURNNEY'S FAMOUS SPIDER WEB PLEX TUNER ★

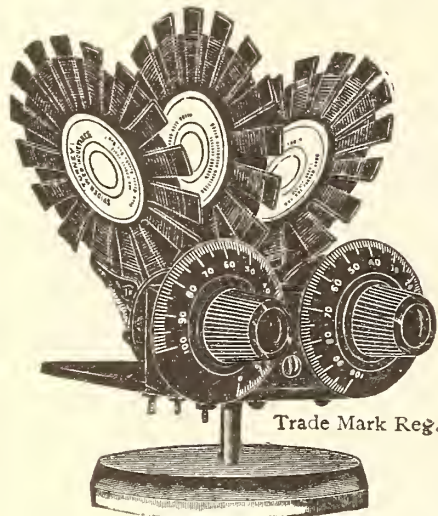

Trade Mark Reg.

is now available for mounting in the cabinet with two Dial Vernier control on the panel.

Three genuine Turnney Spider Web Coils with their wonderful tuning value in absolutely practical shape

**ELIMINATES VARIOCOUPLER AND VARIOMETER  
CLOSEST APPROACH TO ZERO TUNING  
EXTREME SELECTIVITY  
COVERS ALL BROADCASTING WAVE LENGTHS**

Spider Web Coils have the approval of EVERY RADIO ENGINEER, U. S. Bureau of Lighthouses, Millions of Radio Fans, Every Magazine Published.

**\$6.00**

Stand 25c extra

Packed with 4 Hookups—3 for Tube and 1 for Crystal Sets

**TRISTAN SALES CORPORATION, Dept. E**  
1 UNION SQUARE NEW YORK

*Sole National Distributors*

**REGIONAL REPRESENTATIVES**

Baker Smith & Co.  
741 Call Building  
San Francisco, Cal.

Geo. H. Chamberlain  
375 Broad St.  
Elyria, O.

O. P. Smith Co.  
205 W. Harrison St.  
Chicago, Ill.

Walter Ferguson & Co.  
208 Baltimore Bldg.  
Kansas City, Mo.

J. H. Lyte  
65 North 63rd St.  
Philadelphia, Pa.

C. L. S. Holmes Co.  
601 Boston Block  
Minneapolis, Minn.

# THE BEL-CANTO

acoustical amplifier commonly called "Loud speaker" is the outcome of over three years of study and scientific research by an eminent musician and acoustical expert.

It is not an experiment, but a perfect Acoustical Amplifier.

The unit used in this instrument is a special one with a perfect adjustable air gap. Constructed to give the greatest volume without distortion or tinniness which cannot be obtained with half a headset. Compare it with all other so-called devices at any price and you, like many others, will be convinced it is the highest quality instrument offered to the public.

**Being demonstrated at our Display Room, 202-204 W. 34th St.**

## 4 REASONS WHY

- |   |   |
|---|---|
| <p>1. Large Heavy Base Eliminates Top Heaviness.</p> <p>2. Re-enforced Fiber Horn Cannot Break. Gives perfect Reproduction.</p> | <p>3. No Adjustment Necessary; Will Work Perfectly on Any Good Two Stage Set.</p> <p>4. Guaranteed Against Mechanical Defects of any Kind for One Year.</p> |
|---|---|

These Are Exclusive Bel-Canto Features

**LOOK FOR THIS TRADE MARK**



*Write for territory and discounts*

**BEL-CANTO MANUFACTURING CO.**

BENSEL-BONIS CO., Inc.

417 East 34th Street

New York City

Actual photograph of Mr. H. L. Thompson of Brooklyn, N. Y., and the 1-tube receiver which he built from the instructions given by Kenneth Harkness in his new book "Radio Frequency Amplification."

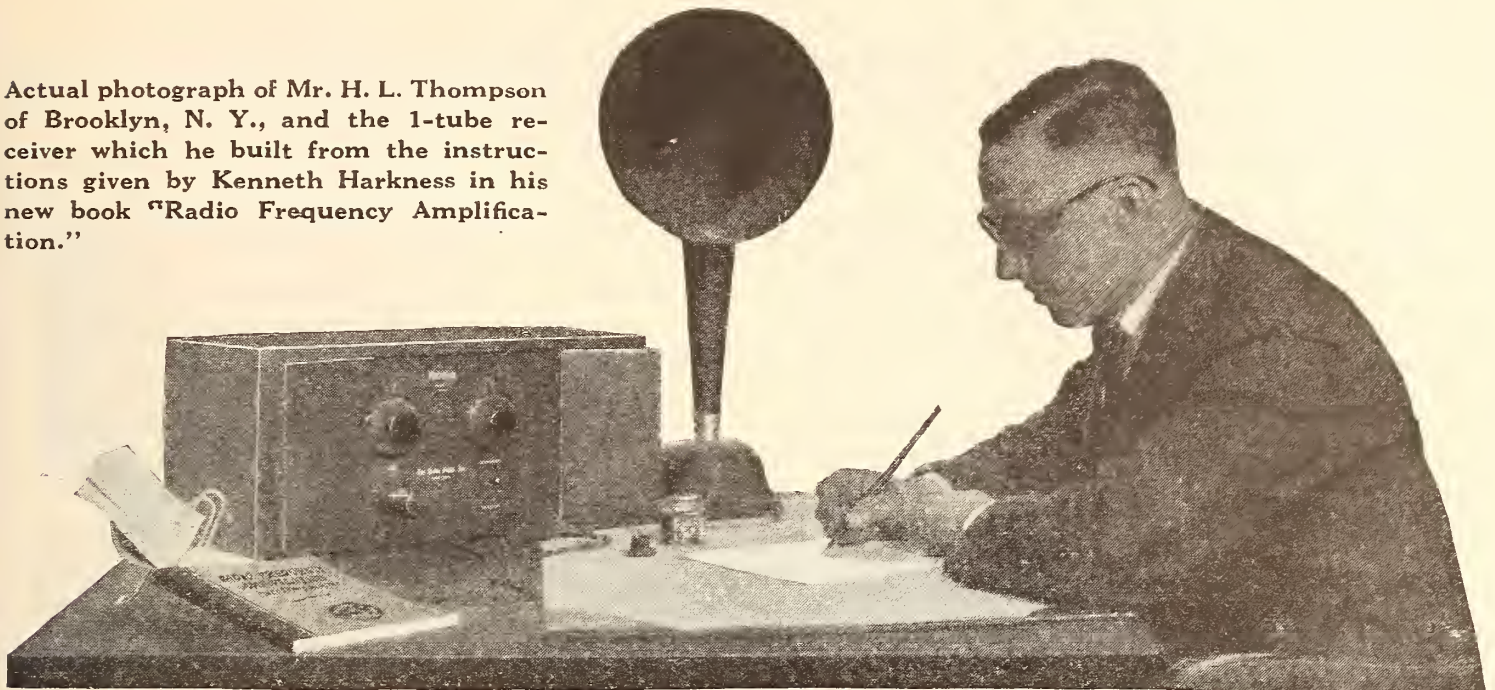

## "This Harkness Set is Simply AMAZING!"

"I NEVER realized that one tube could possibly amplify to such an extent," writes H. L. Thompson, of Brooklyn, N. Y.

"Peter Dyson next door has a 3-tube set and yet this 1-tube Harkness reflex receiver has Peter's 3-tube set beaten fifteen different ways.

"While sitting here writing this letter WHN is pounding in like a ton of bricks—you can hear him 50 feet from the loud-speaker. Last night I heard nearly every broadcasting station in the United States, wearing headphones, of course. The signals were clear as a bell and not a trace of interference.

"I had no difficulty in building the set—thanks to you. I just assembled the special 'Radioformers' T1 and T2 and the other parts you sent me on the drilled front panel and wired the set according to the instructions in Mr. Harkness' book. The whole job only took me about half an hour.

"The batteries are all tucked away out of sight in the special cabinet I got from you. The set looks great. I'm more than satisfied. I've got to hand it to Kenneth Harkness and I'm mighty glad I mailed you my coupon for his book. I'm glad, too, that I ordered the complete set of parts to build the 1-tube set from you; it saved me a lot of trouble and expense. I've got a SET now and I've learned more about radio from Mr. Harkness' book than I ever learned in my life before. All my friends are amazed at the progress I've made and at the results I got with this receiver. I'm advising everybody I know to send for Mr. Harkness' book. It certainly is all you claim for it and more.

"You may publish this letter and enclosed photograph if you care to do so. If it benefits you in any way I'm very glad indeed to be of some service in return for what you have done for me.

Gratefully yours,  
H. L. Thompson."

THE above letter represents the experiences of thousands of amateurs who have read the new Kenneth Harkness book on "Radio Frequency Amplification" and who have constructed either the 1-tube receiver or one of the four other remarkable sets fully described by Mr. Harkness. In this book Mr. Harkness doesn't merely tell you HOW to build these sets. In 8 comprehensive chapters, illustrated by scores and scores of explanatory diagrams, drawings and photographs, he first explains thoroughly the theory of radio reception from A to Z. He doesn't leave anything to your imagination; he doesn't dismiss a tricky subject with a heavy equation which only a mathematician could grasp—he starts right in with you at the beginning and doesn't let go until you understand.

Mr. Harkness then shows you how to apply the theoretical principles. In the 7 chapters of Part 2 he tells you how to build different types of receivers—with all the details of construction. By special permission Mr. Harkness reveals to you a number of the carefully guarded laboratory secrets of the Radio Guild covering the design, construction and wiring of their famous receivers. Some of these sets have just been developed in the Guild laboratories and are disclosed in Mr. Harkness' book for the first time! The theory of operation and details of assembly and wiring are explained thoroughly and illustrated by one hundred and seventy-five (175) diagrams, drawings and

action photographs. Each consecutive step in the construction of these remarkable receivers is unfolded for you with the graphic clearness of a talking-moving picture. And remember—you are told professional engineering secrets of manufacture never before revealed to the amateur radio constructor!

This is more than just a book—it's more than a course of instruction—Kenneth Harkness, with his long experience as consulting engineer and manufacturer of advanced radio receiving apparatus, lives in the pages of this book. He imparts to you the vast knowledge that he has gained of the theory and practice of radio reception. He sits right down with you and explains in easy-to-grasp language the big important things in radio you always thought were too complicated to understand. The very first day you start reading his book you will feel yourself growing in knowledge. Everything is so delightfully clear; each subject is taken up so smoothly and simply that you will clean forget you are actually learning advanced radio—actually learning the theory and operation of the most modern and latest types of radio receivers.

You've always wanted a book like this, a book that will answer all your theoretical and practical radio questions; a book that will tell you how to banish interference from your receiver; a book that will tell you how to make your set receive stations thousands of miles away. You can have this book for the asking—without paying a cent in advance. Just mail the coupon below and you will receive your copy by return mail.

**SEND NO MONEY**  
Just fill in and mail the coupon below. When the book arrives pay the postman the astonishingly low price of only \$1.25. Do it now, while you're thinking about it.

### SPECIAL BARGAIN!

#### All Parts for 1-Tube Set

We can help you to build this set—we can save you a great deal of trouble and expense, too, by supplying you with all the necessary parts exactly as specified by Mr. Harkness. These parts include the front panel, completely drilled, finished and engraved; the 2 special "Radioformers" T1 and T2 completely mounted on variable condensers the special sub-base with turned-in tube socket and audio transformer mounted underneath; the crystal detector; the mahogany cabinet with battery compartments and all dials, wire, binding posts, screws and sundries.

As a special offer to the readers of this magazine we can supply you with all these parts for only \$33.50. All you have to do is to assemble them together with a screwdriver and wire the receiver.

We can also supply you with the "Radioformers" T1 and T2 by themselves if desired—both for only \$12.00 completely mounted on the variable condensers.

The complete 1-tube set, wired and ready for operation, lists at \$42.50.

When ordering, **Send No Money.** Just fill in and mail the coupon below. When the expressman delivers your material pay him the cost of materials ordered plus the small shipping charge. All our apparatus is sold on a refund guarantee basis if found unsatisfactory. The demand for these parts is very heavy so we cannot urge you too strongly to fill in and mail the coupon immediately.

### Use This Coupon

#### The Radio Guild, Inc.

256 West 34th St., New York, N. Y.

Send me—immediately—a copy of the new Kenneth Harkness book "Radio Frequency Amplification." I will pay the postman \$1.25 plus a few cents postage upon delivery.

Also send me the materials which I have checked below. I will pay the expressman the prices indicated plus the small shipping charge when he delivers my order.

**Note: If you only want the book and do not want any of these items, just cross out this section with your pen.**

Complete 1-tube Harkness receiver, wired and ready for operation .....\$42.50  
All the parts to build the 1-tube Harkness receiver 33.50  
2 Special Radioformers T1 and T2 ..... 12.00

Name .....

Full Address .....RB 11-23

41 W. 43rd St.  
New York City

# Haynes-Griffin

New York's  
Largest Radio  
Store

## The HAYNES SELECTOR TRADE-MARK An Inductive Wave Trap (New Type)

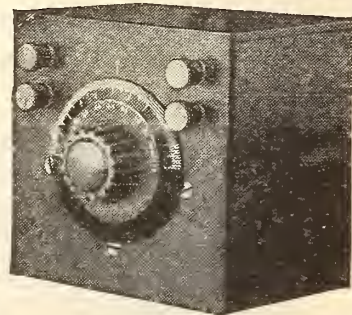

Designed by A. J. Haynes, Assoc. Inst. of Radio Engineers

THE final answer to perfect selectivity. Guaranteed to trap out the interfering signal before it ever reaches your receiving set. Lets you listen to one broadcasting station at a time. Cuts out nearby or powerful stations and greatly increases your receiving range.

The Haynes Selector is furnished completely assembled, ready for immediate use. It can be used with any kind of receiving set or with any type of antenna. It improves tuning operations greatly when used with indoor loop aerial.

The Haynes Selector is enclosed in a beautifully polished mahogany cabinet that justifies its use with receiving sets of the finest quality. It can be connected in an instant's time. No knowledge of radio required.

New Leaflet Now Ready:—Send for our new four-page illustrated leaflet just off the press. Full description with illustrations and directions for use. Tells you everything you want to know about the Haynes Selector. Mailed on receipt of 2 cent stamp.

PRICE—Complete—Ready  
to use  
Parcels **\$8.50**  
Post  
Prepaid

### Parts for the Man Who Builds His Own

23 Plate Condenser \$2.25  
Coil . . . . . 1.25  
Drilled Panel . . . . .85  
Mahogany Cabinet 1.25  
All other parts . . .80

HAYNES-GRIFFIN RADIO SERVICE, Inc. 41 W. 43rd St. New York City

## AT LAST THE GENUINE REINARTZ

Covers all broadcasting  
wave lengths now used  
Each coil bears a  
facsimile of John L.  
Reinartz's signature

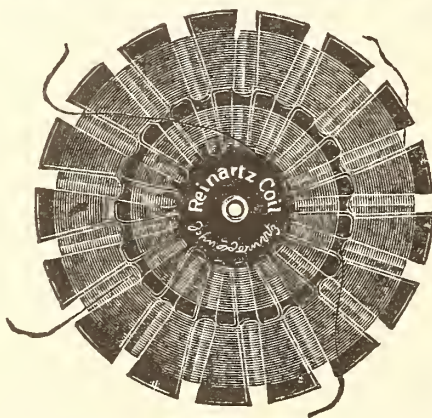

Made under John L.  
Reinartz's specifica-  
tions by The Eugene  
T. Turney Laboratories,  
Inc., exclusively

Primary Coil . . . . . 57 turns 8 taps  
Secondary Coil . . . . . 45 turns 2 taps  
Diameter 5½ inches. Bakelite cores

Packed in individual boxes. With new copyrighted Reinartz hookup  
List \$2.50 Standard package 3 doz.

Jobbers and Dealers write for discounts

### TRISTAN SALES CORPORATION, Dept. E

1 UNION SQUARE

Sole National Distributors  
REGIONAL REPRESENTATIVES

NEW YORK

Baker-Smith & Co.  
741 Call Building  
San Francisco, Calif.  
Walter I. Ferguson & Co.  
208 Baltimore Bldg.  
Kansas City, Mo.

Geo. H. Chamberlain  
375 Broad St.  
Elyria, O.  
J. H. Lyte  
65 North 63rd St.  
Philadelphia, Pa.

O. P. Smith Co.  
205 W. Harrison St.  
Chicago, Ill.  
C. L. S. Holmes Co.  
601 Boston Block  
Minneapolis, Minn.





# Travel Across the Country Most any Night with the

# ACE \$20

**TYPE V** **U** Armstrong  
Regenerative  
Receiver  
Formerly called  
Crosley Model V

*Licensed under Armstrong  
U. S. Patent No. 1,113,149*

**T**HE Ace Type V Armstrong Regenerative Radio Receiver is without doubt the most popular of all sets. Its low cost is not indicative of its efficient service because it performs equally as well as any one tube at any price.

The very first evening you enjoy the Ace Type V you'll wonder how you ever did without it.

Under ordinary conditions you can pick up stations from coast to coast, one after the other, with this long range regenerative receiver. A loud speaker can be operated in connection with the Ace Type V by simply adding an Ace Type 2 B, a new two-step Audio Frequency Amplifier, which sells for \$20.00. This makes it possible to hear a concert all over the house.

This set is so low in cost that everyone can now afford to enjoy radio. Don't be without radio entertainment any longer—listen to the world's best talent—both instrumental and vocal.

If your dealer cannot supply you, order direct, mentioning his name. Ask for "Simplicity of Radio." Your copy is *Free*.

**DEALERS:** Write on your letterhead for attractive sales proposition.

Be sure to visit the Grand Annual Radio Exposition, Grand Central Palace, New York—October 6 to 13th. and receive a hardy welcome at our Booths No. 43-44 and 45. also come to the Grand Annual Radio Exposition, Coliseum, Chicago, our four-section Booth No. 78 on the Collonade—November 20 to 25th.

## The Precision Equipment Company

*Powel Crosley, Jr., PRES.*

1120 Vandalia Avenue, Cincinnati, Ohio

### Ace Type 3C Consolette

This is a new addition to the Ace Family. Has beautiful solid mahogany, wax finished cabinet. Set consists of a regenerative tuner, detector and two stages of amplification, with built in loud speaker. The tuning circuit is licenced under the Armstrong U. S. Patent No. 1,113,149 and due to the particular method of winding Crosley coils it is exceptionally selective. Has sufficient room inside Cabinet for dry batteries making a complete self contained long range receiving outfit. Phone jack for tuning with head phones; Crosley multistat; filament switch, Crosley moulded condenser; beautifully engraved formica panel. Uses all kinds of tubes. A wonderful set at a remarkable price, \$125.00—without tubes or batteries.

### The New Ace Type 3B

This set is equal to a combination of the Ace Type V and the Ace two-stage amplifier. Manufactured under Armstrong U. S. Patent No. 1,113,149. A filament switch eliminates necessity of turning out rheostats when set is not in use. You may turn off the set by throwing switch and come back later without retuning. Has telephone jack in between first and second stage. Crosley multistats. Universal filament control rheostats for all makes of tubes. Price \$50.00.

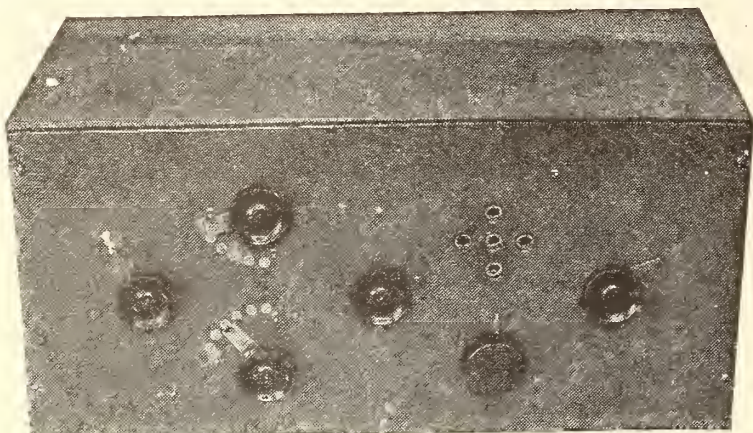

**HERE'S WHAT YOU GET FOR \$10**

1. "The How and Why of Radio Broadcasting"—the book and working charts that tell you just what you need to know about radio, free with each order until further notice.
  2. Parts for the receiver cabinet.
  3. Specially finished front panel.
  4. All the parts, including stators, rotors, axles, friction washers, rotor balls, and wire for two variometers.
  5. All the parts for one vario-coupler.
  6. Metal indicators.
  7. Control knobs for tuning devices.
  8. Vacuum tube socket.
  9. Rheostat.
  10. Wire for winding vario-coupler and variometers.
  11. Grid leak and condenser unit.
  12. Inductance switches for vario-coupler.
  13. Contact points for vario-coupler.
  14. Spring connectors for making an easy job of the wiring.
  15. Eight binding posts.
  16. Hard drawn copper wire for making substantial, bus-type connections.
  17. Metal foil for making the shield which cuts out "howling," due to "body capacity," effect.
  18. Complete soldering outfit, including soldering iron, solder, resin and scraper—just the thing for radio work.
- Everything is here to enable you to build a receiver, without any special tools, without requiring any knowledge of radio, without any complicated parts—but with all the advantages of an expensive receiver at about one-sixth its usual cost. And you have all the fun of making it. Sent prepaid on receipt of money order for \$10.



**LOOK THESE STATEMENTS OVER**

For more than a year K-D-10 has been making excellent reception possible to hundreds at a reasonable cost. Here are a few lines from those who have built the three circuit regenerative receiver designed by Arthur H. Lynch, with K-D-10 parts.

The K-D-10 is the best set yet, receive Davenport, Iowa, Winnepeg, Canada, and Pittsburgh, Pa., regularly in summer.—M. L. J., Morristown, Minn.

With K-D-10 on my indoor aerial I have heard Havana, Louisville, Davenport, Chicago, and Denver.—H. F. C. Garden City, N. Y.

Have had the finest results with your K-D-10—Havana, Atlanta, Pittsburgh, also Chicago—everything around here—R. H. P., Brooklyn, N. Y.

I will tell you who I hear and their approximate distance from here—Calgary, Alberta, 360, Los Angeles, 1,100, (with four ranges of mountains in between), San Francisco, 850, Portland, 600, Seattle, 525, Denver, 670, and Yakima, 600. As this is summer, I consider this reception remarkable.—H. F. L., Gilman, Mont.

**KAY DEE RADIO SUPPLY CO.**

**487 Fulton Street**

**Brooklyn, N. Y.**

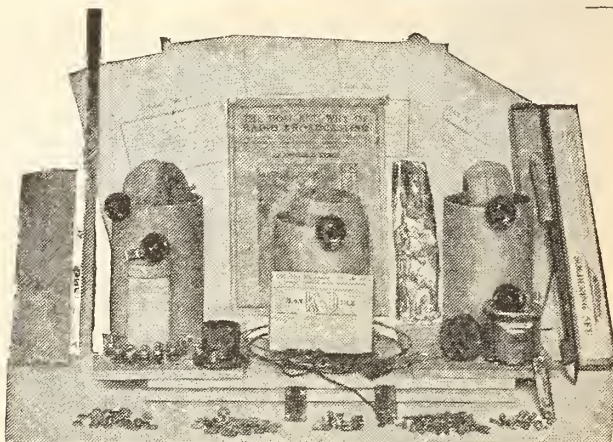

**ALL THESE PARTS FOR \$10**

# S U C C E S S

Has Been Achieved By Hundreds of Radio Enthusiasts Who Have Built Their Own Receivers From the Directions Contained In

## The How and Why of Radio Broadcasting

By Arthur H. Lynch

*Editor of Radio Broadcast*

Letters of endorsement from all over the country indicate that the pleasure of radio has been brought by this book to hundreds of homes, where the high price of ready-made sets made it impossible before.

Think of a complete set of parts for the cabinet, panel, variometers, vario-coupler—everything necessary for the building of a three-circuit regenerative receiver can be purchased for ten dollars.

Excellent results are being obtained by many builders of this receiver with dry-cell tubes.

*Think of Receiving 1,000 Miles and More  
With a Single Dry-Cell Tube*

You Can Do It—As Many Others Already Are. Send Your Dollar For This Now Famous Book And Working Drawings To-day.

Doubleday, Page & Co.

Garden City, N. Y.

# Sodion



*The Plant Behind It*

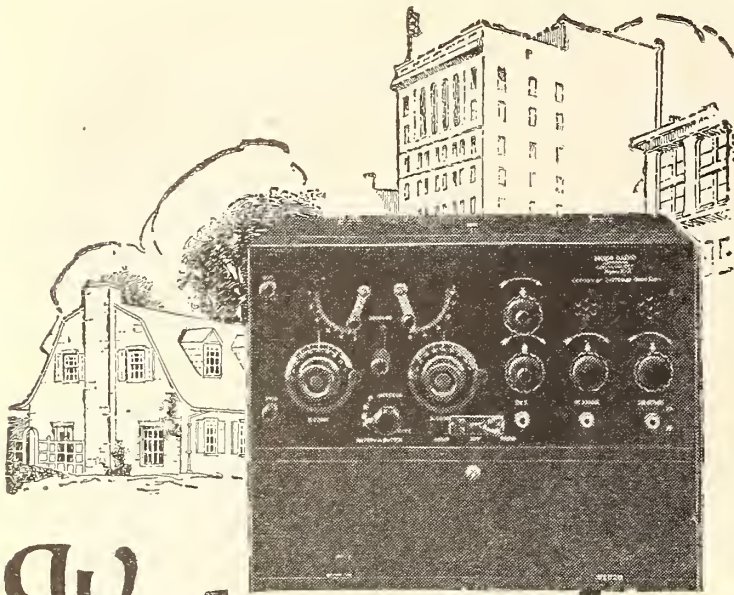

*Works everywhere  
-city or country-*

“Local Conditions” do not exist where Moon Satterlee Antennaless Radio is installed. Here is a set which brings distortionless speech and music to you no matter where you live or how severe the local conditions. The Moon is operated by simply grounding to a water pipe or radiator—no antenna, loop or indoor wire is necessary.

Stations within a conservative 1000 mile radius are regularly received with a non-power loud speaker on this set.

It is the ideal set for use in apartments, automobiles, yachts or railroad trains where an antenna is not practical. Extremely sensitive, unusually receptive, yet simple to operate.

*Write to-day for our folder  
“California or Newark.”*

**MOON RADIO CORPORATION**  
501 Steinway Ave., Long Island City, N. Y.  
In Canada, Continental Equipment Co., Ltd.  
New Birks Bldg., Montreal, Quebec

**MOON**  
*Satterlee*  
**antennaless**  
**-RADIO-**

# Have You Slipped?

Is your knowledge of French slipping and do you want to hold what you have and then build upon it? If you answer “yes” we have a suggestion to offer.

## Le Petit Journal

is a periodical published in reduced newspaper form and appearing twice a month. It is made up of reprinted extracts from the current issues of the leading French newspapers and magazines.

**How can we call ourselves educated if we don't have a working knowledge of at least one language beside our own?**

**Learn French in the natural easy, absorptive way: read *Le Petit Journal*.**

Current news, political affairs, commerce, literature, art, music, sport, feminism, science. Keep in touch with them as France thinks about them by reading *Le Petit Journal* regularly.

While you are enjoying this experience twice a month, you will be developing almost unconsciously skill with a language which next to English is the most important to know.

This digest of French affairs, this easy way to achieve mastery of the French language costs only \$2.00 the year for 24 issues. Subscribe now using the coupon.

RB-11

*Le Petit Journal*  
Garden City, New York

I enclose \$2.00. Enter my subscription for one year.

.....  
.....

# WORKRITE NEUTROFORMER

(Licensed under Hazeltine Patent No. 1,450,080)

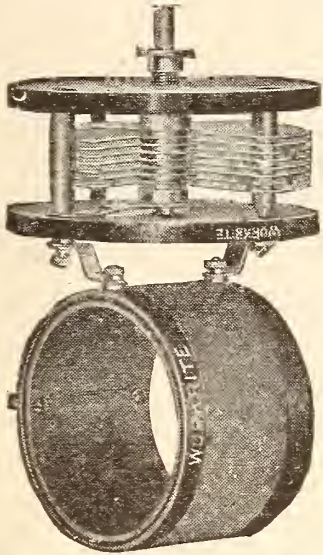

1 WorkRite Condenser + 1 WorkRite Transformer  
= 1 WorkRite Neutroformer

The WorkRite Neutroformer is most carefully made. All parts are carefully inspected and the instrument is the result of painstaking research work on the part of our engineers. The WorkRite Variable Condenser and the WorkRite Neutrodyne Transformer are made to work together in Neutrodyne Receiving sets. These parts can be purchased separately if desired.

WorkRite Variable Condenser.....\$3.50  
WorkRite Neutrodyne Transformer..... 2.00  
WorkRite Neutroformer (Two Mounted)..... 5.50  
WorkRite Neutrodon..... .50

## WORKRITE VERNIER RHEOSTAT

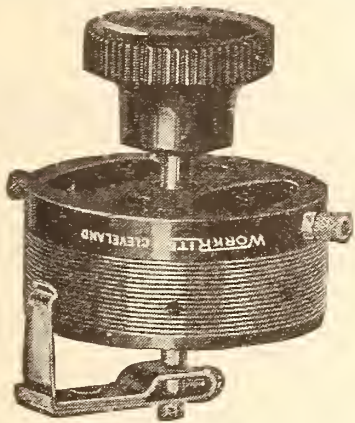

Snappiest Rheostat on the market. 50,000 adjustments possible. A turn of  $\frac{1}{2}$ " will separate two stations or clear up one. Made in three resistances to meet the requirements of all tubes now on the market. 6 ohms \$1.00; 15 ohms \$1.10; 30 ohms \$1.25.

Send for a WorkRite Neutrodyne Hookup. For best results with your Neutrodyne set use all WorkRite parts.

★ "WorkRite Radio Parts WorkRite"

**THE WORKRITE MFG. CO.**

1802 E. 30th St. Cleveland, Ohio

(Branch Office, 536 Lake Shore Dr., Chicago)

# WALNART

PERFORMS  
100%

RADIO  
CONFIDENCE  
AND  
WALNART  
PRODUCTS

The feeling of security, the knowledge that the part is working right, gives the radio fan a new delight—for no matter what may occur, he has learned that "Walnart" perform 100%

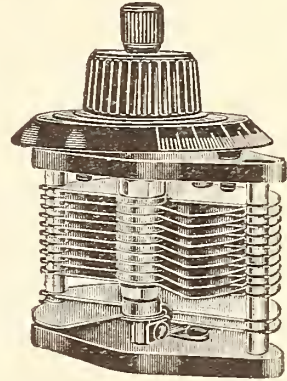

Variable Condenser  
(Plain and Vernier)

You too can have this feeling of security if you equip your set with Walnart Parts. They cost no more than the other kind—and pay you over and over again in their continued 100% performance.

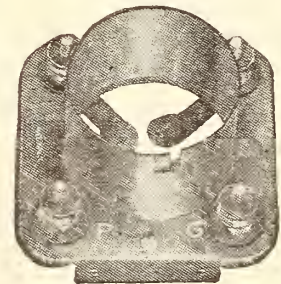

Tube Socket

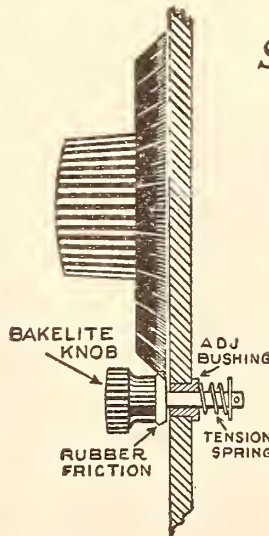

Vernier Adjuster

Send for catalogue  
of Walnart

## Trouble Proof Radio Parts

Variable Condensers  
(Plain and Vernier)

Variable Grid Resistance

Inductance Switch

Tube Sockets (Standard and UV 199)

Vernier Adjusters

**WALNART ELECTRIC MFG. CO.**

Dept. 302-1249 W. Van Buren St.  
Chicago Illinois

# "B" Batteries that are built with a conscience

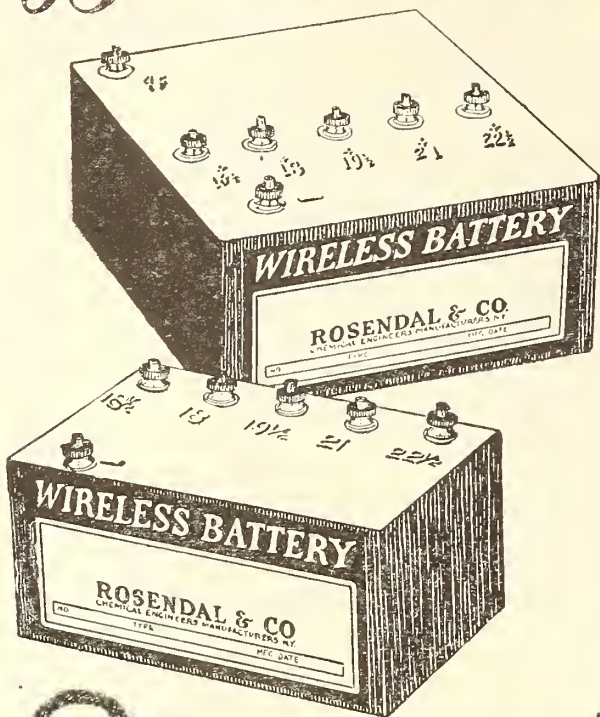

INTO every battery made by Rosendal is injected all of the years of experience gained thru analytical work for some of the largest Battery Manufacturers in the country—with the best of materials and most thorough care in its manufacture.

Rosendal is aware of the requirements of a "B" Battery and can therefore unequivocally guarantee the service you can expect from it. Either you are satisfied with its use or you may return it and your money will be refunded or a new battery sent in exchange.

Rosendal Production provides for fresh stock always. Orders shipped same day received.

Buy direct from the Manufacturer and save the difference.

		Large	Medium	Small
22 1/2	Volt Plain	\$1.25	\$1.00	\$ .70
22 1/2	" Variable	1.38	1.13	.75
45	" Plain	2.50	1.75	...
45	" Variable	2.75	2.00	...

See that your "B" Batteries are always in good condition for best reception. A Jewel Volt Meter regularly sold for \$2.75 is yours for \$1.87 with every order for \$5.00 or over.

Send Money Order or order for C. O. D.

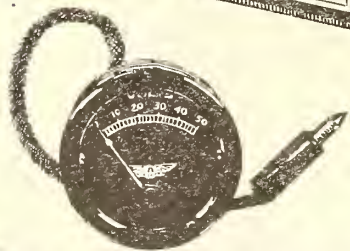

## ROSENDAL & CO.

Chemical and Radio Engineers

2 and 4 Stone Street · New York



## Schwarze

No. 56

## Head Phone Set

2,000 ohms \$5

3,000 ohms \$5<sup>50</sup>

*Super-sensitive  
and  
true to tone*

Complete with  
five feet of cord  
Light in Weight

Phones of hard rubber, mounted on polished swivels, instantly adjustable. The powerful Schwarzze magnets of exclusive construction give direct center pull on diaphragm and produce true articulation without distortion, under high amplification. The steel-spring headband is built for comfort. Each set accurately ground and carefully tested.

*Liberal Discounts to Jobbers and Distributors*

SCHWARZE ELECTRIC COMPANY

Adrian, Michigan

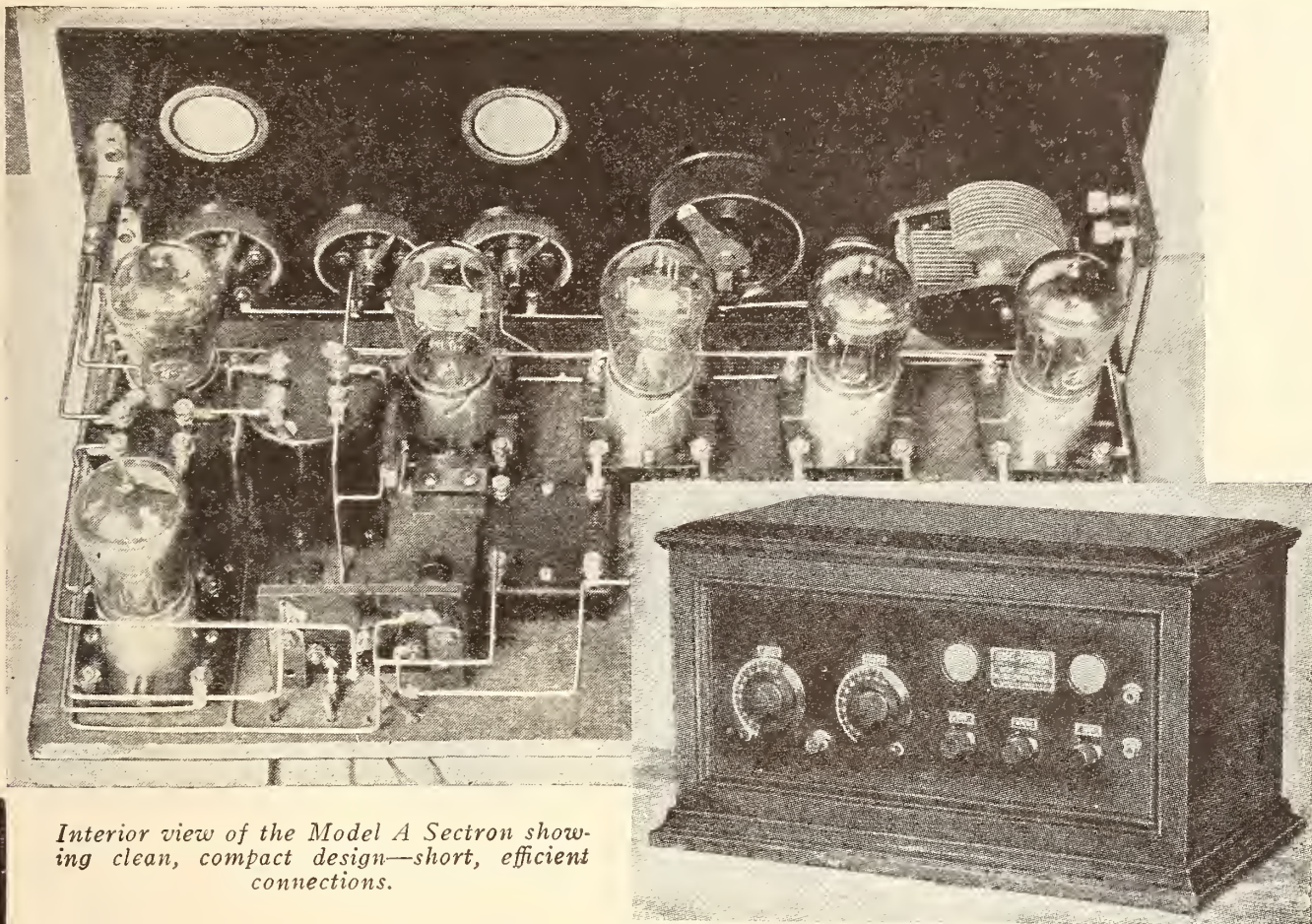

*Interior view of the Model A Sectron showing clean, compact design—short, efficient connections.*

*The outside is equally clean-cut and well designed—finished in mahogany, ebony or walnut; will grace any home.*

**At Last! The Simple, Efficient Radio Set. No aerial required.**

**Three stages of Radio, Detector, and two stages of Audio — selective, directional — simplicity itself in installation and operation.**

# SECTRON ★

SIX TUBES

**M**ANY radio lovers are waiting for radio sets to become simpler to install and operate. No need to wait longer. The Sectron meets all requirements—gets stations 1500 miles or more away—all wave-lengths from 200 to 600 meters.

It is so compact that it may be easily carried anywhere, uses only loop, no outside aerial to put up, battery connections plainly marked—no possible chance to go wrong.

After first adjustment turning of one dial will bring in all stations within range. Works with loud speaker or head phones. Except for A battery and Loop, Sectron is entirely self-contained. The last word in high grade radio workmanship. You cannot know how good a radio can be until you have heard Sectron.

**THE SECTRON RADIO COMPANY**

Eastern Sales Office  
1819 Broadway, New York City

See These! Two new models will be on exhibition at the New York Radio Show. Model B—a compact, leather bound Sectron Portable—complete with batteries, loud speaker and tubes. Model C—a desk set for business men, complete, efficient and moderate in price.



1928 East 55th Street,  
Cleveland, Ohio

COUPON

Please send me data and prices on set checked.

- Model A—de Luxe Sectron
- Model B—Portable Sectron
- Model C—Business Man's Sectron

Name .....

Address .....

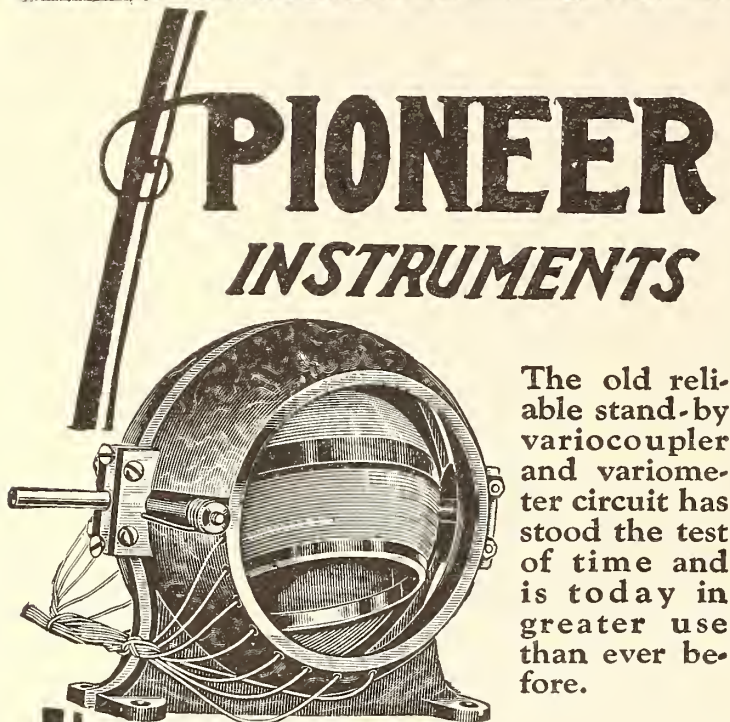

# PIONEER INSTRUMENTS

The old reliable stand-by variocoupler and variometer circuit has stood the test of time and is today in greater use than ever before.

Pioneer Variocoupler \$7.00

Pioneer coupler and variometers are built to meet all the latest broadcasting wave lengths.

The variocoupler has the primary winding on the inside, giving closer inductance, and with 16 taps permits of greater selectivity and closer tuning.

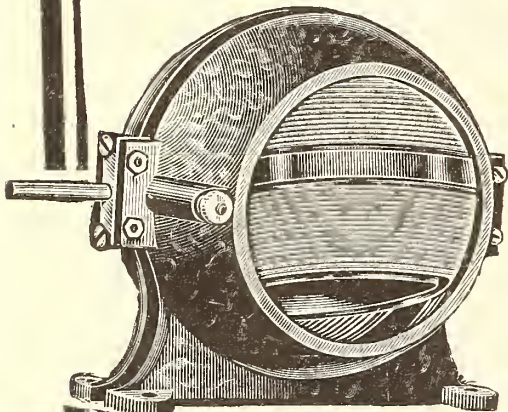

The shells and rotor are of moulded Bakelite.

Moulded in our own factory under our personal supervision. All connections are positive and constant. Made for either panel or table mounting.

Pioneer Variometer \$6.50

The beauty of these instruments has not yet been equalled—their electrical efficiency never surpassed. Send for illustrated folder.

**PIONEER RADIO CORPORATION**  
106 Pioneer Ave. Galesburg, Illinois

**Branch Offices:**

European Branch Office: London, Eng., 27-28 Anning Street.  
Gaston E. Marbaix, European Manager

New York City..... 220 Fulton St.  
Chicago, Ill..... 33 So. Clinton St.  
Kansas City, Mo..... 208 Baltimore Bldg.  
Minneapolis, Minn..... 705 Plymouth Bldg.  
San Francisco..... 623 Larkin St.

## USE A C H SHARP TUNER DIALS

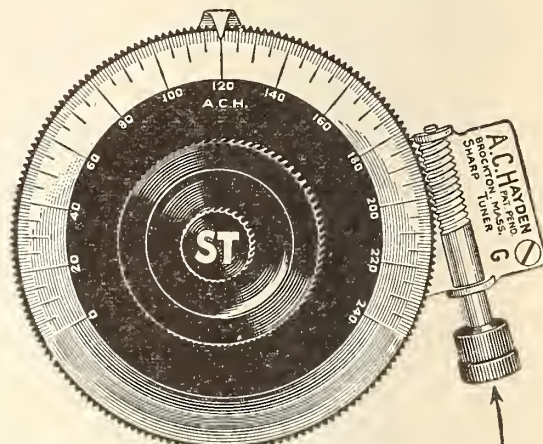

Why the A.C.H. is different

3 in. DIAL

156-t-1

4 in. DIAL

215-t-1

Rough tuning with dial or, one thousandth of an inch in either direction.

### Money Back Guarantee

Price A C H 3" Dial complete..... \$2.50

Price A C H 4" Dial complete..... 5.00

Regular fitting  $\frac{5}{8}$ " hole,  $\frac{1}{4}$ " and  $\frac{3}{8}$ ". Bushings, 5c each extra. 10c for all.

### ASK YOURSELF THIS

Would L. M. Cope, Connellville, Pa., enclose check and say "I want another of those wonderful Dials" if he were not satisfied? To retain your good will you must be satisfied or money refunded.

Ask for circular No. 2 on RV Loud Talker and Detector Set. A wonderful set. All ready for you to put together.

**A. C. HAYDEN RADIO & RESEARCH CO.**

Brockton, Mass.

U. S. A.

Mail Orders sent prepaid in U. S. A.

Ask for a description of  
**THE NEW NATURE LIBRARY**  
Doubleday, Page & Co.



**HEADPHONE CUSHION**  
HUDSON-ROSS

### RADIO FANS

Rejoice when using these pneumatic phone cushions. They gently hug the ears, shutting out all room noises. Fits any type headset. Money back guarantee if you are not satisfied

**FANS** List of Bargains

**FREE**

**RADIO BARGAINS**

17 N. LA SALLE ST. - CHICAGO

SENT ANYWHERE  
POSTAGE FREE  
100 PR



**AMPLION**

**Junior  
DeLuxe**



**\$26<sup>00</sup>**  
List

England

Canada

Scotland

Australia

Wales

New Zealand

Ireland

So. Africa

**The Uncanny Amplion  
A "Human" Loudspeaker**

**YOU** can scarce believe your ears when you first hear the Amplion Loudspeaker.

The clearness, softness and rich tone-quality with which it reproduces voice and music are so real as to be uncanny. You get a new thrill from radio. Delicious "chills" course up-and-down your spine, as they do when you listen to some master of voice or instrument face-to-face.

American Engineers who have tested the Amplion are unanimous in their opinion that for true reproduction and volume it's the best loud speaker yet produced.

The Amplion is not a head receiver fitted with a horn, but the adaption for Radio of an electro-magnetic-and acoustic instrument which for thirty years has been successfully used in all parts of the world.

Ask your dealer to let you hear the wonderful "AMPLION" Loudspeaker. Send for illustrated folder.

*Patentees Alfred Graham & Co.*

**SIGNAL ELECTRIC MFG. CO.**  
*Sole United States Distributors* Menominee, Michigan

**BURNDIPT OF CANADA, LTD.**  
*Canadian Distributors* 172 King St., West, Toronto

India

France

Italy

Spain

Norway

Sweden

Denmark

Holland

Belgium

Japan

*The Supremacy of the AMPLION  
is the Supremacy  
of Actual Performance*

# Radio Engineers KNOW and buy these features

**Teleradio**

**\$5<sup>50</sup>**

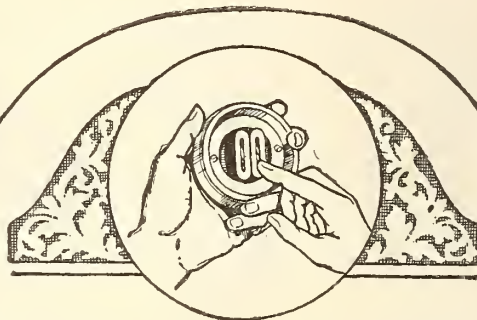

## SUPER-SENSITIVE

1. A guarantee that less than five percent variation in resistance ever exists between the coils of Teleradio head sets. The secret of accurate reproduction of faintest signals.
2. Positive adjustment of diaphragm—insures best tonal qualities.
3. Improved self adjustable friction-sleeve—positive position grip.
4. Drawn aluminum case—all metal parts highly nickel polished. Light and durable for the hardest usage.
5. Fabricated head band for unusual comfort and ease.
6. Latest engineering principles and best of materials employed in every detail of construction and manufacture.

If your dealer cannot supply you, write for catalogue and prices.

Jobbers and dealers write for trade prices.

**TELERADIO ENGINEERING CORP.**

488 Broome Street  
New York City

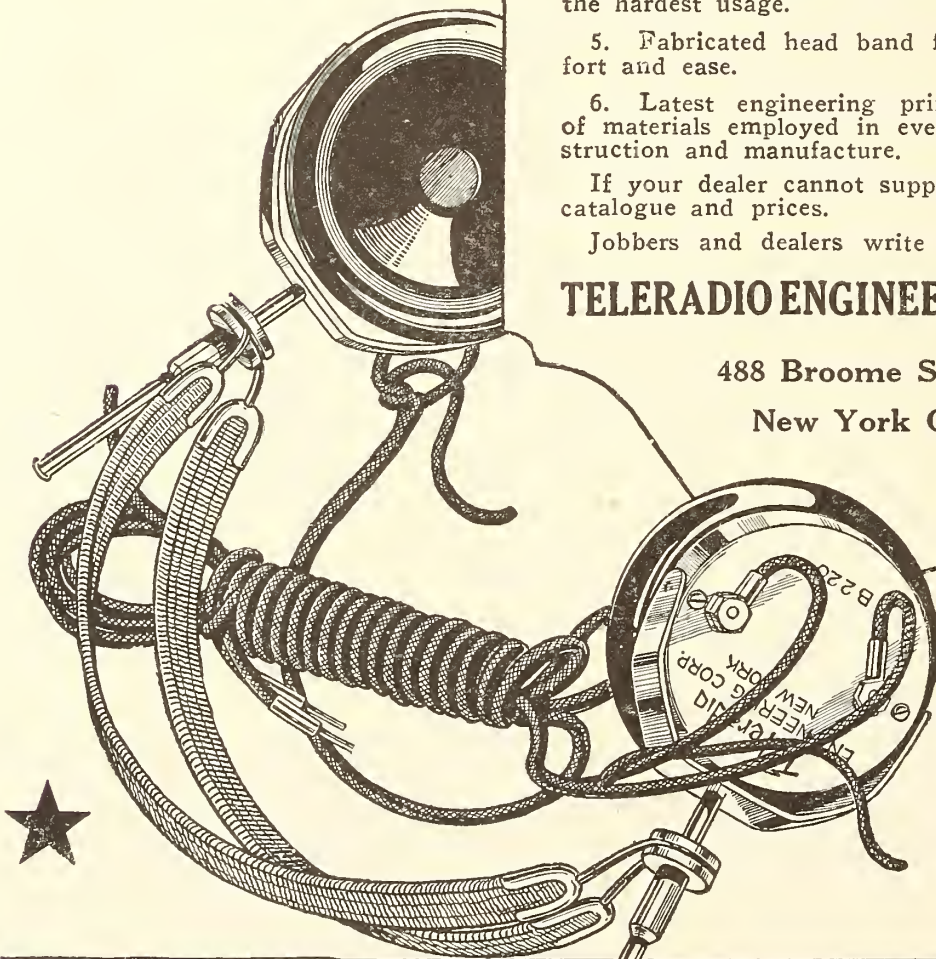

<b>VERNIER CONDENSERS</b>	
23 plate	\$4.50
43 plate	\$5.50
<b>VARIABLE CONDENSERS</b>	
3 plate	\$2.00
23 plate	\$3.00
11 plate	\$2.50
43 plate	\$4.00
<b>RHEOSTATS</b>	
(6 & 30 ohm)	\$1.00
<b>LIGHTNING ARRESTER</b>	
	\$1.00
<b>HEAD PHONE</b>	
(2,000 ohm)	\$5.50
(2,200 ohm)	\$6.00
(3,000 ohm)	\$7.00

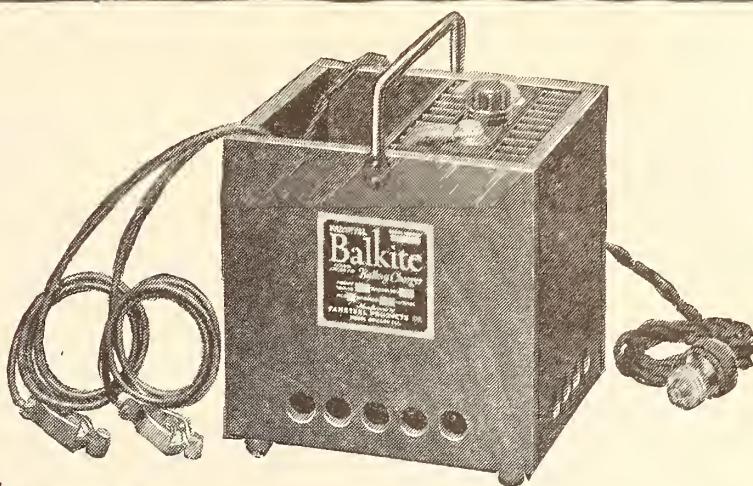

*The*  
**FANSTEEL**  
**Balkite**  
 PATENTS APPLIED FOR  
**battery charger**

*has no vibrators, bulbs,  
 or moving parts*

**FANSTEEL  
 BALKITE**

is a new metal developed for this charger. It acts as a valve, allowing alternating current to flow into the battery but not out of it. It is the most efficient charger valve made, is practically indestructible, and does away with noisy, delicate vibrators and fragile bulbs.

The Gould Battery Company is also marketing, under the Fansteel Balkite Patents, a complete battery and recharging unit known as the Gould Unipower, into which this charger, under the name, "The Fansteel Balkite Rectifier," has been incorporated.

The Fansteel Balkite Battery Charger for Radio "A" Batteries [6 volt] is an entirely new type of rectifier, based on the use of Fansteel Balkite, a new and rare metal developed for this purpose. It is entirely noiseless. *It can be used while the set is in operation.* It cannot deteriorate through use or disuse. It has nothing to replace, adjust, or get out of order. It cannot discharge or short circuit the battery, and requires no attention other than an occasional filling with distilled water. It will not overcharge, and cannot fail to operate when connected to the battery and line current. It is unaffected by temperature or fluctuations in line current. It is simple, efficient, and indestructible except through abuse.

*The Fansteel Balkite Battery Charger will charge the ordinary 6 volt radio "A" battery at 3 amperes, and a 12 volt at 1½ amperes, from 110-115 AC, 60 cycle current. It comes complete and ready for use. Get it from your dealer, or use the coupon below.*

**Price, \$18**  
 (\$18.50 West of the Rockies)

**FANSTEEL PRODUCTS CO., Inc.**

Dept. 5-C North Chicago, Illinois

*Dealers and Jobbers: The Fansteel Balkite Battery Charger does away with complaints and replacement troubles. Write for literature and discounts.*

Dept.  
 6-C

FANSTEEL  
 PRODUCTS  
 CO., Inc.,  
 North Chicago, Ill.

Enclosed please find \$18. (\$18.50 west of the Rockies.) Send me the Fansteel Balkite Battery Charger for Radio "A" Batteries. If I am not entirely satisfied I will return it and you will refund my money.

Name .....

Street .....

City..... State.....

STEPLESS • NOISELESS

COMPACT • PERMANENT

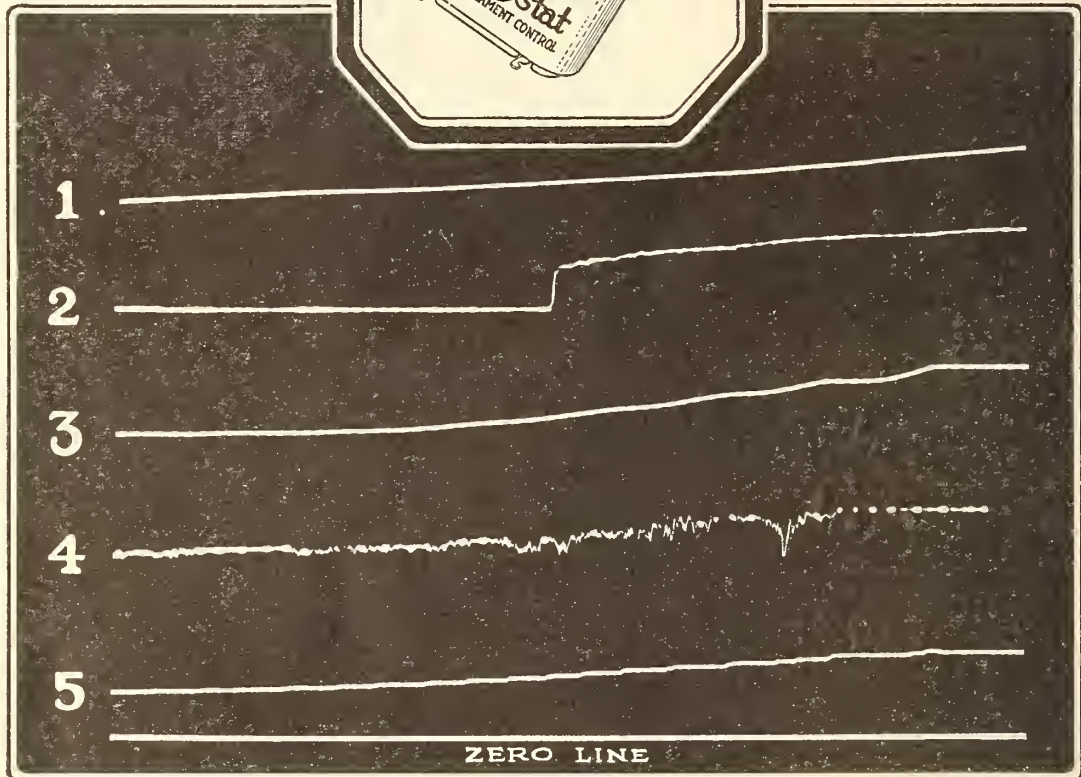

## The Graphite Discs in the Universal Bradleystat Surpass All Other Resistors for Perfect Filament Control

**S**UBSTITUTES have been offered, from time to time, for the scientifically-treated graphite discs in the Universal Bradleystat. Carbon powder, dust, flakes and other materials have been tried without success.

For a time, such materials appear to give satisfactory service, but they soon pack into a solid mass and the filament control is destroyed.

The Allen-Bradley Co. has built graphite disc rheostats for over twenty years for battle ships, mines, rubber plants, textile mills and other places requiring smooth, stepless control. This wide experience has made possible the Universal Bradleystat, backed by a guarantee of excellence and performance which assures every Bradleystat purchaser of a filament control that is perfect and permanent.

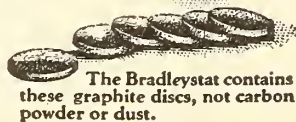

The Bradleystat contains these graphite discs, not carbon powder or dust.

**L**ABORATORY tests are made frequently to compare the performance of the Bradleystat with other types of filament control. A recent oscillograph test made at the University of Wisconsin is shown above to demonstrate conclusively the superiority of graphite discs over other resistance materials.

Curve No. 1 is the smooth perfect control of the Universal Bradleystat.

Curves No. 2 and 3 show the control of carbon powder or dust rheostats. Observe the unreliable and irregular control obtained.

Curves No. 4 and 5 illustrate the control of two types of wire rheostats.

Remember—The Universal Bradleystat can be used with any receiving or amplifying tube, and with 5-watt sending tubes.

Retail Price \$1.85  
In Canada \$2.50

**Allen-Bradley Co.**  
Electric Controlling Apparatus  
278 Greenfield Ave. Milwaukee, Wis.



All Reliable Dealers  
Sell the Bradleystat

THE ALLEN-BRADLEY CO. HAS BUILT GRAPHITE DISC RHEOSTATS FOR OVER 20 YEARS

# RADIO ON THE FARM THE DAILY MARKET REPORTS



WITHOUT THE  
AUDIOPHONE



IT LINKS  
THE CITY  
WITH  
THE FARM

WITH THE  
AUDIOPHONE



Market reports through the AUDIOPHONE can be depended upon because nothing is lost from the original broadcasting.

Not only is it easily possible to distinguish the words of a speaker, but also the minute graduations in pitch, timbre, and quality of overtones, which distinguish individual voices.

The same qualities that make the AUDIOPHONE a source of profit by day, gives pleasure in the evening to the entire household, furnishing entertainment and education of a varied nature because it is equally efficient in reproducing the speaking voice, singing voice, and all musical instruments.

The AUDIOPHONE is complete and self-contained—needs no separate battery or other accessories—goes to you ready for use in connecting to your receiving set. It will prove a source of lasting pride and pleasure.

Audiophone Sr. ....	\$32.50
Audiophone Jr. ....	22.50
Bristol One Stage Power Amplifier .....	25.00

Send your name and address to receive copy of Bulletin No. AH-3006.

**THE BRISTOL COMPANY**                      **Waterbury, Conn.**

*BRANCH OFFICES:*

<b>Boston</b>	<b>New York</b>	<b>Philadelphia</b>	<b>Pittsburgh</b>
<b>Detroit</b>	<b>Chicago</b>	<b>St. Louis</b>	<b>San Francisco</b>

★ Tested and approved by RADIO BROADCAST ★

# REMLER

## a new and Improved Variometer

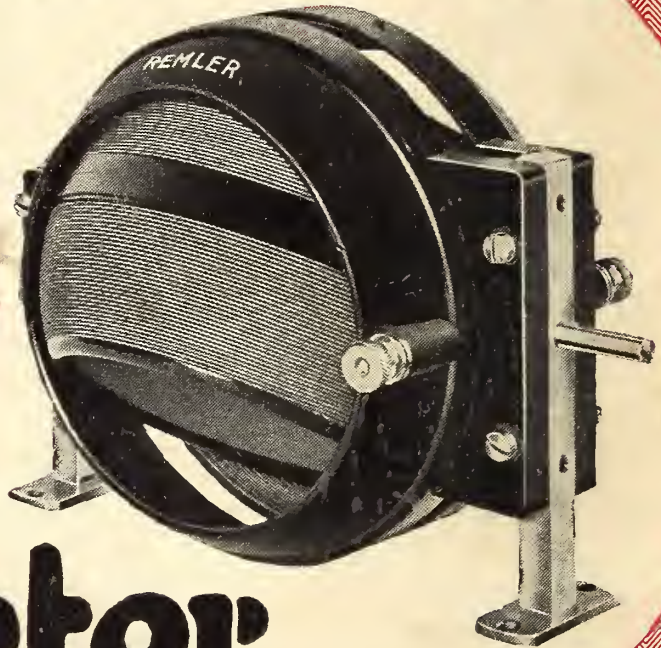

With Internal Pig Tail Connections.  
Wave Length Range 180 to 570 Meters.  
Positively Guaranteed.

Price **\$7.50**

TYPE 500 with closed rotor

### The Greatest Variometer Ever Produced

A Leader in Appearance and Performance

Three years ago Remler introduced the "moulded Bakelite" Variometer. Since that time the engineers of the Remler Company have made a thorough scientific study of the application of variometers to every phase of radio reception. As a result of this exhaustive study a new and improved variometer, the greatest ever produced, is now offered to the public.

It has the lowest minimum and highest maximum wave length ever obtained in a variometer and the wave length variation is exactly proportional to the reading of the dial scale. It will cover the entire range of amateur and broadcast wave length when used with any vario-coupler. When used with a Remler vario-coupler the wave length range is guaranteed to be from 180 to at least 570 meters. Pigtailed connections are used between stator and rotor resulting in perfect contact and quiet operation. All metal parts are buffed and nicked; green silk wire is used on both stator and rotor. The general appearance and quality of the bakelite molding is the best ever built into a radio item.

If your dealer cannot supply you, send the attached coupon direct to us with express or postal money order. Write for complete descriptive circular.

**Remler Radio Mfg. Co.**  
248 First St.  
San Francisco, Cal.

**REMLER RADIO MFG. CO. ★**

HOME OFFICE:

248 First St.  
San Francisco

154 W. Lake St.  
Chicago, Ill.

30 Church St.  
New York City

Gentlemen:

Please send me by return parcel post one new and Improved Remler Variometer Type 500 for which I enclose Seven dollars and fifty cents (\$7.50). If for any reason whatsoever I am not satisfied with this Variometer, I can return it to you express collect and you will refund my seven dollars and fifty cents in full.

Name.....

Address.....

★ Tested and approved by RADIO BROADCAST ★

THE COUNTRY LIFE PRESS, GARDEN CITY, NEW YORK

C 190  
back









WERT  
BOOKBINDING  
Grantville, Pa.  
May/June 1988  
We are Quality Bound

LIBRARY OF CONGRESS

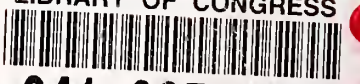

0 041 065 197 A