



Calhoun: The NPS Institutional Archive
DSpace Repository

Theses and Dissertations

1. Thesis and Dissertation Collection, all items

2002-12

Budget preparation, execution and methods
at the major claimant/budget submitting
office level

Reed, James E.

Monterey, California. Naval Postgraduate School

<http://hdl.handle.net/10945/3416>

Downloaded from NPS Archive: Calhoun



Calhoun is a project of the Dudley Knox Library at NPS, furthering the precepts and goals of open government and government transparency. All information contained herein has been approved for release by the NPS Public Affairs Officer.

Dudley Knox Library / Naval Postgraduate School
411 Dyer Road / 1 University Circle
Monterey, California USA 93943

<http://www.nps.edu/library>

**NAVAL POSTGRADUATE SCHOOL
Monterey, California**



THESIS

**BUDGET PREPARATION, EXECUTION AND METHODS AT
THE MAJOR CLAIMANT/BUDGET SUBMITTING OFFICE
LEVEL**

by

James E. Reed

December 2002

Thesis Advisor: Jerry L. McCaffery
Associate Advisor: John E. Mutty

Approved for public release; distribution is unlimited

THIS PAGE INTENTIONALLY LEFT BLANK

REPORT DOCUMENTATION PAGE			Form Approved OMB No. 0704-0188
Public reporting burden for this collection of information is estimated to average 1 hour per response, including the time for reviewing instruction, searching existing data sources, gathering and maintaining the data needed, and completing and reviewing the collection of information. Send comments regarding this burden estimate or any other aspect of this collection of information, including suggestions for reducing this burden, to Washington headquarters Services, Directorate for Information Operations and Reports, 1215 Jefferson Davis Highway, Suite 1204, Arlington, VA 22202-4302, and to the Office of Management and Budget, Paperwork Reduction Project (0704-0188) Washington DC 20503.			
1. AGENCY USE ONLY (Leave blank)	2. REPORT DATE December 2002	3. REPORT TYPE AND DATES COVERED Master's Thesis	
4. TITLE AND SUBTITLE Budget Preparation, Execution and Methods at the Major Claimant/Budget Submitting Office Level		5. FUNDING NUMBERS	
6. AUTHOR (S) James E. Reed		8. PERFORMING ORGANIZATION REPORT NUMBER	
7. PERFORMING ORGANIZATION NAME(S) AND ADDRESS(ES) Naval Postgraduate School Monterey, CA 93943-5000		10. SPONSORING/MONITORING AGENCY REPORT NUMBER	
9. SPONSORING / MONITORING AGENCY NAME(S) AND ADDRESS(ES)			
11. SUPPLEMENTARY NOTES The views expressed in this thesis are those of the author and do not reflect the official policy or position of the U.S. Department of Defense or the U.S. Government.			
12a. DISTRIBUTION / AVAILABILITY STATEMENT Approved for public release; distribution is unlimited		12b. DISTRIBUTION CODE	
13. ABSTRACT (maximum 200 words) This thesis describes the current Planning, Programming, and Budgeting System (PPBS) process at a Navy Major Claimant/Budget Submitting Office (BSO) by examining the overall navy process and the processes employed at a major claimant/BSO, COMPACFLT (CPF). The thesis begins by describing the scope of the Planning, Programming, and Budgeting requirements at CPF by describing its Area of Responsibility (AOR) and the major sub-claimants who rely on CPF for program and budget submissions and subsequent allocation of resources. The thesis then describes the current navy PPBS process, the process at CPF, and the interactions that occur between the two. Next, the thesis describes and analyzes the concurrent program/budget process implemented by the Secretary of Defense in August 2001 and the perceptions among CPF staff for the reasoning behind the change. The thesis also examines the differences in funding between readiness accounts that directly support operating forces and support accounts that provide resources to the infrastructure account that supports those forces. Finally, the thesis discusses the intricate, yet reiterative nature of the process and the informal PPBS process that occurs between participants on a day-to-day basis. This thesis was prepared by reviewing current documentation of the PPBS process and by conducting interviews with key members of the CPF planning, programming and budgeting staffs.			
14. SUBJECT TERMS Planning, Programming, and Budgeting System (PPBS), Capability Plans (CP), Baseline Assessment Memoranda (BAM), Integrated Warfare Architectures (IWAR), Budget		15. NUMBER OF PAGES 97	
17. SECURITY CLASSIFICATION OF REPORT Unclassified	18. SECURITY CLASSIFICATION OF THIS PAGE Unclassified	19. SECURITY CLASSIFICATION OF ABSTRACT Unclassified	20. LIMITATION OF ABSTRACT UL

NSN 7540-01-280-5500

Standard Form 298 (Rev. 2-89)
Prescribed by ANSI Std. Z39-18

THIS PAGE INTENTIONALLY LEFT BLANK

Approved for release; distribution is unlimited

**BUDGET PREPARATION, EXECUTION AND METHODS AT THE MAJOR
CLAIMANT/BUDGET SUBMITTING OFFICE LEVEL**

James E. Reed
Commander, United States Navy
B.B.A., University of North Florida, 1986

Submitted in partial fulfillment of the
requirements for the degree of

MASTER OF SCIENCE IN MANAGEMENT

from the

**NAVAL POSTGRADUATE SCHOOL
December 2002**

Author: James E. Reed

Approved by: Jerry L. McCaffery
Thesis Advisor

John Mutty
Associate Advisor

Douglas A. Brook, Ph.D.
Dean, Graduate School of Business and Public
Policy

THIS PAGE INTENTIONALLY LEFT BLANK

ABSTRACT

This thesis describes the current Planning, Programming, and Budgeting System (PPBS) process at a Navy Major Claimant/Budget Submitting Office (BSO) by examining the overall navy processes and the process employed at a major claimant/BSO, COMPACFLT (CPF). The thesis begins by describing the scope of the Planning, Programming, and Budgeting requirements at CPF by describing its Area of Responsibility (AOR) and the major sub-claimants who rely on CPF for program and budget submissions and subsequent allocation of resources. The thesis then describes the current navy PPBS process, the process at CPF, and the interactions that occur between the two. Next, the thesis describes and analyzes the concurrent program/budget process implemented by the Secretary of Defense in August 2001 and the perceptions among CPF staff for the reasoning behind the change. The thesis also examines the differences in funding between readiness accounts that directly support operating forces and support accounts that provide resources to the infrastructure account that supports those forces. Finally, the thesis discusses the intricate, yet reiterative nature of the process and the informal PPBS process that occurs between participants on a day-to-day basis. This thesis was prepared by reviewing current documentation of the PPBS process and by conducting interviews with key members of the CPF planning, programming and budgeting staffs.

THIS PAGE INTENTIONALLY LEFT BLANK

TABLE OF CONTENTS

I.	INTRODUCTION	1
A.	OBJECTIVES	1
B.	RESEARCH QUESTIONS	2
C.	METHODOLOGY	3
D.	SCOPE	4
E.	ORGANIZATION	4
	1. Chapter II: CPF	4
	2. Chapter III: The PPB Process and CPF	5
	3. Chapter IV: Routine and Emergent Issues and Strategies	5
	4. Chapter V. Conclusions and Recommendations ...	5
II.	COMPACFLT	7
A.	INTRODUCTION	7
B.	MISSION	8
C.	SCOPE	9
	1. AOR	9
	2. Resources	10
D.	SUBORDINATE COMMANDS	11
E.	CPF INTERNAL BUDGETING AND PROGRAMMING ORGANIZATION	12
	1. Comptroller	12
	2. Programming	16
F.	INTERACTION AMONG DEPARTMENTS	18
G.	CHAPTER SUMMARY	19
III.	THE PLANNING, PROGRAMMING AND BUDGETING SYSTEM AND COMPACFLT	21
A.	INTRODUCTION	21
B.	PPBS OVERVIEW	21
C.	THE NAVY PPBS PROCESS	23
	1. Planning Phase	23
	a. <i>IWAR</i>	24
	b. <i>CPAM</i>	25
	c. <i>Navy Programming and Fiscal Guidance</i> ...	25
	2. Programming Phase	26
	3. Budgeting Phase	30
	a. <i>Concurrent Budgets</i>	35
D.	PPBS AT COMPACFLT	36
	1. Planning	37
	b. <i>IWARs</i>	38
	2. Programming	39
	3. Budgeting	43

a.	<i>Budget Guidance</i>	43
b.	<i>Budget Preparation</i>	44
c.	<i>Budget Review</i>	45
d.	<i>Issue/Comment Phase</i>	46
e.	<i>Budget Sweep-Up and Certified Obligations</i>	46
f.	<i>OSD Review and PBDs</i>	47
g.	<i>PRESBUD and Mid-Year Review</i>	48
E.	CHAPTER SUMMARY	49
IV.	ROUTINE AND EMERGENT BUDGET ISSUES AT COMPACFLT	51
A.	INTRODUCTION	51
B.	ROUTINE ISSUES	51
1.	The Process	51
2.	Readiness Versus Support Accounts	53
3.	Recent Changes	59
4.	The Informal System	65
C.	CHAPTER SUMMARY	66
V.	CONCLUSIONS AND RECOMMENDATIONS FOR FURTHER RESEARCH ...	69
A.	INTRODUCTION	69
B.	CONCLUSIONS	69
1.	PPBS is a Reiterative Process	69
2.	Resources are Limited	70
3.	The Process is Undergoing Transformation	70
4.	The Informal PPBS	71
C.	AREAS FOR FURTHER RESEARCH	72
1.	Support Account Metrics and Models	72
2.	Results of the Concurrent Program/Budget Process	72
3.	Continuing Updates to the Process	73
	LIST OF REFERENCES	75
	INITIAL DISTRIBUTION LIST	79

LIST OF FIGURES

Figure 1.	PACOM (CPF) AOR. [Ref.5:p.1].....	10
Figure 2.	CPF Comptroller Organization. [Ref.1].....	14
Figure 3.	CPF Budget Department Organization. [Ref.10]....	15
Figure 4.	Resource Control Organization. (Budget Execution) [Ref.10].....	16
Figure 5.	CPF Programming Structure. [Ref.12].....	18
Figure 6.	Navy IWAR Structure. [Ref.12].....	24
Figure 7.	N8 Organization. [Ref.17].....	28
Figure 8.	N7 Organization. [Ref.17].....	28
Figure 9.	PPBS Prior to 2001. [Ref.1].....	32
Figure 10.	PPBS 2001 and Subsequent. [Ref.1].....	32
Figure 11.	FY-02 Budget Processes. [Ref.1].....	36
Figure 12.	CPF Budget Year.....	49
Figure 13.	CPF Execution Controls for Selected Accounts. [Ref.1].....	57
Figure 14.	CPF FY-02 Prioritized Mid Year Review Submission. [Ref.1].....	58
Figure 15.	CPF DERF and Supplemental Funding for FY-02. [Ref.1].....	58
Figure 16.	Memo from Secretary Rumsfeld Directing Concurrent Program/Budget.....	64

THIS PAGE INTENTIONALLY LEFT BLANK

LIST OF TABLES

Table 1. CP Topics and Assessment Sponsors [Ref.22]	42
---	----

THIS PAGE INTENTIONALLY LEFT BLANK

ACRONYMS

AOR	Area of Responsibility
BAM	Baseline Assessment Memorandum
BES	Budget Estimate Submission
BGM	Budget Guidance Memorandum
BOR	Budget OPTAR Report
BOS	Base Operating Support
BSO	Budget Submitting Office
CEB	CNO Executive Review Board
CFFC	Commander Fleet Forces Command
CIVPERS	Civilian Personnel
CLF	Commander, U.S. Atlantic Fleet
CNO	Chief of Naval Operations
COMNAVAIRPAC	Commander Naval Air Forces Pacific
COMNAVSUBPAC	Commander Naval Submarine Forces Pacific
COMNAVSURFPAC	Commander Naval Surface Forces Pacific
CP	Capability Plan
CPAM	CNO Program Assessment Memorandum
CPF	Commander, U.S. Pacific Fleet
DoD	Department of Defense
DoN	Department of the Navy
FHCR	Flying Hour Cost Report
FHP	Flying Hour Program
FHPS	Flying Hour Projection System
FMB	Navy Budget Office
FO	Flying Hours Other
FP	Force Protection
FY	Fiscal Year
FYDP	Future Years Defense Program

IDTC	Inter-deployment Training Cycle
IPT	Integrated Process Team
ISPP	Integrated Sponsor Program Proposal
IT	Information Technology
IWAR	Integrated Warfare Architecture
NAVAIR	Naval Aviation Systems Command
NAVSEA	Naval Sea Systems Command
NHBS	Navy Headquarters Budgeting System
O&MN	Operations and Maintenance, Navy
OMB	Office of Management and Budget
OPNAV	Office of the Chief of Naval Operations
OSD	Office of the Secretary of Defense
PACFLT	U.S. Pacific Fleet
PACNORWEST	Pacific Northwest
PACOM	U.S. Pacific Command
PBCG	Program Budget Coordination Group
PBD	Program Budget Decision
POM	Program Objective Memorandum
PPBS	Planning Programming and Budgeting System
PR	Program Review
PRESBUD	President's Budget
R3B	Resource Requirements Review Board
SECDEF	Secretary of Defense
SPP	Sponsor Program Proposal
SRM	Sustainment, Restoration, and Maintenance
T-POM	Tentative Program Objective Memorandum
TYCOM	Type Commander
USNORTHCOM	U.S. Northern Command

ACKNOWLEDGEMENTS

I would like to thank Professor Jerry L. McCaffrey for his ideas, guidance, insights, and patience during the research, development, coordination with COMPACFLT, and writing and review of this thesis. I would also like to thank Captain (Ret) John E. Muttu for his review of the thesis and his insights into the structure of the Navy's programming and budgeting staffs in Washington, DC.

The following people at COMPACFLT also deserve recognition and thanks for providing the author with candid insights into the planning, programming and budgeting processes within their command: Rear Admiral (Upper Half) Jonathan Greenert, Deputy COMPACFLT, Captain John Morris, COMPACFLT Comptroller, CDR Diane Brooks, COMPACFLT Resource Control Department Head, Ms. Vicki Catton, COMPACFLT Budget Department Head, Mr. Brian Overby, COMPACFLT N80, LCDR Heidi Allan, COMPACFLT Assistant Programming Officer, LCDR Ed Butziruis, COMPACFLT Resource Control Financial Management Officer, Ms. Geri Shishido, COMPACFLT Base Operating Support Budget Analyst Supervisor, and Mr. Randall Scott, COMPACFLT Aviation Budget Analyst Supervisor.

THIS PAGE INTENTIONALLY LEFT BLANK

I. INTRODUCTION

A. OBJECTIVES

The primary objective of this study is to analyze the planning, programming, budgeting and budget execution methods employed at the Major Claimant/Budget Submitting Office (BSO) level describing both routine and non-routine events that occurred during fiscal years 2001 and 2002. In order to complete the drafting and review of the thesis, processes in place as of 31 October 2002 are described. The thesis will provide future students in the Masters of Business Administration curriculum with a "living document" that describes the workaday world of programming and budgeting at the Major Claimant/BSO level. The thesis will attempt to describe planning relationships, program and budget preparation and execution issues, and Program Objective Memoranda (POM)/Program Review (PR) and budgeting relationships.

The call for tighter and stricter fiscal controls requires all navy commands to become more efficient and effective in the preparation and execution of their budgets. In order to achieve these goals and to provide useful budget information up the Chain of Command, navy planners, programmers and comptrollers must possess a fundamental understanding of the budget processes and methods employed by their major claimants in the preparation and execution of their budgets.

Students at the Naval Postgraduate School, many of whom will become programmers or comptrollers in the fleet after graduation, receive a solid base for understanding

the overall Department of Defense (DoD) PPBS process. However, there is not as much understanding of the day-to-day budget issues and organization at a lower level (major claimant). While it is important for Navy Financial Managers to understand how the Navy formulates its overall budget, in many ways it is even more important to understand organization and interactions with the Planning, Programming, and Budgeting System (PPBS) at lower level commands such as the Fleet commanders who are the BSOs For subordinate commands and activities.

Developing and coordinating information for requirements for funding and apportionment of available funding and execution of subsequent budgets in most navy commands flows both up and down through major claimants. As Financial Officers in the fleet, it is important to understand the process for developing the program and budget and for executing the budget. It is also important to understand the relationships that exist both up and down the Chain of Command. It is equally important to understand the budget authority's process, the strategies it employs in the planning, programming, and budgeting process.

B. RESEARCH QUESTIONS

This thesis attempts to answer several questions that will give Navy Financial Managers an understanding of programming and budgeting at the Fleet Commander level by describing the processes at COMPACFLT (CPF). The primary research question is what is the program and budget formulation and execution process at Fleet Commander level major claimants? The thesis will provide a timeline and explanation of the major program and budget planning and

execution milestones that occur during the course of a fiscal year.

Second, in order to ensure that his command receives the funding needed to meet all of its requirements, the Fleet Commander must be actively engaged in the POM process. Consequently, it is important to ask, "What is the CPF's relationship to the POM/PR, and budget process?" In 2002, the CPF Operations and Maintenance, Navy O&MN budget totaled over seven billion dollars [Ref.1].

Third, in order to understand the magnitude of the PPBS requirements at the major claimant level, the thesis will describe the scope and magnitude of CPF's PPBS requirements by describing its Area of Responsibility and the number and diversity of forces that report to CPF for resource planning and allocation.

Lastly, this thesis will review current (FY-02) changes to the PPBS process and discuss the relationships between readiness and support accounts and their funding.

Through answering these questions and examining these topics, this thesis will develop a base for understanding the scope of the program and budget, PPBs relationships and processes, and issues faced in program and budget formulation and execution at the Major Claimant level.

C. METHODOLOGY

A thorough review of applicable publications, instructions, the World Wide Web, Department of Defense references, CPF instructions, and other library information sources was conducted for Navy and Major Claimant PPBS processes. In addition, interviews were conducted with key CPF programming and budget personnel to develop the

commander's program and budget timeline for development and execution. On site interviews conducted at NPS and the CPF Comptroller's Office provided insight to budgetary relationships and strategies used to respond to emergent issues, supplemental funding issues and issues surrounding the mid-year review.

D. SCOPE

This thesis will provide a guide to program and budget preparation and execution processes at the Major Claimant/BSO level. Additionally, the thesis will provide navy comptrollers with a living document that describes POM relationships and strategies employed by Major Claimants when dealing with emergent issues. The thesis was prepared by researching the planning, programming, and budgeting processes and methods employed at CPF.

E. ORGANIZATION

This study addresses Operations and Maintenance (O&MN) budgeting at the Major Claimant/BSO level and is organized into four areas of emphasis, including (1) CPF organization, (2) the DoD and CPF PPBS process, (3) recent changes to the PPBS process and emergent issues and (4) conclusions and recommendations for further research.

1. Chapter II: CPF

This chapter provides background on the mission and Area of Responsibility (AOR) of CPF and provides insight into the scope of responsibility that resides at the Major Claimant as represented by CPF. The chapter also provides the CPF organization structure, a description of the CPF Comptroller's Office organization, and the budgetary relationships between CPF and the PPB process.

2. Chapter III: The PPB Process and CPF

This chapter describes the PPB process in the Navy including recent changes and the processes used and timeline for major program and budget formulation and execution milestones at CPF.

3. Chapter IV: Routine and Emergent Issues and Strategies

This chapter describes both routine and major emergent issues that arise at the Major Claimant level. The chapter also describes the processes and issues surrounding the CPF mid-year review and recent supplemental issues and the methods employed by CPF to execute this funding.

4. Chapter V. Conclusions and Recommendations

This chapter provides final conclusions regarding PPBS at the major claimant level and provides recommendations for further study.

THIS PAGE INTENTIONALLY LEFT BLANK

II. COMPACFLT

A. INTRODUCTION

COMPACFLT (CPF) is one of 24 Navy Budget Submitting Offices (BSO). CPF is headquartered at Makalapa Crater near Pearl Harbor, Hawaii. This chapter will describe participation by this BSO in the Department of the Navy (DoN) and Department of Defense (DoD) Planning, Programming and Budgeting System (PPBS) by describing its processes and relationships, both internal and external. Although many of the issues faced by CPF may vary from issues faced by other BSOs, the processes and procedures to plan, program, and develop and execute their budget reflect enough overall commonality with other major claimants for navy financial managers and comptrollers to extrapolate methods and procedures for budget planning and execution within their claimancies.

Additionally, while not all financial managers/comptrollers will be working at the BSO level, an understanding of the major issues and planning, programming and budgeting methods used at this level will enable financial managers/comptrollers at subordinate levels, the resource sponsor level, Office of the Chief of Naval Operations (OPNAV) level, (N8) level, and Navy Budget Office (FMB) level to more effectively interact with BSOs. To develop an understanding of the issues faced at CPF, one must first understand their mission, scope of their budgetary responsibility, internal and external organization and planning, programming and budgeting relationships. This chapter provides this foundation.

B. MISSION

The mission statement of an organization is provides the purposes for which an organization exists. [Ref.2:p.4] The mission of CPF is:

The mission of the U.S. Pacific Fleet, is to support the U.S. Pacific Command's (PACOM) theater strategy, and to provide interoperable, trained and combat-ready naval forces to PACOM and other U.S. unified commanders. This mission reflects changes since 1986, when the U.S. Congress passed the Goldwater-Nichols Act of 1986 to engender more cooperation and "jointness" between the armed services. PACFLT's role has transitioned from that of warfighter to that of force provider, sustainer and trainer for the unified commanders. The net effect of this change is that the operational chains of command are now shorter and more direct, while PACFLT and other force providers are able to focus on maintaining readiness. [Ref.3]

The Goldwater Nichols Military Reform Act of 1986, under the guise of reorganization actually revolutionizes the way the military does business [Ref.4:p.17] The act empowered regional joint commanders to exercise operational control over all forces in his region of the world.

In his region, PACOM exercises combatant command of assigned forces through commanders of service components, subordinate unified commands, and joint task forces. [Ref.5:p.4] Operationally, CPF is the naval force provider for PACOM. Administratively, as an echelon two commander, CPF reports directly to the Chief of Naval Operations (the Navy's echelon one commander). [Ref.6:Encl(4):p.13]

CPF's mission statement reflects this relationship and chain of command. Other service component commanders reporting to PACOM include:

- U.S. Army Pacific
- Marine Forces Pacific
- U.S. Pacific Air Forces

As the naval forces component commander in the Pacific Region, CPF is the world's largest naval command. [Ref.4:p.8]

C. SCOPE

In order to understand the magnitude of the programming and budgeting at CPF, it is important to first understand the magnitude of its Area of Responsibility (AOR) and the forces and infrastructure that are provided for by its program and budget.

1. AOR

As the naval component commander in the PACOM region, CPF's AOR mirrors PACOM's and includes the Pacific Ocean, a significant portion of the Indian Ocean, and about half of the continental United States. CPF's AOR extends from near the African coast on its west side to Oklahoma on its east side as depicted in Figure 1.

The AOR covers more than 50% of the world's surface; approximately 105 million square miles, and 16 time zones and includes nearly 60% of the world's population. It includes 43 countries, 20 territories and possessions, and 10 U.S. territories. It also includes the world's six largest armed forces: (1) Peoples Republic of China, (2) United States, (3) Russia, (4) India, (5) North Korea, (6) South Korea. [Ref.5:p.1]



Figure 1. PACOM (CPF) AOR. [Ref.5:p.1]

2. Resources

To perform its mission as force provider in its AOR that includes many of the most militarily significant regions of the world, CPF requires an enormous amount of resources. Human resources include 196,000 active duty military personnel, 13,000 reserve personnel, and 30,000 civilian personnel. Its physical infrastructure consists of 20 major installations, 15 minor installations, 191 ships, and 1434 aircraft that are distributed among subordinate TYCOMS, shore commands, or other commands. [Ref.1]

In order to fund its operations, CPFs current estimate of the Fiscal Year (FY)-2002 Operations and Maintenance, Navy (O&MN) account totals \$7,565,000,000. [Ref.7] Including price and program growth, the O&MN account estimate for FY-03 is \$7,477,000,000. These are baseline figures and do not include congressional supplementals received due to costs associated with the war on terrorism and other funding shortfalls identified in the CPF mid-year review (nor reductions due to Congressional adjustments).

The amount of supplemental funding received for FY-02 operations was an additional \$290,000,000. [Ref.1]

Because the CPF AOR is so large and encompasses so much of the world, it will experience contingencies that are not budgeted for and are funded in the form of congressional supplementals. CPF has provided forces to operations Southern and Northern Watch in Iraq, Noble Eagle in Afghanistan and Enduring Freedom that expands the war on terrorism worldwide. CPF also provide forces to support U.S. policies throughout the region in areas such as East Timor and the Philippines and is now beginning to become involved in homeland security as a component commander who reports to the U.S. Northern Command (USNORTHCOM) for operations regarding homeland security. Much of the supplemental money provided to CPF is result of the costs incurred supporting these contingency operations. [Ref.8]

D. SUBORDINATE COMMANDS

CPF's claimancy includes five operational commanders, four type commanders (TYCOMs), and six navy regional commanders. CPF acts as the BSO for all activities contained within these organizations. These organizations include:

Operational commanders:

- SEVENTH Fleet
- THIRD Fleet
- Maritime Defense Zone
- Task Force 12 (Undersea Warfare)
- Task Force 14 (Missile Submarines)

TYCOMs include:

- Air (COMNAVAIRPAC)

- Surface (COMNAVSURFPAC)
- Submarines (COMNAVSUBPAC)
- Fleet Marines

Regional Commanders include:

- Marianas (Commander Naval Forces Marianas)
- Japan (Commander Naval Forces Japan)
- Korea (Commander Naval Forces Korea)
- Pearl Harbor (Commander Navy Region Hawaii)
- San Diego (Commander Navy Region Southwest)
- Seattle (Commander Navy Region PACNORWEST)
[Ref.1]

In addition to these regions, the CPF claimancy also includes small naval forces in Singapore (Logistics Group WESTPAC) and Diego Garcia, British Indian Ocean Territories. Each "sub-claimant" contains its own comptroller who is responsible for providing programming estimates and budget submissions to the BSO, CPF.

E. CPF INTERNAL BUDGETING AND PROGRAMMING ORGANIZATION

CPF's internal programming and budgeting structure was recently changed to reflect that of the DoN. Prior to the change, CPF programming and budgeting functions were both performed under the direction of the CPF Comptroller. Recently however, CPF reorganized into the Comptroller, a Navy Captain, who is designated N00F, the Director, Fleet Warfare Requirements, Force Structure, and Programming, a civilian GS-15 who is designated N8, and program managers who reside in the "N codes."

1. Comptroller

The comptroller's function is to oversee the budget preparation and execution process at CPF. He also supervises the fleet accountants who maintain official

records of obligations and expenditures throughout the fleet. The comptroller at CPF is analogous to the Navy Budget Office or FMB. He does not perform programming functions but develops the budget for the fleet based on programming requirements. The comptroller at CPF is designated N00F, reporting directly to the Commander. This direct reporting relationship is mandated by SECNAV Instruction 7000.27 which states:

The commanding officer or head of an activity that receives allocations or suballocations of funds subject to the Antideficiency Act (31 U.S.C Section 1341 or 31 U.S.C Section 1517) shall have a qualified comptroller who reports directly to the commanding officer. [Ref.9:p.1]

The instruction goes on to state the responsibilities of the comptroller:

The comptroller shall ensure that the requirements of reference (g) are met and have overall responsibility for budget formulation, budget execution, financial management, managerial accounting program analysis, and performance measurement. [Ref.9:p.2]

The current department organization for the comptroller at CPF is depicted in Figure 2.

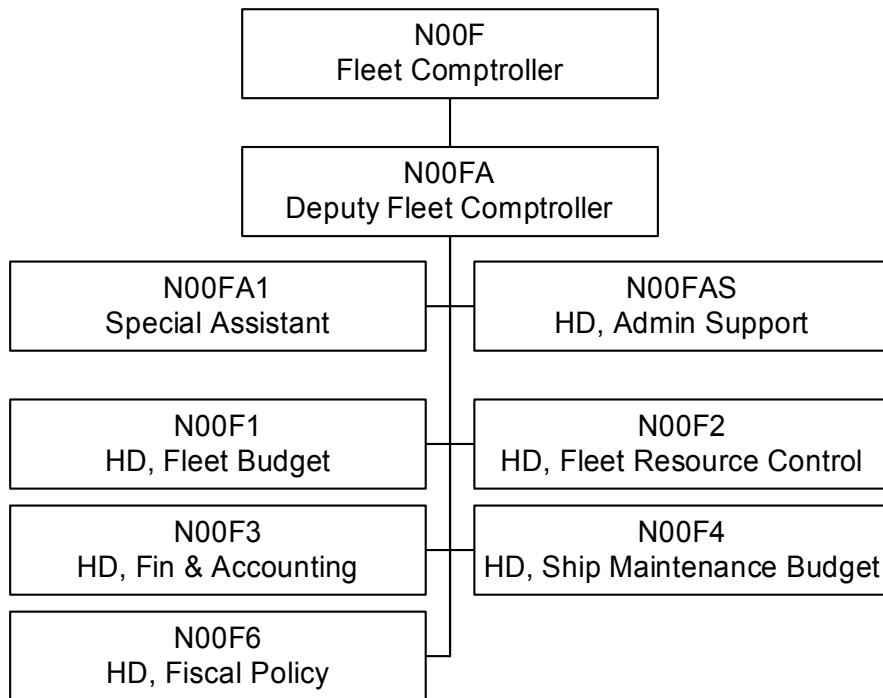

Figure 2. CPF Comptroller Organization. [Ref.1]

As directed by SECNAV Instruction 7000.27, the CPF comptroller performs the prescribed budgetary functions of formulation, execution, financial management, accounting, program analysis, and performance measurement. This thesis, however will focus on the relationships and processes that take place in N00F1, the Fleet Budget section and N00F2, the Fleet Resources section of the CPF comptroller organization.

The N00F1 position at CPF is held by a DoD civilian. N00F1 prepares budget submissions for the DoN, OSD and Presidents Budgets (PRESBUD) for POM and Program Review (PR) years, the PRESBUD submission for the upcoming execution year and reconciles the executed budget at years end by certifying the obligations made against it. In order to perform these functions, N00F1 employs

approximately 13 budget analysts that prepare O&MN budgets that are broken down into five major areas:

- Air Operations
- Ship Operations
- Combat Support
- Ship Maintenance
- Base Operating Support

Figure 3 depicts the CPF budgeting organization.

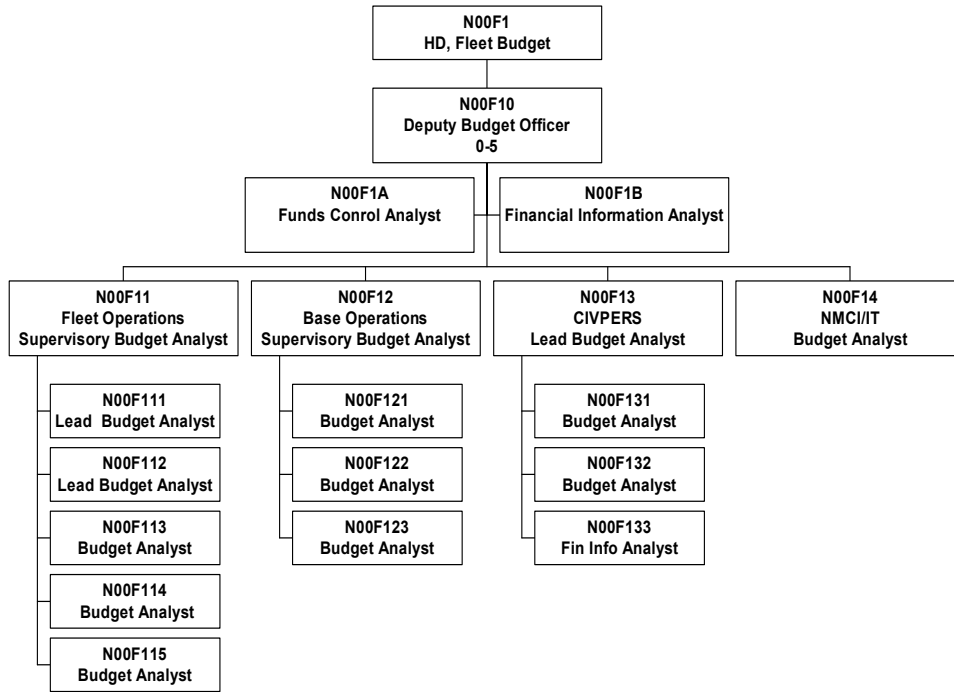

Figure 3. CPF Budget Department Organization. [Ref.10]

The new budget is executed at CPF by N00F2. The function of N00F2 at CPF is performed by a Navy Commander. N00F2 is responsible the execution of current budget year control numbers. The N00F2 department has five budget

analysts who report directly to the department head. Analysts within N00F2 are responsible for monitoring the obligation of funds at subordinate commands. Additionally, they coordinate with the budget analysts and program managers to effectively coordinate funding of emergent issues, execution adjustments, conduct mid-year review and request for supplemental funding based on unfunded requirements, and end of year "sweep-up" of funds. The organization of the Resource Control Department is depicted in Figure 4.

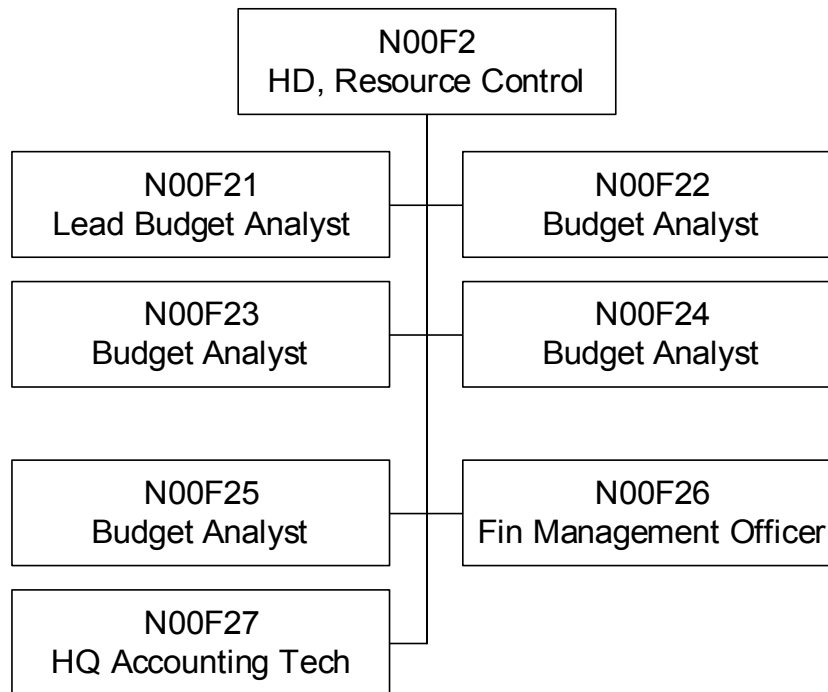

Figure 4. Resource Control Organization. (Budget Execution) [Ref.10]

2. Programming

While SECNAV Instruction 7000.27 directs that the comptroller for activities that receive allocations or sub-allocations reports directly to the commanding officer

(PACFLT), there is no corresponding requirement for heads of programming. Programming functions at CPF take place within the "N" codes. The N codes report to the Commander via the Deputy Commander, a two star admiral. Fleet requirements formulation is conducted by officers within N codes such as N8 for warfare requirements and assessments and N43 for fleet maintenance which includes aviation, surface ship, and submarine maintenance and N46, who is responsible for programming for shore activities.

Program Managers within CPF maintain close liaison with program sponsors in Washington, DC as well as points of contact at subordinate commands within the CPF claimancy such as TYCOMS for fleet warfare and maintenance requirements and regional headquarters for Base Operating Support (BOS). They function to coordinate fleet resource assessments and requirements which are used to develop program inputs to resource sponsors in Washington, DC. While primarily active in the programming phase of PPBS, the program managers maintain contact throughout the fleet and with their resource sponsors in Washington and serve as resident experts within CPF for emergent budget and execution issues. [Ref.11] Figure 5 depicts the programming structure at CPF.

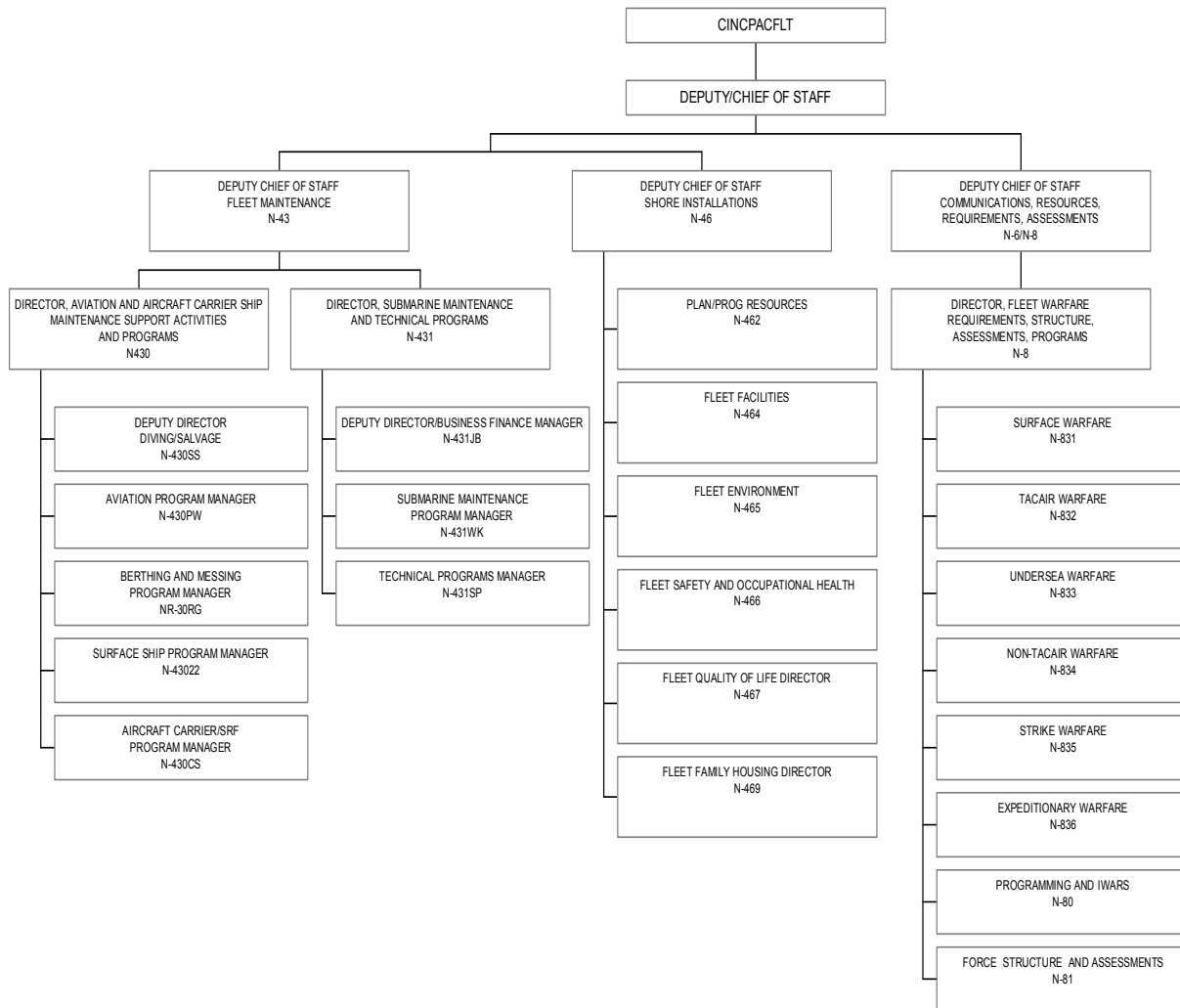

Figure 5. CPF Programming Structure. [Ref.12]

F. INTERACTION AMONG DEPARTMENTS

Although CPF employs budget analysts in two departments within the comptroller organization whose missions are different (budgeting and execution) and develops warfare requirements, assessments and programs within different N codes, programming, budgeting and execution are not conducted in a vacuum within CPF. Although budget analysts are familiar with the inputs, marks (or issues), and budget decisions which helped to formulate and evolve the budgets, they will rely on the

program managers who performed the assessments and developed requirements for their areas of the fleet program and budget when conducting analysis on subordinate commands' budget submissions. Similarly, program managers must be aware of the issues that arose during the development, submission, and execution of prior years' budgets when conducting their assessments and developing their requirements.

Recent changes to the PPBS process within the DoD (to be discussed in chapter three) have served to reinforce the necessity for programmers and budgeters to strengthen their working relationships.

G. CHAPTER SUMMARY

CPF is the largest naval fleet command in the world. It's mission to be the naval force provider to its operational commander, USPACOM. In order to provide those forces, CPF conduct planning, programming, and budgeting activities and employs an organizational structure similar to the DoN structure where OPNAV, N80 performs programming functions and FMB performs budgeting and execution functions. Chapter III will describe the PPBS process within the Navy, DoD, and CPF. It will also describe a recent change to the process that mandated that programming and budgeting (within the services) be conducted concurrently.

THIS PAGE INTENTIONALLY LEFT BLANK

III. THE PLANNING, PROGRAMMING AND BUDGETING SYSTEM AND COMPACFLT

A. INTRODUCTION

As one of the Navy's BSO's, CPF planners, programmers and budgeters participate in all phases of the Planning, Programming, and Budgeting System (PPBS). In the planning phase, CPF participates in the Integrated Warfare Architectures (IWARs) analysis; in programming, CPF requirements officers develop fleet resource requirements and program managers prepare Capabilities Plan (CP) inputs based on those requirements; in the budgeting phase, CPF provides control numbers to activities and solicits their budget inputs based on those control numbers. They then consolidate fleet budget estimates and provide required supporting exhibits to the Navy's Office of Budget (FMB) which are used to develop the Navy's Budget Estimate Submissions (BES). CPF monitors and provides feedback, and adjusts its budget submissions throughout DoN and OSD. It is then up to CPF to execute that budget in coordination with its activities and FMB.

This chapter reviews the PPB process in the Navy and discusses a recent revision to the process that combines the programming and budgeting phases into a concurrent process. The chapter then describes CPF's interaction with the process and presents a timeline of CPF's major milestones in the PPBS process.

B. PPBS OVERVIEW

The ultimate objective of the DoD PPBS is to provide the best mix of forces, equipment, and support attainable within fiscal constraints.
[Ref.13:p.1]

PPBS is the heart of the Defense resource allocation process. The PPBS process was introduced to the DoD by Secretary of Defense (SECDEF) Robert S. McNamara in 1962. [Ref.13:p.5] It is a cyclic and iterative process consisting of interrelated and overlapping phases: Planning, Programming, and Budgeting. [Ref.14:p.1]

Planning is the first step of the PPBS process. During the planning phase, the objective is to identify threats to national security, assess current capabilities to address those threats, and recommend forces required to defeat them. The planning phase attempts to answer a very difficult question: "How much defense is enough?" [Ref.13:p.1] The end result of the planning phase in navy planning is the summary CNO Program Assessment Memoranda (CPAM) that develops and supports navy goals for programming based on IWAR assessments. The summary CPAM provides the foundation and recommendations for navy programming and fiscal guidance that must be considered when developing its program based on Defense Planning Guidance provided by OSD.

During the programming phase, the services attempt to translate CPAM priorities and fiscal guidance given in the DPG into a six-year resource proposal program that meets those priorities and fiscal constraints. The challenge of this phase is to apply fiscal constraints to loosely constrained guidance from the planning phase and develop an acceptable proposal for how to allocate available resources.

The services programming decisions are articulated via their POM which is submitted to SECDEF. Programs are then

reviewed to assess how closely they followed planning guidance. Based on this assessment SECDEF issues Program Decision Memoranda that are final decisions on resource allocation. The programming phase answers the question, "How much defense can we afford?" [Ref.13:p.1]

The next phase of the PPBS process is budgeting. The budgeting phase focuses on the first two years of the six-year Future Years Defense Program (FYDP) for POM years and the first year of the FYDP in program review years. The purpose of the budget phase is to "price" the program and determine if it is executable in light of "fact-of-life" issues. The outcome of the budget cycle is either a one or two-year budget estimate submission. The POM/PR based budget, becomes the President's Budget (PRESBUD) submission from OSD to congress after DoN, DoD, and OMB review. The PRESBUD is the final product of the PPBS process and serves two purposes: 1) it provides a plan that lays out what the DoD wants to spend money on to achieve the goal of providing the best mix of forces, equipment, and support within fiscal constraints and, 2) it is a request to Congress to appropriate the required budget authority to achieve the plan and provides execution controls based on appropriations for the current fiscal year budget. [Ref.13:p.2]

C. THE NAVY PPBS PROCESS

1. Planning Phase

The organization in charge of coordinating the Navy planning process is the CNO Assessment Division (N81). The Navy produces three major planning products:

- Integrated Warfare Architectures (IWAR) assessments

- Chief of Naval Operations (CNO) Program Assessment Memoranda (CPAMs)
- Programming and Fiscal Guidance [Ref.13]

a. IWAR

Starting in 1998, the Navy's tool for planning became a broad-based analysis process involving 12 IWARs. IWARs are comprised of five warfare and seven support areas. The five warfare areas consist of Power Projection, Sea Dominance, Air Dominance, Information Superiority/Sensors, and Deterrence. The foundation of the five warfare areas are seven support areas that include: Sustainment, Infrastructure, Manpower and Personnel, Readiness, Training and Education, Technology, and Force Structure. The 12 IWARs are assessed from the standpoint of end to end capabilities. The assessment process attempts to answer the question of "how much is enough, both in terms of quality and quantity, today and in the future" for all 12 IWARs. [Ref.13] The IWARs are assessments conducted by Integrated Product Teams IPTs that are comprised of Secretariat, Claimant, Fleet, and resource sponsor representatives.

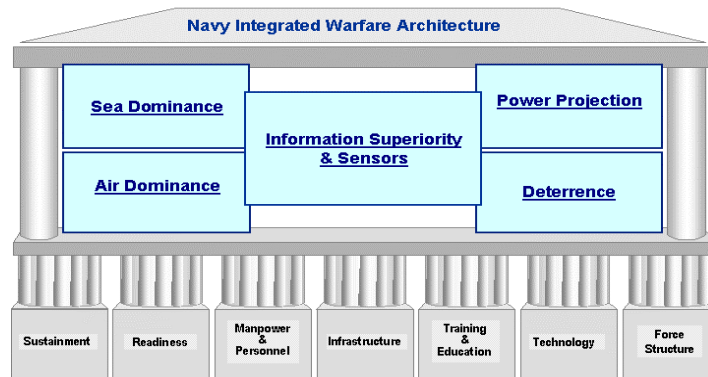

Figure 6. Navy IWAR Structure. [Ref.12]

IWARs are intended to:

- Provide senior naval leadership with the foundation for resource decisions by conducting end-to-end capability analysis of warfare and support areas
- Provide linkage across Navy's strategic vision, threat assessment, and resource programs
- Analyze the current and planned program and identify capability shortfalls and surpluses
- Identify the impact of alternate paths to reach near, mid, and far term warfighting capabilities [Ref.13]

b. CPAM

The analysis generated by the IWAR process, feeds directly into the CPAM. Based on IWARs analysis, CPAMs are designed to produce a balanced program that supports the Navy's goals. Each of the 12 IWARs will lead to an individual CPAM. CPAMs are then combined into a summary CPAM which becomes the basis for N80's Programming and Fiscal guidance. N80's guidance, combined with the DPG becomes the basis for development of the Navy's POM. CPAMs will:

- Provide balanced programs across warfare and support area capabilities and over time
- Provide senior naval leadership with the foundation for Programming and Fiscal Guidance
- Evaluate the impact of IWAR issues on near/mid/far term warfare and support area capabilities
- Recommend specific programmatic adjustments based on capability tradeoffs, alternatives, and options [Ref.13]

c. Navy Programming and Fiscal Guidance

The Navy programming and fiscal guidance provides navy resource sponsors with general and specific guidance

from the CNO when developing their Sponsor Program Proposals (SPPs). The guidance is developed based on IWAR/CPAM analysis and is issued as the first POM serial.

2. Programming Phase

During the years prior to 2001, the product of the programming phase, the POM, formed the basis of the budgeting phase of the PPBS cycle. On 02 August 2001, Donald Rumsfeld (SECDEF) forwarded a memo that changed the PPBS process. The memo, "Concurrent Defense Program and Budget Review" was sent to the military departmental secretariats, the CJCS, other military directorates, commanders, and undersecretaries. The memo states:

This year, and in the future, we will conduct a concurrent program and budget review. The review this year (2001) will consider all program and budget issues and be the primary venue for resolving any programmatic or budget issues arising from the Quadrennial Defense Review. It will be used to verify that programs proposed by Components can be executed within established fiscal guidance and focus on issues that arise during execution and from other fact of life changes. Issues previously resolved by the Secretary or Deputy Secretary of Defense will not be revisited.

Your submissions for concurrent review will be due October 1, 2001. We are currently in the process of developing overall guidance for the review, to include which specific exhibits will be required. All additional information will be provided to you by the Under Secretary of Defense (Comptroller) as soon as the details are completed. [Ref.15]

This memo marks a fundamental change to the PPBS process. Prior to August, 2001, the services developed and submitted their POM's to OSD for review in May. The services would then start to build their Budget Estimate

Submissions (BES's), based on their POMs. After 2001, services are required to submit both their BES's and their POMs to OSD simultaneously in late-August. Navy BES's are now developed based on Tentative POM (T-POM) control numbers that are issued in late May. [Ref.16]

The organization responsible for coordinating and managing navy programming is the CNO Programming Division (N80). N80 publishes POM serials that serve as programming instructions as well as fiscal guidance for Resource Sponsors, Assessment Sponsors, Major Claimants and others involved in the POM process. In addition, N81 conducts assessments of the Capability Plans which are based on the programming and fiscal guidance. N83 validates Fleet requirements and programming inputs. If N80 finds that resource sponsors are not in compliance with fiscal or programming guidance, they will direct the sponsor to bring their program into compliance.

Prior to the navy realignment that was conducted after the present CNO's appointment, navy warfare resource sponsors were a part of the N8 organization. As a result of the realignment however, resource sponsors were moved to N7 which was established as DCNO for Warfare Requirements and Programs to give visibility to warfare programs and training & education. [Ref.16] Warfare resource sponsors now have an advocate at the three-star level similar to the leadership of N8. N7 now consolidates SPPs into an Integrated Sponsor Program Proposal (ISPP) that balances the resources available to provide an equitable distribution among warfare areas based on valid Fleet

requirements and ensure compliance with both fiscal and programming guidance.

Resources, Requirements, and Assessments (N8)

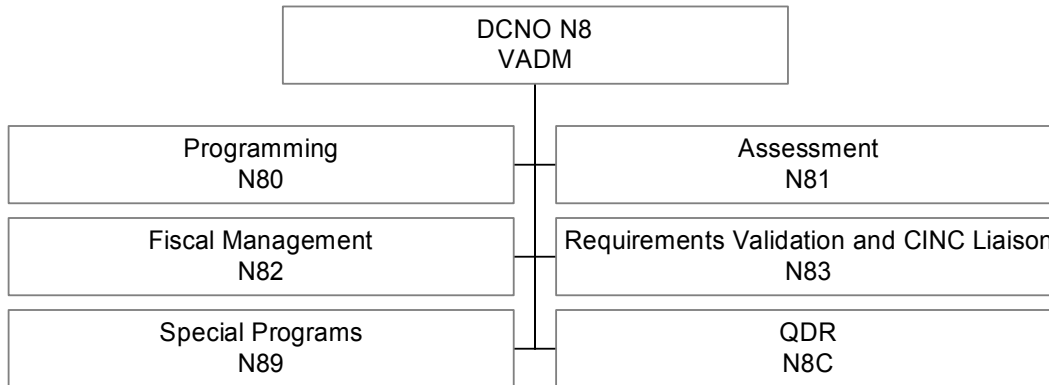

Figure 7. N8 Organization. [Ref.17]

Warfare Requirements and Programs (N7)

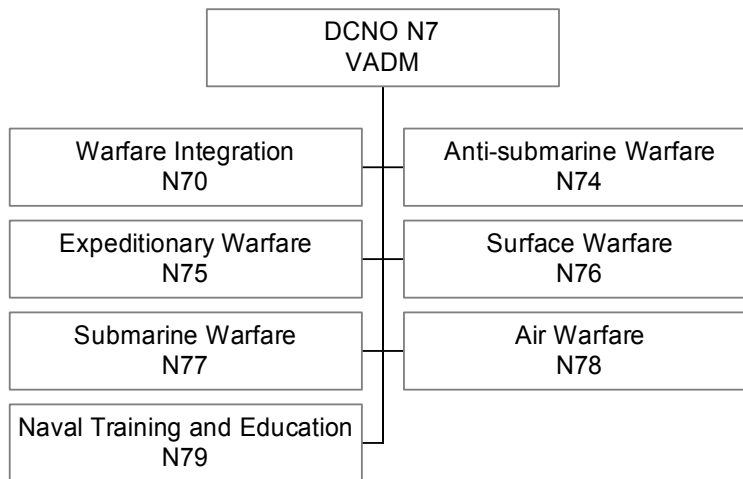

Figure 8. N7 Organization. [Ref.17]

Once the navy program is developed it is reviewed by the Resource Requirements Review Board (R3B), that is the Navy's focal point for deciding warfare requirements and resource programming issues. The board is chaired by N8 and consists of principals from N1 (personnel), N3/5 (plans, policy and operations), N4 (logistics), N6 (space

and information warfare), N7 (training), N09G (Navy Inspector General), N093 (Navy Medical), N095 (Naval Reserve), Navy Air Systems Command (NAVAIR), Naval Sea Systems Command (NAVSEA), and the Marine Corps Deputy Chief of Staff (programs and resources). Other subject matter experts are called in to advise on an as-needed basis. High interest items that involve both the Navy and Marine Corps are addressed by the IR3B which includes members of the R3B but incorporates principals from Marine Corps directorates. Major issues that remain unresolved at the R3B and IR3B are forwarded to the CNO Executive Board (CEB) for resolution. The CEB principals include the CNO, VCNO, N1, N3/5, N6, N7 and N8. CNO decisions on the T-POM are then briefed to senior navy military and civilian leadership at the Department of the Navy Strategy Board (DPSB).

Prior to 2001, the Navy and Marine Corps T-POMs were combined and briefed to SECNAV. SECNAV's decisions on the T-POM were then incorporated into the T-POM and the output became the Department of the Navy's POM. The POM was forwarded to SECDEF for review and the Navy began to build its budget based on the POM. As a result of Secretary Rumsfeld's August, 2001 memo, the Navy now uses the T-POM to develop both its program and budget concurrently. Although the T-POM is 1) not the final POM, 2) is not locked, 3) may still be changed if execution issues arise during the program/budget review phase, and 4) is used to develop budget control numbers for claimants, it must be noted that it has received CNO approval and has been briefed to SECNAV. [Ref.18] Thus, there is a tendency to treat it as final.

3. Budgeting Phase

A DoN budget is developed for each of the three phases of budgeting. The three phases of the budget process are: 1) BSO submission to FMB, 2) Navy submission to OSD, and 3) OSD submission to Congress. The PPBS budget process begins when FMB issues its initial Budget Guidance Memorandum in March. Budget Guidance Memorandums are serialized throughout the fiscal year and are issued as the need arises.

For FY-02, the initial memorandum, BG 02-1 was issued on March 29th and the final serial, BG 02-1K was issued on July 17th. BG 02-1 provided BSO's with the DON Program/Budget Calendar, pricing factors to be used in preparing budget submissions, requirements for budget exhibits, and guidance supplementary to that found in the Navy's budget guidance manual. Shortly after issuing the first Budget Guidance Memorandum, FMB issues budget control numbers (dollars) derived from the T-POM for operating accounts (post 2001) that BSO's use to develop their budget submissions. Based on their control numbers BSO's prepare, compile, and submit budget estimates and required supporting exhibits directly to FMB based on guidance provided in the Budget Guidance Memoranda. BG 02-1 directed BSO's to submit operating account budget exhibits for FY-02 through FY-05 no later than May 31st. Data required included budget data for the current year (FY-02), the budget year (FY-03 PRESBUD), and for the two POM years (FY-04 and FY-05).

After budgets are submitted to FMB based on the T-POM controls numbers, the Navy conducts a concurrent DoN

program/budget review. The concurrent program/budget process is a combined (or reciprocal) process versus a sequential process. The reasoning behind the concurrent program/budget process is:

- It incorporates a common perspective for program, budget formulation and execution
- It provides a comprehensive review of pricing/ executability before POM wrap up
- Discrete program adjustments can continue to be implemented during the budget review phase
- It allows for continued program refinement [Ref.19]

Prior to 2001, once the POM was locked and control numbers developed, the program was set and could not be adjusted in a meaningful way, except for changes mandated by PDMs, until the following year during the POM or Program Review (PR) [Ref.16]. It is important to note that as a result of recent navy re-alignment and the concurrent program/budget process, sponsor proposals that are incorporated into the program have been reviewed for proper allocation and compliance with guidance and consolidated as an integrated N7 input. Additionally, the budget is built on the T-POM controls and the final POM or Program Review and budget are forwarded to OSD at the same time and the line between the programming phase and budget phase has disappeared. Programming changes can be made at the same time as budget changes and in response to N80/FMB and BSO inputs to help ensure that the program is executable as a budget. Figures nine and ten present the PPBS cycle before August 2001 and after. Although it doesn't appear significant, the line separating programming and budgeting no longer exists.

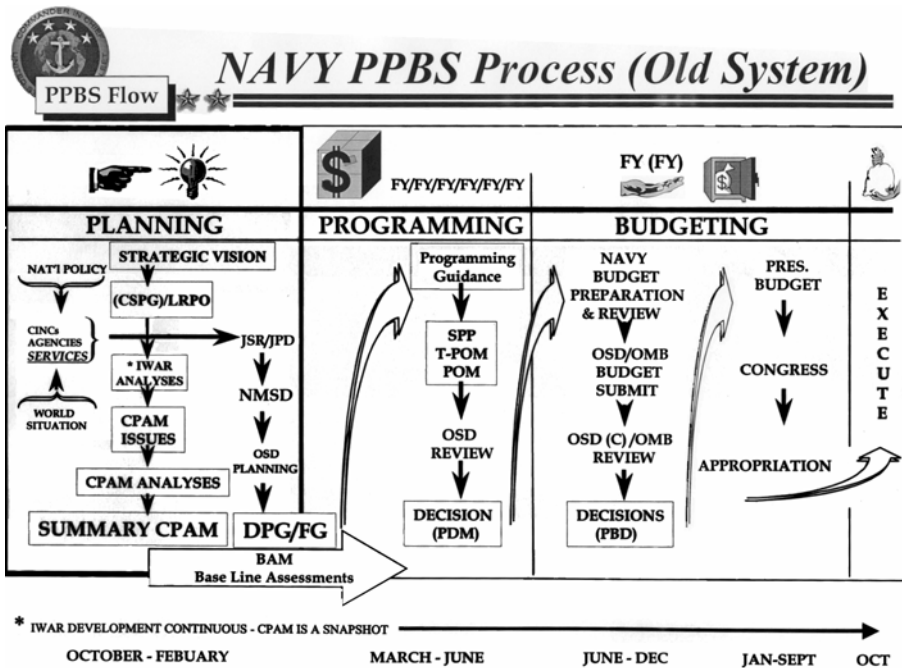

Figure 9. PPBS Prior to 2001. [Ref.1]

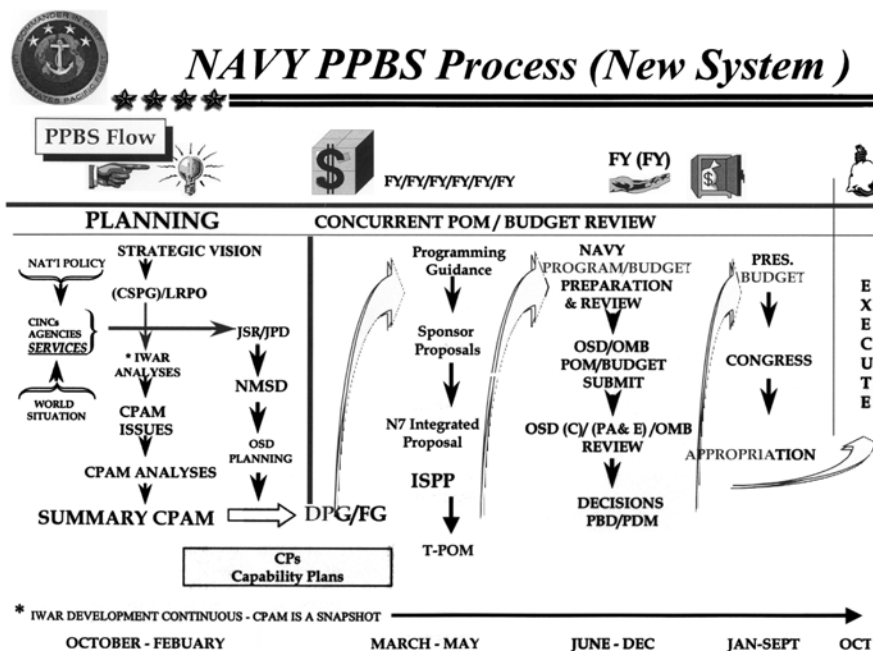

Figure 10. PPBS 2001 and Subsequent. [Ref.1]

The mechanism for making changes to BSO budget submissions also changed as a result of the concurrent program/budget review. In prior years, the mechanism FMB used to challenge BSO budget submissions was called a mark. Marks are adjustments (usually negative) to the estimates submitted by the BSO prepared by the cognizant FMB analyst [Ref.13]. In response to marks, BSO's had the right of reclamation. Reclamation's provided the BSO with the opportunity to respond to adjustments made in the FMB mark in attempt to restore the funding that was removed. If a reclamation was submitted to a specific mark, that mark was considered a tentative decision until that mark was resolved.

The method for resolving reclamation's started with the cognizant FMB budget analyst and progressed through the department head and division director. Unresolved marks became major issues to be resolved at Major Budget Issue meetings. The absence of the restoration of a mark after this meeting represented a decision result that would be forwarded to SECNAV.

The mechanism for resolving program/budget issues post 2001, is the "issue paper." Issue papers have replaced the mark/reclamation process. The issue paper process is more dynamic than the previous mark/reclamation process. Marks focused on specific issues for which BSO's would prepare reclamation's. Mark's were generated at the FMB level and distributed to cognizant BSO's; issue papers, on the other hand, enable all stakeholders to present an issue at the appropriate level or to view outstanding issues or comment on issues that affect them. [Ref.18] While an issue may not specifically address a particular BSO, or activity any

stakeholder is free to submit comments, reinforcing the primary addressee's comments on the issue. An example is information technology (IT) funding. IT, inherently underfunded in the POM, affects all CPF activities [Ref.16]. The sub-activities are free (after coordination with the BSO) to address the specific requirements that will be affected by the issue within their region, numbered Fleet, or TYCOM. IT funding issues are also not limited to the CPF claimancy but affect the Navy as a whole. [Ref.15] Not only are CPF activities free to comment, but other claimancies are also free to comment on an issue. While claimaints other than the one specifically addressed by an issue are free to comment, it must be noted that this is not a "free-for-all" and that consideration must be given prior to making comment on issues not specifically addressed to a particular claimant.

When issues are generated, they are posted to the Navy Headquarters Budget System (NHBS) website. The website provides stakeholders with a method of generating issue papers, submitting them, making comments on them, and reviewing comments that have been posted. If issues go unresolved (via the FMB/N80 analyst, department head, and division directors) they are presented to the Program Budget Coordination Groups. PBCG's are similar to Major Budget Issue meetings. They are the final resolution of issues prior to being forwarded to the CNO and SECNAV. While Major Budget Issue meetings resolved only budget issues, PBCG's may resolve both program and/or budget issues. While both program and budget issues may be addressed, the PBCG is primarily FMB's forum. PBCG membership consists of representatives of FMB, N80, N7,

Commander Fleet Forces Command (CFFC) and N43 (Fleet Readiness). [Ref.20] PBCG's meet to review issues by budget area, i.e. Civilian Personnel, Military Manpower, Base Operations, Aircraft Operations, Ship Operations. The PBCG schedule and major issue area are also posted on the NHBS website.

Following SECNAV review, the program, which now becomes the POM, and budget are submitted concurrently to OSD. OSD adjusts the services' submissions by issuing Program Budget Decisions (PBDs). When PBDs are incorporated, the budget is forwarded to the Office of Management and Budget (OMB) where it becomes the defense portion of the PRESBUD that is submitted to Congress.

a. Concurrent Budgets

The previous section described the PPBS process for budgeting. It must be noted that the PPBS process is mainly concerned with developing a POM and budgets for both the POM and subsequent year in even numbered years and the PR and budget for the PR year in odd numbered years. Therefore, in FY-02, the Navy prepared POM 04 and budgets for FY-04 and FY-05 and in FY-03 the Navy will conduct a PR for FY-05 and refine the FY-05 budget. It must be kept in mind though, that while these budgets are being developed, the PRESBUD for the upcoming fiscal year is being refined, and the current fiscal year's budget is being executed; thus there are actually three budget processes being performed in any given year as depicted in Figure 11.

PPBS Cycle

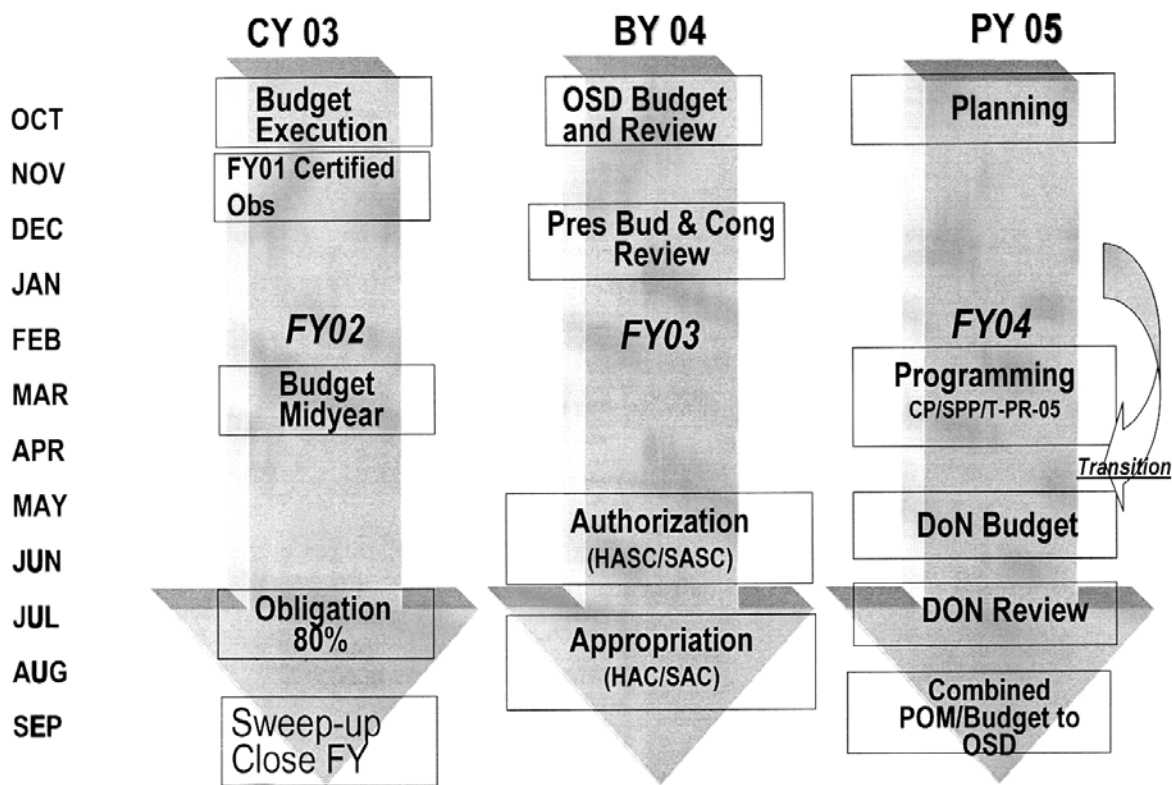

Figure 11. FY-02 Budget Processes. [Ref.1]

As can be seen in Figure 11, during the current year, the Navy (and its BSO's) are working on three separate budgets. Using figure 11, the Navy is executing the FY-03 budget at the same time it is preparing the FY-04 PRESBUD and FY-05 program/budget. There are ripple affects that occur though as a result of what is happening in the current execution year and these affects push into both budget and program decisions for subsequent years. At the BSO level, programmers, budgeters and execution personnel are all actively engaged in all three budget processes.

D. PPBS AT COMPACFLT

As a major navy BSO, CPF participates in every phase of the PPBS cycle. In the planning phase, they participate

by developing IWARS focus areas and conducting IWARS analysis through Integrated Process Teams (IPTs) the results are incorporated in CPAMs that are the foundation for developing the Navy's program.

During the programming phase, CPF develops fleet resource requirements and provides monetary programming inputs to resource sponsors in the development of the Navy program. In the budgeting phase, CPF develops control numbers for its sub-claimants based on T-POM control numbers, consolidates sub-claimant budget submissions, and provides FMB with their BES. CPF then monitors the DoN program/budget review process at both the DoN and OSD levels ensuring any CPF claimancy issues are addressed and resolved. CPF revises its budget throughout the process until submitting its PRESBUD input that will be executed in the following fiscal year.

CPF is also a major player in budget execution. They develop execution control numbers and plans for their activities, monitor funding obligation rates, conduct a mid-year review, oversee the end of the execution year "sweep-up" of funds, and allocate supplementary funding. This section will discuss certain aspects of CPF's integration into the Navy PPBS cycle.

1. Planning

CPF provides planning inputs such as IWARS focus area recommendations and IWARS focus area analysis to OPNAV N81 via Commander, United States Fleet Forces Command (CFFC). CFFC was established during the CNO's realignment and is a concurrent responsibility of Commander in Chief, U.S. Atlantic Fleet (LANTFLT/CLF). CFFC is responsible for

overall coordination, establishment, and implementation of integrated requirements and policies for manning, equipping and training Atlantic and Pacific fleet units during inter-deployment training cycle (IDTC). [Ref.19:Slide 12] CFFC consolidates inputs from both CPF and CLF before forwarding them to N81. CFFC also coordinates Fleet inputs during the programming phase of the PPBS cycle.

b. IWARS

CPF's primary participation in the planning phase of PPBS is via the IWARS process. In May, CPF receives a data call from OPNAV N81 via CFFC requesting priorities for IWAR analysis for the current year. CPF develops areas for consideration in the IWARS process based on:

- CNO guidance
- Theater concerns
- Previous IWARS [Ref.21]

CPF develops their priorities, focusing on areas where they feel either capabilities are non-existent or inadequate to meet threats, or resources are misaligned causing incomplete capabilities. [Ref.21] After CPF forwards its desired focus areas to CFFC for consolidation, N81, reviews and develops Navy IWARS focus areas. In 2002, CPF developed proposed focus areas in four of the five IWAR war-fighting areas: Air Dominance, Sea Dominance, Power Projection, and Information Superiority and Sensors and six of the seven IWAR support areas: Infrastructure, Readiness, Sustainment, Training, Manpower/Personnel, Training/Education, and Force Structure.

In June, N81 determines yearly navy IWAR focus areas based on responses to its data call. CPF will then participate in IWARS analysis via the IPT. IPT's are

comprised of cognizant program managers or requirements officers from COMPACFLT, COMLANTFLT, COMUSNAVEUR, and the OPNAV staff. Most IWAR interaction from this point is web-enabled allowing rapid interaction among IWAR focus area points of contact on the CPF, CLF, and NAVEUR staffs. [Ref.20] IWAR analysis continues through October. CPF, N80 coordinates CPF interaction during the IWAR analysis phase. This concludes when the focus area study results are briefed to Resource Sponsors, Assistant SECNAVs, CNO/Vice CNO (VCNO), and Fleet Commanders in October. Following IWAR briefs CPAMs are developed and consolidated to become the summary CPAM which is briefed to Fleet Commanders in February of the following year. This CPAM then becomes one of the Navy's inputs to the PPBS programming phase.

2. Programming

Programming at CPF is mostly concerned with O&M accounts and is performed by the N8 and N4 codes. The mechanism for providing program inputs to OPNAV is via Capability Plans (CPs). CPs were formerly known as Baseline Assessment Memoranda (BAMs). In October 2003, OPNAV N801E distributed the first CP serial that changed program assessments from BAMs to CPs. A CP is an identification and critical evaluation of a baseline valid requirement for specific programs and estimates the funding necessary to achieve 100% of the valid requirements. [Ref.22] For example, CP inputs are developed for CPF for their Flying Hour Program. The CP will provide "an assessment of the flying hours required to meet stipulated readiness goals and the resultant flying hour support requirement necessary to support those hours." [Ref.22]

CPF's initial formal interaction with the CP process is the draft CP procedures memorandum serial that they receive from OPNAV N80 via CFFC in September. In 2002, CPF received a draft BAM serial in September for review. The draft was a rough copy of the BAM guidance for Program Review (PR) 05. CPF makes corrections to the draft as it determine necessary and submits its corrected copy back to CFFC.

Adjustments are made to the draft copy and the actual guidance is then distributed. From 2002 forward, guidance will address CPs. The CP procedures memorandum specifies assessments that will be conducted; assigns assessment sponsors who oversee the assessments; provides guidance for conducting the assessments; and delineates responsibilities for producing the CPs. For Program Review 05 sponsor responsibilities included:

- Assessment sponsors: Assessment sponsors should prepare the assessments listed in enclosures (1) and (2) and deliver them to OPNAV (N81) no later than 31 January 2003. Use the FY-04 Navy BES resource allocation display as the resource baseline.
- Resource Sponsors: Work closely with assessment sponsors for CP development. Satisfy CP requirements wherever possible when developing PR-05 SPPs. Clearly document compliance and explain areas where the assessed requirement has not been met.
- Assessment Division (N81): N81 will participate in the development of CP to ensure that each requirement is valid based on analytically sound methodology
- Claimants: Participate in IPTs and work groups as requested by assessment sponsors to support the respective assessments

- Fleets: CFFC is the Fleet Requirements integrator and the conduit of Fleet requirements to OPNAV. As such, Fleet (PAC/LANT FLT/NAVEUR/Lead TYCOMs) and NAVSEA, where applicable (i.e., as operator of government-owned shipyards input will be coordinated, consolidated, and submitted via CFFC CP POCs to Assessment Sponsors. [Ref.22]

The CP procedures memorandum also details factors to consider when preparing CPs for submission to N81. The procedures memorandum does not tell Assessment Sponsors how to conduct their assessments, but it does request that assessment sponsors provide a detailed description of the methodology that was used to conduct the assessment. This means that there is no standard method for conducting the CP process and different programs develop program resource requirements using differing methodologies. PR-05 CP and assessment sponsors are detailed in Table 1.

Based on requirements developed for its claimancy, CPF program managers provide assessment sponsors with the dollar amount their programs cost to meet 100% of the valid requirements. CPs prepared by the assessment sponsors provide N81 with the cost to fund 100% of the validated requirement being assessed across the Navy. Based on resources actually available, programs will be funded at a percentage of the 100% requirement. Actual funding levels are provided by N80 in its Program Guidance.

PR-05 CP Topics	Sponsor
Total Force Management	N1
Ashore Readiness	N4
Contingency Engineering (naval Construction Force	N4
Maritime Readiness/Sustainment	N4
Aviation Readiness/Sustainment	N4
Conventional Ordnance Readiness/Sustainment	N4
Anti terrorism/Force Protection	N3/N5
Fleet readiness	N4
NMCI	N6
Individual Training and Education	N1

Table 1. CP Topics and Assessment Sponsors
[Ref.22]

For PR-05, assessment sponsors are required to submit their CPs to OPNAV N81 no later than 31 January 2003. [Ref.20] Based on the CPs, IWARs, and CPAMs, N80 develops its programming guidance. The programming guidance is preliminary guidance to resource sponsors for developing their SPPs. If N80 guidance is promulgated prior to the DPG, N80 will revise the guidance based on the DPG. CPF monitors program development as the resource sponsors adjust funding to meet the program. CPF program managers decide if changes being made to funding within resource sponsors are major enough to attempt to justify adding money back in during the programming phase. [Ref.23]

Prior to 2001, when the POM was almost complete, CPF would participate in the "end game." End game was a small window of opportunity before the POM was "locked" where CPF could address the most important major programming issues that could not be resolved in their favor throughout the programming phase. The commander would either transmit a message or even contact the CNO directly regarding his last major issues. According to the CPF budget director, the general message being sent is: "Based upon the SPPs, what's in the programming data base (WINPAT) at this point in time, we cannot live without these programming changes. This does not meet our requirements." [Ref.16]

The process prior to 2001 was sequential and well understood. After the end game, the POM was locked and budget control numbers were developed by FMB and issued to BSOs. The 2002 PPBS cycle that developed the POM for FY-04 and budgets for FY-04 and FY-05 became a pooled process as the budget was developed and the program was revised concurrently.

3. Budgeting

Throughout its budget year, the CPF budget department is coordinating three budgets, the Department of Navy (DON, OSD, and PRESBUD as well as assisting with the execution of the current year's budget. The process will be described by developing a timeline starting with the POM/PR budget submission.

a. Budget Guidance

The DoN POM/PR budget process at CPF begins with receipt of the Budget Guidance Memorandum (BGM), serial 1 from FMB. BGM serial 1 outlines the budget calendar, required budget exhibit submissions, and pricing factors

for inflation and foreign currency exchange rates. CPF uses FMB's guidance as a foundation for preparing their guidance to their activities, adding any claimancy specific guidance. As FMB issues further serials to its budget guidance, CPF will also update their guidance as necessary if the updates affect their activities. For example, CPF Budget Guidance 02-01A (first update) provided updated inflation rates for activities to apply in the submission of their budget exhibits.

b. Budget Preparation

As the BSO for its claimancy, CPF receives control numbers from FMB based on the T-POM (2001 and subsequent), and develops and distributes control numbers for its activities (regions, TYCOMs, numbered Fleets), that the activities use to build their portions of the overall CPF BES.

CPF develops controls based on T-POM (program controls developed by FMB) and in coordination with their in-house requirements AOs, program managers, and activity level budget and programmer inputs. Controls are based on budget models for certain major programs such as Surface Ship Operations and the Flying Hour Program (FHP), and on historical data and obligation rates for other major programs such as Base Operating Support (BOS) and are also adjusted for pricing and known new requirement changes.

Additionally, CNO goals are established for funding Ship Operations, FHP, Ship Maintenance and Base Operations as a percentage of the 100% valid requirement identified in the programming phase. Funding for large portions of FHP and Ship Operations are "fenced" and CPF

must solicit FMB approval before attempting to modify funding levels for those programs. Other items such as civilian personnel (CIVPERS) and utilities (within BOS), although not fenced are not discretionary and must be funded at 100% of requirement. CPF must determine funding levels for those programs that are discretionary and are neither fenced and funded at percentages of their 100% requirement nor require 100% funding. The Sustainment, Restoration, and Maintenance account is an example of a discretionary account.

c. Budget Review

CPF budget analysts review budget exhibits provided by activities with their programmers and requirements staff as necessary to ensure that activities are preparing budgets based on valid requirements. Although analysts are intimately familiar with their programs, the program managers and AO's have been working directly with their Fleet counterparts and have developed points of contact throughout the Fleet during the planning and programming phases of the POM or PR for which the budget is being developed. As activities submit budget exhibits, analysts pay particular attention to items that show a marked increase or "spike" over previous years' funding levels. They also ensure that exhibits are fully justified by requirements developed throughout the planning phase and that exhibits are detailed enough to support the resources requested. [Ref.11] When spikes occur or the exhibits are not detailed enough, analysts examine circumstances which may have led to the spike in order to determine if the increase is justified or request more detail from activities.

Once fleet inputs are received, analyzed, and revised based on analyst review, CPF combines the inputs and builds its budget submission in late May. Budget submissions will balance to controls given by FMB and are submitted using pricing, factors, exchange rates, and exhibits required by the budget guidance. Once submitted, the request undergoes the concurrent program/budget review and issue/comment process.

d. Issue/Comment Phase

In June FMB analysts review the budget submissions and generate issue papers. Issue papers are posted to the NHBS website and BSO's are notified by FMB that there is an issue that affects them that requires comment. CPF may either comment on the issue in an attempt to restore funding, concur with the issue, or simply choose not to comment on the issue. If CPF does not comment, the issue is resolved as FMB chooses. If comments are generated in an attempt to restore or justify resources, the issue and comments will undergo FMB analyst, department head and division director reviews. Issues that remain unresolved at lower levels are addressed at PBCG reviews that take place in July and August for major program/budget issues. Prior to 2001, this was the "mark/reclamma" phase of the DoN budget review. As DoN review is in progress and issues are resolved, CPF updates its budget exhibits for submission to OSD. The OSD budget submission incorporates any program and budget issues that affected CPF funding and programs during the DoN review.

e. Budget Sweep-Up and Certified Obligations

From the end of August thru October, CPF budget analysts work in conjunction with the execution department

to help conduct the "end of year sweep-up" of funds and to certify the obligations against the execution budget. The end of year sweep-up is the process of obligating execution year funds before the end of the fiscal year on September 30th. Analysts coordinate with both CPF execution analysts and reporting activities to ensure that either 1) an activity can execute the remainder of its operating budget prior to the end of the fiscal year, 2) an activity will not run out of operating funds prior to the end of the fiscal year, or 3) have excess operating funds at the end of the fiscal year. If an activity has funds at year end that cannot be executed, the funds will be transferred to other activities who are in danger of running out of operating funding prior to the end of the fiscal year.

Certifying obligations is the process of comparing the budget to the actual obligations that were executed during the execution year. Any variances are reported to FMB for analysis and possible adjustments to future years programs and budgets.

f. OSD Review and PBDs

In September OSD programmers and analysts review service component program and budget submissions and release PBDs which are "marks" against the DoN budget. CPF monitors the PBDs to ensure that they prepare reclamation when necessary in an attempt to restore funding. Some PBD's are simply informational and address such issues as Working Capital Rates or Foreign Currency Adjustments. Although changes in these rates may negatively affect CPF funding levels they are "fact of life" adjustments that must be incorporated into their budget. The PBD process lasts until late November to early December. At the same

time, DoD receives undistributed congressional marks that act the same way as a DoN issue or mark based on pricing issues, specific increase and general provisions in the language. If Congress eliminates or realigns funding however, CPF has no right of reclamation but must absorb the loss of funding. [Ref.16]

g. PRESBUD and Mid-Year Review

In December, after PBD's have been adjudicated, CPF is issued new control numbers to be used in developing their PRESBUD submission. After OSD and OMB review of the component service budget submissions is finalized, the President submits his budget to Congress on the first Monday of February. Over the next nine months, the PRESBUD will be closely scrutinized and serve as the basis for the Congressional Authorization and Appropriations Bills.

In March, after their PRESBUD submission, CPF receives guidance for conducting its Mid-year Review of the execution year appropriation from OPNAV N82. Mid-year Review guidance provides specific guidance to major claimants for exhibit preparation and other submissions such as current unfunded requirements. The guidance also highlights the scarcity of funds available to solve problems identified at mid-year review and directs claimants to "craft their submissions of unfunded requirements to reflect only those that are most critical to mission accomplishment." [Ref.24]

When the mid-year review is complete, the budget cycle begins again for the next POM/PR year. Figure 12 depicts the budget year at CPF. As the figure shows, the process is a continuous cycle that is either preparing,

adjusting, or executing budgets for the current year, the budget year, or the program year.

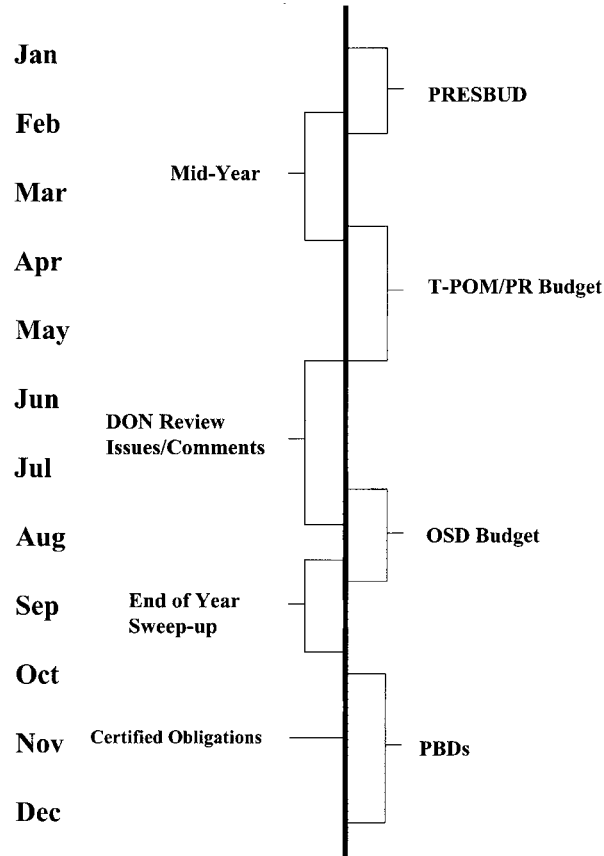

Figure 12. CPF Budget Year.

E. CHAPTER SUMMARY

PPBS is an extremely complex process that occurs over a long timeframe. It takes three years from CPF's first interaction with the planning process during IWARS to plan, program and execute that budget. As a navy BSO, CPF participates in every phase of the process and coordinates with subordinate activities, in-house planners, programmers, budget analysts, and navy and OSD planning, programming, and budgeting activities to ensure the goals

of the PPBS process are met; to provide the best mix of forces, equipment, and support activities available within fiscal constraints in its AOR. Chapter IV will address specific issues in the budgeting process at CPF.

IV. ROUTINE AND EMERGENT BUDGET ISSUES AT COMPACFLT

A. INTRODUCTION

PPBS is the process that the DoD has used to plan, program, prepare, and execute budgets for 40 years. However, from time to time the process has undergone change. The year 2002 was particularly turbulent for PPBS. SECDEF Rumsfeld issued a memorandum in 2001 that directed a concurrent program/budget process. Recently, Baseline Assessment Memoranda (BAMs) were replaced by Capability Plans (CPs). There are also routine budget issues that occur from year to year and emergent or "pop-up" issues that occur throughout the budget year. This chapter will discuss some of the major routine and emergent issues at CPF and then discuss the concurrent program/budget process as seen by personnel at CPF. This portion of the thesis was developed based on discussions and interviews with CPF planning, programming, and budgeting personnel.

B. ROUTINE ISSUES

1. The Process

The PPBS process is a cyclical process with different elements taking place throughout each year. Even though changes were made to the process during 2001 and 2002, inputs although extremely intricate, are still reiterative in nature from year to year and unless major changes occur, as in 2001 and 2002, do not change significantly. Even with changes occurring, in many ways planners, programmers and budgeters are on "auto-pilot" and simply wait for guidance from Washington, DC to provide specific guidance and deadlines for required inputs.

During any given year, the Navy issues guidance that affects every phase of the PPBS cycle. During the planning phase, OPNAV N81 issues a call for IWARs focus areas based on theater concerns, CNO guidance, and previous IWARs and develops specific IWARs to be analyzed. During the programming phase, the Navy issues BAM or CP guidance for developing baseline program requirements that will be used to build the Navy's program. The budgeting phase of PPBS begins with the FMB's budget guidance and is adjusted based on follow-on serials.

The Navy issues guidance for virtually every stage of the PPBS process. However, due to the reiterative nature of the process and the tendency of participants to anticipate what will be needed, much of the work addressed in the guidance has either been done prior to guidance being issued and received or the work is in-process. [Ref.23] It happens that the planning, programming and budget input requirements simply do not change dramatically enough from year to year to wait for guidance to be issued. Even in 2002, with the change from BAMs to CPs, CPF programmers were already engaged in developing the data required to provide the assessment sponsors with CPF program guidance. [Ref.23]

This was a common theme throughout discussions with CPF planning, programming and budgeting staff. According to the CPF Assistant Fleet Programmer, "This is typical, you get the directive after most of the work (BAM/CP submission) has been done." [Ref.23]. In fact, for the PR-05 assessment, CPF had not received final BAM guidance as

of late October and when guidance arrived, it directed and provided guidance on the preparation of CPs and not BAMs.

The views expressed by the CPF Assistant Fleet Programmer were reinforced by both the CPF IWARS Coordinator [N80] and Budget Department Head (N00F1). Referencing the IWAR data call, CPF N80 stated:

It's standard, so we start generating information prior to the data call. It's semi auto-pilot. [Ref.21]

Referencing FMB budget guidance, CPF N00F1 stated:

You don't wait for it, you're getting prepared. [Ref.16]

N00F1 went on to state:

And we know how they've (the regions and TYCOMs) spent their money in the last few years. They're not going to make any major changes unless a region goes totally Base Operating Support (BOS) contracted or something. Other than that, we know where they're going to spend their money. We could do their budget for them. [Ref.16]

2. Readiness Versus Support Accounts

In its O&MN budget, CPF supports both readiness programs and support programs. Readiness accounts are those accounts that actually support the war-fighters when conducting IDTC training and deployed operations in support of PACOM operations and include the Flying Hour Program, Ship Operations, and Ship Maintenance. Support programs such as Base Operating Support (BOS) provide resources for regions to fund base operations, and support for operating units. BOS consists of:

...funding for shore activities that support ship, aviation, combat operations and weapons

support forces. Base support includes port and airfield operations; operation of utility systems; public work services; base administration; supply operations; and base services such as transportation; environmental and hazardous waste management; security; personnel support functions; bachelor quarters operations; morale welfare and recreation operations; and disability compensation. [Ref.25]

While navy programming develops requirements and resource allocations for both types of programs based on 100% valid Fleet requirements, a major portion of program funding for readiness accounts is protected by Congressionally imposed restrictions. Money cannot be removed from them in excess of \$15,000,000 (navy-wide) without Congressional approval. Consequently, it may be said that these accounts are not discretionary. Major readiness accounts at CPF include the Flying Hour Program and Ship Operations accounts. In addition, the CNO provides goals for the percentage of the valid Fleet requirement to be funded for these accounts. For the FY-03 budget goals for programs within the FHP ranged from 89% for TACAIR to 92% for Fleet Readiness Squadrons. These goals were met in the FY03 FHP budget. [Ref.26:p.2-12] For FY-03, CPF execution controls equaled 94.1% of requirement for the FHP and 95.2% of requirement for Surface Ship Operations.

These accounts are developed using metrics that are based on operating characteristics of the various platforms within them. As an example, OPNAV N78, develops the Operational Plan 20, (OP-20) which is the primary FHP budget exhibit. To develop the exhibit, N78 works closely

with major claimants such as CPF and coordinates with the TYCOM, Commander Naval Air Forces Pacific (CNAP). [Ref.26]

CNAP assists in developing the OP-20 by providing FHP cost inputs to N78 via its Flying Hour Cost Reports (FHCRs) that consolidate FHP costs provided by squadrons and air stations on a monthly basis throughout the year via their Budget OPTAR Report (BOR). Factors reported in the BOR include the number of and type, model, series (T/M/S) aircraft assigned, funding obligation totals, flight hours flown for the month, and the total gallons and type of fuel consumed for the month and fiscal year to date. TYCOM data are input by N78 into its Flying Hour Projection System (FHPS) that relates annual budgeted flying hours to forecasted flying hour costs. [Ref.27] Based on readiness, training, operational capability requirements, available resources, and programming guidance requirements, CNAP distributes FHP funding among the various T/M/S commanders. However, a portion of the moneys within the FHP is not fenced. This account, Flying Hours Other (FO) provides funding for temporary duty, training under instruction, support equipment, etc. It is developed by averaging the previous three years budgets and is not based on metrics as are other FHP accounts. [Ref.16] Essentially, it is a support account within the FHP.

As with FO, many support programs such as BOS have no model for building major portions of their budget submissions, but rely on previous budget funding and execution levels. [Ref.16] Because they are no Congressional restrictions and because they are not directly supporting readiness (buying fuel, spent on

maintenance of aircraft, etc), and have no established CNO funding levels, these accounts are inherently under-funded and become "bill-payers" for emergent unfunded requirements. [Ref.16] Senior navy leadership is aware of this issue. Two IWARS focus areas addressed BOS funding for 2002, Shore Infrastructure Recapitalization and BOS Readiness Metrics Review. [Ref.28] FO also becomes a bill-payer account, because even though it is a part of the total FHP, it is outside the Congressional fence. Fleet comptrollers tend to see these accounts as "free-money" for meeting emergent funding issues during budget execution. [Ref.29]

The bill-payer issue is a matter of concern throughout the Fleet. While BOS is a major bill-payer, CNAP is concerned about funding being re-programmed from FO by CPF to support emergent requirements. [Ref.27] As an example, when the Navy started to convert to the common access card (new ID card) FMB funded the conversion entirely from BOS. CPF was concerned that this would have too big of an impact on BOS and "taxed" accounts across the board to fund the conversion. FO, as a discretionary account within the FHP paid its fair-share of the tax. [Ref.30] These taxes leave the TYCOM, and every other activity that was taxed with some other unfunded needs within their budgets.

The Assistant Fleet Programmer, the Head of Fleet Budgeting, the BOS Budget Analyst, and the Aviation Budget Analyst all identified the facilities Sustainment, Restoration, and Maintenance (SRM) account as a prime bill-payer. These comments are supported by CPF execution control levels for FY-03 and mid-year review requests and

and subsequent supplemental funding for FY-02. Compared to the FHP and Ship Ops funding levels of 94.1% and 94.2% of requirement respectively, SRM was only funded at 54.8% of CPF's requirement [Ref.1]. Figure 13 displays CPF's FY-03 execution controls for certain readiness and support accounts, Figure 14 shows CPF's mid-year review priorities and request for supplemental funding for FY-02 and Figure 15 is CPF's actual supplemental funding received for FY-02.

There is a discrepancy between CPF's priorities and the supplemental funding received. CPF priorities listed BOS and SRM, which was funded at a fraction of requirement for FY-03, as part of their first priority and as their overall second and third priorities. However, CPF received no additional funding for these bill payer programs except to fund additional force protection requirements within the regions brought about as a result of the September 11, 2001 terrorist attacks.



FY03 Execution Controls



	FY03 Control	FY03 Requirement	FY03 Shortfall	Percent <u>Funded</u>
Air Ops	2,119	2,252	-133	94.1%
Ship Ops	1,231	1,292	-61	95.3%
OBOS	1,144	1,281	-137	89.1%
SRM	556	1,015	-459	54.8%

Figure 13. CPF Execution Controls for Selected Accounts. [Ref.1]



Mid Year Review Submission to FMB



PRIORITIZED LIST OF CRITICAL UNFUNDED REQUIREMENTS		
O&MN Priority #	Issue Title	Unfunded Amount (\$000)
1	Cost of War	307,238
	Force Protection	11,759
	SRM Program	6,665
	BOS Program	10,600
	Ship Maintenance	214,237
	Ship Operations	53,000
	Combat Support	10,977
2	SRM Baseline Program	55,000
3	BOS Baseline Program	13,371
4	Ship Maintenance Baseline Program	44,348
5	Combat Support Baseline Program	1,064
6	PREPO	4,954
TOTAL		425,975

Reassessing shortfalls in view of DERF received and the Spring Supplemental... special focus on FP and BOS/SRM cost of war requirements

Figure 14. CPF FY-02 Prioritized Mid Year Review Submission. [Ref.1]



DERF & Supplemental Funding



Categories	DERF Funds	Supplemental
Enhanced Force Protection	36	-
Anti-Terrorism (AT)/Force Protection (FP) Task Force Findings	14	-
Fund Base Operations for AT/FP/Force Protection Modernization	22	-
Increased Worldwide Posture	327	250
Increase in Flying Hours	17	143
Increase in Steaming Days	108	48
Combat Support Force Operations	24	3
Communications	5	2
Ship and AC Maintenance	173	54
Initial Crisis Response	7	-
1. NCW	7	-
Total	370	250

Figure 15. CPF DERF and Supplemental Funding for FY-02. [Ref.1]

While these accounts may be safely underfunded in the short run, in the long run inadequate funding will lead to deteriorating infrastructure such as runways, hangars, piers that support operations and may eventually have a negative impact on overall Fleet readiness and result in increased costs to upgrade more severely degraded facilities.

3. Recent Changes

Prior to discussing the change to a concurrent program/budget process and the reactions of CPF personnel to it, it is worthwhile to develop three types of interdependence between tasks. According to Nadler and Tushman, they are:

- Pooled Interdependence
- Sequential Interdependence
- Reciprocal Interdependence [Ref.31]

Pooled interdependence is when separate units (or tasks) operate independently but are part of the same organization and share certain scarce resources. An example is a bank with several branches. Individual branches function independent of each other but share certain resources of the main corporate entity such as advertising or marketing resources. The branch banks do not depend on each other for their functioning.

Sequential interdependence is when a unit or task downstream of another depends on the prior unit's or task's output or completion. In sequential interdependence, units or task functions must deal with a greater degree of coordination than pooled units or task functions. The functioning of one unit or task can be affected by upstream units or tasks. Coordination must exist to ensure that

work flows remain constant. An example of sequential interdependence would be an oil company. First, oil must be extracted from the ground, then it must be refined into different products, then it is shipped to customers. One task cannot be completed prior to the previous task's completion and coordination between tasks must exist to ensure that work flows remain constant.

In reciprocal interdependence, work groups must work with other units in the production of common product. Reciprocal interdependence imposes substantial problem solving requirements between units; no one unit can accomplish its task without the active contribution of each other unit. [Ref.31]

As tasks become more interdependent the amount of coordination and communication between tasks increases. Reciprocal interdependence represents the highest degree of interdependence and therefore the highest degree of required communication and coordination between units.

Secretary Rumsfeld appears to have recognized the need for programmers and budgeters to coordinate more closely in the development of a program that is truly executable in the budget when he directed a concurrent program/budget process.

The decision to change the process makes sense based on the amount of task interdependence between the programming and budgeting functions. Prior to the change, the system was structured as if there was a relatively low amount of task interdependence between programming and budgeting and that the interdependence was sequential in nature where each successive process (programming and

budgeting) was dependent on the one prior to it for outputs, but that once those outputs were received, downstream tasks would not affect the output. The change to the concurrent program/budget process recognized that in reality there was a large degree of task interdependence between the two functions and that the interdependence was reciprocal in nature. Actions taken during the budgeting phase of PPBS could have significant impacts on the upstream process, programming. Personnel at CPF also seem to recognize the reciprocal nature of the planning and budgeting process.

According to the Deputy Commander (and former FMB-1, Director of the Operations Division), the reasons behind changing the PPBS process to a concurrent program/budget review include:

Eliminates wasteful duplications:

It eliminates unnecessary duplication of effort. Prior to the change, the POM would be finished in May. Then, budgets would be prepared for OSD review. Emerging issues could cause services to change the program while developing the budget. [Ref.18]

Extends the time to build the POM:

Gives the services longer to finish the POM while incorporating emergent budget issues. Services can re-visit the program based on budget issues. [Ref.18]

Increases communication and cooperation between programmers and budgeters:

Prior to the change, OPNAV N80 would finish the program and then it was "out of their hands." The new process leads to more cooperation between programmers and budgeters. [Ref.18]

Gives claimants more inputs to the program:

I think it (the new process) gives claimants more input into the program. Take Information technology (IT); if many claimants have issues with funding, it can become a major issue. Now you can revisit the POM; before you couldn't. Claimants can also say they can't execute the program as funded by controls. [Ref.18]

The Deputy's comments were reinforced by the head of the budget department and the comptroller. Both agreed that the change was incorporated to provide more coordination between programmers and budgeters. According to the CPF Comptroller:

Secretary Rumsfeld has been talking about transformation and new ways of doing things. He's saying we can't continue to think of things the way we always have. To me, this is transformation applied to resource allocation, programming, budgeting, and requirements determination. They're (OSD) looking to streamline things and make them more efficient, to eliminate redundancies, and to ask questions just once instead of over two different processes. [Ref.32]

The CPF comptroller also stated that:

When you have a concurrent process, you're forced to work together. [Ref.32]

The budget department head echoed these comments:

I think the intent was to streamline the process so that there's not so much flux. Before, once the program locked, you had to wait a whole cycle or try to fix the program in the budget. What we're trying to do instead of trying to fix it (the program) in the budget is to make the program executable in the programming stage and only have to concern ourselves with pricing and pop-up issues in the budget. There intent was to

streamline the process so there also were not as many required exhibits. [Ref.16]

While there was agreement among CPF staff on the reasoning behind the change to a concurrent program/budget process, there was some disagreement about the new process. There was very little direction given as to how the process would be implemented. The only guidance given initially was the one page memo from SECDEF. Figure 16 is the memo from Secretary Rumsfeld.



THE SECRETARY OF DEFENSE
 1000 DEFENSE PENTAGON
 WASHINGTON, DC 20301-1000

AUG - 2 2001

MEMORANDUM FOR SECRETARIES OF THE MILITARY DEPARTMENTS
 CHAIRMAN OF THE JOINT CHIEFS OF STAFF
 UNDER SECRETARIES OF DEFENSE
 DIRECTOR, DEFENSE RESEARCH AND ENGINEERING
 ASSISTANT SECRETARIES OF DEFENSE
 GENERAL COUNSEL OF THE DEPARTMENT OF DEFENSE
 INSPECTOR GENERAL OF THE DEPARTMENT OF DEFENSE
 DIRECTOR, OPERATIONAL TEST AND EVALUATION
 COMMANDER IN CHIEF, U.S. SPECIAL OPERATIONS COMMAND
 COMMANDER IN CHIEF, U.S. TRANSPORTATION COMMAND
 ASSISTANTS TO THE SECRETARY OF DEFENSE
 DIRECTOR, ADMINISTRATION AND MANAGEMENT
 DIRECTORS OF THE DEFENSE AGENCIES
 DIRECTORS OF THE DOD FIELD ACTIVITIES

SUBJECT: Concurrent Defense Program and Budget Review

This memorandum is to assist you in planning for submission of the FY 2003 budget and FY 2003-2007 program. This year, and in the future, we will conduct a concurrent program and budget review. The review this year will consider all program and budget issues and be the primary venue for resolving any programmatic or budget issues arising from the Quadrennial Defense Review. It will be used to verify that programs proposed by Components can be executed within established fiscal guidance and focus on issues that arise during execution and from other fact-of-life changes. Issues previously resolved by the Secretary or Deputy Secretary of Defense will not be revisited.

Your submissions for the concurrent review will be due October 1, 2001. We are currently in the process of developing overall guidance for the review, to include which specific exhibits will be required. All additional information will be provided to you by the Under Secretary of Defense (Comptroller) as soon as the details are completed.



U12800 /01

Figure 16. Memo from Secretary Rumsfeld Directing Concurrent Program/Budget.

The CPF Comptroller understood that change (especially to a process such as PPBS which has been conducted in much the same way for many years) caused anxiety among personnel within the CPF programming and budgeting organization, he "did not want to be too quick to jump to conclusions" [Ref.32] regarding the new process. Comments from other staff members were not as encouraging. One analyst described the process as "chaos." As late as June 26th, 2002, after their original POM-04 budget had been submitted to FMB based on T-POM control numbers, there were questions among the CPF staff as to how the new process worked. In an e-mail to the Deputy Commander, the Comptroller stated:

Admiral, still much confusion and concern over the issue paper and program/budget review process. I have my Budget Department Head and the N8 has his N80 monitoring and posting issue papers and comments. Are the PBCG decisions final or is there a court of last appeal? [Ref.20]

In the end, CPF was able to work through the issues that faced them regarding the concurrent program/budget and submitted their DoN budget on-time based on both programming and budgeting changes that occurred as a result of issue papers and comments and reviews at the FMB, N80 and PBCG levels.

4. The Informal System

This thesis has attempted to describe the formal PPBS process, CPF's interaction with it, and certain issues that are faced on a recurring basis and in the preparation of the POM-04 program and budget. It is difficult, however, to describe the tremendously complex processes that take place day-in and day-out as a part of the informal system

between planning, programming, and budgeting personnel at CPF and between CPF and their counterparts in the activities that report to them and in Washington, DC. It is also difficult to describe the affect of the "common-sense" knowledge of issues that personnel gain from extended experience working within the process.

These relationships and issues were mentioned by CPF planners, programmers, and budgeters in virtually every interview conducted at CPF. Comments made by the BOS analyst can be used as examples of this more informal process and the common-sense knowledge gained through experience in the system:

FMB collects all the budgets. They analyze them and come back with informal questions before the issue/comment phase begins. Normally they let us know when they need an answer; hopefully enough to support the number. They're looking to mark us. [Ref.11]

We have binders of things we go back and ask (the regions). Things like where we buy things from navy working capital funds and "other contracts." We ask for specifics of what they're buying. That's such a general area that activities tend to balance their accounts in there. [Ref.11]

C. CHAPTER SUMMARY

The PPBS process has been in existence for over 40 years. Requirements, although they may change dramatically over time, do not vary much from year to year. Planning, programming, and budgeting personnel, accustomed to the reiterative nature of the process perform much of the required work on a set schedule throughout the year even though guidance from higher authority has not yet been

received. For the most part, required submissions undergo only incremental changes from year to year.

In 2001 however, OSD implemented a major change aimed at streamlining the system, reducing reiterative processes, and building a program that was executable in the budget. Even though the process changed, personnel quickly adapted to new requirements and methods for reviewing the concurrent program and budget submissions. Also, while the PPBS process is a formal process with planning, programming, and budgeting activities taking place throughout the year on a set schedule, it is also an informal process that takes place between personnel involved in the process day-in and day-out throughout the year.

THIS PAGE INTENTIONALLY LEFT BLANK

V. CONCLUSIONS AND RECOMMENDATIONS FOR FURTHER RESEARCH

A. INTRODUCTION

CPF, as one of only 24 navy BSOs, is responsible for a tremendous amount of financial resources. In FY-02 it was responsible for over 7.4 billion dollars in O&MN funding. That funding provided for forward deployed operating forces and the required support infrastructure for two numbered Fleets, six navy regions, three TYCOMs, Pacific Fleet Marine Forces, and other smaller commands that are located and operate over more than 50% of the earth's surface. Planning, programming, and budgeting resources for such a large Area of Responsibility (AOR) is a daunting task. To accomplish this task, CPF has organized its planning, programming, and budgeting functions into departments that coordinate with their counterparts on both senior staff (OPNAV) and subordinate staffs (activities) to allocate available resources as effectively as possible. This chapter discusses some conclusions reached about PPBS at the BSO level and then suggests some areas for follow-on research.

B. CONCLUSIONS

1. PPBS is a Reiterative Process

While the current SECDEF recently changed the PPBS process so that programming and budgeting are done concurrently, at the BSO level, the resource requirements, change only incrementally. CPF had to adapt and submit its FY-02 and subsequent budget estimates earlier in the year and although the mark/reclamma process changed to an issue paper/comment process, the overall process remains

relatively stable. Although inputs (exhibits, analysis, etc) are extremely complex, discussions with personnel in all three phases of the process at CPF indicated that there was a reiterative nature to the process and an incremental nature to the resource requirements and allocations from year to year.

2. Resources are Limited

Programmers and budgeters are working with a limited pool of resources and must decide how to distribute available resources among competing priorities. Based on funding levels within CPF's O&MN account, readiness related funding takes priority over support related funding. At CPF, Ship Operations and the Flying Hour Program (FHP) were both funded at over 90% of their requirements for 2003, while Sustainment, Restoration, and Maintenance for facilities was only funded to 54% of its requirements. [Ref.1]

Analysts at CPF discussed the difficulty they faced in justifying to FMB the funding of support accounts versus readiness accounts. Metrics for developing budgets within support accounts are either non-existent or inadequate to provide justification of increased funding within a resource-limited environment at the expense of readiness. The best metric available for developing the Flying Hour Other (FHO) account is currently to average the funding for the previous three years even though, in the words of the CPF budget department head, "...you're taking an average of three years that were also underfunded." [Ref.16]

3. The Process is Undergoing Transformation

Recent changes to the PPBS process from a process system designed to accommodate a sequential task flow to

one that accommodates a reciprocal task flow have increased the communication and coordination between programmers and budgeters. Prior to the change, the program was locked and the budget was built based on those numbers. However, comptrollers in many instances were faced with "...trying to fix the program in the budget" [Ref.16] and would actually change the program approved by the CNO and Secretary of the Navy while trying to make the program "executable." The concurrent process recognizes the reciprocal nature of programming and budgeting and allows the program to be changed if it is not possible to execute it given the available resources.

4. The Informal PPBS

While PPBS is a highly formalized process, the day-to-day interaction between players in the process is anything but formal. Analysts at various levels of command coordinate with each other on a daily basis, not just when a required submission is due. They develop a deep understanding of issues that affect both subordinate and senior personnel in the process and where to go to and whom to speak with as issues arise.

There are also different tactics for budgeting when resources are limited that allow analysts to attempt to maximize their resources without drawing unnecessary attention to the particular account or line number being funded or where to look for resources other analysts may be trying to hide. Tactics such as avoiding large spikes in funding, avoiding increases in accounts that were scrutinized in prior years, and burying resource requirements within accounts that are general in nature were all mentioned by analysts as tactics employed in an

attempt to maximize their portion of the available resources.

C. AREAS FOR FURTHER RESEARCH

1. Support Account Metrics and Models

During research for this thesis, I came across previous research that attempted to provide metrics to support funding for accounts that currently are not supported by a model for quantifying resource requirements, in particular Force Protection/Anti-terrorism (FP) within the Ship operations account. [Ref.33] Accounts that are viewed as support generally are not supported by such models but simply average previous years' funding and any other known requirements to provide budget requests. If these accounts are inherently underfunded, then each year, BSO's are submitting requests for resources based on an average of underfunded budgets. Developing metrics for these accounts may provide additional justification for increased funding to meet actual requirements.

2. Results of the Concurrent Program/Budget Process

A stated objective of the concurrent program/budget process is to ensure that programs are executable in the budget and that comptrollers are not adjusting the program (POM/PR) in order to make it executable. It would be an interesting analysis to examine obligations throughout fiscal years prior to the change to a concurrent system and after to determine if obligations more closely match the program and budget. There will always be emergent funding needs in response to contingency operations, but if the concurrent process is working as intended, there should be less delta from baseline after the change than before.

3. Continuing Updates to the Process

As mentioned previously, the PPBS is a reiterative process from year to year. However, the process is not completely static nor are the organizations that participate in the process. In order to continue to provide students of Financial Management with updated information and to keep this document "alive", a periodic review of recent PPBS process and CPF organizational changes should be conducted.

THIS PAGE INTENTIONALLY LEFT BLANK

LIST OF REFERENCES

1. PACFLT, N001F1, PowerPoint Presentation, *COMPACFLT Program and Budget Overview*, 17 September 2002.
2. Harrison, J. S. and St. John, C. H., *Foundations in Strategic Management*, 2nd. ed., South-Western, 2002.
3. COMPACFLT, "Mission," [http://www.cpf.navy.mil/facts/mission_aor.html], July 2001.
4. Hadley, R. T., "Military Coup: The Reform that Worked; Goldwater-Nichols Military Reform Act of 1986," *The New Republic*, Vol. 198, No. 3; p. 17, 18 January 1988.
5. United States Pacific Command, "Area of Responsibility," [<http://www.pacom.mil/pages/siteindex.htm>], October 2002.
6. Office of the Chief of Naval Operations, OPNAV Notice 5400, Subject: STANDARD NAVAL DISTRIBUTION LIST, 13 September 2002.
7. Electronic Mail Message from CDR Diane Brooks, CPF-N00F2, to the Author, Subject: Thesis, 14 November 2002.
8. Interview between LCDR Butziruis, N00F26, COMPACFLT, Makalapa, Hawaii, and the Author, 25 September 2002.
9. Office of the Secretary of the Navy, SECNAV Instruction 7000.27, Subject: COMPTROLLER ORGANIZATIONS, 08 April 2002.
10. PACFLT, N00F1, PowerPoint Presentation, *COMPACFLT Comptroller Organization Brief*, 03 October 2002.
11. Interview between Geri Shishido, N00F12, COMPACFLT, Makalapa, Hawaii, and the Author, 27 September 2002.
12. COMPACFLT, COMPACFLT Instruction 5400.3Q, Subject: COMMANDER, U.S. PACIFIC FLEET STAFF REGULATIONS, 17 July 2000.

13. OPNAV N6, "N6 PPBS Online Tutorial," [http://cno-n6.hq.navy.mil/N6E/PPBS/ppbs_process.htm] 27 October 1999.
14. Snook, J. S., *An Analysis of the Planning, Programming, and Budgeting System (PPBS) Processes of the Military Services Within the Department of Defense*, Master's Thesis, Naval Postgraduate School, Monterey, California, December 1999.
15. Office of the Secretary of Defense UNCLASSIFIED memorandum to Secretaries of the Military Departments, Subject: CONCURRENT DEFENSE PROGRAM AND BUDGET REVIEW, 02 August 2001.
16. Interview between Vicki Catton, Budget Department Head, COMPACFLT, Makalapa, Hawaii, and the Author, 25 September 2002.
17. Naval Postgraduate School, *MN-4159 PPBS Brief*, Summer Quarter, Academic Year 2002.
18. Telephone Interview between Rear Admiral Greenert, Deputy CINPACFLT, Makalapa, Hawaii, and the Author, 10 October 2002.
19. Office of the Assistant Secretary of the Navy, Financial Management and Comptroller, PowerPoint Presentation, *FY 2004/2005 DON Budget Review Process*, 04 April 2002.
20. Electronic Mail Message from the Deputy COMPACFLT to the COMPACFLT Comptroller, Subject: RE: Issue 65079, 26 June 2002.
21. Interview between Brian Overby, N80 Programming and IWARs Coordinator, COMPACFLT, Makalapa, Hawaii, and the Author, 26 September 2002.
22. OPNAV N801E Memorandum: N801E Serial 002 to Distribution List, Subject: PROGRAM REVIEW (PR-05) SUPPORT CAPABILITY PLANS (CP) (FORMERLY KNOWN AS BASELINE ASSESSMENT MEMORANDUM (BAM)) PROCEDURES, 29 October 2002.

23. Interview between LCDR Heidi Allan, N801 Programming Issues Officer, COMPACFLT, Makalapa, Hawaii, and the Author, 26 September 2002.
24. OPNAV N801E Memorandum: N801 Serial 07 to Distribution List, Subject: MID-YEAR REVIEW OF THE FY2002 O&MN APPROPRIATION, 08 March 2002.
25. Department of the Navy, Operation and Maintenance, Navy BSS4 Base Support FY 2003 Budget Estimate Submission Exhibit OP-5, http://navweb.secnav.navy.mil/pubbud/03pres/db_u.htm, 12 November 2002.
26. Office of Budget, Department of the Navy, *Highlights of the Department of the Navy FY 2003 Budget*, February 2002.
27. Philips, W. E., *Flying Hour Program Cash Management at Commander Naval Air Forces Pacific*, Master's Thesis, Naval Postgraduate School, Monterey, California, June 2001.
28. Electronic Mail Message from Brian Overby, CPF-N80, to the Author, Subject: Programming Relationships in CPF, 22 October 2002.
29. Electronic Mail Message from Erin Kern, FMB121, to the Author, 30 October 2002.
30. Interview between Randall Scott, CPF Aviation Budget Analyst Supervisor, COMPACFLT, Makalapa, Hawaii, and the Author, 27 September 2002.
31. Nadler, D. and Tushman, M., *Strategic Organization Design, Concepts, Tools, and Processes*, Scott, Foresman and Company, 1988.
32. Interview between Captain John Morris, CPF Comptroller, COMPACFLT, Makalapa, Hawaii, and the Author, 27 September 2002.
33. Anderson, Tim J., *The Impact of Increased Antiterrorism/Force Protection Requirements on Ships Operations Funding*, Master's Thesis, Naval Postgraduate School, Monterey, California, March 2002.

THIS PAGE INTENTIONALLY LEFT BLANK

INITIAL DISTRIBUTION LIST

1. Defense Technical Information Center
Ft. Belvoir, Virginia
2. Dudley Knox Library
Naval Postgraduate School
Monterey, California
3. Professor Jerry L. McCaffery
Naval Postgraduate School
Monterey, California
4. CAPT John E. Mutty (Ret)
Naval Postgraduate School
Monterey, California
5. Dr. Joseph San Miguel
Naval Postgraduate School
Monterey, California
6. CAPT John I. Morris
COMPACFLT
Pearl Harbor, Hawaii