













# Proceedings of the Linnean Society of New South Wales

Issued 9th September, 1976

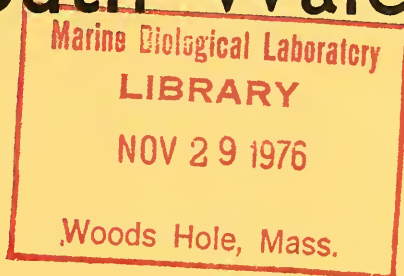

VOLUME 101  
PART I  
No. 445

# The Linnean Society of New South Wales

Founded 1874. Incorporated 1884

“ For the cultivation and study of the science of Natural History  
in all its branches ”

## OFFICERS AND COUNCIL, 1976-77

### *President*

Barbara G. Briggs, Ph.D.

### *Vice-Presidents*

H. G. Cogger, M.Sc., Ph.D. ; D. W. Edwards, B.Sc.Agr. ;  
P. J. Stanbury, Ph.D. ; T. G. Vallance, B.Sc., Ph.D.

### *Honorary Treasurer*

Joyce W. Vickery, M.B.E., D.Sc., F.L.S.

### *Secretary*

Ruth J. Inall

### *Council*

Barbara G. Briggs, Ph.D.	F. W. D. Rowe, B.Sc., Ph.D., M.I.Biol., F.L.S.
H. G. Cogger, M.Sc., Ph.D.	P. J. Stanbury, Ph.D.
D. W. Edwards, B.Sc.Agr.	N. G. Stephenson, M.Sc., Ph.D.
L. A. S. Johnson, D.Sc.	T. G. Vallance, B.Sc., Ph.D.
D. McAlpine, M.Sc., Ph.D.	Joyce W. Vickery, M.B.E., D.Sc., F.L.S.
Helene A. Martin, Ph.D.	J. T. Waterhouse, B.Sc., M.Sc. (N.S.W.), M.Sc. (R'ding), F.L.S.
Lynette A. Moffat, B.Sc., Ph.D.	B. D. Webby, M.Sc., Ph.D.
P. Myerscough, M.A., D. Phil.	A. J. T. Wright, B.Sc., Ph.D.
J. Pickard, B.Sc.Agr.	
A. Ritchie, B.Sc., Ph.D.	

### *Auditors*

W. Sinclair and Company, Chartered Accountants

*Linnean Macleay Lecturer in Microbiology, University of Sydney*

K. Y. Cho, Ph.D.

### *Librarian*

Constance B. McKay, B.A., A.L.A.A.

### *Executive Editor*

Janet Donald, B.A., Dip.Lib.

The Society's Headquarters are in Science House, 157 Gloucester Street, Sydney,  
N.S.W. 2000, Australia



## ANNUAL GENERAL MEETING

31st MARCH 1976

The one-hundred-and-first Annual General Meeting was held in the Society's Rooms, Science House, 157 Gloucester Street, Sydney, on Wednesday, 31st March 1976, at 8.00 p.m..

Mr. D. W. Edwards occupied the Chair. The minutes of the one-hundredth Annual General Meeting (26th March 1975) were read and confirmed.

### REPORT ON THE AFFAIRS OF THE SOCIETY FOR THE YEAR 1975

#### *Publications*

The Society's *Proceedings* were published on the following dates during the year :

1975 Vol. 99, Part 4	23rd April 1975
1975 Vol. 100, Part 1	1st August 1975
1975 Vol. 100, Part 2	10th November 1975
1976 Vol. 100, Part 3	6th February 1976

The cost of publishing the *Proceedings* was as follows :

	\$		\$
Blockmaking (Illustrations)	1,300.00	Subscriptions	.. 7,734.44
Printing .. .. .	7,108.60	Miscellaneous	
Postage .. .. .	1,203.29	sales .. .. .	.. 1,380.39
Cost of Reprints : Printing—	\$1,371.40 ;	Sales—	\$1,559.48

#### *Membership*

During the year 26 new members were admitted to the Society, 15 resigned and two died. The numerical strength of the Society as at 1st March 1976 was Ordinary Members 288 ; Life Members 27 ; Corresponding Members 5 ; total 320.

#### *Meetings*

Ordinary monthly meetings were held in March and April at Science House in the Linnean Society Rooms ; in July at the School of Botany, University of New South Wales ; in October at the Edgeworth David Building, University of Sydney.

A Special General Meeting was held in the Society's Rooms in March, in order to confirm acceptance of the new Rules of the Society.

#### *Library*

Requests for photocopies of reference material from Australia, New Zealand and Malaysia have maintained normal standards. The Librarian is in attendance two mornings a week ; the remaining three mornings are spent in cataloguing the collection of the Royal Society of New South Wales.

Catalogue cards have been received from the University of Sydney for all serials transferred, and all these titles have been checked for deletion of the holdings by the Society in *Scientific Serials in Australian Libraries*.

Still no catalogue cards have been received for the Society's monographs which are being held by the University of Sydney as a special collection.

Several overseas learned societies have advised that they are no longer able to maintain their exchanges, and have indicated that their publications are only available on a subscription basis. After consideration, your Council has decided not to subscribe except in a rare case where the Society has an exceedingly long run and is the only library in Australia holding the serial.

#### *Linnean Macleay Lectureship in Microbiology*

The appointment continues to be held by Dr. K. Y. Cho. Research work in 1975 was reduced considerably, since Professor Tchan took study leave and Dr. Cho was appointed the Acting Head of Department. Preliminary work was carried out on the characterisation of the cell envelope of *Pseudomonas capacia* isolated from hospitals. The lipid composition of this organism appears to differ from that of other *Pseudomonas* species. The organism is also found to be resistant to lysozyme, EDTA and a wide range of antibiotics.

A paper on the lipid metabolism of *Neisseria gonorrhoeae* was presented in the International Conference of Chemotherapy in July 1975, in London.

#### *Obituaries*

Dr. W. R. Browne } Council has resolved that obituaries for the late  
 Mr. G. P. Whitley } Dr. W. R. Browne and Mr. G. P. Whitley will be  
 Miss Gwendoline Allpress (Assistant Secretary 1920-1971). } prepared for the Society's Memorial Series.

Miss Gwendoline Lucy Allpress, who came as Assistant Secretary to the Society in May 1920, and who retired in May 1971, died in hospital at Newport on 17th February 1976, aged seventy-six years.

Miss Allpress was born at Darlinghurst on 12th December 1899, the daughter of Percy and Lilly Allpress (née Walker), and the granddaughter of George Walker, Mayor of the Borough of Paddington in 1902-3 and 1908-9. The Allpress family moved to Ithaca Road, Elizabeth Bay, opposite the then Linnean Society Hall, around 1913.

Miss Allpress attended Sydney Church of England Girls' Grammar School where she topped the class each year and was college dux in 1916. Later she was to donate her school prizes back to the library at SCEGS. She was a handsome, intelligent and vivacious girl, and in 1919 was engaged to be married, although the marriage did not take place.

Miss Allpress began working for the Linnean Society in 1920, and was to be devoted to its interests for the rest of her life.

In 1920 the Linnean Society was in its Hall at Elizabeth Bay. Miss Allpress saw two moves of premises, the first to 16 College Street in 1924 and the second to Science House in 1931. Both these moves involved much additional work, especially in library matters.

Meanwhile the family had moved to Patterson Street in Double Bay and also bought a holiday home at Newport. Not long after the move Lilly Allpress died, and the care Miss Allpress had given to her sick mother was then given to her father. As time passed he spent more time at their Newport residence, retiring there in the forties, and subsequently dying there.

It was at that time that Miss Allpress became more involved with the parish of St. Michael's, Newport, and from 1950 until her death twenty-six years later she was the Secretary of the Parish Council.

The Church and the Linnean Society had become her life and work. For the latter, over the years, Miss Allpress worked with a succession of Secretaries, Honorary Secretaries and Honorary Treasurers. To these she always gave loyal service and assistance, and her aim was unswervingly for the welfare of the Society. Much help was given to Ordinary Members of the Society, too, especially in library matters.

During the last twenty years of service her responsibilities became greater, in view of the fact that the Society had Honorary Secretaries, so that Miss Allpress often dealt with matters requiring immediate attention.

Despite substantial wealth, her tastes were simple. She spent little on possessions; the suggestion from an old friend that she buy a new dress for her Linnean Society Memorial Dinner was met with mild but characteristic disapproval. However, the silver salver given to her on that occasion by the Society was her pride and joy, and stood on her sideboard as one of her most treasured possessions.



Miss Gwendoline Lucy Allpress

Born with the proverbial silver spoon in her mouth, and inheritress of a small fortune, Miss Allpress chose to live a simple, frugal existence, so that finally a number of deserving charitable institutions would benefit from her wealth. But, wealthy or not, Miss Allpress would have been the same: she needed to give of herself unflinchingly, and this she did to the Linnean Society. As Professor J. M. Vincent said, when he was President of the Society,

“ It is Miss Allpress’s detailed knowledge of Society procedure and organization that smooths the path of its honorary officers. More than that, however, none of us who has had occasion to seek her help and advice can fail to have been impressed by her graciousness and enthusiasm for the Society’s welfare ”.

Her wholehearted devotion to the Society inspires the admiration of Officers, Council and Members. The Linnean Society of New South Wales salutes Miss Allpress and mourns her passing.

#### *Finance*

The audited accounts presented cover a period of ten months, from 1st March to 31st December 1975, and thus the figures are not strictly comparable with those presented in the previous balance sheets, which covered a period of twelve months.

As you are aware, the past ten months have witnessed a further burst of inflation, bringing ever-increasing costs of salaries, services and goods, the effects of which your Society cannot escape. In this context it is therefore a source of qualified satisfaction that the balance sheet of the General Account reveals a small deficiency of \$341 compared with the deficiencies of \$5,253, \$7,875, \$6,043 and \$3,823 revealed in the last balance sheets.

It is evident that the measures taken by your Council regarding staffing arrangements, as reported last year, have been beneficial to the finances of the Society. The Society now pays its Secretary only an honorarium for general supervision of its affairs and buys its secretarial services as required from Science House Pty. Ltd., thus obtaining an efficient service but sharing the costs of salaries, statutory holiday pay, provision for long service leave, sick leave, retirement benefits and the like with other organisations which are similarly finding it expedient to avail themselves of this service.

In the General Account balance sheet I need only comment on the sum of \$3,004 standing against Science House in 1974 and absent from the 1975 figures. That sum was held by the Science House Management Committee, together with similar sums from the other two former owner organisations, for the management of this building. In the interest of efficiency and economy of management, the former owner organisations resolved to terminate the Committee and hand over the management of this building and its lease from the Sydney Cove Redevelopment Authority to Science House Pty. Ltd. In consequence \$3,004 was repaid to the Linnean Society and, at balance date, was held in its bank account. Since balance date the same sum has been lent to Science House Pty. Ltd. specifically for the purpose of management of this building.

In the Income and Expenditure Account attention is directed to the increase in postages, reflecting the savage increase in postal charges which operated for only a part of the year and will doubtless amount to a greater sum in the current year. The costs of illustrations for printing of the *Proceedings* have again greatly increased. These are net costs after deducting the not inconsiderable donations received from some of the authors towards publication of their papers. These combined costs greatly exceeded our budget. Members have doubtless been disappointed at the small size of the *Proceedings* recently, and hopefully will appreciate and understand the reasons behind it. With the recent rise and doubtless future rises in wages, it seems inevitable that printing costs will rise still further and that a change to an alternative and cheaper method of printing will have to be adopted, as has been done by many other scientific journals. Plans are being formulated to this end. It is also noted that the combined figures for salaries and secretarial services, amounting to \$5,812 this year, demonstrate a saving of \$4,212, when compared with \$10,024 for salaries last year.

Turning to income, there has been an increase in membership subscriptions, and in subscriptions to the *Proceedings* from members and non-members. Science House reimbursements have closed because this Society no longer manages or pays the cost of management of this building. Although for only ten months, the interest received from investments is over \$1,000 more than last year, reflecting the turn over at maturity of some of our low interest yielding investments that have been recently available. The fellowships surplus income has increased for the same reason. Science House has provided our share of a small surplus this year, whereas it suffered a small deficit in the preceding year and paid nothing to the Society.

The Fellowships Account indicates that, as we did not have a Fellow last year, the whole of the salary that would otherwise have been paid had been added to accumulated funds, and the surplus transferred to the General Account. The fact that the interest received is slightly lower this year is due to the ten month period as compared with former twelve month period.

In the Bacteriology Account you will note a loan on mortgage with interest accrued of \$1,106. This is due to the death of the mortgagee and consequent delay in receiving interest payments. Our investment and the interest due on it is quite secure but we have been obliged to wait for payment.

The Society customarily sends a cheque to the University of Sydney towards the salary of the Linnean Macleay Lecturer in Microbiology twice a year. During the ten month period only the first of these, for \$700, was sent. The second was sent early in 1976 and I am glad to say that our total contribution has been maintained at the same rate as before in spite of the large amount of interest accrued but not yet received into this fund.

The Scientific Research Fund, a tax-deductible fund, has received interest of \$748 and donations of \$2,000. Its accumulated fund now stands at \$10,889.

The Library Fund, another tax-deductible fund, has received a donation of \$87,500 and now stands at \$93,366. This fund can be used to provide housing for our library and has been loaned to Science House Pty. Ltd. to provide future accommodation for the library in the new Science Centre.

#### *Science House Management Committee*

Until 1975, Science House, 157 Gloucester Street, was managed by Science House Management Committee, consisting of representatives of the Linnean Society, Royal Society and the Institution of Engineers.

On 30th January 1975, Science House Management Committee resolved to take steps to terminate its own existence and the proposal to do so was forwarded as a recommendation to the Councils of the three owner bodies, which duly approved of such action. The Board of Science House Pty. Ltd. agreed to take over the lease for Science House, Gloucester Street, and to manage the building, if and when asked to do so. This administrative change was effected during 1975 and the current lease from the Sydney Cove Redevelopment Authority covers the whole of Science House, Gloucester Street, which is owned by the Authority.

The settlement of the Science House Management Committee account was reported to the Council of the Linnean Society on 17th December 1975.

#### *Science House Pty. Ltd.*

##### *Annual General Meeting*

The second Annual General Meeting of Science House Pty. Ltd. was held on 11th September 1975, when the Directors' Report, Balance Sheet and Profit and Loss Account to 30th June 1975 were presented to the shareholders. One of the shareholders, the Linnean Society of New South Wales, was represented by its President, while the other shareholder, the Royal Society of New South Wales, was represented by Mrs. Krysko v. Tryst. The auditor, Mr. W. Sinclair, and the company solicitors, Messrs. Stephen Jaques and Stephen, represented by Mr. D. W. Howard, were present by invitation.

The names of the Directors in office at the date of the second Annual General Meeting were :

Edric Keith Chaffer	Joyce Winifred Vickery
John William Humphries	Lynette Anne Moffat
Maurice James Puttock	Esmond John Selby
William Eric Smith	Neville George Stephenson

##### *Report on Science Centre*

The principal activities of Science House Pty. Ltd. during 1975 centred around the development of a new Science Centre in Sydney as a permanent home and source of income for the Linnean Society of New South Wales and the

Royal Society of New South Wales, as owner bodies, and as a centre providing a wide range of facilities for scientific and professional organisations generally. To this end, Science House Pty. Ltd. settled the contract with F. T. Wimble & Co. Ltd. on 5th November 1974 for the purchase of a substantial building on an attractively central and accessible city site at 35-43 Clarence Street, opposite St. Phillip's Church. The building itself was suitable for the extensive remodelling needed to provide the facilities for a Science Centre.

The final plans of the Architects, Messrs. Jackson, Teece, Chesterman and Willis, were approved on 24th April 1975. Messrs. K. B. Hutcherson Pty. Ltd. were successful in tendering for the constructional work and were appointed as builders on 12th June 1975. Building operations began during the second week of August 1975 and by 20th October 1975 it was reported that demolition work had been completed and that various types of constructional work had been initiated. Since then steady progress has been made and it is anticipated that the new Centre will be ready for occupancy in June 1976.

#### *Concessions in Taxation and Rates*

Science House Pty. Ltd. has been treated by both the Commonwealth and local government authorities in the same way as non-profit making, charitable organisations. The company has been relieved from taxation on its investments and profits; it has been exempted from land rates and council rates. In general, the position of the company is at least comparable to that pertaining to the Linnean Society of New South Wales and the Royal Society of New South Wales.

#### *Staffing*

For most of 1975 the number of full-time permanent staff employed by Science House Pty. Ltd. was two. A junior typist was added on 7th October 1975. Scientific and professional organisations have continued to make requests for secretarial, editorial and other services, and it is envisaged that further additions to the staff will be made during 1976. One of the bases on which requests for services are met is that salaries for additional staff should be met from income derived from providing these services and that in no way is the company out of pocket through providing these services.

#### *Fund-raising Committee*

Substantial donations of \$75,000 and \$100,000 from Messrs. F. T. Wimble and of \$10,000 from the N.S.W. State Government have already been received towards the cost of the new Science Centre. Science House Pty. Ltd. is most grateful for these donations but they fall short of balancing the increased costs of the project caused by inflation. It is therefore the intention of Science House Pty. Ltd. to launch an appeal for funds at a stage when the new Centre is near completion and when its important role in the community can be more readily explained to prospective donors. During 1975, steps were taken by the company to establish a Fund-raising Committee and Mr. John Studdy, one of our financial advisers, agreed to act as Chairman of this Committee. Science House Pty. Ltd. has authorised the Fund-raising Committee to act on its behalf in seeking and receiving donations towards the new Science Centre.

#### *Annual Elections*

The Secretary announced the election results and declared the following elections for the ensuing year to be duly made:

*President* : Dr. B. Briggs.

*Members of Council* : Dr. P. J. Myerscough, Dr. F. W. Rowe, Dr. P. J. Stanbury, Dr. J. W. Vickery, Mr. J. T. Waterhouse, Professor B. D. Webby.

*Auditor* : W. Sinclair & Co.

LINNEAN SOCIETY OF NEW SOUTH WALES

GENERAL ACCOUNT

Balance Sheet as at 31st December 1975

1974-5 \$		1974-5 \$	
Accumulated Funds—		Fixed Assets—	
Balance, 1st March 1975 .. .. .	507,522.13	Furniture, Fixtures and Fittings—At Cost ..	370.91
Add Profit on Debenture Redemption .. .. .	10.00	Less Depreciation written off .. .. .	113.33
	507,532.13		257.58
Less Deficiency for the Period .. .. .	340.99	Office Machines—At Cost .. .. .	984.00
Balance, 31st December 1975 .. .. .	507,191.14	Less Depreciation written off .. .. .	299.13
		Investment—At cost—	
Reserves—		Share—Science House Pty. Ltd. .. .. .	684.87
Bookbinding .. .. .	1,142.66	Total Fixed Assets .. .. .	943.45
		Investments—	
		Deposits—	
		NSW Permanent Building Society .. .. .	12,288.89
		Australian Resources Development Corp. .. .. .	36,700.00
		Commonwealth Loans—At cost .. .. .	1,000.00
		Debentures—At cost—	
		Colonial Sugar Refining Co. Ltd. .. .. .	5,000.00
		Metropolitan Water Sewerage and Drainage Board .. .. .	33,100.00
		Mutual Acceptance Ltd. .. .. .	12,750.00
		Science House—At cost .. .. .	
		(One-third Interest) .. .. .	
		Total Investments .. .. .	100,838.89
		Current Assets—	
		Loan—Science House Pty. Ltd. .. .. .	400,000.00
		Sundry Debtors .. .. .	2,440.60
		Cash on Hand .. .. .	56.02
		Cash at Bank .. .. .	4,054.84
		Total Current Assets .. .. .	406,551.46
1974-5 \$	508,665	1974-5 \$	508,665
	508,333.80		508,333.80

LINNEAN SOCIETY OF NEW SOUTH WALES

GENERAL ACCOUNT

Income and Expenditure Account for the Ten Months ended 31st December 1975

EXPENDITURE		INCOME	
1974-5	\$	1974-5	\$
425	Audit Fees .. .. .		
869	Cleaning .. .. .	478	Subscriptions—Members' .. .. .
112	Depreciation .. .. .	5,280	Proceedings .. .. .
776	General Expenses .. .. .		
752	Illustrations .. .. .	5,758	Science House Management Reimbursement .. .. .
99	Insurance .. .. .	1,243	Interest Received .. .. .
115	Library .. .. .	6,721	Fellowships Account—Surplus Income for the period ended 31st December 1975 .. .. .
250	Life Assurance Premium .. .. .	4,654	Rents Received .. .. .
119	Light and Power .. .. .	29	Reprints Sales .. .. .
864	Postages .. .. .	356	Sales .. .. .
4,145	Proceedings—Printing Costs .. .. .	2,267	Science House—Share of Surplus .. .. .
714	Printing and Stationery .. .. .		
70	Referees' Fees .. .. .	21,028	Total Income .. .. .
288	Repairs and Maintenance .. .. .	3,824	Deficiency for Year Transferred to Accumulated Funds .. .. .
556	Salaries .. .. .		
10,024	Science House Rent .. .. .		
4,449	Secretarial Services .. .. .		
225	Telephone .. .. .		
	Total Expenditure .. .. .	\$24,852	\$24,700.29

AUDITORS' REPORT

We have audited the books and records of the Linnean Society of New South Wales for the ten months ended 31st December 1975 and are of the opinion that the above Balance Sheet and accompanying Income and Expenditure Account correctly set forth the position of the financial affairs as at 31st December 1975, according to the explanations given to us and as disclosed by the books of the Society.

W. SINCLAIR & Co.,  
Chartered Accountants  
Registered under the Public Accountants Registration Act 1945,  
as amended

DATED at Sydney this seventeenth day of February 1976

February 1976

JOYCE W. VICKERY,  
Hon. Treasurer.



**LINNEAN SOCIETY OF NEW SOUTH WALES**  
**LINNEAN MACLEAY FELLOWSHIPS ACCOUNT**  
**Balance Sheet as at 31st December 1975**

<p>1974-5 \$</p> <p>Accumulated Funds— Balance, 1st March, 1975 Amount Bequeathed by Sir William Macleay .. .. . 70,000.00 Transfers from Income Account .. .. . 56,806.36 Increase in Value of Assets .. .. . 272.02 <u>127,078.38</u></p> <p>Add Transfer from Income and Expenditure Account .. .. . 2,686.67 <u>129,745.05</u></p> <p>Balance, 31st December 1975 .. .. . 129,745.05</p> <hr/> <p>\$127,078</p> <hr/>	<p style="text-align: right;">\$</p> <p>Fixed Assets— Commonwealth Loans—At Cost .. .. . 52,200.00 Deposits—At Cost— British Petroleum Company of Australia Ltd. .. .. . 200.00 Electricity Commission of New South Wales .. .. . 1,000.00 F. N. C. B. and Watsons Corporation Limited .. .. . 1,262.90 Metropolitan Water, Sewerage and Drainage Board .. .. . 34,700.00 Mittal Acceptance Limited .. .. . 13,250.00 Federal Bank of New South Wales .. .. . 1,800.00 Loans on Mortgage .. .. . 11,000.00 Deposits— Australian Resources Development Bank .. .. . 8,300.00 Permanent of Australia Building Society Ltd. .. .. . 3,480.09 <u>127,192.99</u></p> <p>Total Investments .. .. . 127,192.99</p> <p>Current Assets— Cash at Bank .. .. . 2,552.06 <u>\$129,745.05</u></p>
---	--

**Income and Expenditure Account for the Ten Months ended 31st December 1975**

<p>1974-5 \$</p> <p>1,867 Salary of Linnean Macleay Fellow .. .. . 1,383 Transfer to Capital Account .. .. . 4,654 Surplus for the year transferred to General Account .. .. . <u>\$7,854</u></p>	<p style="text-align: right;">\$</p> <p>1974-5 7,854 Interest Received .. .. . <u>\$7,854</u></p> <p style="text-align: right;">\$7,632.96</p>
---	--

**AUDITORS' REPORT**

We have audited the books and records of the Linnean Society of New South Wales for the ten months ended 31st December 1975 and are of the opinion that the above Balance Sheet and accompanying Income and Expenditure Account correctly set forth the position of the financial affairs of the Linnean Macleay Fellowships Account as at 31st December 1975, according to the explanations given to us and as disclosed by the books of the Society.

W. SINGLAIR & Co.  
Chartered Accountants  
Registered under the Public Accountants Registration Act 1945,  
as amended

DATED at Sydney this seventeenth day of February 1976

JOYCE W. VICKERY,  
Hon. Treasurer.

February 1976

LINNEAN SOCIETY OF NEW SOUTH WALES

BACTERIOLOGY ACCOUNT

Balance Sheet as at 31st December 1975

	1974-5	\$	1974-5	\$
Accumulated Funds—				
Balance, 31st December 1975—				
Amount Bequeathed by Sir William				
Macleay .. .. .		24,000.00		
Transfers from Income Account Etc. . . . .		12,900.00		
		36,900.00		
Macleay Lecturer in Microbiology Reserve				
Balance, 1st March 1975 .. .. .		951.96		
Add Surplus for Year .. .. .		1,828.31		
		2,780.27		
		\$37,852		
Investments—				
Commonwealth Loans—At Cost .. .. .		26,900		26,900.00
Debentures—				
British Petroleum Company of Australia				
Ltd. .. .. .		200		200.00
Metropolitan Water, Sewerage and Drainage				
Board—At Cost .. .. .		1,800		1,800.00
Loan on Mortgage .. .. .		8,000		8,000.00
Add Interest Accrued .. .. .				1,106.85
		36,900		38,006.85
Current Assets—				
Cash at Bank .. .. .		952		1,673.42
		\$37,852		\$39,680.27

Income and Expenditure Account for the Ten Months ended 31st December 1975

	1974-5	\$	1974-5	\$
University of Sydney—Salary of Lecturer .. .. .		700.00		
Surplus for the Year .. .. .		1,828.31		
		\$2,528.31		
Interest Received .. .. .		2,540		2,528.31
		\$2,540		\$2,528.31

AUDITORS' REPORT

We have audited the books and records of the Linnean Society of New South Wales for the ten months ended 31st December 1975 and are of the opinion that the above Balance Sheet and accompanying Income and Expenditure Account correctly set forth the position of the financial affairs of the Bacteriology Account as at 31st December 1975, according to the explanations given to us and as disclosed by the books of the Society.

W. SINCLAIR & Co.  
Chartered Accountants  
Registered under the Public Accountants Registration Act 1945,  
as amended

JOYCE W. VICKERY,  
Hon. Treasurer.

February 1976

DATED at Sydney this seventeenth day of February 1976

## LINNEAN SOCIETY OF NEW SOUTH WALES

## SCIENTIFIC RESEARCH FUND ACCOUNT

## Balance Sheet as at 31st December 1975

1974-5		1974-5			
\$		\$		\$	\$
Accumulated Funds—		Investments—			
Balance, 1st March 1975 ..	8,140.73	Debitures—At Cost—			
Interest Received ..	748.27	British Petroleum Company of Australia Ltd.			1,200.00
Donations Received ..	2,000.00	Commercial and General Acceptance Limited			2,700.00
		Finance Corporation of Australia Limited			1,400.00
Balance, 31st December 1975 ..	10,889.00	F.N.C.B. and Waltons Corporation Limited			1,021.00
8,141		Industrial Acceptance Corporation Limited			1,200.00
		Mutual Acceptance Limited .. .. .		2,000.00	1,200.00
		Loans on Mortgage .. .. .			1,200.00
		<i>Add Interest Accrued .. .. .</i>			2,138.36
				138.36	
					10,889.36
		Current Assets—			
		Cash at Bank .. .. .			29.04
\$8,141	\$10,889.00				
					\$10,889.00

## AUDITORS' REPORT

We have audited the books and records of the Linnean Society of New South Wales for the ten months ended 31st December 1975 and are of the opinion that the above Balance Sheet correctly sets forth the position of the financial affairs of the Scientific Research Fund Account as at 31st December 1975, according to the explanations given to us and as disclosed by the books of the Society.

W. SINGLAIR & Co.  
Chartered Accountants

Registered under the Public Accountants Registration Act 1945,  
as amended.

DATED at Sydney this seventeenth day of February 1976.

February 1976

JOYCE W. VIGEBLY,  
Hon. Treasurer

## LINNEAN SOCIETY OF NEW SOUTH WALES

## LIBRARY FUND ACCOUNT

Balance Sheet as at 31st December 1975

1974-5			1974-5	
\$		\$	\$	
Accumulated Funds—			Current Assets—	
Balance, 1st March 1975 .. .. .	5,866.00		Loan Account—	
Donations Received .. .. .	87,500.00		Science House Pty. Ltd. . . . .	93,366.00
Balance, 31st December 1975 .. .. .	93,366.00			
				\$93,366.00
5,866				
\$5,866				

## AUDITORS' REPORT

We have audited the books and records of the Linnean Society of New South Wales for the ten months ended 31st December 1975 and are of the opinion that the above Balance Sheet correctly sets forth the position of the financial affairs of the Library Fund Account as at 31st December 1975, according to the explanations given to us and as disclosed by the books of the Society.

W. SINGLAIR &amp; Co.

Chartered Accountants

Registered under the Public Accountants Registration Act 1945,

as amended

DATED at Sydney this seventeenth day of February 1976

February 1976

JOYCE W. VICKERY,  
Hon. Treasurer.

# EARLY DEVONIAN IGNEOUS ACTIVITY AND SOME STRATIGRAPHIC CORRELATIONS IN THE TUMUT REGION, NEW SOUTH WALES

J. P. BARKAS\*

[Accepted for publication 17th December 1975]

## *Synopsis*

North of Talbingo, the Tumut River in southern New South Wales traverses a belt of folded Silurian metasediments and volcanic rocks, the latter being part of an extensive association here named the Wiradjuri Volcanics. Several bodies of sub-volcanic leucogranite (the Gocup and Bogong Granites, and the Killimicat and Lobs Hole Adamellites) postdate the rocks of this belt and exhibit clear petrographic and chemical affinities. Ignimbritic rhyolites of the Buddong and Minjary Volcanics and the Gatelee Ignimbrite are stratigraphically equivalent, spatially associated with these leucogranites, and also comprise a petrologically coherent group. New radiometric and palaeontological evidence indicates that both groups are of Early Devonian age and enables regional stratigraphy to be refined. The ignimbritic rhyolites may represent the extrusive equivalents of the leucogranites but other volcanic and plutonic rocks of post-Silurian age in the area are clearly unrelated to this magmatic episode.

## INTRODUCTION

The town of Tumut, 70 km due west of Canberra, is situated within a belt of folded rocks that comprises the southern part of what has been recently termed the Bogan Gate Synclinal Zone (Scheibner, 1974). These rocks were deposited in the southwestern portion of the Cowra Trough (Packham, 1969, p. 6). A broad two-fold division is characteristic of much of this belt: a unit dominated by porphyritic rhyodacites and pyroclastic rocks of rhyolitic to dacitic composition, with intercalated sedimentary material of varying prominence, overlies more strongly deformed rocks of diverse lithology which include shales, siltstones, phyllites, basic schists, serpentinites and minor marbles. Several granitic bodies intrude the rocks of this belt, and it is unconformably overlain in places by more gently folded supracrustal rocks of Early to Late Devonian age.

In the Tumut region, this belt appears between the Burrinjuck-Young Batholith in the east, and the Wagga Metamorphic Belt and Wondalga Granite to the west. The upper unit in this area has been named the Blowering Beds (Ashley *et al.*, 1971, after Adamson, 1960a). Less is known of the more complex lower unit—it includes at least the Bullawyarra Schist and Bumbole Creek Beds, and possibly the Honeysuckle Beds and Coolac Serpentinite. All these have been discussed by Ashley *et al.* (1971), who have also described the Bogong Granite and Killimicat Adamellite, which intrude the folded succession east of Tumut, and the Gatelee Ignimbrite, which overlies it unconformably.

Northwest of Tumut, however, previous geological investigations have been limited to broad reconnaissance studies such as that of Adamson (1960a). A granitic stock in this region is here named the Gocup Granite, the name being taken from the village of Gocup situated 1 km from its eastern boundary.

This paper describes the Gocup Granite and associated rocks, as well as occurrences of similar lithologies over a much wider area (see Fig. 1). New palaeontological, radiometric and petrological investigations have enabled part of the sequence of sedimentation, granitic intrusion and volcanic activity in the area to be dated accurately and allow a refinement of regional stratigraphy.

---

\* Department of Geology and Geophysics, University of Sydney, New South Wales, 2006.

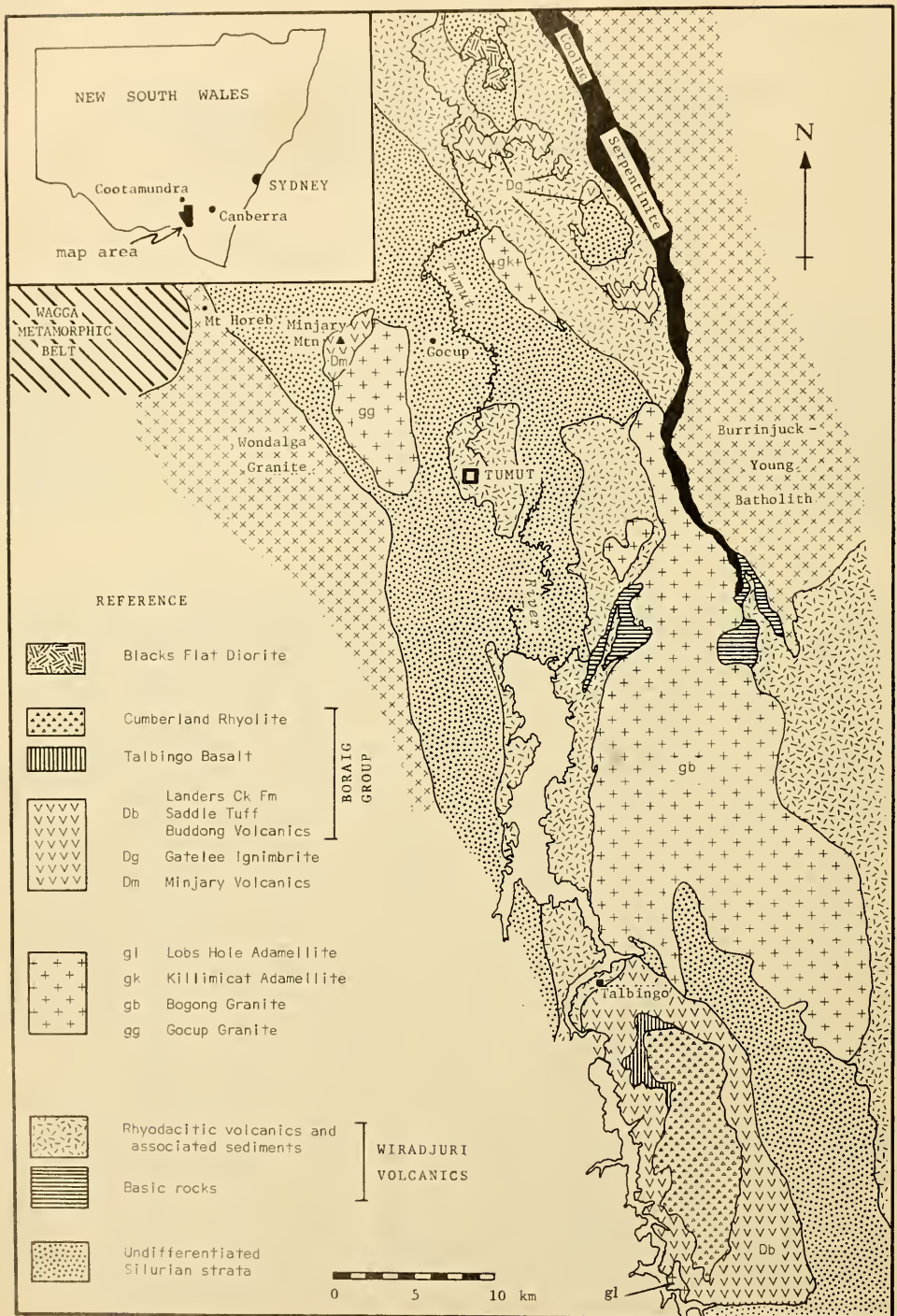

Fig. 1. Geological sketch map of the Tumut District. (Modified from Adamson and Loudon, 1966, and Ashley *et al.*, 1971). For stratigraphic relationships see Fig. 2.

## GEOLOGY NORTHWEST OF TUMUT

## METASEDIMENTS

An extensive succession of folded low-grade metamorphic rocks of unknown thickness is intruded by the Gocup Granite. In and north of Tumut, this succession is overlain by porphyritic rhyodacites and tuffs of the Blowering Beds. The metasediments consist mainly of phyllite, lithic sandstone and thinly-bedded quartz-siltstone, with subordinate conglomerate, marble, volcanic breccia and tuff. These rocks have undergone regional metamorphism only to lower greenschist facies; chlorite is extensively developed. A closely-spaced subvertical cleavage striking from 5° to 20° west of true north is widespread, and sedimentary structures are rarely observed. Deformation is most intense in the narrow septum of metasediments separating the Wondalga and Gocup Granites, where bedding is generally obliterated by two sets of overprinted cleavage, the second parallel to the axial planes of tight, locally isoclinal, mesoscopic folds in the earlier-generation cleavage. The fine-grained phyllites from this belt contain 40–60% rounded quartz grains (average diameter 0.02 mm) in a sheared matrix of finer-grained quartz, muscovite, chlorite and limonite. Relict, fractured plagioclase grains of composition around  $An_{30}$  characterise the tuffaceous material, which may have been andesitic, but is now extensively chloritised. In addition, local occurrences of actinolite schists, which become more prominent northwest of the Gocup Granite, attest to the presence of more basic rocks in the original sequence.

East of the Gocup Granite, the sediments are less deformed, though the penetrative cleavage is still characteristic. Quartz-rich siltstone with limonitic cement is the dominant rock type, with some coarser-grained lithic sandstone and greywacke. These rocks are very similar to the Bumbole Creek Beds of Ashley *et al.* (1971), a sequence of slaty shales, siliceous siltstones and lithic sandstones exposed extensively east of the Tumut River. Both units are overlain by the Blowering Beds and stratigraphic equivalence is suggested.

*Marble and Serpentinite*

Small pods of marble occur *en echelon*, trending about 20° west of north, within the belt of metasediments separating the Group and Wondalga Granites. This marble is foliated, and consists almost entirely of white, fine-grained, recrystallised calcite, with occasional cherty nodules and tale bands. Parasitic and kink folds mirror the deformation in the surrounding phyllites and siltstones. Isolated exposures of similar marble occur along strike both to the north and south. The horizon extends north-northwest to at least a point east of Mount Horeb where the rock was quarried last century (Carne and Jones, 1919, p. 350), while to the south it is exposed discontinuously over a distance of some 15 km parallel to, and east of Gilmore Creek.

Serpentinite is found in this narrow belt of country rocks at isolated localities along much the same zone as the marble described above, though the two rock types have not been observed in contact. The serpentinite is composed of reticulate masses of fine-grained serpentine minerals, with larger grains of altered pyroxene (bastite) and pale sea-green antigorite. Anthophyllite, picotite, magnetite and chlorite are present in smaller amounts. A relic igneous texture is apparent, and these rocks are considered to have had an original composition of peridotite or harzburgite. Quartz-magnetite-hematite rocks are associated with the serpentinities.

*Age*

In spite of the pronounced deformation and recrystallisation in the marble pods west of the Gocup Granite, recognisable conodont fragments were found to have survived the metamorphism. These represent the only fossils recorded

from strata below the Blowering Beds in the Tumut district. The fragments are of a form with an asymmetric platform ledge and a small basal cavity. They show affinities (T. B. H. Jenkins, pers. comm.) to the genus *Polygnathoides* Branson and Mehl, a platform-type conodont of Ludlovian age (Walliser, 1964). Link and Druce (1972) have recorded *Polygnathoides siluricus* and *P. emarginatus* from the middle Ludlovian Silverdale Formation of the Yass Basin.

The fauna recorded from the Blowering Beds northeast of Tumut (Ashley *et al.*, 1971) includes corals, brachiopods and graptolites generally indicative of a Silurian age, as well as the conodonts *Trichonodella inconstans* Walliser and *Ozarkodina cf. jacgeri* Walliser. Although this fauna may be reworked in part, it confirms a Middle to Late Silurian age, suggested on limited evidence by Adamson (1960a), for the whole country rock succession northwest of Tumut, thus placing an older limit on the time of intrusion of the Gocup Granite.

#### GOCUP GRANITE

This body is discontinuously exposed over an elliptical area of some 42 km<sup>2</sup> consisting mainly of a range of hills, in part flat-topped, that rises steeply from the east and west, but more gently from the south, to an elevation of about 400 m above the surrounding country. In the northwest, on and near Minjary Mountain, the granite is overlain by rhyolitic lavas and ignimbrites of the Minjary Volcanics. Outcrop is generally good on the steep flanks of the hills but is often poor on the upper, flat to undulating central plateau which supports natural forest vegetation.

Except near its margins, the granite is massive and unstressed: joint orientations show no regular pattern and neither mineralogical nor tectonic foliation is present. The body is largely homogeneous and composed of leucogranite with an average grainsize ranging from 2 to 7 mm. The grainsize tends to decrease at topographically higher levels, possibly indicating that the Gocup Granite has not been eroded far below its original roof.

Microscopic examination reveals that quartz and alkali feldspar (perthitic microcline and primary albite) together generally comprise at least 80% by volume of the rock, the remainder being chiefly biotite, muscovite, oligoclase (as relict phenocrysts) and tourmaline, in varying proportions. Muscovite-free varieties are rare. Zircon, apatite, sphene and fluorite are present as accessories, but always collectively total less than 0.5% of the mode. Secondary alteration of the feldspars and biotite is widespread, with the appearance of sericite, epidote, clays, chlorite and hematite. Micrographic and myrmekitic quartz-feldspar intergrowths are common, especially in the finer-grained variants.

Minor rock types within the stock probably occupy less than 5% of the total outcrop area and comprise, in the main, fine-grained aplite patches and coarse quartz-rich tourmaline-bearing pegmatite veins. The former have much the same mineralogy as the host granite and are distinguished only by a mean grainsize as fine as 0.5 mm. Quartz, pink feldspar and tourmaline are the main minerals in the pegmatites, the tourmaline occurring in radiating clusters and bladed aggregates up to 20 cm in length.

Contact effects about the Gocup Granite are limited to a narrow zone, in places less than 10 m wide, in which the country rocks are indurated and brecciated. Development of a prominent metamorphic aureole, like those adjacent to the Killimicat Adamellite and parts of the Bogong Granite, is not apparent. This may be due in part to the siliceous nature of the metasediments which would preclude the development of mineral assemblages indicative of thermal metamorphism, but structural features at the margin of the Gocup Granite indicate forceful emplacement of a massive, semi-solid body to its present crustal position by upward and lateral wedging apart of country rocks that were already strongly cleaved. In the southwest, the contact with the metasediments dips away from the granite at over 80°. In places along the eastern contact,



the granite is somewhat porphyritic and satellitic bodies of granite and porphyritic microgranite intrude the country rocks to the east, north and northwest of the main pluton; these bodies are too small to be shown on Fig. 1, having outcrop areas of only a few thousand square metres.

Chemical data for the Gocup Granite are presented in Table 1; radiometric ages for four samples have been determined by Dr. J. R. Richards (Research School of Earth Sciences, Australian National University). K-Ar data on biotites and muscovites yield a mean age of  $410 \pm 4$  m.y. and a Rb-Sr age of 408 m.y. has also been determined. The significance of these data will be discussed later.

#### MINJARY VOLCANICS

A succession of porphyritic and banded rhyolites unconformably overlies both the Silurian country rocks and the northwestern margin of the Gocup Granite, in the vicinity of Minjary Mountain. The name Minjary Volcanics is proposed for this sequence which has a maximum thickness in excess of 350 m, and may be broadly divided into two units:

- (1) a lower series of massive, porphyritic lava flows and ignimbrites;
- (2) an upper unit of fine-grained, banded rhyolite.

The porphyritic rocks of the lower part of the Minjary Volcanics are rhyolitic to rhyodacitic in composition, and purple to brown in colour. In some specimens the presence of fragmental and welded textures suggests an ignimbritic character. The rocks consist of phenocrysts of quartz, oligoclase and, to a lesser extent, sanidine, in a fine-grained groundmass, chiefly of quartz and alkali feldspar. Biotite, commonly replaced by chlorite, forms occasional glomeroporphyritic aggregates. Sphene, pyrite, zircon, apatite and monazite are present as accessories, while epidote, muscovite, calcite, zeolites and prehnite occur as secondary phases. Spherulitic and devitrified glassy textures are often present, but flow banding is rarely prominent.

Conglomeratic bands with a maximum individual thickness of about 5 m occur at various stratigraphic levels in a zone about 60 m thick near the top of the lower, porphyritic section of the Minjary Volcanics. The detritus in these poorly-sorted rocks consists of angular pebbles up to 8 cm in diameter of coarse-grained leucogranite and rounded to subangular fragments of quartz-rich rhyolite and, rarely, schist and phyllite. The matrix contains angular pink feldspar grains and quartz fragments in a purple silt that is similar in colour to much of the underlying porphyritic rhyolite. Broken tourmaline needles extracted from the matrix of this conglomerate possess optical properties identical with those of the deep indigo tourmaline of the Gocup Granite. Associated grits and arkoses contain angular to rounded grains of quartz and pink feldspar with lithic fragments, again set in a fine-grained, purple matrix. The lithology of these rocks suggests strongly that they were derived in part from the underlying Gocup Granite or a very similar body, and from the local volcanic rocks.

Southwest of Minjary Mountain, non-porphyritic, massive to banded rhyolite overlies the porphyritic volcanics and intercalated sediments. The banding, highly contorted in places, is textural rather than mineralogical and widths of individual bands range from less than 0.02 mm to more than 15 mm. Massive, non-banded rhyolites within this upper unit have a mineralogy similar to that of the banded rocks, being essentially composed of very fine-grained quartz and alkali feldspar. Much of this upper section of the Minjary Volcanics appears to represent fine ash-fall and flow material.

#### *Palaeontology*

Thinly-bedded, sparsely fossiliferous siltstones form discontinuous bands immediately above the base of the banded rhyolites, southwest of Minjary Mountain. Individual lenses have a maximum thickness of 1.5 m and are

composed of fine lithic silt, quartz and broken shelly material. The presence of "Siluro-Devonian Brachiopoda . . . from the Minjary Ranges near Tumut" was first reported by Stephens (1882). Subsequently, fossils collected from the area by Mr. G. Hayes in 1900 were identified by Dun (1901) and again by Fletcher (1961). The locality was originally listed as "Portion 41, Parish Calafat, County Buecleugh" (Dun, 1901). Almost certainly, however, the true location was Portion 241, where the fossiliferous horizons of the Minjary Volcanics examined in this study are exposed. The fauna collected by the present author in 1971 is similar but more diverse than that listed by Dun or Fletcher, and comprises the following forms:

Brachiopoda : Articulata—

- Howellella? jaqueti* (Dun)
- Meristina* sp.
- Molongia?* sp.
- Strophonella manta* Talent
- Strophodonta?* sp.
- Nadiastrophia?* sp.
- Hipparionyx?* sp.
- chonetid indet.
- Isorthis alpha* (Gill)
- Schizophoria convexa* Dun ?
- dalmanellid indet.

Coelenterata : Tabulata—

- cladoporid indet.

The tentative determinations are due to the fragmentary nature of the specimens and their generally poor state of preservation; the silty matrix obscures much of the fine detail such as micro-ornament.

The assemblage has a definite Early Devonian aspect; similar faunas characterised by *Howellella? jaqueti* have been recorded from several places in Cobar Basin and Parkes Platform deposits (cf. Packham, 1969, pp. 147–149; Strusz *et al.*, 1972, pp. 442–443 and chart). A lower to middle Siegenian age is consistent with all these occurrences; the assemblage appears unlikely to be as old as Gedinnian or as young as Emsian. A mid-Early Devonian age is indicated for the Minjary Volcanics.

#### REGIONAL CORRELATIONS

##### *Pre-Devonian Strata*

The belt of folded rocks of which the metasediments at Tumut are a part, extends north-northwest at least as far as Stockinbingal and Barmedman where it is overlain by extensive Quaternary deposits. South of Tumut, it narrows to less than 10 km in width, between the Bogong and Wondalga Granites.

Stratigraphic relations within the complex lower unit are unclear as only parts of it have been examined in detail. To the north, rocks similar to the Bullawyarra Schist have been named the Jindalee Beds by Basden (1974) who considers these units to represent strongly deformed oceanic crust. Tectonic syntheses by Scheibner (1973, 1974) propose that parts of these are as old as Cambrian and that the serpentinites associated with the Jindalee Beds, as well as the Coolac Serpentinite, represent the lower oceanic crust and upper mantle that formed the basement of the Cowra Trough. The age relationships on which this interpretation depends, however, must remain in doubt as the metasediments are all unfossiliferous. In this regard, the presence of conodont fragments in the marbles west of the Gocup Granite may be crucial, as these marbles are associated with serpentinites, quartz-magnetite rocks and basic schists similar to those of the Jindalee Beds, and the styles of deformation are comparable. Thus the

inferred Silurian age for the metasediments northwest of Tumut could have important wider tectonic implications if regional correlations can be established.

Marble occurs elsewhere in the low-grade, foliated metasediments, at localities near Gilmore, west of Brungle, and east of Gilmore Creek some 20 km south of Tumut, where it is again associated with serpentinite and quartz-iron oxide rocks (Bradley, 1968). Near the Murrumbidgee River south of Nangus, Vallance (1953) has described serpentine rock, marble and jasper-iron oxide rocks that occur in close proximity within a zone of low-grade, folded metasediments.

Regional correlations with the Blowering Beds are less tenuous. The "Blowering Porphyry" was originally described from between Tumut and Talbingo (Hall and Relph, 1956; Adamson, 1960a) where it is intruded by the Bogong Granite. Ashley *et al.* (1971) and Basden (1974) have extended the mapped area of this unit north and northeast of Tumut to beyond Cootamundra. Sedimentary material associated with the dominantly rhyodacitic extrusive rocks and pyroclastics has varying prominence over the areas examined and includes volcanic and calcareous sandstones, siltstone, mudstone, chert and conglomerate. The only known fossils are those recorded by Ashley *et al.* (1971) which indicate a Middle to Late Silurian age.

Similar rhyolitic to dacitic volcanics, with associated sediments and more basic volcanics, are common in the southern part of the Cowra Trough where they occur over extensive areas around the Burrinjuck-Young Batholith. These units include the Goobarragandra Beds (Ashley *et al.*, 1971), Douro Volcanics (Brown, 1941) as now expanded, Canowindra Porphyry (Stevens, 1952; Ryall, 1965) and Frampton Volcanics (Basden, 1974), all of which have been assigned a Middle or Late Silurian age, and at least parts of the Illunie Rhyolite (Adamson, 1960b), Wyora Porphyry (Strusz, 1971) and Peppercorn Beds (Strusz, 1971). This last unit is in need of subdivision: it includes limestones that are as old as Llandoveryan (Nicoll and Rexroad, 1974) as well as the rhyolites and dacites that are of interest here. It has been suggested (Ashley and Basden, 1973; Basden, 1974) that some of the volcanic units are closely related to the batholith they surround. Detailed chemical and mineralogical studies of these "porphyries" and the various rocks of the Burrinjuck-Young Batholith (Barkas, in prep.) point to a genetic association. It is proposed to refer to these related volcanic rocks that surround and are in part intruded by this batholith as the Wiradjuri Volcanics. This is a collective term and does not supersede the existing formation names of its constituent units. The name is taken from that of an Aboriginal tribe that inhabited a wide area centred around the Lachlan and Murrumbidgee Rivers (Tindale, 1940).

#### *Early Devonian Correlations*

Acid volcanism of Early Devonian age was not uncommon in the southern part of the Cowra Trough, where its products, like the Minjary Volcanics, rest unconformably on older strata. About 15 km northeast of the Gocup Granite, 100 m of rhyolitic ignimbrite (the Gatelee Ignimbrite) overlies the Blowering Beds and older rocks (Ashley *et al.*, 1971). Though banding is there more prominent, much of this unit exhibits a striking resemblance to the purple and brown rhyolites of the Minjary Volcanics.

Forty kilometres south-southeast of Tumut, the rhyolitic Buddong Volcanics, the lowest unit of the Lower to ?Middle Devonian Boraig Group, lies unconformably above the Silurian Ravine Beds (Moye *et al.*, 1969). The Buddong Volcanics are themselves overlain east of Ravine by beds of the Byron Range Group, the middle part of which (the Lick Hole Limestone) contains a fauna similar to that of part of the Murrumbidgee Group in the Taemas-Cavan area (Moye *et al.*, 1969, p. 145). As this fauna is now considered to be Emsian in age (Chatterton, 1973) a close time-correlation must exist between the Minjary and

Buddong Volcanics. Well-exposed sections of this latter unit in the east of the Boraig Basin and near Lobs Hole reveal a sequence strikingly analogous to the Minjary Volcanics: about 100 m of massive and banded, purple, porphyritic ignimbrites are overlain by conglomerates and grits, followed by more rhyolite. The sediments contain fragments of leucogranite, rhyolite and chert. It is envisaged that the lower part of the Minjary Volcanics, the Gatelee Ignimbrite and at least part of the Buddong Volcanics are stratigraphically as well as lithologically similar, and form an Early Devonian "rhyolite association" whose significance will be discussed later.

A similar analogy is apparent to the north. Basden (1974) notes that "rhyolitic lavas with an interbedded conglomeratic member occur to the west of Cootamundra, unconformably overlying the Frampton Volcanics". She refers to this unit as the Cootamundra Volcanics and includes shale which conformably overlies the rhyolite and contains the *Howellella? jaqueti* fossil assemblage (Sherwin, unpubl., quoted by Basden, 1974) in her definition of this unit.

East of the Indi River near the Victorian border, 175 km south of Tumut, strongly folded, low-grade metasediments and acid to intermediate volcanics of the late Middle to early Upper Silurian Cowombat Group are overlain by rhyolites and rhyodacites of the Snowy River Volcanics with a marked angular unconformity (Moye *et al.*, 1969). The presence in Victoria of Emsian strata overlying the Snowy River Volcanics restricts the age of this unit to Early Devonian, while the similarity with the Tumut region is further enhanced by the observation of Talent (1965) that granitic rocks intrude the Cowombat Group in Victoria, but are overlain by the Snowy River Volcanics.

In the southeastern part of the Cowra Trough, near Bowning and at Cooleman Plains, the rhyolitic Mountain Creek Volcanics, of Early Devonian age, again appear to occupy a similar stratigraphic and structural position to the volcanic formations described above.

#### LEUCOGRANITES OF THE TUMUT DISTRICT

Evidence suggesting the stratigraphic equivalence of the rhyolitic rocks of the Minjary Volcanics, Gatelee Ignimbrite and Buddong Volcanics has been reviewed. Examination of the leucogranitic intrusions spatially related to these volcanics reveals a similar close association.

The *Bogong Granite* (Hall and Relph, 1956) is by far the largest of these; it outcrops over an area exceeding 320 km<sup>2</sup> (see Fig. 1) and has been described in part by Ashley *et al.* (1971). A composite mass, it intrudes units of the Wiradjuri Volcanics as well as the non-volcanic Silurian sequence in the south (Ravine Beds and Cave Creek Limestone). The K-Ar age of 385 m.y. reported by Ashley *et al.* has been revised (J. R. Richards, pers. comm.) to 410 m.y. to take account of revised decay constant determinations. A deuterically altered specimen of the Bogong Granite analysed at the same time yields a revised age of 390 m.y. which can be confidently considered to be younger than the age of intrusion. These radiometric data indicate that the Bogong and Gocup Granites are of the same age.

The *Killimicat Adamellite* (Ashley *et al.*, 1971) intrudes Silurian rocks to the north of the Bogong Granite. Chemically, petrographically and in hand specimen it is almost identical to large parts of the latter, and Ashley *et al.* have suggested that it represents a "cupola-like extension" of the Bogong Granite.

The *Lobs Hole Adamellite* (Adamson, 1957) is a small granitic body with an outcrop area of less than 3 km<sup>2</sup> at the south western margin of the Boraig Basin, near the now-submerged locality of Lobs Hole, on the Tumut River. This rock is characterised by phenocrysts of alkali feldspar and oligoclase up to 15 mm long that comprise from 50 to 85% of the mode, with interstitial micrographic quartz-

feldspar intergrowths making up the bulk of the remainder. Most of the phenocrysts are clouded with alteration products; the margins of many have been resorbed, while others have albitic or micrographic overgrowths. Quartz forms occasional clear, irregular phenocrysts; biotite and subordinate hornblende jointly account for less than about 5% of the mode and are usually interstitial, but sometimes partly replace or mantle the phenocrysts.

This unusual rock appears to be genetically related to the rhyolites of the Buddong Volcanics within which it is situated. The porphyritic nature of the volcanics shows that the lavas and ash flows that formed them contained suspended phenocrysts at the time of extrusion. The textures of the Lobs Hole Adamellite suggest that it formed in a sub-volcanic chamber from a crystal-rich magmatic residue with interstitial rhyolitic liquid, that was not erupted: a multi-stage cooling history is apparent. Variations within the body appear gradational and are due to differing proportions of phenocrysts and interstitial material: some specimens (e.g. no. 9, Table 1) represent little more than a welded mass of phenocryst fragments.

Contact metamorphism around the Bogong Granite and Killimicat Adamellite is more marked in places than that adjacent to the Gocup Granite. It is common in the Lachlan Fold Belt for the degree of thermal metamorphism by the Murrumbidgee-type granites of Vallance (1969) and their associated leucogranites to be dependent on the nature of the country rocks as well as on the temperature difference across the contact. The Bogong Granite intrudes a variety of lithologies and illustrates this proposition: in psammopelitic rocks of the Bumbole Creek and Ravine Beds, for example, contact effects are generally very slight; similarly the rhyodacites of the Wiradjuri Volcanics exhibit recrystallisation and growth of secondary biotite clusters visible in hand specimen only within a few tens of metres of the contact. Elsewhere, however, the Bogong Granite intrudes the Coolac Serpentinite and associated basic rocks, and extensive high-grade hornfels are developed (Ashley *et al.*, 1971), while to the south, massive andradite-hedenbergite and andradite-magnetite skarns are present in the belt of undifferentiated Silurian rocks shown on Fig. 1. At Black Perry Mountain (8 km west of Talbingo) and elsewhere, these skarns occur up to 3 km from the exposed margin of the granite.

Basic and silicified hornfels make up the Wermatong Amphibolite of Adamson (1960a) which appears to correspond on the western margin of the Bogong Granite to some of the metamorphosed basic rocks recorded by Ashley *et al.* (1971) on the eastern side. The Wermatong Amphibolite and the basic rocks within the Goobarragandra Beds are taken to be part of the newly-defined Wiradjuri Volcanics.

#### BLACKS FLAT DIORITE

To the north of the main outcrop area of the Gatelee Ignimbrite, a diorite stock intrudes both the Bullawyarra Schist and Blowering Beds. This body was mapped in detail by Thrum (1972) who named it the Blacks Flat Diorite. It has an outcrop area of about 4 km<sup>2</sup> that is irregular in shape, but elongated north-south.

Much of the body is composed of a medium-grained diorite whose two main mineral constituents are sodic oligoclase and hornblende, the former nearly always dominant; the content of potassium feldspar is variable, ranging up to about 20% of the mode. Quartz, sphene, apatite, magnetite, allanite and zircon are almost constant accessories, while small amounts of chloritised biotite, calcite and epidote are often present as secondary phases. The hornblende is hastingsitic with  $2V_{\alpha} \cong 55^{\circ}$ ,  $Z^{\wedge}c \cong 29^{\circ}$  and marked pleochroism (X = very pale yellow-green, Y = yellow-green, Z = deep green). Its composition, determined by microprobe analysis, is

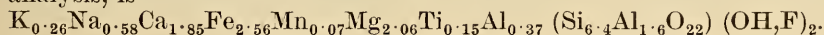

Most of this hornblende is present as subhedral, elongate grains that are sometimes clustered; intergrowths with potassium feldspar and inclusions of sphene and apatite are common. Much of the feldspar is pink in hand specimen; microscopic examination shows this to be due to a very fine clouding of most grains with alteration products. By contrast the hornblende is generally free from any signs of alteration.

Contact effects of the Blacks Flat Diorite appear limited to a partial recrystallisation and hardening of the country rocks within a zone never more than about 10 m wide. Xenoliths of partly-recrystallised country rock are common throughout the intrusion and apparent roof pendants up to 600 m across have been mapped by Thrum (1972). The mass is noticeably finer-grained and somewhat porphyritic near its southern end and, to the north and south, several satellitic and dyke-like bodies of similar dioritic rocks intrude the surrounding Bullawyarra Schist. All these features suggest that, like the Gocup Granite, this body is exposed at a level not far below its original roof.

As Thrum (1972) pointed out, the Blacks Flat Diorite intrudes part of the Blowering Beds and is thus no older than Late Silurian. On the available chemical and petrographic evidence, however, it is not genetically related to the Early Devonian intrusive rocks described elsewhere in this paper, although it does appear to occupy a somewhat analogous crustal position.

#### CHEMICAL DATA

Seventeen bulk-rock analyses of relevance to the discussion in this paper are listed in Table 1. No previous chemical data have been published on the Gocup Granite, Minjary Volcanics, Lobs Hole Adamellite or Boraig Group, but the analyses of the Bogong Granite, Killimicat Adamellite and Gatelee Ignimbrite presented here should be considered in association with those of these units tabulated by Ashley *et al.* (1971) and Ashley and Basden (1973). When this is done, a clear chemical coherence is apparent among the members of the two igneous associations (leucogranites and rhyolites) described in this paper, as is the similarity between these two groups. A detailed study of a much larger number of analyses will form the subject of a subsequent paper.

Of the Bogong Granite analyses, numbers 4 and 5 in Table 1 represent biotite leucogranites typical of the pluton as a whole, while 6 and 7 are of variants of very limited areal extent. The atypical (e.g. high  $\text{TiO}_2$ , Sr, Zr; low  $\text{SiO}_2$ , Rb) and variable composition of the Lobs Hole Adamellite (nos 8, 9, 10) reflect its unusual, partly cumulus origin. These analyses, however, show interesting similarities to that of a rhyodacite unusually rich in feldspar phenocrysts from the Gatelee Ignimbrite (no. 11).

The Middle Devonian Cumberland Rhyolite lies at the top of the volcanic succession in the Boraig Basin and so is appreciably younger than, but conformable with, the rhyolites of the Buddong Volcanics. Its analysis (no. 15), however, stands clearly apart from those of the rhyolites considered here to be co-genetic. Similarly, the Blacks Flat Diorite may be distinguished from the other granitic analyses on many counts, perhaps the most striking of which is its SrO content of 0.29 weight per cent.

#### STRATIGRAPHIC SYNTHESIS

A stratigraphic scheme consistent with the radiometric, palaeontological and structural data discussed in this paper is shown in Fig. 2. The Gocup Granite, Killimicat Adamellite and Lobs Hole Adamellite all have petrographic and chemical analogues in the composite Bogong Granite and in the light of the coherent radiometric and structural data, these plutons are considered to comprise a post-tectonic sub-volcanic leucogranite association of Early (or Earliest) Devonian age.

TABLE I  
Chemical data for some igneous rocks of the Tumut district

	1	2	3	4	5	6	7	8	9	10	11	12	13	14	15	16	17
SiO <sub>2</sub>	74.01	74.81	75.68	76.16	74.11	75.85	72.15	71.14	60.89	64.84	66.01	75.78	74.42	72.34	75.72	53.79	54.94
Al <sub>2</sub> O <sub>3</sub>	12.74	13.63	12.71	12.50	13.70	13.31	13.91	14.22	14.98	14.26	16.23	13.20	12.18	14.30	12.22	15.79	17.20
Fe <sub>2</sub> O <sub>3</sub>	0.56	0.58	0.39	0.26	0.82	0.44	0.65	1.67	2.90	1.98	1.91	1.23	0.47	0.33	0.86	2.51	2.71
FeO	1.77	0.46	0.84	0.64	1.32	0.50	1.81	1.98	3.49	3.69	1.27	0.64	1.58	0.63	0.95	6.14	4.54
MnO	0.03	0.02	0.03	0.03	0.04	0.05	0.02	0.05	0.13	0.09	0.08	0.03	0.05	0.01	0.04	0.19	0.19
MgO	0.50	0.15	0.31	0.12	0.51	0.20	0.60	0.42	1.02	0.81	0.81	0.52	0.62	0.45	0.23	4.02	3.26
CaO	0.34	0.39	0.98	0.98	1.37	0.82	2.19	0.36	4.20	2.59	2.98	0.90	0.61	0.44	0.12	9.21	5.53
Na <sub>2</sub> O	3.52	3.83	3.62	3.54	3.37	3.41	3.97	4.40	6.75	5.57	4.25	3.71	3.10	3.99	3.17	2.93	4.99
K <sub>2</sub> O	5.46	4.59	4.59	4.97	4.39	4.31	3.73	3.41	0.57	2.34	3.94	4.79	5.49	5.49	5.53	1.24	3.22
H <sub>2</sub> O <sup>+</sup>	1.13	0.90	0.35	0.35	0.36	0.30	0.40	1.25	1.87	1.78	1.10	0.61	0.76	1.55	0.62	1.53	1.51
H <sub>2</sub> O <sup>-</sup>	0.15	0.17	0.15	0.15	0.07	0.12	0.09	0.31	0.20	0.24	0.30	0.16	0.18	0.15	0.19	0.16	0.09
TiO <sub>2</sub>	0.22	0.07	0.19	0.18	0.28	0.11	0.35	0.42	1.05	0.68	0.46	0.30	0.32	0.36	0.14	1.76	0.72
P <sub>2</sub> O <sub>5</sub>	0.20	0.29	0.04	0.02	0.05	0.02	0.05	0.12	0.40	0.23	0.12	0.04	0.06	0.05	0.02	0.37	0.48
CO <sub>2</sub>	0.08						0.08										
Total	99.71	99.89	99.86	99.90	100.39	99.44	99.92	99.83	99.47	99.59	99.70	99.91	99.84	100.09	99.81	99.64	99.38
Trace elements in p.p.m.																	
Y	45	35	58	49	44	28	45	66	67	70	47	41	32	56	350		33
Sr	71	75	89	56	86	109	172	167	346	283	300	200	170	230	32		2430
Zr	194	120	186	183	168	120	245	450	400	530	245	215	155	275	213		203
Rb	317	200	205	185	225	260	157	120	25	65	130	200	217	164	240		70

Five-figure specimen numbers (in brackets) refer to the catalogue and collections of the Department of Geology and Geophysics, University of Sydney. Grid references are quoted from the Wagga Wagga geological sheet, scale 1 : 250,000 (Adamson and Loudon, 1966). Analyses by X-ray fluorescence spectrometry, except for Na<sub>2</sub>O (atomic absorption), FeO (titrimetry), H<sub>2</sub>O (gravimetry), CO<sub>2</sub> (combustion).

Key :

1. Biotite leucogranite (48245). Gocup Granite, 5 km E. of Tumut, G.R. 614640.
2. Biotite leucogranite (48247). Gocup Granite, 8-8 km NE. of Tumut, G.R. 612643.
3. Biotite leucogranite (48254). Killinickat Adamellite, 12 km N. of Tumut, G.R. 625651.
4. Biotite leucogranite (48242). Bogong Granite, 22 km SSE. of Tumut, G.R. 629618.
5. Biotite leucogranite (48289). Bogong Granite, 14 km SE. of Tumut, G.R. 634633.
6. Fine-grained biotite leucogranite (48240) Bogong Granite, Marginal phase, 13 km E. of Tumut, G.R. 634636.
7. Hornblende biotite granite (48287). Bogong Granite, 16.5 km SE. of Tumut, G.R. 635627.
8. Porphyritic, granophytic leucogranite (48259). Lobs Hole Adamellite, G.R. 632583.
9. Porphyritic, granophytic leucogranite (48260). Lobs Hole Adamellite, G.R. 633584.
10. Porphyritic, granophytic leucogranite (48261). Lobs Hole Adamellite, G.R. 632584.
11. Rhyodacite, unusually rich in feldspar phenocrysts (48257). Gatelee Ignimbrite, 15 km N. of Tumut, G.R. 622662.
12. Banded rhyolite (48258). Gatelee Ignimbrite, 15 km N. of Tumut, G.R. 620661.
13. Porphyritic rhyolite (48262). Minjary Volcanics, 600 m S. of Minjary Mountain, G.R. 612648.
14. Ignimbritic rhyolite (48280). Buddong Volcanics, 3 km ENE. of Talbingo, G.R. 631606.
15. Rhyolite (48284). Cumberland Rhyolite, 11 km SSE. of Talbingo, G.R. 636595.
16. Andesitic basalt (porphyritic, partially degraded) (48283). Talbingo Basalt, 7.5 km SSE. of Talbingo, G.R. 632598.
17. Diorite (48461). Blacks Flat Diorite, 25 km N. of Tumut, G.R. 623666.

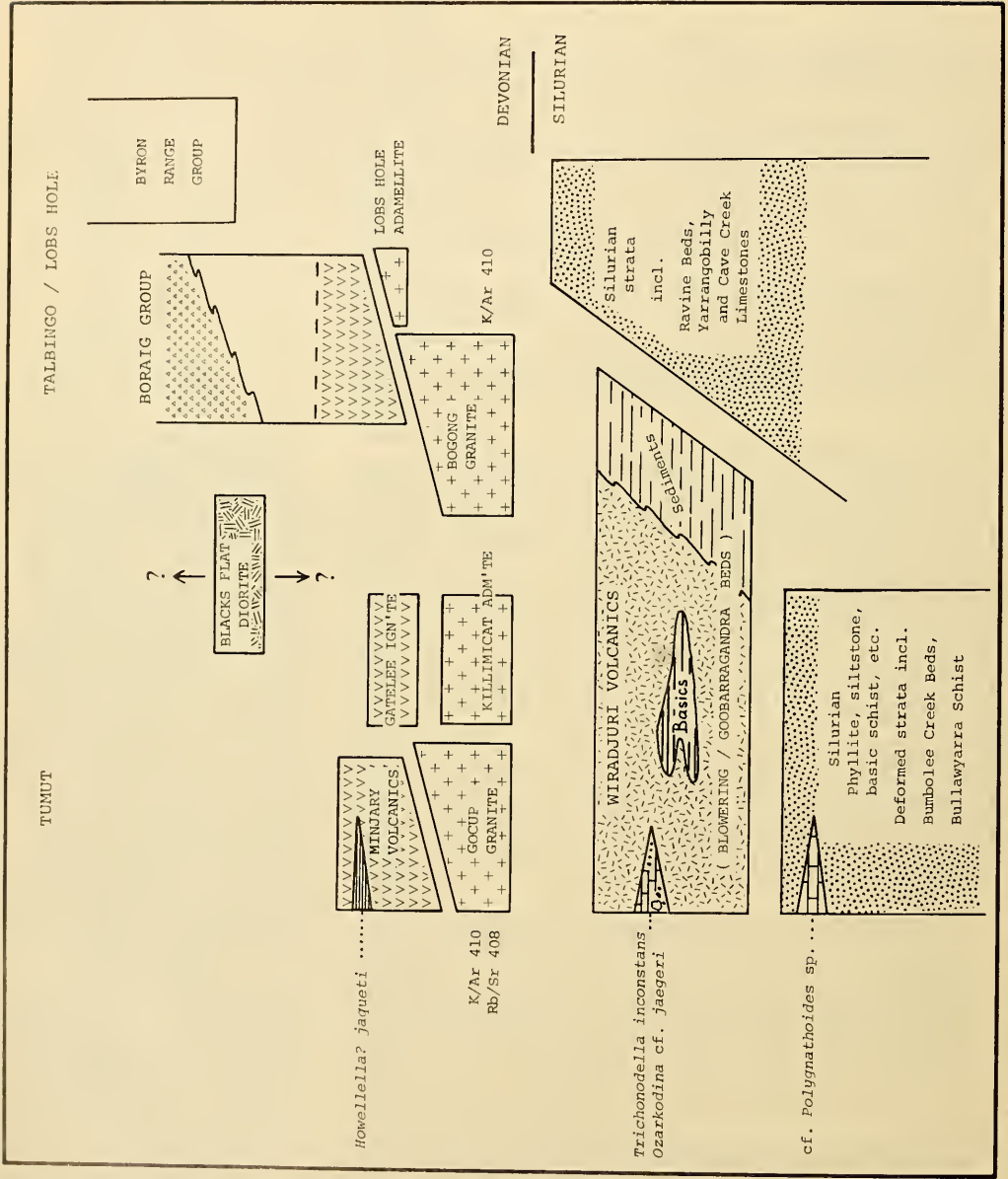

Fig. 2. Sketch of Siluro-Devonian stratigraphic relations in the Tumut region, N.S.W. (not to scale). See also Fig. 1.



The absolute age of the Silurian-Devonian boundary is as equivocal as its lithostratigraphic position (Philip, 1974). Brooks and Leggo (1972) quote 413 and 430 m.y. as possible limiting values, but the latter estimate, although based on "local" data from the Canberra area (Bofinger *et al.*, 1970) may well be subject to stratigraphic imprecision (Talent *et al.*, 1975, p. 27). An age for the boundary of between 410 and 415 m.y. would appear acceptable in the light of the data summarised by Lambert (1971), and indeed such an age is suggested by this study.

In any case, a close temporal relationship exists between the leucogranite and rhyolite associations and, as the volcanism partly overlaps in age and partly postdates the granite emplacement, it may represent the culmination of an Early Devonian episode of high-level acid magmatism. The older the absolute age of the Siluro-Devonian boundary, the more restricted must have been the duration of this magmatic episode. By Middle Devonian time, volcanic activity had resumed in the Boraig Basin with the eruption of the Talbingo Basalt and Cumberland Rhyolite after a break represented stratigraphically by the sediments of the Saddle Tuff and Landers Creek Formation, described by Moye *et al.* (1969).

Thus it may be postulated that the Buddong Volcanics, Gatelee Ignimbrite and Minjary Volcanics represent the extrusive equivalents of the Bogong Granite, Lobs Hole Adamellite, Killimieat Adamellite and Gocup Granite. In this regard, the Minjary Volcanics and the outcrop areas of the Gatelee Ignimbrite show a sub-radial distribution around the two northernmost plutons that may well be genetically significant.

#### ACKNOWLEDGEMENTS

I wish to thank Associate Professor T. G. Vallance for critically reading the manuscript, and Dr. E. A. K. Middlemost for many helpful discussions. The X-ray fluorescence analyses were carried out in the School of Earth Sciences, Macquarie University, where special thanks are due to my colleague, Mr S. Dobos. Mr I. G. Percival assisted with the identification of the brachiopods.

#### References

- ADAMSON, C. L., 1957.—Reconnaissance geology of the Snowy Mountains area. Progress report 10. Tumbarumba. *Tech. Rep. Dep. Mines N.S.W.*, 2 (for 1954) : 7–15.
- , 1960a.—Reconnaissance geology of the Snowy Mountains area. Progress report 16. Tumut. *Tech. Rep. Dep. Mines N.S.W.*, 5 (for 1957) : 138–154.
- , 1960b.—The geology of Burrangong Shire. *Tech. Rep. Dep. Mines N.S.W.*, 5 (for 1957) : 155–162.
- and LOUDON, A. G., 1966.—Geological sheet, Wagga Wagga, N.S.W. *Geol. Surv. N.S.W.*, Sydney.
- ASHLEY, P. M., CHENHALL, B. E., CREMER, P. L., and IRVING, A. J., 1971.—The geology of the Coolac Serpentinite and adjacent rocks east of Tumut, New South Wales. *J. Proc. R. Soc. N.S.W.*, 104 : 11–29.
- and BASDEN, H., 1973.—Revision of nomenclature of granitic intrusions at Burrinjuck, Young and Cowra. *Rec. geol. Surv. N.S.W.*, 15 (2) : 213–220.
- BASDEN, H., 1974.—Preliminary report on the geology of the Cootamundra 1 : 100,000 sheet. *Q. Notes geol. Surv. N.S.W.*, 15 : 7–18.
- BOFINGER, V. M., COMPSTON, W., and GULSON, B. L., 1970.—A Rb–Sr study of the Lower Silurian State Circle Shale, Canberra, Australia. *Geochim. cosmochim. Acta*, 34 : 433–445.
- BRADLEY, G. M., 1968.—The geology of the Upper Gilmore Creek district, north east of Batlow, N.S.W. B.Sc. Hons thesis (unpubl.), Dept Geol. Geophys., Univ. Sydney.
- BROOKS, C., and LEGGO, M. D., 1972.—The local chronology and regional implications of a Rb–Sr investigation of granitic rocks from the Corryong District, southeastern Australia. *J. geol. Soc. Aust.*, 19 : 1–19.
- BROWN, I. A., 1941.—The stratigraphy and structure of the Silurian and Devonian rocks of the Yass-Bowning district, New South Wales. *J. Proc. R. Soc. N.S.W.*, 74 : 312–341.
- CARNE, J. E., and JONES, L. J., 1919.—The limestone deposits of New South Wales. *Miner. Resour. N.S.W.*, 25.
- CHATTERTON, B. D. E., 1973.—Brachiopods of the Murrumbidgee Group, Taemas, New South Wales. *Bur. Miner. Resour. Geol. Geophys. Aust. Bull.*, 137.
- DUN, W. S., 1901.—Report of a collection of fossils from the foot of Minjary Mountain, Tumut. *Ann. Rep. Dep. Mines N.S.W.*, (for 1900) : 185, 195.

- FLETCHER, H. O., 1961.—Palaeontological determinations, 1958. *Tech. Rep. Dep. Mines N.S.W.*, 6 (for 1958) : 116.
- HALL, L. R., and RELPH, R. E., 1956.—Reconnaissance geology of the Snowy Mountains area. Progress report 9. Talbingo-Tumut. *Tech. Rep. Dep. Mines N.S.W.*, 1 (for 1953) : 9-13.
- LAMBERT, R.StJ., 1971.—The pre-Pleistocene Phanerozoic time-scale—a review. In *The Phanerozoic time-scale—a supplement. Spec. Publ. geol. Soc. Lond.*, 5 : 9-31.
- LINK, A. G., and DRUCE, E. C., 1972.—Ludlovian and Gedinian conodont stratigraphy of the Yass Basin, New South Wales. *Bur. Miner. Resour. Geol. Geophys. Aust. Bull.*, 134.
- MOYE, D. G., SHARP, K. R., and STAPLEDON, D. H., 1969.—Lower and Middle Devonian Series, Snowy Mountains area. In *The geology of New South Wales. J. geol. Soc. Aust.*, 16 : 143-146.
- NICOLL, R. S., and REXROAD, C. B., 1974.—Llandovery (Silurian) conodonts from southern New South Wales. (Abstract) *Geol. Soc. Am. Abst. Prog.*, 6 : 534.
- PACKHAM, G. H., (Ed.) 1969.—The geology of New South Wales. *J. geol. Soc. Aust.*, 16 : 1-654.
- PHILIP, G. M., 1974.—Biostratigraphic procedures and correlation in the Tasman geosynclinal zone. In *The Tasman Geosyncline—a symposium. Geol. Soc. Aust., Queensl. Div.*, pp. 295-312.
- RYALL, W. R., 1965.—The geology of the Canowindra East area, N.S.W. *J. Proc. R. Soc. N.S.W.*, 98 : 169-179.
- SCHIEBNER, E., 1973.—A plate tectonic model of the Palaeozoic tectonic history of New South Wales. *J. geol. Soc. Aust.*, 20 : 405-426.
- , 1974.—Tectonic map of New South Wales, scale 1 : 1,000,000. *Geol. Surv. N.S.W.*, Sydney.
- STEPHENS, W. J., 1882.—Note and exhibit—Rocks and fossils from the western coal-fields and Siluro-Devonian brachiopods from Yass and the Minjary Ranges, near Tumut. *Proc. LINN. Soc. N.S.W.*, 7 : 560.
- STEVENS, N. C., 1952.—The petrology of the Cowra intrusion and associated xenoliths. *Proc. LINN. Soc. N.S.W.*, 77 : 132-141.
- STRUSZ, D. L., 1971.—Explanatory notes, Canberra 1 : 250,000 geological sheet. *Bur. Miner. Resour. Geol. Geophys. Aust.*, Canberra. 47 pp.
- , and 13 others, 1972.—Correlation of the Lower Devonian rocks of Australasia. *J. geol. Soc. Aust.*, 18 : 427-455.
- TALENT, J. A., 1965.—The stratigraphic and diastrophic evolution of central and eastern Victoria in middle Palaeozoic times. *Proc. R. Soc. Vict.*, 79 : 179-195.
- , BERRY, W. B. N., BOUCOT, A. J., PACKHAM, G. H., and BISCHOFF, G. C. O., 1975.—Correlation of the Silurian rocks of Australia, New Zealand and New Guinea. *Spec. Pap. geol. Soc. Am.*, 150 : 1-108.
- THRUM, D. P., 1972.—The geology of an area between Brungle and Darbalara in New South Wales. B.Sc. Hons thesis (unpubl.), Dept. Geol. Geophys., Univ. Sydney.
- TINDALE, N. B., 1940.—Distribution of Australian Aboriginal tribes : a field survey. *Trans. R. Soc. S. Aust.*, 64 : 140-231.
- VALLANCE, T. G., 1953.—Studies in the metamorphic and plutonic geology of the Wantabadgery-Adelong-Tumbarumba district, N.S.W. Part I. Introduction and metamorphism of the sedimentary rocks. *Proc. LINN. Soc. N.S.W.*, 78 : 90-121.
- , 1969.—Plutonic and metamorphic rocks, Southern and Central Highlands fold belt. In *The geology of New South Wales. J. geol. Soc. Aust.*, 16 : 180-200.
- WALLISER, O. H., 1964.—Conodonten des Silurs. *Hess. Landesamt Bodenforsch. Abh.*, 41 : 1-106.

THE GENERA *CAMPYLOCHIRUS* TROU ESSART AND  
*CAMPYLOCHIOPSIS* FAIN (ACARI: ATOPOMELIDAE),  
PARASITES OF PHALANGEROID MARSUPIALS IN AUSTRALASIA

ALEX FAIN\* and ROBERT DOMROW†

[Accepted for publication 17th December 1975]

*Synopsis*

The little known type-species of *Campylochirus* Trouessart, *Campylochirus chelopus* Trouessart from *Pseudocheirus peregrinus* (Boddaert) in Tasmania, is re-examined. Material from the same host and locality subsequently assigned to this species is shown to be composite, comprising *Campylochirus* (*Campylochirus*) *brevipennis*, n. sp., and *Campylochiroopsis micrura* Fain and Domrow. *Schoinobates volans* (Kerr) is listed as a new (and more likely) host for *Campylochirus* (*Campylochiroides*) *antechinus* Fain, originally described from museum specimens of various Australian dasyurid marsupials. *Campylochirus* (*Campylochiroides*) *sthenophallus*, n. sp., is described from *S. volans* in Victoria. New morphological data are given for *Campylochiroopsis dolichurus* (Fain), also from *S. volans*, and for *Campylochiroopsis misonnei* Fain from *Pseudocheirus* sp. in Irian Jaya. No new data are available for the three other known *Campylochirus* (*Campylochiroides*) spp.: *C. pseudocheirus* Fain (*Pseudocheirus forbesi* Thomas, New Guinea), *C. petauricola* Fain (*Petaurus breviceps* Waterhouse, Victoria and Irian Jaya), and *C. caparti* Fain (*Pseudocheirus* sp., Irian Jaya). The necessary illustrations and descriptions are given, thereby affording a revision of the closely related genera *Campylochirus* and *Campylochiroopsis*, all species of which parasitise petaurid marsupials in Australasia.

The Australian phalangeroid marsupials carry several atopomelid genus-group taxa characterised in part by a relatively full complement of dorsal shields (see Fain and Domrow, 1974, for terminology), the migration of the normally basal solenidion of tibiotarsi III to a distal position (Fain, 1972), and, in the ♂, by adanal organs and incrassate legs IV.

The first to be described was *Campylochirus* Trouessart, the history of which is complex enough to bear summary. Its type-species, *Campylochirus chelopus* Trouessart, was briefly described without illustrations by Trouessart (1893, 1917) from *Pseudocheirus peregrinus* (Boddaert) (= *Pseudocheirus convolutor* (Oken) = *Phalangista cooki* Desmarest), the only representative of this genus in Tasmania.

In August 1956, Lawrence described *Cricetomysia andrei*, n. g., n. sp., from specimens in the Trouessart collection labelled as from *Cricetomys gambianus*, West Africa. Earlier, in April of the same year, Domrow (1956b) described the ♂, ♀, and nymph of a species he identified as *Campylochirus chelopus* from specimens collected on the type-host in Tasmania. In 1958, Domrow noted that his description and figures corresponded well with those of *Cricetomysia andrei* and concluded that the specimens described by Lawrence could only be the lost syntypes of *Campylochirus chelopus*, but that they had become mislabelled since Trouessart's time.

Fain (1971, 1972), in his revision of the Listrophoroidea of Australia and New Guinea, reproduced the illustrations of the ♂ and ♀ given by Domrow (1956b), because enquiry at likely institutions had failed to locate the specimens on which they were based.

This seemed satisfactory until Domrow recently obtained both sexes of two atopomelid species from *Pseudocheirus peregrinus* in Tasmania and Victoria and concluded that the species he had earlier described as *Campylochirus chelopus* was

\* Institut de Médecine Tropicale Prince Léopold, Antwerp, Belgium.

† Queensland Institute of Medical Research, Herston, Queensland, 4006.

composite, the ♂ representing his conception of *Campylochirus chelopus*, and the ♀ and nymph representing a new species briefly described as *Campylochiopsis micrura* by Fain and Domrow (Fain, 1974). The examination of six of Domrow's original specimens (on a slide since located in the Natal Museum, Pietermaritzburg, by Mr B. Lamoral) confirmed this finding.

A re-examination of Trouessart's types seemed essential and this was kindly facilitated by Mr M. Nando, Muséum National d'Histoire Naturelle, Paris. In brief, *Campylochirus chelopus* Trouessart is closely related to, but distinct from, *Campylochirus chelopus* Domrow.

It is the purpose of this paper to record the corrections involving the three species and two closely related atopomelid genera mentioned above, to describe another new species of *Campylochirus*, and to provide further data on three of the other six known species in the complex. All species are from members of the family Petauridae (Laurie and Hill, 1954 ; Ride, 1970).

All measurements are in  $\mu\text{m}$ .

The material listed is deposited in various institutions abbreviated :

Australian National Insect Collection, CSIRO, Canberra	ANIC
British Museum (Natural History), London	BMNH
Institut de Médecine Tropicale Prince Léopold, Antwerp	IMTPL
Institut Royal des Sciences Naturelles de Belgique, Brussels	IRSNB
Muséum National d'Histoire Naturelle, Paris	MNHN
Natal Museum, Pietermaritzburg	NM
Queensland Institute of Medical Research, Brisbane	QIMR
Queensland Museum, Brisbane	QM

#### Genus CAMPYLOCHIRUS Trouessart

*Campylochirus* Trouessart, 1893 : 698. Type-species *Campylochirus chelopus* Trouessart.

*Cricetomysia* Lawrence, 1956 : 355. Type-species *Cricetomysia andrei* Lawrence.

*Definition.* Both sexes with four dorsal shields of which the postscapular is devoid of strongly sclerotised transverse bands posteriorly ; coxae III and IV normally placed. Female without any external copulatory tube. Male with genitalia set between trochanters IV ; legs IV moderately to strongly swollen, with suckers on tibiotarsi IV reduced in latter case.

#### Subgenus CAMPYLOCHIRUS Trouessart

*Definition.* Male with penis cylindrical, long to very long, and describing at least one curve ; body provided with complex transparent membrane posteriorly ; legs IV strongly swollen, with shortened tibiotarsi IV bearing reduced suckers. Female with two lateral shields on opisthogaster ; opisthonotal shield in shape of T, flanked on either side by an elongate depressed zone that is neither punctate nor scaly.

#### *Campylochirus* (*Campylochirus*) *chelopus* Trouessart

(Figs 1-4)

*Campylochirus chelopus* Trouessart, 1893 : 699, 1917 : 154 ; Domrow, 1956a : 191. *Nec* Domrow, 1956b : 234, 1958 : 43 ; Fain, 1972 : 122.

*Cricetomysia andrei* Lawrence, 1956 : 356 ; Domrow, 1958 : 43.

*Material.* Two ♂♂ and one ♀, mislabelled (in Trouessart's handwriting) *Cricetomys gambianus* Waterhouse (Rodentia : Muridae), West Africa, but said by Trouessart to have come from *Pseudocheirus peregrinus* (Boddaert), Tasmania (MNHN). Two ♂♂, same data (NM).

One ♂ (MNHN) (that figured by Lawrence, 1956) is designated lectotype and the remaining four specimens paralectotypes of *Campylochirus chelopus* (Rees 74B and E). Although Lawrence (pers. comm.) did not select a holotype for *Cricetomysia andrei*, no type designation seems necessary now, since it is an objective junior synonym of Trouessart's species.

*Male lectotype* (Figs 1-2). Length (including capitulum) 330; maximum width 153. Prescapular shield subcircular, sclerotised except marginally. Postscapular shield shallowly concave anteriorly. Hysteronotal shield with few scales laterally. Opisthonotal shield posteriorly with median design formed by

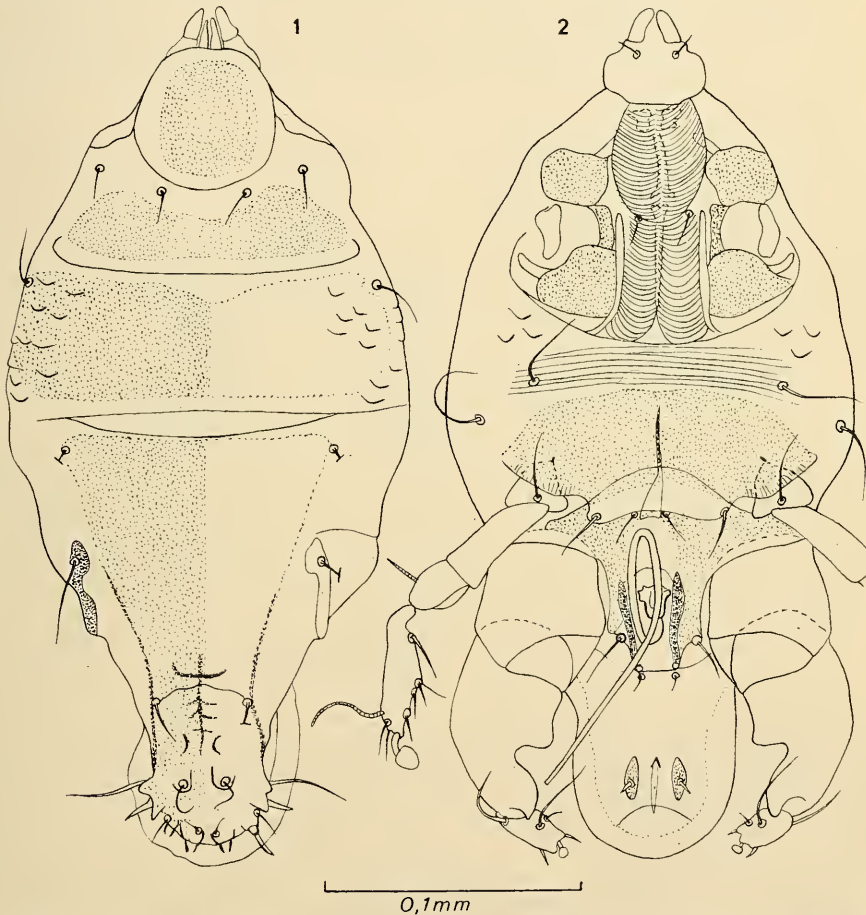

Figs 1-2. *Campylochirus* (*Campylochirus*) *chelopus* lectotype ♂. 1. Dorsum. 2. Venter.

short longitudinal line bearing several short arborescences; posteriorly with two paramedian setose prominences and two lateral bifid processes. Coxae III confluent, with straight longitudinal sclerite medially. Penis describing two turns of  $180^\circ$  and long enough for distal half to be displaced  $45^\circ$  laterally in mounted specimens; total length 186. Anus flanked by pair of oval adanal organs, each carrying small curved spine posteriorly. Legs IV strongly swollen, with tibiotarsi IV quite short and carrying reduced sucker on short peduncle. Genua IV with strong distal boss directed dorsally.

*Female paralectotype* (Figs 3-4). Length (including capitulum) 366; maximum width 144. This specimen contains an egg with thin shell,  $177 \times 47$ . Anterior three dorsal shields as in ♂. Opisthonotal shield in form of T, falling well short of vestibule of bursa copulatrix. Cuticle scaly on either side of shield except for longitudinal textureless gutter. Bursa copulatrix with broad vestibule opening dorsally 27 from end of body; bursa relatively long, dilated past mid-length, and then sharply narrowed and more sclerotised towards internal aperture: total length 153, length of very narrow portion 45. Cuticle smooth in

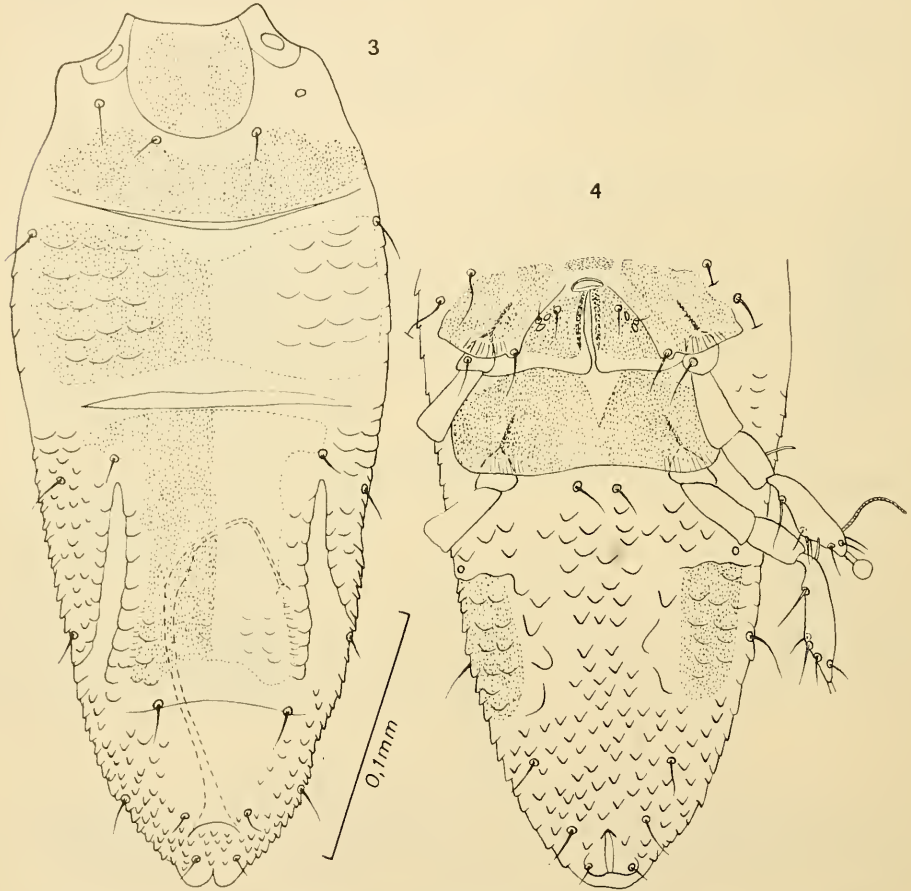

Figs 3-4. *Campylochirus* (*Campylochirus*) *chelopus* paralectotype ♀. 3. Dorsum. 4. Venter.

front of vestibule, but scaly behind and beside it. Propodosoma ventrally as in ♂. Coxae III punctate, separated in front by punctate band. Coxae IV confluent, at least posteriorly. Opisthogaster entirely scaly, with small punctate shield to either side. Anus subterminal.

*Notes.* The above description supplements that of Lawrence (1956) and is based solely on specimens that are at once the syntypes of *Campylochirus chelopus* and *Cricetomysia andrei*.

See also notes on *Campylochirus brevipenis* below.

*Campylochirus (Campylochirus) brevipenis*, n. sp.

(Figs 5-7)

*Campylochirus chelopus* Domrow, 1956b : 234 (♂ and nymph), 1958 : 43 (♂ and nymph) ; Fain, 1972 : 122 (♂ and nymph). *Nec* Trouessart, 1893 : 699, 1917 : 154 ; Domrow, 1956a : 191.

**Material.** Holotype and three paratype ♂♂, allotype and six paratype ♀♀, *Pseudocheirus peregrinus*, Dartmouth, Vic., 22.xi.1973, I. Beveridge; two paratype ♂♂ and four paratype ♀♀, *Pseudocheirus peregrinus*, Launceston, Tas., 1.x.1973, R.H. Green. Holotype and allotype in ANIC ; paratypes in IMTPL and QIMR.

As noted above, some material (one ♂) Domrow (1956b) figured and described from the same host, Woodbury, Tas., has been recovered (NM).

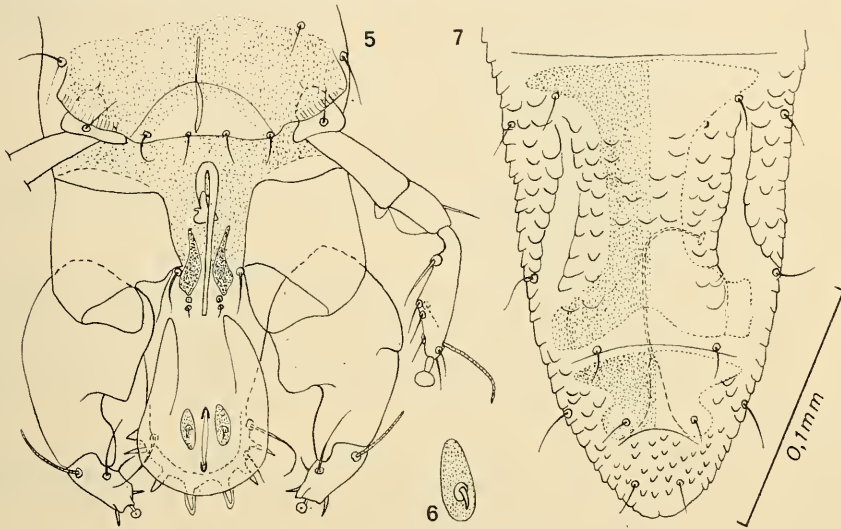

Figs 5-7. *Campylochirus (Campylochirus) brevipenis*. 5. Venter holotype ♂. 6. Adanal organ ♂. 7. Dorsum allotype ♀.

**Male holotype** (Figs 5-6). This specimen is flattened and broken in two, but its length (including capitulum) does not exceed 350 nor its maximum width 120. In two paratypes, these dimensions are 285 × 120 and 308 × 126. Dorsum and venter as in *Campylochirus chelopus* except for very much shorter penis (which describes only one turn of 180°) and slightly different shape of aggenital sclerites. Maximum length of penis 77 in holotype, 72, 75, and 81 in three paratypes.

**Female allotype** (Fig. 7). Length (including capitulum) 338 ; maximum width 125. Dorsum as in *Campylochirus chelopus*, but hysteronotal shield somewhat narrower at midlength and with urn-shaped accessory shieldlet in front of vestibule of bursa copulatrix. Bursa very narrow throughout (beyond vestibule), not expanded near midlength ; total length only 96 in allotype, 90, 92, and 94 in three paratypes.

**Notes.** The new species is closely related to *Campylochirus chelopus*, but is readily separable in both sexes by the genitalic characters noted in the description.

Subgenus *CAMPYLOCHIROIDES* Fain

*Campylochiroides* Fain, 1971 : 240. Type-species *Campylochirus (Campylochiroides) antechinus* Fain.

*Definition.* Male with penis short to very short, directed backwardly without describing any curve; body without any membrane posteriorly; legs IV moderately swollen, with normal tibiotarsi IV bearing normal suckers. Female with either a median or no shield on opisthogaster; opisthonotal shield not flanked by depressed textureless zones.

*Campylochirus (Campylochiroides) antechinus* Fain

*Campylochirus (Campylochiroides) antechinus* Fain, 1971 : 241, 1972 : 126.

*Material.* Six ♂♂ and one ♀, *Schoinobates volans* (Kerr) (= *Petauroides volans* (Kerr)), Dartmouth, Vic., 20.i.1974, I. Beveridge, represent a new (and more likely) host-record. In IMTPL; type-series in BMNH and IMTPL.

The type-series is from museum specimens of various Australian dasyurid marsupials (Dasyuroidea) and, in the light of the present record and the host-relationships of all other species in the complex, may well comprise contaminants.

*Female.* Bursa copulatrix narrow and weakly sclerotised, 180 long in one paratype from *Antechinus stuartii* Maeleay (= *A. unicolor* Gould, see Wakefield and Warneke (1967)), and describing 4–5 curves.

*Campylochirus (Campylochiroides) sthenophallus*, n. sp.

(Figs 8–9)

*Material.* Holotype ♂, allotype ♀, and two paratype ♂♂, *Schoinobates volans* (Kerr), Dartmouth, Vic., 20.i.1974, I. Beveridge. Holotype and allotype in ANIC; paratypes in IMTPL and QIMR.

*Male holotype* (Fig. 9). Length (including capitulum) 302; maximum width 135. General facies as in *Campylochirus antechinus*, but genitalia considerably more complex. Penis proper 18 long, flanked by two elongate formations of similar length, all three travelling within stout U-shaped sclerite. Behind penis lie two strong paramedian elongate-triangular sclerites; these, U-shaped sclerites, and complex structure supporting base of penis all lacking in *Campylochirus antechinus*.

*Female allotype* (Fig. 8). Length (including capitulum) 315; maximum width 137. General facies as in *Campylochirus antechinus*, but bursa copulatrix thick-set, about 300 long, and describing several curves. Internal aperture of bursa dilated, 12–14 long. Vestibule not discernible.

*Notes.* The new species is closely related to *Campylochirus antechinus*, but is readily separable in both sexes by the genitalic characters notes in the description.

*Campylochirus (Campylochiroides) pseudocheirus* Fain

*Campylochirus (Campylochiroides) pseudocheirus* Fain, 1972 : 128.

*Material.* Type-series from *Pseudocheirus forbesi* Thomas, Papua New Guinea (BMNH and IMTPL). One ♀ from *Pseudocheirus* sp., Irian Jaya (IMTPL).

*Campylochirus (Campylochiroides) petauricola* Fain

*Campylochirus (Campylochiroides) petauricola* Fain, 1972 : 131.

*Material.* Type-series from *Petaurus breviceps papuanus* Thomas, Irian Jaya, and *Petaurus breviceps* Waterhouse, Victoria (BMNH).

*Campylochirus (Campylochiroides) caparti* Fain

*Campylochirus (Campylochiroides) caparti* Fain, 1974 : 14.

*Material.* Type-series from *Pseudocheirus* sp., Irian Jaya (IRSNB).

Genus CAMPYLOCHIROPSIS Fain

*Campylochiropsis* Fain, 1972 : 120. Type-species *Campylochirus (Campylochiropsis) dolichurus* Fain.



*Definition.* Both sexes with four dorsal shields of which the postscapular shows two strongly sclerotised, but medially interrupted, bands posteriorly; coxae IV widely separated from coxae III. Female with long external copulatory tube. Male with genitalia displaced anteriorly, set either between, or in front of, trochanters III; legs IV only slightly swollen, sometimes shortened, but always with normal suckers on tibiotarsi IV.

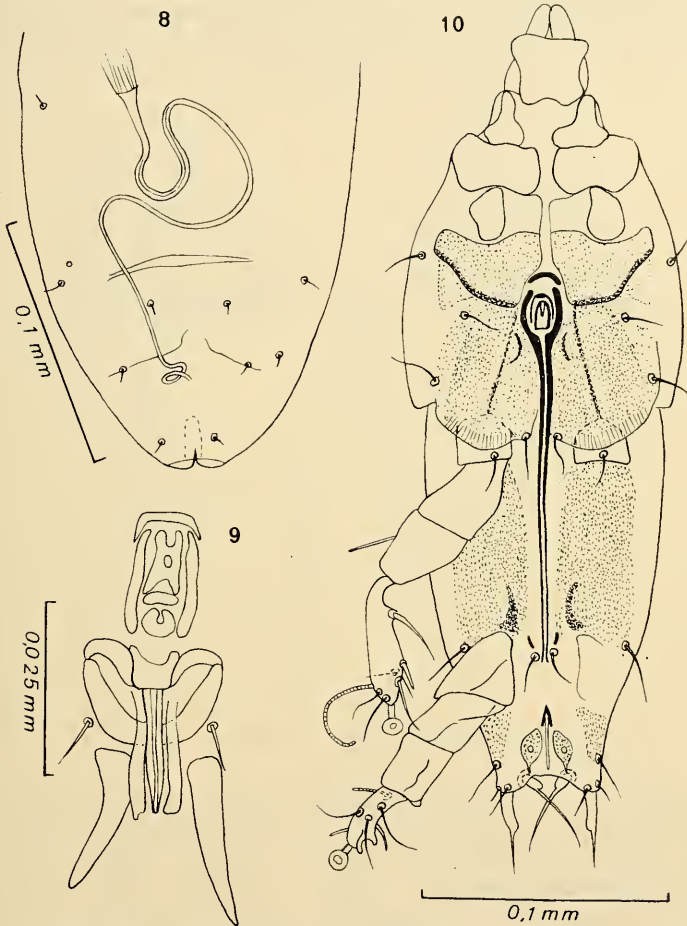

Figs 8-9. *Campylochirus* (*Campylochiroides*) *sthenophallus*. 8. Dorsum ♀. 9. Genitalia ♂.

Fig. 10. *Campylochiropsis dolichurus* ♂. Venter.

*Campylochiropsis dolichurus* (Fain)

(Fig. 10)

*Campylochirus* (*Campylochiropsis*) *dolichurus* Fain, 1972 : 123.

*Material.* Eleven ♂♂ and ten ♀♀ from type-host, *Schoinobates volans* (Kerr), Dartmouth, Vic., 20.i.1974, I. Beveridge. In IMTPL and QIMR; type-series in BMNH.

*Male* (Fig. 10). Penis considerably displaced forward, lying between anterior portions of coxae III, at level of setae *sh*.

*Notes.* The position and details of the genitalia could not be seen in the one laterally mounted male in the type-species.

*Campylochiropsis misonnei* Fain

Figs. 11–12

*Campylochiropsis misonnei* Fain, 1974 : 16.

*Material.* Two ♀♀ from type-host, *Pseudocheirus* sp., Jiwika, Irian Jaya (IRSNB).

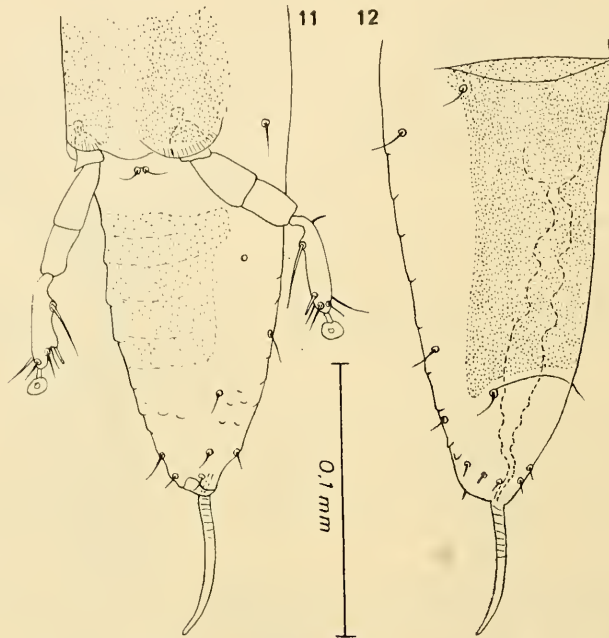

Figs 11–12. *Campylochiropsis misonnei* ♀. 11. Venter. 12. Dorsum.

*Female* (Figs 11–12). Length (including capitulum, but excluding copulatory tube) 345 ; width (in oblique view) 90. Dorsum as in *Campylochiropsis dolichurus*, but lacking scales on opisthonotal shield and area behind setae  $d_3$  smooth. Opisthogaster with ill-defined and lightly punctate shield that lacks scales, though some occur behind it. Copulatory tube 3–4 wide at most, 51 long in one specimen and 57 in other. Bursa copulatrix sclerotised and very narrow over first 10–12, but becoming membranous and wide for 110 before reaching hemispherical internal aperture.

*Notes.* The two females just described come from the same animal as the type-series, which comprised only males.

*Campylochiropsis micrura* Fain and Domrow

(Figs 13–16)

*Campylochirus chelopus* Domrow, 1956*b* : 234 (♀), 1958 : 43 (♀) ; Fain, 1972 : 122 (♀). *Nec* Trouessart, 1893 : 699, 1917 : 154 ; Domrow, 1956*a* : 191.

*Campylochiropsis micrura* Fain and Domrow, in Fain, 1974 : 16.

*Material.* Type-series from *Pseudocheirus peregrinus*, Victoria. Holotype and allotype in QM ; paratypes in IMTPL and QIMR.

As noted above, some material (three ♀♀, one ♂, one nymph) Domrow (1956b) figured and described from the same host, Woodbury, Tas., has been recovered (NM). The nymph is associated with the ♀ rather than with the ♂ because of the resemblance of legs I and the elongate coxae IV.

Two ♀♀ from *Petaurus* sp., Irian Jaya (IMTPL).

*Male allotype* (Figs 13 and 15). Length (including capitulum) 330; maximum width 115. Prescapular shield divided into two rectangular halves; other dorsal shields as in *Campylochiropsis dolichurus*. Opisthogaster largely obscured by legs IV, but adanal organs present. Penis very small, set between trochanters III. Legs IV shorter, but hardly thinner, than legs III; tibiotarsi IV smaller than tibiotarsi III.

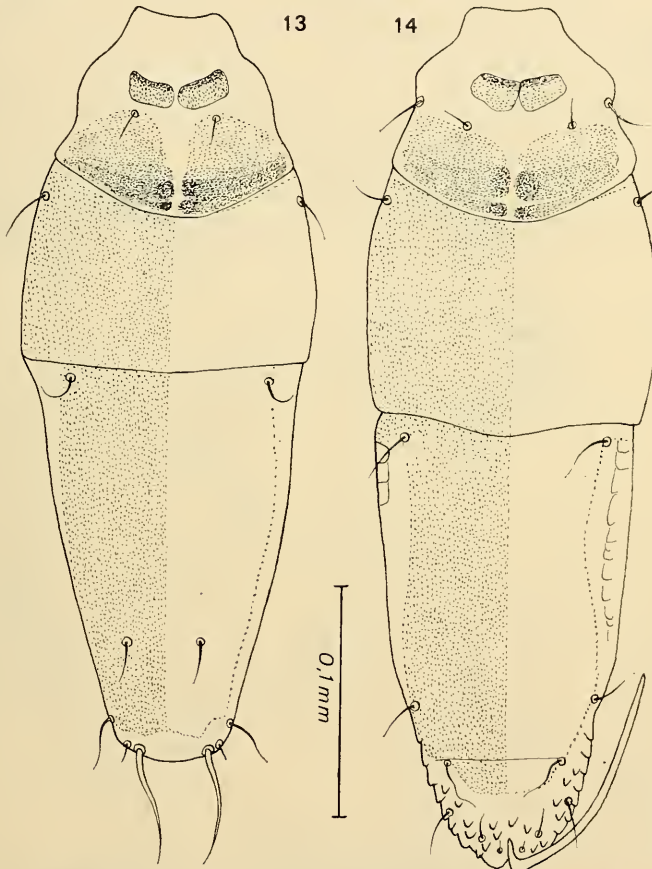

Figs 13-14. *Campylochiropsis micrura*. 13. Dorsum allotype ♂. 14. Dorsum holotype ♀.

*Female holotype* (Figs 14 and 16). Length (including capitulum, but excluding copulatory tube) 362; maximum width 106. Opisthonotal shield without scales, but cuticle of opisthosoma entirely scaly except central area on opisthogaster. Copulatory tube 90 long.

*Notes.* The preliminary diagnosis of *Campylochiropsis micrura* given by Fain and Domrow (Fain, 1974) is here supplemented by illustrations and further description. The species is separable from *Campylochiropsis misonnei* (1) in the male, by the more strongly flared shape of the posterior end of the body (with a consequently much wider separation of the two strong setae thereupon), and by

the absence of an oval sclerotisation around the analia, and (2) in the female, by the more numerous scales on the opisthosoma and by the much longer copulatory tube.

Further, the species is separable from *Campylochiropsis dolichurus* (1) in the male, by the absence of strongly modified setae at the posterior end of the body and by the unmodified tibiotarsi IV; and (2) in the female, by the absence of scales on the opisthotal shield and by the much shorter copulatory tube.

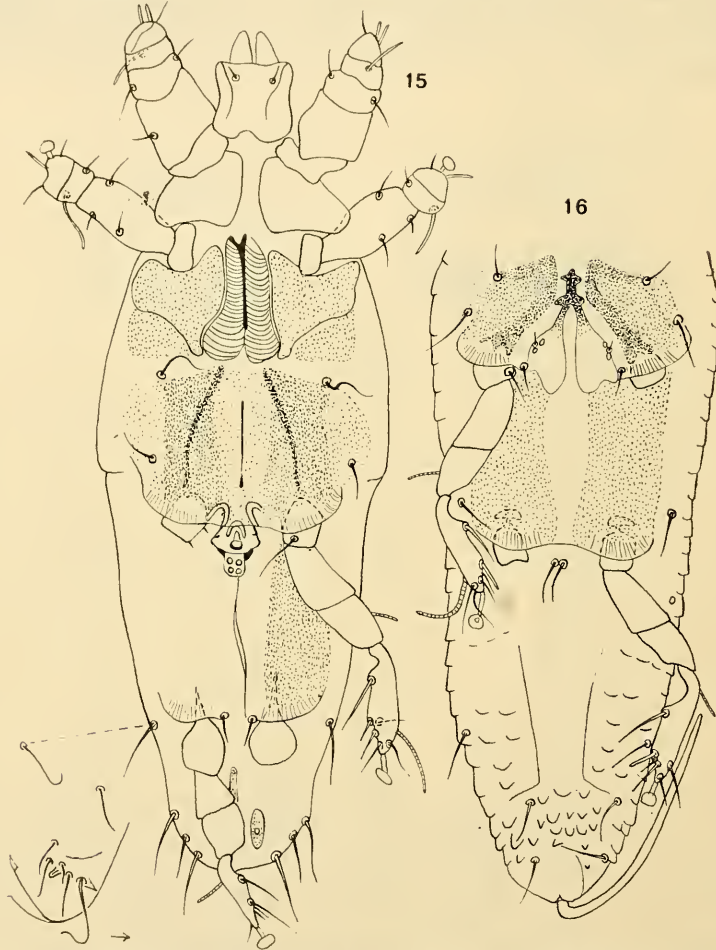

Figs 15-16. *Campylochiropsis micrura*. 15. Venter allotype ♂ (with inset of terminalia of Woodbury♂ in lateral view). 16. Venter holotype ♀.

*Nomenclature.* All ten specific names recognised above are nouns, two genitive (*caparti* and *misonnei*), and eight nominative in apposition.

#### ADDENDUM

While we accept that parasites are but one possible indicator of host relationships, we believe their collection serves as much to accumulate data on their hosts as the measurement of, say, tooth rows. So may we ask our colleagues who handle Australian vertebrates (especially the seldom seen, but even the common please to take time to collect their parasites? A wad of cotton wool soaked in ones, at least in potentially interesting areas such as the limits of their ranges), chloroform and rubbed briskly through the fur of a lightly anaesthetised animal

will dislodge a surprisingly good sample of free-roving mites. Soft skin (e.g. feet, perianal region, interior of ear) should be examined for attached mites, and scurfy lesions scraped off. Closer examination of the fur (or feathers, or scales), even by eye, will reveal mites, and, time and material permitting, they may also be found in internal organs (e.g. nasal passages and lungs). See Evans *et al.* (1961), Fain (1965) and McClure (1966). Material should be stored in ethanol (70% in water, preferably with 5% glycerol to counter hardening), *not* formalin, together with full, neatly written collection data. Further preparation is best left to the specialist.

Acarological data from such collections may be confirmatory (e.g. the species of *Trichosurolaelaps* on the lower macropodid *Hypsiprymnodon* belongs with those from phalangerids and petaurids, see Domrow, 1966); indicative of possible value (e.g. the species of *Laelaps* on "old endemic" rodents, see Domrow, 1973, under study); or, frankly, of little value (e.g. *Mesolaelaps australiensis* with its catholic tastes, see Domrow, 1967).

We conclude with two points. One, new species of such popular groups as birds are now seldom described, but "we cannot expect . . . to settle all the problems of mite taxonomy . . . for decades to come" (Mayr, 1969). Two, the recent recovery of some "lost" Australian mammals and birds and the chance location of a living colony of the former fossil *Burrhamys* give some hope, but the losses documented by Marlow (1958) imply a double extinction, of host *and* parasite.

#### References

- DOMROW, R., 1956a.—Notes on Australian fur-mites (Listrophoridae, Atopomelinae), with description of a new genus. *PROC. LINN. SOC. N.S.W.*, 80: 191–200.
- , 1956b.—The genera *Campylochirus* Trouessart and *Austrochirus* Womersley in Australia (Acarina, Listrophoridae). *PROC. LINN. SOC. N.S.W.*, 80: 234–239.
- , 1958.—A summary of the Atopomelinae (Acarina, Listrophoridae). *PROC. LINN. SOC. N.S.W.*, 83: 40–54.
- , 1966.—Some laelapid mites of syndactylous marsupials. *PROC. LINN. SOC. N.S.W.*, 90: 164–175.
- , 1967.—Mite parasites of small mammals from scrub typhus foci in Australia. *Aust. J. Zool.*, 15: 759–798.
- , 1973.—New records and species of *Laelaps* and allied genera from Australasia (Acari: Dermanyssidae). *PROC. LINN. SOC. N.S.W.*, 98: 62–85.
- EVANS, G. O., SHEALS, J. G., and MACFARLANE, D., 1961.—*The terrestrial Acari of the British Isles*. Vol. 1. London: British Museum.
- FAIN, A., 1965.—Quelques aspects de l'endoparasitisme par les acariens. *Annls Parasit. hum. comp.*, 40: 317–327.
- , 1971.—Notes sur quelques Atopomelidae de la région australienne (Acarina: Listrophoroidea). *Revue Zool. Bot. afr.*, 83: 238–242.
- , 1972.—Les listrophoridés d'Australie et de Nouvelle-Guinée (Acarina: Sarcoptiformes). *Bull. Inst. r. Sci. nat. Belg.*, 48(5): 1–196.
- , 1974.—Mission zoologique du Fonds Léopold III en Irian (Nouvelle-Guinée Occidentale): acariens parasites de marsupiaux et de rongeurs (Listrophoroidea). *Bull. Inst. r. Sci. nat. Belg.*, 50(7): 1–22.
- , and DOMROW, R., 1974.—The subgenus *Cytostethum* Domrow (Acari: Atopomelidae): multiple speciation on the marsupial *Potorous tridactylus* (Kerr). *Aust. J. Zool.*, 22: 549–572.
- LAURIE, Eleanor M. D., and HILL, J. E., 1954.—*List of land mammals of New Guinea, Celebes and adjacent islands 1758–1952*. London: British Museum.
- LAWRENCE, R. F., 1956.—Studies on South African fur-mites (Trombidiformes and Sarcoptiformes). *Ann. Natal Mus.*, 13: 337–375.
- MCCLURE, H. E., 1966.—*An Asian bird-banders manual*. Hong Kong: Migratory Animals Pathological Survey.
- MARLOW, B. J., 1958.—A survey of the marsupials of New South Wales. *C.S.I.R.O. Wildl. Res.*, 3: 71–114.
- MAYR, E., 1969.—*Principles of systematic zoology*. New York: McGraw-Hill.
- RIDE, W. D. L., 1970.—*A guide to the native mammals of Australia*. Melbourne: Oxford University Press.
- TROUSSERT, E. L., 1893.—Notes sur les les sarcoptides pilicoles (Listrophorinae). *C. r. Séanc. Soc. Biol.*, (9)5: 698–700.
- , 1917.—Troisième note sur les sarcoptides pilicoles et description de genres-nouveaux. *Bull. Soc. zool. Fr.*, 42: 151–158.
- WAKEFIELD, N. A., and WARNEKE, R. M., 1967.—Some revision in *Antechinus* (Marsupialia)—2. *Victorian Nat.*, 84: 69–99.

STUDIES IN THE ECOLOGY OF COASTAL HEATH IN NEW SOUTH WALES. II. THE EFFECTS OF WATER SUPPLY AND PHOSPHORUS UPTAKE ON THE GROWTH OF *BANKSIA SERRATIFOLIA*, *B. ASPLENIIFOLIA* AND *B. ERICIFOLIA*

M. Y. SIDDIQI\* AND R. C. CAROLIN†

[Accepted for publication 17th December 1975]

*Synopsis*

An experimental study of *Banksia serratifolia*, *B. aspleniifolia* and *B. ericifolia* was carried out to evaluate the hypotheses and conclusions drawn from the field analysis results, as reported in Siddiqi *et al.* (1972).

In a soil (texture) and water interaction experiment, the growth of these species was shown to be related to moisture level. However, it is probable that the development of proteoid roots depends on a combination of moisture level and aeration of top soil. All the three species were shown to differ in their tolerance ranges to the various combinations of these factors.

Absorption of  $P^{32}$  by intact proteoid and non-proteoid roots and its subsequent translocation to shoots were investigated. In *B. serratifolia* and *B. aspleniifolia*, proteoid roots were shown to absorb considerably more  $P^{32}$  than the non-proteoid roots, whereas in *B. ericifolia* there was no significant difference between the two types of roots.

INTRODUCTION

Siddiqi *et al.* (1972) have employed quantitative methods to demonstrate that various heathland communities on the central coast of New South Wales can be classified in relation to large-scale differentiation of regional climate, the physical characteristics of associated soils and variations in modal water tables. Within this broad framework of regional variation, Siddiqi (1971) has employed conventional pattern analysis to demonstrate the existence of smaller-scale vegetation mosaics which can be classified by the relative distribution and abundance of "indicator" shrub species such as *Banksia serratifolia*, *B. aspleniifolia* and *B. ericifolia*. This latter work suggests that the relative distribution of these species in the ecotones between the units of these small-scale mosaics may be due in part to the outcome of competitive interactions between the species concerned. Because of the uncontrolled nature of the field situation, and the strong probability that field experiments are likely to be confounded by the added complexity of fire, we have examined this hypothesis by way of laboratory experiments.

This paper reports two experiments designed to investigate the comparative growth responses of these three Banksias to variations in soil texture and water availability; and to examine one possible role of proteoid roots as they may affect the interactions between these species.

EXPERIMENT 1

EFFECTS OF SOIL TEXTURE AND WATER INTERACTION ON THE GROWTH OF *B. SERRATIFOLIA*, *B. ASPLENIIFOLIA* AND *B. ERICIFOLIA*

This experiment was designed to investigate the effects of four soils of differing textures and four water regimes, combined factorially to give 16 treatments, on the growth of *B. serratifolia*, *B. aspleniifolia* and *B. ericifolia*.

---

\* School of Biological Sciences, University of Sydney, New South Wales, 2006. Present Address: Botany Department, University of Dar es Salaam, Dar es Salaam, Tanzania.

† School of Biological Sciences, University of Sydney, New South Wales, 2006.

---

*Materials and Methods*

Sandy soil and clay soil were collected from a sub-surface profile at Mourawaring Moor, air dried, ground, and sieved through a 2 mm mesh. Apart from the sand and clay, two further synthetic soils were produced, containing 60 : 40 and 40 : 60 proportions by volume of sandy and clayey soils respectively. Thus, in all, four soils were used in the experiment, each pot in the experiment being filled with 700 cc of the appropriate soil. The soils were analysed for a moisture factor (M.F.), exchangeable sodium, potassium, calcium, magnesium, available phosphorus and total nitrogen.

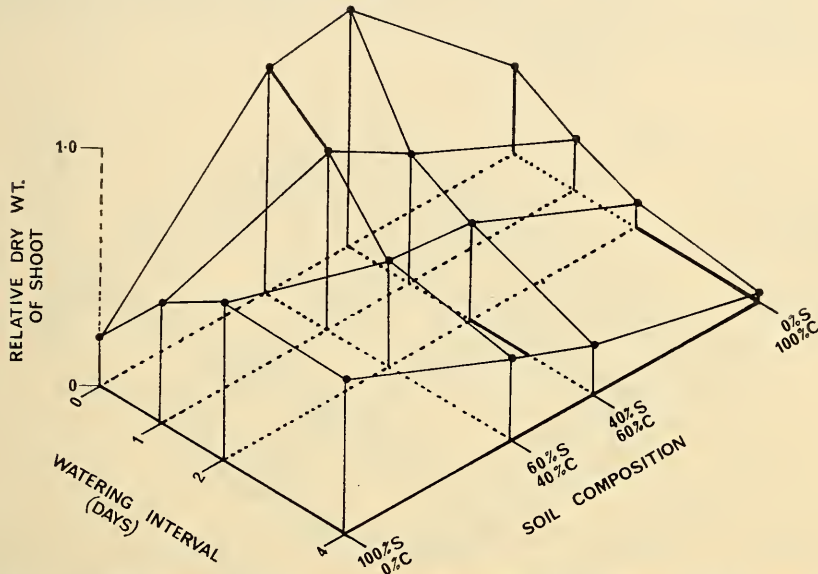

Fig. 1. *Banksia serratifolia*: relative dry weight of shoots of seedlings in a range of soils of varying texture and watering regimes.

Means of dry weight (g) with least significant differences at  $p=0.05$  (l.s.d.) and variance ratios (F) from analyses of variance (anovar). [Variance ratios (F) each with degrees of freedom 3, 8; each significant at  $p < 0.001$ ].

Soil composition (% sand/% clay)	Watering interval (days)				l.s.d.	F
	0	1	2	4		
100/0	0.616	1.433 (0.359)	1.872 (0.620)	1.906	0.429	20.86
60/40	2.512	2.253 (0.808)	1.331 (0.286)	0.997	0.496	22.66
40/60	2.810	1.483 (0.391)	1.204 (0.184)	0.601	0.263	133.42
0/100	1.055 [1.026]	0.616 (-0.485) [0.785]	0.289 (-1.241) [0.538]	0.084 [0.284]	— [0.098]	— 113.29*
l.s.d.	0.559	— (0.157)	— (0.154)	0.217		
F	39.35	127.51†	305.15†	133.59		

\* Square root transformation of data before anovar; means and l.s.d. for square root values in square brackets.

† Natural logarithm transformation of data before anovar; means and l.s.d. for  $\log_e$  values in rounded brackets.

The four watering treatments used comprised daily watering, watering on alternate days, watering every two days, and watering every four days (see 0, 1, 2, 4, on Watering Interval (Days) scale, respectively, in Figs 1-9). A constant amount of 200 ml of tap water was supplied to each pot—28.5% volume by volume for all soils. The pots were standard 5" diameter and were filled to within approx. 2.5 cm below the top. They were arranged in randomised blocks and re-randomised at four-week intervals.

The seeds were germinated on filter pads in the laboratory and two-week old seedlings matched for even size were transplanted one to each pot, then placed in a glasshouse. Watering treatments were imposed after the first post-cotyledonary leaf had emerged.

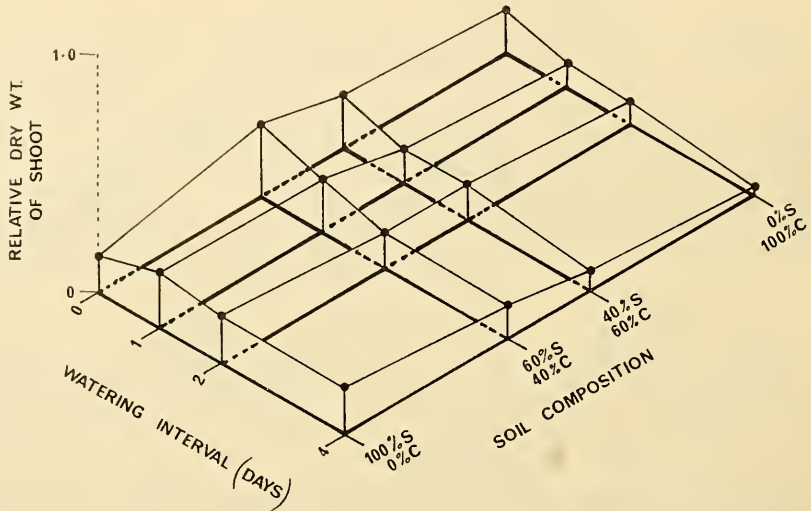

Fig. 2. *Banksia asplenifolia*: relative dry weight of shoots of seedlings in a range of soils of varying texture and watering regimes.

Means of dry weight (g) with least significant differences at  $p=0.05$  (l.s.d.) and variance ratios (F) from analyses of variance (anovar). [Variance ratios (F) each with degrees of freedom 3, 8; \*\*\*, significant at  $p<0.001$ ; n.s., not significant].

Soil composition (% sand/% clay)	Watering interval (days)				l.s.d.	F
	0	1	2	4		
100/0	0.447	0.628	0.579	0.546 (-0.620)	0.147	2.88 n.s.
60/40	0.881	0.687	0.425	0.375 (-0.988)	0.107	51.48***
40/60	0.618	0.400	0.397	0.225 (-1.506)	0.065	64.86***
0/100	0.522	0.300	0.268	0.069 (-2.670)	0.058	107.02***
l.s.d.	0.120	0.094	0.024	—		
F	26.36***	40.82***	305.35***	(0.308) 89.45***†		

† Natural logarithm transformation of data before anovar; means and l.s.d. for  $\log_e$  values in brackets.



## Results

The plants were harvested 14 weeks after the start of the various watering treatments. Proteoid roots were separated from the main root system; these and other plant fractions were oven-dried at 80°C for 72 hours. The results are presented in Figs 1-9 on the following measures: (a) dry weight of shoot; (b) dry weight of roots (proteoid + non-proteoid); (c) dry weight of proteoid roots.

Significant variance heterogeneity, as detected by Bartlett's test, precluded use of analysis of variance in the full table of data for each characteristic measured. However, in subsets of watering intervals within soils and species, or of soils

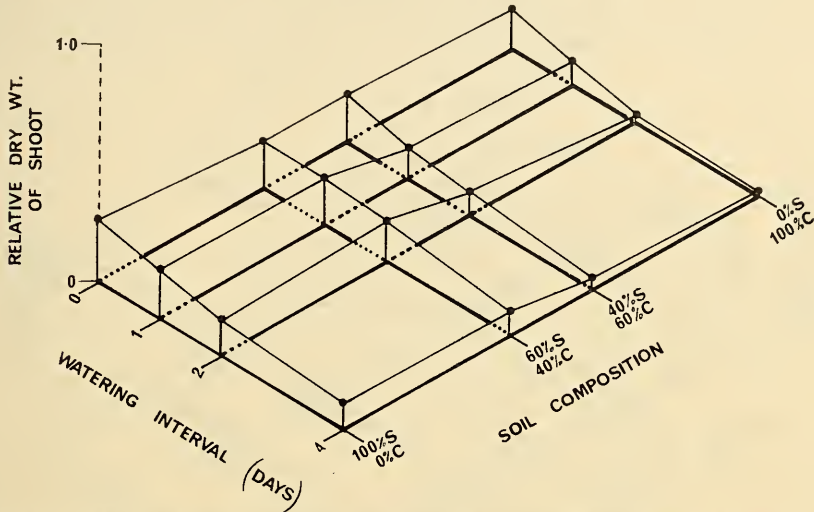

Fig. 3. *Banksia ericifolia*: relative dry weight of shoots of seedlings in a range of soils of varying texture and watering regimes.

Means of dry weight (g) with least significant differences at  $p=0.05$  (l.s.d.) and variance ratios (F) from analyses of variance (anovar). [Variance ratios (F) each with degrees of freedom 3, 8; \*\*\*, significant at  $p<0.001$ ; \*\*, significant at  $p=0.01-0.001$ ].

Soil composition (% sand/% clay)	Watering interval (days)				l.s.d.	F
	0	1	2	4		
100/0	0.809	0.608	0.435	0.319	0.112	38.87***
60/40	0.577	0.570	0.508	0.324	0.079	23.86***
40/60	0.577	0.391	0.325	0.193	0.104	25.18***
0/100	0.526	0.258	0.095	0.041	—	—
	(-0.647)	(-1.456)	(-2.366)	(-3.219)	(0.612)	35.16***†
l.s.d.	0.140	0.154	0.043	0.059		
F	8.70**	11.90**	190.08***	55.16***		

† Natural logarithm transformation of data before anovar; means and l.s.d. for  $\log_e$  values in brackets.

within watering intervals and species, the data showed homogeneity of variance either in the untransformed or in log or square root transformed state, and were tested for significant effects in these two types of subset using where necessary a log or square root transformation. The significance of these comparisons is indicated in the legends to Figs 1-9.

In order that a graphical comparison between the species may be made, the highest values obtained for any one of the three species for a given fraction

(shoot or total root) has been taken as unity and the remaining values calculated proportionately. These relative values are used as a basis for comparison in Figs 1-9.

### Discussion

The results as shown in Figs 1-9 clearly show that *B. serratifolia* grows very well in sand and clay mixtures and to lesser extent in clay soil in monocultures under conditions of freely available moisture—soil environments in which this

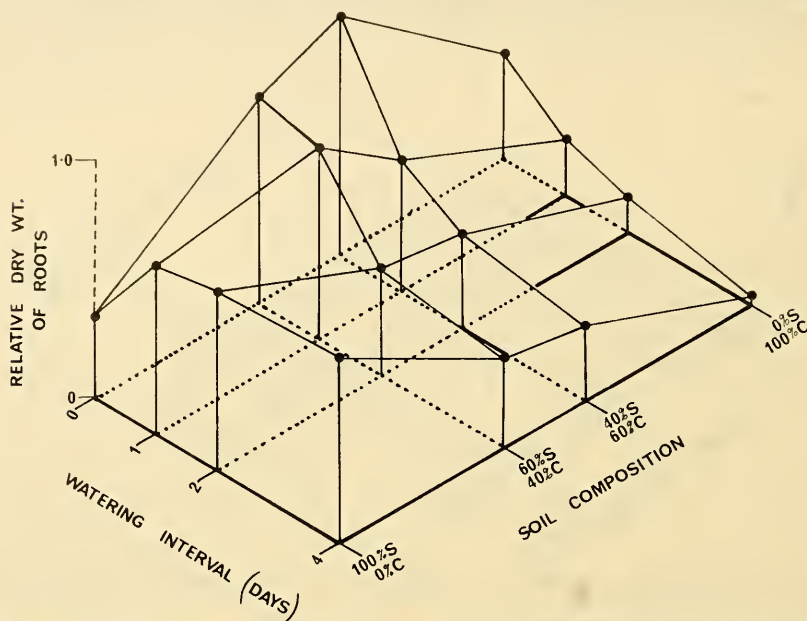

Fig. 4. *Banksia serratifolia*: relative dry weight of roots of seedlings in a range of soils of varying texture and watering regimes.

Means of dry weight (g) with least significant differences at  $p=0.05$  (l.s.d.) and variance ratios (F) from analyses of variance. [Variance ratios (F) each with degrees of freedom 3, 8; \*\*\*, significant at  $p < 0.001$ ; \*\*, significant at  $p = 0.01-0.001$ ].

Soil composition (% sand/% clay)	Watering interval (days)				l.s.d.	F
	0	1	2	4		
100/0	0.292	0.585	0.636	0.662	0.190	8.64**
60/40	0.746	0.681	0.387	0.326	0.096	50.16***
40/60	0.847	0.457	0.353	0.252	0.088	92.65***
0/100	0.393	0.197	0.124	0.024	0.048	111.48***
l.s.d.	0.187	0.091	0.085	0.070		
F	21.93***	56.87***	64.85***	151.13***		

species does not normally occur naturally. Beadle (1962) has reported a similar growth behaviour for *Acacia suaveolens*, another frequent sand heath species, and suggest that its total absence from clayey soils in the field is due to its inability to compete with the more aggressive species of that habitat. Our results, in agreement with those of Beadle, suggest that the total elimination of *B. serratifolia* from clayey soils in the field may be determined primarily by an interspecific competition factor.

It seems highly significant that *B. serratifolia* fails to develop proteoid roots in the sand and clay mixtures and clay soil (Fig. 8) even when the overall growth is maximum (Figs 1, 4). *B. aspleniifolia* and *B. ericifolia*, however, produce significant amounts of proteoid roots in these treatments (Figs 8, 9).

Jeffrey (1967) has shown that in *Banksia ornata* and *B. serrata* the proteoid roots are much more active in the absorption of phosphorus than their non-proteoid counterparts and points out that these special roots may be very important in competition. Groves (1964) and Jeffrey (1967) have suggested that proteoid roots are produced in response to low phosphorus levels in the surrounding medium. In the present case, however, this does not seem to be so. The value of available phosphorus in sandy soil (7 ppm) is significantly higher than those of sand and clay mixtures (3–5 ppm) and pure clay soil (1 ppm).

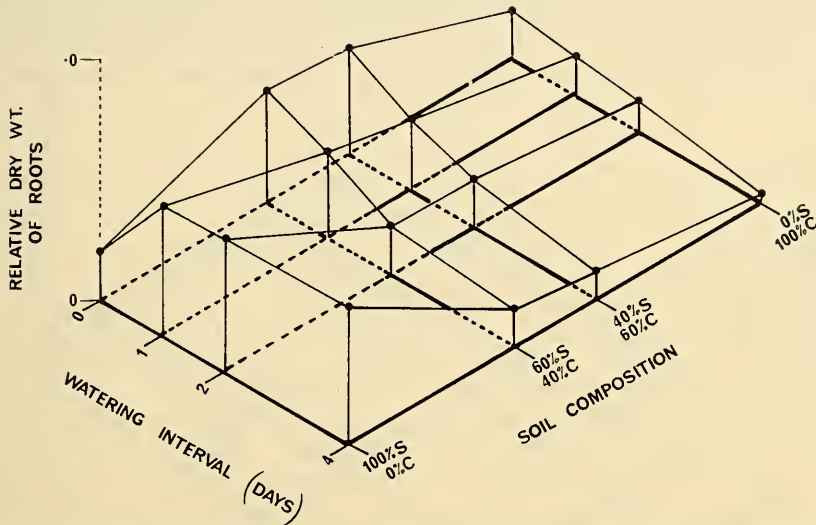

Fig. 5. *Banksia aspleniifolia*: relative dry weight of roots of seedlings in a range of soils of varying texture and watering regimes.

Means of dry weight (g) with least significant differences at  $p=0.05$  (l.s.d.) and variance ratios (F) from analyses of variance (anovar). [Variance ratios (F) each with degrees of freedom 3, 8; each significant at  $p<0.001$ ].

Soil composition (% sand/% clay)	Watering interval (days)				l.s.d.	F
	0	1	2	4		
100/0	0.161	0.456	0.464	0.485	0.097	26.83
60/40	0.409	0.325	0.161	(-0.736) 0.149	0.053	60.24
40/60	0.375	0.263	0.165	(-1.903) 0.105	0.044	76.85
0/100	0.164	0.144	0.104	(-2.266) 0.026 (-3.647)	0.036	29.95
l.s.d.	0.054	0.056	0.035	—		
F	64.35	56.49	236.46	(0.292) 179.77†		

† Natural logarithm transformation of data before anovar; means and l.s.d. for  $\log_e$  values in brackets.

Alternatively, two hypotheses are available for consideration :

(1) That the higher levels of exchangeable sodium, potassium and magnesium and total nitrogen in sand and clay mixtures and pure clay are responsible for the absence of proteoid roots in *B. serratifolia* ;

(2) That the poor aeration of sand and clay mixtures and pure clayey soil is mainly responsible for the failure of *B. serratifolia* to develop proteoid roots.

Lamont (1972) provides data for *Hakea prostrata* showing that although at lower nitrogen levels proteoid root production increases with increasing nitrogen, above a certain level of nitrogen it decreases. Unfortunately, Lamont's values are not comparable with those in the present paper since they are given in millimoles per litre of solution applied.

Whilst accepting the possibility that nutrient levels can influence proteoid root production of the *Banksia* species discussed here, the aeration factor may be more important since even in pure sandy soil, both in the glasshouse and field, the proteoid roots are developed almost entirely in the top 15 cm of soil, the layer with maximum aeration. This is further substantiated by an observation

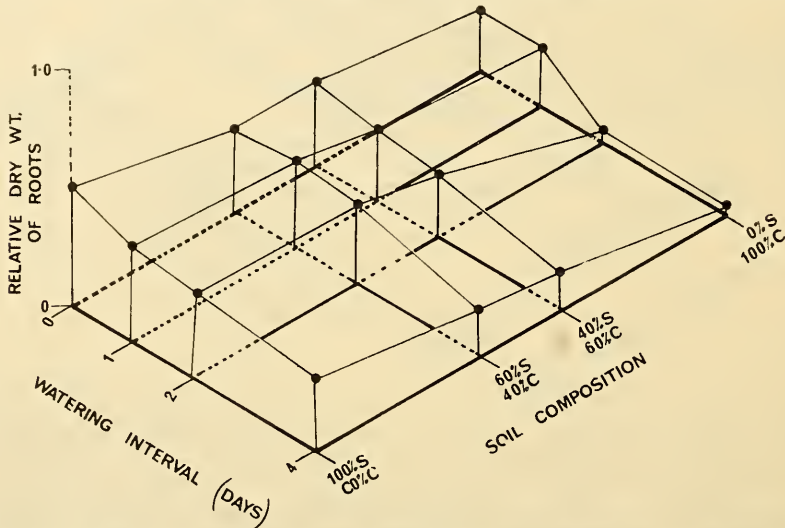

Fig. 6. *Banksia ericifolia*: relative dry weight of roots of seedlings in a range of soils of varying texture and watering regimes.

Means of dry weight (g) with least significant differences at  $p=0.05$  (l.s.d.) and variance ratios (F) from analyses of variance (anovar). [Variance ratios (F) each with degrees of freedom 3, 8; \*\*\*, significant at  $p < 0.001$ ; \*\*, significant at  $p = 0.01-0.001$ ; \*, significant at  $p = 0.05-0.01$ ].

Soil composition (% sand/% clay)	Watering interval (days)				l.s.d.	F
	0	1	2	4		
100/0	0.425	0.417	0.316	0.268	0.105	5.74*
60/40	0.300	0.323	0.312	0.181	0.062	12.10**
40/60	0.308	0.250	0.235	0.151	0.044	22.49***
0/100	0.214 (-1.546)	0.212 (-1.617)	0.055 (-2.903)	0.026 (-3.672)	— (0.503)	— 44.97***†
l.s.d.	0.082	0.123	0.042	0.026		
F	12.04**	5.71*	89.78***	155.23***		

† Natural logarithm transformation of data before anovar; means and l.s.d. for  $\log_e$  values in brackets.

in the glasshouse, where, in some trial pots which were not sealed below, the roots projected through the bottom holes and produced proteoid roots outside. Jeffrey (1967) has also mentioned a similar observation. Moreover, the levels of nutrients in sand and clay mixtures are similar to those of vegetated sandy soil where this species occurs naturally and produces proteoid roots very profusely (Siddiqi, 1971).

It seems reasonable, then, to suggest that in sand and clay mixtures and in pure clay, poor aeration may be responsible for the failure of *B. serratifolia* to develop proteoid roots under adequate moisture conditions. Under conditions of improved aeration in these soils, moisture becomes the limiting factor and the soils become too hard to penetrate, especially by the young rootless and proteoid roots. Flocker *et al.* (1959) and Pearson (1966) similarly suggest that in moist compact soils it is the poor aeration which hampers root growth, since, as the soil becomes dry and aeration improves, the mechanical conditions in soil become limiting to root growth.

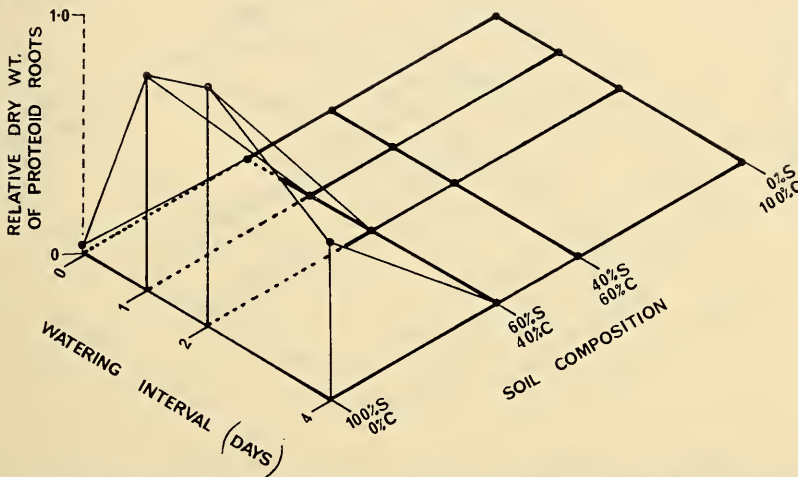

Fig. 7. *Banksia serratifolia*: relative dry weight of proteoid roots of seedlings in a range of soils of varying texture and watering regimes.

Means of dry weight (g) in 100% sand with least significant difference at  $p=0.05$  (l.s.d.) and variance ratio (F) from analysis of variance with degrees of freedom 3, 8, significant at  $p<0.001$ . No proteoid roots were formed in other soils.

Watering interval (days)				l.s.d.	F
0	1	2	4		
0.010	0.382	0.427	0.279	0.070	75.364

A reduction in the amount of proteoid roots in pure sandy soil under the driest treatment in *B. serratifolia* (Fig. 7) may be attributed to water deficiency, to the possible increase in temperatures of the top layer due to moisture deficiency, or to a combination of both.

Under the moisture conditions applied, *B. asplenifolia* and *B. ericifolia* both produce proteoid roots in sand and clay mixtures and in clay but proportionately less than in sand. While a similar effect of soil and water interaction is shown in sand and clay mixtures and in clay in both these species, *B. ericifolia* in sandy soil produces maximum weight of proteoid roots in the wettest treatment, whereas *B. asplenifolia* shows maximum development in the three drier treatments

(Figs 8, 9). This implies that the development of proteoid roots in these species is controlled by a combination of moisture level and optimum aeration of the top soil. In addition it seems that all three species differ in their tolerance ranges and in the level of optimal combination of these factors.

That *B. asplenifolia* is absent from deep sandy ridges in high rainfall regions, dominated by *B. serratifolia*, indicates a possible competition factor in its distribution (Siddiqi, 1971) since it is shown above that *Banksia asplenifolia* grows well without competition in well-watered sand. Our results also indicate the probable importance of proteoid roots in any interaction of species, for there is a reduction in the amount of proteoid roots in *B. serratifolia*, with no corresponding decrease in the case of *B. asplenifolia*, in the driest sand treatment. In this treatment the amount of proteoid roots per plant tends to be equal in the two species, whereas in the intermediate treatment the proportional

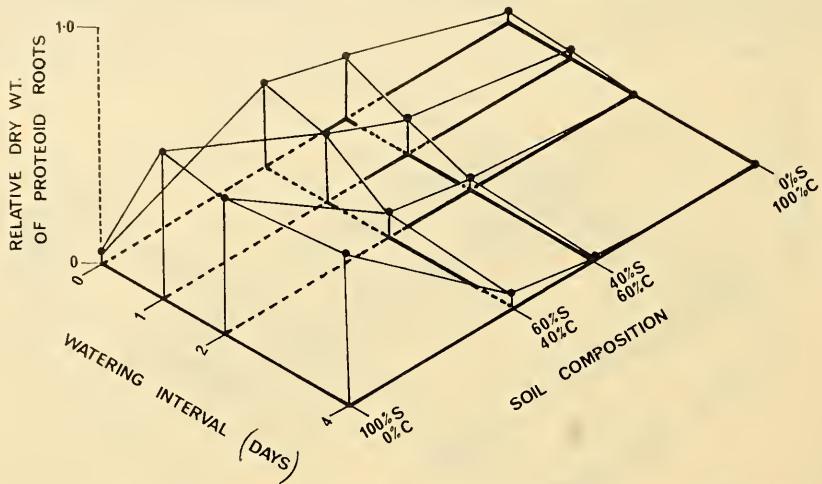

Fig. 8. *Banksia asplenifolia*: relative dry weight of proteoid roots of seedlings in a range of soils of varying texture and watering regimes.

Means of dry weight (g) with least significant differences at  $p=0.05$  (l.s.d.) and variance ratios (F) [\*\*, significant at  $p=0.01-0.001$ ; \*\*\*, significant at  $p<0.001$ ] from analyses of variance (anovar).

Soil composition (% sand/% clay)	Watering interval (days)				l.s.d.	F
	0	1	2	4		
100/0	0.017 (-4.120)	0.267 (-1.324)	0.251 (-1.382)	0.271 (-1.318)	—	—
60/40	0.159	0.127	0.050	0.032 (-3.446)	0.021	92.90*** <sup>†</sup>
40/60	0.123	0.070	0.028	0.007 (-4.924)	0.018	85.42*** <sup>†</sup>
0/100	0.020	0.009	0	0	0.004	41.78*** <sup>†</sup>
l.s.d.	0.019	0.027	0.014	—		
F	156.13*** <sup>†</sup>	181.09*** <sup>†</sup>	934.33*** <sup>†</sup>	392.76*** <sup>†</sup> <sup>‡</sup>		

<sup>†</sup> Natural logarithm transformation of data before anovar; means and l.s.d. for  $\log_e$  values in brackets.

<sup>‡</sup> F values with degrees of freedom 3, 8.

<sup>‡</sup> Anovar only includes daily and alternate day watering, F value with degrees of freedom 1, 4.

<sup>‡</sup> Anovar only includes the first three types of soil, F values with degrees of freedom 2, 6.

amount produced by *B. serratifolia* is higher than that of *B. aspleniifolia*. Towards the wettest treatment the amount again tends to be equal. This agrees with direct field observations: *B. serratifolia* and *B. aspleniifolia* occur in mixed stands at the two extremes, that is in very wet situations (e.g. towards the gully at Mourawaring Point and at Myall Lakes) and in relatively dry situations (e.g. Agnes Banks); *B. aspleniifolia* is eliminated from the intermediate situation (Siddiqi, 1971). We suggest then, that *B. serratifolia* outcompetes *B. aspleniifolia* at the sites where it produces a maximum amount of proteoid roots, whereas these species grow together in a mixed stand at the two extremes of water availability in sand heath due to the amounts of proteoid roots produced being similar in both the species.

The results clearly show that, although proteoid roots may be extremely important in determining competitive ability, there is no relationship between the amount of proteoid roots produced and overall performance of the plants.

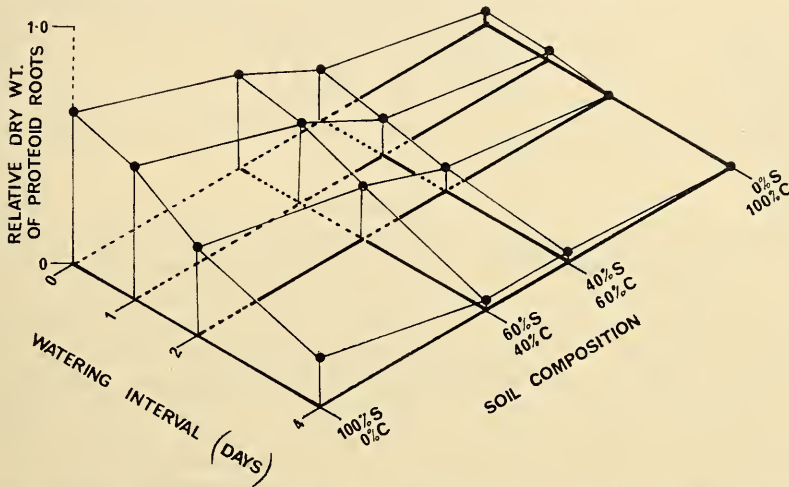

Fig. 9. *Banksia ericifolia*: relative dry weight of proteoid roots of seedlings in a range of soils of varying texture and watering regimes.

Means of dry weight (g) with least significant differences at  $p=0.05$  and variance ratios (F) [\*\*\*, significant at  $p<0.001$ ; n.s., not significant] from analyses of variance (anovar).

Soil composition (% sand/% clay)	Watering interval (days)				l.s.d.	F
	0	1	2	4		
100/0	0.269 (-1.324)	0.248	0.165	0.093 (-2.401)	0.059	20.22***1
60/40	0.167 (-1.792)	0.146	0.100	0.029 (-3.556)	0.020	98.75***1
40/60	0.094 (-2.370)	0.073	0.050	0.020 (-3.899)	0.011	88.53***1
0/100	0.029 (-3.549)	0.019	0	0	0.014	4.20 n.s. <sup>2</sup>
l.s.d.	— (0.237)	0.038	0.015	— (0.340)		
F	175.03***†1	72.13***1	167.04***3	63.86***†3		

† Natural logarithm transformation of data before anovar; means and l.s.d. for  $\log_e$  values brackets.

<sup>1</sup> F values with degrees of freedom 3, 8.

<sup>2</sup> Anovar only includes daily and alternate day watering, F value with degrees of freedom 1, 4.

<sup>3</sup> Anovar only includes the first three types of soil, F values with degrees of freedom 2, 6.

Both *B. serratifolia* and *B. asplenifolia* show a better performance in terms of total dry weight in sand and clay mixtures under adequate moisture conditions. Beadle (1962) has obtained similar results for *Acacia suaveolens*, which, however, is different in that it forms root nodules which may complicate the issue. It seems that the increased growth in soils of higher clay content may be primarily associated with their generally higher nutrient status (see Table 1).

TABLE 1  
Analysis data of soils used in Experiment no. 1

Soil composition by volume	M.F. (%) (Metson, 1956)	Exchangeable				Available P (ppm) (Fogg and Wilkinson, 1958)	Total N (%) (Piper, 1950)
		Na	K (m-equiv. %) (Tucker, 1960)	Ca	Mg		
100% S : 0% C	0.07	0.41	0.11	0.75	0.25	7	0.020
60% S : 40% C	0.64	0.50	0.13	0.76	0.76	5	0.045
40% S : 60% C	1.01	0.76	0.29	0.76	1.26	3	0.053
0% S : 100% C	2.04	0.83	0.36	0.51	2.04	1	0.104

S = sandy soil from Mourawaring site.  
C = clay soil.

## EXPERIMENT 2

### ABSORPTION OF P<sup>32</sup> BY PROTEOID ROOTS AND NON-PROTEOID ROOTS AND ITS TRANSPORT TO LEAVES IN A 24-HOUR UPTAKE PERIOD IN BANKSIA SERRATIFOLIA, B. ASPLENIIFOLIA AND B. ERICIFOLIA

Engler (1889) was probably the first to realise the importance of proteoid roots in the absorption of nutrients as is evident in his reference to these structures as "absorption hairs". Subsequently there has been general agreement about the function of proteoid roots in the absorption of nutrients, particularly phosphorus (Purnell, 1960; Groves, 1964; Jeffrey, 1967). Jeffrey (1967) has demonstrated that the excised proteoid roots of *Banksia ornata* and *B. serrata* absorb significantly more phosphorus than their non-proteoid counterparts.

The results from Experiment 1 indicated that proteoid roots are important in determining the competitive abilities of the three *Banksia* species used and that these species differ in their overall tolerance ranges. The results also served to indicate the levels of certain environmental factors affecting the relative yield of proteoid roots in them.

The second experiment was set up to investigate the absorption of phosphorus into intact proteoid and non-proteoid roots and its subsequent translocation to the aerial parts of the plant.

### Materials and Methods

Seedlings of *Banksia serratifolia*, *B. asplenifolia* and *B. ericifolia* were raised in sand in the glasshouse under conditions suitable for the development of proteoid roots. The seedlings were removed from sand after 24 weeks growth, when all plants were showing well developed proteoid roots. The roots were thoroughly washed free of sand with tap water and then washed twice with distilled water for 30-minute and 10-minute periods respectively.

The plants of each species were divided into two sets and treated thus:

Set 1. All root systems left intact. Non-proteoid roots from this set are designated NPR 1 and proteoid roots PR 1.

Set 2. Proteoid roots removed. Non-proteoid roots from this set are designated NPR 2.



The plants of both sets were then placed in 1/10 Hoagland solution minus phosphorus for one hour and subsequently transferred to 6" diameter sealed pots (1.5 litre capacity) containing 1/10 Hoagland solution with 1 ppm phosphorus as orthophosphate. These solutions were then labelled with 7.5  $\mu\text{C}$   $\text{P}^{32}$  prior to a 24-hour uptake period during which the solutions were aerated continuously. Uptake was terminated by transferring the plants to distilled water. The roots were washed with distilled water four times (10 minutes each). The experimental procedure adopted here was essentially that employed by Jeffrey (1967).

Shoots, proteoid roots and non-proteoid roots were separated and oven-dried at 80°C. The dried samples were digested in a mixture of sulphuric acid, perchloric acid and nitric acid (Piper, 1950) and total  $\text{P}^{32}$  determined by liquid scintillation counting.

TABLE 2

*Absorption of  $\text{P}^{32}$  by proteoid roots (PR) and non-proteoid roots (NPR) and its subsequent translocation in 24-hour uptake periods in Banksia species*

Species	Shoots, set 1 (dpm/mg)	PR 1 (dpm/mg)	NPR 1 (dpm/mg)	NPR 2 (dpm/mg)	NPR 1		Shoots
					PR 1 (%)	PR 1+NPR 1	PR 1+NPR 1 (%)
<i>B. asplenifolia</i>	10.6	1864.0	825.5	1069.0	44.28	2689.5	0.394
<i>B. serratifolia</i>	3.9	843.2	494.5	417.2	58.65	1337.7	0.292
<i>B. ericifolia</i>	124.3	1223.5	1315.2	1395.5	107.50	2538.7	4.896

TABLE 3

*Comparison of the means in Table 2*

	t	p
<i>Banksia serratifolia</i>		
PR 1/NPR 1	7.96	0.02-0.01
PR 1/NPR 2	8.23	0.02-0.01
NPR 1/NPR 2		n.s.
<i>Banksia asplenifolia</i>		
PR 1/NPR 1	10.37	<0.01
PR 1/NPR 2	7.68	0.02-0.01
NPR 1/NPR 2	9.05	0.02-0.01
<i>Banksia ericifolia</i>		
PR 1/NPR 1		n.s.
PR 1/NPR 2		n.s.
NPR 1/NPR 2		n.s.

n.s. = not significant

### Results

The results, from two replicates, expressed as mean disintegrations per minute (dpm) per mg dry weight of the respective plant fraction, are presented in Table 2. Table 3 shows the results of comparing the means in Table 2. It can readily be seen that the removal of proteoid roots has little effect on absorption by non-proteoid roots. Total root absorption is assessed by adding PR 1 and NPR 1 and the translocation by the relative percentage of dpm/mg in shoot material to that in total roots. The relative efficiency in  $\text{P}^{32}$  absorption of PR and NPR is indicated by the ratio of NPR 1 : PR 1 %.

### Discussion

It is interesting to note that the differential behaviour of proteoid roots and non-proteoid roots in the absorption of  $P^{32}$  places the species into two distinct groups :

- (1) *B. serratifolia* and *B. aspleniifolia* group, with the proteoid roots showing substantially higher absorption than the non-proteoid roots.
- (2) *B. ericifolia* group, with no appreciable difference in the absorption of  $P^{32}$  by the two types of roots.

The relevance of this distinction becomes apparent when their distribution in the field is considered. It is evident that *B. ericifolia* would be equally effective in exploiting the soil for nutrients, especially phosphorus, in an environment which is unfavourable for the development of proteoid roots, e.g. most clayey soils, and at the same time deficient in available phosphorus, as is the case in the usual habitat of this species. Jeffrey (1967) has shown in *B. ornata* that although proteoid roots are more efficient in the absorption of phosphorus, both types of roots are capable of polyphosphate synthesis. He suggests that the increased uptake by proteoid roots is due to their greater surface/volume (dry weight) ratio. It may well be that the surface/volume ratio of non-proteoid roots in *B. ericifolia* has been improved (possibly by the presence of persistent hairs).

It has been demonstrated in Experiment 1 that, whereas proteoid roots may be extremely important in determining competitive power, these structures bear little relationship to the performance of plants. Williams and Barber (1961) have argued that if a structure is more developed than would be appropriate for the function it is said to perform, a second hypothesis is needed to explain the excess of structures over function. A critical evaluation shows that the proteoid roots appear to perform three functions :

- (1) They occupy and exploit a greater area of soil near the surface. Jeffrey (1967) noted that in *B. ornata* the proteoid root carpet was continuous when the bushes were 2-3 metres apart and that a *B. serrata* tree with 250 sq ft (c. 23 m<sup>2</sup>) of canopy produced a proteoid roots carpet of 5,000 sq ft (c. 465 m<sup>2</sup>). Seedlings of the latter species with 1.75 sq ft (c. 0.16 m<sup>2</sup>) canopy had a carpet of 11.5 sq ft (c. 1 m<sup>2</sup>).
- (2) They form an effective barrier against leaching near the soil surface and trap nutrients from a number of sources.
- (3) They efficiently absorb nutrients, especially phosphorus, and store the excessive amount (Groves, 1964 ; Jeffrey, 1967).

It has been indicated that the development of proteoid roots is favoured by maximum aeration within the critical limits of moisture availability (Experiment 1). At least in the present case, a maximum aeration would be correlated with strong leaching of the soil, e.g. in deep sandy ridges. On the other hand, poor aeration, which affects the development of proteoid roots adversely, would coincide with less leaching. It seems, then, that the proteoid roots serve to reduce leaching, a constant hazard in these nutrient-poor soils. Their development is triggered by a factor (aeration) which is associated with leaching.

*B. serratifolia* invariably occurs on well aerated sandy soils which could be subjected to strong leaching unless the nutrient status is maintained by some biological mechanism. *B. ericifolia*, on the other hand, occurs mostly at the sites with relatively poor aeration, a situation which would be coincidental with little leaching. Such a situation, in fact, causes a significant reduction in the development of proteoid roots. But at the same time a greater area of soil for exploitation and effective absorption (the other two so-called secondary functions of

proteoid roots) is maintained by a significant improvement in the capacity of non-proteoid roots to absorb phosphorus (comparable to that of proteoid roots in quantitative terms).

*B. aspleniifolia*, which shows behaviour of proteoid and non-proteoid roots similar to that of *B. serratifolia* (Table 2), presents an interesting case. The results imply that on the one hand this species would be at a disadvantage against *B. serratifolia* under maximum aeration within the critical limits of moisture availability (seemingly on the gross growth basis)—a situation which seems to correspond to deep sandy ridges in high rainfall regions—but that on the other hand *B. ericifolia* and possibly other species would tend to outcompete this species at sites with poor aeration, e.g. moist clayey soils, at least in the availability of phosphorus.

Similar to the results of Jeffrey (1964), all the species in question show a very low proportion of P<sup>32</sup> translocated to the shoots from roots. Nevertheless *B. ericifolia* shows a substantial increase of such translocation over the other species (Table 2). Jeffrey (1964, 1967) has shown that most of the phosphorus absorbed by the roots in *B. ornata* is stored in the form of polyphosphate within the roots. Groves (1964) has also demonstrated this phenomenon and suggests that, on "demand", polyphosphate is converted into orthophosphate, thereby making itself available.

#### CONCLUDING DISCUSSION

The experimental studies reported in this paper indicate that *B. serratifolia* can grow well in clayey soils under optimum moisture conditions and that its total elimination from a similar habitat in the field is perhaps due to its failure to develop proteoid roots under these conditions of poor aeration, and that this failure seems to reduce the competitive power of this species very considerably (Experiments 1 and 2). Perhaps the same can be said for its absence from moist peaty soils. Loach (1964), Sheikh (1969*a*, 1969*b*) and Sheikh and Rutter (1969) have studied wet heath vegetation in England and similarly suggest that *Erica tetralix* is eliminated from well aerated soils mainly due to competition with *Molinia caerulea*.

Field analysis results suggest that the total exclusion of *B. aspleniifolia* from deep sandy ridges in high rainfall regions is mainly due to its competition with *B. serratifolia* (Siddiqi, 1971). The results of these experimental studies support this conclusion and further suggest that proteoid roots play an important role in this species interaction.

That proteoid roots may be important in competition is further substantiated by the experience of nurserymen with the waratah (*Telopea speciosissima*). When transplanting, they discard all those seedlings which do not show the development of what they regard as fungus "the size of a shilling", maintaining that these seedlings are doomed to failure (Bleakley, 1959). In fact, due to their unusual structure and shape, the proteoid roots have been mistakenly regarded as "fungus" by these nurserymen (Siddiqi, 1971).

The results reported in Experiment 2, together with the conclusions drawn from the field analyses, suggest that *B. ericifolia* would have a considerable advantage over *B. aspleniifolia* in moist clayey soils in the exploitation and effective absorption of nutrients, particularly phosphorus, by virtue of the increased capacity of non-proteoid roots to absorb nutrients. This, together with the height of canopy for exploiting light, confers a considerable advantage on *B. ericifolia* over *B. aspleniifolia* (and possibly some other species).

Thus it seems that some aspects of the structure of these communities in a given environment are determined by the competitive power of the species in that particular environment. We agree with Rutter (1955) when we say that a difference in habitat may have some important direct effects on the normal

growth of a species, but some of the effects may be largely due to changes in the competitive ability of that particular species and of its associates in different habitats.

#### ACKNOWLEDGEMENTS

The authors wish to thank Dr N. S. Scott and Dr P. J. Myerscough for help and criticism. We would particularly like to thank Professor D. J. Anderson for his help. The work reported here was carried out as part of a Ph.D. thesis while one of us (M.Y.S.) was in receipt of a University of Sydney Postgraduate Studentship.

#### References

- BEADLE, N. C. W., 1962.—Soil phosphate and the delimitation of plant communities in Eastern Australia. II. *Ecology*, 43 : 281–288.
- BLEAKLEY, H. G., 1959.—How do waratahs grow? *Aust. Plants*, 1 : 15.
- ENGLER, A., 1889.—In Engler, A. and Prantl, K., *Die natürlichen Pflanzenfamilien*. Band 3, Teil 1. Leipzig : Wilhelm Engelmann. (Cited by Purnell (1960).)
- FLOCKER, W. J., VOMOCIL, J. A., and HOWARD, F. D., 1959.—Some growth responses of tomatoes to soil competition. *Soil Sci. Soc. Am. Proc.*, 23 : 188–191.
- FOGG, D. N., and WILKINSON, N. T., 1958.—The colorimetric determination of phosphorus. *Analyst*, 83 : 406–414.
- GROVES, R. H., 1964.—Experimental studies on heath vegetation. Ph.D. Thesis, University of Melbourne.
- JEFFREY, D. W., 1964.—The formation of polyphosphate in *Banksia ornata*, an Australian heath plant. *Aust. J. Biol. Sci.*, 17 : 845–854.
- , 1967.—Phosphate nutrition of Australian heath plants. I. The importance of proteoid roots in *Banksia* (Proteaceae). *Aust. J. Bot.*, 15 : 403–411.
- LAMONT, B., 1972.—The effect of soil nutrients on the production of proteoid roots by *Hakea* species. *Aust. J. Bot.*, 20 : 27–40.
- LOACH, K., 1964.—Inter-relations between soil nutrients and vegetation in wet heaths. Ph.D. Thesis, University of London. (Cited by Sheikh (1969a).)
- METSON, A. J., 1956.—*Methods of chemical analysis for soil survey samples*. Wellington, N.Z. : DSIR Soil Bureau.
- PEARSON, R. W., 1966.—Soil environment and root development. In Pierre, R. J., Kirkham, D., Pesek, J. and Shaw, R. (eds), *Plant environment and efficient water use*. Wisconsin : American Society of Agronomy and Soil Science Society of America.
- PIPER, C. S., 1950.—*Soil and plant analysis*. Adelaide : University of Adelaide.
- PURNELL, H. M., 1960.—Studies of the family Proteaceae. I. Anatomy and morphology of the roots of some Victorian species. *Aust. J. Bot.*, 8 : 38–50.
- RUTTER, A. J., 1955.—The composition of wet heath vegetation in relation to water table. *J. Ecol.*, 43 : 507–543.
- SHEIKH, K. H., 1969a.—The effects of competition and nutrition on the interrelations of some wet heath plants. *J. Ecol.*, 57 : 89–101.
- , 1969b.—The responses of *Molinia caerulea* and *Erica tetralix* to soil aeration and related factors. III. Effects of different gas concentrations on growth in solution culture and general conclusions. *J. Ecol.*, 58 : 141–154.
- , and RUTTER, A. J., 1969.—The responses of *Molinia caerulea* and *Erica tetralix* to soil aeration and related factors. I. Root distribution in relation to soil porosity. *J. Ecol.*, 57 : 713–726.
- SIDDIQI, M. Y., 1971.—An ecological analysis of coastal heath in New South Wales. Ph.D. Thesis, University of Sydney.
- , CAROLIN, R. C., and ANDERSON, D. J., 1972.—Studies in the ecology of coastal heath in New South Wales. I. Vegetation structure. *Proc. Linn. Soc. N.S.W.*, 97 : 211–224.
- TUCKER, B. M., 1960.—Measurement of ion-exchange properties of soils. *CSIRO Soil Publ.*, 15.
- WILLIAMS, W. T., and BARBER, D. A., 1961.—The functional significance of aerenchyma in plants. *Symp. Soc. Exp. Biol.*, 15 : 132–144.

# STUDIES IN THE ECOLOGY OF COASTAL HEATH IN NEW SOUTH WALES. III. REGROWTH OF VEGETATION AFTER FIRE

M. Y. SIDDIQI,\* R. C. CAROLIN† AND P. J. MYERSCOUGH†

[Accepted for publication 17th December 1975]

## Synopsis

Regrowth of heathland vegetation and changes in nutrient status of its soils were studied at Mourawaring Point over a period of one year, following a fire.

Greatest regrowth occurred in the open sand heath, while in the ground-water heath, regrowth was less as the clay layer became shallower.

All species regenerating from lignotubers showed a rapid regrowth immediately after fire.

Frequent burning was shown to eliminate tall shrub species which regenerate solely from seedlings, e.g. *Banksia ericifolia*, *Hakea teretifolia*, *Casuarina distyla*, but seemed to be essential for the continued survival of herbaceous and low shrub species. Nutrient status of soils showed great variability between apparently similar sites immediately after fire. However, after 12 months these sites showed moderate uniformity and their general nutrient status was similar to that before fire.

## INTRODUCTION

The area under investigation lies in a high fire frequency belt along the central coast of New South Wales and its vegetation is subjected to periodic burning. Consequently, the flora of this region is well adapted to the influence of burning and may be termed as a typical "fire-type vegetation". The most important adaptation in this regard is the ability of most of the species to sprout from aerial, sub-aerial or underground stocks. Physiognomically, the vegetation may be compared with the vegetation of other parts of the world where periodic burning is also an important factor, e.g. the Mediterranean region of Europe, South West Africa, and California (Specht *et al.*, 1958; Specht, 1969*a*, 1969*b*).

Although brief reference may be found frequently in literature to the general effects of fire, there have been few detailed studies of the influence of fire on vegetation in Australia compared with some other parts of the world. Notable amongst such studies in Australia are those of Jarret and Petrie (1929), Beadle (1940), Beadle and Burges (1949), Hatch (1955), Shaw (1957), Specht *et al.* (1958), Evans (1960), Coaldrake (1961), Tothill and Shaw (1968) and Tothill (1969).

During investigations of the distribution of heathland species, a fierce fire occurred in this area in the last week of September 1968, burning virtually every plant in the area. This provided an opportunity to study regeneration patterns of the vegetation and changes in nutrient status of the soils during the year following the fire.

Unfortunately, no quantitative data were collected prior to the fire on the species other than *Banksia serratifolia*, *B. asplenifolia*, *B. ericifolia*, *Casuarina distyla* and *Hakea teretifolia*. However, data on presence or absence of species, collected prior to the fire, are available.

## METHODS

Five grids, each 30 × 30 m, were selected and marked permanently. Each grid, representing a more or less uniform habitat, was sampled by means of 20 randomly placed 2 × 2 m quadrats. The data on cover repetition of living plants, used as a measure of relative performance (Anderson, 1960; Kershaw,

---

\* School of Biological Sciences, University of Sydney, New South Wales, 2006. Present Address: Botany Department, University of Dar es Salaam, Dar es Salaam, Tanzania.

† School of Biological Sciences, University of Sydney, New South Wales, 2006.

1973), were collected from the quadrats on all the species present, using 50 regularly spaced, 2 mm diameter pins per quadrat. The cover repetition scores, total number of contacts recorded on the pins, for each species are pooled for each grid from its 20 quadrats. Also the relative prominence of each species in a habitat was assessed as its percent contribution to the sward (P.C.S.). The P.C.S. is defined as :

$$\frac{\text{No. of hits by a species}}{\text{Total no. of hits by all species}} \times 100 \text{ (cf. Anderson, 1960)}$$

TABLE 1  
*Summary of characteristics of grid areas sampled at Mourawaring Point*

Grid number	Vegetation type	Soil characteristics	Approximate time since last fire before 1968 (years)
I	Ground-water heath	Loamy top soil relatively impermeable clay layer at 25–60 cm deep	5
II	Dry sand heath	Sandy profile with shallow to deep water table	5
III	Ground-water heath	Loamy profile with relatively impermeable clay layer	5
IV	Wet sand heath (with mature <i>Banksia ericifolia</i> , <i>Hakea teretifolia</i> and <i>Casuarina distyla</i> prior to 1968 fire)	Sandy profile with water table 60–150 cm deep	12–15
V	Ground-water heath	Shallow soil with iron-stones at surface and relatively impermeable clay layer 15–25 cm deeper	5

The grids were sampled three times in this way at 4-monthly intervals over a period of one year from the time of burning.

Seven soil samples were collected from each grid immediately after the fire and again one year later. The samples were analysed for the major nutrients, i.e. exchangeable sodium, potassium, calcium, magnesium and available phosphorus and total nitrogen.

#### LOCATION AND CHARACTERISTICS OF SAMPLING GRIDS

A topographic survey of the area was carried out and the grids were mapped. Figure 1 shows the location of grids in relation to height contours. The grid sites were selected to represent the various habitats within the sand heath and the ground-water heath previously indicated by information analysis (Siddiqi *et al.*, 1972). Their vegetation type, soil characteristics and times since the last fire prior to 1968 are shown in Table 1. The difference in fire regime between Grid IV and the other grids has particular importance in interpretation of the results.

#### RESULTS

##### VEGETATION

The grids differed in both floristic changes (Table 2) and patterns of regrowth (Table 3 and Fig. 2) in their vegetation following the fire.

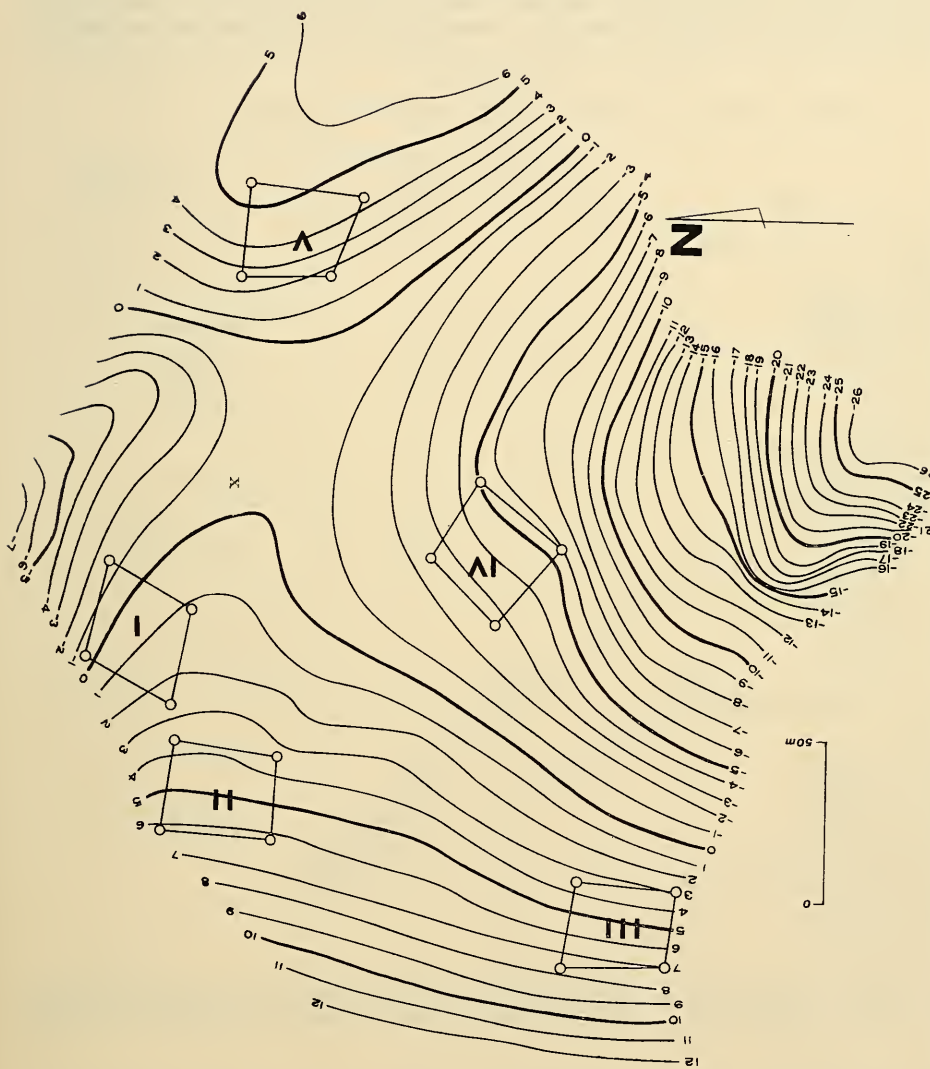

Fig. 1. Topographic map of the area studied at Mourawaring Point showing the position of Grids in relation to contours. Survey datum position (x) map reference 8/431/597. Height contours relative to datum position in metres.

*Floristic Changes* (Table 2)

The most striking floristic change following the fire was the elimination of *Casuarina distyla*, *Banksia ericifolia* and *Hakea teretifolia* from Grids I, II and III and of *B. ericifolia* from Grid V, even though seedlings were abundant prior to the fire. Apart from the pre-fire occurrence of *Hibbertia obtusifolia* in Grid II and the post-fire occurrence of *Schoenus ericetorum* with some abundance in Grid I, other differences in recorded occurrences of species before and after the fire involve species with low relative abundances in the grids, and the chances of their being overlooked in the pre- or post-fire survey cannot be entirely eliminated.

TABLE 2  
*Floristic changes in grid areas at Mourawaring Point following a fire in 1968*

Grid :	Relative abundance *					Main origin of regrowth
	I	II	III	IV	V	
(i) Species not recorded after fire						
<i>Selaginella uliginosa</i> .. .. .	+					? shallow rhizomes
<i>Anisopogon avenaceus</i> .. .. .	vr					?
<i>Casuarina distyla</i> .. .. .	a	la	a			seedlings
<i>Banksia ericifolia</i> .. .. .	a	la	a		a	seedlings
<i>Hakea teretifolia</i> .. .. .	a	la	a			seedlings
<i>Hakea gibbosa</i> .. .. .	i	i	i		r	seedlings
<i>Hakea sericea</i> .. .. .	i	i	i		r	seedlings
<i>Pimelea linifolia</i> .. .. .	vr				vr	?
<i>Lasiopetalum ferrugineum</i> .. .. .	vr				r	?
<i>Dillwynia retorta</i> .. .. .	vr				r	seedlings
<i>Hibbertia obtusifolia</i> .. .. .		f				?
<i>Platysace linearifolia</i> .. .. .			vr			?
<i>Acacia suaveolens</i> .. .. .			vr			seedlings
<i>Aotus ericoides</i> .. .. .			vr			?
<i>Persoonia lanceolata</i> .. .. .					vr	?
<i>Actinotus helianthi</i> .. .. .					r	?
<i>Acacia myrtifolia</i> .. .. .					r	seedlings
<i>Bauera rubioides</i> .. .. .					r	?
<i>Baeckea imbricata</i> .. .. .					r	?
(ii) Species recorded only after fire						
<i>Lepyrodia scariosa</i> .. .. .	vr		vr	r		rhizomes
<i>Schoenus ericetorum</i> .. .. .	f					?
<i>Lomandra longifolia</i> .. .. .	r			r		? rhizomes
<i>Hypolaena fastigiata</i> .. .. .			vr			rhizomes
<i>Lomandra glauca</i> .. .. .				r		? rhizomes
<i>Haemodorum planifolium</i> .. .. .				r		?
<i>Themeda australis</i> .. .. .				i		?
<i>Acacia myrtifolia</i> .. .. .				r		seedlings
<i>Leucopogon esquamatus</i> .. .. .				r		?
<i>Opercularia aspera</i> .. .. .				r		?

\* Relative abundance in species under (i) refers to their abundance before the fire, and in species under (ii) after the fire. +present; vr very rare; a abundant; i infrequent; la locally abundant; f frequent; r rare.

*Patterns of Regrowth* (Table 3 and Fig. 2)

The pattern of regrowth observed in each grid is to a large extent characteristic of its vegetation type before the fire. *Cyathochaeta diandra* is the most abundant species in the earliest stages of regrowth in all three areas of ground-water heath (Grids I, III and V). However, the three areas differ somewhat in other species abundant in regrowth. *Themeda australis* and *Banksia aspleniifolia* each have high abundance in Grid I, while *Lambertia formosa* is relatively abundant in Grid V.



In the area of dry sand heath (Grid II) *Banksia serratifolia* is the most abundant species in the regrowth, followed by *Hypolaena fastigiata*, *Platysace linearifolia*, *Aotus ericoides* and *Hibbertia fasciculata*.

The area of wet sand heath (Grid IV) had been burnt least recently before the fire and was the only area bearing a tall dense scrub of mature bushes of *Banksia ericifolia*, *Casuarina distyla* and *Hakea teretifolia* (Table 1). The fire killed the bushes of these three species and brought about a sharp change in the structure of the vegetation; a number of lower-growing heliotropic species, *Banksia aspleniifolia*, *B. serratifolia*, *Pimelea linifolia*, *Actinotus helianthi*, *Anisopogon avenaceus* and *Hypolaena fastigiata*, rare or suppressed before the

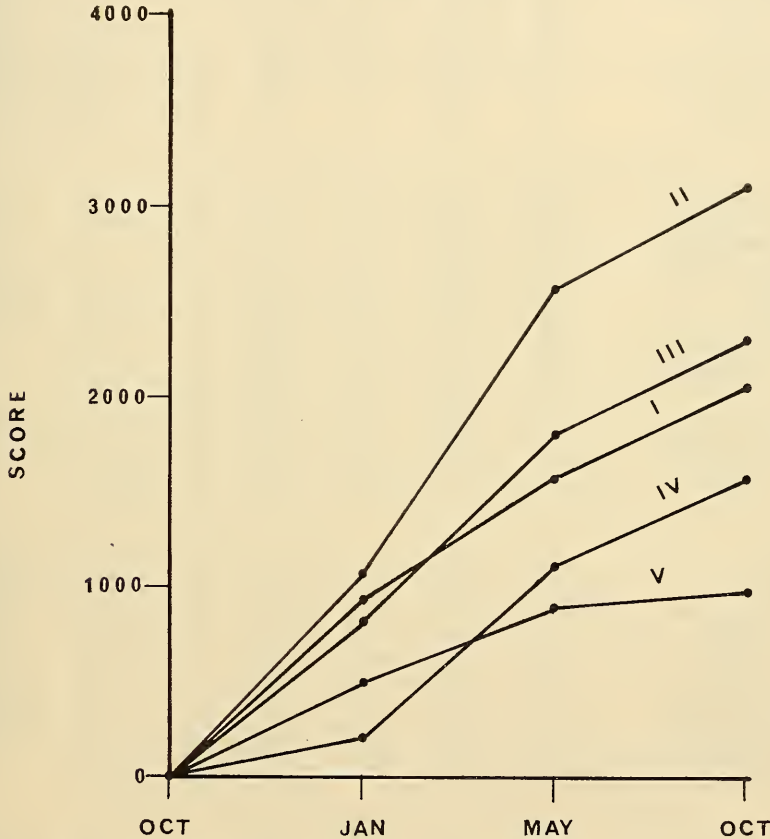

Fig. 2. Total cover repetition scores for all species, total number of contacts recorded on sampling pins, in Grids I-V at Mourawaring Point at four-monthly intervals over the period October 1968 to October 1969 following a fire in late September 1968.

fire, grew well in the early stages of regrowth. But this change does not appear to be permanent since, the fire having released seeds of the tall shrub species, their seedlings are present and would probably grow on and again dominate the area provided another fire does not occur before they flower and set seed.

In their overall patterns of regrowth (Fig. 2) all five areas show rather similar curves. Regrowth is greatest in Grid II and least in Grid V. Whereas the other four areas show a trend of continued regrowth, Grid V shows no significant increment over the winter period, May to October.

TABLE 3

Cover repetition scores and percent contribution to the sward (P.C.S.) of more prominent species at four-monthly intervals, over a period of one year after a fire at Mourawaring Point (Specific authorities as in Beadle *et al.* (1972))

Species *	JANUARY		MAY		OCTOBER		Main origin of regrowth
	Score	P.C.S.	Score	P.C.S.	Score	P.C.S.	
GRID I							
<i>Lomandra glauca</i>	90	9.76	88	5.61	166	8.12	? rhizomes
<i>L. micrantha</i>	47	5.10	47	3.00	116	5.68	? rhizomes
<i>Cyathochaeta diandra</i>	237	25.70	382	24.36	462	22.60	? rhizomes
<i>Schoenus ericetorum</i>	66	7.16	95	6.06	98	4.79	? seedlings
<i>Entolasia stricta</i>	48	5.21	48	3.06	50	2.45	? rhizomes
<i>Themeda australis</i>	209	22.67	511	32.59	532	26.03	? rhizomes
<i>Aristida sp.</i>	7	0.76	17	1.08	74	3.62	? rhizomes
<i>Banksia asplenifolia</i>	126	13.66	221	14.09	290	14.19	lignotubers
<i>Haloragis teucroides</i>	14	1.52	31	1.98	50	2.45	? seedlings
Miscellaneous spp.	78	8.45	128	8.17	206	10.08	
GRID II							
<i>Lomandra glauca</i>	109	10.26	112	4.39	117	3.79	? rhizomes
<i>Hypolaena fastigiata</i>	94	8.85	383	15.00	410	13.29	? rhizomes
<i>Lepidosperma laterale</i>	3	0.28	164	6.42	226	7.33	? rhizomes
<i>Anisopogon avenaceus</i>	138	12.99	126	4.94	173	5.61	?
<i>Banksia asplenifolia</i>	81	7.63	101	3.96	107	3.47	lignotubers
<i>B. serratifolia</i>	213	20.06	528	20.68	575	18.64	lignotubers
<i>Aotus ericoides</i>	59	5.56	231	9.05	277	8.98	? lignotubers
<i>Eriostemon australasicus</i>	15	1.41	51	2.00	74	2.40	?
<i>Ricinocarpos pinifolius</i>	13	1.22	102	4.00	78	2.53	?
<i>Hibbertia fasciculata</i>	81	7.63	111	4.35	272	8.82	?
<i>Haloragis teucroides</i>	7	0.66	43	1.68	82	2.66	? seedlings
<i>Leptospermum flavescens</i>	2	0.19	13	0.51	67	2.17	lignotubers
<i>Platysace linearifolia</i>	110	10.36	353	13.83	313	10.15	?
Miscellaneous spp.	137	12.89	235	9.20	313	10.15	
GRID III							
<i>Lomandra glauca</i>	86	10.76	201	11.15	164	7.17	? rhizomes
<i>L. longifolia</i>	32	4.01	83	4.61	121	5.29	? rhizomes
<i>L. micrantha</i>	242	30.29	422	23.42	524	22.90	? rhizomes
<i>Cyathochaeta diandra</i>	308	38.55	497	27.58	671	29.33	? rhizomes
<i>Baumea teretifolia</i>	0	0	98	5.44	204	8.92	? rhizomes
<i>Entolasia stricta</i>	39	4.88	45	2.50	51	2.23	? rhizomes
<i>Themeda australis</i>	2	0.25	80	4.44	68	2.97	? rhizomes
<i>Banksia asplenifolia</i>	61	7.63	97	5.38	96	4.20	lignotubers
<i>Haloragis teucroides</i>	5	0.63	111	6.16	140	6.12	? seedlings
<i>Leptospermum flavescens</i>	0	0	65	3.61	65	2.84	? lignotubers
Miscellaneous spp.	24	3.03	103	5.72	184	7.93	
GRID IV							
<i>Hypolaena fastigiata</i>	5	2.30	90	8.23	84	5.41	? rhizomes
<i>Schoenus brevifolius</i>	39	17.97	83	7.59	89	5.73	? rhizomes
<i>Lepidosperma laterale</i>	34	15.67	48	4.39	73	4.70	? rhizomes
<i>L. limicola</i>	10	4.61	119	10.88	173	11.15	? rhizomes
<i>Entolasia stricta</i>	14	6.45	57	5.21	67	4.32	? rhizomes
<i>Anisopogon avenaceus</i>	9	4.15	105	9.60	132	8.51	?
<i>Casuarina distyla</i>	0	0	33	3.02	52	3.35	seedlings
<i>Banksia asplenifolia</i>	55	25.35	86	7.86	92	5.93	lignotubers
<i>B. serratifolia</i>	28	12.90	121	11.06	97	6.25	lignotubers
<i>B. ericifolia</i>	0	0	30	2.74	68	4.38	seedlings
<i>Acacia suaveolens</i>	0	0	111	10.15	113	7.28	seedlings
<i>Haloragis teucroides</i>	0	0	11	1.01	51	3.29	?
<i>Pimelea linifolia</i>	0	0	78	7.13	203	13.08	?
<i>Actinotus helianthi</i>	0	0	9	0.82	46	2.96	seedlings
Miscellaneous spp.	23	10.59	113	10.33	212	13.66	

TABLE 3—Continued

Species *	JANUARY		MAY		OCTOBER		Main origin of regrowth
	Score	P.C.S.	Score	P.C.S.	Score	P.C.S.	
GRID V							
<i>Lomandra glauca</i>	63	12.65	85	9.41	87	8.90	? rhizomes
<i>L. micrantha</i>	73	14.66	64	7.09	162	16.58	? rhizomes
<i>Cyathochaeta diandra</i>	137	27.51	256	28.35	231	23.64	? rhizomes
<i>Schoenus brevifolius</i>	69	13.86	76	8.42	90	9.21	? rhizomes
<i>Lepidosperma laterale</i>	35	7.03	53	5.87	69	7.06	? rhizomes
<i>Entolasia stricta</i>	42	8.43	57	6.31	37	3.79	? rhizomes
<i>Lambertia formosa</i>	31	6.22	131	14.51	111	11.36	? lignotubers
Miscellaneous spp.	48	9.62	181	20.04	190	19.45	

\* Only those species whose cover repetition score exceeded 50 on any one of the sampling occasions are shown individually.

Other plants recorded were :

- Grid I : *Lomandra longifolia*, *Patersonia glauca*, *Haemodorum planifolium*, *Diuris* sp., *Lepyrodia scariosa*, *Schoenus brevifolius*, *Lepidosperma limicola*, *L. laterale*, *Isopogon anemonifolius*, *Petrophile fucifolia*, *Acacia myrtifolia*, *Mirbelia rubiifolia*, *Callistemon citrinus*, *Leptospermum flavescens*, *Leucopogon esquamatus*, *Epacris pulchella*, *Dampiera stricta*, *Goodenia bellidifolia*, 1 unidentified species.
- Grid II : *Selaginella uliginosa*, *Lomandra longifolia*, *L. micrantha*, *Haemodorum planifolium*, *Cyathochaeta diandra*, *Lepyrodia scariosa*, *Schoenus ericetorum*, *S. brevifolius*, *Lepidosperma limicola*, *Entolasia stricta*, *Isopogon anemonifolius*, *Petrophile fucifolia*, *Bauera rubioides*, *Acacia ulicifolia*, *A. suaveolens*, *Bossiaea ensata*, *B. heterophylla*, *Pseudanthus orientalis*, *Hibbertia* sp., *Callistemon citrinus*, *Leptospermum laevigatum*, *Pimelea linifolia*, *Leucopogon esquamatus*, *L. appressus*, *Epacris pulchella*, *Dampiera stricta*, unidentified seedlings.
- Grid III : *Patersonia glauca*, *Haemodorum planifolium*, *Hypolaena fastigiata*, *Lepyrodia scariosa*, *Schoenus brevifolius*, *Lepidosperma laterale*, *L. limicola*, *Aristida* sp., *Anisopogon avenaceus*, *Banksia spinulosa*, *Isopogon anemonifolius*, *Acacia ulicifolia*, *A. myrtifolia*, *Mirbelia rubiifolia*, *Pseudanthus orientalis*, *Hibbertia aspera*, *Callistemon citrinus*, *Pimelea linifolia*, *Epacris pulchella*, *Dampiera stricta*, *Scaevola ramosissima*, *Goodenia bellidifolia*, *Lasiopetalum ferrugineum*, unidentified seedlings.
- Grid IV : *Lomandra glauca*, *L. longifolia*, *Haemodorum planifolium*, *Cyathochaeta diandra*, *Lepyrodia scariosa*, *Themeda australis*, *Hakea teretifolia*, *H. gibbosa*, *Isopogon anemonifolius*, *Petrophile* cf. *fucifolia*, *Acacia ulicifolia*, *A. myrtifolia*, *Aotus ericoides*, *Bossiaea ensata*, *B. heterophylla*, *Mirbelia rubiifolia*, *Eriostemon australasicus*, *Pseudanthus orientalis*, *Hibbertia fasciculata*, *Xanthosia* cf. *pilosa*, *Leucopogon esquamatus*, *Opercularia aspera*, *Dampiera stricta*, *Scaevola ramosissima*, *Rulingia* cf. *hermaniifolia*, unidentified seedlings.
- Grid V : *Selaginella uliginosa*, *Lomandra longifolia*, *Patersonia glauca*, *Haemodorum planifolium*, *Lepyrodia scariosa*, *Schoenus ericetorum*, *Lepidosperma limicola*, *Aristida* sp., *Casuarina distyla*, *Banksia aspleniifolia*, *Isopogon anemonifolius*, *Hakea teretifolia*, *Petrophile fucifolia*, *Mirbelia rubiifolia*, *Haloragis teucroides*, *Callistemon citrinus*, *Epacris pulchella*, *Leucopogon esquamatus*, *L. appressus*, *Dampiera stricta*, *Goodenia bellidifolia*, unidentified seedlings.

#### SOILS (Table 4)

The results from first set of samples (taken one week after fire) show a great deal of variation within the grids, which seems to be the result of uneven distribution of the nutrients from ash pockets at this stage. Due to this variability, mean values from the two sets are not compared statistically. However, a general trend of decrease in the amounts of exchangeable sodium and potassium is indicated in the samples of the second set (taken after one year). Exchangeable calcium and magnesium show quite the reverse pattern, indicating a trend of increase after one year, especially in the two sandy grids (II and IV).

Soil analysis data are available from samples collected before the fire from the same areas, but not the same sampling spots. A comparison of the mean

TABLE 4  
*Comparison of mean values of soil variables immediately after "0", one year after fire "0+1", and before fire "(2)"*

Grid	Exchangeable						Available P (ppm)	Total N (%)										
	Na (m-equiv, %)	K (m-equiv, %)	Ca (m-equiv, %)	Mg (m-equiv, %)	Available P (ppm)	Total N (%)												
	0	0+1	(2)	0	0+1	(2)	0	0+1	(2)	0	0+1	(2)						
I	0.65	0.50	(0.76)	0.50	0.43	(0.43)	1.66	2.08	(1.70)	1.80	2.33	(2.16)	3	2	(2)	0.099	0.092	(0.093)
II	0.53	0.39	(0.42)	0.39	0.29	(0.28)	0.95	1.51	(1.05)	0.52	1.04	(0.48)	10	9	(8)	0.060	0.053	(0.063)
III	0.63	0.49	(0.66)	0.48	0.42	(0.42)	1.49	2.02	(2.08)	1.56	1.84	(1.77)	9	6	(6)	0.084	0.087	(0.083)
IV	0.53	0.46	(0.50)	0.29	0.30	(0.28)	1.12	0.93	(1.21)	1.18	1.04	(0.50)	13	9	(8)	0.067	0.062	(0.066)
V	0.56	0.48	(0.62)	0.35	0.39	(0.39)	0.98	1.12	(1.24)	1.15	1.27	(1.37)	2	1	(1)	0.057	0.060	(0.060)

values shows that one year after the fire the nutrient status was very similar to that before the fire, except for magnesium in Grids II and IV which was higher (1.04 m-equiv.%) after the fire than before (0.48–0.50 m-equiv.%).

#### DISCUSSION

The results clearly show that the total regrowth was highest at the sandy site (Grid II), while in the ground-water heath (Grids I, III and V) total regrowth was related to soil depth, being less as the loamy horizon becomes shallower. The small amount of regrowth in Grid IV, especially in the initial stages, may be related to the presence of a tall storey of *Banksia ericifolia*, *Hakea teretifolia* and *Casuarina distyla* before the fire and reflects the suppression of heliophilic species which sprout from underground stocks, e.g. *Hypolaena fastigiata*, *Lepidosperma* spp. Such species show a rapid regrowth at other sites immediately after fire. This further suggests that, whereas these species have regenerated from underground stocks at other sites initially, in Grid IV they may have regenerated mostly from seedlings. The larger lignotuberous species, *Banksia serratifolia* and *B. aspleniifolia*, were much suppressed and few aerial shoots were present before the fire in Grid IV. These species showed a rapid regrowth immediately after the fire. Jacobs (1955) has reported that in tallowwood (*Eucalyptus microcorys*) a lignotuber was capable of producing a healthy shoot after being suppressed for 14 years on a forest floor under heavy shade.

The most notable feature following the fire was the almost total absence of seedlings of the tall shrubby species *Banksia ericifolia*, *Hakea teretifolia* and *Casuarina distyla* from sites where their seedlings were present before the fire. This suggests that the present structure of vegetation would persist for a long time in the absence of a tall storey of these species. It also suggests that in the event of frequent periodic burning, these large shrubby species, which regenerate solely from seedlings, would be eliminated and consequently the dominant stratum would then be formed by such shrub species as are able to regenerate from underground stocks, e.g. *Banksia aspleniifolia*. It is reasonable therefore to postulate that the community dominated by *B. aspleniifolia* at Mourawaring Point is a fire-maintained one in the wet sand heath and the ground-water heath.

An observation on the North Head of Port Jackson, New South Wales, supports this. The area, with a loamy topsoil, contains numerous seedlings of *Banksia aspleniifolia* but no mature bushes. On the other hand, numerous dead sticks of *B. ericifolia*, *Casuarina distyla* (?) and *Hakea teretifolia* can be seen in the area but none of their seedlings. According to local residents, the area was subjected to periodic burning (approximately every two years) over the preceding few years. It seems that this area, once supporting a tall, dense scrub of these shrubs, has been transformed into an open heath where the most prominent species is *B. aspleniifolia*, whose seedlings have established successfully in the absence of a tall storey.

It is also interesting to note that the seedlings of *B. aspleniifolia* (and also of *B. serratifolia*) have been encountered only rarely at Mourawaring Point. There is no obvious explanation available to account for this difference in the behaviour of *B. aspleniifolia* with respect to establishment of seedlings at these sites. Evans (1960) reports that most of the species growing on Hawkesbury Sandstone favour only one method of re-establishment, either by seedlings or by sprouting from underground stocks, and that *Banksia aspleniifolia* is one of the few species which regenerate by both sprouting and seedling production.

It may be seen from the results that few changes have occurred in the floristic composition of herbaceous or undershrubby lower stratum at the open sites (Grids I, II, III and V) as compared to the site which supported a dense, tall storey before the fire (Grid IV). Many species which were frequent at the adjacent sites were absent, rare or suppressed in Grid IV before the fire. These

species appear and show a luxuriant growth after the fire at this site. Interestingly enough, a few species which were relatively rare at the adjacent sites before the fire show luxuriant growth in Grid IV after the fire, e.g. *Acacia suaveolens*, *Lepidosperma limicola*. Sweeney (1956) has shown a similar phenomenon for some herbaceous species on chaparral burns in California and has demonstrated that viable seeds of many herbaceous plants, appearing on one year old burns, were present in soil under brush stands of various ages.

Two hypotheses have been put forward to explain any subsequent changes, following a fire, in population densities of herbaceous and undershrub species :

- (1) Direct factor-function relationship between fire and seeds (see Sweeney, 1956) :
- (2) Competition (see Specht *et al.*, 1958).

Both the hypotheses are feasible and demonstration of the probability of either of these may not necessarily mean the elimination of the other. In fact, it seems likely that either one of them, or both, may contribute towards change in population densities of different species, depending on the vegetation types. More detailed studies are necessary to resolve this problem. In the present case, herbaceous or undershrub species regenerate after fire from underground stocks or seedlings or both. Any subsequent changes in population densities may be attributed either to a requirement of seeds for a temperature treatment before they germinate or to a competition factor, especially for light, which increases with time, or to both. In any event, periodic burning seems essential for continued survival of some of these species.

The soil analysis shows that the nutrient status of soil returns fairly quickly to the pre-fire level (see Table 4). Specht *et al.* (1958), who have examined 2½, 9, 15 and 25 year old stands of heath vegetation on Makin sand, point out that any increase in the nutrient status immediately after fire, which must occur, is essentially depleted by the end of 2½ years. The nutrient status, then, remains relatively constant in the top 76 cm of soil for the next 15 years. The soils under a 25 year old stand again show an increase in the nutrient status, which has been attributed to the degeneration of the two co-dominants, *Phyllota* and *Casuarina*. The results from this present study are in complete agreement with those of Specht *et al.* (1958) and furthermore indicate that the equilibrium may be reached within 12 months after fire.

#### ACKNOWLEDGEMENTS

The work described above formed part of the Ph.D. thesis submitted by one of us (M.Y.S.) during tenure of a University of Sydney Postgraduate Research Studentship. Support from University of Sydney Research Grant funds is gratefully acknowledged.

#### References

- ANDERSON, D. J., 1960.—A comparison of some upland plant communities with particular reference to their structure. Ph.D. Thesis, University of Wales.
- BEADLE, N. C. W., 1940.—Soil temperatures during forest fires and their effect on the survival of vegetation. *J. Ecol.*, 28 : 180–192.
- , and BURGESS, A., 1949.—Working capital in plant community. *Aust. J. Sci.*, 11 : 207–208.
- , EVANS, O. D., and CAROLIN, R. C., 1972.—*Flora of the Sydney Region*. Sydney : A. H. Reed.
- COALDRAKE, J. E., 1961.—The ecosystem of the coastal lowlands ("Wallum") of Southern Queensland. *C.S.I.R.O. Bull.*, 283.
- EVANS, G. P., 1960.—Ecological studies on regeneration following bush-fires in the Hawkesbury Sandstone district. M.Sc. Thesis, University of Sydney.
- HATCH, A. B., 1955.—The influence of plant litter on the Jarrah forest soils of the Dwellingup region, Western Australia. *Commonw. For. Timber Bur. Leaf.*, 70.
- JACOBS, M. R., 1955.—*Growth habit of the eucalypts*. [Department of the Interior, Forestry and Timber Bureau] Canberra : Government Printer.

- JARRET, P. H., and PETRIE, A. H. K., 1929.—The vegetation of Blacks' Spur region : A study in the ecology of some Australian mountain Eucalyptus forests. II. Pyric succession. *J. Ecol.*, 17 : 249-280.
- KERSHAW, K. A., 1973.—*Quantitative and dynamic plant ecology*. 2nd ed. London : Edward Arnold.
- SHAW, N. H., 1957.—Bunch spear grass dominance in burnt pastures in South-Eastern Queensland. *Aust. J. Agric. Res.*, 8 : 325-334.
- SIDDIQI, M. Y., CAROLIN, R. C. and ANDERSON, D. J., 1972.—Studies in the ecology of coastal heath in New South Wales. I. Vegetation structure. *PROC. LINN. SOC. N.S.W.*, 97 : 211-224.
- SPECHT, R. L., 1969a.—A comparison of the sclerophyllous vegetation characteristic of Mediterranean type climates in France, California, and Southern Australia. I. Structure, morphology, and succession. *Aust. J. Bot.*, 17 : 277-292.
- , 1969b.—A comparison of the sclerophyllous vegetation characteristic of Mediterranean type climates in France, California, and Southern Australia. II. Dry matter, energy, and nutrient accumulation. *Aust. J. Bot.*, 17 : 293-308.
- , RAYSON, P., and JACKMAN, M., 1958.—Dark Island heath (Ninety-Mile Plain, South Australia). VI. Pyric succession : changes in composition, coverage, dry weight and mineral nutrient status. *Aust. J. Bot.*, 6 : 59-88.
- SWEENEY, J. R., 1956.—Responses of vegetation to fire : A study of the herbaceous vegetation following chaparral fires. *Univ. Calif. Publ. Bot.*, 28 : 143-250.
- TOTHILL, J. C., 1969.—Soil temperatures and seed burial in relation to the performance of *Heteropogon contortus* and *Themeda australis* in burnt native woodland pastures in Eastern Queensland. *Aust. J. Bot.*, 17 : 269-275.
- , and SHAW, N. H., 1968.—Temperatures under fires in bunch spear grass pastures of South-East Queensland. *J. Aust. Inst. Agric. Sci.*, 34 : 94-98.





Copies of the PROCEEDINGS OF THE LINNEAN SOCIETY OF NEW SOUTH WALES (with the exception of a few volumes and Parts) may be purchased from the Society, Science House, 157 Gloucester Street, Sydney, N.S.W., 2000.

Current charges for the PROCEEDINGS are :

Volumes—\$16.00 each for 1st Series (Volumes 1-10); \$11.00 each for 2nd Series (Volumes 11-20) and all subsequent volumes.

Parts—\$5.00 each for all back parts; \$4.00 each for current Parts. For volumes of 5 or 6 Parts, \$1.00 each for first and last Parts.

Prices do not include postage.

Subscription to the PROCEEDINGS—\$20.00 per volume, plus \$2.50 postage—\$22.50.

All prices are in Australian currency.

These charges may be revised from time to time, and inquiries should be addressed to The Secretary, Linnean Society of New South Wales, Science House, 157 Gloucester Street, Sydney, N.S.W., 2000, Australia.

The Society's PROCEEDINGS are printed and published for the Society by the Australasian Medical Publishing Co., Ltd., 71-79 Arundel Street, Glebe, N.S.W., 2037.

# Proceedings, Volume 101, Part 1, 1976

## CONTENTS

	Page
Annual General Meeting :	
Report on the Affairs of the Society for the Year .. .. .	1
Balance Sheets .. .. .	7
BARKAS, J. P. Early Devonian igneous activity and some stratigraphic correlations in the Tumut region, New South Wales .. .. .	13
FAIN, A., and DOMROW, R. The genera <i>Campylochirus</i> Trouessart and <i>Campylochiropsis</i> Fain (Acari: Atopomelidae), parasites of phalangeroid marsupials in Australasia .. .. .	27
SIDDIQI, M. Y., and CAROLIN, R. C. Studies in the ecology of coastal heath in New South Wales. II. The effects of water supply and phosphorus uptake on the growth of <i>Banksia serratifolia</i> , <i>B. aspleniifolia</i> and <i>B. ericifolia</i> .. .. .	38
SIDDIQI, M. Y., CAROLIN, R. C., and MYERSCOUGH, P. J. Studies in the ecology of coastal heath in New South Wales. III. Regrowth of vegetation after fire .. .. .	53

# Proceedings of the Linnean Society of New South Wales

Issued 16th March, 1977

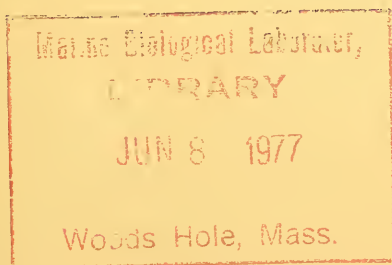

VOLUME 101  
PART 2  
No. 446

# The Linnean Society of New South Wales

Founded 1874. Incorporated 1884

“ For the cultivation and study of the science of Natural History  
in all its branches ”

## OFFICERS AND COUNCIL, 1976-77

### *President*

Barbara G. Briggs, Ph.D.

### *Vice-Presidents*

H. G. Cogger, M.Sc., Ph.D. ; D. W. Edwards, B.Sc.Agr. ;  
P. J. Stanbury, Ph.D. ; T. G. Vallance, B.Sc., Ph.D.

### *Honorary Treasurer*

Joyce W. Vickery, M.B.E., D.Sc., F.L.S.

### *Secretary*

Ruth J. Inall

### *Council*

Barbara G. Briggs, Ph.D.  
H. G. Cogger, M.Sc., Ph.D.  
D. W. Edwards, B.Sc.Agr.  
L. A. S. Johnson, D.Sc.  
D. McAlpine, M.Sc., Ph.D.  
Helene A. Martin, Ph.D.  
Lynette A. Moffat, B.Sc., Ph.D.  
P. Myerscough, M.A., D. Phil.  
J. Pickard, B.Sc.Agr.  
A. Ritchie, B.Sc., Ph.D.

F. W. E. Rowe, B.Sc., Ph.D., M.I.Biol.,  
F.L.S.  
P. J. Stanbury, Ph.D.  
N. G. Stephenson, M.Sc., Ph.D.  
T. G. Vallance, B.Sc., Ph.D.  
Joyce W. Vickery, M.B.E., D.Sc., F.L.S.  
J. T. Waterhouse, B.Sc., M.Sc. (N.S.W.),  
M.Sc. (R'ding), F.L.S.  
B. D. Webby, M.Sc., Ph.D.  
A. J. T. Wright, B.Sc., Ph.D.

### *Auditors*

W. Sinclair and Company, Chartered Accountants

*Linnean Macleay Lecturer in Microbiology, University of Sydney*

K. Y. Cho, Ph.D.

### *Librarian*

Constance B. McKay, B.A., A.L.A.A.

### *Executive Editor*

Janet Donald, B.A., Dip.Lib.

The Society's Headquarters are in Science Centre, 35-43 Clarence Street, Sydney,  
N.S.W. 2000, Australia

UNIVERSITY OF SYDNEY  
LIBRARY  
JUN 8 1977  
100, 105, Hall, Mack

# THE ROLE OF BARLEY, RYE AND GRASSES IN THE 1973-74 WHEAT STEM RUST EPIPHYTIC IN SOUTHERN AND EASTERN AUSTRALIA

N. H. LUIG\* AND I. A. WATSON\*

[Accepted for publication 18th February 1976]

## Synopsis

The addition of three further genotypes, namely *Agropyron intermedium* derivative, Entrelargo de Montijo and Barleta Benvenuto, to the Australian wheat stem rust differential set permitted the recognition of 41 strains among 1,530 isolates identified during the 1973-74 wheat season. A comparison is made for each State and region of the stem rust patterns obtained from collections on wheat and those from barley, rye and the grasses *Agropyron scabrum* and *Hordeum leporinum*. The latter patterns reflect to a high degree the relative frequencies of strains well established in the different areas. Population shifts in the pathogen are mainly attributed to factors other than survival ability on grasses. Putative hybrid rusts, probably involving *Puccinia graminis avenae*, are also described.

## INTRODUCTION

Annual surveys aimed at determining the variability of cereal rusts in Australia have been conducted for more than 50 years and the main emphasis has been placed on the wheat stem rust pathogen, *Puccinia graminis* Pers. f.sp. *tritici* Eriks. and E. Henn. During the last 35 years collections from wheat have comprised two different types, namely those taken from commercial cultivars giving susceptible or semi-resistant reactions to all strains and those coming from cultivars with genes for resistance to certain strains only. On account of the fact that the second group of cultivars placed severe restrictions on the development of some strains having fewer genes for virulence, the tables concerned with relative frequencies are thus biased.

However, such bias is not always caused by collections from wheats in the second group. If it was, the strain pattern obtained only from cultures established from the generally susceptible wheats could be used to give a true picture of the composition of the pathogen population during a particular year. Recently, in Western Australia and South Australia, more than half of the total wheat acreages in each State were sown to one cultivar, Gamenya (*Sr9b*) and Halberd (*Sr6 Sr11*), respectively. These cultivars have genes for resistance which differentiate between strains in those areas and consequently both were important in determining the nature of the rust population in these States.

The 1973 growing season differed in many aspects from previous ones. Stem rust was prevalent throughout the whole of the southern and eastern wheat belts and many samples from wheat were submitted for identification. Also, collections from barley, rye and numerous grasses were made by our, co-operators, as well as by one of us (I.A.W.) during routine survey sampling. The present study exploits this unique opportunity to compare the rust patterns emerging from sampling these different hosts. An attempt is also made to relate the shifts in the *P. g. tritici* population to infection of grasses (possible oversummering), windblown rust movements and cultivars carrying major genes for resistance.

---

\* Plant Breeding Institute, University of Sydney, New South Wales, 2006.

## MATERIALS AND METHODS

As previously reported (Watson and Luig, 1963) our survey procedure is to take field collections of rusted wheat and to inoculate the susceptible cultivar Sonora W195 with them. The inoculum so increased is then used to infect seedlings of wheat genotypes belonging to four groups. The first group comprises those genotypes of the standard international differential set useful for the Australia-New Zealand geographical region, namely Marquis (*Sr7b*), Reliance (*Sr5*), Mindum, Acme, Einkorn (*Sr21*) and Vernal Emmer (*Sr9e*). The genes in parentheses are important for differentiation. The reactions of these six genotypes determine the standard race number and a further subdivision is made on the basis of the system proposed by Watson and Luig (1963) using eleven supplementary genotypes constituting the second group. The first eight of these and the infection types observed on them have already been described (Watson and Luig, 1963, 1966; Luig and Watson, 1970). In 1973 we added W3592, Entrelargo de Montijo W3560 P.L.184525 (a Portuguese *T. durum* cultivar) and Barleta Benvenuto W3502 C.I.14196 (an Argentine cultivar which possesses a major gene (infection type "X-" to Australian strains)). W3592 is an alien substitution line in which the 7D chromosomes are replaced by a pair of chromosomes from *Agropyron intermedium* (Host) Beauv. This line was derived from an addition line, TAF2 (-W3341) produced by Mme. Y. Cauderon in France. The three additional supplementals have been numbered 9, 10 and 11, respectively.

The third group includes genotypes which combine two or more known genes for resistance, and which are very useful when dealing with mixed cultures. In the fourth group are two varieties (Eagle with *Sr26* derived from *Agropyron elongatum* and Khapstein W1451 with *Sr7a*, *Sr13* and *Sr14*) which have proved resistant to all isolates from this geographical area.

Due to the large number of collections received during the 1973-74 season, many samples which contained sufficient inoculum were first stored at 7°C and low humidity. When differential sets became available, infected stems (or leaves) were cut into short pieces, placed in tubes containing Mobilsol oil and after shaking the spore suspension was used to inoculate seedlings of the four groups of genotypes. This technique reduced the possibility of contamination during inoculum increase.

Rust samples which had their origin on plants other than wheat were dealt with by a different procedure. Samples originating from rye or barley were first applied to Little Club, W2691 and Yalta wheats and to Black Winter rye. In most instances, virulence on rye (3+, 4) and infection types approximating to "X", "2=" and "0" on W2691, Little Club and Yalta, respectively, were taken as evidence that the particular sample was of rye stem rust *P. g. f. sp. secalis* Eriks. and E. Henn. On the other hand, avirulence on rye (;,1,2), infection types "2=" or "3+" on Yalta and susceptibility on W2691 and Little Club indicated that *P. g. tritici* was involved. Such cultures were further tested on the four groups as outlined above.

The collections that could not be categorised as *P. g. secalis* or *P. g. tritici* we classified as "scabrum" rust (see Luig and Watson, 1972). In such instances, Black Winter rye was heterogeneous or intermediate in reaction, Yalta was usually highly resistant, and Little Club and W2691 produced higher infection types than with *P. g. secalis*. Stem rusts other than these three probably occurred occasionally on certain rye genotypes (e.g. stem rust of rye grass caused by *Puccinia graminis* f. sp. *lolii* Guyot and Massenot) but no attempt was made to detect them as their presence was considered insignificant for the present study.

Collections from native or cultivated grasses, e.g. rough wheat grass *Agropyron scabrum* Beauv. and barley grass *Hordeum leporinum* Link., were first tested on Little Club wheat, Black Winter rye, Algerian oats, barley (B240),

*Lolium temulentum* L. and *Dactylis glomerata* L. Virulence on wheat indicated the presence of *P. g. tritici*, on oats the presence of oat stem rust *P. g. graminis* f. sp. *avenae* Eriks. and E. Henn., on Black Winter rye the presence of *P. g. secalis* and on *L. temulentum* the presence of stem rust of rye grass *P. g. lolii*. Scabrum rust was identified by the criteria cited above, whereas hybrid rusts (probably involving oat stem rust) were characterised by intermediate infection types on Algerian oats and virulence on *D. glomerata*. The pathogen involved in stem rust of cocksfoot, *P. graminis* f. sp. *dactylidis* Guyot and Massenot, was identified by its virulence on *D. glomerata* and avirulence on the genotypes of the other species.

The locations where collections from the grasses were made are indicated in Fig. 1.



Fig. 1. Sites (•) in Queensland and Northern New South Wales (Region I) and in Southern New South Wales, Victoria and South Australia (Region II) where rusts were collected on grasses.

## RESULTS

The main purpose of this study is to compare the patterns in stem rust strains originating from collections made from wheat with those from rye, barley and the grasses and to relate the prevalence of individual strains of wheat stem rust to oversummering (on grasses and volunteer wheat), to rust movements due to windblown inoculum and to wheat cultivars grown in the different areas of the southern and eastern wheat belt. In this connection each State and region (see Luig and Watson, 1970) will be treated *seriatim*. Thus the results from northern and southern New South Wales appear separately. Table 1 summarises the entire data obtained for the 1973–1974 season.

Summary of the number of isolations of different strains of *P. graminis* tr

Origin of samples	21,2	5	9	1,2	2,5	2,7	1,2,5	1,2,6	1,2,7	2,3,7	2,4,5	2,5,10	1,2,3,7	2,3,5,7	2,3,6,7	2,3,7,11	2,5,7,10	2,3,4,5,7	2,3,7,8,9
QUEENSLAND																			
fr Wheat	7	27	2	2	12	1				6	1	1						9	7
fr <i>A. scabrum</i>	5				1	1													1
fr <i>H. leporinum</i>																			
fr Barley	1	1								1									
fr Rye																			
Total	13	28	2	2	13	2				7	1	1						9	8
NORTHERN NEW SOUTH WALES																			
fr Wheat	6	4		2	11		1			5			1					3	3
fr <i>H. leporinum</i>					1														1
fr Barley	1				1														
Total	7	4		2	13		1			5			1					3	4
SOUTHERN NEW SOUTH WALES																			
fr Wheat	42	3		47	99	2	3	1		50	1	1		1	1	1	1	4	10
fr <i>A. scabrum</i>	3			4	11					1		1							
fr <i>H. leporinum</i>	3			3	2					6					2				1
fr Barley	1			1	8					3									2
fr Rye	1									1									
Total	50	3		55	120	2	3	1		61	1	2		1	3		1	1	13
VICTORIA																			
fr Wheat	4	1		32	6			1		1									
fr <i>H. leporinum</i>										1									
Total	4	1		32	6			1		2									
SOUTH AUSTRALIA																			
fr Wheat	9	1		135	25	3	1	2		19			2	2		1			3
fr <i>A. scabrum</i>																			
fr <i>H. leporinum</i>	1			6	1	1													
fr Barley	1			13	4					5									
fr Rye																			
Total	11	1		154	30	4	1	2		24			2	2		1			3
WESTERN AUSTRALIA																			
fr Wheat				1															
TASMANIA																			
fr Wheat	1					6													
NEW ZEALAND (NORTH ISLAND)																			
fr Wheat			1							2									
NEW ZEALAND (SOUTH ISLAND)																			
fr Wheat																			
Grand Total	86	37	3	246	188	8	5	1	3	101	2	3	3	1	5	2	1	16	28



nae speciales of *P. graminis* during 1973-74 grouped according to their origin

	-2,7	-2,11	-2,3,7	-2,5,7	-2,5,11	-2,7,11	-2,4,5,11	194-1,2	-2,5	-2,3,7	-2,5,7	-1,2,3,5,6	-2,3,7,8,9	-1,2,3,7,8,9	-2,3,7,8,9,10	222-1,2,3,5,6	326-1,2,3,5,6	343-1,2,3,5,6	<i>P. g. tritici</i> Total	"Scabrum" rust	<i>P. gr. avenae</i>	<i>P. gr. secalis</i>	<i>P. gr. lolii</i>	Grand Total
			6		2		1					5	41	14			6	158		3	1			158
													3	3	2		3	20		2				23
													3					6		1				1
			6		2		1					5	47	17	2		9	184		6	1	1		192
		1	3					1			1	3	27	14			30	124			1			124
																		2						3
																		5						5
		1	3					1			1	3	28	14			30	131		1				132
5	9	134			1				1		7	79	2	1			14	601						601
1	2	10						1			4	4						49			4			53
1		3	1								3	3						30		5	3	1		39
		3									1	4					2	35						35
		1																3			6			9
7	11	151	1		1			1	1		8	90	2	1			16	718		5	13	1		737
4	1	5		2													5	89						89
																	1	3		1				4
4	1	5		2													5	92		1				93
1	3	28		1				12	1				9				29	322						322
			1					1										1	13					13
		7						2									1	39			2			39
																								2
1	3	35	1		1			15	1				9				30	375		2				377
																		1						1
		3		1													2	22						22
																		3						3
																	2	4						4
12	16	203	2	6	1	1	15	3	1	1	17	176	33	1	2	94	1	1530	6	8	16	1	1561	

## QUEENSLAND (REGION I)

Altogether one hundred and eighty-four identifications of *P. g. tritici* from this area were made and strain 194-2,3,7,8,9 was most prevalent (22.8%). In contrast to the season 1972-73, when virulence on plants with *Sr6* was not detected, 23.3% of the isolates in 1973-74 proved virulent on plants with this gene.

Of eight isolates originating from barley, two were identified as scabrum rust which is a putative hybrid between *P. g. tritici* and *P. g. secalis* (Luig and Watson, 1972) and appears to be pathogenic on commercial barley. The other six isolates were classified as wheat stem rust: three were identified as 194-2,3,7,8,9 and three represented the old, well documented strains 21-2, 21-5 and 21-2,3,7. Since only eight identifications were made, the absence of strains attacking plants with *Sr6* was not significant. On the other hand, sampling from barley had produced a rust pattern more resembling that of 1972-73 than that of 1973-74.

Two samples from rye were collected from the Hermitage Plant Breeding Station, Warwick. One, received early in the season, was identified as scabrum rust, suggesting that susceptible genotypes of rye were infected with inoculum originating on *A. scabrum*. The other, collected later, proved to be *P. g. secalis*.

Of isolates found growing on grasses, 23 came from *A. scabrum* and one from *H. leporinum*. Here the rust pattern was different from that shown when barley was the host. Strain 194-2,3,7,8,9 was detected only in three instances, but eight isolates were of the recently discovered strains possessing virulence on plants with *Sr6* (3 × 194-1,2,3,7,8,9; 3 × 326-1,2,3,5,6; 2 × 222-1, 2,3,5,6). Strain 222-1,2,3,5,6 came from two sites, Brookstead and Southbrook, separated by only 32 km, and because of virulence on plants with *Sr6* we regard it as possible that the *A. scabrum* A type plants in these areas (Rees, 1972b) were infected by inoculum originating on nearby wheats with *Sr6* such as Oxley, Gamut and Tarsa.

Two very rare strains, 34-2,4,5,11 and 21-2,7, were detected among the *A. scabrum* isolates. Unexpectedly, scabrum rust was found only three times. Strains 21-2 (5 ×), 21-2,3,7,8,9 (1 ×) and 21-2,5 (1 ×) accounted for the remainder of the twenty-three samples.

The single sample from *H. leporinum* proved to be *P. graminis avenae*. This shows that barley grass may also be infected by *P. graminis avenae* as well as by *P. graminis tritici*, *P. graminis secalis*, scabrum rust and *P. graminis lolii*. Hence it appears to be a congenial host for several cereal and related *formae speciales* of *P. graminis*.

## NORTHERN NEW SOUTH WALES (REGION I)

The strain pattern emerging in northern New South Wales reflected the strong influence that Tarsa and Gamut had on the composition of the rust population in this region. The total area sown to them was relatively small but almost all the remaining area was sown to cultivars with resistance to all strains, e.g. Timgalen, Gatcher and Eagle. There was a small area of Festiguay as well and this accounted for the presence of 194-2,3,7,8,9. Since Tarsa and Gamut each have *Sr6* and *Sr9b* there was strong selection pressure favouring strains with corresponding virulence genes.

Strain 326-1,2,3,5,6, previously recorded only in South Australia, Victoria and southern New South Wales, was detected in 30 of the 131 identifications (22.9%). Six other strains with virulence on plants carrying *Sr6* (194-1,2, 3,7,8,9, 21-1,2,3,7,8,9, 194-1,2,3,5,6, 21-1,2,3,7, 21-1,2 and 21-1,2,5), all unrecorded in this region during the previous season, accounted for 19.8% of the identifications. Strain 194-2,3,7,8,9, the leading strain of the previous season,

was recorded in 21·4% of the cases. Among the remaining isolates 11 further strains including 21-2,5, 21-2, 21-2,3,7 and 34-2 were detected.

From three barley samples four different strains, namely 21-2, 34-2 ( $\times 2$ ), 21-2,5 and 194-2,3,7,8,9, were identified. About eighteen years ago, 21-2 was very widespread in this region, but has decreased during the last ten years. The others are common in this region. As with the collections from barley in Queensland, no strains virulent on plants with *Sr6* were recovered.

Two rust samples, one of *Phalaris* sp. and the other of *H. leporinum*, were received. The sample from the latter proved to be a mixture of oat stem rust and wheat stem rust (21-2,5 and 21-2,3,7,8,9). The sample from *Phalaris* sp. was a possible hybrid involving *P. graminis avenae*. The significance of this will be discussed later in conjunction with other putative hybrids.

#### SOUTHERN NEW SOUTH WALES (REGION II)

Nearly 50% of all stem rust samples had their origin in southern New South Wales, and this was expected in view of the extent of the damage suffered in this part of the wheat belt. However, the relative prevalence of the main strains remained about the same as in the previous season, the percentages being: 34-2,3,7—21·1%; 21-2,5—16·9%; 194-2,3,7,8,9—12·7%; 21-2,3,7—8·6%; 21-2—7·0%. The Summit (*Sr5*), attacking strains 34-2 (10·3%), 34-2,5 (5·9%) and 34-2,7 (1·1%), made up more than 17% of the isolates while strains 21-2,3,7,8,9 (1·8) and 194-1,2,3,5,6 (1·1) which are now common in northern New South Wales, accounted for a further 3%. Twelve strains were recovered on three or less occasions.

Altogether 117 *P. g. tritici* isolates originating from hosts other than wheat were identified. About 30% came from barley, with strains 34-2 and 21-2,5 accounting for more than 50%. This proportion was twice that expected. Strain 34-2,3,7, on the other hand, was relatively infrequent. Strains 326-1, 2,3,5,6 and 194-1,2,3,5,6 virulent on plants with *Sr6* and *Sr9b*, were also recovered. Of nine isolates from rye, three were *P. g. graminis* (21-2; 21-2,3,7 and 34-2,3,7) and the other six proved to be *P. g. secalis*, which was also found on barley grass (3 $\times$ ) and rough wheat grass (4 $\times$ ). However, the bulk of the samples from the two grasses were identified as *P. g. tritici*. Strains 21-2,5, 34-2,3,7 and 34-2 were prevalent among 49 isolates from *A. scabrum*, while 21-2,3,7 and 34-2 appeared relatively more frequently among thirty isolates from barley grass. Summarising the results and comparing them with the overall pattern from *P. g. tritici* in southern New South Wales it can be concluded that 34-2 occurred on hosts other than wheat with twice the frequency expected, whereas the frequency of 194-2,3,7,8,9 on both types of hosts was approximately the same. Strain 21-2,5 was very frequent on *A. scabrum* and barley. Unlike the wheat samples, 34-2,3,7 did not show up as the leading strain from grasses. The absence of the new, *Sr6*-attacking strains 326-1,2,3,5,6, 194-1,2,3,5,6, 194-1,2,3,7,8,9 and 21-1,2,3,7,8,9 on barley grass and *A. scabrum* was conspicuous; they were recovered twenty-four times from wheat and three times from barley.

A sample obtained from Wimmera rye grass proved to be *P. graminis lolii*. Collections from grasses other than *A. scabrum*, *H. leporinum* or *Lolium* spp. involved *P. graminis avenae* (*Lamareckia aurea* L. (1 $\times$ ), *Aira cupaniana* Guss. (2 $\times$ ), *Phalaris paradoxa* L. (1 $\times$ ), *Bromus hordeaceus* (1 $\times$ ), *Dactylis glomerata* (1 $\times$ ), *Phalaris* sp. (1 $\times$ ), Silver grass *Vulpia bromoides* (2 $\times$ ), Pigeon grass *Setaria geniculata* var. *pauciseta* Desv. (1 $\times$ )). From Swamp Wallaby grass *Amphibromus neesii* Steud. and from *Phalaris* sp. putative hybrids involving *P. graminis avenae* were recovered. One sample from *D. glomerata* was identified as *P. graminis dactylidis*. In addition to *P. g. tritici* and *P. g. secalis*, barley grass yielded *P. g. avenae*, *P. coronata* F. and L. (crown rust of oats), and the specialised leaf rust pathogens of barley grass and rye grass.

## VICTORIA (REGION II)

The most prevalent strain in Victoria was 21-1,2 (34.8%) and this was determined from ninety-two isolates. In previous years there had only been trace amounts of this strain. The increased acreage of Halberd (*Sr6*, *Sr11*) in north-western Victoria has probably contributed to the build up of 21-1,2 but we believe that the predominance of this strain in South Australia has also been responsible to some extent for the change. The influence of Summit (*Sr5*) is shown by 34-2 and 34-2,5 being also among the prevalent strains in Victoria.

Of three samples of rusted barley grass, one yielded strain 34-2, the second gave a mixture of *P. g. avenae* and *P. g. tritici* (21-2,3,7), and from the third a new, previously unrecorded standard race, 343 (343-1,2,3,5,6), was recovered. Presumably this is a mutant for virulence on plants with *Sr5* from the wide-spread 326-1,2,3,5,6. Should 343-1,2,3,5,6 become more prevalent, the newly released cultivars Condor, Oxley and Egret will be extremely vulnerable as as they possess little or no resistance to this strain.

## SOUTH AUSTRALIA (REGION II)

As a consequence of a severe stem rust epiphytotic many samples from South Australia were analysed. Of the three hundred and seventy-five isolates of wheat stem rust, three hundred and twenty-two originated from wheat, one from *A. scabrum* and fifty-two came from either barley or barley grass. Since Halberd (*Sr6*, *Sr11*) was the leading cultivar in South Australia, it was not surprising to find that strain 21-1,2 was predominant (41.1%). Five strains which are virulent on Halberd, 326-1,2,3,5,6 (8.0%), 194-1,2 (4.0%), 21-1,2,7 (0.5%), 21-1,2,3,7 (0.5%) and 21-1,2,5 (0.3%) were also found. These together with 21-1,2 accounted for 54.4% of the isolates.

TABLE 2

*Behaviour of 14 wheat genotypes when tested with strain 34-2,11 and its putative parents SRN 21 and SRN 126*

	SRN 126	SRN 21	34-2,11
Stocks with <i>Sr5</i> .. .. .	+	-	+
Stocks with <i>Sr7a</i> .. .. .	+	-	+
Stocks with <i>Sr10</i> .. .. .	+	-	+
Stocks with <i>Sr12</i> .. .. .	-	+	-
Stocks with <i>SrK</i> .. .. .	+	-	+
Stocks with <i>SrL<sub>2</sub></i> .. .. .	+	-	+
Barleta Benvenuto .. .. .	+	-	+
Stocks with <i>Sr6*</i> .. .. .	-	+	+
Stocks with <i>Sr8</i> .. .. .	+	-	-
Stocks with <i>Sr14</i> .. .. .	-	+	+
Stocks with <i>Sr15</i> .. .. .	+	-	-
Stocks with <i>Sr17</i> .. .. .	+	-	-
Mindum .. .. .	-	+	+
Acme .. .. .	-	+	+

+ = virulent    - = avirulent    \* = at temperatures above 20°C

Excluding 194-2,3,7,8,9, eleven strains, recovered at least four times, came from wheat as well as from barley and barley grass. Apart from the northern part of the wheat belt (Region I) where 194-2,3,7,8,9 infects crops of Festiguay carrying Webster type resistance, this strain is mainly found on cultivars with the gene *Sr9b* (Robin, Raven, Gamenya). During previous seasons, 194-2,3,7,8,9 was virtually nonexistent in the south (Region II) but was found to be very prevalent in the central and northern parts in 1973-74. The absence of

194-2,3,7,8,9 in samples from any alternative grass host is interpreted to indicate that its presence on wheat in South Australia resulted from recent north to south spore movement.

Of the 30 isolates of 326-1,2,3,5,6, 29 were collected on wheat. The exception, the last sample of the season, came from barley. The virtual absence of this strain from hosts other than wheat indicates that the spread of 326-1,2,3,5,6 is mainly promoted by cultivars carrying the genes *Sr6* and/or *Sr9b* (Halberd, Tarsa, Gamut, Robin, Gamenya, Raven). In all other instances, the common strains of South Australia were proportionally well represented in isolates from barley and barley grass.

The recovery of 34-2 twice among the 13 isolates from *H. leporinum* is worthy of comment because this strain has replaced 34-2,11 in the southern regions of the country. Studies of the evolution of the Australian strains of *P. g. tritici* suggest that 34-2 and 34-2,11, although seemingly closely related, have arisen in different ways. The latter was first found in 1957 and, we believe, had its origin as a somatic hybrid between the old standard race number (SRN) 126 of 1925, which was still present, and SRN 21 which became prevalent after 1954 (Luig and Watson, 1970). Strain 34-2,11 has some of the characters of each putative parent as shown by the reactions on seedlings of 14 genotypes in Table 2.

Following the increased acreage sown to Summit (*Sr5*) in Victoria, 21-2, which is a very common strain in the south, mutates at the locus corresponding with *Sr5*, and 34-2 arises. Otherwise 34-2 resembles 21-2. Likewise, strains 21-2,5 and 21-2,7 can give rise to 34-2,5 and 34-2,7, which differ from 34-2,5, 11 and 34-2,7,11 on all genotypes which differentiate between 34-2 and 34-2,11.

As shown in Table 1, the strains which had their origin in the putative somatic hybrid are rare. In mixed cultures their detection on seedlings with *Sr7a*, *Sr10*, *Sr12*, *SrL2* and *SrK* is difficult, as the infection types in each instance are not sufficiently distinct. However, on Barleta Benvenuto they are easily contrasted ("3,3+" vs. ";1++"), and therefore this variety is included as the 11th extra-differential into our stem rust set. This enables us to observe the decline of the older components of race 34 which apparently have not adapted as well to the environment as those developed more recently.

#### *Putative Hybrid Rusts*

As reported under northern and southern New South Wales, five putative hybrid rusts resembling avirulent strains of *P. g. avenae* were recovered. One culture, 74044, was from Armidale in northern New South Wales and four were from the Holbrook region in southern New South Wales and separated by less than 75 km. The origins and characteristics of the five cultures are shown in Table 2. While all five were virulent on wild oats (*Avenae fatua* L. and *A. ludoviciana* Durieu) and produced semi-resistant reactions on Algerian oats, their behaviour on Saia oats (*A. strigosa* Schreb.), *Lolium temulentum*, and *Phalaris canariensis* L. showed the presence of four distinct types. Cultures 74078 and 74079 may be similar.

Four of the cultures, 74044, 74059, 74078 and 74079, in producing identical infection types on the 12 Australian Oat Stem Rust Testers, resembled culture 69968 previously described (Luig and Baker, 1973; Luig and Watson, 1972).

#### DISCUSSION

From the results we have reported it is doubtful whether native and naturalised grasses have a cardinal role in initiating wheat stem rust epiphytotics in the southern and eastern wheat belts. Years of observations of local out-breaks of wheat stem rust have convinced one of us (I.A.W.) that infected volunteer wheat is the salient factor in the persistence and perpetuation of this

TABLE 3  
*Infection types produced by five grass stem rusts on three naturalised grasses and three species of Avenae*

Accession number of rust culture	Locality	Host	Infection type on seedling of					
			<i>Lolium temulentum</i>	<i>Phalaris canariensis</i>	<i>Dactylis glomerata</i>	Algerian Oats 09**	<i>A. ludoviciana</i> 0736**	<i>A. strigosa</i> Saia 0589** C.I.7010
74044	Armidale	<i>Phalaris</i> sp.	3	3	X,3	1+	3+	3+
74050	Carabost	<i>Amphibromus nesii</i>	0	; 1-N	X,3	2	3	; 0
74059	Cookardina	"	0	; 1-N	X,3	1+	3+	3+
74078	Table Top	<i>Phalaris</i> sp.	0	3	X,3	1++	3+	3+
74079	Little Billagong	<i>Phalaris</i> sp.	0*	3	X,3	1++	3+	3+

\* one plant gave "3" infection type.

\*\* 0 numbers refer to Sydney University Oat Accession Lists.

parasite. The fact that a considerable proportion of rust collected from *A. scabrum* is scabrum rust (Table 1; Luig, unpublished) which is non-pathogenic on commercial wheat, decreases the significance of this grass as an initial source of inoculum. This investigation also shows that *H. leporinum* is susceptible to many *formae speciales* as well as to *P. g. tritici*.

Nevertheless, in dry years native grasses could be partially responsible for the overseasoning of the fungus in certain areas, especially Queensland (Rees, 1972a). Furthermore, the role of grasses such as *A. scabrum* and *H. leporinum* in epiphytotics of wheat is not limited to the amount of initial inoculum supplied; the composition of the inoculum could also be influenced by them. Rust populations have to adjust themselves so that they comprise strains best suited to the common genotypes of the grass species essential for their survival, and these strains must also have the necessary genes for virulence, to infect common wheat cultivars carrying simple resistances. A comparison of the strains isolated from collections made in Region I (Queensland and northern New South Wales) showed that 194-2,3,7,8,9 was the most frequent strain in wheat samples but was poorly represented in samples from grasses. Again, the most widespread strains in southern New South Wales, 34-2,3,7 and 21-2,5, were not recovered from *A. scabrum* and *H. leporinum* as frequently as expected. On the other hand, 21-1,2, the most prevalent strain in South Australia and Victoria, was proportionally well represented on grasses while 34-2 was found on grasses more often than expected. Strain 21-2 was common on *A. scabrum* in Queensland. In spite of lacking many factors for virulence, this strain was also recovered frequently from wheat cultivars susceptible to all strains.

The present study further suggests that recently detected strains combining genes for virulence on genotypes with *Sr6* and *Sr9b* (Tarsa and Gamut) were not widespread on grasses. However, as the wheat season progressed, rust isolates from rough wheat grass or barley grass seemed to be a reflection of the epiphytotic rather than its cause. Again, the other alternative hosts of *P. g. tritici*, barley and certain genotypes of commercial rye, when infected during the latter part of the season, appeared to present a strain pattern similar to that expected from wheat cultivars susceptible to all rust strains.

Although stem rust development in the northern part of the eastern wheat belt normally precedes outbreaks in the south, a reverse situation was apparent during 1973-74. While a severe stem rust epiphytotic developed in South Australia, Queensland and northern New South Wales suffered little damage due to a scarcity of inoculum and to the widespread cultivation of resistant wheats. Since some loss was experienced from leaf rust, we believe that susceptible cultivars if widely grown would have been damaged by stem rust. The environment was ideal for long-distance aerial movement of stem rust inoculum and the survey showed that this was happening. During the early growing season, rust collections from Queensland and northern New South Wales comprised old established strains such as 21-5, 21-2,3,4,5,7 and 21-2, 3,7,8,9; later, strains common in central New South Wales (34-2,3,7, 21-2,5, 21-2,3,7, *et al.*) were prominent among the northern isolates; at the end of the season, a larger proportion of collections came from the previously resistant cultivars Tarsa and Gamut. Many of the isolates collected on these latter were of strains virulent on plants with *Sr6*, which had proved effective against all isolates from these areas in preceding seasons. With the exception of 21-1,2,3,7, 21-1,2,3,7,8,9 and 194-1,2,3,7,8,9, which probably arose as mutants from strains present in the northern part of the wheat belt, the other strains (21-1,2, 21-1,2,5, 194-1,2,3,5,6, 222-1,2,3,5,6 and 326-1,2,3,5,6) had previously been detected in the central and southern part of the wheat belt. This showed that southern strains had established themselves in the north and, in due course,

had caused some of the outbreaks of stem rust on Gamut and Tarsa. We also attribute the infection of *A. scabrum* plants in Queensland by strains 326-1, 2,3,5,6, 194-1,2,3,7,8,9 and 222-1,2,3,5,6 to movement of rust inoculum from infected crops to this grass later in the season.

#### ACKNOWLEDGEMENTS

The authors wish to thank Mr. J. D. Oates for his help in the collection of many rust samples, and Messrs. R. G. Rees and R. J. Flynn and other collectors who forwarded rust specimens. Thanks are also due to Messrs., D. J. S. Gow and A. W. Jackson who provided technical assistance.

We are grateful for financial support from the Wheat Industry Research Council and the Reserve Bank of Australia.

#### References

- LUIG, N. H., and BAKER, E. P., 1973.—Variability in oat stem rust in eastern Australia. *PROC. LINN. SOC. N.S.W.*, 98 : 53-61.
- LUIG, N. H., and WATSON, I. A., 1970.—The effect of complex genetic resistance in wheat on the variability of *Puccinia graminis* f.sp. *tritici*. *PROC. LINN. SOC. N.S.W.*, 95 : 22-45.
- , 1972.—The role of wild and cultivated grasses in the hybridization of *formae speciales* of *Puccinia graminis*. *Aust. J. Biol. Sci.*, 25 : 335-342.
- REES, R. G., 1972a.—Uredospore movement and observations on the epidemiology of wheat rusts in north-eastern Australia. *Aust. J. Agric. Res.*, 23 : 215-223.
- , 1972b.—*Agropyron scabrum* and its role in the epidemiology of *Puccinia graminis* in north-eastern Australia. *Aust. J. Agric. Res.*, 23 : 789-798.
- WATSON, I. A., and LUIG, N. H., 1963.—The classification of *Puccinia graminis* var. *tritici* in relation to breeding resistant varieties. *PROC. LINN. SOC. N.S.W.*, 88 : 235-258.
- , 1966.—Sr15—a new gene for use in the classification of *Puccinia graminis* var. *tritici*. *Euphytica*, 15 : 239-250.



# ISOTOPIC DATING OF A MIDDLE TRIASSIC MEGAFOSSIL FLORA FROM NEAR NYMBOIDA, NORTHEASTERN NEW SOUTH WALES

G. RETALLACK\*, R. E. GOULD\* and B. RUNNEGAR\*

[Accepted for publication 24th March 1976]

## Synopsis

A basalt flow, with a K-Ar isotopic age of  $211 \pm 5$  million years, is interbedded between two homotaxial Aniso-Ladinian fossil flora within the Nymboida Coal Measures underlying the far southwestern Moreton Basin. The Dalmally Basalt Member (new name) of the Bardool Conglomerate is a flow because it has a chilled base and coarse grained top, an increased size of feldspar phenocrysts and vesicles upwards, and it is concordant in dip and strike with the surrounding sedimentary rocks. Flint and Gould (1975) have recently correlated the rich fossil flora of the Basin Creek Formation, stratigraphically above the basalt flow, with the Aniso-Ladinian flora of the Esk Trough in southeastern Queensland. The fossil flora of the Cloughers Creek Formation, stratigraphically below the basalt flow, is essentially identical to that of the Basin Creek Formation. The basalt thus furnishes one well-documented isotopic date for Aniso-Ladinian Gondwanaland megafossil floras now recognised in eastern Australia, South Africa and South America.

In the description of the fossil flora of the Cloughers Creek Formation, G.R. proposes the following new species and varieties: *Lobifolia dejerseyi* sp. nov., *Dicroidium dubium* var. *tasmaniense* comb. nov. and *D. odontopteroides* var. *remotum* comb. nov.

## INTRODUCTION

Diverse and in places well-preserved Triassic fossil floras are associated with an isotopically dated basalt flow within the Nymboida Coal Measures (Fig. 1). These rocks outcrop for a few miles around the small township of Nymboida, 35 km southwest of Grafton, northeastern New South Wales (Fig. 2). The Nymboida Coal Measures unconformably overly deformed Palaeozoic metasediments of the New England Fold Belt to the west. They form an isolated outcrop underlying terrestrial sediments of the far southwestern Moreton Basin (Day *et al.*, 1974).

McElroy (1963) mapped the area around Nymboida in considerable detail. The megafossil flora of the area has been studied by De Jersey (1958) and Flint

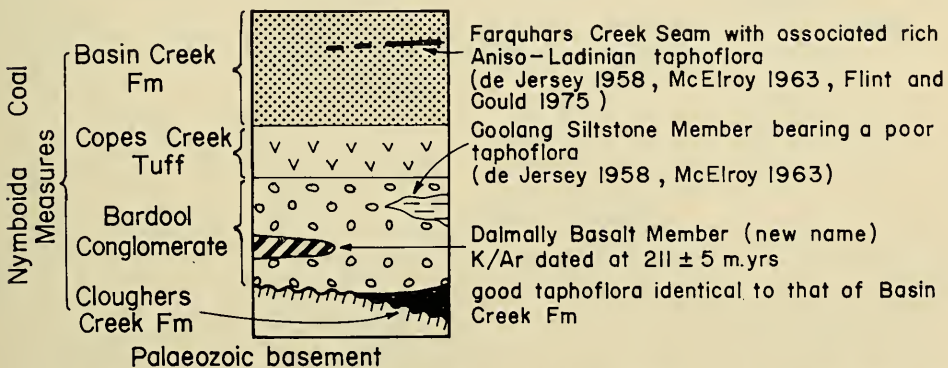

Fig. 1. Geological relationship of the isotopically dated basalt flow with the fossil floras and a lithological key to Fig. 2.

\* Department of Geology, University of New England, Armidale, New South Wales, 2351.

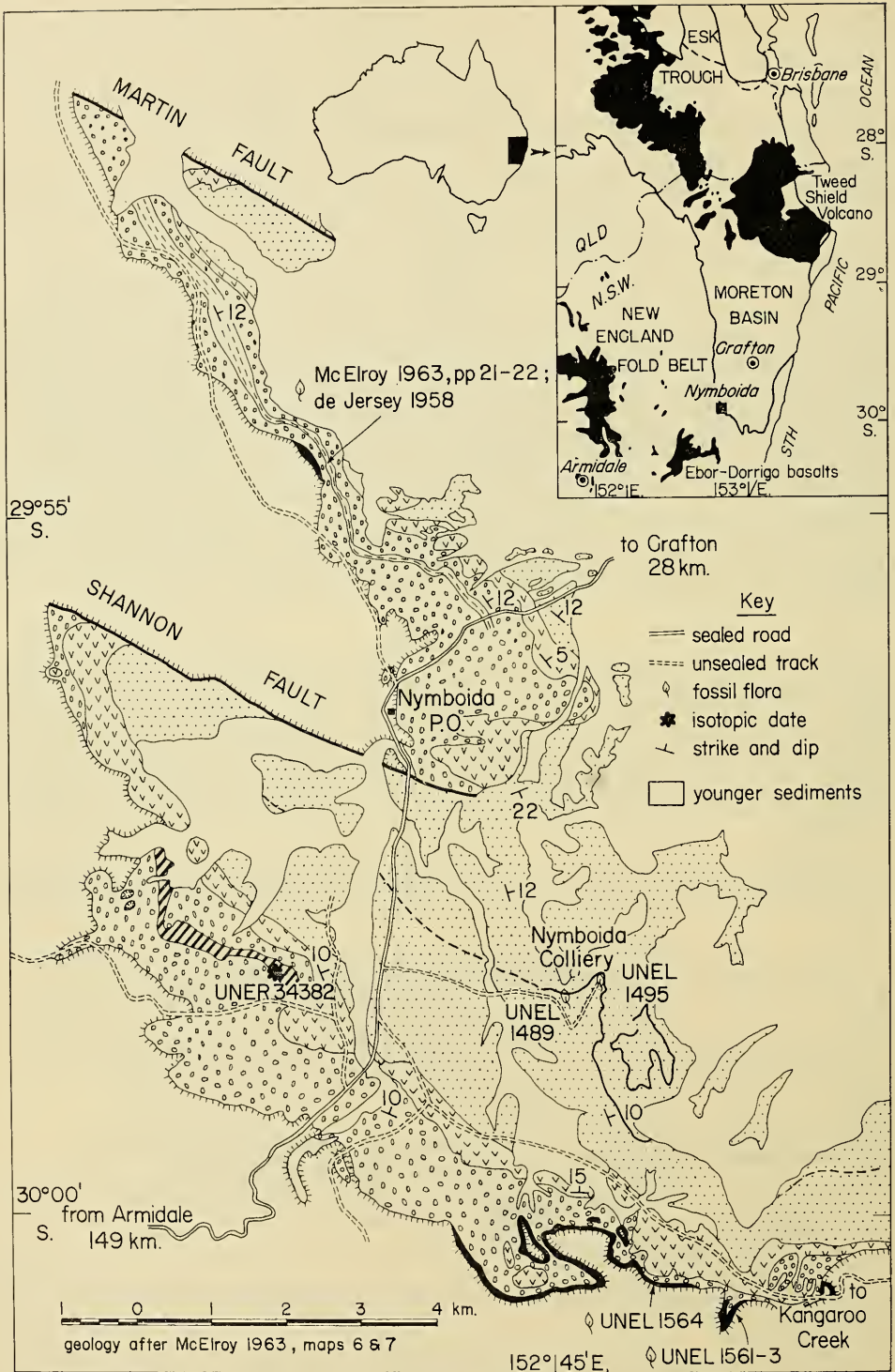

Fig. 2. Geological map of the Nymboida Coal Measures.

and Gould (1975). Unfortunately, pollen and spores recovered from the Nymboida Coal Measures have been too poorly preserved to be of any biostratigraphic use (De Jersey, 1958; McElroy, 1963, p. 25; J. C. E. Flint, pers. comm.)

#### DALMALLY BASALT MEMBER (RETALLACK, NEW NAME)

*Enclosing Formation.* Bardool Conglomerate of the Nymboida Coal Measures, underlying the far southwestern Moreton Basin (McElroy, 1963).

*Type Section.* The basalt is about 15 m thick outside the meander bend on the true right bank of Copes Creek ("Nymboida" 1:63,360 military map, grid. ref. 808877).

*Derivation.* After Dalmally Homestead, near where Copes Creek flows into the Nymboida River.

*Description.* McElroy (1963, pp. 49, 59) has described the outcrop, petrography and chemistry of this unit. The C.I.P.W. norm calculated from McElroy's analysis indicates a subalkaline (non-alkaline) basaltic composition. Several specimens illustrating the textural variation in this rock have been placed in the collections of the Geology Department, University of New England (UNER34382, 35367-35370).

*Why the Dalmally Basalt Member is a Triassic Flow.* The elongate outcrop of the basalt is concordant with the strike of the surrounding Triassic sedimentary rocks and completely within the outcrop of the Bardool Conglomerate (Fig. 2). The dip of the bench-forming top of the basalt is also the same as the dip of overlying conglomerate, sandstone and tuff. Concordance is also supported by the outcrop pattern of vertical texture variation in the basalt (Fig. 3) at the type locality.

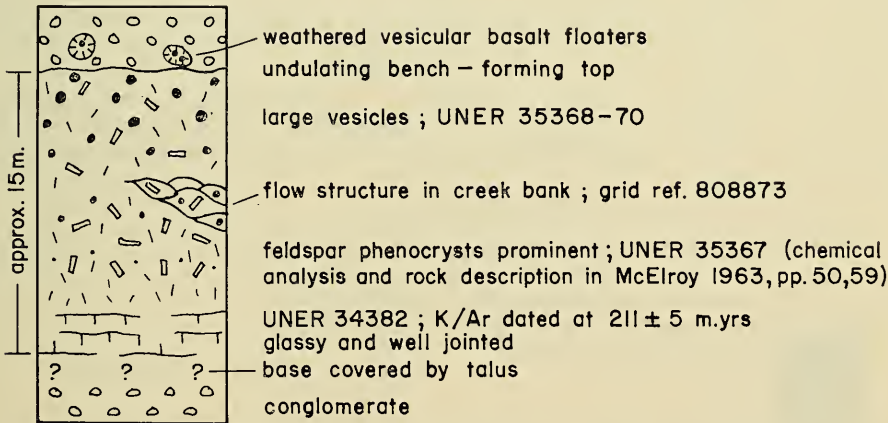

Fig. 3. Vertical texture variation in the Dalmally Basalt Member of the Bardool Conglomerate.

The basalt has a glassy, block-jointed base, and a more massive central portion containing feldspar phenocrysts. Amygdales and vesicles increase in abundance and size towards the top of the flow (Fig. 3). The vesicles are up to 3 cm in diameter and may be partly or completely filled with calcite, zeolites and quartz. Some rounded basalt floaters found on the hillside above the top of the basalt are very strongly vesicular and resemble basaltic scoria (Green and Short, 1971, fig. 162b). In the creek bank exposure at "Nymboida" grid. ref. 808873, coarsely vesicular basalt with lenticular flow structure appears to cut a shallow channel into the underlying well-jointed basalt.

The Cope's Creek Tuff, only 15 to 30 m above Dalmally Basalt Member, is evidence of associated Triassic pyroclastic activity in this area.

The Dalmally Basalt Member is chemically more similar to some Triassic basalts in southeastern Queensland than to subalkaline Tertiary basalts in northeastern New South Wales (Fig. 2; McElroy, 1963, p. 63). "The low Fe/Mg ratio and low K<sub>2</sub>O content (0.35%) distinguish the Dalmally Basalt Member from the subalkaline volcanics in the southern portion of the middle Miocene Tweed Shield Volcano. Not enough is known about the Miocene basaltic lavas of the Ebor-Dorrigio area to make an effective comparison. Houston (1965) considered some volcanics from the base of the Triassic Ipswich Coal Measures in southeastern Queensland to be spilites, but there appears to be insufficient mineralogical data to warrant terming these rocks spilites *s.s.* The analysed volcanics are altered to varying degrees, but inspection of the analyses (Houston, 1965, table 1) suggests some chemical affinities with the Dalmally Basalt Member." (J.F.G. Wilkinson, pers. comm.)

#### ISOTOPIC AGE OF THE DALMALLY BASALT MEMBER

Unweathered plagioclase from near the base of the basalt (UNER34382) yielded a <sup>40</sup>K/<sup>40</sup>Ar isotopic date of 211 ± 5 million years. The determination was made by Dr D. C. Green (Isotope Laboratory, Department of Geology and Mineralogy, University of Queensland), who has also supplied the following ancillary data and constants: %K<sub>2</sub>O (av.) = 0.36; vol. radiogenic <sup>40</sup>Ar std.cc. = 0.02664 × 10<sup>-5</sup>; % radiogenic <sup>40</sup>Ar = 86.6; λ<sub>e</sub> = 0.585 × 10<sup>-10</sup>/yr; λ<sub>β</sub> = 4.72 × 10<sup>-10</sup>/yr; <sup>40</sup>K/K = 1.19 × 10<sup>-4</sup> mole/mole.

#### NEW FOSSIL PLANT LOCALITIES IN THE CLOUGHERS CREEK FORMATION

The Cloughers (pronounced "Cloggers" by the local residents) Creek Formation (McElroy, 1963) is the lowest formation of the Nymboida Coal Measures, underlying the Bardool Conglomerate in restricted areas (Figs 1, 2). Several new plant fossil localities have been given University of New England, Geology Department fossil locality numbers (UNEL-).

Only fragmentary remains were found associated with the coal seam at locality H of McElroy (1963, map 12), near the base of the Cloughers Creek Formation (Fig. 4). The following species are identified from the top of the seam (UNEL1561):

*Pteruchus dubius* (Thomas) Townrow 1961

*Lepidopteris madagascariensis* Carpentier 1935

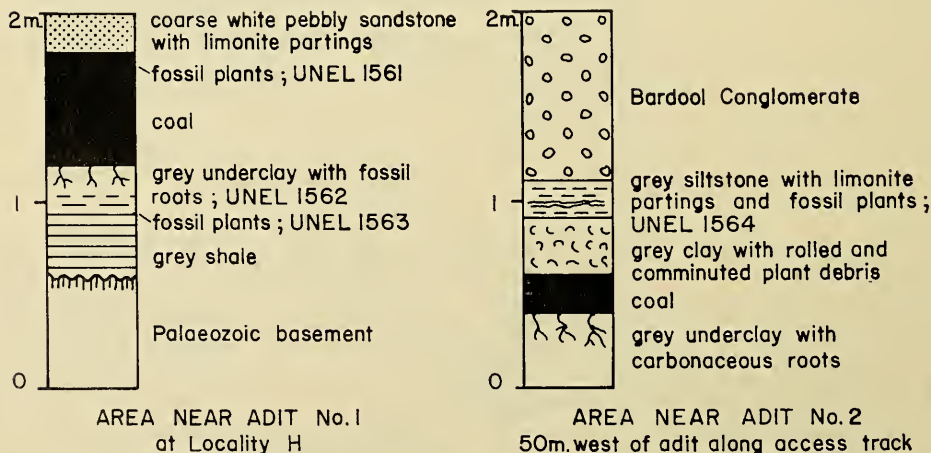

Fig. 4. Geology of fossil plant localities in the Cloughers Creek Formation (locality H and adits are shown by McElroy, 1963, maps 12, 13).

The underclay of the coal seam (UNEL1562) contained only many-branched woody roots.

In well-bedded carbonaceous shale below the underclay (UNEL1563) all the fossil plant remains are very fragmentary. Comparison with more complete material from the Cloughers Creek Formation suggests the following species are present :

*Lobifolia dejerseyi* sp. nov.

*Dicroidium lancifolium* (Morris) Gothan 1912

*D. odontopteroides* var. *remotum* comb. nov.

*D. zuberi* (Szajnocha) Archangelsky 1968c

*Rissikia media* (Tenison-Woods) Townrow 1967b (cone)

Fructification type A

Fructification type B

Fructification type C

The best collection was obtained from a grey siltstone at the very top of the Cloughers Creek Formation on the track 100 m west of adit number 2 (UNEL1564; McElroy, 1963, map 13). The plant fossils have all been leached of organic matter and iron stained to varying extent. Some layers, consisting almost entirely of leaves without intervening sediment, form muddy solution planes in the rock. Asterisks indicate the more common forms.

*Arctopteris* sp.

\* *Cladophlebis gondwanica* Frenguelli 1947

*C. mendozaensis* (Geinitz) Frenguelli 1947

*Lobifolia dejerseyi* sp. nov.

*Dicroidium dubium* var. *tasmaniense* comb. nov.

*D. eskense* (Walkom) Jacob and Jacob 1950

*D. incisum* (Frenguelli) Anderson and Anderson 1970

*D. odontopteroides* var. *remotum* comb. nov.

*D. superbum* (Shirley) Townrow 1957

\* *D. zuberi* (Szajnocha) Archangelsky 1968c

*Pteruchus johnstonii* (Feistmantel) Townrow 1962

*Pilophorosperma* sp. cf. *P. costulatum* Thomas 1933

*Lepidopteris madagascariensis* Carpentier 1935

*Taeniopteris carruthersii* Tenison-Woods 1883

\* *Phoenicopsis elongatus* (Morris) Seward 1919

\* *Sphenobaiera argentinae* (Kurtz) Frenguelli 1946

*S. stormbergensis* (Seward) Frenguelli 1948

*Rissikia media* (Tenison-Woods) Townrow 1967b (foliar spur)

Fructification type A

#### COMPARABLE FOSSIL PLANTS FROM THE BASIN CREEK FORMATION

The Basin Creek Formation is the uppermost formation of the Nymboida Coal Measures. Fossil plants from the Nymboida Colliery open cut (UNEL1489) and drives (UNEL1495) have been described by several authors (De Jersey, 1958; McElroy, 1963, p. 65; Flint and Gould, 1975). Since viewing the large private collection of Mr W. B. K. Holmes, we now realise that this flora is more diverse than previously thought. Certainly much interesting and worthwhile work could be done. However here we only list species which are directly comparable to those described from the Cloughers Creek Formation. We have added new species and emended others in the list of Flint and Gould (1975).

*Cladophlebis gondwanica* Frenguelli 1947

*C. mendozaensis* (Geinitz) Frenguelli 1947

*Lobifolia dejerseyi* sp. nov. (= *Hoegia* sp. De Jersey, 1958; = *Cladophlebis lobifolia* in Flint and Gould, 1975)

- Dicroidium dubium* var. *tasmaniense* comb. nov.  
*D. eskense* (Walkom) Jacob and Jacob 1950  
*D. lancifolium* (Morris) Gothan 1912  
*D. odontopteroides* var. *remotum* comb. nov.  
*D. superbum* (Shirley) Townrow 1957  
*D. zuberi* (Szajnocha) Archangelsky 1968c (= *D. feistmantelii* and *Hoegia papillata* in Flint and Gould, 1975)  
*Pteruchus dubius* (Thomas) Townrow 1961  
*P. johnstonii* (Feistmantel) Townrow 1962  
*Pilophorosperma* sp. cf. *P. costulatum* Thomas 1933  
*Lepidopteris madagascariensis* Carpentier 1935  
*Taeniopteris carruthersii* Tenison-Woods 1883 (= *T. lentriculiforme* in part of Flint and Gould, 1975)  
*Phenicopsis elongatus* (Morris) Seward 1919  
*Sphenobaiera argentinae* (Kurtz) Frenguelli 1946  
*S. stormbergensis* (Seward) Frenguelli 1948  
*Rissikia media* (Tenison-Woods) Townrow 1967b (foliar spurs)  
Fructification type C  
Woody many-branched roots

#### COMPARABLE FOSSIL PLANTS FROM THE GOOLANG SILTSTONE MEMBER

McElroy (1963, p. 21) collected some fossil plants from the Goolang Siltstone Member of the Bardool Conglomerate, 3 km north of Nymboida post office ("Nymboida" grid. ref. 816944; Fig. 2). We have emended De Jersey's (1958) determinations of these fossil plants:

- Lobifolia dejersyi* sp. nov.  
*Dicroidium dubium* var. *tasmaniense* comb. nov.

#### AGE AND UNITY OF FOSSIL FLORULES IN THE NYMBOIDA COAL MEASURES

Of the 23 fossil plant species recognised in the Cloughers Creek Formation 20 can be matched with very similar specimens from the Basin Creek Formation. The three fossil plant species not common to the two formations are rare leaves and fructifications. The two fossil plant species found in the Goolang Siltstone Member of the Bardool Conglomerate are also found in both the Cloughers Creek and Basin Creek Formations. Thus these three florules are essentially homotaxial and may be regarded as belonging to the same megafloreal biozone. The fossil flora of the Nymboida Coal Measures is most similar to Aniso-Ladinian flora of the Esk Trough in southeastern Queensland (De Jersey, 1972; Flint and Gould, 1975).

#### RECOGNISING ANISO-LADINIAN GONDWANALAND MEGAFOSSIL FLORAS

Aniso-Ladinian flora of Gondwanaland are relatively distinct from older Scytho-Anisian floras (Banks *et al.*, 1967; Townrow, 1967a; Banks and Clarke, 1973). However they are not easy to distinguish from Carnian to Norian flora. Both younger Triassic floras have many elements in common. Both are very diverse and variably represented at individual localities. Nevertheless workers in South America, South Africa and Australia (Frenguelli, 1948; Du Toit, 1927; Flint and Gould, 1975) have attempted biostratigraphic separation, despite the opposing tendencies to resist dividing Middle to Late Triassic floras (Stipanovic and Bonetti, 1969) and to refer most of the richer Triassic floras to the Carnian (Anderson and Anderson, 1970). The difference between Aniso-Ladinian and Carnian to Norian fossil plant assemblages is outlined below for Australia, South Africa and South America. Many of the emended records listed here are new. Further intercontinental comparative work will be necessary before formal subdivisions can be proposed.

In eastern Australia the following species are confined to Aniso-Ladinian flora of the Esk Trough in Queensland and the Nymboida Coal Measures of New South Wales (see also Flint and Gould, 1975):

- Asterotheca hillae* Walkom 1924  
*Dictyophyllum davidii* Walkom 1917a  
*Cladophlebis gondwanica* Frenguelli 1947  
*Lobifolia dejerseyi* sp. nov. (= *Hoegia* sp. in De Jersey, 1958; = *Cladophlebis lobifolia* in Flint and Gould, 1975)  
*Kurtziana brandmayri* Frenguelli 1944b (= "*Thinnfeldia*" *eskensis* in Hill *et al.*, 1965, pl. T5, Fig. 3 only)  
*Dicroidium eskense* (Walkom) Jacob and Jacob 1950  
*D. odontopteroides* var. *remotum* comb. nov.  
*Anthrophyopsis grandis* Walkom 1928  
*Pseudoctenis eathiensis* (Richards) Seward 1911

The following species are much more common in the Aniso-Ladinian rocks of the Esk Trough and the Nymboida Coal Measures than in the Carnian Ipswich Coal Measures (see also Jones and De Jersey, 1947, pp. 19, 31, 46):

- D. superbum* (Shirley) Townrow 1957 (*s.s.*, lobed pinnules with clear venation)  
*Johnstonia coriacea* (Johnston) Walkom 1925a (*s.s.*, narrow lamina with entire margins)  
*Taeniopteris carruthersii* Tenison-Woods 1883 (= *T. lenticuliforme* of Flint and Gould, 1975, in part, and of Hill *et al.*, 1965)  
*T. crassinervis* (Feistmantel) Walkom 1917a

Although common in the Ipswich Coal Measures, *Yabeiella* and *Fraxinopsis* have not been found in the Esk Trough or Nymboida Coal Measures. *Xylopteris elongata* (Carruthers) Frenguelli 1943 is common at some localities in the Ipswich Coal Measures, but rare in the Esk Trough and in the Brookvale shale lens of the Hawkesbury Sandstone in the Sydney Basin (probably Anisian; see Helby, 1969).

Du Toit (1927, p. 293) states that the lower portion of the Moltano Beds (Stage C) in South Africa "has produced many genera and species, the majority of which appear again in stage D; only a few are restricted to stage C, for example *Cladophlebis rösserti*, *Marattiopsis münsteri* and *Thinnfeldia narrabeenensis*". However in a table (Du Toit, 1927, pp. 307-308) *Yabeiella*? *dutoitii* Oishi 1931 (= *Marrattiopsis muensteri* of Du Toit, 1927) is only indicated for the middle Moltano Beds (Stage D). From this table the following species are confined to Stage C. Those marked with a + also occur in the Esk Trough of Queensland and the Nymboida Coal Measures of New South Wales.

- + *Cladophlebis gondwanica* Frenguelli 1947 (= *C. roesserti* of Du Toit, 1927)  
+ *Dicroidium eskense* (Walkom) Jacob and Jacob 1950 (= *Thinnfeldia narrabeenensis* of Du Toit, 1927)  
*D.* sp. cf. *D. odontopteroides* (Morris) Gothan 1912 (very like *Dicroidiopsis crassa* var. *prolongata* Menendez 1951; = *Thinnfeldia rhomboidalis* of Du Toit, 1927)  
+ *D. superbum* (Shirley) Townrow 1957 (= *Thinnfeldia feistmanteli* var. *trilobita* of Du Toit, 1927)  
+ *Taeniopteris crassinervis* (Feistmantel) Walkom 1917a  
*Pseudoctenis* sp. cf.  
*P. ballii* (Feistmantel) Seward 1917  
*P. fissa* Du Toit 1927

Fabré and Greber (1960) have also identified many of these species in a flora from the Moltano Beds near Morija, Basutoland. Their *Dictyophyllum ellenbergii* is closest to the Aniso-Ladinian species *D. davidii* of Australia (Walkom, 1917a; Flint and Gould, 1975) and *D. tenuifolium* of Argentina (Bonetti and Herbst, 1964).

This distinction is not apparent in Anderson's (1974) review of the Molteno flora. Her list contains many new species and combinations but there are no accompanying illustrations or descriptions. If her distribution chart is rearranged in the stratigraphic succession of fluvial cycles given by her, only five out of 104 listed species do not occur in cycle 2. These five are mainly new species and all of apparently little stratigraphic value. Within cycle 2, those of Du Toit's (1927) Stage C and Stage D plants which can be made out from the list, occur in separate localities.

Frenguelli (1948) noted the following species as typical of the lower levels in Argentine Triassic basins:

- + *Neocalamites carrerei* (Zeiller) Halle 1908
- + *Asterotheca fuchsii* (Zeiller) Solms-Laubach 1899 (= *A. truempyi* of Frenguelli, 1948, according to Townrow, 1957)
- ? + *Cladophlebis roylei* Arber 1901
- Chiropteris barrealensis* Frenguelli 1942e
- + *Kurtziana brandmayri* Frenguelli 1944b
- + *Dicroidium dubium* var. *tasmaniense* comb. nov.
- + *D. lancifolium* (Morris) Gothan 1912 and/or *D. eskense* (Walkom) Jacob and Jacob 1950 (= *Displasiophyllum acutum* of Frenguelli, 1948)
- + *D. odontopteroides* var. *remotum* var. nov. (= *D. remotum* of Frenguelli, 1948)
- + *D. zuberi* (Szajnocha) Archangelsky 1968c (= *Zuberia feistmantellii*, *Z. sahnii* and *Z. zuberi* of Frenguelli, 1944a, 1948)
- Xylopteris spinifolia* (Tenison-Woods) Frenguelli 1943
- + *Taeniopteris daintreei* McCoy 1875 (separate from *T. spatulata sensu* Frenguelli 1944b, pp. 387-388, non Walkom 1917a, p. 30)
- Voltziopsis angusta* (Walkom) Townrow 1967c (= *Walkomia primula* of Frenguelli, 1944b, according to Townrow, 1967c)

Many of these species (marked with a +) are also known from the Esk Trough in Queensland and the Nymboida Coal Measures in New South Wales. Only questionable remains of *Cladophlebis roylei* have been found in the Esk Trough and Ipswich Coal Measures (Walkom, 1917a, p. 5; Frenguelli, 1947, p. 27). *Kurtziana brandmayri* has been figured from the Esk Trough by Hill *et al.* (1965, pl. T5, Fig. 3 only as "*Thinnfeldia*" *eskensis*). *Xylopteris spinifolia* has not been found in the Esk Trough or the Nymboida Coal Measures, but is known from the younger Ipswich Coal Measures (Jones and De Jersey, 1947). *Taeniopteris daintreei* (*s.s.* Frenguelli, 1944b) includes leaves, like that figured by Flint and Gould (1975, pl. 3, fig. 9) and Hill *et al.* (1965, pl. T8, fig. 4) as *T. lenticuliforme* from the Nymboida Coal Measures and the Esk Trough. *Chiropteris barrealensis* has only been found at one locality in the Barreal-Hilario Basin of Argentina (Frenguelli, 1942e).

*Voltziopsis angusta* is known from the upper Narrabeen Group of the Sydney Basin, New South Wales, possibly from Tanganyika, Africa, and also immediately above a 2 m thick sandstone near the base of the Triassic sequence in the Cacheuta Basin, Argentina (Townrow, 1967c). The sandstone in Argentina contains largely *Dicroidium zuberi* (= *Zuberia feistmantellii*, in Frenguelli, 1944b), but also *Equisetites* sp., *Sphenopteris* sp., *Pterophyllum* sp., *Nilssonia* sp. cf. *N. taeniopteroides* and a (?) cone (Frenguelli, 1944b). This assemblage is most similar to that of the upper Narrabeen Group of the Sydney Basin, New South Wales, of late Scythian to early Anisian age (Helby, 1969).

In addition to the species listed by Frenguelli, *Dictyophyllum tenuifolium* (Bonetti and Herbst, 1964) from Paso Flores and the basal formation of the Barreal-Hilario Basin in Argentina also has Aniso-Ladinian affinities.

We can now most easily recognise Aniso-Ladinian assemblages from the Esk Trough and Nymboida Coal Measures in Australia; the lower Molteno Beds (Stage C of Du Toit, 1927, or cycle 1 and part of cycle 2 of Anderson, 1974) in



South Africa; the Las Cabras Formation of the Cacheuta Basin (excluding the lowest two *Voltziopsis* and *Dicroidium zuberi* dominated localities of Frenguelli, 1944b) and the Potrerillos Formation in the Challao-San Isidro Basin (Frenguelli, 1948) in Argentina.

The Aniso-Ladinian flora from the Esk Trough and the Nymboida Coal Measures were probably diverse forest assemblages on a broad coastal plain between a hilly region to the west and the Eopacific ocean to the east. A generally similar habitat and geographic continuity probably explains why comparison of fossil flora from the Esk Trough and Nymboida Coal Measures works so well (Flint and Gould, 1975). This also explains similarities with Argentine and South African plant megafossil successions.

Gould and Retallack (in Bourke *et al.*, in press) found that Aniso-Ladinian and Carnian to Norian flora could not be so easily distinguished inland of the old Triassic dividing range, near Delungra, New South Wales. An Aniso-Ladinian age for this flora rests largely on the presence of *Lobifolia dejerseyi* sp. nov. (= *Cladophlebis lobifolia* in Bourke *et al.*, in press), the abundance of *Johnstonia coriacea* s.s. and the rarity of *Xylopteris elongata*. One of us (G.R.) has examined some fossil plants from Antarctica in the collections of the New Zealand Geological Survey (partly described by Townrow, 1967a) and Victoria University, Wellington (localities collected on VUWAE 16 1971–1972 in Barrett and Webb, 1973). These appear to be inland plant associations because they are similar to the Delungra florule. The distinction between Aniso-Ladinian and Carnian to Norian flora may prove difficult to make here. This distinction is even more difficult to make in floras from Mount Potts, Benmore Dam and near Corbies Creek in New Zealand (New Zealand Geological Survey collections) where very few distinctive Aniso-Ladinian forms are present. These New Zealand flora appear to be specialised coastal communities associated with Kaihikuan (=Ladinian) marine rocks.

#### ISOTOPIC TIME SCALE WITHIN THE TRIASSIC

Up to the present, the isotopic time scale within the Triassic has been based on terrestrial sediments with extrusives. There is every indication that future progress will rely on more detailed knowledge of fossil plants and vertebrates and their correlation with marine stages. Our K-Ar date of  $211 \pm 5$  million years for an Aniso-Ladinian fossil flora can be regarded as one of the more reliable points for the scale.

The Triassic period probably ranged from 200 to 240 million years ago (Green and Webb, 1974). As Tozer (1964) notes, the minimum  $^{207}\text{Pb}/^{235}\text{U}$  age of  $218 \pm 5$  million years for Carnian pitchblende ores has been much debated. Also an upper limit only is given by the 193 million year old Palisades Sill which intrudes sedimentary rocks with Norian plants and vertebrates. Stipanovic (1969) records "Middle to Upper Triassic" floras in Argentina overlying 222 and  $228 \pm 20$  million year old porphyrites at Los Menucos and a  $194 \pm 25$  million year old granite in the Chihui-Tronquimalal Basin. As with this South American data, many K-Ar dates from southeastern Queensland (Green and Webb, 1974) cannot be correlated with the geological time scale until we know more about the floras and their geological relationships to the dated rocks.

#### SYSTEMATIC PALAEOBOTANY OF THE CLOUGHERS CREEK FORMATION (G.R.)

In this section plant fossils from the Cloughers Creek Formation are described and compared. Comparable specimens from the Basin Creek Formation are listed but not described or figured here. Synonymies have been compiled according to the informal system of Matthews (1973) only for new or unclear specific concepts. The suprageneric classification is after Scagel *et al.* (1968). University of New England Geology Department fossils are prefixed by UNEF- and localities by UNEL-.

## DIVISION PTEROPHYTA

## ORDER FILICALES

## UNCLASSIFIED FERN FORM GENERA

## Genus ARCTOPTERIS Samylina 1964

*Arctopteris* sp.

## Fig. 5C

1927 *Cladophlebis concinna* ; Du Toit, p. 318, pl. 18, fig. 1.

*Description.* The single specimen found (Fig. 5C) shows two parallel pinna fragments. The pinnules have rounded apices and coalesce at the base. The lateral veins form an acute angle to the pinnule midvein and are simple or once forked.

*Comparison.* This fragment cannot be included in *Cladophlebis* (s.s. Frenguelli, 1947; Herbst, 1971) because of its non-falcate, rounded, basally coalescing pinnules. There is no definite anastomosis of the basal secondary veins of contiguous pinnules as in *Merianopteris* (Arber, 1905, p. 144). The fragment agrees best with the form genus *Arctopteris* (Lebedev, 1974).

The very similar *Merianopteris major* (Feistmantel, 1881, p. 83, pl. 19A figs. 9-11; Arber, 1905, p. 144, fig. 34; Surange, 1966, fig. 42) could be placed within *Arctopteris*, but differs from our specimen in its larger unveined basal interpinnular area.

A more common group of Gondwanaland leaves differ from this specimen in their sinuous midrib and secondary veins arising at a less acute angle. These are probably best referred to *Cladophlebis mesozoica* and *C. kurtzii* (Frenguelli, 1947; Herbst, 1971). They include *Merianopteris major* of Tenison Woods (1883), *Cladophlebis concinna* of Jones and De Jersey (1947) and Flint and Gould (1975), *Cladophlebis wielandii* of Jain and Delevoryas (1967) and probably also *Pecopteris concinna* of Feistmantel (1881) and Surange (1966).

*Occurrence.* A similar specimen is figured by Du Toit (1927) from the middle Molteno Beds at Konings Kroon, South Africa (Stage D of Du Toit, 1927, and cycle 2 of Anderson, 1974).

Genus CLADOPHLEBIS Brongniart emend. Frenguelli 1947 : 12

*Cladophlebis gondwanica* Frenguelli 1947

Figs 5D-5F

*Description.* The large number of specimens found (UNEF14663-14668, UNEF14645, UNEF14659, UNEF14714) suggest that this species was locally abundant near the depositional site of UNEL1564. The primary and secondary rachis are very thick and woody for this genus. The pinnules may appear lobed and basally constricted but this is due to fracture of the rock matrix around an irregularly recurved leaf. The secondary veins generally dichotomise twice and arise very obliquely from the pinnule midvein.

*Comparison.* This species closely resembles *C. grahamii* (Frenguelli, 1947), but in that species the secondary veins are doubly forked only at the base of the pinnules.

*Occurrence.* As defined by Frenguelli (1947, p. 32), this species is known from the lower Molteno Beds (Stage C) of South Africa, the Rhaetic or Norian of Tonkin in Vietnam, the (?) Keuper Yenchang Formation of northern Shensi in China, the Triassic of Paso Flores and the Liassic of Piedra Pintada in Argentina, and the Jurassic of Grahamland, Ceylon and India.

*Comparable Basin Creek Formation material.* UNEF13363/4 from UNEL1489 are part and counterpart of a similar but larger frond than any from the Cloughers Creek Formation.

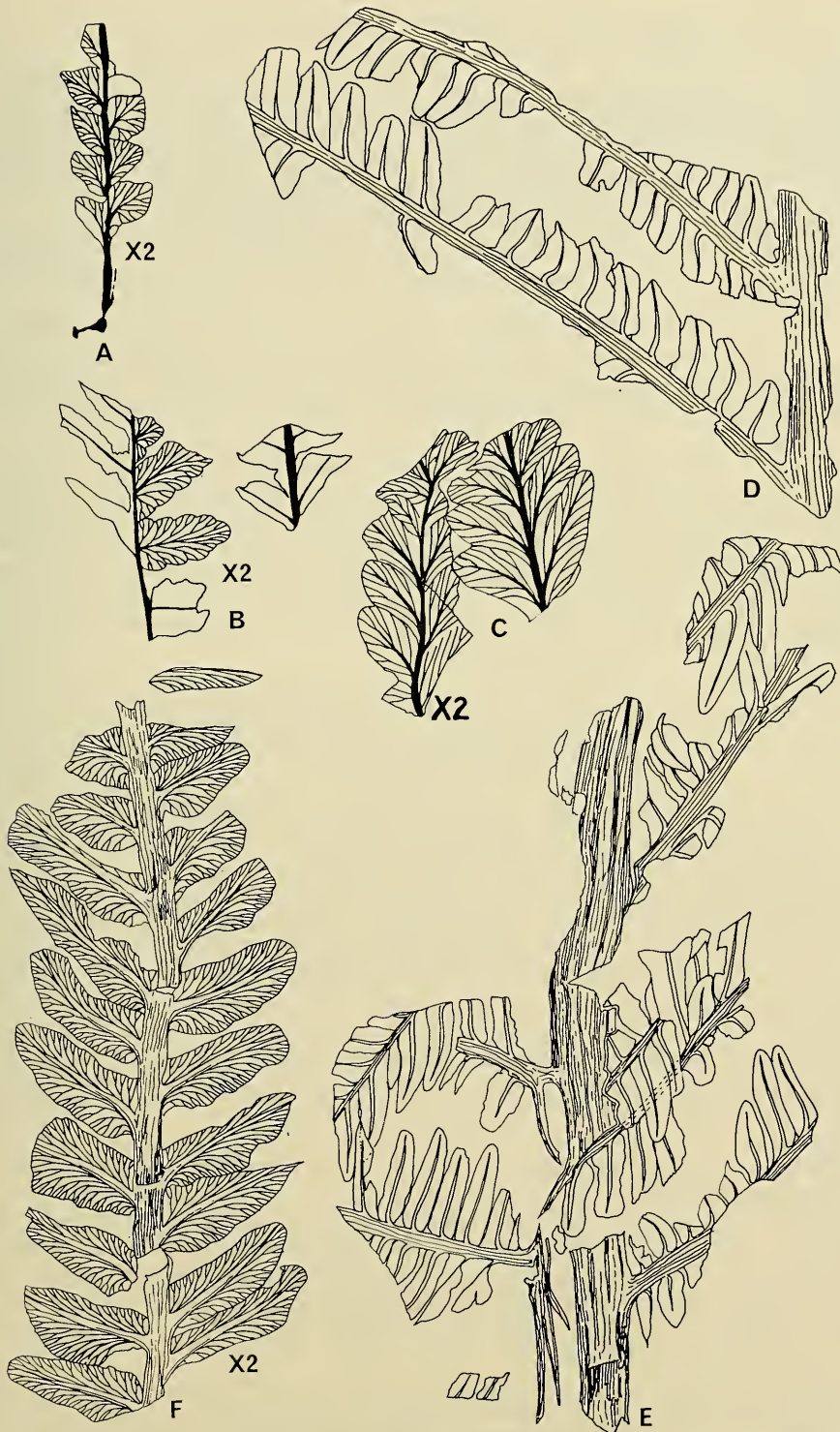

Fig. 5. A. *Lobifolia dejerseyi*. B. *Cladophlebis mendozaensis*. C. *Arctopteris* sp.  
 D-F. *Cladophlebis gondwanica*. A. UNEF14669,  $\times 2$ ; B. UNEF14681,  $\times 2$ ; C. UNEF-  
 14676,  $\times 2$ ; D. UNEF14663, natural size; E. UNEF14666, natural size; F. UNEF14714,  $\times 2$ .  
 All from UNEL1564.

*Cladophlebis mendozaensis* (Geinitz) Frenguelli 1947

## Fig. 5B

*Description.* The only specimen (Fig. 5B) found at UNEL1564 shows two parallel pinna fragments of a presumably bipinnate frond. The slender pinna rachis bears erect subtriangular to slightly falcate, alternate, lobulate, basally constricted pinnules. The lateral veins dichotomise twice before reaching the pinnule margin. The leaf surface is finely punctate as if covered in small hair bases, similar to the South American material (Frenguelli, 1947, p. 62).

*Comparison.* This specimen is most similar to those figured by Frenguelli (1947, pl. 12, figs 1-6) and generally similar to the diagrams of Herbst (1971, figs 12, 13, 20).

There is some debate whether forms with elongate pinnules should be separated as *Cladophlebis johnstonii* (Jain and Delevoryas, 1967) or given varietal status within *C. mendozaensis* (Herbst, 1971). Either outcome does not affect the identification of the material from the Nymboida Coal Measures dealt with here.

*Occurrence.* This species has only been previously identified in Argentina. Frenguelli (1947) describes and figures specimens from the Potrerillos Formation of the Cacheuta Basin and the Los Rastros Formation of the Ischigualasto-Villa Union Basin. It has also been recorded from the Chihui Formation of the Chihui-Tronquimal Basin (Menendez, 1951) and also from the El Tranquilo Basin (Herbst, 1971).

*Comparable Basin Creek Formation material.* A large portion of a small bipinnate frond (UNEF14121) from UNEL1489.

## Genus LOBIFOLIA Lebedev and Rasskazova 1968

*Lobifolia dejerseyi* Retallack sp. nov.

## Fig. 5A

?1891 *Thinnfeldia odontopteroides*; Etheridge, p. 10, pl. 2, figs 1, 2.

1924 *Cladophlebis lobifolia*; Walkom, p. 81, text fig. 2, pl. 15, fig. 2.

1928 *Cladophlebis lobifolia*; Walkom, p. 460.

v1958 ?*Hoegia* sp.; De Jersey, p. 86, text figs 3, 4.

?1961b *Cladophlebis* sp. (cf. *C. shensiensis*); Lele, p. 73, pl. 2, fig. 15.

1975 *Cladophlebis lobifolia*; Flint and Gould, pl. 1, figs 4, 5, 6.

(1976) *Cladophlebis lobifolia*; Gould and Retallack in Bourke *et al.*, pl. 1, fig. 1.

*Holotype.* UNEF14102; a well-preserved frond fragment figured by Flint and Gould (1975, pl. 1, fig. 4).

*Type locality.* UNEL1489, open cut workings of Nymboida Colliery; Farquhars Creek Seam (member) of the Basin Creek Formation, Nymboida Coal Measures New South Wales (McElroy, 1963) of Aniso-Ladinian age (Flint and Gould, 1975).

*Derivation.* In honour of Dr N. J. De Jersey of the Queensland Geological Survey Palynological Division.

*Diagnosis.* *Lobifolia* in which the basal pinnules of the pinna have acute apices and the basal margin constricted basiscopically and flared aeroscopically. Midvein of the pinnules arising near the basiscopic margin, dissolving before half its length into once or twice forked lateral veins radiating evenly at very acute angles to each other. Pinnules progressively narrower and more falcate (cladophlebid) towards the pinna apex.

*Description.* These are large bipinnate fronds with a stout striated primary rachis and long opposite or alternate pinnae. The pinnules are opposite to subopposite, strongly inclined forward, broadly triangular, acutely pointed and

more or less falcate. The basal pinnules of the pinnae have a broad basal margin, auriculate basiscopically and flared, sometimes almost lobate, acroscopically. The basicopic lobe of the lowermost pair of pinnules of the pinnae may overlap the primary rachis. The basal auriculation and flaring of the pinnules becomes less marked towards the pinna apex, where the pinnules are narrower and more falcate (cladophleboid) in appearance. The strong midvein of the pinnules arises close to the basiscopic margin but dissolves into lateral veins before half its course to the pinnule apex. The lateral veins dichotomise once or twice, evenly radiating from near the origin of the midvein at a very acute angle to each other.

The fragment (Fig. 5A) from UNEL1564 is the smallest known specimen. The holotype is of intermediate size. Fronds may have pinnules up to 12.7 mm long (UNEF14715).

*Dimensions of the holotype.* Preserved rachis length = 80.9 mm; maximum rachis width (lower end) = 3.9 mm; minimum rachis width (upper end) = 1.6 mm; lowest right pinna length = 75 mm; second lowest left pinna rachis width = 0.9 mm; third lower pinnule on second lowest left pinna, width along pinna rachis = 6.4 mm, length along midvein = 9.3 mm, veins at margin = 22.

*Comparison.* Of the species described by Lebedev and Rasskazova (1968), our material is closest to *Lobifolia novopokrovskii* but has more constricted pinnule bases and more acutely angled, less copiously forked lateral veins than the Russian species. *Cladophlebis goeppertiana* of Du Toit (1927, p. 319 fig. 1) may prove to be another Gondwanaland species of *Lobifolia*. Its pinnules are longer and lateral veins at a less acute angle to the pinnule midrib than in *L. dejerseyi*.

*Remarks.* The genus *Lobifolia* (Lebedev and Rasskazova, 1968) separates from the form genus *Cladophlebis* some of the species previously excluded by Frenguelli (1947, pp. 40–41). These are characterised by basally constricted and lobed lower pinnules of the pinnae, which may overlap the primary rachis. *Lobifolia* leaves possibly belong to the family Dicksoniaceae as the genus includes sterile leaves of *Eboracia lobifolia* (Harris, 1961, figs 62, 63).

*Occurrence.* This species is known from the Nymboida Coal Measures (De Jersey, 1958; Flint and Gould, 1975) and the Gunnee Beds near Delungra (Gould and Retallack in Bourke *et al.*, in press), New South Wales, and the Esk Trough (Walkom, 1924, 1928), Queensland. It may also occur in a bore near Leigh Creek, South Australia (Etheridge, 1891), and in the middle Gondwana Beds of the South Rewa Basin, India (Lele, 1961b).

*Cloughers Creek Formation material.* One fragment (Fig. 5A) from UNEL1564 and an isolated pinnule (UNEF146701) from UNEL1563.

*Goolang Siltstone Member material.* Specimens described by De Jersey (1958) as ?*Hoegia* sp., now lodged in the Australian Museum, Sydney (AMF48236, AMF48235).

*Basin Creek Formation material.* In addition to the holotype the following have been collected from UNEL1489: UNEF14103 (Flint and Gould, 1975, pl. 1, fig. 6), UNEF14104 (Flint and Gould, 1975, pl. 1, fig. 5), UNEF14715.

## DIVISION PTERIDOSPERMOPHYTA

### ORDER PTERIDOSPERMALES

#### Family CORYSTOSPERMACEAE

Genus *DICROIDIUM* Gothan emend. Townrow 1957: 26

Current opinion (Anderson and Anderson, 1970; Archangelsky, 1968c; Boureau and Doubinger, 1975) is somewhat divided on which of the six genera recognised by Frenguelli (1943) for *Dicroidium*-like leaves are worth retaining.

All these have more or less similar cuticles. In addition to *Dicroidium*, I believe that only *Johnstonia* and *Xylopteris* should be retained. These are easy to recognise and sometimes characterise probable xerophytic florules. Along with Townrow (1957), Bonetti (1966) and Archangelsky (1968c), I include *Diplasiophyllum*, *Dicroidiopsis* and *Zuberia* within *Dicroidium*.

*Dicroidium dubium* (Feistmantel) Gothan 1912 var. *tasmaniense* (Anderson and Anderson 1970, non Johnston 1887) Retallack comb. nov.

Figs. 6D, E.

?1887 *Neuropteris tasmaniensis*; Johnston, pl. 2, fig. 2.

?1888 *Neuropteris tasmaniensis*; Johnston, pl. 23, fig. 2.

1899 *Thinnfeldia incisa*; Solms-Laubach, p. 599, pl. 14, figs 3-4.

p1908 *Thinnfeldia odontopteroides*; Seward, p. 92, text figs 3B, 4 only.

1928 *Thinnfeldia talbragarensis*; Walkom, p. 46, pl. 17, fig. 1.

p1944d *Dicroidiopsis dubia*; Frenguelli, p. 521, lam. 1, fig. 1 only, lam. 2.

1947 *Thinnfeldia talbragarensis*; Jones and De Jersey, p. 17, text figs 9, 10, pl. 1, fig. 5.

1958 *Dicroidium* sp.; De Jersey, p. 84.

1965 "*Thinnfeldia*" *talbragarensis*; Hill Playford and Woods, pl. T4, fig. 5.

1970 *Dicroidium tasmaniensis*; Anderson and Anderson, chart 9.

*Varietal lectotype.* N-UU786 figured by Anderson and Anderson (1970, chart 9).

*Description.* The two specimens from UNEL1564 (Figs 6D, E) are typical for this variety. Their short relatively broad pinnae have rounded pinna lobes and the lateral veins curve strongly from the midrib to become almost perpendicular to the margin.

*Comparison.* This variety has shorter, broader pinnae with well rounded lobes unlike the holotype of *Dicroidium dubium* (Feistmantel) Gothan 1912 (*Gleichenites dubius* of Feistmantel, 1878, refigured as *Gleichenia dubia* by Feistmantel, 1890). For the same reasons this variety differs from *Sphenopteris bergina* Jones and De Jersey, 1947, which is a forking frond with *Dicroidium*-like cuticle and a junior synonym of *Dicroidium dubium* s.s. The shorter, smaller, narrower, less coriaceous, more distinctly veined pinnae of this variety are quite unlike *Dicroidium australe* and *D. walkomii* of Jacob and Jacob (1950). *Dicroidium incisum* (sensu Anderson and Anderson, 1970) has more obliquely directed lateral venation and less strongly asymmetrically incised pinna margins.

*Remarks.* Of the many names applied to bipinnatifid *Dicroidium* leaves the earliest valid record is *Gleichenites dubius* of Feistmantel (1878). Johnston (1888, 1896) included bipinnatifid fronds under *Thinnfeldia polymorphum* and *Neuropteris tasmaniensis*. However his drawings are poor and the specimens cannot be found. Some Jurassic leaves of *Thinnfeldia talbragarensis* Walkom 1921 are very similar but definitely unforked (Australian Museum specimen number AMF2664). Townrow (1965) includes these Jurassic leaves in *Pachypteris crassa*.

*Occurrence.* In Australia this variety occurs in the Esk Trough (Walkom, 1928), the Ipswich Coal Measures (Jones and De Jersey, 1947; Hill *et al.*, 1965), and the Nymboida Coal Measures (Flint and Gould, 1975). It is also known from cycle 2 of the Molteno Beds (Anderson, 1974) of South Africa, La Ternera in Chile (Solms-Laubach, 1899) and the Ischichuca Formation of the Ischigualasto-Villa Union Basin, Argentina (Frenguelli, 1944d).

*Comparable Goolang Sitstone Member material.* The specimen of *Dicroidium* sp. which De Jersey (1958) compares with *Thinnfeldia talbragarensis* Walkom 1921.

*Comparable Basin Creek Formation material.* UNEF14716 from UNEL1489.

*Dicroidium eskense* (Walkom) Jacob and Jacob 1950

## Fig. 6F

- ?1896 *Thinnfeldia Buftoni*; Johnston, fig. 18.  
 ?1903 *Thinnfeldia rhomboidalis*; Seward, pl. 8, fig. 1.  
 ?1921 *Thinnfeldia* sp.; Seward and Holttum, p. 41, pl. 11B.  
 1927 *Thinnfeldia narrabeenensis*; Du Toit, p. 333, pl. 18, fig. 3.  
 \*1928 *Thinnfeldia eskensis*; Walkom, p. 459, pl. 27, fig. 2, pl. 28, fig. 1.  
 1943 *Diplasiophyllum moltenense*; Frenguelli, p. 300.  
 1958 *Dicroidium narrabeenense*; De Jersey, p. 84.  
 p1965 "*Thinnfeldia*" *eskensis*; Hill, Playford and Woods, pl. T5, fig. 4 only.  
 p1967a cf. *Diplasiophyllum acutum*; Townrow, p. 464, fig. 3E only.  
 1975 *Dicroidium eskense*; Flint and Gould, pl. 2, fig. 3.

*Holotype*. University of Queensland number UQF1733, figured by Walkom (1928, pl. 28, fig. 1).

*Description*. Only one specimen (Fig. 6F) was found at UNEL1564, but this species is quite common in the Basin Creek Formation. In addition to the relatively oblique lateral veins, constricted bases and acute apices of the pinnae noted by Walkom (1928), a characteristic feature of these leaves is a deep sinus in the basal acroscopic margin of pinnae in the middle part of the length of the primary rachis.

*Comparison*. *Dicroidium eskense* may agree in size with unipinnate forking fronds which have been referred to *Dicroidium narrabeenense* (Dun) Townrow 1957, *Dicroidium hughesii* (Feistmantel) Townrow 1957, *Dicroidium lancifolium* (Morris) Gothan 1912 and *Dicroidium acutum* (Walkom) Jacob and Jacob 1950. However it differs from all these in its more oblique lateral venation and the acroscopic sinus and basiscopic constriction of the pinna bases. Fragments of *Dicroidium eskense* may be confused with the unforked leaves of *Kurtziana* (Frenguelli, 1942d, 1944b). In *Kurtziana* the pinna midribs are attached on top of the rachis or to a central ridge of the rachis. One of the specimens of "*Thinnfeldia*" *eskensis* figured by Hill *et al.*, (1965, pl. T5, fig. 3) is probably *Kurtziana brandmayri* Frenguelli 1944b. *Dicroidium eskense* combines the diagnostic characters of both *Dicroidiopsis* and *Diplasiophyllum*. These genera of Frenguelli (1943) are not widely accepted (Townrow, 1957, p. 29).

*Remarks*. *Thinnfeldia buftonii* (Johnston, 1896, fig. 18) may prove to be the holotype and senior synonym of this species. However Johnston's figure is unclear and the specimen cannot be found. The specimen described as *Dicroidium eskensis* by Jacob and Jacob (1950, p. 111) is more likely a frond of *Dicroidium lancifolium* (Morris) Gothan 1912.

The forking specimen from the Cloughers Creek Formation (Fig. 6F) and a further forking specimen (part and counterpart UNEF13346, UNEF13350) from the Basin Creek Formation indicate unequivocally that these leaves belong within the genus *Dicroidium*.

*Occurrence*. This species is best known from the Esk Trough (Walkom, 1928; Hill *et al.*, 1965) of Queensland, the Nymboida Coal Measures (De Jersey, 1958; Flint and Gould, 1975) of New South Wales and the lower Molteno Beds (Stage C of Du Toit, 1927, and cycle 2 of Anderson, 1974) of South Africa.

*Comparable Basin Creek Formation material*. UNEF13334 (Flint and Gould, 1975, pl. 2, fig. 3), UNEF13346 and UNEF13350 (part and counterpart of a forking frond), and UNEF14609, all from UNEL1489.

*Dicroidium incisum* (Frenguelli) Anderson and Anderson 1970

## Figs 6A-6C

- p1927 *Pachypteris incisum*; Du Toit, text fig. 8A only.  
 1928 *Neuropteridium moombraense*; Walkom, p. 463, pl. 27, fig. 4.

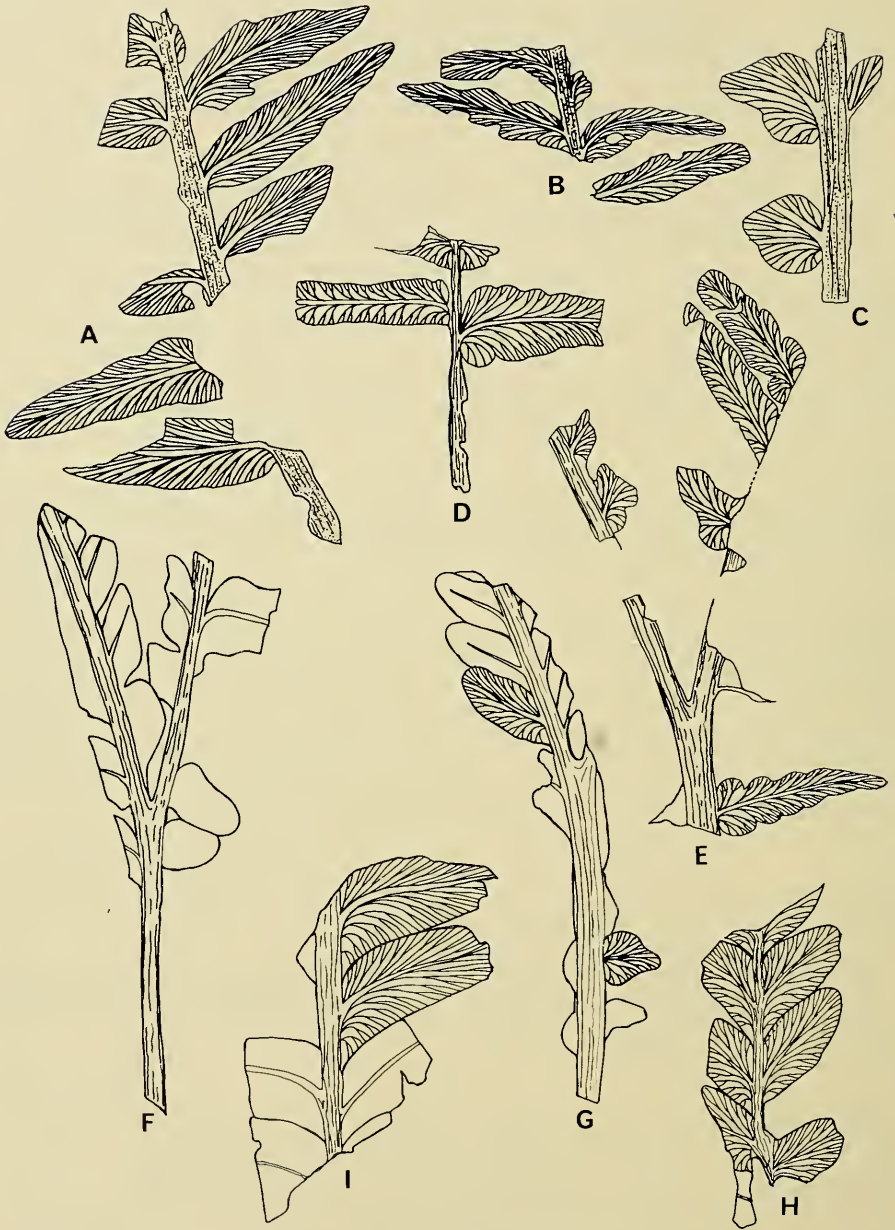

Fig. 6. A-C. *Dicroidium incisum*. D-E. *D. dubium* var. *tasmaniense*. F. *D. eskense*. G-H *D. odontopteroides* var. *remotum*. I. *D. lancifolium*. A. UNEF14651; B. UNEF-14660; C. UNEF14642; D. UNEF14681; E. UNEF14659; F. UNEF14682; G. UNEF-14653; H. UNEF14700; I. UNEF14698. All from UNEL1564. All natural size.



\*1943 *Dicroidiopsis incisa* ; Frenguelli, p. 289.

1947 ?*Neuropteridium* sp. ; Jones and De Jersey, p. 33, text fig. 21.

?1952 *Pachypteris* sp. ; Gordon and Brown, p. 5, pl. 1, fig. 1.

?1969 *Dicroidium incisum* ; Stipanovic and Bonetti, p. 1093.

1970 *Dicroidium incisa* ; Anderson and Anderson, chart 9.

1975 *Dicroidiopsis incisa* ; Boureau and Doubinger, p. 664, fig. 568 bis.

*Description.* This species is easily recognised by its somewhat constricted pinna bases, its asymmetrically and weakly lobed pinna margins and very clear lateral veins at an acute angle to the pinna midvein. One leaf (Fig. 6A and its counterpart UNEF14652) is evidently part of a forking frond, because of the smaller pinnae inside the rachis curve. Fig. 6B is a more delicate fragment from near the apex of the frond. Fig. 6C is a more robust portion of rachis below the fork.

*Comparison.* *Dicroidium incisum* is distinct from *D. eskense* (Walkom) Jacob and Jacob 1950 in its lobate pinna margins and less constricted pinnae bases without an aroscopic sinus. The pinnules and their lobes have a less rounded outline in *D. incisum* than in *D. dubium* var. *tasmaniense* comb. nov. and *D. australe* and *D. walkonii* of Jacob and Jacob (1950). The pinnules of *D. incisum* are more broadly lanceolate and less coriaceous than in the holotype of *Dicroidium dubium* (Feistmantel) Gothan 1912.

*Remarks.* The Cloughers Creek Formation material is identical to one of the fronds Du Toit (1927, text fig. 8A) referred to "*Pachypteris incisa* (Saporta) pars.". Frenguelli (1943) made Du Toit's fig. 8A the type of an essentially new concept : "*Dicroidiopsis incisa* Du Toit sp.". Anderson and Anderson (1970) cite Du Toit's fig. 8A and figure a comparable range of forms called "*Dicroidium incisa*". They place the other specimens of *Pachypteris incisa sensu* Du Toit (1927) in an informal group agreeing in concept with *Xylopteris ? natalensis* Frenguelli 1943. Some unfigured South American records of this species are difficult to interpret. "*E. incisa*" in Archangelsky's (1968a) list is probably a misprint as it follows species of *Dicroidiopsis*. *Dicroidium incisum* of Stipanovic and Bonetti (1969) could refer to *D. incisum* (Frenguelli) Anderson and Anderson 1970, *Xylopteris ? natalensis* Frenguelli 1943 or some other species, as it was described in an unpublished thesis (Bonetti, 1963) which I have not seen.

*Occurrence.* This species is known from the lower and middle Molteno Beds (Stages C and D of Du Toit, 1927, and cycle 2 of Anderson, 1974) in South Africa, and the Esk Trough (Walkom, 1928) and Ipswich Coal Measures (Jones and De Jersey, 1947) in Queensland.

*Dicroidium lancifolium* (Morris) Gothan 1912 (s.s. Anderson and Anderson 1970)

#### Fig. 6I

*Description.* A small fragment (Fig. 6I) was found at UNEL1563.

*Comparison.* Fig. 6I has broad pinnae, probably with rounded apices, most like those figured by Kurtz (1921, pl. 18, fig. 246) as *Thinnfeldia intermedia*.

*Dicroidium lancifolium* is distinguished from *D. odontopteroides* by its more elongate pinnae, as in the variation diagram of Anderson and Anderson (1970).

*Remarks.* Contrary to Townrow (1957) I believe that this species should be maintained as separate from *D. odontopteroides* because it has a different stratigraphic range and is not always associated with the same reproductive organs.

*Dicroidium lancifolium* is found in older Triassic rocks such as the upper Beaufort Beds of South Africa (Du Toit, 1927) and the upper Narrabeen Group of New South Wales (Walkom, 1925c) as well as Middle to Late Triassic rocks. However *D. odontopteroides* and its presumed reproductive structures, *Pteruchus johnstonii* (Feistmantel) Townrow 1962 and *Pilophorosperma* spp. Thomas 1933, first appear

in Middle Triassic rocks such as the middle Molteno Beds (Stage C) of South Africa and the Wianamatta Group of New South Wales.

*Occurrence.* *Dicroidium lancifolium* is very widely distributed in middle Triassic rocks of Gondwanaland. The oldest reliable records are probably those from the upper Beaufort Beds of South Africa (Du Toit, 1927) and the upper Narrabeen Group, Sydney Basin, New South Wales (Walkom, 1925*c*). In Queensland it persists to the top of the Ipswich Coal Measures but has not been found in the overlying Bundamba Group (Jones and De Jersey, 1947). In South Africa it ranges as high as the middle Molteno Beds (Stage D of Du Toit, 1927, and cycle 4 of Anderson, 1974). In Argentina it is found as high as the lower plant bearing level of the Ischigualasto Formation of the Ischigualasto-Villa Union Basin and the Cacheuta Formation of the Cacheuta Basin (Frenguelli, 1948). Specimens from Punta Puquen in Chile appear to underly a Norian marine fauna (Azcarate and Fasola, 1970). At La Ternera in Chile (Solms-Laubach, 1899) and Paso Flores in Argentina (Frenguelli, 1948) it occurs in fossil floras apparently underlying Liassic marine rocks. A supposed pinna apex in the Liassic flora of Piedra Pintada (Frenguelli, 1937) cannot be accepted as convincing evidence of *D. lancifolium*. Arber (1917, pl. 5, fig. 2, New Zealand Geological Survey number B62·7) figured a specimen of *D. lancifolium* from the Middle Jurassic (Speden, 1958) of Owaka Creek, New Zealand. I have examined this specimen. The "fork" in this case is symphyodial and formed by the accidental juxtaposition of two robust *Cladophlebis* pinnae whose rachis have quite dissimilar textures. The range of *D. lancifolium* can thus be taken as late Seythian to Norian, as suggested by Stipanovic and Bonetti (1969, p. 1097).

*Comparable Basin Creek Formation material.* UNEF14608 from UNEL1489.

*Dicroidium odontopteroides* (Morris) Gothan 1912 (*s.s.* Anderson and Anderson 1970) var. *remotum* (Szajnocha) Retallack comb. nov.

Figs 6G–6H

\*1889 *Neuropteris remota* ? ; Szajnocha, p. 226, pl. 2, fig. 3.

1944e *Dicroidium remotum* ; Frenguelli, p. 449, pls 1–3.

1948 *Dicroidium remotum* ; Frenguelli, pp. 234, 291.

1968a *Dicroidium remotum* ; Archangelsky, p. 80.

p1975 *Dicroidium odontopteroides* ; Flint and Gould, pl. 3, fig. 11 only.

1975 *Dicroidium remotum* ; Boureau and Doubinger, p. 668.

*Varietal type.* The specimen from Cacheuta in Argentina figured by Szajnocha (1889, pl. 2, fig. 3a).

*Description.* Some fragments (UNEF14699–700) from UNEL1463 are very similar to the forking specimen (fig. 6G) from UNEL1564.

*Comparison.* This variety is a new combination of *Dicroidium remotum* Frenguelli 1944e. This has relatively more elongate, rounded, basally constricted pinnules than is usual for *D. odontopteroides* (*sensu* Anderson and Anderson, 1970). In addition, the pinnules inside the rachis fork are at a more acute angle to the rachis and those below the fork are almost triangular cordate. The pinnules of *D. odontopteroides* var. *remotum* are not as long and narrow as those of the holotype of *D. odontopteroides* (Townrow, 1957) or those of *D. lancifolium* (*sensu* Anderson and Anderson, 1970). *Dicroidium odontopteroides* var. *remotum* is separated from *Johnstonia* (*sensu* Frenguelli, 1943) by the more common forms of *D. odontopteroides* and *D. obtusifolium* (Johnston) Townrow 1966a with short pinnules.

*Occurrence.* This variety is best known from the lower portions of Argentine Triassic sequences, the Las Cabras Formation of the Cacheuta Basin and the Cortaderita Formation of the Barreal-Hilario Basin (Frenguelli, 1948).

*Dicroidium odontopteroides* s.s. is very widely distributed in Middle to Late Triassic rocks of Gondwanaland (Townrow, 1967a; Frenguelli, 1943). The upper limit in South Australia and Tasmania is probably close to the Rhaetio-Liassic boundary (Townrow, 1966a). However, at this level *D. odontopteroides* has short pinnules of a type intergrading into *D. obtusifolium* quite unlike *D. odontopteroides* var. *remotum*. In Queensland *D. odontopteroides* persists into the Raceview Formation of the Bundamba Group (Jones and De Jersey, 1947) and in South Africa it persists to the top of the Molteno Beds (Stage E of Du Toit, 1927, and cycle  $\pm 5$  of Anderson, 1974).

Balme and Helby (1973) record *D. odontopteroides* in the Tuggerah Formation of the Sydney Basin. However I cannot locate their specimen and am convinced that the earliest records of this species in this region are the specimens of Feistmantel (1878, 1890) from the Wianamatta Group. The most securely dated early occurrence of *D. odontopteroides* is a range of specimens I am currently studying for the New Zealand Geological Survey. These were found at Mount Potts, New Zealand, underlying Kaihikuan (=Ladinian) marine rocks. *Comparable Basin Creek Formation material.* UNEF14609 from UNEL1489 is an identical frond to Fig. 6G; UNEF13455 from UNEL1495 is a similar but smaller frond (Flint and Gould, 1975, pl. 3, fig. 11).

*Dicroidium superbum* (Shirley) Townrow 1957

Figs 8A–8B

?1889 *Thinnfeldia trilobita* (?); Feistmantel, p. 65, pl. 2, figs 2, 2a, 2b.

v1898 *Sphenopteris superba*; Shirley, p. 18, pls 4, 8.

v1917a *Sphenopteris superba*; Walkom, p. 27, pl. 8, fig. 3.

?1924 (?) *Sphenopteris superba*; Walkom, p. 86.

?1927 *Thinnfeldia feistmanteli* var. *trilobita*; Du Toit, p. 22.

1947 *Sphenopteris superba*; Jones and De Jersey, p. 31, pl. 5, fig. 2C.

v1965 *Dicroidium superbum*; Hill, Playford and Woods, pl. T4, fig. 6.

p1970 *Dicroidium tripinnate* sp. A; Anderson and Anderson, 1970, chart 9, excluding examples with linear segments.

p1970 *Dicroidium tripinnate* sp. B; Anderson and Anderson, 1970, chart 9, excluding examples with linear segments.

*Description.* Only two fragments (Figs 8A, 8B), probably from the same frond were found at UNEL1564. The broad pinnules have clear venation and generally three marginal lobes. The primary and secondary rachis are conspicuously grooved.

*Comparison.* The material is most similar to that of Hill *et al.* (1965, pl. T4, fig. 6). The lobation of the pinnules in *Dicroidium superbum* is much more marked than in *D. zuberi* (Szajnocha) Archangelsky 1968c, which may show incipient lobing of the pinnules (Feistmantel, 1890, pls 23, 24; Frenguelli, 1944a, figs 1–4). The pinnules of *D. superbum* are not as elongate as in the tripinnatifid fronds variously called *Thinnfeldia sphenopteroides* Seward 1908, *Zuberia barrealensis* Frenguelli 1944a and *Thinnfeldia* sp. Arnold 1947 (fig. 117).

*Remarks.* After examining Shirley's (1898) material (including the holotype) I conclude that these are somewhat torn remains of leaves with formerly broader, lobed pinnules. For this reason I exclude from *D. superbum* specimens with narrow coriaceous pinnules and acute pinna apical points such as those ascribed to this species by Townrow (1957) and Anderson and Anderson (1970, chart 9, in part).

*Occurrence.* *Dicroidium superbum* is most common in the Esk Trough, but is also found at some levels in the Ipswich Coal Measures of Queensland (Jones and De Jersey, 1947). It also occurs in the lower Molteno Beds (Stage C of Du Toit, 1927, and cycle 2 of Anderson, 1974) in South Africa.

*Comparable Basin Creek Formation material.* A pinna fragment (UNEF14610) from UNEL1469.

*Dicroidium zuberi* (Szajnocha) Archangelsky 1968c

Fig. 7

*Description.* Several specimens (Figs 7A, 7B, 7C) of intermediate size for this species were found at UNEL1564. They have subrhombic to rounded pinnules. The basiscopic pinnule of the pinnae overlaps the rachis by less than half its length. Some fragments from UNEL1563 (Figs 7D, 7E, 7F) are similar to the more complete examples from UNEL1564.

*Comparison.* There is considerable variation within bipinnate *Dicroidium* leaves. This material ranges between *Zuberia zuberi* (of Frenguelli, 1944a) and *Dicroidium sahnii* (of Seward, 1933; Rao and Lele, 1962). This variation is not broad enough to include the larger interpinnuled *Zuberia feistmantelii* (of Frenguelli, 1944c) or the smaller semi-pinnatifid *Dicroidium* int. sp. B (of Anderson and Anderson, 1970). Some specimens of the Jurassic *Pachypteris crassa* (Walkom, 1921; Townrow, 1965) are similar but definitely unforked (Australian Museum specimen number AMF2664).

*Remarks.* I agree with Bonetti (1966) and Archangelsky (1968c) that most of the distinctions made within bipinnate *Dicroidium* leaves by Frenguelli (1943, 1944a) are not clear enough to be recognised at a species level. Our material is not sufficiently distinctive to fall into any of Frenguelli's (1943, 1944a) categories as a variety of *D. zuberi*.

*Occurrence.* Frenguelli (1944a, 1948) has pointed out that flora dominated by *D. zuberi* are generally lowest in the Argentine Triassic successions, although *D. zuberi* does persist less prominently at higher levels. Frenguelli (1944a) figures abundant material from the Las Cabras Formation of the Cacheuta Basin and the Cortaderita Formation of the Barreal-Hilario Basin. Fragments of this species have been found as high as the (?) Norian, in the Ischigualasto Formation of the Ischigualasto-Villa Union Basin (Archangelsky, 1968c) in Argentina and at Punta Puquen in Chile (Azcarate and Fasola, 1970). In India it occurs in the Parsora Beds (Seward, 1933). In South Africa it occurs in the upper Beaufort Beds and the lower and middle Molteno Beds (Stages B, C, D of Du Toit, 1927, and cycle 2 of Anderson, 1974).

In the Sydney Basin *D. zuberi* (Walkom, 1925c, 1932; Jacob and Jacob, 1950; Townrow, 1957) dominates Scytho-Anisian fossil flora found from the base of the Bald Hill Claystone to the Brookvale shale lens of the Hawkesbury Sandstone. Similar *D. zuberi* dominated fossil floras are found in the Camden Head Claystone of the Lorne Basin New South Wales (Pratt and Herbert, 1973), the Erskine Sandstone of the Canning Basin, Western Australia (Antevs, 1913; Townrow, 1957) and the *Cylostrobus* macroflora of Tasmania (Banks and Clarke, 1973). By the level of the Wianamatta Group of the Sydney Basin, *D. zuberi* is rarer, smaller and subordinate to *D. odontopteroides* (*sensu* Anderson and Anderson, 1970). *Dicroidium zuberi* also persists in the *D. odontopteroides* dominated fossil flora of the Esk Trough (Walkom, 1924, 1928) and Ipswich Coal Measures (Jones and De Jersey, 1947) in Queensland, the Feldspathic Sandstone Series in Tasmania (Walkom, 1925a, 1925b) and the Leigh Creek Coal Measures in South Australia (Chapman and Cookson, 1926; Etheridge, 1902; Pledge, 1974). It has not been found in the Raceview Formation of the Bundamba Group (Jones and De Jersey, 1947).

The *D. zuberi* dominated fossil flora of the upper Narrabeen Group of New South Wales and the upper Beaufort Beds of South Africa are probably as old as Scythian. *Dicroidium zuberi* probably persisted until the Norian in the Ischigualasto Formation and Punta Puquen of South America. It could range as high as the Rhaetian at Leigh Creek in South Australia. However this palynological age of Playford and Dettmann (1965) has been seriously questioned by Anderson and Anderson (1970, chart 14).

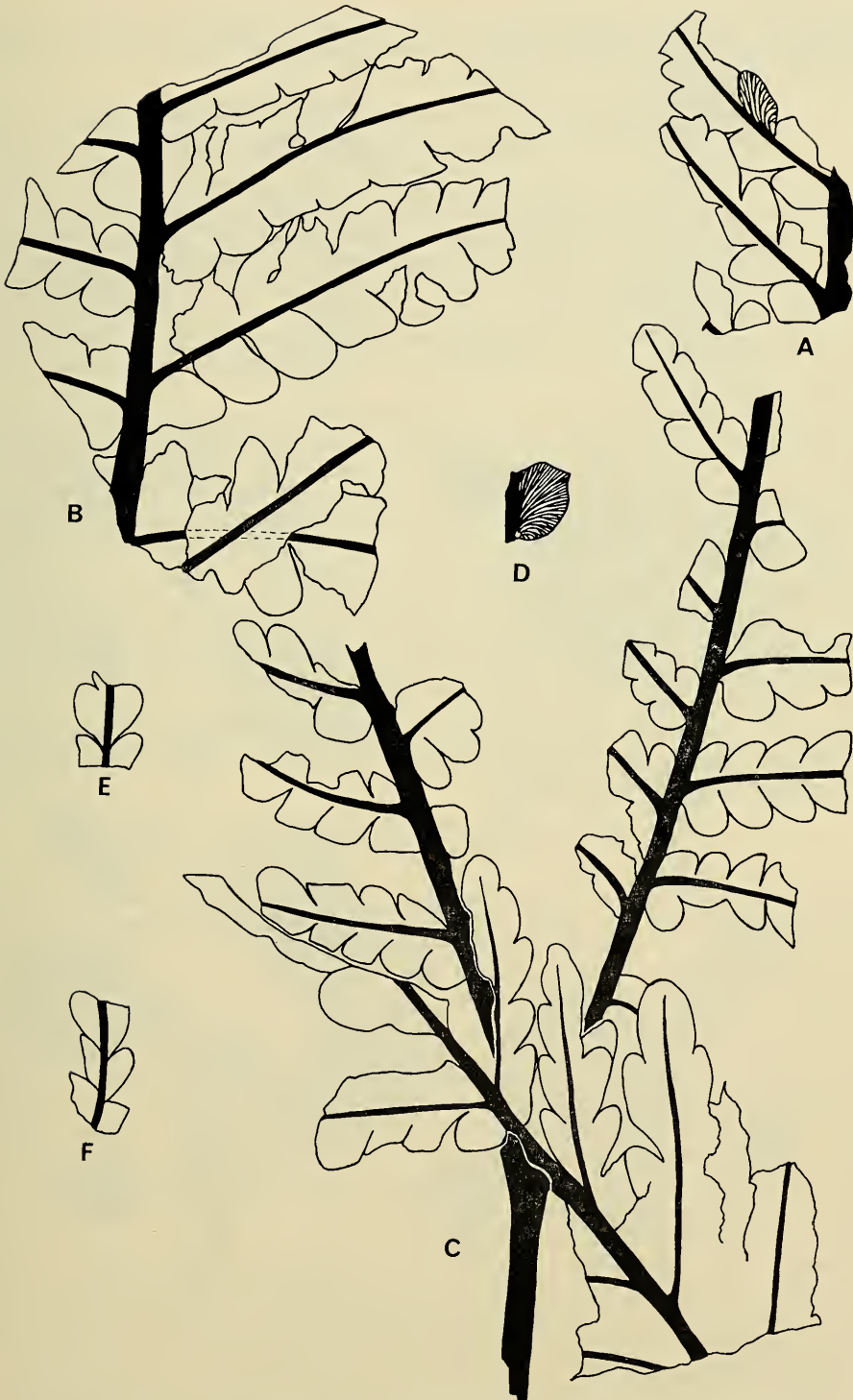

Fig. 7. A-F. *Dicroidium zuberi*. A. UNEF14657; B. UNEF14655; C. UNEF14656; D. UNEF14709; E. UNEF14701; F. UNEF14702. A-C. Frond fragments from UNEL1564; D-F. Comparable pinnule and pinna fragments from UNEL1563. All natural size.

*Comparable Basin Creek Formation material.* Two specimens figured as *Hoegia papillata* by Flint and Gould (1975, pl. 2, figs 4, 5) and UNEF13326 from UNEL1489 and UNEF13472 from UNEL1495.

Genus *PTERUCHUS* Thomas emend. Townrow 1961 : 289

*Pteruchus dubius* (Thomas) Townrow 1961

Fig. 8D

*Description.* One rock specimen (UNEF14695) from UNEL1561 bears two impressions of microsporangial aggregates. One aggregate consists of 50 pollen sacs in a group 4.4 mm wide. The arrangement of the pollen sacs indicates this is about half the width of the microsporophyll. The individual pollen sacs show clear cellular striation and a prominent peg-like internal mould of the rounded apical end of the dehiscence slit. The second aggregate (Fig. 8D) shows about 30 pollen sacs arranged with bilateral symmetry on a lamina about 8.8 mm wide.

*Comparison.* The aggregates are probably fragments of long *Pteruchus* heads. They are most similar to the South American *Pterorrachis barrealensis* (Frenguelli, 1942b, 1944a), which is the supposed pollen organ of *Dicroidium zuberi* (Szajnocha) Archangelsky 1968c. Townrow (1961) regarded *Pterorrachis barrealensis* as a junior synonym of *Pteruchus dubius* although the South American microsporophylls have longer heads than the Molteno material on which *P. dubius* is based.

*Occurrence.* *Pteruchus dubius* is known from the middle Molteno Beds (Stage D of Du Toit, 1927, and cycle 2 of Anderson, 1974; Townrow, 1961; Thomas, 1933) of South Africa and the Ipswich Coal Measures (Hill *et al.*, pl. T6, fig. 3) of Queensland. *Pterorrachis barrealensis* is known from the Barreal and Cortaderita Formation of the Barreal-Hilario Basin in Argentina (Frenguelli, 1944a; Stipanovic and Bonetti, 1969).

*Comparable Basin Creek Formation material.* A large slab (UNEF13395) bearing *Cladophlebis* fronds from UNEL1489 also contains a similar short fragment of a microsporangiate head.

*Pteruchus johnstonii* (Feistmantel) Townrow 1962

Fig. 8C

*Description.* Only one specimen was found in part and counterpart (UNEF14661, UNEF14690) at UNEL1564. The four fleshy subrectangular microsporangiate heads bear numerous pendant cigar-shaped dehisced pollen sacs.

*Comparison.* I agree with Townrow (1961) that *Pteruchus* should not include specimens with spirally inserted pollen sacs, such as *Pteruchus indicus* Pant and Basu 1973, *P. nipurensis* Srivastava 1974 and *P. edwardsi* Thomas 1933. These species are otherwise quite similar to *P. johnstonii* and should perhaps be placed in a separate genus. Townrow (1962) regards *Sphenolepis rhaetica* Geinitz as a *nomen vanum* and with it disappears any record of South American forms which are comparable with *P. johnstonii* (Archangelsky, 1968a, table 3; Stipanovic and Bonetti, 1969, fig. 1a; Jain and Delevoryas, 1967, p. 572). Townrow (1961) gives a detailed comparison of the species of *Pteruchus*.

*Remarks.* This is the supposed microsporophyll of *Dicroidium odontopteroides* and *D. lancifolium* (Townrow, 1961).

*Occurrence.* Townrow (1961) relocated the holotype of the species from the Feldspathic Sandstone Series, of Lords Hill, Hobart, Tasmania. It also occurs in the Ipswich Coal Measures of Queensland and the middle Molteno Beds (Stage D of Du Toit, 1927, and cycle 2 of Anderson, 1974) of South Africa (Townrow, 1961).

*Comparable Basin Creek Formation material.* An almost identical specimen (UNEF14612/3, part/counterpart) from UNEL1489.

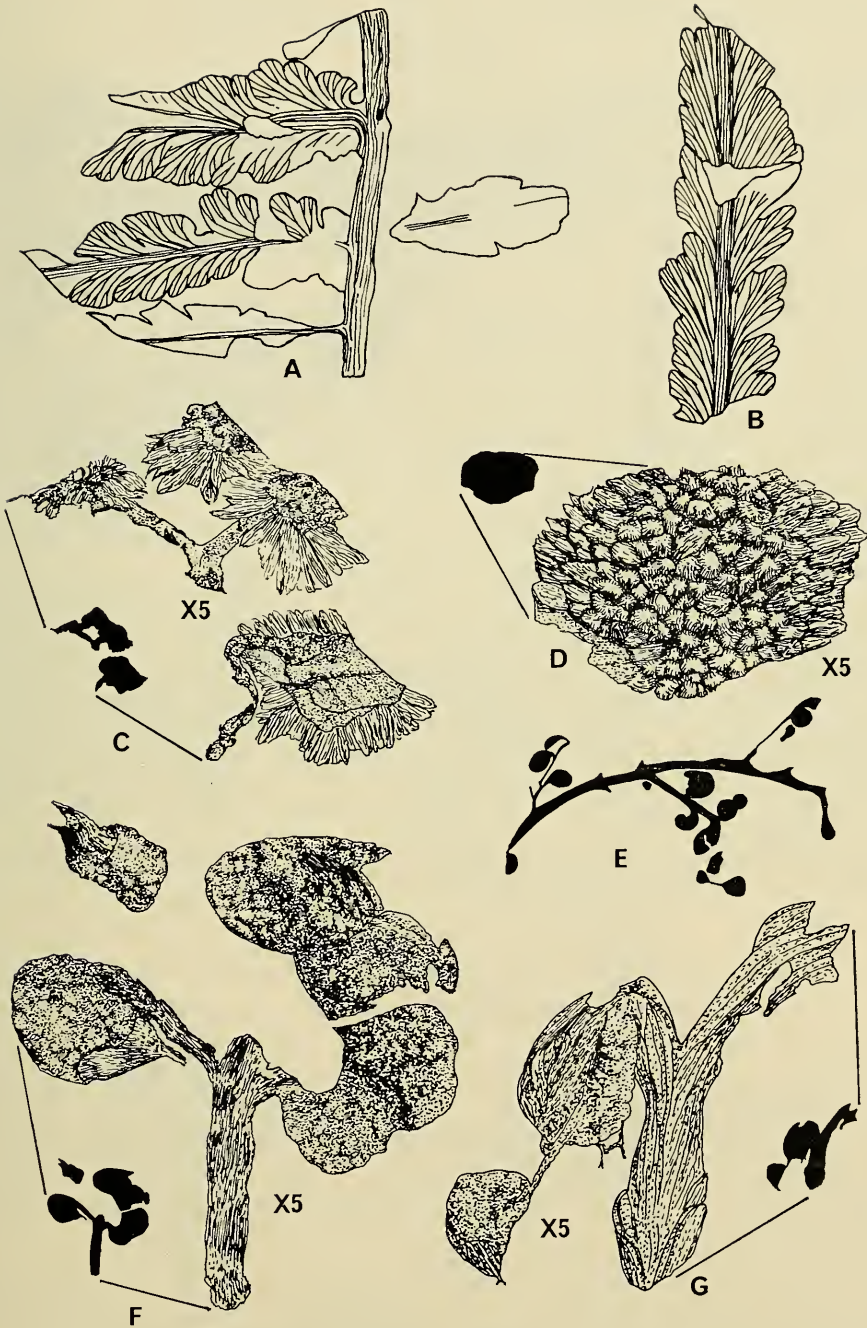

Fig. 8. A–B. *Dicroidium superbum*. C. *Pteruchus johnstonii*. D. *P. dubius*. E–G. *Pilophorosperma* sp. cf. *P. costulatum*. A. UNEF14674, natural size; B. UNEF14675, natural size; C. UNEF14661,  $\times 5$ ; D. UNEF14695,  $\times 5$ ; E. UNEF14689; natural size; F. UNEF14685,  $\times 5$ ; G. UNEF14686,  $\times 5$ . A–C and E–G from UNEL1564; D from UNEL1561. Silhouettes natural size.

Genus *PILOPHOROSPERMA* Thomas 1933*Pilophorosperma* sp. cf. *P. costulatum* Thomas 1933

Figs 8E-8G

*Description.* Three specimens in part and counterpart were collected from UNEL1564. UNEF14684/5 (Fig. 8F) shows a group of cupules around a short section of rachis. Two show a single, ribbed seed with a bifid micropyle protruding some distance from the more or less even lower margin of the fleshy verrucose cupule. UNEF14686/7 (Fig. 8G) is similar, showing also "bracts" on the rachis and more distinctly ribbed seeds. UNEF14688/9 (Fig. 8E) is a very poorly preserved, pinnately arranged group of cupules on a muddy solution plane of the rock.

*Comparison.* In addition to microscopic characters (Thomas, 1933), *Umkomasia* differs from *Pilophorosperma* in its larger size and deeply cleft cupule. Within *Pilophorosperma* the variable presence, size, prominence and ornament of the seed is probably dependent on its growth stage. The fleshy, verrucose, smooth-margined cupules and ribbed prominent seeds in the Cloughers Creek material are most like *Pilophorosperma costulatum* Thomas 1933 (fig. 22). However there seem to be few megascopic reasons for separating this species from *Pilophorosperma granulatum*, *P. gracile*, *P. geminatum*, *P. paucipartitum*, *P. burnense*, *P. natalense*, *P. sp. type A*, *P. sp. type B* and *P. sp. type C*. The distinctly lobed cupular margins of *P. crassum* and *Spermatocodon seawardii* distinguish them from this group of forms and this material.

*Remarks.* It appears that Thomas (1933) has created an unnecessary number of *Pilophorosperma* species, as Townrow (1961) has shown for the equivalent microsporophylls. *Pilophorosperma* spp. are the most abundant corystosperm megasporophylls at the "Waterfall" locality of the Molteno Beds in South Africa. Following Townrow's (1961) arguments for the microsporophylls, *Pilophorosperma* spp. are probably the megasporophylls of *Dicroidium odontopteroides* and *D. lancifolium* (both *sensu* Anderson and Anderson, 1970).

*Occurrence.* *Pilophorosperma* is best known from the middle Molteno Beds (Stage D of Du Toit, 1927, and cycle 2 of Anderson, 1974) of South Africa (Thomas, 1933).

*Comparable Basin Creek Formation material.* Two very similar specimens (UNEF14711, UNEF14715) from UNEL1489.

## Family PELTASPERMACEAE

Genus *LEPIDOPTERIS* Schimper emend. Townrow 1956 ; 4*Lepidopteris madagascariensis* Carpentier 1935

Fig. 9

*Description.* A range of specimens (UNEF14671-3, UNEF14677-9) was collected at UNEL1564 and one (UNEF14697) at UNEL1561. The material from UNEL1564 varies (Fig. 9) from small unipinnate fronds (Fig. 9C) to bipinnatifid (Fig. 9C) and bipinnate (Figs 9A, 9B) fronds. All have rachis pinnules (*Zwischerfiedern*) and rounded pinnule apices. The rachis generally shows sparsely distributed blisters and a finer punctation, and often an indistinct midrib (Fig. 9D).

*Comparison.* *Lepidopteris madagascariensis* is very difficult to distinguish from *L. stormbergensis*. Townrow (1966b) found a whole range of intergrading forms in the Brookvale shale lens of the Hawkesbury Sandstone, New South Wales. The variation in the Cloughers Creek Formation material (Fig. 9) is very similar to that of *L. stormbergensis* (Townrow, 1960, fig. 5). The unipinnate form (Fig. 9C) from the Cloughers Creek Formation is very similar to specimens of *L. stormbergensis* figured by Townrow (1960, figs 5B, 5E) and Du Toit (1927, pl. 22, fig. 1). However I follow Townrow (1966b, p. 210) in placing the Cloughers



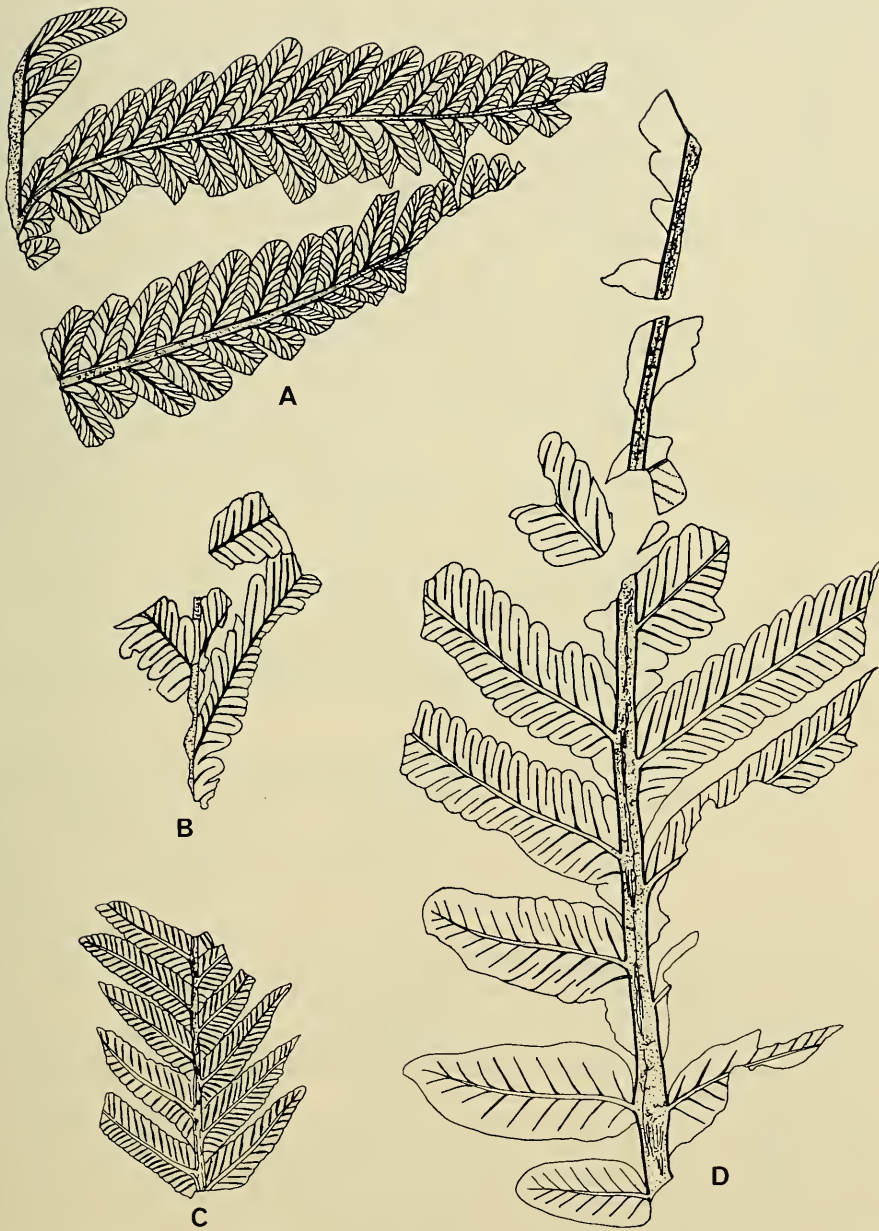

Fig. 9. A–D. *Lepidopteris madagascariensis*, showing intraspecific variation. A. bipinnate UNEF14678; B. bipinnate UNEF14672; C. pinnatifid UNEF14671; D. bipinnatifid UNEF14677. All from UNEL1564. All natural size.

Creek material in *L. madagascariensis* because of its thick leaf substance and mostly obtuse pinnules. *Lepidopteris indica* (Srivastava, 1974) is larger, with broader rounded pinnules and a more distinctly grooved rachis than both *L. madagascariensis* and *L. stormbergensis*.

*Occurrence.* According to Townrow (1966b) *L. madagascariensis* occurs in the upper Beaufort Beds (Stage B of Du Toit, 1927) in South Africa, bed 3 of the Sakamena Group in Madagascar, throughout the Narrabeen Group of the Sydney Basin in New South Wales and in the Esk Trough in Queensland. Flint and Gould (1975) also record it from the Nymboida Coal Measures in New South Wales. Townrow (1960, 1966b) had difficulty identifying specimens from the Brookvale shale lens of the Hawkesbury Sandstone in the Sydney Basin, New South Wales, and in the Esk Trough of Queensland. At Brookvale he decided that both *L. madagascariensis* and *L. stormbergensis* were present with intergrading forms. Townrow (1966b) finally identified the Esk specimens as *L. madagascariensis* (figured by Hill *et al.*, 1965, pl. T6, figs. 1, 2). *Lepidopteris stormbergensis* is best known from the lower and middle Molteno Beds (Stages C and D) in South Africa (Du Toit, 1927; Townrow, 1960).

Baldoni (1972) identified *L. stormbergensis* from the Cacheuta and Potrerillos Formations of the Cacheuta Basin in Argentina, apparently unaware of the work of Townrow (1966b). All the megascopic and cuticular features of these specimens, excepting the elongated cells at the margin, agree with *L. madagascariensis* rather than *L. stormbergensis*. Furthermore, these leaves are associated with peltasperm fructifications unlike those known for *L. stormbergensis* (Townrow 1960). These are the microsporophylls *Fanerotheca dichotoma* Frenguelli 1944c and *F. exstans* Frenguelli 1944c *pro parte* (those specimens not included in *Antevsia exstans* by Townrow, 1960, p. 350). The megasporophyll "*Umkomasia*" *cacheutensis* Frenguelli 1942c is more likely a *Peltaspermum* with laterally attached heads bearing six seeds and with no marginal lobes.

*Comparable Basin Creek Formation material.* Flint and Gould (1975, pl. 2, figs 1, 2) figure similar bipinnate specimens, and UNEF14616 is a similar unipinnate specimen, all from UNEL1489.

## DIVISION CYCADOPHYTA

### FORM GENERA OF UNCERTAIN POSITION

Genus TAENIOPTERIS Brongniart emend. Harris 1932; 33

*Taeniopteris carruthersii* Tenison Woods 1883

Fig. 10G

- 1872 *Taeniopteris Daintreei*; Carruthers, p. 355, pl. 27, fig. 6.
- 1878 *Taeniopteris Daintreei*; Feistmantel, pl. 14, fig. 4.
- \*1883 *Taeniopteris Carruthersi*; Tenison Woods, p. 117.
- 1886 *Taeniopteris Carruthersi*; Johnston, p. 375.
- 1890 *Taeniopteris Carruthersi*; Feistmantel, p. 115, pl. 28, fig. 7.
- 1892 *Taeniopteris Carruthersi*; Etheridge, in Jack and Etheridge, p. 374.
- 1898 *Taeniopteris Carruthersi*; Dun, p. 393.
- p1903 *Taeniopteris carruthersi*; Seward, p. 59, pl. 8, fig. 6 only.
- 1908 *Taeniopteris Carruthersi*; Seward, p. 99, fig. 6.
- 1917a *Taeniopteris Carruthersi*; Walkom, p. 37, fig. 10.
- 1924 *Taeniopteris Carruthersi*; Walkom, p. 85, fig. 3.
- 1925b *Taeniopteris Carruthersi*; Walkom, p. 64.
- p1927 *Taeniopteris carruthersi*; Du Toit, p. 347, fig. 9. (excluding narrow leaves).
- 1947 *Taeniopteris Carruthersi*; Jones and De Jersey, p. 46.
- 1958 *Taeniopteris carruthersi*; De Jersey, p. 85.
- 1965 *Taeniopteris* aff. *lenticuliforme*; Hill, Playford and Woods, pl. T8, fig. 4.
- p1975 *Taeniopteris lenticuliforme*; Flint and Gould, pl. 3, fig. 8 only.

*Description.* Several leaves were found on one rock fragment (Fig. 10G) from UNEL1564. These are elongate lanceolate and have a rounded apex. The secondary veins arise steeply from a robust deeply striated midrib and turn sharply to run perpendicular to the margin for most of their course. They dichotomise once or twice at varying distances from the midrib. The half width of the lower apical fragment (Fig. 10G) is 12.6 mm.

*Comparison.* I regard narrower leaves of this type (about 1 cm wide; Seward, 1903, pl. 8, fig. 5; Du Toit, 1927, fig. 9; Flint and Gould, 1975, pl. 3, fig. 9) as *Taeniopteris daintreei* (*sensu* Frenguelli, 1944b, pp. 387–388). *Taeniopteris lenticuliforme* (Walkom, 1917a) is a relatively shorter, more lanceolate leaf, with a more abruptly tapering biconcave lower margin. Its lateral veins are rarely forked and then only close to the midrib. *Taeniopteris fluctuans* (Etheridge, 1895, p. 139, pl. 5, figs 1–3) is very similar to *T. carruthersii* but for its strong transverse wrinkling.

*Occurrence.* This species has been reliably recorded from the Cortaderita Formation of the Barreal-Hilario Basin in Argentina (Stipanovic and Bonetti, 1969), the Esk Trough (Walkom, 1924) and Ipswich Coal Measures (Jones and De Jersey, 1947) in Queensland, the Feldspathic Sandstone Series in Tasmania (Walkom, 1925b), the Nymboida Coal Measures in New South Wales (Flint and Gould, 1975) and the lower and middle Molteno Beds (Stages C and D) in South Africa (Du Toit, 1927).

*Comparable Basin Creek Formation material.* UNEF13454 (Flint and Gould, 1975, pl. 3, fig. 8) from UNEL1495, and UNEF13440 and UNEF14614 from UNEL1489.

## DIVISION GINKGOPHYTA

### ORDER GINKGOALES

Genus PHOENICOPSIS Heer emend. Florin, 1936; 45

*Phoenicopsis elongatus* (Morris) Seward 1919

Fig. 10A

*Description.* This species is well represented at UNEL1564 (UNEF14649–52). These are narrow lanceolate leaves with a rounded apex and a broad abscission scar rather than a well-formed petiole. The veins are well-spaced, parallel and unforked except at the base of the leaf. The leaves are mostly about 15 mm wide. An exceptionally long narrow leaf (Fig. 10A) is 9.8 mm wide and more than 110.4 mm long.

*Comparison.* *Phoenicopsis elongatus* is distinctly lanceolate unlike other species of the genus (Seward, 1919).

*Remarks.* In both the Cloughers Creek and Basin Creek Formations *P. elongatus* lacks a well-defined petiole and appears to grade into *Sphenobaiera argentinae* (Kurtz) Frenguelli 1946. This suggests ginkgoalean rather than cycadophyte or podocarp affinities. Frenguelli (1937) placed *Phoenicopsis elongatus* within the genus *Podozamites*. However his specimen of a leaf group shows no clear evidence of a central axis.

*Occurrence.* This species is locally abundant in Middle and Late Triassic rocks of Gondwanaland. In Australia it is common in the Esk Trough (Walkom, 1924; Hill *et al.*, 1965) and Ipswich Coal Measures (Walkom, 1917b; Jones and De Jersey, 1947) in Queensland, the Nymboida Coal Measures in New South Wales (Flint and Gould, 1975) and the Feldspathic Sandstone Series (Walkom, 1925b) and/or uppermost megafossil flora in Tasmania (Banks and Clarke, 1973). It also occurs in the Molteno Beds (Stages C and D of Du Toit, 1927, and cycles 2 to  $\pm 5$  of Anderson, 1974) in South Africa. In Argentina it occurs at Paso Flores (Frenguelli, 1937), in the El Tranquilo Basin (Stipanovic and Bonetti, 1969), the Tronquimalal Formation in the Chihuii-Tronquimalal Basin (Menendez, 1951), the Potrerillos and Cacheuta Formations in the Cacheuta



Fig. 10. A. *Phoenicopsis elongatus*. B-D. *Sphenobaiera argentinae*. E. *S. stormbergensis*. F. *Rissikia media*. G. *Taeniopteris carruthersii*. A. Complete unusually long leaf and normal width leaf UNEF14650; B. UNEF14642; C. UNEF14644; D. UNEF14646; E. Showing strongly developed woody interveinal striae UNEF14648; F. Foliar spur UNEF14683; G. Natural group UNEF14670. All from UNEL1564. All natural size.

Basin (Frenguelli, 1948), the Cortaderita Formation of the Barreal-Hilario Basin (Frenguelli, 1948), the Los Rastros Formation in the Ischigualasto-Villa Union Basin (Stipanice and Bonetti, 1969) and the Challao-San Isidro Basin (Frenguelli, 1948). Douglas (1969) believes that supposed remains of *P. elongatus* from the Early Cretaceous of Victoria (Medwell, 1954, pl. 3, figs 9, 10) are equisetalean fragments.

*Comparable Basin Creek Formation material.* UNEF13465 (Flint and Gould, 1975, pl. 2, fig. 6) from UNEL1495 and UNEF13326 from UNEL1489.

Genus SPHENOBAIERA Florin 1936

*Sphenobaiera argentiniae* (Kurtz) Frenguelli 1946

Figs 10B–10D

*Description.* Several specimens from UNEL1564 vary from narrow scarcely-divided leaves (Fig. 10B) to more widely divided (Fig. 10C) and broader fan-shaped leaves (Fig. 10D). They have a narrow almost petiolate leaf base. The veins dichotomise at various levels. Commonly there are clear interveinal woody striae.

*Comparison.* These leaves differ from *Phoenicopsis elongatus* in their divided apex and veins dichotomising at various levels in the leaf. *Sphenobaiera argentiniae* is larger and more deeply divided than is usual for *Ginkgoidium* (Seward, 1919; Frenguelli, 1946). The variation in shape (Figs 10B, 10C, 10D), the interveinal striae and close relationship with associated *Phoenicopsis elongatus* are most similar to the South American material (Frenguelli, 1946).

*Occurrence.* This species is best known from the Potrerillos and Cacheuta Formations of the Cachenta Basin in Argentina (Frenguelli, 1946; Jain and Delevoryas, 1967). Archangelsky (1968a) and Anderson and Anderson (1970) also record it from Paso Flores, the Cortaderita Formation in the Barreal-Hilario Basin and in the Chihuiu-Tronquimalal Basin in Argentina. It may also occur in the Feldspathic Sandstone Series at Lords Hill, Hobart, Tasmania (as *Salisburia hobartensis* in Johnston, 1887, 1888).

*Comparable Basin Creek Formation material.* UNEF14610, UNEF14611 and Australian Museum specimen number AMF48873 all from UNEL1489.

*Sphenobaiera stormbergensis* (Seward) Frenguelli 1948

Fig. 10E

- \*1903 *Baiera stormbergensis*; Seward, p. 64, pl. 8, fig. 3.
- p1917b *Ginkgo magnifolia*; Walkom, p. 9, pl. 4, figs 3, 4.
- p1927 *Ginkgoites magnifolius*; Du Toit, p. 25, fig. 17, pls 10, 11, fig. 1.
- 1928 *Ginkgoites* cf. *magnifolius*; Walkom, p. 466, pl. 27, fig. 3.
- 1936 *Ginkgoites magnifolius*; Florin, p. 44.
- 1947 *Ginkgoites magnifolius*; Jones and De Jersey, p. 59, pl. 10, figs 2, 3.
- 1948 *Sphenobaiera, Stormbergensis*; Frenguelli, p. 247.
- 1968a *Sphenobaiera stormbergensis*; Archangelsky, p. 82.
- 1969 *Sphenobaiera stormbergensis*; Stipanice and Bonetti, pp. 1095, 1099.
- 1975 *Ginkgoites* cf. *magnifolius*; Flint and Gould, p. 71.

*Holotype.* The specimen figured by Seward (1903, pl. 8, fig. 3) from the middle Molteno Beds (Stage D) of Konings Kroon, Elliot, South Africa (Du Toit, 1927, p. 371).

*Description.* Only one specimen (Fig. 10E) was found at UNEL1564. This is a broad leaf in which the venation is obscured by woody striae giving the leaf a pleated appearance.

*Comparison.* The strong pleating of the leaf is most similar to the specimen figured by Du Toit (1927, pl. 30). *Sphenobaiera argentiniae* is smaller, narrower, only once divided and never shows a comparable development of woody interveinal striae. *Sphenobaiera stormbergensis* has been synonymised with "*Ginkgo*

*Huttoni magnifolia*” of Ward (1905) from the Jurassic of Oregon and Alaska. The American Jurassic species is distinctly smaller, usually only divided into four segments and the lowest segments form a right angle to a long well-differentiated petiole (Ward, 1905, pl. 32, fig. 2).

*Remarks.* The three species *Phoenicopsis elongatus*, *Sphenobaiera argentina* and *S. stormbergensis* form an intergrading series of increasing size, dissection and development of woody interveinal striae. They may have been one species in life.

*Occurrence.* This species is known from the upper Beaufort Beds (Stage B) and the middle Molteno Beds (Stage D of Du Toit, 1927, and cycle 2 of Anderson, 1974) in South Africa, the Esk Trough and Ipswich Coal Measures in Queensland (Walkom, 1917*b*, 1928; Jones and De Jersey, 1947), the Red Cliff Coal Measures in New South Wales (Flint and Gould, 1975) and the Cortaderita Formation of the Barreal-Hilario Basin in Argentina (Stipanovic and Bonetti, 1969; Archangelsky, 1968*a*).

*Comparable Basin Creek Formation material.* Robust pleated leaves UNEF13333 from UNEL1489 and UNEF13471 from UNEL1495.

## DIVISION CONIFEROPHYTA

### ORDER CONIFERALES

#### Family PODOCARPACEAE

#### Genus RISSIKIA Townrow 1967*b*

#### *Rissikia media* (Tenison Woods) Townrow 1967*b*

#### Figs 10F; 11A

*Description.* A foliar spur (Fig. 10F) from UNEL1564 shows spirally arranged, narrow, elongate lanceolate leaves with strong midribs. The leaves are up to 9.6 mm long, 1.6 mm wide and about 3 mm apart. They are contracted at the base and arranged at a relatively open angle to the axis.

A seed cone (Fig. 11A) from UNEL1563 was collected in part and counterpart (UNEF14707/8). The three obtusely pointed lobes of the cone scale at the top of the specimen each bear two ovules. A trifold bract scale may be seen immediately left of the X5 indication on Fig. 11A. The ovules are not all exactly the same size (Townrow, 1967*b*, p. 111). To the lower left of the cone is a fragment of a foliage leaf.

*Comparison.* The specimens are identical to those of Townrow (1967*b*, 1969). Similar Gondwanaland conifer remains are compared in detail by Townrow (1967*b*, p. 123).

*Occurrence.* This species is best known from the middle Molteno Beds (Stage D of Du Toit, 1927, and cycle 2 of Anderson, 1974) in South Africa. The type specimen of Tenison Woods (1883) is localised as “Ipswich” and has a specimen of *Dicroidium odontopteroides* on the same slab. However nothing like it was found in the Ipswich Coal Measures by Jones and De Jersey (1947). *Rissikia media* has been found in the neighbouring Esk Trough in Queensland (as *Elatocladus* sp. in Hill *et al.*, 1965, pl. T8, fig. 7) and rocks of the same age in New South Wales; the Nymboida Coal Measures (Flint and Gould, 1975) and the Gunnee Beds near Delungra (Gould and Retallack in Bourke *et al.*, in press). Townrow (1967*a*) also records it from Antarctica. I am reluctant to accept that the foliar spurs from bed 3 of the Sakamena Group in Madagascar, synonymised by Townrow (1967*b*) are valid records of *R. media*. These have thicker axes than *R. media* and crowded flexuous leaves curving sharply into the axis. *Voltziopsis* fructifications are associated with the Madagascar leaves, but no *Rissikia* cones have been found.

*Comparable Basin Creek Formation material.* Foliar spurs figured by Flint and Gould (1975, pl. 2, fig. 6a) from UNEL1495 and UNEF13334 from UNEL1489.

#### UNCLASSIFIED PLANT REMAINS

##### Fructification type A

##### Fig. 11C

*Description.* This is a lax cone with stalked seed-like organs borne on thick woody cone scales. The best specimen (Fig. 11C, part and counterpart UNEF-14690/1) from UNEL1564 shows three apparently-inverted sets of possibly paired ovules on a slender branched stalk which rises almost perpendicularly from the cone scale. The cone scale is very thick and heavily carbonised. It arises almost perpendicularly to the axis and then curves sharply upwards. UNEF14692/3 is a very poorly preserved leached fragment in a coarser matrix from UNEL1564. UNEF14606 from UNEL1563 is a group of three stalked seedlike bodies overlying a flat portion of cone scale.

*Comparison.* This cone has some features of the Voltziaceae, but does not agree with any known genus of that family (Archangelsky, 1968b). *Strobilites lacus* Seward 1908 is larger and lacks seeds, although it has similar curved thick cone scales. *Beaniopsis* is also superficially similar but has only two distinctly angled seeds per scale which are back to back and directed in opposite directions (Ganju, 1947). In *Stachyotaxus* the seeds are fused with the cone scale (Seward, 1919). A specimen of "seeds of possible Ginkgoalean affinity" (Jones and De Jersey, 1947, p. 63) is somewhat similar but the associated sterile bracts are linear.

*Remarks.* The coalification of the remains in a coarse matrix and leaching of the rock do not allow a closer analysis.

##### Fructification type B

##### Fig. 11B

*Description.* This is a natural oblique section through a cone found as part and counterpart (Fig. 11B, UNEF14703/4) at UNEL1564. The bract scales are elongate triangular with a sagittate, almost sheathing base. The bract substance is very thick and coriaceous. The midrib is prominently rounded but the probably once-forking lateral veins are very difficult to trace. Below and to the left of the most obvious bract scale is a natural longitudinal section of the thick woody cone scale, bearing several seeds on its adaxial surface, and of the underlying thinner bract scale. The seeds are small, tear-shaped and strongly convex with micropyles directed upwards. They appear to have a fleshy sarcotesta elongated above the micropyle. The woody sclerotesta shows up as three rounded lobes separated by narrow furrows on one flattened side. The cone was relatively lax after fall as it has picked up extraneous plant fibres in transport. A further specimen of the leaf-like bract scale (UNEF14705 from UNEL1563) shows its acute apex.

*Comparison.* The venation of the bract scale suggests a relation with *Blechnoxylon* (Etheridge, 1899) or *Glossopteris* of the type attached to a thick caudex (Etheridge, 1894) rather than slender axes (Pant and Singh, 1974). This cone scale is superficially similar to *Dictyopteridium*, *Scutum* (Surange and Chandra, 1975) and *Austroglossa* (Holmes, 1974), but in these the bract scale covers a complete strobilus adnate to a foliage leaf. The ribbed seeds are superficially similar to some pteridosperm seeds (Taylor, 1966). The structure is similar to *Palissya* (Frenguelli, 1949). However in the Cloughers Creek cone the bract scale is not fused to the cone scale and the arrangement of the seeds cannot be exactly determined.

*Remarks.* This fructification is probably a new type of gymnosperm possibly related to the Glossopteridae or primitive conifers.

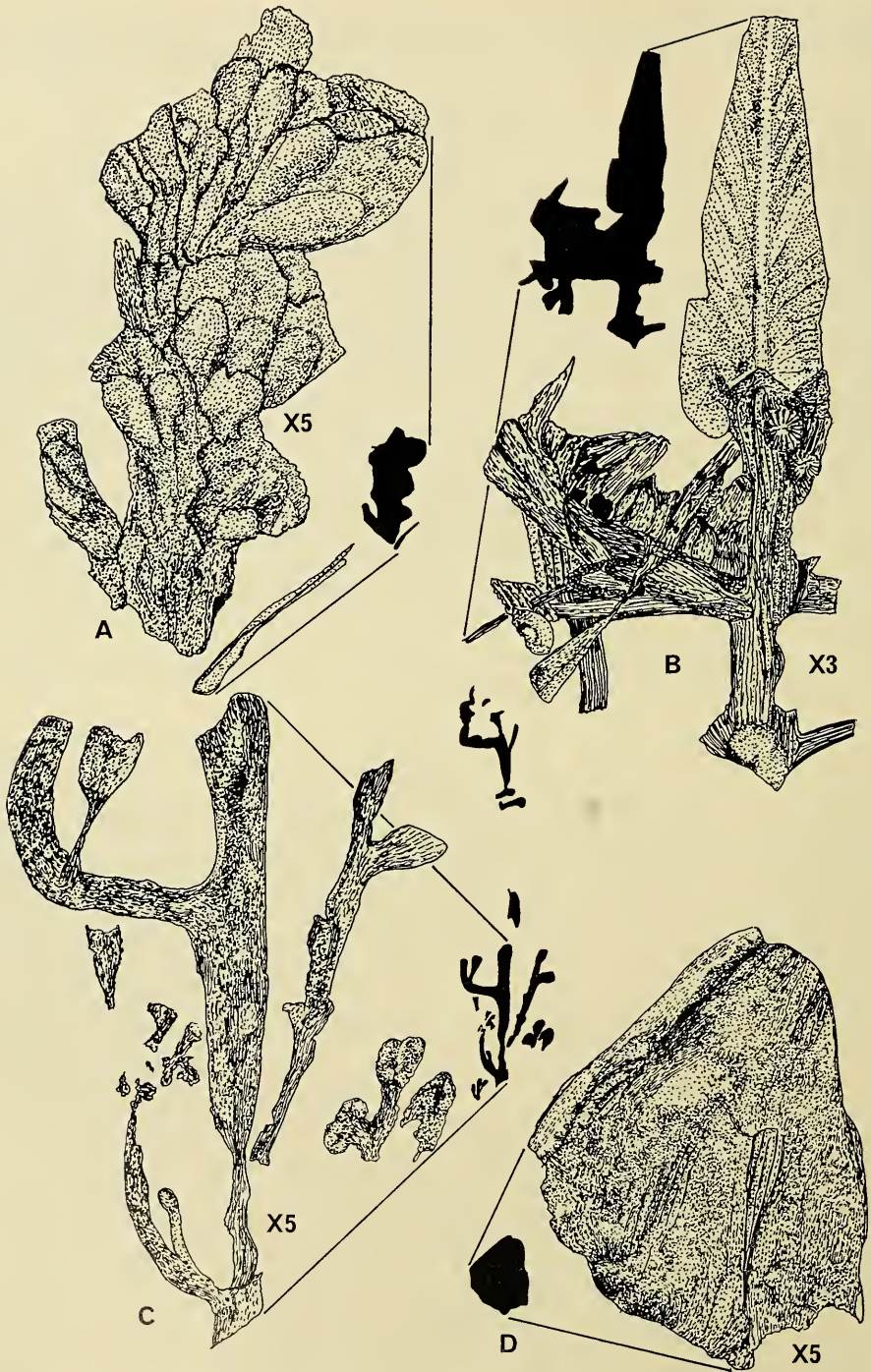

Fig. 11. A. *Rissikia media*. B. Fructification type B. C. Fructification type B. C. Fructification type A. D. Fructification type C. A. Seed cone UNEF14707,  $\times 5$ ; B. (?) seed cone UNEF14704,  $\times 3$ ; D. (?) seed cone UNEF14690,  $\times 5$ ; D. Large seed UNEF14696,  $\times 5$ . A, B and D from UNEL1563; C from UNEL1564. Silhouettes natural size.



## Fructification type C

## Fig. 11D

*Description.* Fig. 11D depicts a large seed from UNEL1563.

*Comparison.* The size, shape and longitudinal rib of this seed are similar to seeds commonly associated with *Dicroidium zuberi* (Szajnocha) Archangelsky 1968c (Frenguelli, 1944a, pl. 12, figs 1, 2).

*Occurrence.* Frenguelli's (1944a) specimen was collected from the Cortaderita Formation of the Barreal-Hilario Basin in Argentina.

*Comparable Basin Creek Formation material.* UNEF14712/3 (part and counterpart) from UNEL1489.

## Woody many-branched roots.

*Description.* One specimen (UNEF14694) was collected from an underclay (UNEL1562).

*Comparison.* Roots of this type are most similar to specimens described by Frenguelli (1942a) as "*Czekanowskia*" *rigalii*.

*Occurrence.* "*Czekanowskia*" *rigalii* occurs in the Cacheuta Basin (Archangelsky, 1968a), the Challao-San Isidro Basin and the Los Rastros Formation of the Ischigualasto-Villa Union Basin (Frenguelli, 1948) in Argentina.

*Comparable Basin Creek Formation material.* UNEF14710 from UNEL1489 is identical with the Cloughers Creek Formation specimen; UNEF14717 from UNEL1489 is very similar to more typical Argentine specimens of "*Czekanowskia*" *rigalii*.

## ACKNOWLEDGEMENTS

We are especially grateful to Professor J. F. G. Wilkinson, Dr. J. D. Kleeman, Mr. H. D. Hensel and Mr. M. B. Duggan of this Department for advice and contributions in describing the Dalmally Basalt Member. G. R. wishes to thank several curators for access to fossil collections; Dr. A. Ritchie (Australian Museum, Sydney), Mr. G. Z. Foldvary (University of Sydney, Geology Department), Mr. P. J. G. Fleming (Queensland Geological Survey, Brisbane), Dr. C. A. Fleming (New Zealand Geological Survey, Lower Hutt, New Zealand) and Mrs R. Kyle (Victoria University, Wellington, New Zealand). Mr. H. R. Butler assisted in fieldwork. Mr. M. Bone drafted the map and diagrams. The botanical drawings are by G.R. Funds for the isotopic date were provided by the Australian Research Grants Committee (Grant no. E69/17168). G. R. is supported by a Commonwealth Postgraduate Award.

## References

- ANDERSON, H. M., 1974.—A brief review of the Molteno "Formation" (Triassic), South Africa. *Palaeontol. Afr.*, 17: 1-10.
- , and ANDERSON, J. M., 1970.—A preliminary review of the uppermost Permian, Triassic and lowermost Jurassic of Gondwanaland. *Palaeontol. Afr.*, 13, suppl., 22 p.
- ANTEVS, E., 1913.—Results of Dr E. Mjöberg's Swedish Scientific Expeditions to Australia 1910-1913. V. Some Mesozoic plants. *K. Sven. Vetenskapsakad. Handl.*, 52(5): 1-5.
- ARBER, E. A. N., 1901.—Notes on Royle's Types of fossil plants from India. *Geol. Mag.*, Dec.: 4, 8, 546.
- , 1905.—*Catalogue of the fossil plants of the Glossopteris flora in the Department of Geology, British Museum (Natural History)*. London: British Museum. 255p.
- , 1917.—Earlier Mesozoic floras of New Zealand. *Palaeontol. Bull. N.Z. Geol. Surv.*, 6: 1-72.
- ARCHANGELSKY, S., 1968a.—Permskie i Triasovye flory Yuznop Ameriki (Permian and Triassic floras of South America). *Akad. Nauk S.S.S.R. Geol. Inst. Tr.*, 191: 71-87.
- , 1968b.—On the genus *Tomaxiella* (Coniferae) from the lower Cretaceous of Patagonia (Argentina) and its male and female cones. *J. Linn. Soc. (Bot.)*, 61: 153-165.
- , 1968c.—Studies on Triassic fossil plants from Argentina. IV. The leaf genus *Dicroidium* and its possible relation to *Rhexoxylon* stems. *Palaeontology*, 11: 500-512.
- ARNOLD, C. A., 1947.—*An introduction to paleobotany*. New York: McGraw Hill. 433p.
- AZCÁRATE, V., and FASOLA, A., 1970.—Sobre formas nuevas para la flora triásica de Los Molles. *Bol. Mus. Nac. Hist. Nat. Chile*, 29: 249-269.

- BALDONI, A. M., 1972.—El genero *Lepidopteris* (Pteridosperma) en el Triasico de Argentina. *Ameghiniana*, 9 : 1—16.
- BALME, B. E., and HELBY, R. J., 1973.—Floral modifications at the Permian-Triassic boundary in Australia. In Logan, A., and Hills, E. V. (eds), *The Permian and Triassic Systems and their mutual boundary*. *Mem. Can. Soc. Pet. Geol.*, 2 : 433—444.
- BANKS, M. R., and CLARKE, M. J., 1973.—*Tasmania, Parmeneer Supergroup*. In Field Trip No. 1. Upper Carboniferous to Triassic rocks in south eastern Australia. 3rd Int. Gondwana Symp., Canberra, pp. 23—47.
- , COSGRIFF, J. W., and TOWNROW, J. A., 1967.—The Triassic System in Tasmania. *Abstr. 1st Int. Gondwana Symp.*, Buenos Aires, p. 19.
- BARRETT, P. J., and WEBB, P. N., 1973.—Stratigraphic sections of the Beacon supergroup (Devonian and older (?) to Jurassic) in South Victoria Land. *Pub. Geol. Dept. Vict. Univ. Wellington*, 2 : 1—165.
- BONETTI, M. I. R., 1963.—Contribucion al conocimiento de la flora fosil de Barreal, Dept. Calingasta (Prov. San Juan). Unpub. thesis, Fac. Cienc. Exact. y Nat., Univ. Buenos Aires.
- , 1966.—Consideracions sobre algunos representantes de la familia *Corystospermeaceae*. *Ameghiniana*, 4 : 389—395.
- , and HERBST, R., 1964.—Dos especies de *Dictyophyllum* del Triasico de Paso Flores de Neuquén, Argentina. *Ameghiniana*, 3 : 273—278.
- BOUREAU, E., and DOUBINGER, J., 1975.—*Traité de Paléobotanique*. Tome IV. Fasc. 2. *Pteridophylla (prem. part.)*. Paris : Masson et Cie. 772 p.
- BOURKE, D. J., GOULD, R. E., HELBY, R., MORGAN, R., and RETALLACK, G. J., in press.—A note on a Middle Triassic flora from the Gunnee Beds, near Delungra, N.S.W.
- CARPENTIER, A., 1935.—Etudes paléobotaniques sur le groupe de la Sakoa et de la Sakamena (Madagascar). *Ann. Geol. Serv. Mines Madagascar*, 5 : 7—32.
- CARRUTHERS, W., 1872.—Notes on fossil plants from Queensland, Australia. *Q. J. Geol. Soc. Lond.*, 28 : 350—359.
- CHAPMAN, F., and COOKSON, I. C., 1926.—A revision of the Sweet Collection of Triassic plant remains from Leigh Creek, South Australia. *Trans. Proc. R. Soc. S. Aust.*, 50 : 163—178.
- DAY, R. W., CRANFIELD, L. C., and SCHWARZBOCK, H., 1974.—Stratigraphy and structural setting of Mesozoic Basins in south-eastern Queensland and northeastern New South Wales. In Denmead, A. K., Tweedale, G. W. and Wilson, A. F. (eds), *The Tasman Geosyncline*. Brisbane : Geological Society of Australia, Queensland Division : 320—363.
- DE JERSEY, N. J., 1958.—Macro- and micro-floras of north-eastern New South Wales. *J. Proc. R. Soc. N.S.W.*, 92 : 83—89.
- , 1972.—Triassic miospores from the Esk Beds. *Pub. Geol. Surv. Queensl.*, 357 (Paleontol. Pap., 32) : 1—40.
- DOUGLAS, J. G., 1969.—The Mesozoic flora of Victoria. I and II. *Mem. geol. Surv. Vict.*, 28 : 9—310.
- DUN, W. S., 1898.—Notes on the Australian Taeniopteridae. *Rep. 7th Meet. Aust. Assoc. Adv. Sci.*, Sydney, pp. 384—400.
- DU TOIT, A. L., 1927.—The fossil flora of the Upper Karroo Beds. *Ann. S. Afr. Mus.*, 22 : 289—420.
- ETHERIDGE, R., 1891.—Description of some Silurian and Mesozoic fossils in South Australia. *S. Aust. Parl. Pap.*, 158 : 10—11.
- , 1894.—On the mode of attachment of the leaves or fronds to the caudex in *Glossopteris* with remarks on the relation of the genus to its allies. *Proc. Linn. Soc. N.S.W.*, 2 : 228—258.
- , 1895.—Additional remains from the Leigh Creek Coal Field, Central Australia. *Trans. Proc. R. Soc. S. Aust.*, 19 : 138—146.
- , 1899.—On a fern (*Blechnoxylon talbragarensis*), with secondary wood, forming a new genus from the Coal Measures of the Talbragar district. *Rec. Aust. Mus.*, 3 : 125—147.
- , 1902.—Contributions to the palaeontology of South Australia. No. 12. More complete evidence of *Thinnfeldia odontopteroides* Morris in the Leigh Creek Coal Measures. *S. Aust. Parl. Pap.*, for 1902 : 1—4.
- FABRE, J., and GREBER, C., 1960.—Presence d'un *Dictyophyllum* dans le flore Molteno du Basuto-land (Afrique australe). *Bull. Soc. Geol. Fr.*, 7 : 178—182.
- FEISTMANTHEL, O., 1878.—Palaeontologische Beitrage (part) 3. Palaeozoische und Mesozoische Flora des ostlichen Australiens. *Palaeontographica*, 3 : 55—84.
- , 1881.—The fossil flora of the Gondwana System. 2. The flora of the Damuda and Panchet Divisions. *Palaeontol. Indica*, 12th ser., 3 : 78—149.
- , 1889.—Die Karroo-formation und die dieselbe unterlagernden Schichten. *Abh. K. Bohm. Ges. Wiss. Prague*, 7 : 1—89.
- , 1890.—Geological and palaeontological relations of the coal and plant bearing beds of Palaeozoic and Mesozoic age in Eastern Australia and Tasmania. *Mem. Geol. Surv. N.S.W. Palaeontol.*, 3 : 1—85.
- FLINT, J. C. E., and GOULD, R. E., 1975.—A note on the fossil megaflores of the Nymboida and Red Cliff Coal Measures, southern Clarence-Moreton Basin, N.S.W. *J. Proc. R. Soc. N.S.W.*, 108 : 70—74.
- FLORIN, R., 1936.—Die fossilen Ginkgophyten von Franz Joseph land nebst Erosterungen über vermeintlichen Cordaitales mesozoischen Alters. 2. Allgemeiner Teil. *Palaeontographica*, 82B : 1—72.

- FRENGUELLI, J., 1937.—La florula jurásica de Paso Flores en el Neuquén. *Rev. Mus. La Plata Paleontol.*, 1 : 67–108.
- , 1942a.—Contribuciones al conocimiento de la flora del Gondwana superior en la Argentina. III. *Czekanowskia rigali* n. sp. *Notas Mus. La Plata Paleontol.*, 7 : 287–291.
- , 1942b.—Contribuciones al conocimiento de la flora del Gondwana superior en la Argentina. VI. *Pterorrachis* n. gen. *Notas Mus. La Plata Paleontol.*, 7 : 303–313.
- , 1942c.—Contribuciones al conocimiento de la flora del Gondwana superior en la Argentina. VII. *Umkomasia cacheutensis* n. sp. *Notas Mus. La Plata Paleontol.*, 7 : 315–321.
- , 1942d.—Contribuciones al conocimiento de la flora del Gondwana superior en la Argentina. IX. *Kurtziana cacheutensis* Kurtz sp. n. gen. et n. comb. *Notas Mus. La Plata Paleontol.*, 7 : 332–339.
- , 1942e.—Contribuciones al conocimiento de la flora del Gondwana superior en la Argentina. X. *Chiropteris barrealensis*. *Notas Mus. La Plata Paleontol.*, 7 : 341–353.
- , 1943.—Reseña crítica de los géneros atribuidos a la “Serie de Thinnfeldia”. *Rev. Mus. La Plata Paleontol.*, 2 : 225–336.
- , 1944a.—Las especies del genero “Zuberia” en la Argentina. *Ann. Mus. La Plata Paleontol.*, B, Paleobot., 2 : 1–30.
- , 1944b.—Contribuciones al conocimiento de la flora del Gondwana superior en la Argentina. XV. La florula de la base de la “Serie de Cacheuta” en el Cerro de los Baños, Mendoza. *Notas Mus. La Plata Paleontol.*, 9 : 271–310.
- , 1944c.—Contribuciones al conocimiento de la flora del Gondwana superior en la Argentina. XVIII. *Fanerotheca exstans* n. gen. n. sp. *Notas Mus. La Plata Paleontol.*, 9 : 393–402.
- , 1944d.—Contribuciones al conocimiento de la flora del Gondwana superior en la Argentina. XXVI. *Dicroidiopsis dubia* Feist. sp. *Notas Mus. La Plata Paleontol.*, 9 : 521–530.
- , 1944e.—Contribuciones al conocimiento de la flora del Gondwana superior en la Argentina. XXX. *Dicroidium remotum* Szajn. sp. *Notas Mus. La Plata Paleontol.*, 9 : 549–553.
- , 1946.—Contribuciones al conocimiento de la flora del Gondwana superior en la Argentina. XXXIII. “Ginkgoales” de los Estratos de Potrerillos en la precordillera de Mendoza. *Notas Mus. La Plata Paleontol.*, 11 : 100–127.
- , 1947.—El genero *Cladophlebis* y sus representantes en la Argentina. *Ann. Mus. La Plata Paleontol.*, B, Paleobot., 2 : 1–74.
- , 1948.—Estratigrafía y edad del llamado Retico en la Argentina. *Gaea, B. Aires*, 8 : 159–309.
- , 1949.—Addendo a la flora del Gondwana superior en la Argentina. I. “*Palissya conferta*” Feistm. y “*Palissya jabalpurensis*” Feistm. en el Jurásico superior del Chubut, Patagonia. *Physis*, 20 : 139–146.
- GANJU, P. N., 1947.—On *Beaniopsis rajmahalensis* gen. et sp. nov., a new type of gymnosperm female fructification from the Jurassic of Bihar. *Proc. Indian Acad. Sci.*, B25, 95–104.
- GORDON, M., and BROWN, R. W., 1952.—Plantas triásicas do sul do Brasil. *Notas Prelim. Estud. Div. Geol. Mineral. Bras.*, 54 : 1–6.
- GOTHAN, W., 1912.—Über die Gattung *Thinnfeldia* Etingshausen. *Abh. Naturhist. Ges. Nürnberg*, 29 : 67–80.
- GREEN, D. C., and WEBB, A. W., 1974.—Geochronology of the northern part of the Tasman Geosyncline. In Denmead, A. K., Tweedale, G. W. and Wilson, A. F. (eds), *The Tasman Geosyncline*. Brisbane : Geological Society of Australia, Queensland Division : 275–294.
- GREEN, J., and SHORT, N. M., 1971.—*Volcanic landforms and surface features*. Berlin : Springer Verlag. 519p.
- HALLE, T. G., 1908.—Zur kenntnis der Mesozoischen Equisetales Schwedens. *K. Sven. Vetenskapsakad. Handl.*, 43 : 1–56.
- HARRIS, T. M., 1932.—The fossil flora of Scoresby Sound, East Greenland. Part 2. Description of seed plants *incertae sedis* together with a discussion of certain cycadophyte cuticles. *Medd. Grönland*, 85(3) : 1–112.
- , 1961.—The Yorkshire Jurassic flora. I. *Thallophyta-Pteridophyta*. London : British Museum (Nat. Hist.) 212 p.
- HELBY, R. J., 1969.—The age of the Narrabeen Group as implied by the microfloras. In Packham, G. H. (ed.), *Geology of New South Wales*. *J. Geol. Soc. Aust.*, 16 : 404–405.
- HERBST, R., 1971.—Revision de las especies argentinas del genero *Cladophlebis*. *Ameghiniana*, 7 : 265–281.
- HILL, D., PLAYFORD, G., and WOODS, J. T., 1965.—*Triassic fossils of Queensland*. Brisbane : Queensland Palaeontographical Society. 32p.
- HOLMES, W. B. K., 1974.—On some fructifications of the Glossopteridales from the upper Permian of N.S.W. *Proc. Linn. Soc. N.S.W.*, 98 : 131–141.
- HOUSTON, B. R., 1965.—Triassic volcanics from the base of the Ipswich Coal Measures, south-eastern Queensland. *Pub. Geol. Surv. Queensl.*, 327 : 1–18.
- JACOB, K., and JACOB, C., 1950.—A preliminary account of the structure of the cuticles of *Dicroidium* (*Thinnfeldia*) fronds from the Mesozoic of Australia. *Proc. Nat. Inst. Sci. India*, 16 : 101–126.

- JACK, R., and ETHERIDGE, R., 1892.—The geology and palaeontology of Queensland and New Guinea. *Pub. Geol. Surv. Queensl.*, 92 : 1-768.
- JAIN, R. K., and DELEVORYAS, T., 1967.—A middle Triassic flora from the Cacheuta Formation, Minas de Petroleo, Argentina. *Palaeontology*, 10 : 564-589.
- JOHNSTON, R. M., 1886.—General observations regarding the classification of the upper Palaeozoic and Mesozoic rocks of Tasmania together with a full description of all the known Tasmanian coal plants including a considerable number of new species. *Pap. Proc. R. Soc. Tas.*, 1885 : 343-387.
- , 1887.—Fresh contribution to our knowledge of the plants of Mesozoic age in Tasmania. *Pap. Proc. R. Soc. Tas.*, 1886 : 160-179.
- , 1888.—*The geology of Tasmania*. Hobart : Government Printer. 408p.
- , 1896.—Further contributions to the history of the fossil flora of Tasmania. *Pap. Proc. R. Soc. Tas.*, 1895 : 57-63.
- JONES, O. A., and DE JERSEY, N. J., 1947.—The flora of the Ipswich Coal Measures—morphology and floral succession. *Pap. Dep. Geol. Univ. Queensl.*, 3(3) : 1-88.
- KURTZ, F., 1921.—Atlas de plantas de la Republica Argentina. *Actas Acad. Nac. Cienc. Cordoba*, 7 : 129-153.
- LEBEDEV, Y. L., 1974.—K metodiky izucheniya skril'nykh list'yev mezozoyskikh paporotnikov (Methods for the study of sterile leaves of Mesozoic ferns). *Paleontol. Zh.*, 1974 : 130-139 (translated in *Paleontol. J.*, 8 : 237-245).
- , and RASSKAZOVA, E. S., 1968.—Novyy rod Mezozoyskikh paporotnikov-*Lobifolia* (A new genus of Mesozoic ferns-*Lobifolia*). *Akad. Nauk S.S.S.R. Geol. Inst. Tr.*, 191 : 56-69.
- LELE, K. M., 1961a.—Studies in the Indian Middle Gondwana flora. I. On *Dicroidium* from the South Rewa Gondwana Basin. *Palaeobotanist*, 10 : 48-68.
- , 1961b.—Studies in the Indian Middle Gondwana flora. II. Plant fossils from the South Rewa Gondwana Basin. *Palaeobotanist*, 10 : 69-83.
- MCCOY, F., 1875.—*Prodromus of the palaeontology of Victoria. Decade II*. Melbourne : Victorian Government Printer.
- MCELROY, C. T., 1963.—The geology of the Clarence-Morton Basin. *Mem. Geol. Surv. N.S.W., Geology*, 9 : 1-172.
- MATTHEWS, S. C., 1973.—Notes on open nomenclature and on synonymy lists. *Palaeontology*, 16 : 713-719.
- MEDWELL, L. M., 1954.—Fossil plants from Killara, near Casterton, Victoria. *Proc. R. Soc. Vict.*, 66 : 16-23.
- MENDENDEZ, C. A., 1951.—La flora mesozoica de la Formacion Llantenes (Provincia Mendoza). *Rev. Mus. Argent. Cienc. Nat. Bernardino Rivadavia*, 2 : 147-261.
- OISHI, S., 1931.—On *Fraxinopsis* Wieland and *Yabeiella* Oishi gen. nov. *Jap. J. Geol. Geogr.*, 8 : 259-267.
- PANT, D. D., and BASU, N., 1973.—*Pteruchus indicus* sp. nov. from the Triassic of Nidpur, India. *Palaeontographica*, B144 : 11-24.
- , and SINGH, R. S., 1974.—On the stem and attachment of *Glossopteris* and *Gangamopteris* leaves. Part II. Structural features. *Palaeontographica*, B147 : 42-73.
- PLAYFORD, G., and DETTMANN, M. E., 1965.—Rhaeto-Liassic plant microfossils from the Leigh Creek Coal Measures, South Australia. *Senckenberg. Leth.*, 46 : 12-17.
- PLEDGE, N. S., 1974.—*Fossils of the Flinders and Mt Lofty Ranges*. Adelaide : Government Printer. 14p.
- PRATT, G. W., and HERBERT, C., 1973.—A reappraisal of the Lorne Basin. *Rec. Geol. Surv. N.S.W.*, 15 : 205-212.
- RAO, A. R., and LELE, K. M., 1962.—On the cuticle of *Dicroidium* (*Thinnfeldia*) *sahnii* (Seward) with some observations on the genera *Thinnfeldia* and *Dicroidium*. *Palaeobotanist*, 11 : 7-12.
- SAMYLYNA, V. A., 1964.—Mezozoiskaya flora levoberezhya r. Kolymy (Zyranski uglenosnyi bassein); chast 1. Khvoshchevye, paporotniki, tsikadovye, bennettitovye. (The Mesozoic flora of the area to the west of the Kolyma River (Zyrianka coal basin) : 1. Equisetales, Filicales, Cycadales, Bennettitales.) *Tr. Inst. Bot. Komarov. Akad. Nauk S.S.S.R. Paleobot.*, 5 : 39-79.
- SCAGEL, R. F., BANDONI, R. J., ROUSE, G. E., SCHOFIELD, W. B., STEIN, J. R., and TAYLOR, T. M. C., 1968.—*An evolutionary survey of the plant kingdom*. Belmont, California : Wadsworth. 658p.
- SEWARD, A. C., 1903.—Fossil flora of Cape Colony. *Ann. S. Afr. Mus.*, 4 : 1-122.
- , 1908.—On a collection of fossil plants from South Africa. *Q. J. Geol. Soc. Lond.*, 64 : 84-108.
- , 1911.—*Fossil plants*. Vol. II. Cambridge : Cambridge University Press.
- , 1917.—*Fossil plants*. Vol. III. Cambridge : Cambridge University Press.
- , 1919.—*Fossil plants*. Vol. IV. Cambridge : Cambridge University Press.
- , 1933.—On some fossil plants from the Parsora Stage, Rewa. *Rec. Geol. Surv. India*, 66 : 235-243.
- , and HOLTUM, R. E., 1921.—On a collection of fossil plants from Southern Rhodesia. *Bull. Geol. Surv. South. Rhod.*, 8 : 29-45.
- SHIRLEY, J., 1898.—Additions to the fossil flora of Queensland. *Bull. Geol. Surv. Queensl.*, 7 : 9-25.

- SOLMS-LAUBACH, GRAF VON, 1899.—Beschreibung der Pflanzenreste von La Ternera. *Neues Jahrb. Miner. Geol. Palaeontol. Beilageband*, 12 : 593-609.
- SPEDEEN, I. G., 1958.—A note on the age of the Jurassic flora of Owaka Creek, south-east Otago, New Zealand. *N.Z. J. Geol. Geophys.*, 1 : 530-532.
- SRIVASTAVA, S. C., 1974.—Pteridospermic remains from the Triassic of Nidpur, Madhya Pradesh, India. *Geophytology*, 4 : 54-59.
- STIPANICIC, P. N., 1969.—Las sucesiones triasicas argentinas. *Proc. 1st Int. Gondwana Symp.*, Buenos Aires, pp. 1121-1149.
- , and BONETTI, N. I. R., 1969.—Consideraciones sobre la cronologia des las terrenos triasicas argentinas. *Proc. 1st Int. Gondwana Symp.*, Buenos Aires, pp. 1081-1119.
- SURABER, K. R., 1966.—Indian fossil pteridophytes. *Bot. Monogr. New Delhi*, 4 : 1-209.
- , and CHANDRA, S., 1975.—Morphology of the gymnospermous fructifications of the *Glossopteris* flora and their relationships. *Palaeontographica*, B149 : 153-182.
- SZAJNOCHA, L., 1889.—Über fossile Pflanzenreste aus Cacheuta in der Argentinischen Republik. *Akad. Wiss. Wien. Mat.-Naturwiss. Kl. Sitzungsber.*, 97 : 219-245.
- TAYLOR, T. N., 1966.—Paleozoic seed studies : on the genus *Hexapterospermum*. *Am. J. Bot.*, 53 : 185-192.
- TENISON WOODS, J., 1883.—On the fossil flora of the coal deposits of Australia. *PROC. LINN. SOC. N.S.W.*, 8 : 37-180.
- THOMAS, H. H., 1933.—On some pteridospermous plants from the Mesozoic rocks of South Africa. *Phil. Trans. R. Soc. Lond.*, B222 : 193-265.
- TOWNROW, J. A., 1956.—The genus *Lepidopteris* and its southern hemisphere species. *Nor. Videnskapskad. Mat.-Naturvidenskap. Kl. Aft.*, 2 : 1-28.
- , 1957.—On *Dicroidium*, probably a pteridospermous leaf and other leaves now removed from this genus. *Trans. Geol. Soc. S. Afr.*, 60 : 21-60.
- , 1960.—The Peltaspermeaceae, a pteridosperm family of Permian and Triassic age. *Palaeontology*, 3 : 333-361.
- , 1961.—On *Pteruchus*, the microsporophyll of the Corystospermeaceae. *Bull. Br. Mus. Nat. Hist. Geol.*, 6 : 285-316.
- , 1962.—On the nomenclature of *Pteruchus johnstoni* (Feistmantel) com. nov. *Pap. Proc. R. Soc. Tas.*, 96 : 91-93.
- , 1965.—A new member of the Corystospermeaceae. *Ann. Bot.*, 29 : 495-511.
- , 1966a.—On *Dicroidium odontopteroides* and *D. obtusifolium* in Tasmania. *Symp. floristics and stratigraphy of Gondwanaland*, Lucknow, India, 1964, pp. 124-136.
- , 1966b.—On *Lepidopteris madagascariensis* Carpenter (Peltaspermeaceae). *J. Proc. R. Soc. N.S.W.*, 98 : 203-214.
- , 1967a.—Fossil plants from Allan and Carapace Nunataks and from the upper Mill and Shackleton Glaciers, Antarctica. *N.Z. J. Geol. Geophys.*, 10 : 456-473.
- , 1967b.—On *Rissikia* and *Mataia*, podocarpaceous conifers from the lower Mesozoic of southern lands. *Pap. Proc. R. Soc. Tas.*, 101 : 103-136.
- , 1967c.—On *Voltziopsis*, a southern conifer of lower Triassic age. *Pap. Proc. R. Soc. Tas.*, 101 : 173-188.
- , 1969.—Some lower Mesozoic Podocarpaceae and Araucariaceae. *Proc. 1st Int. Gondwana Symp.* Buenos Aires, pp. 159-184.
- TOZER, E. T., 1964.—The Triassic Period. *Q. J. Geol. Soc. Lond.*, 1205 : 207-209.
- WALKOM, A. B., 1917a.—Mesozoic floras of Queensland. Part I (cont.). The flora of the Ipswich and Walloon Series (c) Filicales, etc. *Pub. Geol. Surv. Queensl.*, 257 : 1-46.
- , 1917b.—Mesozoic floras of Queensland. Part I (concluded). (d) Ginkgoales, (e) Cycadophyta, (f) Coniferales. *Pub. Geol. Surv. Queensl.*, 259 : 1-49.
- , 1921.—Mesozoic floras of New South Wales. Part I. Fossil plants from Cockabutta Mountain and Talbragar. *Mem. Geol. Surv. N.S.W. Palaeontol.*, 12 : 12p.
- , 1924.—On fossil plants from Bellevue, near Esk. *Mem. Queensl. Mus.*, 8 : 77-92.
- , 1925a.—Notes on some Tasmanian Mesozoic plants. Part I. *Pap. Proc. R. Soc. Tas.*, 1924 : 73-89.
- , 1925b.—Notes on some Tasmanian Mesozoic plants. Part II. *Pap. Proc. R. Soc. Tas.*, 1925 : 63-74.
- , 1925c.—Fossil plants from the Narrabeen Stage of the Hawkesbury Series. *PROC. LINN. SOC. N.S.W.*, 50 : 215-224.
- , 1928.—Fossil plants from the Esk district, Queensland. *PROC. LINN. SOC. N.S.W.*, 53 : 458-467.
- , 1932.—Fossil plants from Mount Piddington and Clarence Siding. *PROC. LINN. SOC. N.S.W.*, 57 : 123-126.
- WARD, L. F., 1905.—Status of the Mesozoic floras of the United States. *Monogr. U.S. Geol. Surv.*, 48 : 1-616.

A DESCRIPTION AND CLASSIFICATION OF SOME FINAL-INSTAR  
LARVAE OF THE PHYTODIETINI AND ECLYTINI (HYMENOPTERA,  
ICHNEUMONIDAE, TRYPHONINAE)

J. R. T. SHORT\*

[Accepted for publication 21st April 1976]

*Synopsis*

The characters of the final-instar larvae of the Phytodietini and Eclytini of the Tryphoninae are reviewed on knowledge of species belonging to seven genera. Keys on larval characters are given for these genera. In the Eclytini certain larval characters of *Hybophanes* and *Neliopisthus* are contrasted with those of *Eclytus* and *Hercus*.

INTRODUCTION

Descriptions and classifications of the final-instar larvae of the Tryphoninae have been published by Short (1959, 1970). This subfamily has been revised on adult characters (Townes, 1969). The author has since gathered new material of ichneumonid larvae and the larval characters of the Tryphoninae, and most other subfamilies, tribes and genera of the Ichneumonidae, must be restated.

The Tryphoninae are ectoparasites which attach eggs to the skin of the host by a stalk. The parasite larva completes its development in the host cocoon. Most Tryphoninae attack sawfly larvae. The Phytodietini and Eclytini attack mainly or only lepidopterous larvae and are world-wide in distribution. Other tribes are essentially Holarctic.

On larval and biological characters the Tryphoninae are a well-marked group. The subfamily is one of the few where the epistoma and labral sclerite are present together, although the epistoma is generally slender, with the dorsal part lightly sclerotised or unsclerotised in some Phytodietini and unsclerotised in the Idiogrammatini.

The methods used in preparing and mounting the larvae from the cocoons of bred material are described in Short (1959, p. 392). The terminology of the head parts, together with its basis in comparative morphology, is given in Short (1952). The slide preparations of *Phytodietus*, *Parabates*, *Hercus* and *Neliopisthus* will be deposited in the Hope Department of Entomology, University of Oxford. The slide preparation of *Eclytus* has been deposited in the Canadian Department of Agriculture. The slide preparations of *Netelia* will be deposited in the Australian National Insect Collection.

In this account *Euceros* is considered to be distinct from the Tryphoninae on larval and biological characters (Short, 1970).

LARVAL CHARACTERS OF THE TRYPHONINAE

The larval characters of the Tryphoninae are restated as follows (cf. Short, 1959, p. 419): head sclerites generally well developed although the epistoma is unsclerotised in the Idiogrammatini and only slightly sclerotised in the Phytodietini; prelabial sclerite absent; maxillary and labial palps flattened and disc-shaped and bearing two to three sensilla which show a pattern of trichoid and dome-shaped structures in the Phytodietini (Fig. 2a); silk press sclerotised; mandibles of moderate size with teeth on dorsal surface of blade (Phytodietini, Eclytini), without teeth (Boëthini, Cteniscini, Idiogrammatini) or with teeth

---

\* Department of Zoology, Australian National University, P.O. Box 4, A.C.T. 2600.

absent in most genera (Tryphonini); antennae papilliform with papillus partly reduced; closing apparatus of spiracle adjoining atrium (*Netelia*, *Parabates*) or situated some distance from atrium; skin with setae which may be conspicuously long (*Hybophanes*, *Netiopisthus*) and with small spines, except in *Ecenterus* where the spines are about half as long as the setae.

For a larval key to the tribes of the Tryphoninae see Short (1970, pp. 188-190).

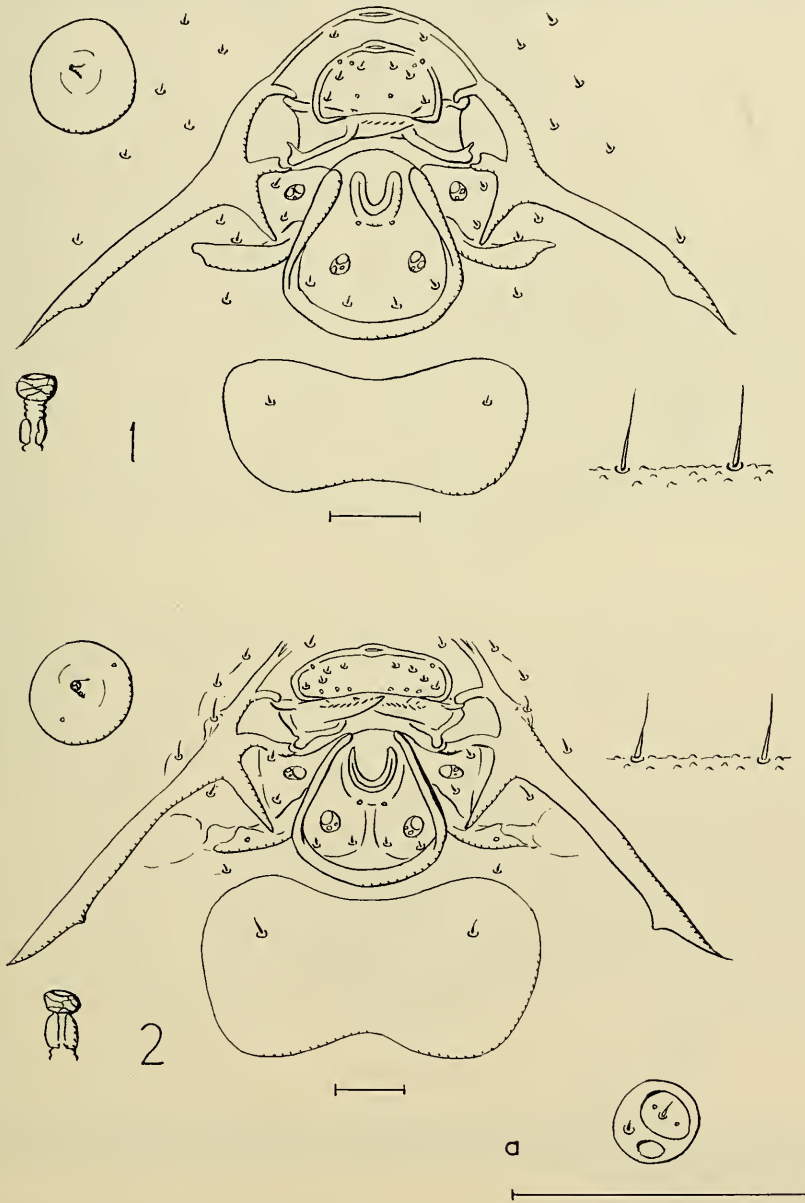

Figs 1-2. 1. *Phytodietus polyzonias* (Foerster) head sclerites and mandibles, antenna, spiracle and skin. 2. *Netelia productus* (Brullé) head sclerites and mandibles, antenna, spiracle and skin. 2a. Left labial palp. Scale: 0.1 mm.

*Tribe Phytodietini*

The lightly sclerotised plate situated on the labium ventral to the labial sclerite is characteristic of this tribe. In contrast to other tribes of the subfamily, apart from the Idiogrammatini, the dorsal part of the epistoma is very lightly sclerotised.

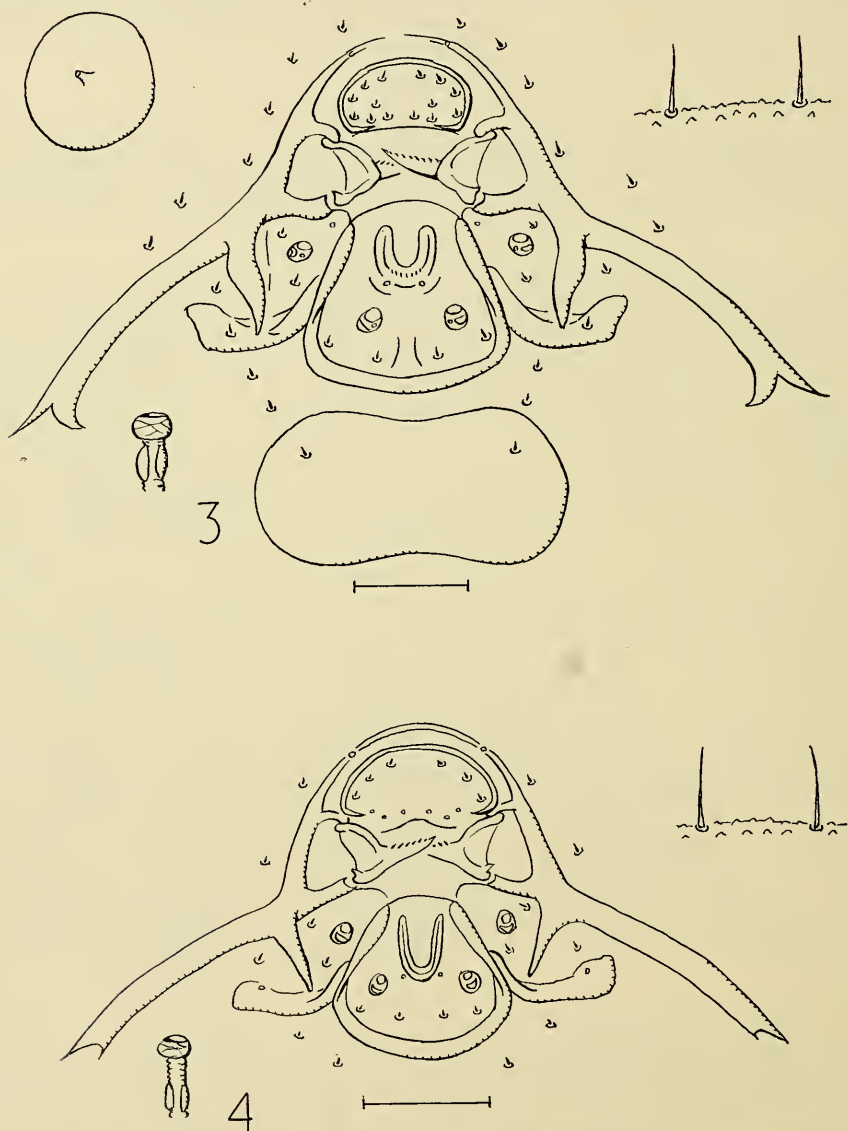

Figs 3-4. 3. *Parabates tarsatus* (Brischke) head sclerites and mandibles, antenna, spiracle and skin. 4. *Hercus fontinalis* (Holmgren) head sclerites and mandibles, spiracle and skin. Scale : 0.1 mm.

*Phytodietus polyzonias* (Foerster) (Fig. 1), *Netelia productus* (Brullé) (Fig. 2), *N. testacea* Gravenhorst, *N. capito* Kokujev, *Parabates tarsatus* (Brischke) (Fig. 3) and *P. cristatus* Thomson were examined.



*Phytodietus pulcherrimus* (Cresson) is figured by Short (1959) and by Simmonds (1947). *Phytodietus gelitorius* (Thunberg) is figured by Beirne (1941). *Phytodietus burgessi* (Cresson) is figured by Finlayson (1967). *Phytodietus vulgaris* Cresson is figured by Torgersen and Beckwith (1974); no setae are shown on the maxillae and labium and the labral sclerite is not shown. *Netelia geminatus* (Say) is figured by Short (1959), *N. vinulae* (Scopoli) by Beirne (1941) and *N. latungula* Thomson by Sechser (1970). *Netelia savi* (Cushman) is figured by Guppy and Miller (1970); details of the mandible and of the head region beneath the labial sclerite are not clear.

#### Larval Key to Genera

1. Closing apparatus of spiracle narrower than atrium and separated from atrium by length of trachea equal to depth of closing apparatus . . . . . *Phytodietus*
- Closing apparatus of spiracle as broad as atrium and adjoining or almost adjoining atrium . . . . . 2.
2. Labral sclerite with median expansion . . . . . *Netelia*
- Labral sclerite without median expansion . . . . . *Parabates*

The genus *Phytodietus* is of world-wide distribution. The hosts are smaller lepidopterous larvae living in rolled or folded leaves. *Netelia* and *Parabates* are also of world-wide distribution. The hosts are exposed lepidopterous larvae that pupate in the ground. The adults are crepuscular and attracted to light. The females can inflict a venomous sting. Townes (1969) places *Parabates* as a subgenus of *Netelia*. On larval characters these two genera are very similar but, as noted above, they can be distinguished on the form of the labral sclerite. They are therefore retained as separate genera in the present account. Dr Perkins has advised that there are grounds for retaining *Parabates* as a genus on adult characters.

#### Tribe Eclytini

The usual hosts of *Eclytus* are tenthredinids, although three are records from tortricids. There may be some confusion here since *Hercus fontinalis* (Holmgren) has been placed under *Eclytus*. The specimen of *H. fontinalis* figured in the present account was from *Tortrix viridana* (L.). The hosts of *Hercus* and *Neliopisthus* appear to be small Lepidoptera. *Hybophanes scabriculus* (Gravenhorst) has been reared from small Lepidoptera such as Olethreutidae.

The following have been examined: *Hercus fontinalis* (Holmgren) (Fig. 4), *Eclytus ornatus* (Holmgren) (Fig. 5) and *Neliopisthus elegans* (Ruthe) (Fig. 6).

*Hercus fontinalis* (Holmgren) is figured by Beirne (1941); teeth are not shown on the mandible. This species is also figured by Gerig (1960). *Eclytus ornatus* Holmgren is figured by Short (1959). This species is figured again in the present account to support comparisons in larval structure. *Eclytus ornatus* Holmgren is figured by Zinnert (1969) and by Pschorn-Walcher and Zinnert (1971). These authors state that the closing apparatus of the spiracle is absent; it is present although not close to the atrium.

#### Larval Key to Genera

1. Setae of skin of thorax as long or longer than hypostoma . . . . . 2.
- Setae of skin of thorax only as long as blade of mandible . . . . . 3.
2. Epistoma sharply arched . . . . . *Hybophanes* (Short, 1959, fig. 12b).
- Epistoma not sharply arched . . . . . *Neliopisthus*
3. Three sensilla on maxillary and labial palps . . . . . *Eclytus*
- Two sensilla on maxillary and labial palps . . . . . *Hercus*

Although most head sclerites, the mandibles, antennae and spiracles are generally similar in form in the four genera grouped here, *Hercus* and *Eclytus* differ so sharply from *Hybophanes* and *Neliopisthus* in the length of the skin setae and in the completeness of the dorsal part of the labral sclerite that one questions placing these genera in the one tribe. *Hybophanes* and *Neliopisthus* are very similar in larval characters, particularly in the form of the labral sclerite and the length of the skin setae. The sharply arched epistoma of *Hybophanes* serves to differentiate these genera.

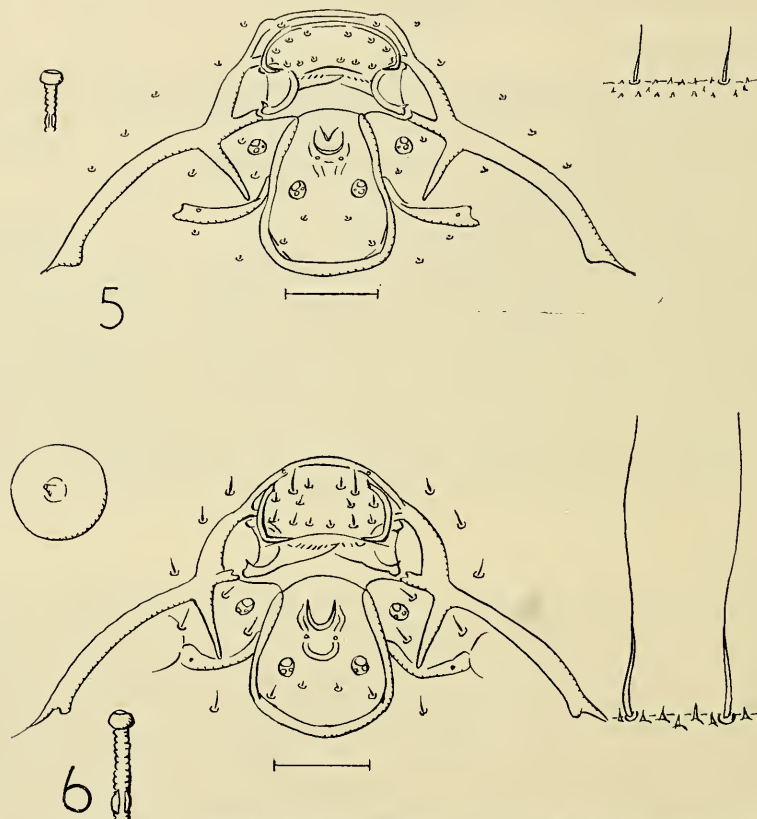

Figs 5-6. 5. *Eclytus ornatus* Holmgren head sclerites and mandibles, spiracle and skin. 6. *Neliopisthus elegans* (Ruthe) head sclerites and mandibles, antenna, spiracle and skin. Scale: 0.1 mm.

#### CONCLUSIONS

In the Phytodietini the genera can be readily keyed out and the classification scheme on larval character appears to be congruent with that based on adult characters. However, *Phytodietus* and *Netelia* are large genera and world-wide in distribution. As yet few larvae have been described.

In the Eclytini the larval characters of some species of four of the recognised nine genera are known. Conclusions based on larval characters must therefore be cautious compared with those based on adult. Nevertheless one is impressed by the difference in larval characters between *Hybophanes* and *Neliopisthus* on the one hand and *Eclytus* and *Hercus* on the other. Further studies may show the classification scheme on larval characters for this tribe to be incongruent with that based on adult. Equally they may show groups of genera within the Eclytini.

## ACKNOWLEDGEMENTS

I am deeply indebted to Dr. J. F. Perkins for advice on the classification, relationships and nomenclature of the Ichneumonidae, to Professor G. C. Varley for providing me with facilities for studying the collections of the Hope Department of Entomology, to the Canadian Department of Agriculture for providing me with material of *Eclytus* and to the N.S.W. Department of Agriculture for supplying me with reared material of *Netelia testacea* Gravenhorst and *Netelia productus* (Brullé). This material on *Netelia testacea* was collected at Taree, N.S.W., and Warrell Creek, N.S.W. The material of *Netelia productus* was collected at Narrabri, N.S.W. These adult specimens were identified through the kindness of Dr. G. J. Kerrich of the Commonwealth Institute of Entomology.

This work was supported by the Australian Research Grants Committee.

## References

- BEIRNE, B. P., 1941.—A consideration of the cephalic structures and spiracles of the final instar larvae of the Ichneumonidae (Hym.). *Trans. Soc. Br. Entomol.*, 7: 123–190.
- FINLAYSON, T., 1967.—Taxonomy of final instar larvae of the hymenopterous and dipterous parasites of *Acrobasis* spp. (Lepidoptera, Phycitidae) in the Ottawa region. *Can. Entomol.*, 99: 1–8.
- GERIG, L., 1960.—Zur Morphologie der Larvenstadien einiger parasitischer Hymenopteren des Grauen Lärchenwicklers (*Zeiraphera griseana* Hübner). *Z. Angew. Entomol.*, 46: 121–177.
- GUPPY, J. C., and MILLER, C. D. F., 1970.—Identification of cocoons and last instar larval remains of some hymenopterous parasitoids of the armyworm *Pseudaletia unipuncta* in eastern Ontario. *Can. Entomol.*, 102: 1320–1337.
- PSCHORN-WALCHER, H., and ZINNERT, K.-D., 1971.—Investigations on the ecology and natural control of the larch sawfly (*Pristiphora erichsonii* Htg., Hym.: Tenthredinidae) in Central Europe. Part II: Natural enemies: their biology and ecology, and their role as mortality factors in *P. erichsonii*. *Tech. Bull., Commonw. Inst. Biol. Control.*, 14: 1–50.
- SECHSER, B., 1970.—Der Parasitenkomplex des Kleinen Frostspanners (*Operophtera brumata* L.) (Lep., Geometridae) unter besonderer Berücksichtigung der Kokonparasiten. *Z. Angew. Entomol.*, 66: 1–35.
- SHORT, J. R. T., 1952.—The morphology of the head of larval Hymenoptera with special reference to the head of Ichneumonoidea, including a classification of the final instar larvae of the Braconidae. *Trans. R. Entomol. Soc. Lond.*, 103: 27–84.
- , 1959.—A description and classification of the final instar larvae of the Ichneumonidae (Insecta, Hymenoptera). *Proc. U.S. Natl. Mus.*, 110: 391–511.
- , 1970.—On the classification of the final instar larvae of the Ichneumonidae (Hymenoptera). Supplement. *Trans. R. Entomol. Soc. Lond.*, 122: 185–210.
- SIMMONDS, F. J., 1947.—The biology of *Phytodietus pulcherrimus* (Cress.) (Ichneumonidae, Tryphoninae) parasitic on *Loxostege sticticalis* L. in North America. *Parasitology*, 38: 150–156.
- TORGENSEN, T. R., and BECKWITH, R. C., 1974.—Parasitoids associated with the Large Aspen Tortrix *Choristoneura confictana* (Lepidoptera, Tortricidae) in interior Alaska. *Can. Entomol.*, 106: 1247–1265.
- TOWNES, H., 1939.—The genera of the Ichneumonidae 1. *Mem. Am. Entomol. Inst.*, 11: 1–300.
- ZINNERT, K.-D., 1969.—Vergleichende Untersuchungen zur Morphologie und Biologie der Larvenparasiten (Hymenoptera Ichneumonidae und Braconidae) mitteleuropäischer Blattwespen aus der Subfamilie Nematinae (Hymenoptera: Tenthredinidae). *Z. Angew. Entomol.*, 64: 180–217, 277–306.

BIONOMICS AND BEHAVIOUR PATTERNS OF THE *ANOPHELES*  
*PUNCTULATUS* COMPLEX (DIPTERA: CULICIDAE) IN THE  
D'ENTRECASTEAUX ISLANDS, PAPUA

M. SPENCER\*

[Accepted for publication 24th March 1976]

*Synopsis*

Biting patterns as shown by all-night outdoor legbiting catches are detailed and discussed for Goodenough Island and for three localities on Fergusson Island. Some culicine species are listed. Breeding sites of *A. farauti*, prevalence of *A. punctulatus* and *A. subpictus*, and the effects of the first DDT spray round on anopheline densities are also discussed. Observations on day- and night-resting indoors, day-resting outdoors, exit-trap catches, parity and sporozoite rates are given. Field and laboratory observations are reviewed to elucidate basic behaviour patterns and to bring out gaps in our knowledge. Development of the oocytes after the bloodmeal, and ovariole contraction after oviposition are related to behaviour patterns and to movement of the females towards and away from the host. By deduction from observations the conclusion is reached that the gonotrophic cycle on the coast is likely to be regularly repeated and to be 48 hours in length. The egg-adult survival rate needed to maintain or increase the population is discussed in relation to *A. farauti*. Factors affecting survival and the length of the gonotrophic cycle are considered, and the practical implications of variations in biting density are pointed out.

INTRODUCTION

This group of three major islands and a number of lesser ones are located off the northeastern end of the Papuan mainland. Their general features and their anopheline fauna have been described previously in a series of papers (Spencer, 1960-71a). A locality list (Spencer, 1960) shows the observed prespray† distribution of adults and larvae of the seven species of *Anopheles* found there (*A. farauti*, *A. punctulatus*, *A. koliensis*, *A. annulipes*, *A. subpictus*, *A. longirostris*, *A. bancroftii*). The present paper enlarges previous descriptions, includes detailed data not previously published in this form, and discusses them on a wider basis.

Goodenough Island with 9,000 indigenous inhabitants is located 150°10'E. and 9°20'S. and is approximately 32 km long and 29 km wide (Fig. 1). The mountains rise abruptly to 2,545 m above sea level. The coastal shelf of the western side is narrow with a number of large rivers and creeks running through it. The wide grassy coastal plain of the eastern side is cut by numerous rivers and is fringed by extensive swamps between Vivigani and Bolu Bolu. There is one deeply indented bay, Mud Bay, between Fai'ava and Bwaidoga. Over most of the island soils are sandy loams with low clay content derived from acid igneous rocks; in the southwest corner shallow soils with a very high clay content are derived from basic igneous rocks. The average annual rainfall over an eight-year period was 2,540 mm.

Fergusson Island with 12,000 indigenous inhabitants lies slightly to the east of Goodenough Island and is approximately 64 km long and 48 km wide at its widest point. It has a varied terrain, of which only a small area will

---

\* Formerly Entomologist, Department of Public Health, Port Moresby, Papua New Guinea  
Present address: 1 George St., Tenterfield, New South Wales, 2372.

† Prespray and postspray observations are those carried out before and after the start of house-spraying operations in a malaria control or eradication programme. In Papua New Guinea the main residual insecticide used has been DDT.

be considered in this paper. In this area the soil is a sandy loam derived from acid igneous rock. The average annual rainfall over an eight-year period was 2,540 mm.

Although this group of islands is classified as "continuously wet" (Ward and Lea, 1970), periods of reduced rainfall may occur April-July. The effects of rainfall upon prevalence have been discussed previously (Spencer, 1970, 1971a).

#### METHODS

Methods have been detailed in earlier papers. In addition to standard 12-hour legbiting catches, and sampling by exit-trap, observations were made on day- and night-indoor resting (both by continuous observation and for limited time periods), and day resting out-of-doors.



Fig. 1. Goodenough Island and part of Fergusson Island (F.I.S.) showing latitude, longitude, place names and averaged biting densities for *A. farauti*.

#### GOODENOUGH ISLAND

##### Wartime Observations

Extensive investigation of the large swampy tracts on the eastern coastline was carried out by Strong (1943), who reported that *A. farauti* larvae were present in the transition zone between the fringing scrub and the mangroves, where the water table reached the surface in depressed areas before the mangrove margin began. He called it "the dangerous transition zone between the salt-tolerant vegetation and the fringing forest of the coast". Breeding sometimes extended distances into the mangroves even though the waters lay under a high canopy through which only limited amounts of sunshine penetrated. The

zone was not continuous along the whole coastline. Along a large proportion the soil was porous, the water did not approach the surface, and the transition to the tidal zone of salt water was sharp. Strong (1943) noted that large breeding zones of anophelines which would be difficult to control occurred at the mouth of Malauna Creek, at Vivigani, and towards the mouth of Kwai Kwai creek (Fig. 1, Kwaiokwaio). Strong did not specifically relate these to concentrations of troops or indigenes. Allman (1943) had previously noted heavy anopheline breeding about Kwaiokwaio village.

TABLE 1

*Analysis of 41 all-night outdoor-biting catches on Goodenough Island in 1957 (prespray), 1958 (prespray) and 1959 (six months postspray, immediately before second spray round)*

Place	August–September 1957				August–October 1958				5–20 June 1959					
	Date	Species and no. taken				Date	Species and no. taken				Species and no. taken			
		F*	P*	K*	S*		F	P	K	S	F	P	K	S
Mataita	.. 22.8	146			2	8.10†	91			22				
	27.9	376	1											
Faiava	.. 26.9	387	22		3	10.10	40			22				
Bwaidoga	..					25.8	2							
Kilia	..					30.8†	31			5				
Lauwela	.. 13.11	59			1	2.9	4							
						3.9	29							
Auwale	..					4.9†	157			11	48			
Diodio	.. 24.8	50				5.9	1			1				
Aikawa (Iauiaula)	.. 26.8†	124				9.9	36			25	26			
Buwari (Saibutu)	27.8†	143		1	1	11.9	111			26	13			
Ufaufa	.. 12.11	109			2	12.9†	101			26	8			
						15.9	110			8				
Lower Wateluma (Budula)	29.8†	48			2	20.9	19							
	11.11	104			3									
Idakameni	..					21.9	25			12				
Vivigani	..					29.9†	282			54				
Bele Bele	.. 10.11	635			9	3.10†	312			9				

\* F=*A. farauti*; P=*A. punctulatus*; K=*A. koliensis*; S=*A. subpictus*. Two locality names are given where necessary to identify places listed in Spencer (1960).

† Attack rates during the first hour and the first quarter of the night were equal or almost equal to attack rates during any other hour or to any other three quarters of the night.

Strong's (1943) account is interesting because although the observations were made under the unnatural conditions of wartime and in the presence of large numbers of troops camped under canvas, it is the only definitive description known to this writer of anopheline breeding related to extensive swampy coastal tracts in Papua New Guinea. Unfortunately there was no opportunity for our team to follow up Strong's observations.

Strong also observed daytime biting by unidentified anophelines ("not *bancroftii*") in the open about 45 m from the heavy breeding of Kwai Kwai creek.

Other wartime surveys (Allman, 1943; Swan, 1943; Hart, 1944) reported (1) extensive *A. punctulatus* breeding, especially along a road running north to Wateluma and within a few hundred metres of native villages, (2) *A. farauti* larvae in borrow-pits near the coast at Vivigani, and (3) prolific breeding in the Bolu Bolu area. The culicine species reported included *Aedes notoscriptus* and *A. scutellaris*, *Culex annulirostris*, *C. squamosus*, *C. pullus*, *C. bitaeniorhynchus*, *C. vicinus*, and *C. sitiens*.

TABLE 2

*Analysis of all-night legbiting catches for species composition, average biting density and premidnight attack for 14 villages on Goodenough Island and 4 villages on Fergusson Island*

Place	Period, total no. taken and no. of catches	Species%			Average biting density/man/night	Premidnight attack%†
		F*	P*	S*		
<i>Goodenough Island</i>						
Prespray	Aug.-Sept. 1957 2,228 11 catches	98	1	1	158 outdoor (Bele Bele excluded)	46.7
	Aug.-Oct. 1958 1,572 16 catches	85.9		14.1	112 outdoor (including <i>A. subpictus</i> )	53.4
Postspray	June 1959 95 14 catches	100			7 outdoor	—
<i>Fergusson Island</i>						
Bwalalea (Spencer, 1970) + 2 catches	1957-59 2,196 21 catches	94.7	5.1	3 specimens	104 outdoor 139 indoor	51.4
Iaupolo (Spencer, 1970) + 6 catches	1957-59 1,106 15 catches	98.5	0.6	0.9	99 outdoor	46.5
Iamalele (Spencer, 1970)	May-Aug. 1959 1,156 14 catches	100			83 outdoor	51.6
Mapamoiwa (Spencer, 1970)	1957-58 169 13 catches	99.98	0.02		13 outdoor	63.5

\* F = *A. farauti* P = *A. punctulatus* S = *A. subpictus*. † See also Table 10.

#### PRESPRAY OBSERVATIONS 1957 AND 1958

Details and localities of all-night legbiting catches are shown in Tables 1 and 2 and in Fig. 1. Attack rates were high, with 21 catches registering more than 100 bites/man/night. Biting rates were generally lower in 1958 than in 1957; this can be attributed to differing places, months of the year and varying seasonal conditions. The outstandingly large catch at Bele Bele in 1957 may be due to an invasion of the type described by Sweeney (1968) on Han Island in the Carterets Group. Unfortunately at that time we had not begun investigations into parousness. Such large numbers of anophelines may have originated from breeding sites in the "transition zone" (see above) below the village.

In three catches in the 1957 series and in six catches of the 1958 series (see Table 1), attack rate during the first hour of the catch, 6-7 p.m., was equal or almost equal to that during any other hour of the night, and during the first quarter of the catch, 6-9 p.m., was equal or almost equal to that during any of the other three quarters (see also Table 10). In the majority of the villages, while biting began at dusk, the attack rate intensified after 9 p.m. It has been observed elsewhere for *A. farauti* (Spencer, 1971*b*) that both gravid females and empty females with fully dilated ovariole sacs (indicating recent oviposition) are on the wing as early as 5.45 p.m.; one factor in variations in time period intensity of attack is the distance flown between resting and oviposition sites and the catching station. Other factors will be considered later in this paper.

It is clear that attack takes place all night long. There was no real peak of biting, the period of highest biting density being 9 p.m.-3 a.m. (Fig. 2).

The 1958 series was not included in the general analysis for derivation of manbiting rate (Spencer, 1965) because of the high proportion of *A. subpictus* present.

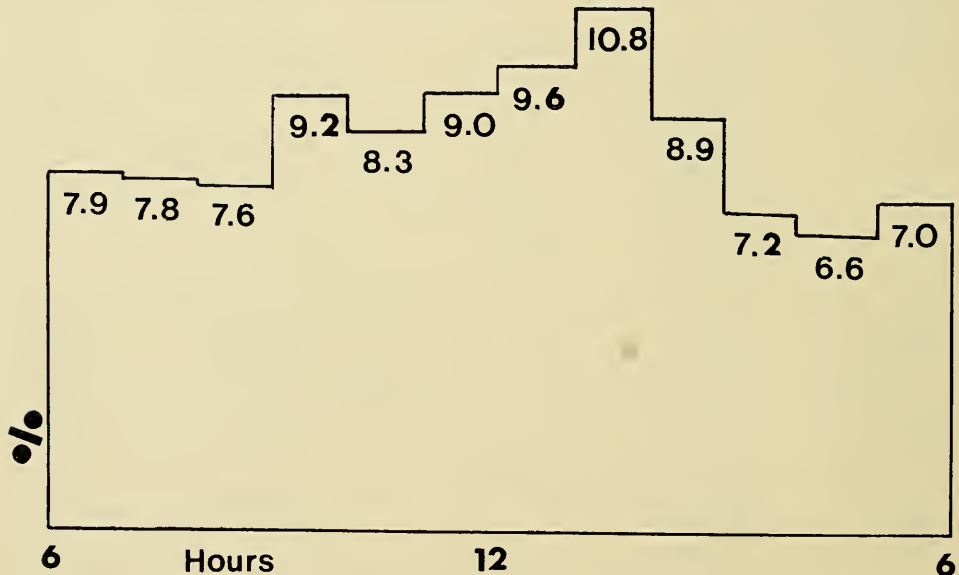

Fig. 2. Biting pattern of total anophelines (93.6% *A. farauti*, 6.4% *A. subpictus*; Bele Bele village excluded) per cent per hour, 6 p.m.-6 a.m., for 1957-58 on Goodenough Island.

*Anopheles punctulatus* occurred only twice in these two series of legbiting catches (Table 1). A further single specimen of this species was taken resting by night on the wall of a house at Ufaufa, and larvae were collected at Auwale. In view of our other records from Bele Bele and Lauwela (Spencer, 1960) there can be little doubt that this species occurs island-wide with the explosive potential which was fully demonstrated under wartime conditions but now dormant because of lack of suitable conditions.

One specimen of *A. koliensis* was taken at Buwari and two specimens at Ufaufa. Identification was based on the presence of a yellow spot on the ventral side of the proboscis. It is possible that this species also occurred island-wide in small numbers as our records show three other localities where it was found (Spencer, 1960).



*Anopheles subpictus* was found at points right around the island, with its numbers noticeably higher in 1958 than in 1957 (Table 1), due particularly to periods of lessened flow in shallow creeks with tidal backwaters.

Details of day and night indoor-resting searches are shown in Table 3. Numbers taken in night house-resting searches are very much higher than those from day-resting catches. It will be noted that one *Anopheles punctulatus* female was taken at Bele Bele. No females of this species occurred in biting catches in this locality.

TABLE 3

*Analysis of day and night indoor-resting catches on Goodenough Island (prespray and postspray) and Fergusson Island (prespray)*

Date and place	Type of catch and time period	No. of houses searched	No. of houses positive	Species (total no.)			No. of anophelines/positive house
				F*	P*	S*	
<i>Goodenough Island</i>							
Bele Bele April 1957	Day indoor-resting 6-8 a.m.	19	10	26	1	1	1-7
Vivigani July 1957	Day indoor-resting 6-8 a.m.	14	14	52		3	1-13
<i>Prespray</i>							
4 villages 10-13 Nov. 1957	All night indoor-resting	11	11	468		105	Average 42F, 10S
4 villages 10-13 Nov. 1957	Indoor-resting 10 p.m.—2 a.m.	11	11	274		39	Average 25F, 4S
<i>Postspray</i>							
14 villages 4-23 April 1959	Night indoor-resting 10 p.m.—2 a.m.	187	31	140 (42.9% unfed)			Average 6F†
<i>Fergusson Island</i>							
<i>Prespray</i>							
1957-59	All night indoor-resting	49	49	1547	5	115	Average 34
1957	Day indoor-resting	200	100	400			1-17; Average 4
Iaupolo, 1957	Day indoor-resting	48	18	51			1-17

\* F = *A. farauti*, P = *A. punctulatus*, S = *A. subpictus*.

† Less than 5 anophelines: 17 houses; 5-10 anophelines: 9 houses; 10-15 anophelines: 4 houses; 16 anophelines: 1 house (in all cases the houses were new and unsprayed, or contained unsprayed walls, or had faulty spraying).

#### POSTSPRAY OBSERVATIONS

Details of legbiting catches and night-resting catches, for comparison with prespray figures, are shown in Tables 1, 2 and 4. Both biting densities and night house-resting densities were much reduced by spraying.

Culicine species recorded postspray (Norris, 1971, adult collection) include *Uranotaenia civinskii* (Kwaikwaio), *Aedes scutellaris* (Nuatutu, between Bolu Bolu and Mataita), *Culex annulirostris* (Wateluma), *C. pullus* (Wateluma, Nuatutu), and *C. fraudatrix* (Kwaiokwaio). *Anopheles pseudobarbirostris* was recorded from Wateluma. *Anopheles farauti* was recorded from Wateluma only.

#### FERGUSSON ISLAND

So far as the author is aware, no entomological observations had been carried out on Fergusson Island prior to our investigations.

## GENERAL OBSERVATIONS

*Night-biting Indoors*

It was reported earlier (Spencer, 1965) that there was little difference between the outdoor and the indoor biting rate.

*Night-resting Indoors*

Details are given in Table 3. A time period analysis without species differentiation of the catches in 30 houses is shown in Table 5. As the greatest concentration of anophelines within houses occurred between 10 p.m. and 2 a.m., this time period was adopted for standard sampling.

TABLE 4

*Analysis of total night indoor-resting (10 p.m.—2 a.m.) anophelines taken on Goodenough Island prespray\* and four and a half months postspray*

Place	Date	Total anophelines			No. of houses
		F†	P†	S†	
Mataita .. ..	8 April 1959	1			22
Faiava .. ..	4 April 1959	10	2		5
	5 April 1959	3	1		4
	6 April 1959	1			18
	7 April 1959				21
	9 April 1959				16
Bwaidoga .. ..	8 April 1959	7			9
Kilia .. ..	11 April 1959				2
Lauwela .. ..	<b>13 November 1957</b>	<b>125</b>		<b>8</b>	3
	12 April 1959	16			3
Auwale .. ..	13 April 1959	30			4
Diodio .. ..	14 April 1959				10
Aikawa .. .. (Iaiuaula)	15 April 1959	27			2
Buwari .. .. (Saibutu) .. ..	16 May 1959	5		2	10
Ufaufa .. ..	<b>12 November 1957</b>	<b>54</b>		<b>30</b>	2
Lower Wateluma (Budula) .. ..	<b>11 November 1957</b>	<b>37</b>			3
	19 April 1959	3			10
Idakamenai .. ..	20 April 1959				10
Vivigani .. ..	22 April 1959	30			10
Bele Bele .. ..	<b>10 November 1957</b>	<b>58</b>		<b>1</b>	3
	23 April 1959				11

\* Shown in bold type.

† F = *A. farauti* P = *A. punctulatus* S = *A. subpictus*.

A series of 4-hour catches from 75 different houses in a number of villages was then analysed. Only two of the catches yielded over 70 anophelines (95 and 253 respectively). The histogram (Fig. 3) indicates that the majority of unsprayed houses in the D'Entrecasteaux Islands can be expected to yield up to 30 anophelines between these hours of the night under normal circumstances of weather and occupancy.

*Exit-traps*

The figures for state of feeding of anophelines taken in exit-traps throughout the night are shown in Tables 6 and 8. The percentage of fed females in both *A. farauti* and *A. punctulatus* is close to Slooff's (1964) figures (82–84%) from test-hut experiments.

TABLE 5  
*All-night indoor-resting catches from  
30 houses on Fergusson Island*

Time period	Total numbers 1957–58
6 p.m.–8 p.m.	62
8 p.m.–10 p.m.	74
10 p.m.–12 midnight	262
12 midnight–2 a.m.	405
2 a.m.–4 a.m.	237
4 a.m.–6 a.m.	63
Total	1,103

*Day-resting Indoors*

From the results shown in Table 6 it is clear that *A. farauti* and *A. punctulatus* females seldom remain within village houses until their eggs are mature. The percentage of gravid females remaining within houses and leaving houses is consistently low, less than 3% in all the larger series. From Slooff's (1964) figures it can be calculated that day indoor-resting *A. punctulatus* represent 4.6% of those that entered during the night, while day-resting *A. farauti* represent 1.2% and *A. koliensis* 1.2%; the figure for all species is 2.6% of the night-entering population. His (prespray) figures could be used as factors for calculating the numbers of each species that had entered throughout the night from the numbers of indoor day-resting anophelines recovered. Slooff's series confirms that *A. punctulatus* has a greater tendency to remain indoors

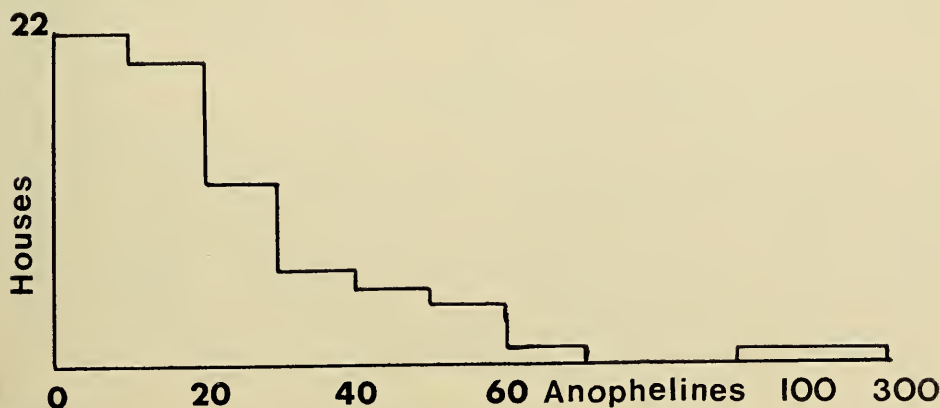

Fig. 3. Distribution of anophelines per hour in 4-hour (10 p.m.–2 a.m.) catches from 75 houses on Fergusson Island.

by day than the other two species. Our figures suggest that among these day indoor-resting *A. punctulatus* females may be a higher proportion of empty mosquitoes than would generally be found with *A. farauti*. Empty mosquitoes are more susceptible to desiccation and to insecticides than fully-fed ones are.

The average number of day house-resting *A. farauti* in a total of 200 houses was four (1-17/positive house) with 50% of houses negative (Table 3).

#### DETAILED OBSERVATIONS

##### *Bwalalea Village*

*General.* This village (Fig. 1) was located about 6 km from our base at Mapamoiwa station and was connected to it by a narrow foot-track through the coastal forest, which here came right down to the beach. The village consisted of two hamlets in separate clearings with some secondary growth between them, but linked by a wide and much used track. About 30 people belonging to several families occupied some 12 houses (as the numbers of people fluctuated with comings and goings of relatives and trading partners so also did the number of houses occupied).

TABLE 6  
*State of feeding of anophelines leaving village houses and remaining indoors by day on Fergusson Island*

Date and number taken	<i>A. farauti</i> %			<i>A. punctulatus</i> %			Type of catch
	Fed	Empty	Gravid	Fed	Empty	Gravid	
Oct. 1956-Dec. 1957							
823	85.2	11.9	2.9				Exit-trap
346				86.7	12.1	1.2	
March-May 1957							
416	94.2	3.6	2.0				Day-resting indoors (4 houses)
34				52.9	41.2	5.9	
Oct. 1956-Dec. 1957							
706	93.9	4.7	1.4				Day-resting indoors (1 house)
187				90.9	9.09		

The relationship between the human and the anopheline populations was as close to a natural basic one as it is possible to envisage. Environmental interference by the human population was minimal. There were no roads, no traffic, and no ditch digging in the agricultural practice. No mosquito nets were used, and the housing of slatted bush materials was of an open type which allowed free entry and exit to mosquitoes.

Two semi-permanent to permanent breeding sites for *A. farauti* were located outside the perimeter of the village clearing: a small beachside lagoon and a series of small pools among mangrove roots which varied in level with the tides. As the village was sited just behind the beach and was not (most unusually) adjacent to a running creek, these were undoubtedly the major sources of the anopheline population of the village. Casual waters in foot-prints, pig-wallows and other depressions were supplementary breeding-places.

The domestic animal population was 11 dogs, some fowls and two pigs. The human blood index of outdoor-resting mosquitoes was 0.72 (Spencer, 1964), the dog blood index was 0.19 and the pig blood index 0.03, with 0.06 unknown.

*Legbiting catches* (see Table 2). Two final catches were made in 1959 after the greater part of Fergusson Island had had its first spray round in the malaria eradication programme. Bwalalea was included in the check (control) area

which was not sprayed until the second round. The percentage for *A. farauti* was the same as in the larger series of biting catches for the whole D'Entrecasteaux Group (Spencer, 1965), but the percentage of *A. punctulatus* was twice that of the larger series. In view of the appearance and disappearance of *A. punctulatus* as previously described (Spencer, 1970), the higher percentage seen at Bwalalea would almost certainly be duplicated elsewhere if a prolonged series of catches were undertaken in some other locality. In a period (September-October 1957) when this elusive species represented 10% of the total taken in all-night biting catches, it formed 50% of a total catch of 195 female anophelines from day-resting outdoor catches in the vicinity of the village. The observations on *A. punctulatus* at Bwalalea were particularly interesting because this village was not sited in a river valley or near a watercourse or on soil with a high clay content. The soil here was generally rather poor with just sufficient clay content for compacting and puddling when wet. *A. punctulatus* specimens were also taken resting on walls at night, and in exit-traps, but not in sufficient numbers to establish behaviour patterns from the observations. A few specimens of *A. subpictus* were found day resting, both indoors and outdoors.

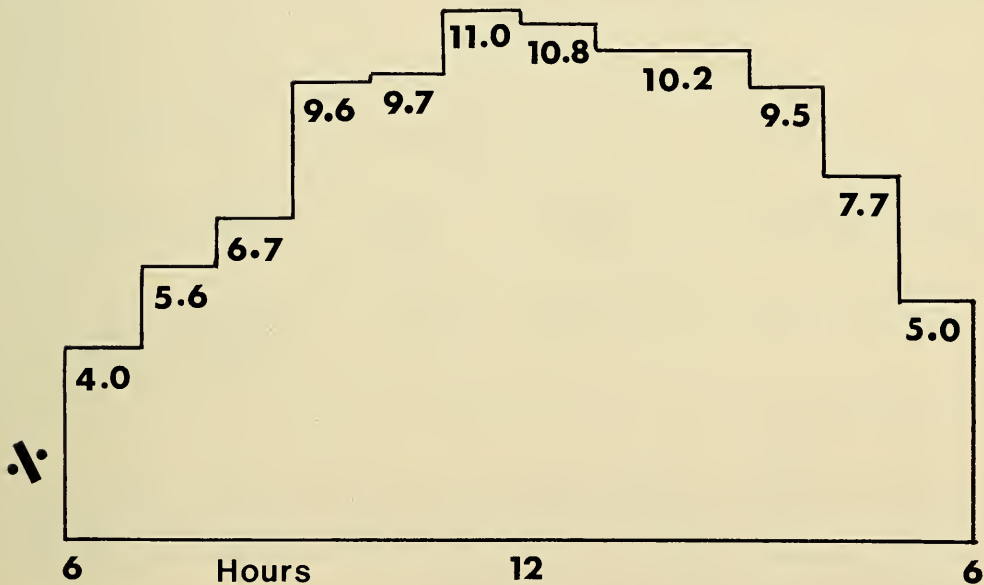

Fig. 4. Biting pattern of total anophelines (94.7% *A. farauti*, 5.1% *A. punctulatus*) per cent per hour, 6 p.m.-6 a.m., for 1957-58 at Bwalalea, Fergusson Island.

The biting pattern for *A. farauti* within the village is shown in Fig. 4 and Table 10. In no catch was the intensity of the attack in the first hour of the night greater than in succeeding hours, and in only four catches was the biting intensity in the first quarter of the night equal to that of the second quarter. It is considered that this reflects the distance between the breeding sites and the collecting stations within the village. Unfed anophelines rested in the vicinity of their hosts after their searching flight and before biting attack.

Seventeen of the 113 *A. punctulatus* were taken before 9 p.m., 24 between 9 p.m. and midnight, 40 between midnight and 3 a.m., and 32 between 3 and 6 a.m.

*Sporozoite rates* (see Table 7). Problems of sampling for sporozoite rate have been discussed previously (Spencer, 1969).

*Fertilisation and day outdoor-resting.* We examined the spermathecae of some hundreds of females taken in biting catches, and all contained motile sperm (the exact number is not now known to the author). It is not yet known when or where fertilisation takes place under natural conditions; under laboratory conditions fertilisation takes place on the first night after emergence, and the first bloodmeal usually takes place on the second night after emergence (Mackerras and Lemerle 1949, for *A. punctulatus*; Bryan 1973, for *A. farauti*).

Between 30 September 1957 and 20 August 1958 day outdoor-resting searches yielded 292 males and 556 females of *A. farauti* (8% empty, 56% fed and 36% fully gravid). With these were recovered 66 female *A. punctulatus* (3% empty, 27% fed and 70% gravid).

Between 11 June and 30 June 1959, 147 *A. farauti* females and 5 males were taken resting outdoors by day in the vicinity of the village, the numbers taken by one man on each of 15 days of searching for one hour varying between 3 and 21. During this period the numbers taken per exit-trap per day varied between 2 and 41 with an average number of 13 (regarded as a period of moderately high density for this village).

TABLE 7  
*Sporozoite rates and types of catch for 2 villages on Fergusson Island*

Date and place	No. dissected	Sporozoite rate	Type of catch
<i>Bwalalea</i>			
18 June 1957–11 Aug. 1958	698	0.57	Leg-biting
Dec. 1957–March 1959	243	1.6	Day-resting outdoors
March–May 1959	2,733	0.29*	Exit-traps
<i>Iaupolo</i>			
6 Jan.–19 Aug. 1958	285	2.1	Leg-biting
	40	5.0	Day-resting indoors
	58	1.7	Day-resting outdoors

\*See also Table 8.

Between 1 July and 9 July 1959, 87 *A. farauti* females and 3 males were taken on seven days, the number taken by one man in one hour's search varying between 2 and 27. During this period the number taken per exit-trap per day varied between 9 and 27 with an average number of 15 (again regarded as a period of moderately high density—see below.)

In our searches males were found resting outdoors in the same places as the females, near the villages, and often in quite large numbers; only very occasionally was a male recovered from an exit-trap or found resting in a house. In day searches for outdoor-resting mosquitoes we had the most consistent success where the edges of the village clearing had been invaded by secondary growth of ferns, tall grass and shrubs, and on the side of the clearings nearest to the breeding sites. The best results were obtained on a grey morning after rain when other catches showed that densities were high. Typical resting situations are the bases of grass stems, the underside of fallen logs and fern leaves, or among the rubbish on the village tip.

*Garden area.* The outdoor-biting situation away from village areas was tentatively explored in a garden area where the night shelter was a roof of sago leaves supported by a minimal framework. Biting rates here were low but quite significant (12 and 19 bites/man/night).

TABLE 8  
*Exit-trap catches, state of feeding and sporozoite rates for Anopheles farauti taken February-August, 1959 at Ewatalea village, Fergusson Island*

Period, 1959	Exit-trap catches					Total no. taken	No. examined	State of feeding		Sporozoite dissections		
	No. 1	No. 2	No. 3	No. 4	No. 5			Fed	Empty	Gravid	No.	No. positive
	Total no. taken											
24-28 February	55	135	23	73	37	323						
March	309	625	37	394	285	1,650	189	171	12	6	229	
April	195	286	59	142	61	743	545	483	20	42	480	
May	448	551	234	542	248	2,023	1,751	1,597	137	17	1,199	
June	378	270	176	314	176	1,314					825	
July	737	1,057	655	695		3,144						
1-6 August						173						
Total	2,122	2,924	1,184	2,160		9,370	2,485	2,251 (90.6%)	169 (6.8%)	65 (2.6%)	2,733	

\* Average catch = 15.5 female *A. farauti*/exit-trap/night.

*Exit-trap catches, state of feeding and outdoor biting densities.* The state of feeding in exit-trapped *A. farauti* females is shown in Table 8. The figure for gravid females is again less than 3% (cf. Table 6).

The months of higher biting density for 1957 and 1958 (arbitrarily over 100 bites/man/night) were August-February, the months of lower biting density March-July (as low as 7 bites/man/night, Spencer, 1970). Detailed and reliable exit-trap figures are available only for the months February-August 1959 (Table 8). These figures show lowest numbers during April and June with most catches less than 10/trap/night, and particularly high catches for July, which were mostly over 10/trap/night and up to 101/trap/night. These figures reflect the numbers of people sleeping in the houses as well as seasonal factors. On 14 July 1959, the outdoor biting density was 130/man/night and the total catch from four exit-traps was 115. On the following night the biting density was 25/man/night and the total exit-trap catch was 138. (The numbers of people sleeping

TABLE 9  
*Prespray age estimations for Anopheles farauti females taken June 1959 at Bwalalea Village, Fergusson Island*

Gonotrophic cycle	Dilatations*	Estimated age (days)	Time of entering trap				Total no. taken
			6 p.m.- 9 p.m.	9 p.m.- 12 midn.	12 midn.- 3 a.m.	3 a.m.- 6 a.m.	
			No. taken				
2	1	6	4	10	12	15	41 (36.3%)
3	2	8	6	18	9	9	42 (37.2%)
4	3	10	1	10	4	4	19 (16.8%)
5	4	12		1	1	5	7 (6.2%)
6	5	14		1			1 (0.89%)
7	6	16				1	1 (0.89%)
8	7	18					
9	8	20					
10	9	22		2			2 (1.8%)
Total			11	42	26	34	113

\* Of the parous mosquitoes, 26.6% showed  $\geq 3$  dilations.

in the houses is not accurately known). The exit-traps yielded an average of 15.5 anophelines/trap/night from the last week in February to the end of the first week in August for the four traps that were constantly in operation. This period covered the months in which low anopheline biting densities had been experienced in 1957 and 1958. Sweeney (1968) using exit-traps on Han Island in the Carteret Group considered more than 20 mosquitoes/3 traps/night to be unusually large exit-trap collections. Our figures from Bwalalea show exit-trap collections of up to 30/trap/night occurring commonly. However we did not observe in Bwalalea anything similar to the tremendous invasions of newly emerged anophelines that Sweeney observed five times on Han Island. The biting population at Bwalalea was a relatively constant one.



Dissections for parity showed that 26·6% of 113 parous females showed three or more dilatations and 9·7% showed four or more dilatations (Table 9). This would be the minimum number that could be expected to be epidemiologically dangerous. For comparison, in a larger series of 588 parous females dissected at Madang (Spencer, 1974), 34·9% showed three or more dilatations and 15·5% showed four or more dilatations.

The average biting density for *A. punctulatus* (12 catches) was 10/bites/man/night, the biting rate varying between 1 and 26. Peak of occurrence was September–October (Spencer, 1970).

#### *Iaupolo Village*

*General.* This village (Fig. 1) was about 0·5 km further inland than Bwalalea, separated from it by coastal forest, with its own anopheline breeding sites near the village and similar to those of Bwalalea in being semi-permanent to permanent. Situated further back from the beach, it was more sheltered from the south-east monsoon. About 40 people occupied eight houses, with three dogs and two pigs. As would be expected the human blood index (0·89) of outdoor-resting females (from 27 specimens only) was higher than in Bwalalea. (The relationship of relative numbers of people, pigs and dogs to the human blood index has been discussed in Spencer *et al.* (1974).

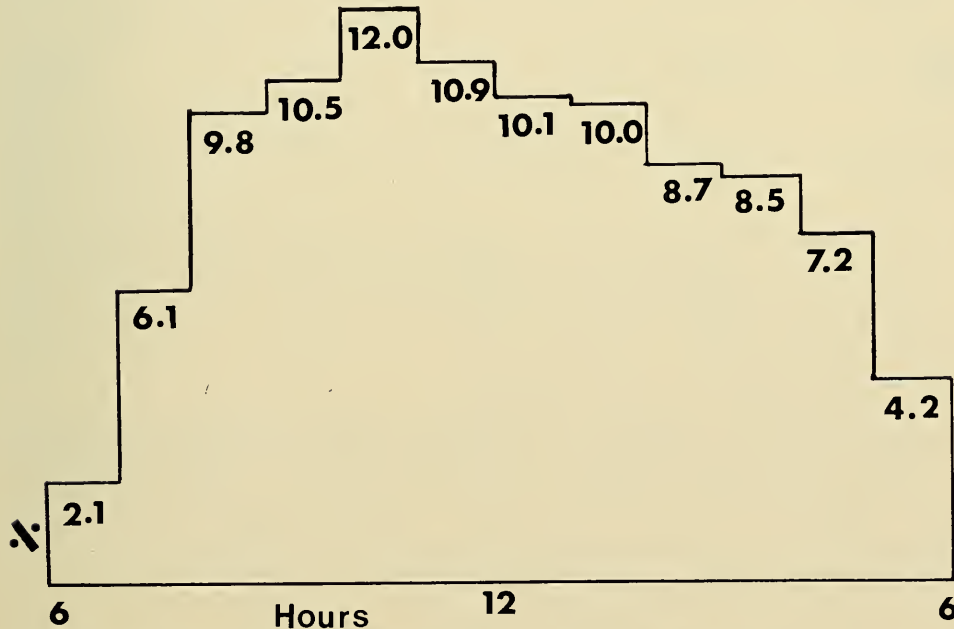

Fig. 5. Biting pattern of total anophelines (*A. farauti*) per cent per hour, 6 p.m.–6 a.m., for 1957–59 at Iaupolo, Fergusson Island.

*Legbiting catches.* The results of analysis of the catches and biting patterns is shown in Tables 2 and 10 and Fig. 5. The last six of the catches were made June–August 1959, by which time most of the Fergusson Island villages had been sprayed with dieldrin in the first round of the malaria eradication programme. Iaupolo was included with Bwalalea in the check area.

There was a slower build-up in the early part of the night than in Bwalalea or in the series for Goodenough Island. In no catch was the intensity of the

attack in the first hour of the catch greater than in succeeding hours, and in only two catches was the biting density in the first quarter of the night equal to that of the second quarter.

*Sporozoite rates* (see Table 7).

*Day indoor-resting* (see Table 3).

*Iamalele Village* (Fig. 1).

Results of catches and the biting pattern are shown in Tables 2 and 10 and in Fig. 6.

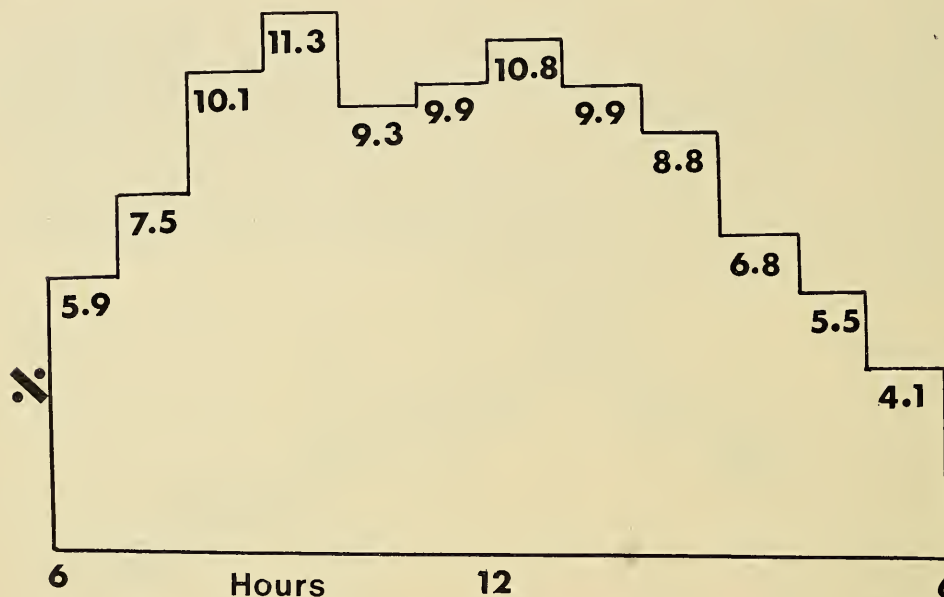

Fig. 6. Biting pattern of total anophelines (*A. farauti*) per cent per hour, 6 p.m.–6 a.m., for 1959 at Iamalele, Fergusson Island.

*Mapamoiwa Village* (Fig. 1 and Table 10)

Results from this village are included for comparison with the more typical situation of the other villages. The following adult postspray culicine species are recorded (Norris, 1971) from Mapamoiwa: *Uranotaenia civinskii*, *U. diagonalis* (also from Ibwaniu), *Aedes notoscriptus*, *Ae. scutellaris* (also from Awagova and Ibwaniu), *Armigeres milnensis* (also from Awagova), *Culex pullus*, *C. fraudatrix*. *Uranotaenia atra* was recorded from Ibwaniu, also *Aedes novalbitarsis*. Awagova and Ibwaniu are nearby hamlets located to the west of Mapamoiwa.

#### D'ENTRECASTEAUX ISLANDS

The distribution of outdoor biting densities is shown in Fig. 1. If more than one catch was made in a particular place, the figure given for that place is an averaged one.

In a total of 124 all-night legbiting catches, 33.9% showed biting densities of more than 100/man/night, 16.1% yielded 50–100 bites/man/night and 50% less than 50 bites/man/night, i.e. two-thirds of all catches were less than 100 bites/man/night, with an average of 30.8. The overall average figure was 79.3, or 74.8 bites/man/night, if the single exceptional catch of 635 is excluded. This figure is slightly higher than the original figure arrived at earlier of 65 bites/man/night (Spencer, 1965).

A combined analysis of *A. farauti* outdoor-biting figures from 106 catches (Table 10) showed that biting began at dusk in just over half the catches and was high in the first hour in half of these. Intensity of attack in the first quarter of the night was high (see Table 10) in over half the catches.

TABLE 10

*Detailed analysis of 106 Anopheles farauti all-night outdoor-biting catches in D'Entrecasteaux Islands to show prespray biting activity patterns*

Place ; total no. catches ; average no./catch	Percentage attacking premidnight	Period of greatest biting densities †	Intensity of attack in first hour of catch	Intensity of attack in first quarter of night
Iamalele ; 11 ; 85 (typical)	51·6	8 p.m.–3 a.m.	NT in 2 High* in 7	High* in 3
Iaupolo ; 15 ; 99 (typical)	46·5	9 p.m.–4 a.m.	NT in 9 High* in 4	High* in 6
Bwalalea ; 20 ; 99 (typical)	51·4	9 p.m.–2 a.m.	NT in 9 High* in 2	High* in 11
Mapamoiwa ; 13 ; 13 (atypical) (sited on porous soil)	63·5	9 p.m.–3 a.m.	NT in 11 High* in 0	High* in 4
Fergusson Island excluding above villages ; 15 ; 38 (varying conditions including atypical)	53·1	9 p.m.–3 a.m.	NT in 7 High* in 3	High* in 11
Goodenough Island 23 ; 70–155	46·7	No pattern at higher end of range	NT in 6 High* in 11	High* in 17
Normanby Island ; 10 ; 75	50·0	9 p.m.–3 a.m.	NT in 3 High* in 3	High* in 3

NT=none taken.

\* Relative intensity of attack in the first hour or first quarter of the night is high if the number taken equals more than half the number taken in the succeeding hours or in the succeeding quarters until 3 a.m.

† Biting began at dusk in 59 catches.

#### DISCUSSION

A review of field and laboratory observations enables us to elucidate basic behaviour patterns and to determine the gaps in our knowledge. For the purposes of discussion the two species of which we have the most knowledge, *A. farauti* and *A. punctulatus*, will be combined. The data was compiled before Bryan's (1973) work demonstrated the existence of two sibling species of *A. farauti*. In view of later data (Malaria Control Branch, Report No. 14) it is likely that our observations relate to *A. farauti* No. 1, with *A. farauti* No. 2, if present as a minority species.

Overall the two hours after dusk and the two hours before dawn are the times of least biting activity for *A. farauti*. Where attack rate is approximately 50 bites/man/night, the period of greatest biting density is 9 p.m.–2 (or 3) a.m. This is the typical coastal village situation for the greater part of the year.

More unusually, where the attack rate is 200–300 bites/man/night or more, no periods of higher biting density were discernible, heavy attack taking place all night long, as in Mackerras and Lemerle's (1949) laboratory colonies of *A. punctulatus*; in these colonies with a very high density of over 1,000 females per cage, flight activity began at twilight, feeding began at 7 p.m. and subsequently between 50 and 100 females fed every hour until daylight.

Field and laboratory observations suggest that mating occurs during the first night after emergence and movement takes place from the breeding site towards the bloodmeal source, but this has not been confirmed in the field. In laboratory colonies the majority of females blood-feed for the first time on the second night after emergence and require 72 hours for maturation of the first batch of eggs (Mackerras and Lemerle, 1949, *A. punctulatus*; Bryan, 1973, all species of the *A. punctulatus* complex). A few females seek a bloodmeal on the first night after emergence and oviposit on the fourth night, but the majority remain nulliparous for five days, ovipositing for the first time on the fifth night after emergence. The ovary of the nulliparous female is compact, with short, straight undilated pedicels, with coiled tracheole endings, and without granular residue.

Mackerras and Lemerle (1949) recorded that a feature of the breeding cycle in their laboratory colonies of *A. punctulatus* was the regularity with which the various processes occurred each day. Flight activity and adult emergence from the pupal state began at twilight. Mating took place at twilight and oviposition occurred early in the evening. These workers also recorded that the diurnal rhythm of activity appeared to be dependent upon daily fluctuations in temperature, humidity and light intensity. The same impression of regular repetitive activity comes through strongly also in the field, here interrupted by overriding climatic factors such as heavy rain and strong wind. In recent years Taylor (1972) has carried out laboratory investigations on the mechanisms controlling flight activity in *A. farauti*.

In the field, flight activity begins at or shortly after dusk, from 5.30–5.45 p.m. or a little later (Spencer, 1971*b*), and becomes a mass oviposition—and host-seeking flight as females leave their day resting places. If suitable breeding sites are close at hand and conditions of temperature, humidity, light intensity and reflection from water surfaces are favourable, the act of oviposition may be very rapidly completed, within 15 minutes after dusk falls (Spencer, 1971*b*). The oviposition flight may convert immediately to a host-seeking flight, sometimes before oviposition has been completed (one to many eggs may be retained, frequently lodged in the lower part of the common oviduct, and even the contents of an entire ovary may remain *in situ*). Such retained eggs are seen in 5–6% of parous individuals (Spencer, pers. obs.). Host-seeking flight brings waves of parous mosquitoes which have just laid eggs to join the night-biting and resting population (Spencer and Christian, 1969). The females rest near their hosts, outdoors or indoors, before and after feeding (Spencer, 1965).

During the rest period following the host-seeking flight, and at the time of biting, ovariole sacs and oviducts are in general still widely distended and the whole ovary is flaccid, indicating that only a short time period has elapsed since oviposition. Granular residue remains in the recently emptied follicles (Fig. 9) and the oocytes are at Christopher's Stage II. Tracheole endings have been irreversibly straightened (Detinova, 1962).

The actual taking of the uninterrupted bloodmeal occupies less than five minutes. Under average village conditions with average movements of people, 80% of total feeding takes place inside houses, 90% of anophelines entering houses take a full bloodmeal where no mosquito nets are used, 60% of entry as measured by house-resting is before midnight (Fig. 7), the time of greatest concentration of resting anophelines is between 10 p.m. and 2 a.m. (Table 5),

and more than 90% of house-entering anophelines leave again before dawn with a rapidly accelerating rate of departure after 4 a.m. (Fig. 8; Spencer, 1965). Thus few females remain within houses for 24 or 48 hours. In general time spent within houses is less than 12 hours and on any particular night, depending on movements of the people, 20% or more of the biting population will not enter houses at all. Males seldom accompany females into houses.

The biting pattern on any particular night depends upon the interaction of (1) climatic factors, (2) the individual times of oviposition which in turn depend upon varying response to stimuli, (3) the distances between breeding sites and source of bloodmeals, and (4) duration of the rest periods between oviposition flight, host-seeking flight and biting attack.

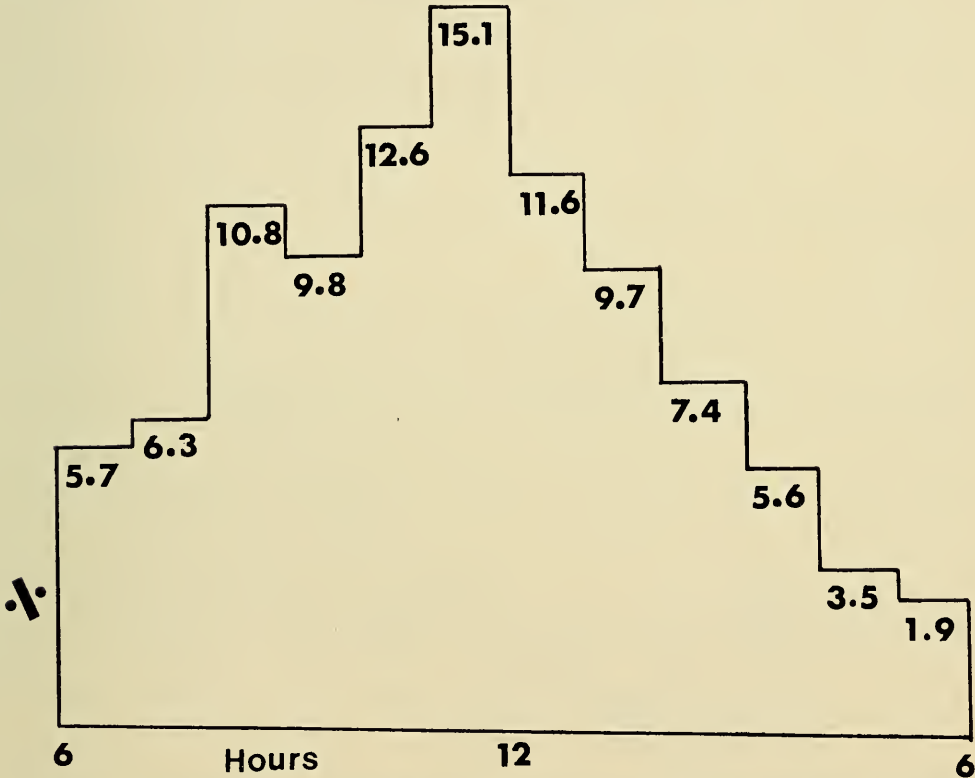

Fig. 7. Distribution of anophelines per hour night-resting in village houses on Fergusson Island, 6 p.m.—6 a.m., Total number=1,242.

Activity has ceased by dawn; the heavily laden blood-fed females have settled in their day resting places. Although normally found in the vicinity of villages, blood-fed females will rest near breeding sites under suitable conditions, e.g. if these and the source of blood and suitable resting places are all close together, as in a puddle with marginal shelter at the side of the track along with foot traffic passes at night.

Host-seeking flight and biting attack can occur in the field during the day. Mackerras and Lemerle (1949) record that day biting occurred if the anophelines had been starved of blood for at least 24 hours (presumably after full digestion of the previous bloodmeal and subsequent oviposition).

The constant outdoor association of males with females and renewal of males from the breeding sites ensures continuing fertility of the females that survive. In the laboratory colony maintained by Mackerras and Lemerle (1949) females tended to outlive males; there was little difference in survival for the first two weeks but thereafter females survived better than males. After the initial mating the *A. punctulatus* female can lay several batches of fertile eggs but her fertility will then diminish without further mating. In *A. farauti* if fertilisation does not occur the eggs will be retained (Roberts and O'Sullivan, 1948). Slooff (1964) has recorded that *A. farauti* and *A. koliensis* females kept

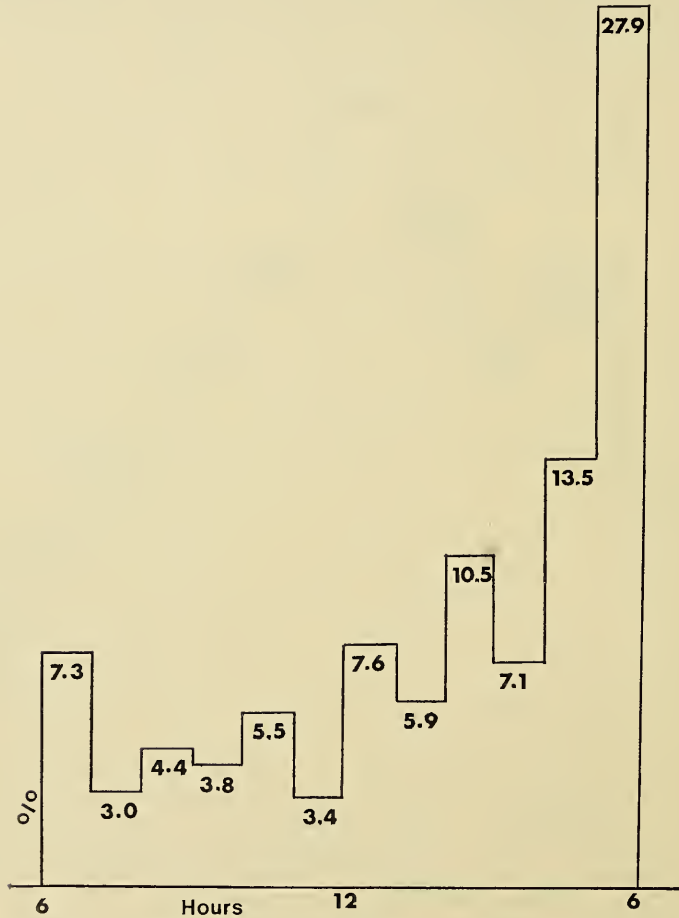

Fig. 8. Distribution of anophelines per hour entering exit-traps fixed to village houses at Bwalalea, Fergusson Island. Total number=858.

in the laboratory were able to lay fertile eggs 5–26 days after ingestion of a full bloodmeal. In the field this would mean a potential for immediate colonisation of surface waters, when rain falls after a dry spell, by females which have survived in sheltered situations. Nothing is known of the possibility of autogenous reproduction maintaining populations remote from dwellings during periods when no bloodmeals are available; Slooff (1964) has recorded huge populations of all three species in uninhabited valleys in West Irian.

By the time the blood-fed female leaves the vicinity of the host the next cycle of development of the oocytes has begun. Under coastal conditions Christophers' Stage III is reached during the day after the bloodmeal is taken. Christophers' Stage IV is reached by the late afternoon or evening after the bloodmeal and Stage V (the egg ready for oviposition) is matured during the second day. Shrinkage of the distended ovaries continues for 24 hours after oviposition, ovariole sacs being replaced by dilatations within 22–24 hours. The mature eggs are ready to be laid on the second night after the bloodmeal when again each mature follicle will be emptied and will become the upper part of an ovariole sac (Detinova, 1962). By deduction, under favourable conditions in the field the cycle will be regularly completed every 48 hours with the acts of oviposition and feeding for an individual female taking place every second night (agreeing with observations on laboratory colonies of *A. punctulatus*, Mackerras and Lemerle, 1949). At each oviposition, each ovariole sac has an increment added to it; both the total length of each sac and the quantity of retained granules progressively increase. Dilatations show up most clearly below degenerating follicles.

From the above information the following deductions may be made when wild-caught females are dissected :

- (1) If oocytes are at Christophers' Stage I the mosquito is newly emerged ;
- (2) Fully-gravid females found in diurnal resting places are at least five days old ;
- (3) An empty parous female that shows granular residue in her ovaries (Fig. 9) is at least six days old and has blood-fed at least once ;
- (4) The degree of distension of the ovary and its general flaccidity will indicate if oviposition has taken place shortly before dissection, and may indicate distances flown from breeding sites ;
- (5) If day-resting females are non-gravid, parous and unfed, it may indicate that the gonotrophic cycle is normally three days in length (it will be three days for that particular cycle) ;
- (6) If males resting with females are numerous, breeding is actively continuing and emergence is continuous ;
- (7) If males resting with females are scarce, the original breeding places may have disappeared or become unsuitable, and the population could be at least two weeks old.

The rhythm of feeding and oviposition under favourable conditions on the coast can be expected to correspond in general with Rhythm no. 1 of Garrett-Jones and Grab (1964). Individual differences in the times of completion of each gonotrophic cycle will depend more on the relative distances covered in oviposition and in host-seeking flights and on the lengths of rest periods than on the time period required for maturation of the eggs following a full bloodmeal. Optimal conditions will include a situation in which suitable diurnal resting places, source of bloodmeals and oviposition sites are located close together. Under such favourable conditions in a stable situation it can be expected that in the field as in the laboratory regularity will be a feature of the breeding cycle, and that biting and parity rates will be maintained at a relatively steady level with a relatively steady output from the breeding sites. Bwalalea, Iaupolo and Iamalele probably exemplify such situations.

Fluctuations in parity rates depend upon the interacting factors of mortality rates, stability of peridomestic breeding sites, any intermittent invasions from more remote breeding places, and regular completion of the gonotrophic cycle. Daily examination of variations in proportion parous enable determination of a

stable period of output and survival in that locality. If the length of the gonotrophic cycle is known and a stable value for proportion parous has been derived, the probability of survival ("p") (Macdonald, 1957) and the natural daily mortality ( $1-p$ ) can be read from Fig. 4 of Garrett-Jones and Grab (1964). Read from the graph these values for *A. farauti* are 0.87 and 13% (derived from figures from Spencer, 1965).

Mackerras and Lemerle (1949) recorded that the 50% survival period for adult *A. punctulatus* in the breeding cages was about 15 days. At a "p" value of 0.85, the theoretical 50% survival period in the field will be six days.

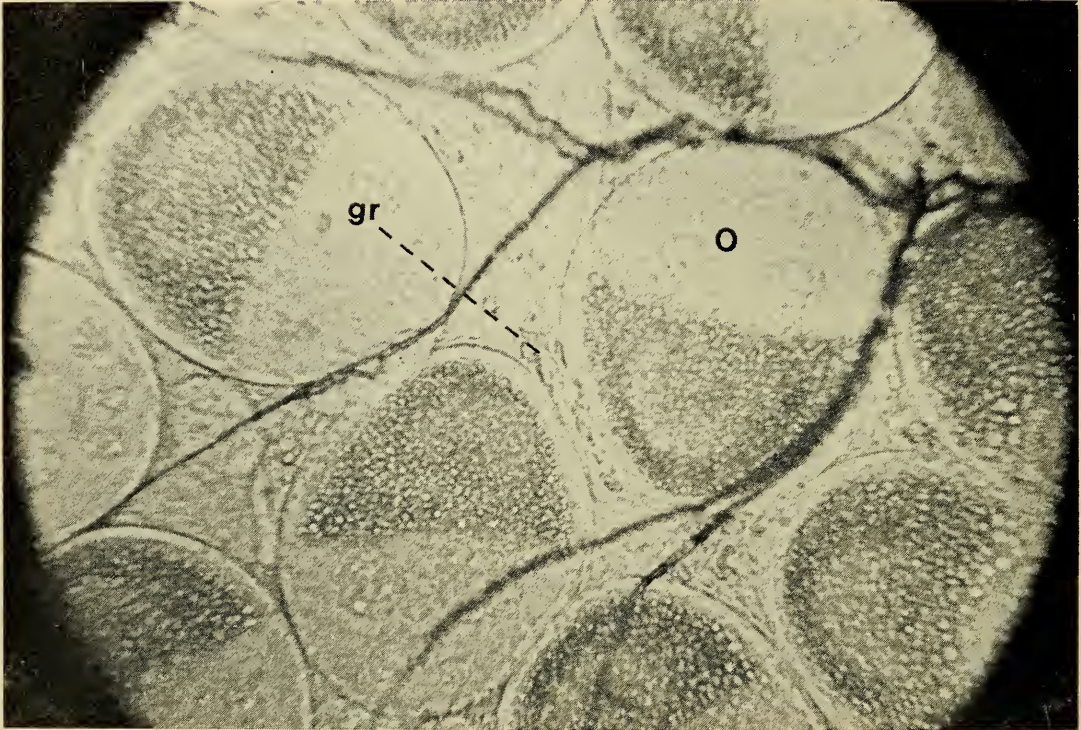

Fig. 9. Parous ovary of *A. farauti* showing granules (gr) and oocytes (o) at Christophers Stage II.

It has been calculated that a "p" value of 0.85 (a natural daily mortality of 15%) the expected number of ovipositions per emerging female will be 1.599, and the average number of eggs laid will be 240 (when the average egg batch is 150 eggs, the first oviposition occurs on the fifth day after emergence and oviposition occurs every two days subsequently (Cuellar, 1969).) If 200 fertile eggs per female are laid, the egg-adult survival rate needed to maintain the population will be only 10/1,000. In addition, 14% of females can be expected to survive to the twelfth night after emergence

If we now examine the data available for *A. farauti*, we find that Bryan (1973) obtained an average number of 129 eggs/batch in her laboratory colony of this species. Additionally, Mackerras and Lemerle (1949) have shown for *A. punctulatus* that the first egg batch consists of 30–100 eggs while subsequent



egg batches consisted of 200–250 eggs. In our series all females examined contained motile sperm in the spermatheca and were therefore presumably fully fertile. The overall proportion nulliparous at Bwalalea was 0·27, or 27 nulliparous females to every 73 parous females. The number of nulliparous females that would theoretically be expected to be present with 113 parous females would be 31, and the total theoretical population represented by the 113 parous females would be 144. From Table 5 it can be calculated that the total number of egg batches laid by that population was 239; the average number of egg batches laid by each female in this series would therefore be 1·66. If the average egg batch (on Bryan's figures) is 130 eggs, the average number of eggs laid will be 216. Thus the egg-adult survival rate needed to maintain this population will be low, of the order of 10/1,000, as above. The conclusion is reached that *A. farauti*, a species which normally breeds under stable conditions, is likely to have considerable resilience in its population dynamics, a conclusion supported by all field observations.

Table 5 shows that 9% of exit-trapped females had survived for 12 days or longer, if a regular gonotrophic cycle of two days in length is assumed. In a larger series of 900 *A. farauti* females (Spencer, 1974) 15·5% had survived in the wild state for 12 days or longer.

With any rate of egg-adult survival lower than 10/1,000, the population will decrease. Conversely, a rate of survival higher than 10/1,000, in a population with a natural daily mortality of 15%, will result in an increase in population numbers.

Factors which determine fertility, the length of the gonotrophic cycle, the survival rate and longevity, include (1) the aggregate quantity of water suitable for breeding in close proximity to a regularly-available and acceptable source of bloodmeals, such quantity being dependent upon rainfall distribution, the nature of the terrain and any manmade disturbance of the ecology, (2) climatic conditions suitable to adult survival and to regular repetition of behaviour patterns, and (3) the effect of parasites and predators.

The shortest possible distance which must be flown by the heavily-laden gravid female is the optimal one. If suitable water is available, the heaviest breeding will be concentrated within 5–275 m of the source of bloodmeals (Spencer, field observations, 1971*b*). The shorter the distance to be flown the less will be the adverse effects of such factors as the weather.

In *A. farauti* factors causing extension of the gonotrophic cycle beyond the expected 48 hours will include (1) weather conditions, e.g. heavy rain, high wind, preventing search for a bloodmeal and for an oviposition site and/or causing dispersal, (2) failure to find a bloodmeal when conditions are suitable e.g. absence or unavailability of suitable hosts due to mosquito nets or to distance from oviposition sites, or irritability due to some factor such as residual insecticide when a bloodmeal is sought indoors, and (3) failure to find an oviposition site when weather conditions are suitable, e.g. drying up of water bodies, overcast sky preventing reflections of light from water surfaces. Any extension of the gonotrophic cycle holds down breeding potential and population increase. If the cycle increases to three days a doubled survival rate egg/adult is necessary to maintain equilibrium (Cuellar, 1969).

If the natural daily mortality is increased three times to 45%, the survival rate for equilibrium must rise ten times to 100/1,000 eggs laid. While a survival rate of 900/1,000 eggs laid has been observed in the laboratory (Mackerras and Lemerle, 1949, for *A. punctulatus*) it is considered unlikely that this will be achieved in nature for any species of the *A. punctulatus* complex and that the practical limit of the egg survival rate lies in the 100–800/1,000 range and probably closer to the lower end. In practice the addition of an extra hazard in the form

of insecticidal attack by house-spraying often rapidly achieves dramatic falls in biting density. The conclusion is reached that by such insecticidal attack daily mortality is increased and longevity decreased to a point where a temporary near-extinction is achieved in particular places. Recovery follows by invasion, but densities should continue to be held down if spraying coverage is efficient, and if only one (house-entering) strain was present in the original population.

Widespread reductions in vector biting density following a spray round indicate good spraying coverage allied with localised breeding. Unusually high biting rates (over 200 bites/man/night) or violent fluctuations indicate instability due to a great increase in casual breeding (which may be due to manmade interference with terrain) or intermittent invasion from more remote breeding places which may be unaffected by any form of control. In the overall assessment of a situation it may be necessary to distinguish between localised breeding and output complicated by immigrant influxes but with minimal outdoor component and less localised, more diffuse breeding, with a greater outdoor-biting component.

#### ACKNOWLEDGEMENTS

Grateful acknowledgement is made to the field staff who carried out the collections under the direction of Mr. Jonathan Baloiioi, and to my husband and colleague, Dr. T. Spencer, who took the microphotograph of the ovary.

#### References

- ALLMAN, S. L. W., 1943.—Survey Vivigani-Bolu Bolu. Report No. 8. Australian Army Malaria Control Unit. (Typed manuscript made available by Professor Sir Edward Ford, School of Public Health and Tropical Medicine, University of Sydney.)
- BLACK, R. H., 1955.—Observations on the behaviour of *Anopheles farauti* Laveran, an important malaria vector in Papua New Guinea. *Med. J. Aust.*, : 949.
- BRYAN, J. H., 1973.—Studies on the *Anopheles punctulatus* complex. Parts 1-3. *Trans. R. Soc. Trop. Med. Hyg.*, 67 : 64, 70, 85.
- CUELLAR, C. B., 1969.—A theoretical model of the dynamics of an *Anopheles gambiae* population under challenge with eggs giving rise to sterile males. *WHO Bull.*, 40 : 205.
- DETNOVA, T. S., 1962.—*Age-grouping methods in Diptera of medical importance*. Geneva : World Health Organisation.
- GARRETT-JONES, C., and GRAB, B., 1964.—The assessment of insecticidal impact on the malaria mosquito's vectorial capacity from data on the proportion of parous females. *WHO Bull.*, 31 : 71.
- HART, T., 1944.—Survey No. 6. U.S. Malaria Survey Unit. (Typed manuscript made available by Professor Sir Edward Ford.)
- MACDONALD, G., 1957.—*Epidemiology and control of malaria*. London : Oxford University Press.
- MACKERRAS, M. J., and LEMERLE, T. H., 1949.—Laboratory breeding of *Anopheles punctulatus* Donitz. *Bull. Ent. Res.*, 40 : 27.
- MALARIA CONTROL BRANCH, 1974—Report No. 14. Port Moresby : Department of Health files, cyclostyled.
- NORRIS, D. P., 1971.—*List of mosquitoes from Milne Bay District*. Port Moresby : Department of Public Health, Malaria Service files.
- ROBERTS, F. H. S., and O'SULLIVAN, P. F., 1948.—Studies on the behaviour of adult Australasian anophelines. *Bull. Ent. Res.*, 39 : 159.
- SLOOFF, R., 1964.—Observations on the effect of residual DDT house-spraying on behaviour and mortality in species of the *Anopheles punctulatus* group. Thesis for doctorate, University of Leiden.
- SPENCER, M., 1960.—Anopheline species distribution list for the D'Entrecasteaux Islands, Papua. *P.N.G. Med. J.*, 4 : 55.
- , 1964.—Blood preferences of *A. Farauti*. *P.N.G. Med. J.*, 7 : 19.
- , 1965.—Malaria in the D'Entrecasteaux Islands, Papua, with particular reference to *Anopheles farauti* Laveran. *PROC. LINN. SOC. N.S.W.*, 90 : 115.
- , 1969.—Sporozoite rate in *Anopheles farauti* Laveran related to types of catch and seasonal conditions. *PROC. LINN. SOC. N.S.W.*, 94 : 100.
- , 1970.—Density and longevity of *Anopheles farauti* Laveran. *P.N.G. Med. J.*, 13 : 84.

- , 1971*a*.—Bionomics of vector anophelines in Papuan Islands. *P.N.G. Med. J.*, 14 : 14
- , 1971*b*.—*An anopheline mosquito survey of the Bougainville Copper Project area*. Port Moresby : Department of Public Health, Malaria Service files, unpublished report.
- , 1976.—*Age-grouping of anopheline female populations with particular reference to Anopheles farauti No. 1 Laveran revised by Bryan 1973 (Diptera : Culicidae) in Papua New Guinea*. *WHO Mal.*, 76 : 865.
- , and CHRISTIAN, S. H., 1969.—Cyclic ovariole changes in *Anopheles farauti* Laveran (Diptera : Culicidae) in Papua New Guinea. *J. Aust. Ent. Soc.*, 8 : 16.
- SPENCER, T., SPENCER, M., and VENTERS, D., 1974.—Malaria vectors in Papua New Guinea. *P.N.G. Med. J.*, 17 : 22.
- STRONG, J. H., 1943.—Present problems of malaria control on Goodenough Island. Report No. 1, Malaria Control Unit, R.A.A.F., Ref. 1801/1/MED. (Typed manuscript made available by Professor Sir Edward Ford.)
- SWAN, G., 1943.—Survey No. 9, Operations Group, R.A.A.F., Ref. 1805/1A/MED. (Typed manuscript made available by Professor Sir Edward Ford.)
- SWEENEY, A. W., 1968.—Variations in density of *Anopheles farauti* Laveran in the Carterets Islands. *P.N.G. Med. J.*, 11 : 11.
- TAYLOR, B., 1969.—Geographical range and circadian rhythms. *Nature*, 222 : 296.
- WARD, R. G., and LEA, D. A. M., 1970.—*An atlas of Papua New Guinea*. Boroko : University of Papua New Guinea Department of Geography.



Copies of the PROCEEDINGS OF THE LINNEAN SOCIETY OF NEW SOUTH WALES (with the exception of a few volumes and Parts) may be purchased from the Society, Science Centre, 35-43 Clarence Street, Sydney, N.S.W., 2000.

Current charges for the PROCEEDINGS are :

Volumes—\$16.00 each for 1st Series (Volumes 1-10) ; \$11.00 each for 2nd Series (Volumes 11-20) and all subsequent volumes.

Parts—\$5.00 each for all back parts ; \$4.00 each for current Parts. For volumes of 5 or 6 Parts, \$1.00 each for first and last Parts.

Prices do not include postage.

Subscription to the PROCEEDINGS—\$20.00 per volume, plus \$2.50 postage—\$22.50.

All prices are in Australian currency.

These charges may be revised from time to time, and inquiries should be addressed to The Secretary, Linnean Society of New South Wales, Science Centre, 35-43 Clarence Street, Sydney, N.S.W., 2000, Australia.

The Society's PROCEEDINGS are printed and published for the Society by the Australasian Medical Publishing Co., Ltd., 71-79 Arundel Street, Glebe, N.S.W., 2037.

# Proceedings, Volume 101, Part 2, 1977

## CONTENTS

	Page
LUIG, N. H., and WATSON, I. A. The role of barley, rye and grasses in the 1973-74 wheat stem rust epiphytotic in southern and eastern Australia .. .. .	65
RETALLACK, G., GOULD, R. E., and RUNNEGAR, B. Isotopic dating of a middle triassic megafossil flora from near Nymboida, northeastern New South Wales .. .. .	77
SHORT, J. R. T. A description and classification of some final-instar larvae of the Phytodietini and Eclytini (Hymenoptera, Ichneumonidae, Tryphoninae) .. .. .	114
SPENCER, M. Bionomics and behaviour patterns of the <i>Anopheles Punctulatus</i> complex (Diptera : Culicidae) in the D'entrecasteaux Islands, Papua	120

# Proceedings of the Linnean Society of New South Wales

LIBRARY

JUN 22 1977

Woods Hole, Mass.

Issued 6th April, 1977

0

VOLUME 101

PART 3

No. 447

# The Linnean Society of New South Wales

Founded 1874. Incorporated 1884

“ For the cultivation and study of the science of Natural History  
in all its branches ”

## OFFICERS AND COUNCIL, 1976-77

### *President*

Barbara G. Briggs, Ph.D.

### *Vice-Presidents*

H. G. Cogger, M.Sc., Ph.D. ; D. W. Edwards, B.Sc.Agr. ;  
P. J. Stanbury, Ph.D. ; T. G. Vallance, B.Sc., Ph.D.

### *Honorary Treasurer*

Joyce W. Vickery, M.B.E., D.Sc., F.L.S.

### *Secretary*

Ruth J. Inall

### *Council*

Barbara G. Briggs, Ph.D.	F. W. E. Rowe, B.Sc., Ph.D., M.I.Biol., F.L.S.
H. G. Cogger, M.Sc., Ph.D.	P. J. Stanbury, Ph.D.
D. W. Edwards, B.Sc.Agr.	N. G. Stephenson, M.Sc., Ph.D.
L. A. S. Johnson, D.Sc.	T. G. Vallance, B.Sc., Ph.D.
D. McAlpine, M.Sc., Ph.D.	Joyce W. Vickery, M.B.E., D.Sc., F.L.S.
Helene A. Martin, Ph.D.	J. T. Waterhouse, B.Sc., M.Sc. (N.S.W.), M.Sc. (R'ding), F.L.S.
Lynette A. Moffat, B.Sc., Ph.D.	B. D. Webby, M.Sc., Ph.D.
P. Myerscough, M.A., D. Phil.	A. J. T. Wright, B.Sc., Ph.D.
J. Pickard, B.Sc.Agr.	
A. Ritchie, B.Sc., Ph.D.	

### *Auditors*

W. Sinclair and Company, Chartered Accountants

*Linnean Macleay Lecturer in Microbiology, University of Sydney*

K. Y. Cho, Ph.D.

### *Librarian*

Constance B. McKay, B.A., A.L.A.A.

### *Executive Editor*

Janet Donald, B.A., Dip.Lib.

The Society's Headquarters are in Science Centre, 35-43 Clarence Street, Sydney,  
N.S.W. 2000, Australia



A NEW SPECIES OF SCORPAENID FISH (SCORPAENIDAE)  
FROM WESTERN AUSTRALIA

GERALD R. ALLEN\*

Plate I

[Accepted for publication 21st April 1976]

*Synopsis*

A new species of scorpaenid fish, *Scorpaenodes steenei*, is described from three specimens collected at Rottneest Island, near Perth, Western Australia. It appears to be most closely related to *S. parvipinnis* from the tropical Indo-West Pacific and is separable from that species on the basis of a higher soft dorsal ray count, fewer spines on the suborbital ridge and a taller dorsal fin.

INTRODUCTION

Compared with the eastern coast of Australia the fishes of Western Australia are poorly documented. Whitley (1948) listed 740 species from the State and since then various authors have added about 200 more. During 1974-75 the author, with the aid of Mr. J. B. Hutchins, made extensive collections at various localities along the western coast. The known fish fauna of Western Australia now stands at approximately 1,500 species and additional discoveries are being made at a rapid rate. This paper describes a new scorpionfish which was taken during 1974-75 off Rottneest Island, which lies about 20 km directly offshore from the Fremantle-Perth district. It represents the first record for the genus *Scorpaenodes* in the temperate region of Western Australia.

Measurements were made with needle-point dial calipers to the nearest one-tenth millimetre. The fraction  $\frac{1}{2}$  which appears in the dorsal fin ray counts refers to a bifurcate condition of the last ray. Terminology of head spines is based on Eschmeyer (1969) and Smith (1957).

Type specimens have been deposited at the following institutions: Australian Museum, Sydney (AMS); United States National Museum of Natural History, Washington, D.C. (USNM); Western Australian Museum, Perth (WAM).

DESCRIPTION

*Scorpaenodes steenei*, n.sp.

(Plate 1)

*Holotype*. WAM P25178-006, 93.0 mm SL, collected with rotenone off northeast side of Rottneest Island, Western Australia, in 6 m by B. Hutchins on 6 March 1975.

*Paratypes*. AMS I.18461-001, 99.8 mm SL, collected with rotenone off west end of Rottneest Island, Western Australia, in 20 m by G. Allen and R. Steene on 29 November 1974; USNM 214679, 97.2 mm SL, same data as preceding specimen.

*Diagnosis*. A species of *Scorpaenodes* with the following combination of characters: vertical scale rows above lateral-line from upper edge of gill opening to base of caudal fin 47-48; horizontal scale rows between lateral-line and base of fourth dorsal spine 6-7; suborbital ridge with 5-8 spines; coronal ridge with apical spines; soft dorsal rays  $10\frac{1}{2}$ .

---

\* Western Australian Museum, Francis Street, Perth, Western Australia, 6000.

---

*Description.* The proportional measurements of the holotype and paratypes are expressed as percentage of the SL in Table 1.

Dorsal rays XIII,  $10\frac{1}{2}$ ; anal rays III, 5; pectoral rays 17; gill rakers on first arch 15-17 (including rudiments); vertical scale rows above lateral-line from upper edge of gill opening to base of caudal fin 47-48; horizontal scale rows from lateral-line to base of fourth dorsal spine 6-7; from lateral-line to anus 12-13.

Body moderately compressed, snout pointed. Depth of body 2.8 (2.6 to 2.7), head length 2.2 (2.3 to 2.4), both in standard length. Snout 3.8 (4.1 to 4.3), eye diameter 3.7 (3.2 to 3.4), interorbital width 6.8 (6.1 to 6.5), length of maxillary 2.4, least depth of caudal peduncle 3.9 (3.7 to 4.1), length of caudal peduncle 4.9 (4.1 to 4.4), of pectoral fin 1.5 (1.4), of pelvic fin 1.7 (1.5 to 1.7), of first dorsal spine 8.3 (6.7 to 6.9), of fifth dorsal spine 3.5 (3.1

TABLE 1  
*Measurements of the type specimens of Scorpaenodes steenei*  
(expressed in thousandths of the standard length)

Characters	Holotype	Paratypes	
	WAM P25178-006	USNM 214679	AMS I.18461-001
Standard length (mm)	93.0	97.2	99.8
Greatest body depth	360	388	366
Head length	445	412	431
Snout length	118	96	105
Eye diameter	120	128	125
Interorbital width	66	64	70
Maxillary length	183	175	180
Caudal peduncle least depth	115	111	105
Caudal peduncle length	91	101	98
Snout to dorsal fin origin	404	412	368
Snout to anal fin origin	753	736	792
Snout to pelvic fin origin	430	375	476
Length dorsal fin base	583	602	574
Length anal fin base	157	154	145
Length pectoral fin	306	288	308
Length pelvic fin	269	275	258
Length 1st dorsal spine	54	62	62
Length 5th dorsal spine	129	132	136
Length penultimate dorsal spine	60	62	69
Longest soft dorsal ray	161	159	167
Length 1st anal spine	98	93	98
Length 2nd anal spine	196	188	193
Length 3rd anal spine	159	144	145
Longest soft anal ray	204	211	215
Length caudal fin	271	247	240

to 3.2), of penultimate dorsal spine 7.4 (6.2 to 6.7), of longest soft dorsal ray 2.8 (2.6), of first anal spine 4.5 (4.4), of second anal spine 2.3 (2.2), of third anal spine 2.8 (2.9 to 3.0), of longest soft anal ray 2.2 (2.0), of caudal fin 1.6 (1.7 to 1.8), all in the head length.

Pair of relatively large nasal openings on each side of snout, anterior opening with elevated rim and dermal flap posteriorly; mouth large and oblique, terminally located; lateral-line gradually descending on sides from upper corner of gill opening to base of middle caudal rays; lips, chin, dentary, and isthmus naked; remainder of head and body covered with ctenoid scales; sheath scales covering base of soft dorsal, anal, and caudal fins, and about basal  $\frac{1}{3}$  of pectoral fin; suborbital ridge with 5-8 spines; secondary row of 3-4 spines below

suborbital ridge; preopercular bone with 6 spines on posterior margin; coronal or interorbital ridge present with spine posteriorly; other spines present include nasal, pre-, supra-, and postocular, anterior and posterior parietal, upper and lower posttemporal, opercular, postfrontal, tympanic, pterotic, sphenotic and cleithral; jaws with bands of small granular teeth; vomer with similar teeth; palatines toothless.

Colour of holotype in ethyl alcohol: ground colour of head and body pale (yellowish); head with diagonal blackish bar from postero-ventral corner of eye to lower edge of preopercle; short blackish bar below middle of eye to lower edge of suborbital; prominent blackish spot, larger than pupil, on middle of opercle; blackish bar across occipital region connecting postero-dorsal corner of each orbit; dusky blotches on nape and sides below dorsal spines 1-8; prominent blackish spot, smaller than pupil, slightly anterior to and above cleithral spine; three irregular transverse bars on sides below soft dorsal and last few dorsal spines, dusky grey in colour and interconnected horizontally above lateral-line; spinous dorsal fin dusky with series of oblique pale bands; soft dorsal and anal fins similar to spinous dorsal on basal portion, but outer half mostly translucent except distal part of last three rays dusky; pelvics, pectorals, and caudal fin mostly pale yellowish to translucent; pectoral and caudal fins with faint dusky bar at base.

The paratypes are similar in coloration except they exhibit 3-4 faint grey crossbands on the caudal fin and an additional bar on the middle of the caudal peduncle which is connected horizontally with the bar at the caudal base.

Colour of 97.2 mm paratype in life (from ektachrome slide taken by R. Steene): ground colour of head and body pink with blackish markings on head as described above; snout and lips red; bars and blotches on body dusky grey suffused with reddish; bars on caudal peduncle reddish; base of dorsal fin mostly red; anal fin with oblique alternating bands of red and white; caudal fin with series of narrow reddish crossbands; lower half of pectoral fin red with narrow white crossbands, upper part of fin pink with white bands less apparent.

*Remarks.* The genus *Scorpaenodes* contains about 12 species, most of which are confined to the tropical Indo-West Pacific. *Scorpaenodes steenei* appears to be most closely related to *S. parvipinnis* (Garrett, 1863), a species which is widely distributed in this vast region. These two differ from most other *Scorpaenodes* by a combination of characters which include more than 45 series of scales above the lateral-line, a well developed interorbital ridge and associated apical spine, a row of secondary spines below the suborbital ridge, and a slightly higher soft dorsal ray count ( $9\frac{1}{2}$ - $10\frac{1}{2}$  v.  $8\frac{1}{2}$ ). *Scorpaenodes steenei* is separable from *S. parvipinnis* in several important respects including a higher soft dorsal count ( $10\frac{1}{2}$  v.  $9\frac{1}{2}$ ), fewer suborbital ridge spines (5-8 v. 12-15), and a taller spinous dorsal fin (longest spine 3.1 to 3.5 in head length v. 4.2 to 4.5 for *S. parvipinnis*). Two specimens of *S. parvipinnis*, 48.5 and 72.0 mm SL, from the Solomon Islands were examined.

*Etymology.* This species is named in honour of Mr. Roger Steene of Cairns, Queensland, who helped the author in procuring the first known specimens (paratypes) and also provided a colour photograph. In addition, Mr. Steene kindly assisted the author at his own expense on a trip to the Dampier Archipelago during October-November 1974.

#### ACKNOWLEDGEMENTS

I am indebted to Mr. John Braun who provided his boat and diving equipment for trips to Rottneest Island. I also thank my wife, Connie, for her care in the preparation of the typescript.

*References*

- ESCHMEYER, W. N., 1969.—A systematic review of the scorpionfishes of the Atlantic Ocean (Pisces : Scorpaenidae). *Occas. Pap. Calif. Acad. Sci.*, 79 : 1-130.
- GARRETT, A., 1863.—Descriptions of new species of fishes. *Proc. Calif. Acad. Sci.*, 3 : 63-66 and 103-107.
- SMITH, J. L. B., 1957.—The fishes of the family Scorpaenidae in the western Indian Ocean. *Ichthyol. Bull. Rhodes Univ.*, 4 : 1-28.
- WHITLEY, G. P., 1948.—A list of the fishes of Western Australia. *W. A. Fish. Dep. Bull.*, 2 : 1-35.

## PLATE I

*Scorpaenodes steenei*, holotype, 93·0 mm SL, Rottnest Island, Western Australia.





IMMATURE STAGES OF THREE MITE SPECIES (ACARI :  
PHYTOSEIIDAE) FROM APPLE IN AUSTRALIA

E. SCHICHA\*

[Accepted for publication 21st April 1976]

*Synopsis*

The immature stages of the phytoseiid mites *Typhlodromus* (*T.*) *helenae*, *Amblyseius* (*A.*) *lentiginosus*, and *Phytoseius fotheringhamiae* are described and figured.

INTRODUCTION

Material for this study was obtained from Granny Smith apple trees at Bathurst, New South Wales, Australia.

The setal nomenclature is that used by Chant (1958) for idiosoma and venter, and by Evans (1963) for the legs. Measurements are the range of three specimens in micrometres.

*Typhlodromus* (*T.*) *helenae* Schicha and Dosse, 1974

Figs 1-20

LARVA (Figs 1-6)

*Dorsum.* Smooth idiosoma 159-167 long, 109-116 wide at L4. Ten pairs of smooth setae, four dorsal, one median, four prolateral, one caudolateral: D1, 18-22 long; D2, 6-8; D3, 5-6; D4, 16-17; M1, 5-7; L1, 6-8; L2, 9-11; L3, 11-12; L4, 32-35; L9, 96-105. L9 slightly knobbed. All setae shorter than distances between their bases and bases of setae following next in series. One pair of small pores and a pair of large pores between L4 and L9. No stigmata or peritremes.

*Venter.* Three pairs of sternal setae and three long para-anal setae present. Posterior para-anal seta approximately one third shorter than lateral para-anal setae. Two pairs of preanal setae, posterior pair twice as long as anterior. Two pairs of lateroventral setae short. Sexes indistinguishable.

*Chelicera.* Both digits 13-14 long. Fixed digit with one blunt subapical tooth and pilus dentilis; movable digit without teeth on margin.

*Legs.* Legs with following chaetotaxy: coxae, 2,2,2; trochanter I, II and III, 1-0/1-0/1-1; femur I, 2-2/1-2/2-1; femur II, 1-2/1-2/0-1; femur III, 1-2/1-1/0-0; genu I, 1-2/1-2/1-1; genu II and III, 1-2/0-2/0-1; tibia I, 1-2/1-2/1-1; tibia II and III, 1-1/1-2/1-1.

PROTONYMPH (Figs 7-13)

*Dorsum.* Smooth idiosoma 205-213 long, 147-153 wide at L4. Sixteen pairs of setae, six dorsal, two median, eight lateral: D1, 17-19 long; D2, 9-12; D3, 9-11; D4, 13-14; D5, 11-12; D6, 4-6; M1, 9-11; M2, 36-38; L1, 13-15; L2, 11-12; L3, missing; L4, 11-13; L5, 16-17; L6, 16-17; L7, 21-22; L8, 18-19. M2 and L9 serrated; all other setae smooth. All setae shorter than distances between their bases and bases of setae following next in series. Two pairs of pores as figured. S1, 14-15, and S2, 12-14, on inter-scutal membrane. Peritremes 32-37 long.

---

\* Biological and Chemical Research Institute, New South Wales Department of Agriculture Rydalmere, New South Wales, 2116.

*Venter.* Sternal area with three pairs of setae. Anal shield with three short para-anal setae of equal length. Two pairs of preanal setae, one pair of latero-ventral setae, and one pair of large caudal setae present. Sexes indistinguishable.

*Chelicera.* Fixed digit 14–17 long, with four teeth on distal half and pilus dentilis; movable digit 16–18 long, with one tooth on inner margin.

*Legs.* Chaetotaxy of first three legs resembles that of larva. Leg IV: coxa with one anteroventral seta; trochanter, 1-0/1-0/1-1; femur, 1-1/0-1/0-1; genu, 1-2/0-2/0-0; tibia, 1-1/1-2/0-1; macroseta on basitarsus 37–40 long.

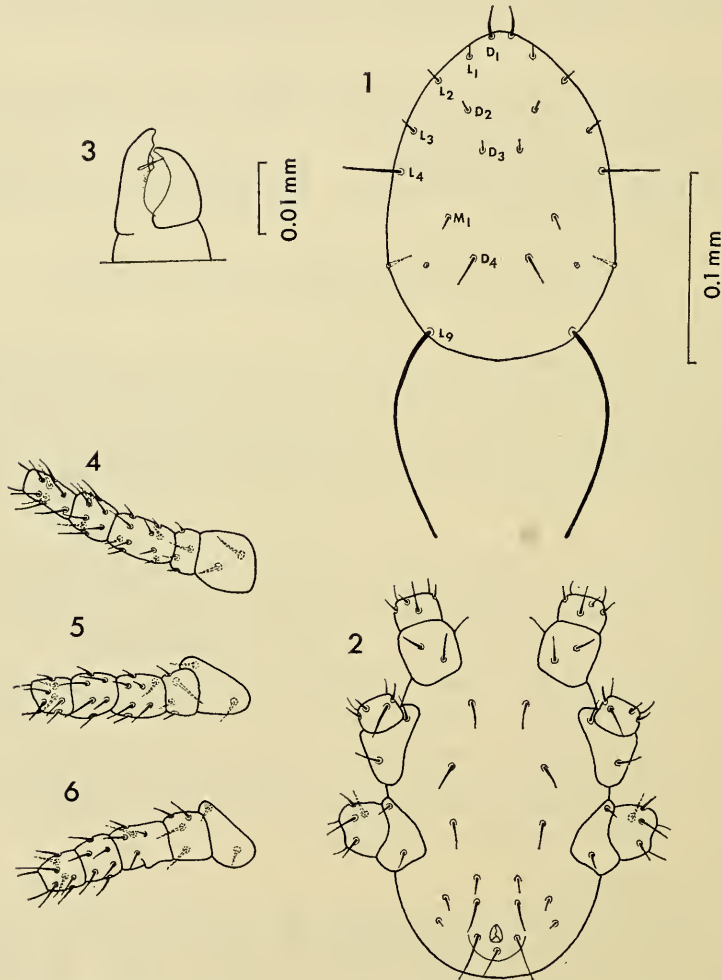

Figs 1–6. *Typhlodromus (T.) helenae* larva. 1. Dorsal shield. 2. Venter. 3. Chelicera. 4. Leg I dorsal. 5. Leg II dorsal. 6. Leg III dorsal.

#### DEUTONYMPH (Figs 14–20)

##### *Female*

*Dorsum.* Imbricated idiosoma 263–265 long, 120–122 wide at L4, with 17 pairs of setae, six dorsal, two median, nine lateral: D1, 20–21 long; D2 and D3, 10–12; D4 and D5, 13–15; D6, 7–8; M1, 11–14; M2, 29–31; L1, 17–18;



L2 and L3, 12–14; L4, 14–15; L5, 17–18; L6, 20–22; L7, 22–24; L8, 23–25; L9, 40–41. L9 serrated, M2 sometimes slightly serrated; all other setae smooth. L1 as long as distance between its base and base of L2; L2 as long as distance between its base and base of L3. All other setae shorter than distances between their bases and bases of setae following next in series. Three pairs of large pores and three pairs of small pores as figured. S1 and S2, 17–18 long, on interscutal membrane. Peritremes 123–145 long.

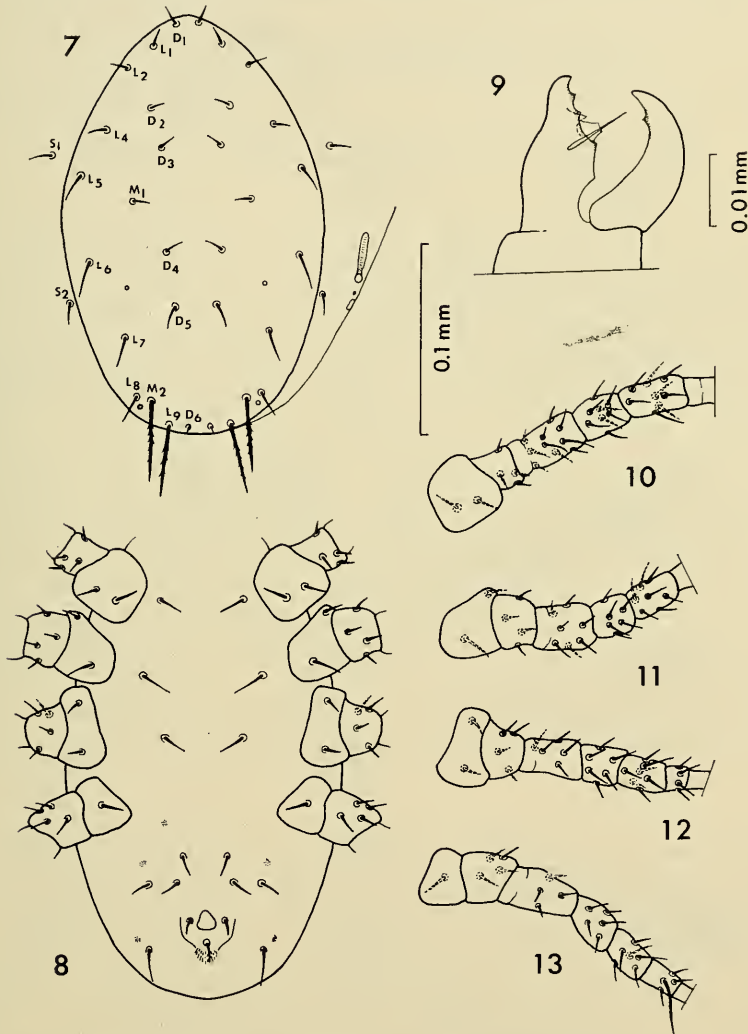

Figs 7–13. *Typhlodromus (T.) helenae* protonymph. 7. Dorsal shield. 8. Venter. 9. Chelicera. 10. Leg I dorsal. 11. Leg II dorsal. 12. Leg III dorsal. 13. Leg IV dorsal.

**Venter.** Sternal area with five pairs of setae. Anal shield with three subequal para-anal setae and surrounded by eight pairs of setae (four preanal, two lateroventral, one posteroventral, and one caudal).

**Chelicera.** Fixed digit 19–21 long, with four teeth on distal half and pilus dentilis; movable digit 18–20 long, with one tooth on inner margin.

*Legs.* Coxae, 2,2,2,1; trochanter I and II, 1-0/1-0/2-1; trochanter III, 1-1/1-0/2-0; trochanter IV, 1-1/1-0/2-0; femur I, 2-3/1-2/2-2 (XII-type); femur II, 2-3/1-2/1-1 (X-type); femur III, 1-2/1-1/0-1 (VI-type); femur IV, 1-2/1-1/0-1 (VI-type); genu I, 2-2/1-2/1-2 (X-type); genu II, 2-2/0-2/0-1 (VII-type); genu III and IV, 1-2/1-2/0-1 (VII-type); tibia I, 2-2/1-2/1-2 (X-type); tibia II, 1-2/1-1/1-1 (VII-type); tibia III, 1-1/1-2/1-1 (VII-type); tibia IV, 1-1/1-2/0-1 (VI-type); basitarsus IV with one macroseta, 48-49 long.

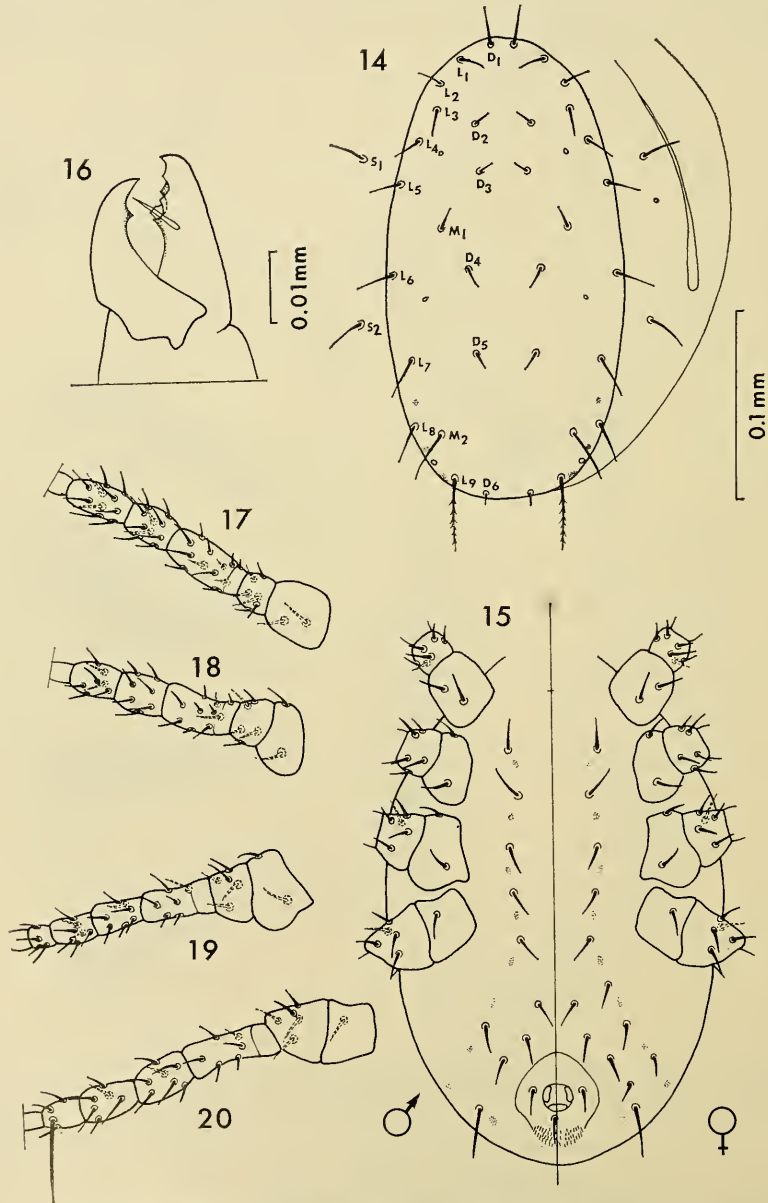

Figs 14-20. *Typhlodromus (T.) helenae* deutonymph. 14. Dorsal shield. 15. Venter of male and female. 16. Chelicera. 17. Leg I dorsal. 18. Leg II dorsal. 19. Leg III dorsal. 20. Leg IV dorsal.

*Male*

*Dorsum.* Idiosoma 231–243 long, 107–110 wide at L4; chaetotaxy resembles that of female deutonymph, but setae shorter: D1, 16–17; D2 and D3, 9–11; D4 and D5, 11–13; D6, 4–7; L1 and L4, 13–15; L2, 12–13; L3 and M1, 9–10; L5 and L6, 14–16; L7, 18–21; L8, 20–21; L9, 34–38; M2, 26–28. Setae S1 and S2, 14–16 long, on interscutal membrane.

*Venter.* Similar to female deutonymph, but differs in absence of three pairs of setae around anal shield.

*Chelicera.* Resembles that of female deutonymph, 19–20 long.

*Legs.* Chaetotaxy resembles that of female deutonymph; macroseta on basitarsus IV only 34–39 long.

*Amblyseius (A.) lentiginosus* Denmark and Schicha, 1974a

Figs 21–40

## LARVA (Figs 21–26)

*Dorsum.* Smooth idiosoma 187–193 long, 130–136 wide at L4. Ten pairs of smooth setae, four dorsal, one median, four prolateral, one caudolateral: D 1, 29–32 long; D2, 3–5; D3, 2–3; D4, 10–11; M1, 3–5; L1, 22–26; L2, 3–5; L3, 4–6; L4, 75–78; L9, 159–173. D2, L2 and M1 equal in length; L1 longer than distance between its base and base of L2. All other setae shorter than distances between their bases and bases of setae following next in series. One pair of large pores and three pairs of small pores as figured. No stigmata or peritremes.

*Venter.* Sternal area with three pairs of setae. Two lateral para-anal setae approximately twice as long as posterior para-anal seta. Two pairs of preanal setae, one pair of lateroventral setae, and two pairs of posteroventral setae all shorter than sternal setae. Posterior to posteroventral setae a pair of small pores. Preanal pores 17–18 apart. Sexes indistinguishable.

*Chelicera.* Both digits 16–18 long. Fixed digit with four teeth on distal half, three teeth on proximal half, and pilus dentilis; movable digit with two teeth on inner margin.

*Legs.* With same chaetotaxy as that of *T. (T.) helenae* larva, but with four macrosetae: on genu I, 34–35 long; on genu II, 48–49; on genu III, 70–72; on tibia III, 75–77.

## PROTONYMPH (Figs 27–33)

*Dorsum.* Smooth idiosoma 231–234 long, 121–124 wide at L4. Seventeen pairs of smooth setae, six dorsal, two median, nine lateral: D1, 21–23 long; D2, 1–3; D3, 1–3; D4, 4–5; D5, 6–7; D6, 7–9; M1, 2–4; M2, 104–108; L1, 36–43; L2 and L3, 3–5; L4, 58–63; L5, 7–8; L6, 5–6; L7 and L8, 3–5; L9, 61–65. L1 longer than distance between its base and base of L2; L4 approximately as long as distance between its base and base of L5. All other setae shorter than distances between their bases and bases of setae following next in series. One pair of large pores and five pairs of small pores as figured. S1, 12–14, and S2, 2–4, on interscutal membrane. Peritremes 52–58 long.

*Venter.* Sternal area with three pairs of setae; anal shield with three subequal para-anal setae. Two pairs of preanal setae, one pair of lateroventral setae, and one pair of large caudal setae. Posterior to caudal setae a pair of small pores. Preanal pores 21–22 apart. Sexes indistinguishable.

*Chelicera.* Fixed digit 21–22 long, with four teeth on distal half, three teeth on proximal half, and pilus dentilis. Movable digit 24–26 long, with two teeth on inner margin.

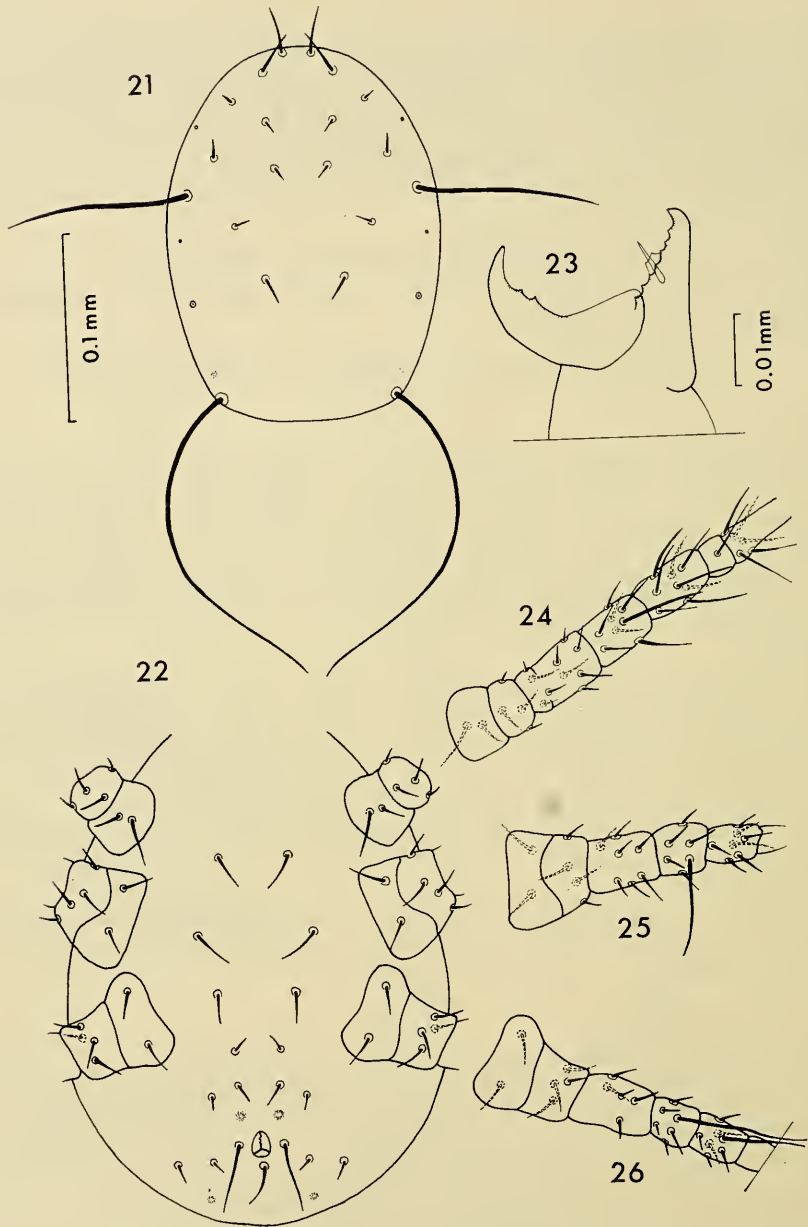

Figs 21-26. *Amblyseius (A.) lentiginosus* larva. 21. Dorsal shield. 22. Venter. 23. Chelicera. 24. Leg I dorsal. 25. Leg II dorsal. 26. Leg III dorsal.

*Legs.* Chaetotaxy of first three legs resembles that of larva. Chaetotaxy of leg IV like that of *T. (T.) helenae* protonymph but with eight macrosetae: on genu I, 28-32; on basitarsus I, 37-42; on genu II, 34-38; on genu III, 56-60; on tibia III, 53-57; on genu IV, 79-83; on tibia IV, 90-93; on basitarsus IV, 90-95.

## DEUTONYMPH (Figs 34-40)

*Female*

*Dorsum.* Smooth idiosoma 288-294 long, 147-153 wide at L4, with 17 pairs of setae, six dorsal, two median, nine lateral: D1, 29-32 long; D2, and D3, 3-5; D4, and D5, 4-6; D6, 9-12; M1, 5-6; M2, 128-130; L1, 48-51; L2 and L3, 7-8; L4, 77-87; L5 and L6, 7-9; L7, 6-7; L8, 7-9; L9, 148-152. All setae smooth; M2 and L9 slightly knobbed. L1 longer than distance

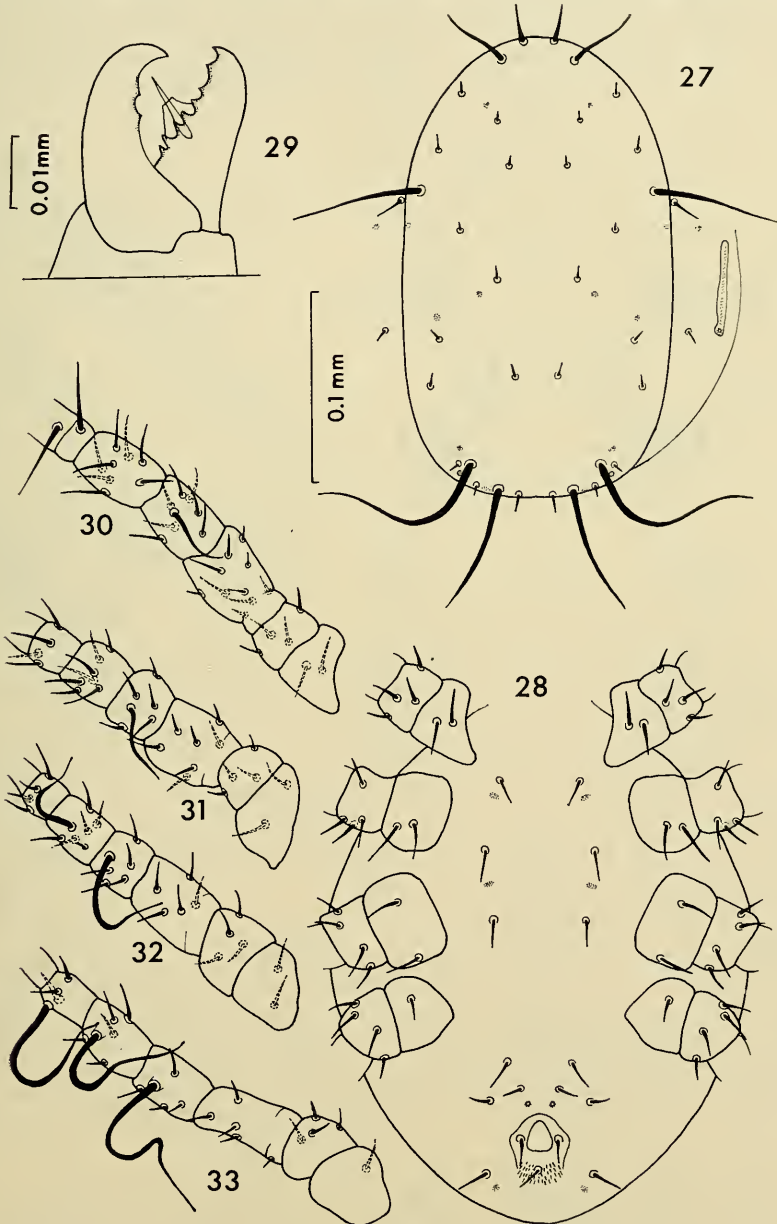

Figs 27-33. *Amblyseius (A.) lentiginosus* protonymph. 27. Dorsal shield. 28. Venter. 29. Chelicera. 30. Leg I dorsal. 31. Leg II dorsal. 32. Leg III dorsal. 33. Leg IV dorsal

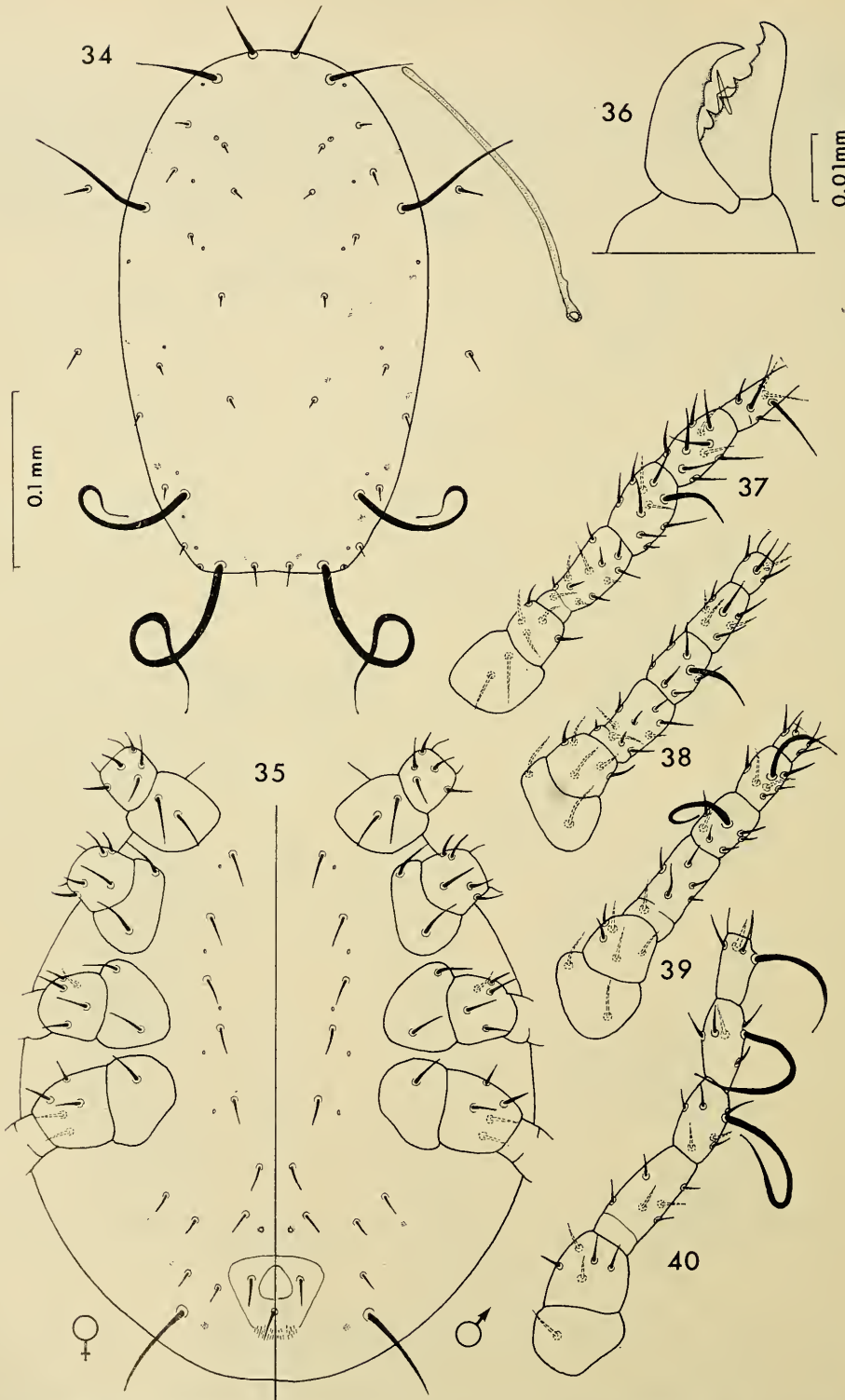

Figs 34-40. *Amblyseius (A.) lentiginosus* deutonymph. 34. Dorsal shield. 35. Venter of male and female. 36. Chelicera. 37. Leg I dorsal. 38. Leg II dorsal. 39. Leg III dorsal. 40. Leg IV dorsal.

between its base and base of L2; all other setae shorter than distances between their bases and bases of setae following next in series. Small pores near L1, L3, between L4 and L5, near L5, L7, L8, L9, and M1; in addition several other smaller pores as figured. S1, 16-18; S2, 8-10, on interscutal membrane. Peritremes 141-159 long.

*Venter.* Sternal area with five pairs of setae; anal shield with three para-anal setae of equal length. Two pairs of preanal setae, two pairs of lateroventral setae, two pairs of posteroventral setae, and one pair of large caudal setae. Eight pairs of small pores as figured. Preanal pores 31-32 apart.

*Chelicera.* Digits 24-26 long. Fixed digit with four teeth on distal half, two teeth on proximal half, and pilus dentilis; movable digit with two backward pointing teeth, on inner margin.

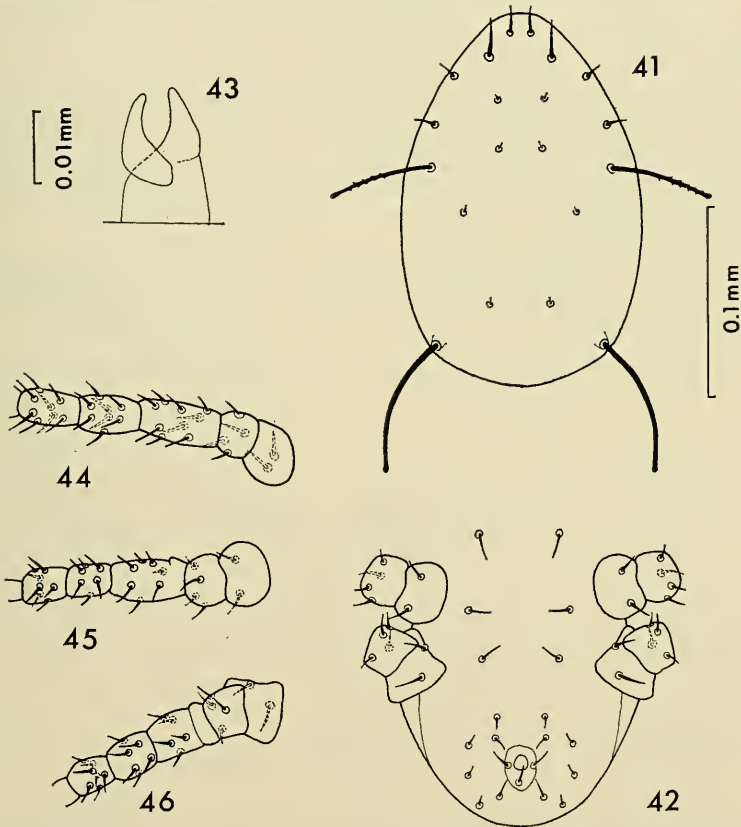

Figs 41-46. *Phytoseius fotheringhamiae* larva. 41. Dorsal shield. 42. Venter. 43. Chelicera. 44. Leg I dorsal. 45. Leg II dorsal. 46. Leg III dorsal.

*Legs.* Chaetotaxy resembles that of *T. (T.) helenae* deutonymph, but with nine macrosetae: on genu I, 34-37; two on basitarsus I, 36-39; on genu II, 34-37; on genu III, 59-63; on tibia III, 49-51; on genu IV, 107-110; on tibia IV, 87-91; on basitarsus IV, 77-83.

#### Male

*Dorsum.* Idiosoma 260-288 long, 138-144 wide at L4; chaetotaxy resembles that of female deutonymph, but setae shorter: D1, 25-29; D2 and D3, 3-4;

D4 and D5, 4-5; D6, 10-14; M1, 3-5; M2, 113-124; L1, 42-46; L2, 4-6; L3, 6-7; L4, 72-75; L5 and L6, 5-6; L7, 5-7; L8, 6-7; L9, 138-145. S1, 14-15, and S2, 5-6, on interscutal membrane.

*Venter.* Similar to that of female deutonymph, but differs in absence of one pair of posteroventral setae. Preanal pores 14-15 apart.

*Chelicera.* Resembling those of female deutonymph, but only 32-33 long.

*Legs.* Chaetotaxy resembling that of female deutonymph. Nine macrosetae: on genu I, 30-33; on basitarsus I, 35-39; on genu II, 33-35; on genu III, 57-59; on tibia III, 45-50; on genu IV, 106-109; on tibia IV, 84-90; on basitarsus IV, 78-80.

*Phyoseius fotheringhamiae* Denmark and Schicha, 1974b

Figs 40-60

LARVA (Figs 41-46)

*Dorsum.* Smooth idiosoma 168-177 long, 123-138 wide at L4. Ten pairs of setae, four dorsal, one median, four proateral, one caudolateral: D1, 9-11 long; D2, D3, D4 and M1 minute; L1, 14-17; L2, 6-7; L3, 4-6; L4, 58-60; L9, 72-83. L4 and L9 slightly knobbed, L4 serrated. L1 approximately as long as distance between its base and base of L2. All other setae shorter than distances between their bases and bases of setae following next in series. No stigmata or peritremes.

*Venter.* Sternal area with three pairs of setae. Anal shield with three subequal para-anal setae. Two pairs of preanal, lateroventral, and posteroventral setae. Sexes indistinguishable.

*Chelicera.* Both digits 11-12 long, no teeth on margins or pilus dentilis.

*Legs.* With same chaetotaxy as that of *T. (T.) helenae* larva.

PROTONYMPH (Figs 47-53)

*Dorsum.* Rugose idiosoma 202-205 long, 130-133 wide at S1. Fourteen pairs of setae, five dorsal, two median, one sacral, six lateral: D1, 20-22 long; D2, D3, and D4, 4-6; D5, missing; D6, 6-7; M1, 4-6; M2, 40-45; S1, 29-30; S2, missing; L1, 33-34; L2, 14-15; L3, missing; L4, 18-19; L5, 51-52; L6, 37-38; L7, 32-34. L1, L5, L6, L7, D1, M2, S1 serrated, all other setae smooth. L1 longer than distance between its base and base of L2. L3 as long as, all other setae shorter than, distances between their bases and bases of setae following next in series. One pair of pores as figured. Peritremes 29-30 long.

*Venter.* Sternal area with three pairs of setae. Anal shield with three para-anal setae. Two pairs of preanal, one of lateroventral, and one of caudal setae. Five pairs of small pores as figured. Sexes indistinguishable.

*Chelicera.* Fixed digit 14-15 long, with two teeth on distal half, one tooth on proximal half and pilus dentilis. Movable digit 16-17 long, with one tooth, on inner margin.

*Legs.* Chaetotaxy of first three legs resembles that of larva. Chaetotaxy of leg IV like that of *T. (T.) helenae* protonymph, but with four knobbed macrosetae; on genu, 18 long; on tibia, 29; two on basitarsus, 29-30 and 22 long.

DEUTONYMPH (Figs 54-60)

*Female*

*Dorsum.* Rugose idiosoma 245-248 long, 144-147 wide at S1, with 15 pairs of setae, five dorsal, two median, one sacral, seven lateral: D1, 27-31 long; D2, 4-5; D3, 5; D4, 5-6; D5, missing; D6, 4-5; M1, 6-7; M2, 43-45; S1, 32-41; S2 missing;



L1, 43-47; L2, 14-17; L3, 19-22; L4, 11-14; L5, 59-68; L6, 52-58; L7, 39-46. All lateral setae (except L2), D1 and S1 serrated. All other setae smooth. L1 to L4 longer, all other setae shorter, than distances between their bases and bases of setae following next in series. Two pairs of pores as figured. Peritremes 116-117 long.

*Venter.* Sternal area with five pairs of setae. Anal shield with three para-anal setae of equal length. Two pairs of preanal setae, two pairs of lateroventral

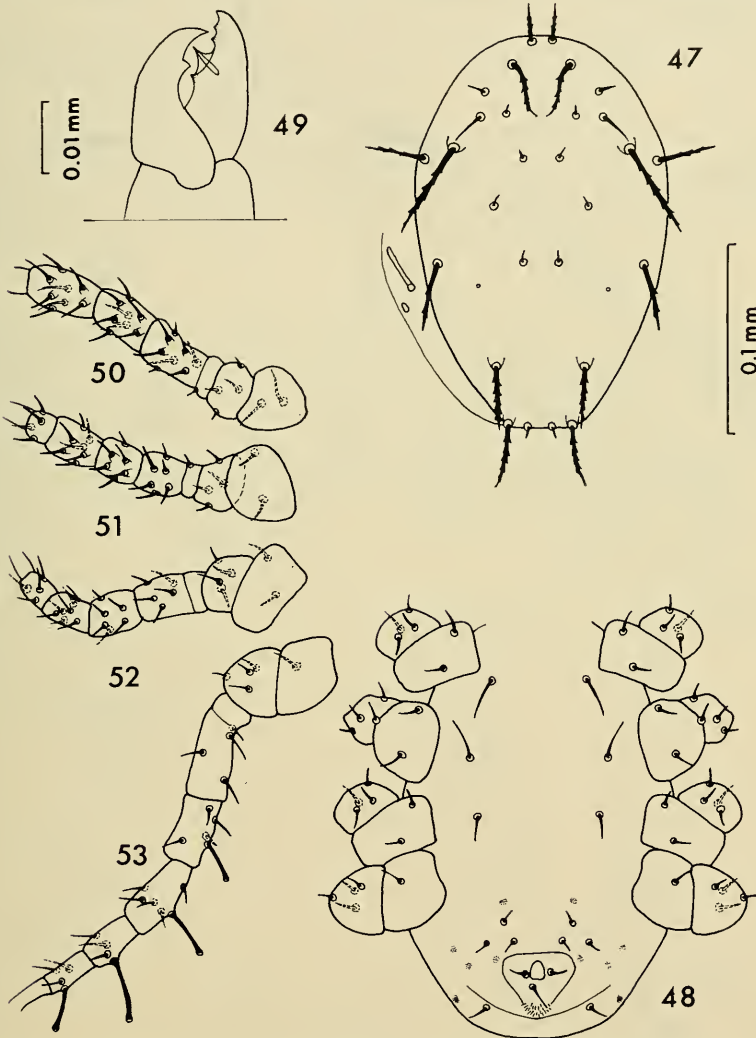

Figs 47-53. *Phytoseius fotheringhamiae* protonymph. 47. Dorsal shield. 48. Venter. 49. Chelicera. 50. Leg I dorsal. 51. Leg II dorsal. 52. Leg III dorsal. 53. Leg IV dorsal.

setae, one pair of posteroventral setae, and one pair of large caudal setae. Ten pairs of pores as figured.

*Chelicera.* Digits 22-23 long. Fixed digit with two teeth on distal half, one tooth on proximal half and pilus dentilis; movable digit with one tooth on inner margin.

*Legs.* Chaetotaxy resembles that of *T. (T.) helenae* deutonymph, but with four knobbed macrosetae: on leg IV: on genu, 18-21; on tibia, 32-40; two on basitarsus, 32-40 and 22-23 long.

*Male*

*Dorsum.* Rugose idiosoma 214-225 long, 100-121 wide at S1; chaetotaxy resembles that of female deutonymph, but setae shorter: D1, 24-26; D2,

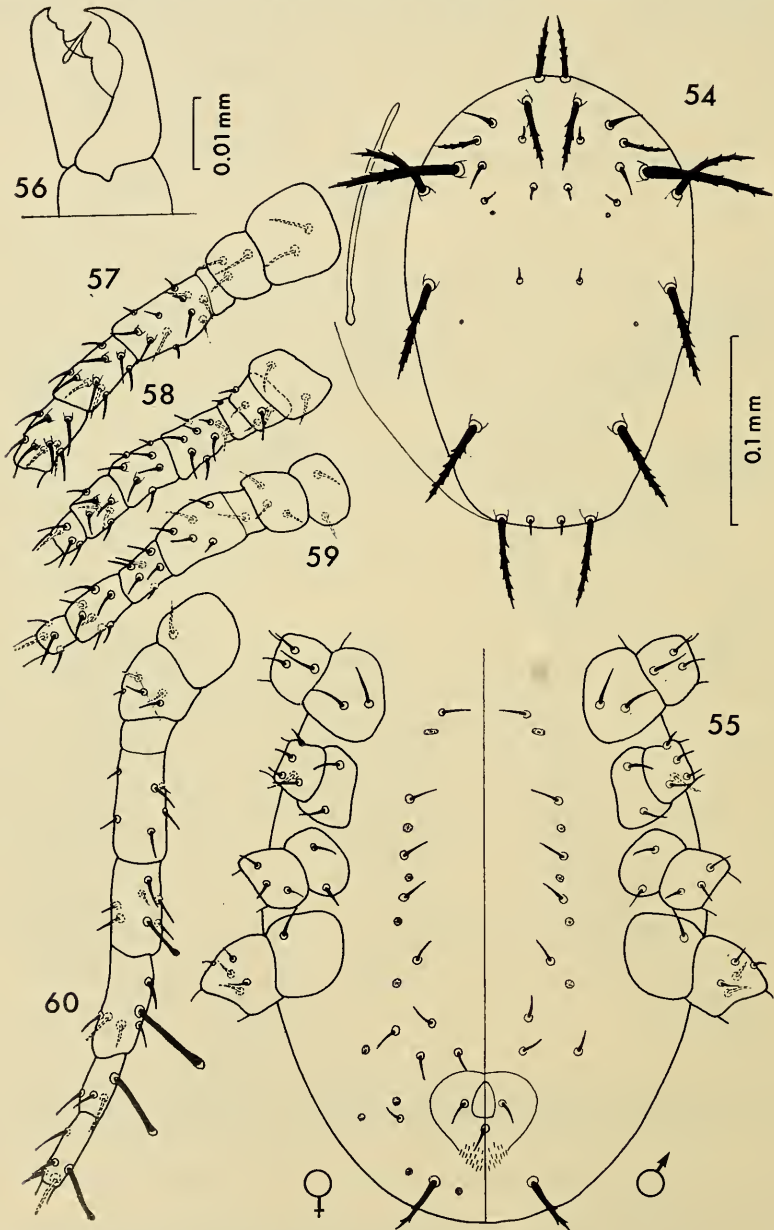

Figs 54-60. *Phytoseius fotheringhamiae* deutonymph. 54. Dorsal shield. 55. Venter. 56. Chelicera. 57. Leg I dorsal. 58. Leg II dorsal. 59. Leg III dorsal. 60. Leg IV dorsal.

D3, D4, 4-5; D5 missing; D6, 7-8; M1, 5-6; M2, 36-42; S1, 35-37; S2, missing; L1, 32-38; L2, 7-8; L3, 14-16; L4, 9-11; L5, 50-57; L6, 44-49; L7, 37-39.

*Venter.* Similar to female deutonymph, but differs in absence of one pair of lateroventral and one pair of posteroventral setae.

*Chelicera.* Resembling those of female deutonymph, but only 20-21 long.

*Legs.* Chaetotaxy resembling that of female deutonymph. Four knobbed macrosetae on leg IV: on genu, 16-17; on tibia 28-29; two on basitarsus, 25-30 and 18-21 long.

#### DEPOSITORY OF SPECIMENS

One slide specimen of larva, protonymph, male deutonymph and female deutonymph of each species at the South Australian Museum, Adelaide, S.A. Additional slide specimens at Biological and Chemical Research Institute, Rydalmere, N.S.W.

#### References

- CHANT, D. A., 1958.—Immature and adult stages of some British Phytoseiidae Berl., 1916 (Acarina). *J. Linn. Soc. Lond. (Zool.)*, 43: 599-643.
- DENMARK, H. A., and SCHICHA, E., 1974a.—A new species of *Amblyseius* Berlese (Acarina: Phytoseiidae) from apple in Australia. *PROC. LINN. SOC. N.S.W.*, 99: 145-150.
- , and ———, 1974b.—A new species of *Phytoseius* Ribaga (Acarina: Phytoseiidae) from apple in Australia. *PROC. LINN. SOC. N.S.W.*, 99: 177-180.
- EVANS, G. O., 1963.—Observations on the chaetotaxy of the legs in the free-living Gamasina (Acari: Mesostigmata). *Bull. Br. Mus. Nat. Hist. (Zool.)*, 10: 275-303.
- SCHICHA, E., and DOSSE, G., 1974.—A new species of *Typhlodromus* Scheuten (Acarina: Phytoseiidae) from apple in Australia. *PROC. LINN. SOC. N.S.W.*, 99: 79-84.

A NEW SPECIES OF *BRACHIONUS* (ROTIFERA) FROM THE  
MYALL LAKES, NEW SOUTH WALES

MINORU SUZUKI\* AND B. V. TIMMS†

[Accepted for publication 19th May 1976]

*Synopsis*

*Brachionus baylyi* sp. nov. from the Myall Lakes, New South Wales, is described and figured. It is most closely related to *B. plicatilis* and its varieties, differing in the form of both frontal and caudal margins.

INTRODUCTION

During an investigation on the plankton of the Myall Lakes (Timms, 1976) an undescribed species of *Brachionus* was recovered from Myall Lake and Lake Boolambayte. The Myall Lakes are a series of interconnected coastal lakes 80 km north of Newcastle. Myall Lake, and to a large degree Lake Boolambayte, are unusual thalassic lakes in that their salinities are low and fairly constant (1–4‰) (W. Johnson, pers. comm.). Most rotifers inhabiting them are ubiquitous forms at the freshwater end of salinity gradients in eastern Australia (Timms, 1976), but one of the rotifers is new. This species is described below.

*Brachionus baylyi* sp. nov.

*Description.* Lorica stippled on surface, triangular with rounded corners in dorsal view (Fig. 1), oval in lateral view (Fig. 2) and semi-circular shaped in frontal view (Fig. 3). Occipital spines six in number, of which anterior medians longest. Each spine comparatively long and broad-based, without so-called saw teeth (Fig. 4). In some specimens there are occasional accessory spines (Fig. 5) on the intermediate spines. Pectoral or mental margin clearly divided into four nearly equal sized projections, each triangular in shape and acutely pointed (Fig. 6). Caudal extremities nearly M-shaped (Fig. 7) in dorsal view, upsidedown heart-shaped (Fig. 8) in ventral view. A knoblike swelling (Fig. 9) usually on the right outer side, rarely on both sides of the caudal extremity. No posterior spines present. Foot *calyciflorus*-like in type (Fig. 10).

*Measurements.* FEMALE. Length of lorica: 268–330  $\mu$ , widest part 245–290  $\mu$ , highest part 140–159  $\mu$ . Occipital spines: laterals 26–36  $\mu$ , intermediates 27–39  $\mu$ , medians 32–44  $\mu$ . Caudal projections: 9–13  $\mu$  long, 9–12  $\mu$  wide. Foot: 160–170  $\mu$  long, 25–30  $\mu$  in diameter. MALE. *c.* 150  $\mu$  long, 60  $\mu$  high. Foot: *c.* 30  $\mu$  long, 11  $\mu$  in diameter. AMICTIC EGG. 120–140  $\mu$  long, 105–120  $\mu$  in diameter. MALE EGG. *c.* 80  $\mu$  long, 70–73  $\mu$  in diameter. Fertilised egg not observed. *Form change.* Variation has been observed in the degree of roundness of the corners of the lorica—from slightly rounded to markedly rounded; in the presence or absence of both accessory spines on the intermediates; in the swelling on the caudal extremity.

*Ecology.* In Myall Lake the ♀♀ and ♂♀ female of *B. baylyi* were abundant on 23 February 1974 and occurred with *Asplanchna* (*Asplanchnella*) sp. near *A. brightwelli*, *Russelletia parrotti* Russell? (♀♀), *Monostyla robusta* Stokes? and *M. stenroosi* Meissner. On 16 April 1974 the ♀♀ female was uncommon and a single specimen of the male of *B. baylyi* was found together with *Asplanchna*

\* Biology Laboratory, Nihon Daigaku, Ōmiya-shi, Saitama-ken, Japan 330.

† Science Department, Avondale College, Cooranbong, New South Wales, 2265.

(*Asplanchnella*) sp. near *A. brightwelli* (♂♀, ♀♀). In Boolambayte *B. baylyi* was uncommon and most of the specimens did not carry eggs.

The new species *B. baylyi* occurred in salinities 1.4–1.9‰ and only in late summer and autumn. It was invariably associated with the copepods *Gladioferens spinosus* Henry and *Sulcanus conflictus* Nicholls.

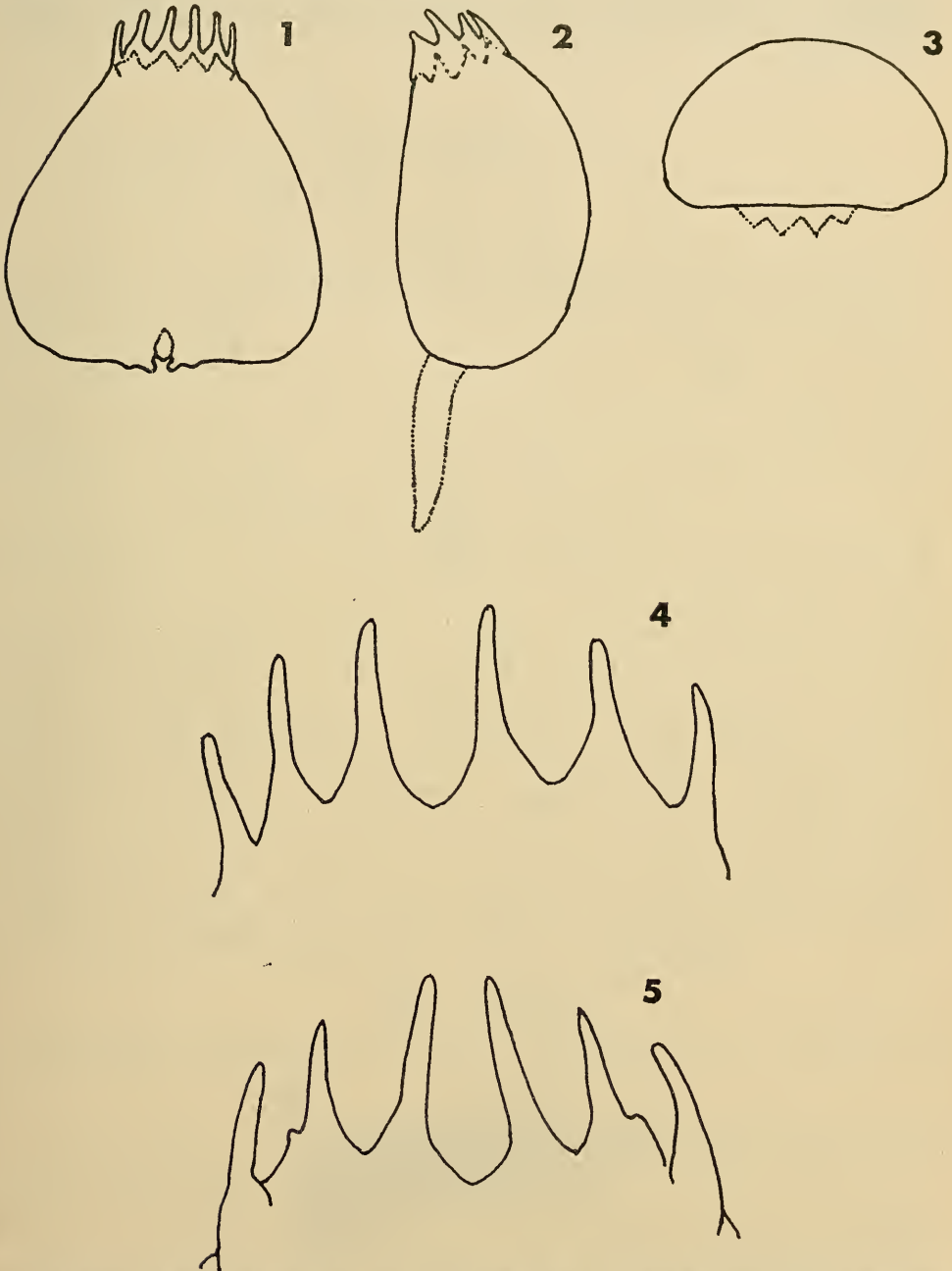

Figs 1–5. *Brachionus baylyi* sp. nov. 1. Dorsal view. 2. Lateral view. 3. Frontal view. 4. Occipital spines. 5. Accessory spines on intermediates.

The holotype of *Brachionus baylyi* is deposited in the Australian Museum, Sydney (AM Z.3697); other specimens have been designated as paratypes (AM Z.3698). Further paratypes are kept in the Biological Laboratory of Nihon Daigaku (A.ROT. 0012-0015).

*Etymology.* The species has been named after Dr. I. A. E. Bayly, Monash University, in honour of his pioneering work on the biology of estuarine plankton in Australia.

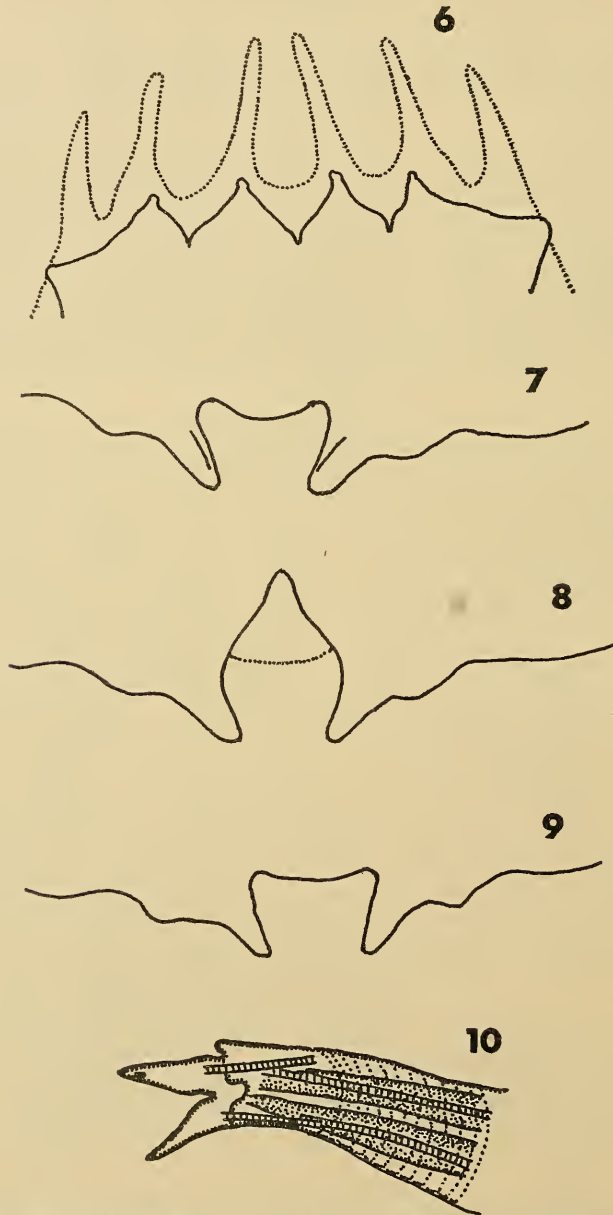

Figs 6-10. *Brachionus baylyi* sp. nov. 6. Pectoral margin. 7. Caudal extremity (dorsal). 8. Caudal extremity (ventral). 9. Knoblike swellings. 10. Foot with toes.

## DISCUSSION

*Brachionus* is a common and representative genus of planktonic rotifers. A number of monographs and papers relating to it have been published, including descriptions of the genus and its species (Bryce, 1924; Ahlstrom, 1940; Gillard, 1948; Voigt, 1956-57; Bartos, 1959; Berzins, 1960; Rudescu, 1960; Sudzuki, 1964; Kutikova, 1970; Ruttner-Kolisko, 1972; Koste, 1972). The following five criteria for species separation within the genus *Brachionus* have been regarded as valid by Bryce (1924, p. 95), Sudzuki (1964, p. 40) and Ruttner-Kolisko (1972, p. 163):

- (i) the pattern of the pectoral or mental margin of the lorica;
- (ii) the pattern of the occipital margin;
- (iii) the general shape of the lorica (spine excluded);
- (iv) the structures of the foot;
- (v) the features around the foot opening.

Based on the pattern of the pectoral margin of the lorica, the specimens from Myall Lakes are most similar to two varieties of *B. plicatilis*, namely var. *orientalis* Rodewald 1937 (Rudescu, 1960, p. 408, Fig. 323) and var. *decemcornis* Fadeev 1925 (Kutikova, 1970 p. 568, Fig. 926) and to *B. satanicus* Roussetlet 1913 (Roussetlet, 1913, pp. 59-60, Fig. 2). However, these two varieties of *B. plicatilis* are clearly different from *B. baylyi* in the pattern of the occipital margin (saw-toothed in these varieties, not saw-toothed in *B. baylyi*) and in the general shape of the lorica (ovoid in *B. orientalis*, elongated in *B. decemcornis*, triangular in *B. baylyi*). *Brachionus baylyi* is distinctly different from *B. satanicus* in lacking large caudal elongations.

The pattern of the occipital margin and the caudal features are similar in *Brachionis baylyi* and *B. nilsoni* Ahlstrom (Ahlstrom 1940, Pl. 18, Fig. 2), but in the latter species the pectoral margin is undifferentiated into projections.

In the general shape of the lorica and in habitats *B. baylyi* is allied to two varieties of *B. plicatilis*, namely var. *spatiosus* Roussetlet 1912 (Roussetlet, 1912 pp. 373-4, Pl. 13, Fig. 2) and var. *rotundiformis* Tschugnoff 1921 (Kutikova, 1970, p. 586, Fig. 927), to *B. pterodinoides* Roussetlet 1913 (Roussetlet, 1913, p. 59, Fig. 1; Carlin-Nilson 1935, p. 4, Figs 8-10) and to *B. novae-zealandiae* (Morris) 1913 (Morris, 1913, p. 167 with figure). However, *B. baylyi* is different from these two varieties in lacking saw teeth on the occipital spines and in not possessing "scalloped" elevations on the pectoral margin. Furthermore the shape of the posterior half of the lorica is different (round in var. *rotundiformis*, slender in var. *spatiosus*). *Brachionus baylyi* is readily distinguishable from *B. pterodinoides* in the position of the foot opening (ventral and nearly in the middle of the body in *B. pterodinoides*, terminal in *B. baylyi*), and from *B. novae-zealandiae* in the shape of the pectoral margin (markedly elevated toward centre in *B. novae-zealandiae*, not elevated toward centre in *B. baylyi*).

## ACKNOWLEDGEMENT

We wish to thank Dr. M. Geddes, Zoology Department, University of Adelaide, for his valuable comments on the manuscript.

## References

- AHLSTROM, E., 1940.—A revision of Rotatorian genera *Brachionus* and *Platyias* with description of one new species and two new varieties. *Bull. Am. Mus. Nat. Hist.*, 77: 143-184.
- BARTOS, E., 1959.—Vírnicí. *Fauna Cesk. SSR*, 15: 1-965.
- BERZINS, B., 1960.—Rotatoria. *Cons. Int. Explor. Mer*, 86: 1-3.
- BRYCE, D. L., 1924.—The Rotifera and Gastrotricha of Devil's and Stump Lakes, North Dakota, U.S.A. *J. Quekett Microsc. Club*, ser. 2, 15: 81-108.
- CARLIN-NILSON, B., 1935.—Rotatorien aus Mexico. *K. Fysiogr. Saellsk. Lund Foerh.*, 5: 1-11.
- GILLARD, A., 1948.—De Brachionidae van Belgie. *Naturwiss. Tijdschr.*, 30: 159-218.
- KOSTE, W., 1972.—Rotatorien aus Gewässern Amazoniens. *Amazoniana*, 3: 268-505.

- KUTIKOVA, L. A., 1970.—Kolovrati. *Fauna SSSR*, n.s., 104 : 1-774.
- MORRIS, C. B., 1913.—Some notes on Rotifera not previously recorded as occurring in New Zealand. *Trans. N.Z. Inst. Wellington*, 46 : 163-167.
- ROUSSELET, C. F., 1912.—On *Notholca triarthroides* Skorikow, *Cathypna brachydactyla* Stenroos and on a new *Brachionus* from Devil's Lake, North Dakota. *J. Quekett Microsc. Club*, ser. 2, 11 : 371-374.
- , 1913.—The Rotifera of Devil's Lake, with a description of a new *Brachionus*. *J. Quekett Microsc. Club*, ser. 2, 12 : 55-64.
- RUDESCU, L., RODEWALD, 1960.—Rotatoria. In *Fauna Republicii Populare Romine*. Vol 1. Bucharest : Academia Republicii Socialiste Romania : 1-1192.
- RUTTNER-KOLISKO, A., 1972.—Rotatoria. *Binnengewasser*, 26 : 99-234.
- SUDZUKI, M., 1964.—New systematical approach to the Japanese planktonic Rotatoria. *Hydrobiologia*, 23 : 1-124.
- , 1968.—Rotifers from Western Australia. *Proc. Jap. Soc. Syst. Zool.*, 3 : 17-19.
- , 1975.—A new *Brachionus* from Australia and a revision of the *B. plicatilis* complex. *Zool. Mag.*, 84 : 446.
- TIMMS, B. V., 1976.—Salinity regime and zooplankton of the Myall Lakes. *Hunter Nat. Hist.*, 8 : 6-13.
- VOIGT, M., 1956-57.—Rotatoria. *Die Rädertiere Mitteleuropas*. Bd 1 und Bd 2. Berlin-Nikolassee : Bornträger.



# UPPER ORDOVICIAN TABULATE CORALS FROM CENTRAL-WESTERN NEW SOUTH WALES

B. D. WEBBY\*

(Plates II-X)

[Accepted for publication 19th May 1976]

## Synopsis

Eighteen tabulate coral species are described and illustrated from the Upper Ordovician limestones and limestone breccias of central New South Wales. Included among the forms are four new species of *Bajgolia*: *B. caespitosa*, *B. furcata*, *B. minor* and *B. ? grandis*, the latter only doubtfully assigned to the genus, and five other new species, *Eofletcheria hadra*, *Aulopora walliensis*, *Adaverina acritos*, *Fletcheria ? stipulosa* and *Catenipora clausa*. An outline of the stratigraphic distribution of the faunas is also presented.

## INTRODUCTION

Earlier contributions on the Upper Ordovician tabulate corals of central New South Wales are given by Etheridge (1909), Hill (1957), Webby and Semeniuk (1969, 1971) and Webby (1975). The present work completes descriptions of the following six tabulate coral groups—lyoporids, cryptolichenariids, auloporids, aulocystids, fletcheriids and halysitids. These are based on collections (both unsilicified and silicified) housed in the Department of Geology and Geophysics, University of Sydney.

The faunas have been collected from widely scattered localities on the flanks of the Molong Rise and on the Parkes Platform (Webby, 1976), through a considerable part of the Late Ordovician (from late Gisbornian or early Eastonian to early Bolindian). Distinctive faunas are readily distinguishable at each of the four stratigraphic levels (Faunas I-IV of Webby, 1969, 1972, 1975), and at the lowest stratigraphical level (Fauna I) there are important lateral faunal variations arising from the differing tectono-environmental settings on either side of the Molong Rise. As representative of Fauna I on the eastern flank of the Molong Rise is the assemblage from the lower part of the Cliefden Caves Limestone of *Eofletcheria hadra* sp. nov., *Bajgolia caespitosa* sp. nov., *B. furcata*, sp. nov., *B. cf. contigua* (Hill, 1955) and *B. minor* sp. nov., and the occurrence of *B. cf. furcata* from a similar stratigraphic level in the Reedy Creek Limestone. A somewhat different fauna characterises Fauna I on the western side of the Molong Rise. Not only are all the species of *Tetradium* different (see Webby and Semeniuk, 1971), but other tabulates as well—for example, *Fletcheria ? stipulosa* sp. nov. in the Gerybong Limestone Member (Semeniuk, 1973) and *Bajgolia cf. gracilis* (Hill, 1957) in the Manooka Limestone Member of the Daylesford Limestone (Bowen Park Group).

The massive, middle member of the Cliefden Caves Limestone was originally excluded from the faunal scheme because it contained few key fossils. The finding of certain diagnostic forms in the massive limestone has, however, led to the bulk of this sequence being assigned to Fauna II. I. G. Percival recently collected *Bajgolia ? grandis* sp. nov., and the stromatoporoid *Ecclimadictyon* from a level ("E-horizon") 94 m above the base of the massive member in the Licking Hole Creek area. This extends the range of the Fauna II assemblage

---

\* Department of Geology and Geophysics, University of Sydney, New South Wales, 2006.

downwards from its previous base just below the "*Aulopora*" unit, at the inferred break in sequence (see Webby and Semeniuk, 1971, text-fig. 2) to well within the lower half of the massive, middle part of the Cliefden Caves Limestone. The "*Aulopora*" unit contains *B.?* *grandis* and *B.?* sp., and the overlying "Island" unit exhibits *B. gracilis* (Hill, 1957) and encrusting forms *Aulopora walliensis* sp. nov., *A.* sp.B and sp.C. The Fauna II elements of the Quondong Limestone (Bowen Park Group) include *B. gracilis* and *A. walliensis*. Forms doubtfully referred to *B. furcata* also occur in the Quondong Limestone and upper part of the Regan's Creek Limestone.

Another species of *Aulopora*, *A.* sp.A occurs in the limestone of the lower part of the Goonumbla Volcanics north of Gunningbland. It is a member of the Fauna III assemblage.

In a limestone breccia towards the base of the Malongulli Formation, overlying the Cliefden Caves Limestone, I. G. Percival found a distinctive species of *Catenipora*, *C.* sp., at a level normally included in Fauna III (Webby, 1969, 1975). The Malongulli species, though derived, must be similar to or older than the enclosing sediments (Zone of *Dicranograptus hians*—late Eastonian) and must represent the earliest appearance of *Catenipora* in the New South Wales succession. The appearance of *Catenipora* is therefore not diagnostic of Fauna IV as previously stated (Webby, 1972).

However, the species *Catenipora clausa* sp. nov., *C.* cf. *obliqua* (Fischer-Benzon, 1871) and *Adaverina acritos* sp. nov., occurring in the limestone band and breccias at the top of the Malachi's Hill Beds (Semeniuk, 1970), represent characteristic components of Fauna IV. Possibly coming from a similar horizon is the occurrence of *Halysites* sp. from the Angullong Tuff of Rodds Creek (Smith, 1966).

#### SYSTEMATIC DESCRIPTIONS

##### Superfamily LICHENARIIDEA

##### Family LYOPORIDAE Kiaer 1930

##### Genus EOFLETCHERIA Bassler 1950

*Type species.* *Columnaria incerta* Billings 1859.

*Diagnosis.* Phaceloid to locally cerioid colony of cylindrical, thick-walled corallites. Short, thick septal trabeculae in wall; sometimes project as short spines into lumen. Transverse wrinkles may occur in outer corallite wall. Lateral increase frequent. Tabulae irregularly spaced, usually complete, horizontal or sagging. No pores and no connecting processes.

*Discussion.* Although originally described by Bassler (1950, p. 266) as lacking septal structures, later workers (Hill, 1953, 1955; Sokolov, 1962; Klaamann, 1966) have widened the scope of the genus to include species with septal trabeculae. Hill and Stumm (1956), on the other hand, have since stated in their diagnosis of *Eofletcheria* that there are no septa and that the corallites are connected by "short, horizontal syringoporoid tubules". The type species, *E. incerta* from the Chazyan of Mingan Islands, Montreal and Ottawa, as described by Okulitch (1937) and Sinclair (1961) has, however, no connecting processes or tubules between individual corallites. Lambe's (1899) interpretation of septal spines in the type species has not been substantiated by later workers, but other species of *Eofletcheria*, notably *E. orvikui* (Sokolov, 1951), exhibit such structures. The species assigned to the genus are listed by Klaamann (1966). To this list should be added one Australian species, *E. hadra* sp. nov., described herein.

Sokolov (1955, 1962) and Klaamann (1965, 1966) have assigned *Eofletcheria* and *Reuschia* Kiaer 1930 to the Family Lyoporidae Kiaer 1930 (Subfamily

*Eofletcherinae* Sokolov 1955), whereas Hill (1953), despite emphasising resemblances in the character of the transverse wrinklings of corallite wall of *Eofletcheria*, *Reuschia* and cerioid *Lyopora*, preferred to relate the first two genera to syringoporids and auloporids—Subfamily Syringoporinae of the Family Auloporidae (Hill and Stumm, 1956).

*Eofletcheria hadra* sp. nov.

Pl. V, figs 1–5; Pl. VI, fig. 4.

*Material.* Holotype SUP 78185 and paratypes SUP 78223, 78184 from the "mixed fauna" unit west of Boonderoo shearing shed. Other paratypes from the "mixed fauna" unit comprise SUP 78218 from east of Fossil Hill and SUP 78180 from south-west of Fossil Hill. A fifth paratype (SUP 78163) comes from the "lower coral" unit at Fossil Hill. All types are from the lower part of the Cliefden Caves Limestone.

*Description.* Corallum of moderately closely spaced corallites ranging from fasciculate to cerioid in habit (not ramose); one colony (Pl. V, fig. 5) encrusts *Tetradium cribriforme* (Etheridge). Adult corallites usually range from 2.1 to 3.3 mm in diameter, but colonies exhibiting a predominantly cerioid form tend to have smaller corallites, usually from 1.7 to 2.5 mm in diameter. In transverse sections, corallites show rounded to polygonal and alveoloid outlines; wall of variable thickness, usually from 0.3 to 0.7 mm, but in extremes, especially in cerioid forms, up to 0.9 mm thick, and almost entirely fills interior of corallite. Dark median line is exhibited where corallites are in contact. Wall to either side of dark line composed of radially aligned fibrous, possibly trabecular, tissue. A few rare examples mainly where a thinner wall is represented show spine-like projections of trabeculae into lumen (Pl. V, fig. 3), but usually inner margin of wall is smooth. In parts of corallum conspicuous transverse wrinkles develop in outer corallite walls (Pl. V, fig. 1; Pl. VI, fig. 4); only rarely does entire wall become folded causing an overall widening of the lumen (Pl. V, fig. 1). Calices may be very deep (Pl. VI, fig. 4). Rejuvenescence is suggested by occasional rapid constrictions in diameter of an individual corallite. Increase is apparently of lateral type. Tabulae typically flat or sagging; rarely updomed; display extreme variability of vertical spacing, from closely spaced intervals (eight in 3 mm) in some corallites to apparent absence from others.

*Remarks.* The specimen described by Hill (1955) as *Lyopora* cf. *favosa* (McCoy) from the Gordon Limestone at Oceana Mine, Zeehan, Tasmania, may belong to this species or be closely related. Both the type species *E. incerta* and *E. subparallela* Hill 1953 from the Mjøsa Limestone of Norway, like *E. hadra*, exhibit transverse wrinkling. However, *E. incerta* has much smaller corallite diameters and thinner walls, and *E. subparallela* has more wide spaced corallites with a more variable diameter.

Family CRYPTOLICHENARIIDAE Sokolov, in Sokolov and  
Mironova, 1959

Genus BAJGOLIA Dziubo 1962

*Type species.* *Bajgolia altaica* Dziubo 1962.

*Diagnosis.* Ramose colony with cylindrical to slightly compressed branches. Corallites with polygonal shapes axially, curving up and outward as rounded and thickened tubes to open obliquely at the surface of the branch; usually with moderately wide interspaces between individual calices. Wall of radially aligned fibrous (trabecular?) tissue; presence of septal trabeculae not proven. Unequal, adaxial, bipartite parricidal increase. Tabulae rare or absent;

irregularly spaced and usually complete; horizontal, sagging or updomed forms. No pores or connecting processes.

*Discussion.* The type species of *Bajgolia*, *B. altaica* Dziubo 1962, from the late Ordovician of the Altai Mountains, south-west Siberia, is based only on the holotype. Dziubo's original diagnosis states that tabulae are absent. The New South Wales representatives, in contrast, usually exhibit rare tabulae, although not every specimen of a particular species shows them. It seems likely that Dziubo's failure to observe tabulae in the type species is a reflection of inadequate sampling or study, and that there is no fundamental difference between the apparently non-tabulated type species from Siberia and the tabulated Australian forms.

The Australian species formerly assigned by Hill (1955, 1957) to the genus *Eofletcheria*, by having a ramose colony form and by exhibiting unequal, adaxial, bipartite increase, are now included in the genus *Bajgolia*. They differ fundamentally in growth form and mode of increase from the type species and other North American and Eurasian species of *Eofletcheria*. The genus *Bajgolia* seems to have a restricted distribution to the late Ordovician of south-west Siberia, New South Wales and Tasmania.

*Bajgolia* is placed by Dziubo (1962, 1965) and by the present writer in the Family Cryptolichenariidae because it exhibits a similar pattern of adaxial, bipartite increase to other representatives of the family, notably *Cryptolichenaria* Sokolov 1955, *Amsassia* Sokolov and Mironova 1959 and *Porkunites* Klaamann 1966. However the first two of these genera show massive, cerioid coralla, unlike the ramose form of *Bajgolia*, while *Porkunites* has a much more open fasciculate habit.

Sokolov and Mironova (1959), Sokolov (1962) and Klaamann (1966) allied the genera *Cryptolichenaria*, *Amsassia* and *Porkunites* to the tetradiids because of the type of axial increase. However, there is a fundamental difference between the tetradiids which exhibit quadripartite increase and those genera of the Family Cryptolichenariidae which show bipartite increase. Representatives of this family, while showing features which are essentially intermediate between *Lichenaria* and *Tetradium*, seem more satisfactorily grouped with *Lichenaria*. The markedly different growth form and type of preservation of *Bajgolia* do not ally it at all closely to *Tetradium*. Alternatively, based on morphological similarities, but not on the mode of increase, *Bajgolia* may be aligned with auloporids.

*Bajgolia caespitosa* sp. nov.

Pl. II, figs 1-7

*Material.* Holotype (SUP 78179) from the "mixed fauna" unit east of Fossil Hill; three paratypes (SUP 78181, 78183, 78186) from the "mixed fauna" unit west of the Boonderoo shearing shed, and a fourth (SUP 78191) from the "lower coral" unit at Licking Hole Creek. The "lower coral" and "mixed fauna" units are in the lower part of the Cliefden Caves Limestone.

*Description.* Ramose corallum composed of branches of variable thickness usually from 5 to 8 mm across. Corallites of axis of branch usually polygonal, often seen in process of bipartite division. Corallites curve upwards and outwards away from axial region, opening obliquely to surface; may exhibit free outer ends. Corallites in distal parts of branch usually cylindrical and from 1.4 to 1.7 (although in extremes up to 2.0) mm in diameter. Wall thickness varies from 0.1 to 0.7 (on average from 0.25 to 0.40) mm; thickening in rare instances almost entirely fills lumen; towards distal extremities there is a marked thinning of wall. Sclerenchyme with fibrosity aligned at right angles to median dark

line; also associated concentric fracture pattern, probably of secondary origin. Division is unequal, adaxial, bipartite and parricidal. New wall commences to grow from small protuberances of sclerenchyme either on one side or both sides of lumen (Pl. II, figs 6-7; Text-fig. 1A-D); protuberances extend inwards as septa-like structures to fuse axially and so subdivide the lumen into unequal divisions. Dark median line establishes in new dividing wall between two "daughters" but does not initially extend to join dark line surrounding former "mother" corallite (Text-fig. 1C). This is because with a moderately deep calice the intervening sclerenchyme had already been formed by "mother" polyp immediately prior to division. With further growth, dark line dividing "daughters" extends outwards to fuse with that surrounding former "mother" corallite (Text-fig. 1D). No evidence of dimorphism or corallite offsets (Oliver, 1966). Rare flat to sagging tabulae.

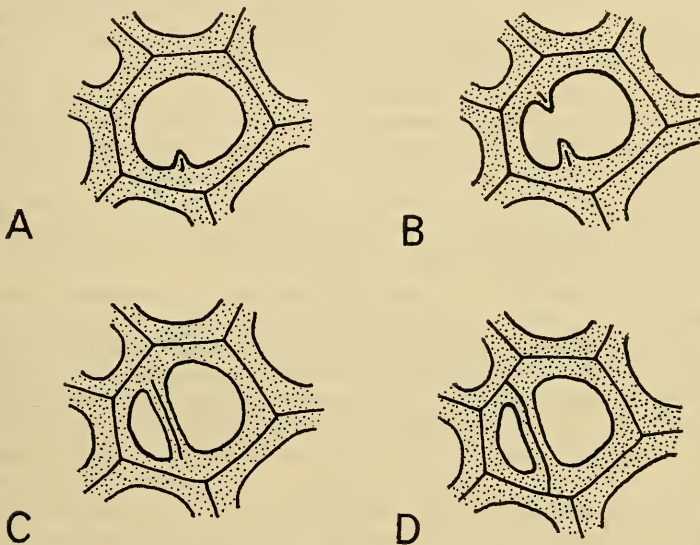

Text-fig. 1. Series of diagrammatic transverse sections showing nature of unequal, adaxial increase in *Bajgolia* (based on *B. caespitosa*; approximately  $\times 11$ ). A. Initial inward extension of sclerenchyme from one side of lumen only; sometimes this single protrusion extends right across lumen and is not met halfway by matching plate-like "septa" from opposite side. B-D. Stages in the development and fusion of the "septal" structures extending from both sides of the lumen to form a new dividing wall with two adjacent new "daughter" corallites.

*Remarks.* One very large ramose colony (SUP 78190) in the collections of the Department of Geology and Geophysics, University of Sydney, bears close morphological similarities to *B. caespitosa*. However, unfortunately the specimen has lost its attached locality and horizon data. It seems likely from manner of preservation and appearance to have been collected from the lower part of the Cliefden Caves Limestone, but this cannot be established with certainty. The colony has an overall flattened hemispherical form, with a flattened top surface and a weakly cone-shaped bottom; it has dimensions of 480 by 440 mm across and 140 mm in height. Branches radiate outwards and upwards from a centre placed slightly eccentrically at the bottom of the cone. The branches reach a vertical height of 140 mm directly above the centre of growth, but extend outwards a much greater distance, in some instances for some 300 mm from the original growth centre. Corallite dimensions are very similar to those of *B. caespitosa*. However, the colony has on average much thinner corallite walls (Pl. II, fig. 8).

*Bajgolia furcata* sp. nov.

Pl. II, fig. 9; Pl. IV, figs 1, 4-6.

*Material.* Holotype (SUP 78155) and paratypes (SUP 78151-54, 78156, 78159-60, 78175) from the "lower coral" unit at Fossil Hill; lower part of the Cliefden Caves Limestone.

*Description.* Moderately sized corallum with discrete branches from 3 to 12 (usually from 4 to 7) mm in diameter; sometimes seen to be branching off a reptant base of attachment (Pl. IV, fig. 1) or otherwise intergrown with bryozoans. Corallites rounded to polygonal; in peripheral part of branch mainly cylindrical and at distal ends may be free; range from 1.0 to 1.8 (usually from 1.2 to 1.5) mm in diameter. Towards axial part of branch corallites tend to be more typically polygonal and include on average smaller dimensions, to a minimum of 0.4 mm in diameter; some of these smaller corallites occur in areas of active division. Wall of individual corallites mainly from 0.1 to 0.2 mm in thickness; in extremes may be up to 0.4 mm thick. In transmitted light common wall is composed of a narrow median dark zone from 0.01 to 0.02 mm wide and thick, light-coloured sclerenchyme to either side. Median dark zone frequently appears to consist of two dark lines separated by a narrow grey zone between. Sclerenchyme adjacent to dark zone shows a radial fibrosity but towards inner margin of wall microstructure is obscured by concentric fracture pattern, probably of secondary origin. Division is of an unequal adaxial, bipartite, parricidal type, as in *B. caespitosa* sp. nov. Tabulae, though rarely seen, are of sagging or slightly updomed types.

*Remarks.* *Bajgolia furcata* bears resemblances to *B. caespitosa*, but differs in having somewhat smaller corallite dimensions and a lesser thickness of corallite wall. A silicified specimen (SUP 26281) from the Quondong Limestone (Bowen Park Group) at Quondong bears close similarities to the species and perhaps should be assigned to it. The branch fragment of the colony is from 3.5 to 6 mm across, and the corallites have a diameter of from 1.3 to 1.5 mm. The corallites open obliquely at widely spaced intervals along the outer surface of the branch as in *B. gracilis* (Hill, 1957). Another silicified specimen from the upper part of the Regan's Creek Limestone (unit 3 of McLean, 1974) displays a thicker branch (up to 9 mm across) and has a much more closely packed arrangement of corallites (Pl. III, fig. 12). In some parts of the corallum the corallites debouch at right angles to the branch axis. Corallites are mainly from 1.3 to 1.5 mm wide, and wall is from 0.2 to 0.4 mm thick. This form is only doubtfully assigned to the species.

Two unsilicified specimens (SUP 78220-21) of *Bajgolia* from the lower part of the Reedy Creek Limestone just north of Molong may also be allied to *B. furcata*. They are not well preserved but exhibit a slightly different growth form with less discrete bundles or branches and a greater frequency of free, upwardly directed corallites (Pl. VI, fig. 3).

*Bajgolia furcata*, though resembling *B. contigua* (Hill, 1955) from the Gordon Limestone of the Oceana Mine, Zeehan, Tasmania, and the type species, *B. altaica* Dziubo 1962, from the late Ordovician of south-west Siberia, differs in having on average larger corallite dimensions. It may also be distinguished from *B. altaica*, which has no tabulae.

*Bajgolia* cf. *contigua* (Hill 1955)

Pl. IV, figs 2-3

*Material.* Two specimens (SUP 78176-77) from the upper part of the "lower coral" unit at Fossil Hill, and one specimen (SUP 78192) from the "lower coral" unit at Licking Hole Creek; lower part of the Cliefden Caves Limestone.

*Description.* Corallum ramose, with branches from 2 to 8 mm in diameter; occasionally intergrown with bryozoans (Pl. IV, fig. 3). Corallites cylindrical in outer parts of individual branches, usually from 0.8 to 1.2 mm in diameter. Inner part of branch has prismatic-shaped corallites, usually of smaller dimensions and frequently undergoing unequal adaxial, bipartite division. Wall thickness varies from 0.07 to 0.15 mm, although in extremes up to 0.25 mm thick. Poor differentiation of wall structure, although median dark line most conspicuous. Domed, flat or gently sagging tabulae occur in some corallites; very rarely seen to be closely spaced (Pl. IV, fig. 2).

*Remarks.* This New South Wales species appears to be closely similar morphologically to *B. contigua* (Hill, 1955) from the Gordon Limestone of Oceana Mine, Zeehan, except for having a slightly thinner corallite wall and in places more closely spaced tabulae. *Bajgolia altaica* Dziubo 1962 differs in having larger branch dimensions and in lacking tabulae.

*Bajgolia minor* sp. nov.

Pl. IV, figs 8–9

*Material.* Holotype (SUP 78164) and paratypes (SUP 78165–66) from the "lower coral" unit of the lower part of the Cliefden Caves Limestone at Fossil Hill.

*Description.* Small, ramose corallum, typically intimately intergrown with a bryozoan. Branches may form clusters of up to 20 corallites in close contact, or develop with more loosely aggregated bryozoan-supported corallites. Adult corallites range from 0.4 to 0.5 mm in diameter. Wall thickness mainly varies from 0.025 to 0.1 mm. Fibrous sclerenchyme is represented in common wall adjacent to median dark line and at right angles to it; very rarely irregular inner margin of wall may be interpreted as suggesting presence of short spine-like elements. Bipartite adaxial increase at intervals of from 1 to 2 mm along length of corallite, as seen in one branch (Pl. IV, fig. 8). Occasional gently updomed, flat or sagging tabulae observed in a few corallites, spaced from 0.1 to 0.3 mm apart.

*Remarks.* Although exhibiting a similar ramose growth habit to other species of *Bajgolia*, *B. minor* is the finest and most slender species known. It is nearest to *B. gracilis* (Hill, 1975) from the Quondong Limestone of the Bowan Park Group, but has finer and thinner-walled corallites.

*Bajgolia gracilis* (Hill, 1975)

Pl. III, figs 1–11; Pl. IV, fig. 7.

1957. *Eofletcheria gracilis* Hill, p. 105, pl. 4, figs 17b, 22b.

*Material.* Holotype (University of Queensland Collection, F 23253) from Bowan Park (Por. 289, Par. Bowan, Co. Ashburnham). Partially silicified specimen (SUP 78217) from Davys Plains Limestone ("pisolite" unit) Member of Daylesford Limestone, and completely silicified specimens (SUP 78280–90) from the Quondong Limestone of the Bowan Park Group at Quondong (probably the same locality and horizon as the holotype), and from the upper part of the Regan's Creek Limestone (SUP 28154–55). Numerous additional unnumbered specimens come from the Quondong Limestone, and the "Island" unit of the upper part of the Cliefden Caves Limestone at Licking Hole Creek.

*Description.* Ramose colony with branches varying from cylindrical to markedly compressed (almost flabellate); occasionally encrusted by bryozoans of more than one kind. Corallites are small and polygonal axially, whereas they assume larger more rounded forms towards periphery of the branches. Corallite dimensions usually from 0.5 to 0.8 mm, and wall thickness from 0.1 to 0.2 mm.

Corallites exposed to exterior frequently show well marked fine transverse growth lines (Pl. III, figs 2, 5-6). Division of adaxial, parricidal bipartite (also rarely tripartite) type; in some parts of branch division seems to be most frequent (Pl. III, figs 9-10), in others much less frequent (Pl. III, fig. 11). Tabulae rarely seen.

*Remarks.* The present description is based on the abundant silicified material available in the collections of the Department of Geology and Geophysics, University of Sydney, and is intended to supplement the description previously given by Hill (1957).

A silicified specimen (SUP 78292) of *Bajgolia* from the Manooka Limestone Member (*Ischadites* unit) of the Daylesford Formation (Bowen Park Group) exhibits close resemblances to *B. gracilis*. However, the branch of the colony is only about 1.5-2.5 mm wide, and the corallites, usually from 0.7 to 0.9 mm in diameter, open obliquely at rather wider spaced intervals along the length of the branch. The specimen is only doubtfully assigned to the species.

*Bajgolia* ? *grandis* sp. nov.

Pl. VI, figs 1-2; Pl. VII, figs 11-12

*Material.* Holotype (SUP 66154) from the "Aulopora" unit of the upper part of the Cliefden Caves Limestone at Licking Hole Creek. The paratypes are silicified. Paratypes SUP 28205-06 are from the "E-horizon" of the middle part of the Cliefden Caves Limestone at Licking Hole Creek, SUP 78291 is from the "Island" unit of the upper part of the Cliefden Caves Limestone at Licking Hole Creek, and SUP 26284 is from the Quondong Limestone (Bowen Park Group) at Quondong.

*Description.* Large, loosely aggregated, ramose corallum with individual branches varying from about 7 to 23 mm in diameter. Corallites mainly cylindrical and thick-walled, usually from 2.1 to 2.7 mm in diameter. Wall of variable thickness, ranging from 0.2 to 0.9 (typically from 0.4 to 0.5) mm in thickness. External surface of silicified corallites show transverse growth lines. Adaxial, bipartite, parricidal increase (Pl. VI, fig. 1); also suggestions of lateral offsets seen in some silicified specimens. Tabulae rare; flat to gently sagging.

*Remarks.* The species is doubtfully assigned to the genus *Bajgolia* for the reason that some specimens show what seems to be lateral offsets, and the branches are not formed of the usual tightly aggregated bundles of corallites. Compared with *B. ? ida* (Hill, 1955) from the Gordon Limestone of Ida Bay, Tasmania, it has larger branches and larger corallite dimensions.

Another specimen (Pl. V, 8-9) from the "Aulopora" unit at Licking Hole Creek seems to be allied to *B. ? grandis*. It has fewer, more loosely clustered corallites in its branches and a greater predominance of free corallites. It has variable corallite dimensions usually from 1.8 to 3.0 mm, but in areas of active increase, corallite diameters from 1.0 to 1.8 mm are not uncommon (Pl. V, fig. 9). Wall in extremes up to 1.2 mm thick. Uneven bipartite division. Rare flat to sagging tabulae.

*Bajgolia* ? sp.

Pl. V, figs 6-7; Pl. VI, fig. 7.

*Material.* Two specimens (SUP 78194, 78196) from the "Aulopora" unit of the Cliefden Caves Limestone at Licking Hole Creek.

*Description.* Dendroid colony composed of loosely interconnected branches and associated free corallites. Corallites usually from 2.7 to 3.5 mm wide.



Corallite wall owing to silicification shows little original structure ; up to 1.2 mm thick. Uneven bipartite adaxial division. No tabulae.

Superfamily AULOPORIDEA

Family AULOPORIDAE Milne Edwards and Haime 1851

Genus AULOPORA Goldfuss 1829

*Type species.* *Aulopora serpens* Goldfuss 1829

*Aulopora walliensis* sp. nov.

Pl. VIII, figs 1-7.

*Material.* Holotype (SUP 78293) from the "Island" unit, upper part of the Cliefden Caves Limestone at Licking Hole Creek, and paratypes from the Quondong Limestone (Bowen Park Group) at Paling Yards Creek (SUP 78294) and Quondong (SUP 77273-75, 78295). Other paratypes (SUP 77271-72) from same locality and horizon as the holotype. All material is silicified.

*Derivation of name.* Walli, a few kms south of the Cliefden Caves Limestone outcrop at Licking Hole Creek.

*Description.* Reptant colony, attached to either valve of brachiopod *Trigrammaria* in a type of commensal relationship. Corallites rim anterior to postero-lateral margin of valve and show prominent transverse growth lines or wrinkles (Pl. VIII, figs 4, 6), sometimes secondarily thickened (Pl. VIII, fig. 2). Usually two, or less commonly three, four or more rows of cylindrical to alveolitoid corallites encrust margin of valve. Deep calices. Lateral offsets usually occur at frequent intervals along margin ; less common in early growth stages inside the margin. Notable change in character of growth in holotype (Pl. VIII, fig. 2) presumably due to early growth extending across concave protected part of external surface, while later growth on more exposed and abraded outer margin was much thickened. Adult corallites mainly from 1.6 to 2.2 mm in diameter but in extremes may reach 2.4 mm across. Corallite wall from 0.2 to 0.4 mm across. No tabulae or septal structures seen.

*Remarks.* The nature of the transverse wrinkles on the outer wall of *A. walliensis* might imply a relationship with the problematical cone-like group, the cornulitids, possibly the compound representative *Conchicolites* Nicholson (see Fisher, 1962). However, tabulate coral genera such as *Eofletcheria* and *Lyopora* also exhibit such wrinkling of the epitheca. Bassler (1950, p. 266) has previously noted the similarity of wall corrugation in cornulitids and *Eofletcheria*. Indeed, it seems likely that some, if not all, the so-called "gregarious commensal" cornulitids (Richards, 1974) are tabulate corals.

*Aulopora* sp. A

Pl. VI, figs 5-6.

*Material.* One specimen (SUP 78225) from limestone in the lower part of the Goonumbla Volcanics, Currajong Park, just north of Gunningbland.

*Description.* Corallum reptant at base ; attached to colony of *Heliolites* although actual contact mainly disrupted by pressure solution with stylolite being formed. Corallites have upward turning, horn-shaped form ; in contact proximally ; mainly free upwards ; attain diameters of from 1.6 to 2.9 mm well above reptant base ; wall of corallites also thickens noticeably to from 0.6 to 0.7 mm. Very deep calice. Tiny, discrete septal spines in stereozone, rarely extending into lumen ; embedded in lamellar sclerenchyme of peripheral stereozone. Individual corallites along reptant base are interconnected ; may represent connecting tubules or corallites actively undergoing fission. No tabulae seen.

*Aulopora* sp. B

Pl. VIII, figs 10–13

*Material.* Silicified specimens (SUP 78296–98) encrusting brachiopods *Eodinobolus*? and *Sowerbyites* from the "Island" unit of the upper Cliefden Caves Limestone at Licking Hole Creek.

*Description.* Corallum reptant at base; above base corallites turn upward and become inclined to near vertical tubes. Corallites from 1.3 to 1.7 mm in diameter. Wall from 0.2 to 0.5 mm in thickness; microstructure destroyed by silicification. Calice very deep. No tabulae or septal structures seen. Epitheca smooth to faintly transversely undulating. Lateral offsets only seen to occur on reptant base.

*Remarks.* Another silicified specimen (Pl. VII, figs 13–15) encrusting the antero-lateral margin of the brachial valve of a *Sowerbyella* is also comparable with *Aulopora* sp. B, but has a more irregular growth habit. Corallites are from 1.5 to 1.9 mm in diameter, and the wall thickness is from 0.2 to 0.3 mm. Calices are deep, and epitheca exhibits weak, transverse growth lines.

*Aulopora* sp. C

Pl. VIII, figs 8–9

*Material.* Silicified specimen (SUP 78291) encrusting the brachiopod *Holtedahlina* from the "Island" unit, upper part of the Cliefden Caves Limestone at Licking Hole Creek.

*Description.* Small, reptant colony which encrusts external surface of brachial valve of *Holtedahlina*. Radiates outwards to lateral margin and covers gap in two valves, suggesting that the encrustation took place after death of the brachiopod. Corallites from 1.0 to 1.2 mm in diameter; wall thickness from 0.2 to 0.3 mm. Lateral offsets common. No septal structures or tabulae seen.

## Family AULOCYSTIDAE Sokolov 1950

## Genus ADAVERINA Klaamann 1969

*Type species.* *Syringocystis adaverensis* Klaamann 1966.

*Adaverina acritos* sp. nov.

Pl. IX, figs 1–8

*Material.* Holotype (SUP 78214) from the limestone unit at the top of the Malachi's Hill Beds, north-east of Malachi's Hill.

*Description.* Corallum phaceloid; specimen of holotype measuring 90 mm across and 110 mm high. Corallites slender, cylindrical, usually not in contact except at points of division; range from about 1.3 to 2.0 (on average from 1.5 to 1.7) mm in diameter. Calice deep, with variable U-shaped to acutely funnel-shaped form. Septa represented by tiny holacanthine? spines set in vertical and horizontal series and embedded in lamellar sclerenchyme of the peripheral stereozone; more than 20 septa in an average corallite; either confined to the stereozone or extend a short distance in from it; stereozone varies in thickness from 0.1 to 0.4 (on average from 0.2 to 0.3) mm thick. Increase is of lateral, non-parricidal type—not off the outer wall but arising from peripheral part of parent corallite. No connecting tubules seen.

Tabulae syringoporoid and most variable along the length of individual corallites; in addition to complete sagging, flat and domed plates, there are commonly inclined complete and incomplete infundibuliform plates, some being extremely large elements which extend considerable distances vertically,

and are in places parallel to side walls; a few smaller elements on side walls resemble dissepiments; an axially or slightly eccentric placed syrnix is sometimes developed but tends to be discontinuous along the length of the corallite. Septal spines are not seen to occur on tabulae.

*Remarks.* Klaamann's (1966) species of *Adaverina*, *A. adaverensis* and *A. acclinis* from the Upper Llandovery of Estonia, are not closely similar to *A. acritos*. The New South Wales species has much smaller corallite diameters, more conspicuous slateral budding and a more disordered arrangement of tabulae. But for the lack of connecting tubules, *A. acritos* would seem to be assignable to the genus *Syringopora* Goldfuss.

The type of lateral, non-parricidal increase (Oliver, 1968) differs from lateral increase off the outer wall of the "mother" corallite (see examples of lateral increase in *Hillophyllum* sp., Webby, 1971, fig. 6A-C, H-J). It has been referred to previously as peripheral non-parricidal "budding" (see *Palaeophyllum macrocaule* Webby, 1972, Pl. IX, figs 6, 8). Perhaps a distinction should be drawn between outer lateral and inside lateral types of increase.

### Superfamily AULOPORIIDEA ?

#### Family FLETCHERIIDAE Zittel 1876

Genus FLETCHERIA Milne Edwards and Haime 1851

*Type species.* *Fletcheria tubifera* Milne Edwards and Haime, 1851.

*Fletcheria?* *stipulosa* sp. nov.

Pl. VII, figs 1-10; Pl. IX, figs 9-10

*Material.* Numerous silicified specimens from the Gerybong Limestone Member ("gastropod" unit) of the Daylesford Limestone (lower part of the Bowan Park Group—Semeniuk, 1972) near Quondong; usually associated with *Tetradium tenue* Webby and Semeniuk. Holotype is SUP 78215; others (SUP 26289-92, 41801, 41804, 78216, 78270-79, 78299) designated paratypes.

*Description.* Corallum dendroid; composed of long wavy corallites usually separated except at points of quadripartite division and where connected in series to form discontinuous chains; up to ten corallites linked in such chains. Calice moderately deep and usually with flat floor. Corallites mainly from 2.7 to 4.0 mm in diameter; occasionally they reach diameter of up to 4.8 mm just prior to division, and may be down to 2.0 mm immediately after division; corallites have rounded outline away from areas of active division, and near points of division tend to be subquadrate. Increase is of the parricidal, adaxial, equal quadripartite kind. No septal structures apart from dividing walls, which appear at intervals just prior to division. Thickness of corallite wall varies from 0.15 to 0.35 mm. Horizontal growth lines seen on outer wall of some well preserved specimens. Tabulae usually preserved as complete horizontal elements spaced on average from four to six in 5 mm.

*Remarks.* Sokolov (1955) in reviewing the literature relating to *Fletcheria* Milne Edwards and Haime 1851 (type species, *F. tubifera*, from the Silurian of Gotland) concluded that the genus had come to be recognised as including a number of widely divergent forms—representatives of several different tabulate coral families and even rugosans. The genus has more recently been restricted to representatives of the Family Fletcheriidae exhibiting peripheral (or "calicular") type increase, usually with four offsets, thin intermittent laminar-type septa and horizontal tabulae (Sokolov, 1955, 1962). Specimens of the type species, *F. tubifera*, have been observed by Stasińska (1967) as lacking septal spines and showing "intracalycal" increase with five offsets. Duncan (1956) has also indicated that increase the in type species is characteristically not

quadripartite. *Fletcheria quadrifida* Leleshus 1972 from the Silurian of Tadzhikistan, which exhibits rows of septal spines rather than laminar-type septa, should perhaps be excluded from the genus.

*Fletcheria*? *stipulosa* has previously been interpreted as a "coral resembling *Pycnostylus*" (Semeniuk, 1970) and as a large *Tetradium syringoporoides*-type of coral, up to 3.5 mm in corallite diameter, with closely spaced tabulae and quadripartite division at widely spaced intervals—possibly a new tetradiid genus (Webby and Semeniuk, 1971, p. 247). Although it is tentatively assigned to the auloporids, following Sokolov (1962), the occurrence of axial increase involving extension of four laminar-type "septa" (more properly dividing walls) suggests a relationship with tetradiids. Assignment of the species to *Fletcheria* is not entirely satisfactory, in the light of Stasińska's and Duncan's observations that the type species, *F. tubifera*, exhibits increase which is characteristically not quadripartite. However, it does not seem justified until *Fletcheria* and its allies are more adequately revised to introduce a new tetradiid genus to accommodate the species, especially as it is mainly based on silicified material.

Nor can the species be satisfactorily assigned to the rugosan genus *Pycnostylus* Whiteaves since it only exhibits four tetradiid-type dividing walls rather than the more normal numerous short "laminar" septa (see Hill, 1940).

The New South Wales species seems to bear the closest similarities to *Fletcheria deadwoodensis* Norford 1962 from the Silurian Sandpile Group of British Columbia, but differs in exhibiting on average slightly larger corallites, more widely spaced tabulae, and in showing a tendency for the colony to adopt a chain-like character.

#### Superfamily HALYSITOIDEA

Family HALYSITIDAE Milne Edwards and Haime 1850

Genus CATENIPORA Lamarck 1816

*Type species.* *Catenipora scharoides* Lamarck 1816.

*Catenipora* cf. *obliqua* (Fischer-Benzoni 1871)

Pl. X, fig. 4

*Material.* Two specimens (SUP 29103, 27214) from the limestone breccia at the top of the Malachi's Hill Beds, north-east of Malachi's Hill.

*Description.* Corallum reaches a size of at least 120 mm across; usually forms loose meshwork of open meandering chains with moderately frequent T-shaped junctions. Up to ten corallites in an individual rank. Calice of variable depth, in extremes up to 1.9 mm deep. Corallites oval in cross section mainly from about 1.7 to 1.9 mm in length and from 1.1 to 1.4 mm in width. Offsets usually issue from mid wall of a corallite rather than between adjacent corallites. Walls mainly from 0.2 to 0.3 mm thick. Septal spines short, in places just protrude inward beyond thickened wall; form in horizontal and vertical rows (probably 12). "Balcken" structure may occur in intercorallite wall (Pl. X, fig. 4). Tabulae thin, normally complete, horizontal to slightly sagging, from 12 to 14 in 5 mm.

*Remarks.* The New South Wales species is closely related to *Catenipora obliqua* (Fischer-Benzoni, 1871) from the late Ordovician (Nabala, Vormsi and Pirgu stages) of Estonia (Klaamann, 1966). However the sinuous ranks of the New South Wales form are not seen to link together to form large lacunae as in the Estonian species.

*Catenipora clausa* sp. nov.

Pl. X, figs 1, 2, 5

*Material.* Holotype SUP 75224; another specimen (SUP 78222) designated a paratype. Limestone breccia at the top of the Malachi's Hill Beds, north-east of Malachi's Hill.

*Description.* Corallum with frequent T-junctions and sometimes forming lacunae, a few being as small as 2.2–2.5 mm in longest dimensions (Pl. X, fig. 2); composed of moderately closely spaced meshwork of sinuous chains. Holotype measures approximately 65 by 40 mm across and 75 mm high; associated with *Grewingkia* sp. Up to 11 corallites in an individual rank. Offsets usually from midwall of a corallite, but rarely may also occur between adjacent corallites (Pl. X, fig. 1). Calice 1.5 mm deep. Corallites oval in cross section, typically from 1.5 to 1.9 mm in length and from 1.2 to 1.5 mm in width. Walls are usually rather thick, from 0.30 to 0.45 mm. Septal spines rarely seen to protrude beyond much thickened wall. "Balcken" structure may be seen in intercorallite wall. Tabulae are thin, usually complete, flat to gently sagging; in holotype from 14 to 20 in 5 mm. However paratype exhibits much more spaced widely tabulae, typically from 8 to 12 in 5 mm.

*Remarks.* *Catenipora clausa* differs from *C. cf. obliqua* in having small lacunae, and in having a thicker corallite wall.

*Catenipora* sp.

Pl. X, figs 6–7

*Material.* One specimen (SUP 78207) found recently by I. G. Percival from a limestone breccia towards the base of the Malongulli Formation at the "Kurrajongs" in the Licking Hole Creek area, near Walli.

*Description.* The moderately large silicified specimen exhibits closed, usually elongated meshes ranging from a minimum diameter of 3 to 9 mm to a maximum diameter of at least 25 mm. Corallites have a length of from 1.3 to 1.5 mm and a width of from 1.0 to 1.2 mm. Wall thickness is from 0.15 to 0.25 mm. Vertical rows of tiny septal spines may be seen in silicified interiors of the wall, and give a denticulate appearance to the inner wall of the corallites, as seen in transverse section. Tabulae are characteristically domed (less commonly flat), complete, with a vertical spacing of from 10 to 12 in 5 mm; very rarely seen to occur as incomplete elements.

*Remarks.* This distinctive species perhaps has closest resemblances to *C. wrighti* Klaamann, 1965, but this European late Ordovician species has mainly horizontal tabulae (Klaamann, 1965, 1966).

Genus HALYSITES Fischer von Waldheim 1813

*Type species.* *Tubipora catenularia* Linnaeus 1767.

*Halysites* sp.

Pl. X, figs 8–9

*Material.* Four specimens (SUP 78208–09, 78211, 78252) from limestone lens in the Angullong Tuff at Rodds Creek (Locality CO. 1/50 of Smith, 1966, pp. 245, 261).

*Description.* Mainly small fragmentary specimens with variable form. Some with small lacunae from 1 to 6 mm, others with more widely spaced lacunae, and a few apparently open chains. Ranks with moderately common T-junctions and offsets issuing from off the side wall of individual corallites. Both corallites and tubules well differentiated. Corallites have oval-shaped cross section mainly from 1.4 to 1.8 mm in length and from 1.0 to 1.2 mm in width. Tubules have quadrate outline, and are from 0.3 to 0.5 mm across. Wall is from 0.1 to 0.2 mm thick. Tubulae mainly horizontal; in corallites spaced from 10 to 13 in 5 mm, whereas in tubules from three to five per mm.

*Remarks.* This species is markedly different from *H. praecedens* Webby and Semeniuk from the upper part of the Clearview Limestone Member of the

Ballingoole Limestone (Bowen Park Group), exhibiting definite lacunae with more frequent branching of chains, and more closely spaced tabulae.

#### ACKNOWLEDGEMENTS

The work was aided by funds from the Australian Research Grants Committee (A.R.G.C. Grant No. E73/15102). Professor Dorothy Hill is thanked for her helpful criticism of the manuscript. Associate Professor G. H. Packham and Mr. I. G. Percival kindly contributed material collected by them.

#### References

- BASSLER, R. S., 1950.—Faunal lists and descriptions of Palaeozoic corals. *Geol. Soc. Am. Mem.*, 44 : 1–315.
- BILLINGS, E., 1859.—Fossils of the Chazy Limestone, with descriptions of new species. *Can. Nat. Geol.*, 4 : 426–470.
- DUNCAN, H., 1956.—Ordovician and Silurian coral faunas of western United States. *Bull. U.S. Geol. Surv.*, 1021–F : 209–236.
- DZIUBO, P. S., 1962.—Novyi rod tabuljat iz ordovika gornogo Altaja. *Tr. Sib. Nauchnoizsled. Inst. Geol., Geofiz. Miner. Ser.*, 23 : 154–155.
- , 1965.—Sistematicheskij i biostratigraficheskij obzor ordovikskich tabuljat i geolilitid gornogo Altaja i gornoj Shorii. In Sokolov, B. S., and Dubatolov, V. N. (eds), *Tabuljatomorfnye korally ordovika i silura SSSR*. Moscow : Institut Geologii i Geofiziki, Sibirskoe Otdelenie, Akademia Nauk : 29–34.
- EDWARDS, H. M., and HAIME, J., 1850.—*A monograph of the British fossil corals...* Part I. Introduction. London : Palaeontographical Society. lxxxv+71 p.
- , and ———, 1851.—Monographie des Polyptiers fossiles des Terrains palaeozoiques. *Arch. Mus. Hist. Nat.*, 5 : 1–502.
- ETHERIDGE, R., 1909.—An organism allied to *Mitcheleania* Wethered of the Carboniferous Limestone, in the upper Silurian of Malongulli. *Rec. Geol. Surv. N.S.W.*, 8 : 308–311.
- FISCHER-BENZON, R. von, 1871.—Mikroskopische untersuchungen über die Struktur der *Halysites*-Arten. *Abh. Naturwiss. Ver. Hamburg*, 5 : 1–31.
- FISCHER VON WALDHEIM, G., 1813.—*Zoognosia tabulis synopticus illustrata*. 3rd ed. Vol. 1. Moscow. i–xiv, 465 p.
- FISHER, D. W., 1962.—Small conoidal shells of uncertain affinities. In Moore, R. C. (ed), *Treatise on invertebrate paleontology*. Part W. Miscellaneous : W98–143. Lawrence, Kansas : University of Kansas Press.
- GOLDFUSS, G. A., 1829.—*Petrefacta Germaniae*. Teil 1. Düsseldorf : 77–164.
- HILL, D., 1940.—The Silurian Rugosa of the Yass-Bowling District, N.S.W. *Proc. Linn. Soc. N.S.W.*, 65 : 388–420.
- , 1953.—The Middle Ordovician of the Oslo region, Norway. 2. Some rugose and tabulate corals. *Nor. Geol. Tidsskr.*, 31 : 143–168.
- , 1955.—Ordovician corals from Ida Bay, Queenstown and Zeehan, Tasmania. *Pap. Proc. R. Soc. Tasm.*, 89 : 237–254.
- , 1957.—Ordovician corals from New South Wales. *J. Proc. R. Soc. N.S.W.*, 91 : 97–107.
- , and STUMM, E. C., 1956.—*Zoantharia Tabulata*. In Moore, R. C. (ed), *Treatise on invertebrate paleontology*. Part F. Coelenterata : F444–476. Lawrence, Kansas : University of Kansas Press.
- KIAER, J., 1930.—Den fossilforende ordovicisk-siluriske lagrekke pa stord. *Bergen Mus. Aarbok Naturvitensk. Rekke*, 11 : 48–49.
- KLAAMANN, E., 1965.—Tabulata (pp. 422–428). In Kaljo, D., and Klaamann, E. The fauna of the Portrane Limestone. III. The Corals. *Bull. Brit. Mus. (Nat. Hist.) Geol.*, 10 : 415–434.
- , 1966.—*Inkommunikatnyi tabuljaty Estonii*. Tallinn : Eesti NSV Teaduste Akademia Geologia Institut : 1–96.
- , 1969.—*Adaverina*—Novoe nazvanie dlja *Syringocystis* Klaamann, 1966 (Tabuljaty). *Izv. Akad. Nauk. Est. SSR, Ser. Geol.*, 18 : 88.
- LAMARCK, J. B. P. A. de M., 1816.—*Histoire naturelle des animaux sans vertèbres*. Vol. 2. Paris. 568 p.
- LAMBE, M. L., 1899.—A revision of the genera and species of Canadian Palaeozoic corals : Part I. The Madreporaria Perforata and the Alcyonaria. *Contrib. Can. Paleontol.*, 4 : 1–96.
- LELESHUS, V. L., 1972.—*Silurijskie tabuljaty Tadžikistana*. Dushanbe : Institut Geologi, Akademia Nauk Tadžikskoi SSR : 1–85.
- LINNEAUS, C., 1767.—*Systema Naturae*. 12th ed. Vol. 1. Part 2. Stockholm : 533–1327.

- MCLEAN, R. A., 1974.—The Geology of the Regan's Creek area, near Cargo, central New South Wales. *PROC. LINN. SOC. N.S.W.*, 98 : 196–221.
- NORFORD, B. S., 1962.—The Silurian fauna of the Sandpile Group of northern British Columbia. *Bull. Geol. Surv. Can.*, 78 : 1–51.
- OKULITCH, V. J., 1937.—Notes on *Fletcheria incerta* (Billings) and *Fletcheria sinclairi* n. sp. *Trans. R. Can. Inst.*, 21 : 313–316.
- OLIVER, W. A. Jr., 1966.—Description of dimorphism in *Striatopora flexuosa* Hall. *Palaeontology*, 9 : 448–454.
- , 1968.—Some aspects of colony development in corals. *Paleontol. Soc. Mem.*, 2 [J. *Paleontol.*, 42] : 16–34.
- RICHARDS, R. P., 1974.—Ecology of the Cornulitidae. *J. Paleontol.*, 48 : 514–523.
- SEMENIUK, V., 1970.—The Lower-Middle Palaeozoic stratigraphy of the Bowan Park area, central-western New South Wales. *J. Proc. R. Soc. N.S.W.*, 103 : 15–30.
- , 1973.—The stratigraphy of the Bowan Park Group, New South Wales. *J. Proc. R. Soc. N.S.W.*, 105 : 77–85.
- SINCLAIR, G. W., 1961.—Notes on some Ordovician corals. *Bull. Geol. Surv. Can.*, 80 : 9–18.
- SMITH, R. E., 1966.—The geology of Mandurama-Panuara. *J. Proc. R. Soc. N.S.W.*, 98 : 239–262.
- SOKOLOV, B. S., 1950.—Silurijskie korally zapada Sibirskoj platformy. *Vopr. Paleontol.*, 1 : 211–242.
- , 1951.—Tabulyaty paleozoya Evropejskoi chasti SSSR. Ch. 1. Ordovik Zapadnogo Urala i Pribaltiki. *Tr. Vses. Nauchnoizsled. Geol. Razved. Inst.*, n.s., 48 : 1–132.
- , 1955.—Tabuljaty paleozoya Evropejskoj chasti SSSR. Vvedenie. *Tr. Vses. Nauchnoizsled. Geol. Razved. Inst.*, n.s., 85 : 3–328.
- , 1962.—Podklass Tabulata. Tabuljaty. In Orlov, Y. A. (ed.), *Osnovy paleontologii*. II (pp. 192–265). Moscow : Akademia Nauk.
- , and MIRONOVA, N. V., 1959.—O novom rode ordovikskiej korallov Zapadnoj Sibiri i Severnogo Kazachstana. *Dokl. Akad. Nauk. SSSR.*, 129 : 1150–1153.
- STASIŃSKA, A., 1967.—Tabulata from Norway, Sweden and from the erratic boulders of Poland. *Palaeontol. Pol.*, 18 : 1–112.
- WEBBY, B. D., 1969.—Ordovician stromatoporoids from New South Wales. *Palaeontology*, 12 : 637–662.
- , 1971.—The new Ordovician genus *Hillophyllum* and the early history of rugose corals with acanthine septa. *Lethaia*, 4 : 158–168.
- , 1972.—The rugose coral *Palaeophyllum* Billings from the Ordovician of central New South Wales. *PROC. LINN. SOC. N.S.W.*, 97 : 150–157.
- , 1975.—Succession of Ordovician coral and stromatoporoid faunas from central-western New South Wales, Australia. In Sokolov, B. S. (ed.), *Ancient Cnidaria*. Vol. II. Novosibirsk : Nauka : 57–68.
- , 1976.—The Ordovician System in South-Eastern Australia. In Bassett, M. G. (ed.), *The Ordovician System*. Cardiff : University of Wales Press : 417–446.
- , and SEMENIUK, V., 1969.—Ordovician halysitid corals from New South Wales. *Lethaia*, 2 : 345–360.
- , 1971.—The Ordovician coral genus *Tetradium* Dana from New South Wales. *PROC. LINN. SOC. N.S.W.*, 95 : 246–259.
- ZITTEL, K. A., 1876.—*Palaeozoologie*. Vol. I. Munich. 765 p.

## EXPLANATION OF PLATES

## PLATE II

Figs 1–7. *Bajgolia caespitosa* sp. nov., lower part of Cliefden Caves Limestone. 1–2. Transverse-oblique sections from “lower coral” unit at Licking Hole Creek, SUP 78191, × 4. 3. Longitudinal section of holotype from “mixed fauna” unit east of Fossil Hill, SUP 78179, × 4. 4. Longitudinal section from “mixed fauna” unit west of Boonderoo shearing shed, SUP 78183, × 4. 5. Transverse section of holotype from “mixed fauna” unit east of Fossil Hill, SUP 78179, × 7. 6–7. Transverse sections of SUP 78181 from “mixed fauna” unit west of Boonderoo shearing shed, showing details of bipartite division, × 7.

Fig. 8. *Bajgolia* cf. *caespitosa* sp. nov., transverse-oblique section of part of large colony probably from lower part of Cliefden Caves Limestone (precise locality and horizon not known), SUP 78190, × 4.

Fig. 9. *Bajgolia furcata* sp. nov., transverse-oblique section of branch of colony from “lower coral” unit, lower part of Cliefden Caves Limestone, Fossil Hill; holotype, SUP 78155, × 4.

## PLATE III

Figs 1-11. *Bajgolia gracilis* (Hill, 1957), silicified specimens from Quondong Limestone (Bowen Park Group), Quondong,  $\times 3$ . 1. Lateral view of exterior of branch, SUP 78282. 2. Lateral view of incomplete branch, SUP 78281. Note fine transverse growth lines on external surface. 3-4. Views of lateral and top surfaces of branching colony, SUP 78286. 5-7. Exterior views of two sides and top of flabellate branching colony, SUP 78280. Note fine transverse growth lines on exterior. 8-9. Oblique lateral view of exterior, and longitudinal view of interior of colony, SUP 78283. Note bipartite division in Fig. 9. 10. View of interior of branch showing bipartite division, SUP 78287. 11. View of interior of branch fragment exhibiting few divisions, SUP 78284.

Fig. 12. *Bajgolia furcata?* sp. nov., external view of part of branch; SUP 28153 from upper part of Regan's Creek Limestone,  $\times 3$ .

## PLATE IV

Figs 1, 4-6. *Bajgolia furcata* sp. nov., from "lower coral" unit, lower part of Cliefden Caves Limestone, Fossil Hill. 1. Colony arising off a reptant base of attachment with a bryozoan, SUP 78154,  $\times 4$ . 4. Transverse-oblique section of SUP 78151,  $\times 4$ . 5. Longitudinal section of holotype, SUP 78155,  $\times 4$ . 6. Transverse section of SUP 78152,  $\times 7$ . Note individual corallites in process of bipartite division.

Figs 2-3. *Bajgolia* cf. *contigua* (Hill, 1955). Longitudinal-oblique and transverse-oblique sections of SUP 78177 from "lower coral" unit, lower part of Cliefden Caves Limestone,  $\times 4$ . Note bryozoan intergrowth.

Fig. 7. *Bajgolia gracilis* (Hill, 1957) longitudinal-oblique section of partially silicified branch from Davys Plains Limestone Member, Daylesford Limestone (Bowen Park Group), SUP 78217,  $\times 4$ .

Figs 8-9. *Bajgolia minor* sp. nov., longitudinal and oblique sections of holotype SUP 78164 from "lower coral" unit, lower part of Cliefden Caves Limestone, Fossil Hill,  $\times 4$ . Note intimate intergrowth association with bryozoan.

## PLATE V

Figs 1-5. *Eofletcheria hadra* sp. nov., from lower part of Cliefden Caves Limestone. 1-4. From the "mixed fauna" unit west of Boonderoo shearing shed. 1. Longitudinal section showing paratype SUP 78223, and in bottom right corner part of holotype SUP 78185,  $\times 4$ . 2-3. Holotype, SUP 78185. 2. Transverse section,  $\times 4$ . 3. Transverse section showing detail of wall with radially aligned fibrous tissue,  $\times 7$ . 4. Transverse section of paratype SUP 78184,  $\times 4$ . 5. Longitudinal section showing encrustation of colony on *Tetradium cribriforme* (Etheridge), SUP 78163,  $\times 4$ , from "lower coral" unit, Fossil Hill.

Figs 6-7. *Bajgolia?* sp. from "*Aulopora*" unit, upper part of Cliefden Caves Limestone, Licking Hole Creek. 6. Transverse section of SUP 78194,  $\times 4$ . 7. Longitudinal section of SUP 78196,  $\times 4$ .

Figs 8-9. *Bajgolia?* aff. *grandis* sp. nov., from "*Aulopora*" unit, upper part of Cliefden Caves Limestone, Licking Hole Creek. 8. Longitudinal-oblique section of SUP 78195,  $\times 4$ . 9. Transverse section of SUP 78195,  $\times 4$ .

## PLATE VI

Figs 1-2. *Bajgolia?* *grandis* sp. nov.,  $\times 4$ . Longitudinal section of holotype, SUP 66154, from "*Aulopora*" unit, upper part of Cliefden Caves Limestone, Licking Hole Creek. 2. Transverse section of paratype, SUP 78205, from "E-horizon", middle part of Cliefden Caves Limestone, Licking Hole Creek.

Fig. 3. *Bajgolia* cf. *furcata* sp. nov., longitudinal section of SUP 78220 from lower part of Reedy Creek Limestone, north of Molong,  $\times 4$ .

Fig. 4. *Eofletcheria hadra* sp. nov., longitudinal section of paratype SUP 78223 from "mixed fauna" unit, lower part of Cliefden Caves Limestone, west of Boonderoo shearing shed,  $\times 4$ .

Figs 5-6. *Aulopora* sp. A,  $\times 4$ . SUP 78225 from limestone, lower part of Goonumbla Volcanics, Currajong Park near Gunningbland. 5. Upturning corallites from a reptant base. 6. Section of colony approximately at right angles to that shown in Fig. 5.

Fig. 7. *Bajgolia?* sp., transverse-oblique section from "*Aulopora*" unit, upper part of Cliefden Caves Limestone, Licking Hole Creek, SUP 78196,  $\times 4$ .



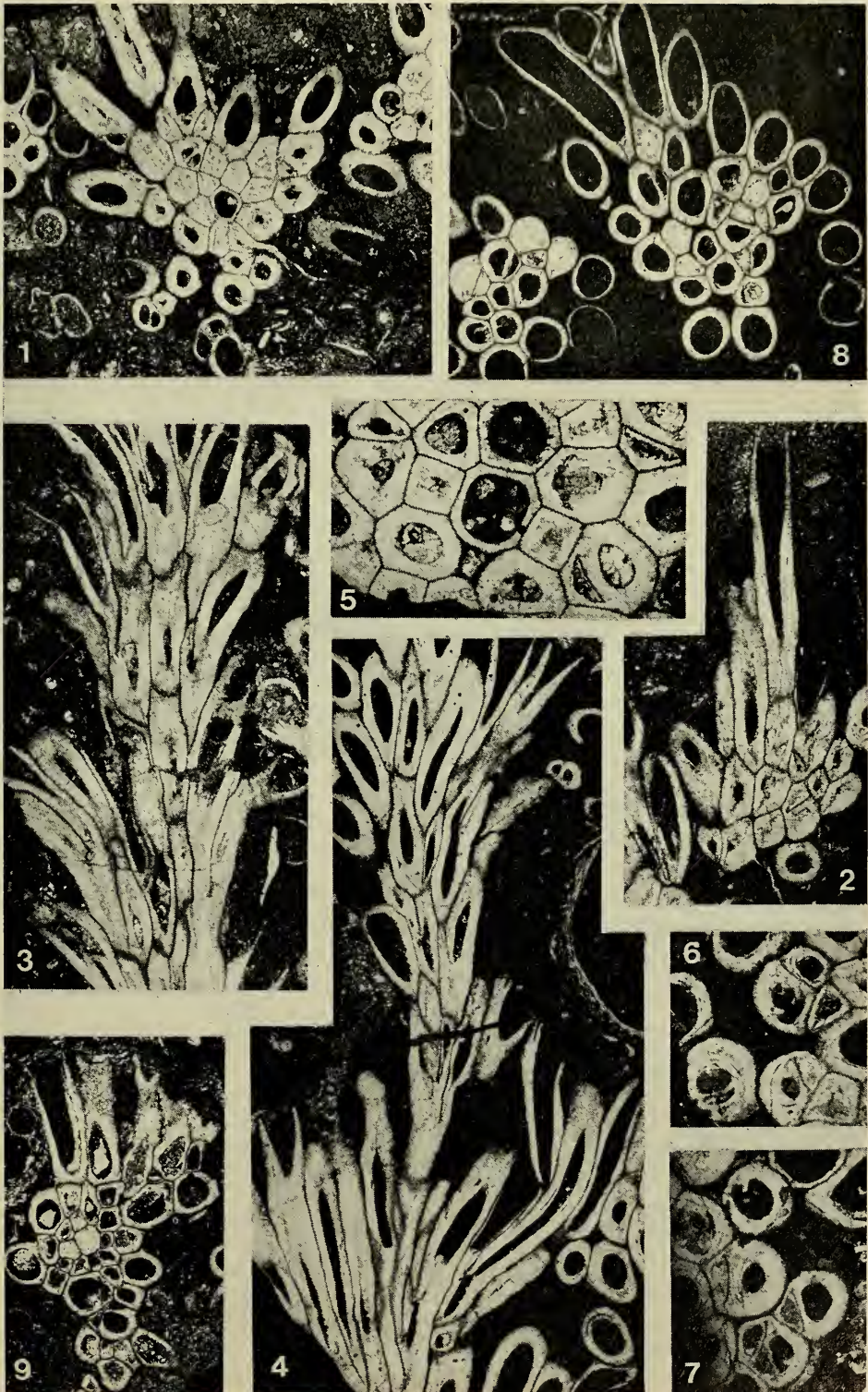



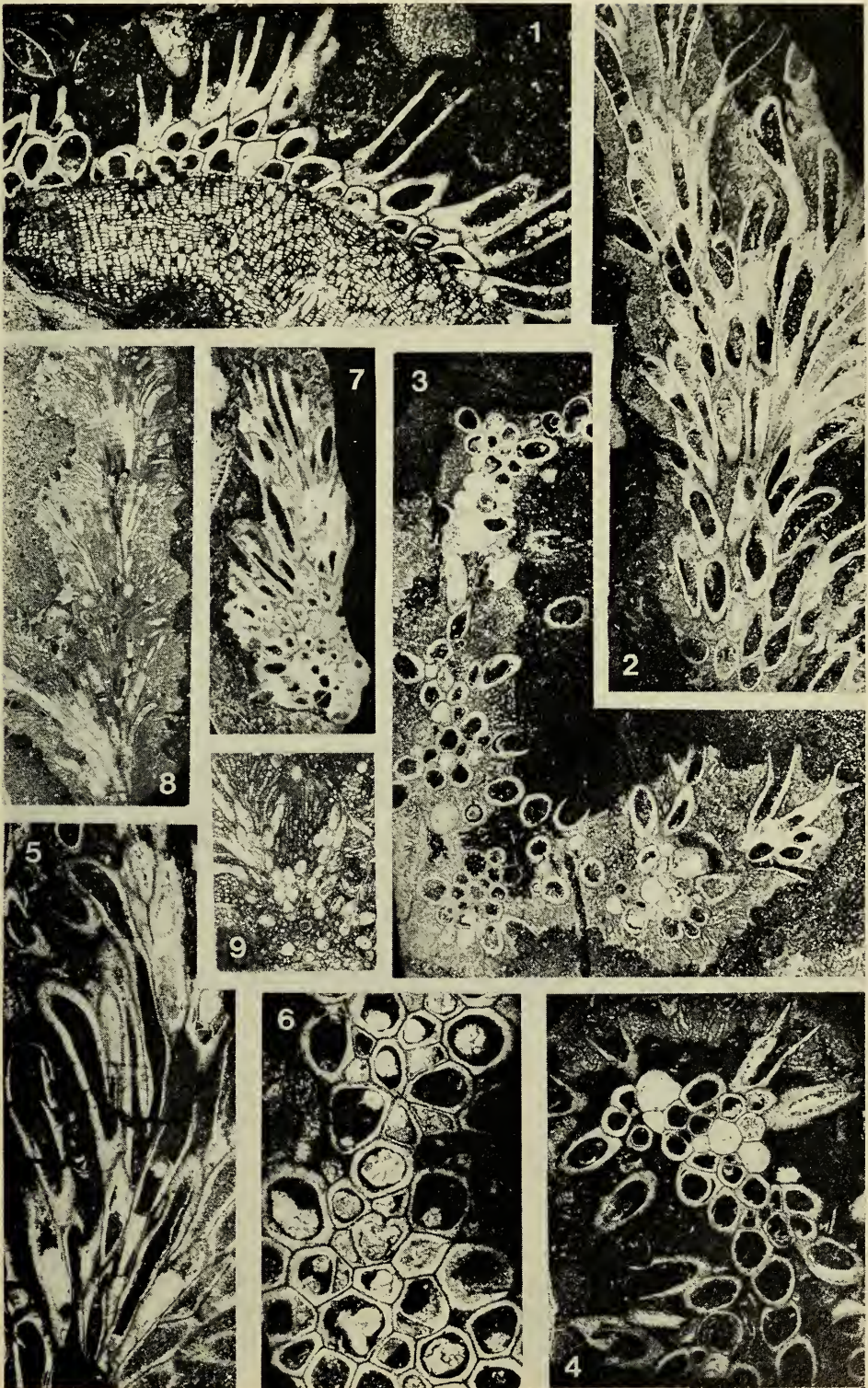

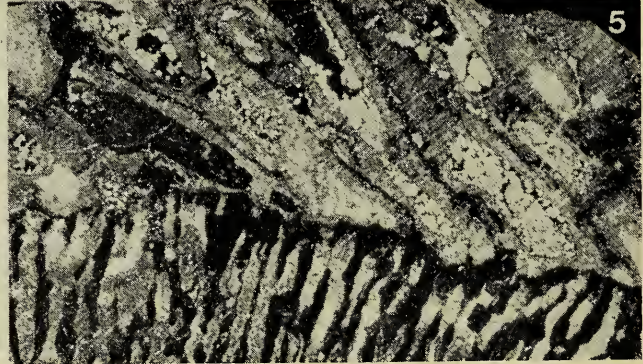
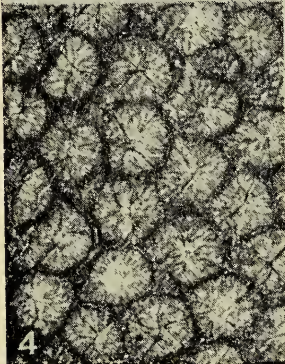
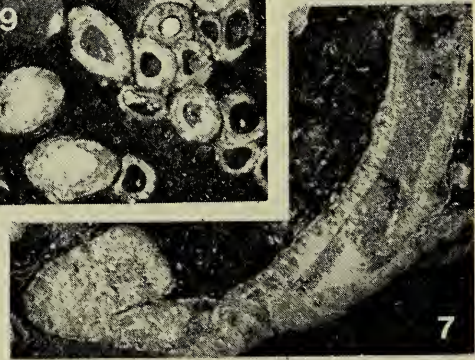
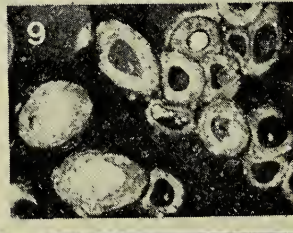
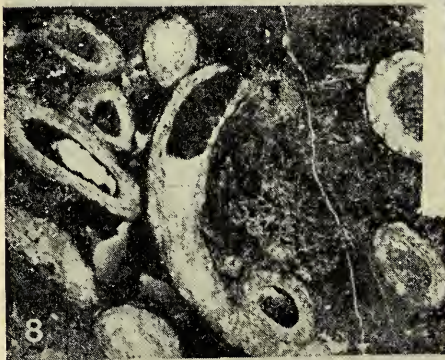
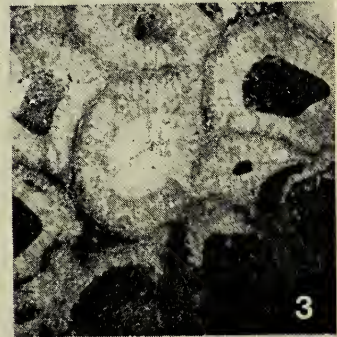
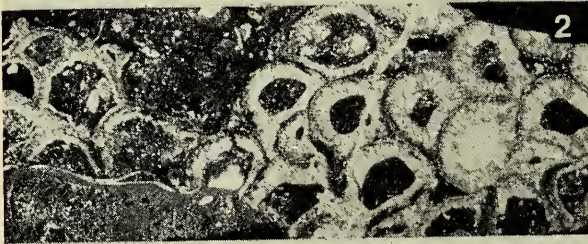
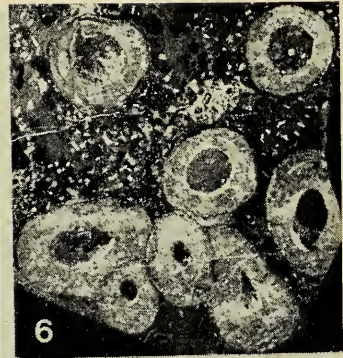

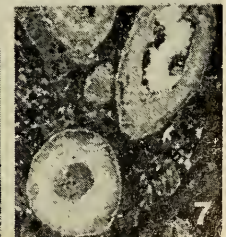
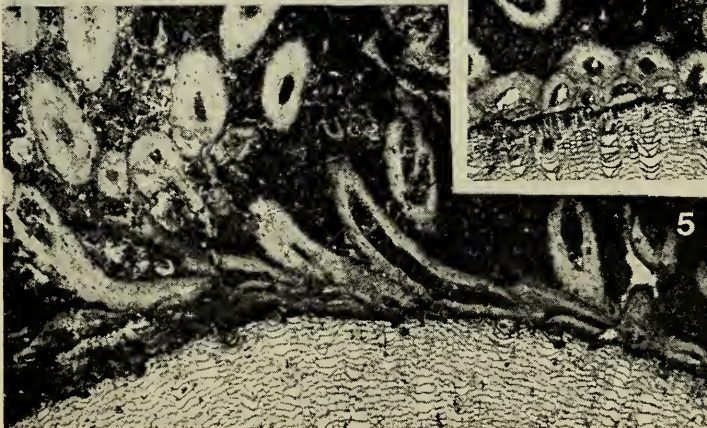
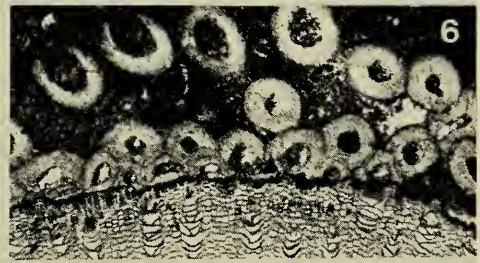
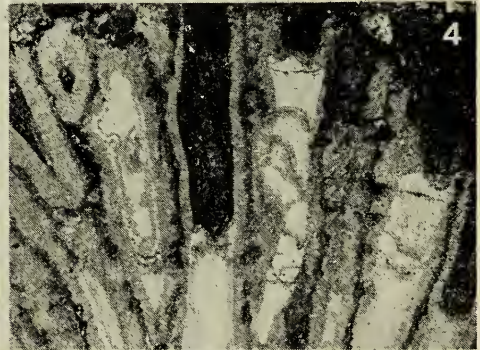
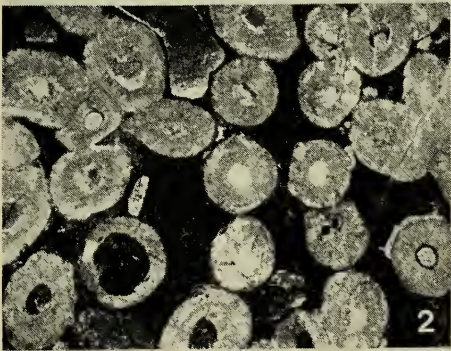

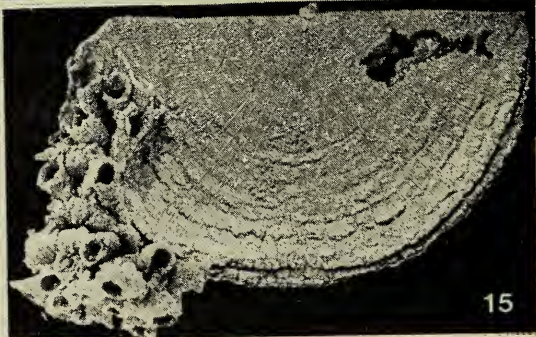
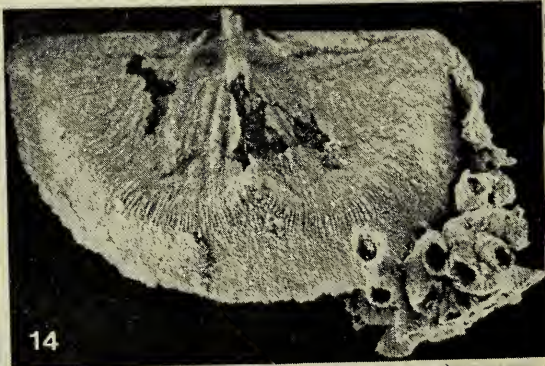
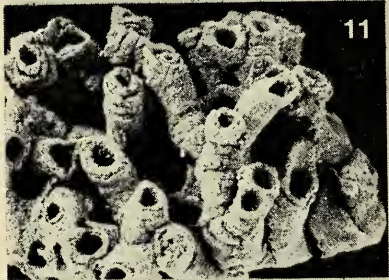
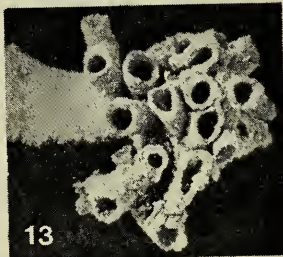
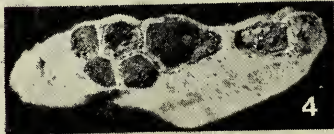
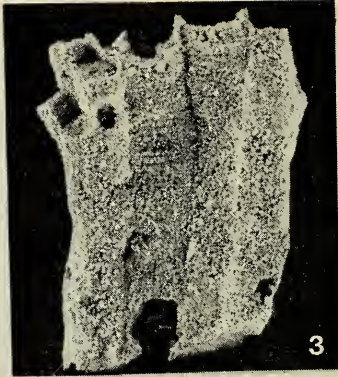

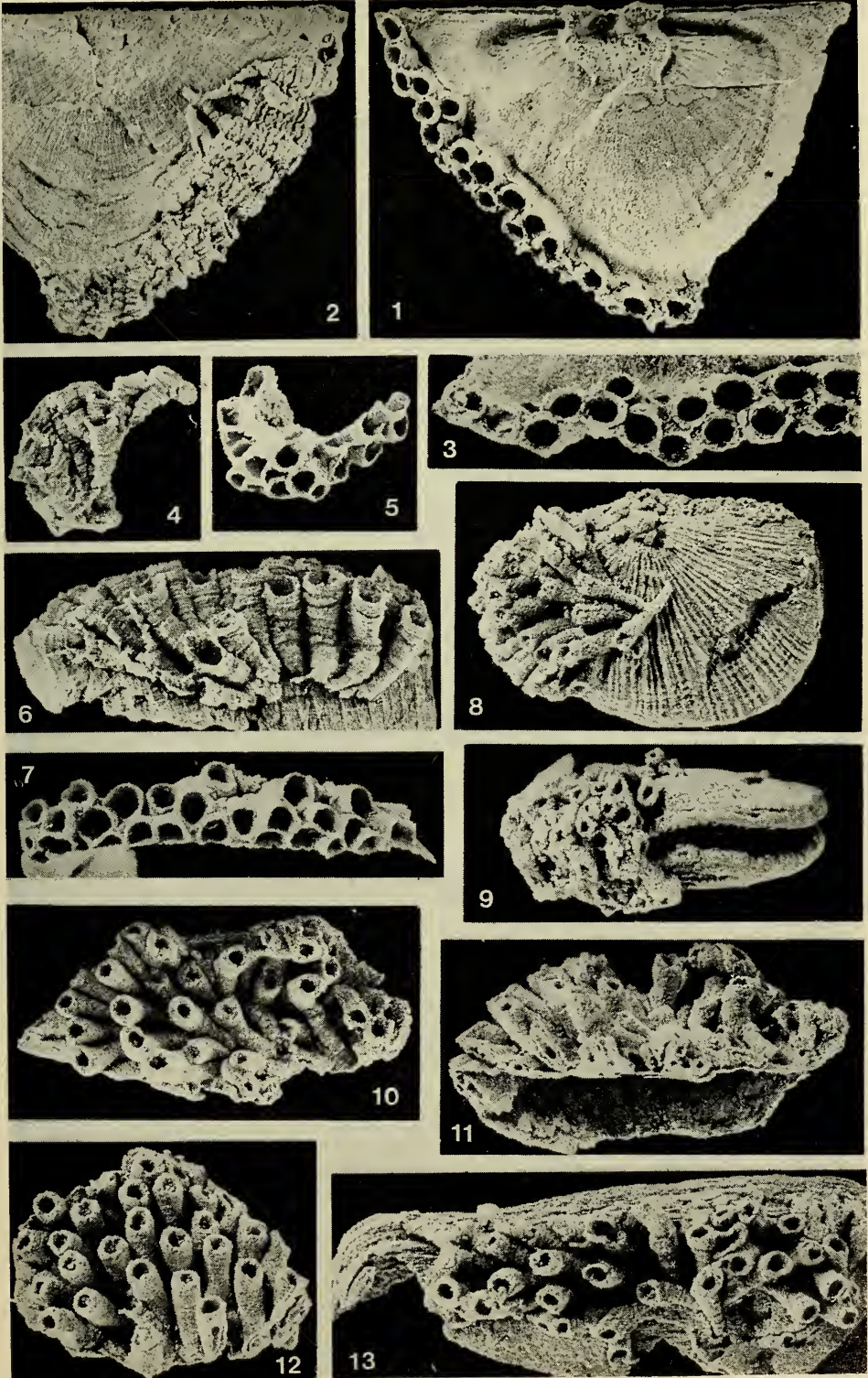

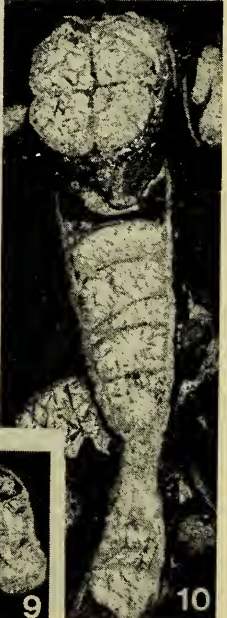
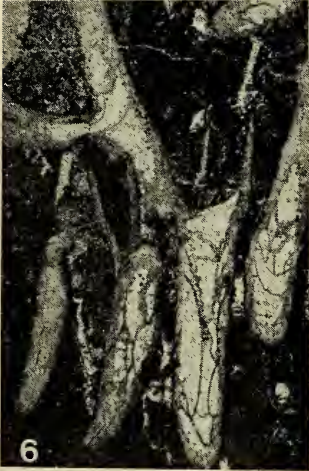
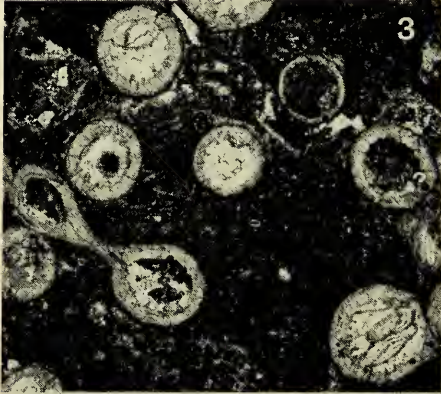
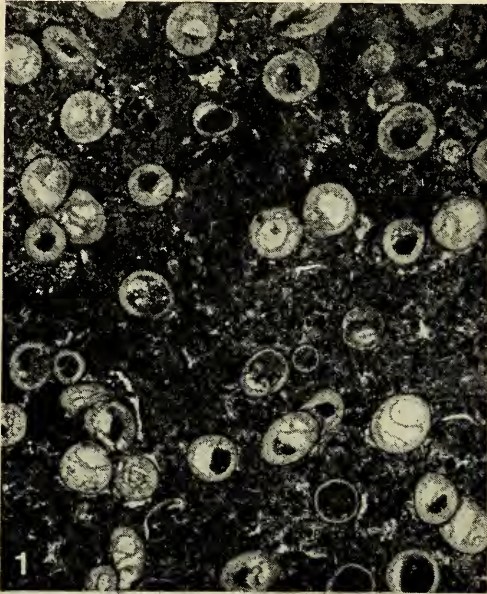



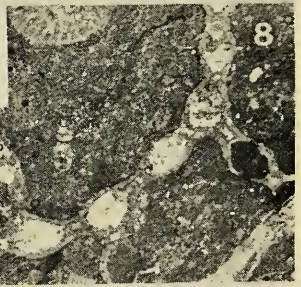
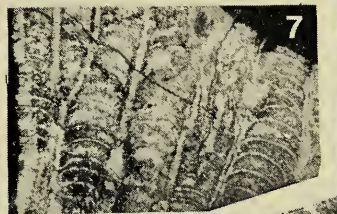
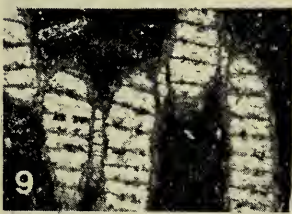
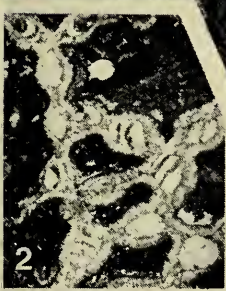
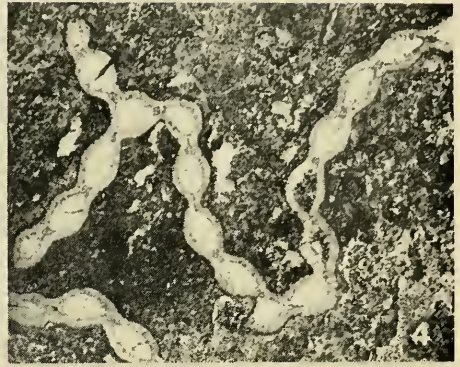
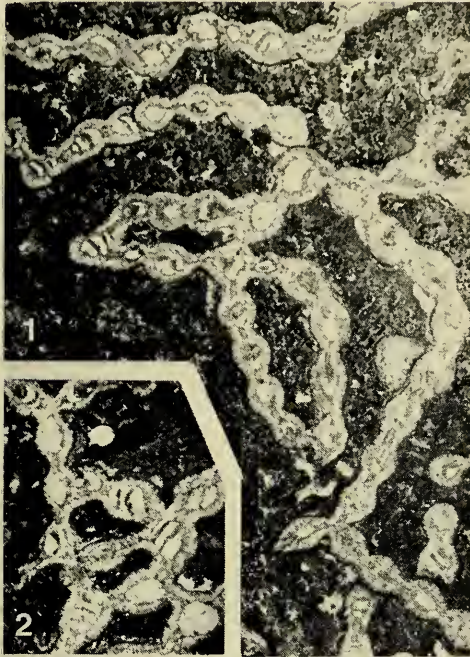



## PLATE VII

Figs 1-10. *Fletcheria? stipulosa* sp. nov., paratypes from Gerybong Limestone Member, Daylesford Limestone (Bowen Park Group) at Quondong. (Figs 1-4, 10,  $\times 2.5$ ; Figs 5-9,  $\times 3$ .) 1. SUP 78271, oblique view of quadripartite increase. 2. SUP 78272, external view of four-fold division. 3-4. SUP 78270, side and top views of colony exhibiting chain-like form. 5. SUP 78277, internal view of dividing wall between two corallites and horizontal tabulae. 6-9. Stages in development of four offsets. 6. SUP 78273, initial stage of division with fusion axially of four septa-like walls. 7. SUP 78274. 8. SUP 78275. 9. SUP 78276, showing almost complete separation of individual offsets. 10. Lateral view of SUP 78278, showing division, an exterior with fine transverse growth lines and cut-away exhibiting interior with near horizontal tabulae.

Figs 11-12. *Bajgolia? grandis* sp. nov.,  $\times 2$ . 11. Oblique view of SUP 78291 from 'Island' unit, upper part of Cliefden Caves Limestone, Licking Hole Creek. 12. Side view of exterior of SUP 26284 from Quondong Limestone (Bowen Park Group), Quondong.

Figs 13-15. *Aulopora* sp., views of colony encrusting antero-lateral margin of brachial valve of *Sowerbyella*. SUP 77270,  $\times 2.5$ , from "Island" unit, upper part of Cliefden Caves Limestone, Licking Hole Creek.

## PLATE VIII

Figs 1-7. *Aulopora walliensis* sp. nov., silicified colonies encrusting brachiopod *Trigrammaria*. 1-3. Holotype SUP 78293 from "Island" unit, upper part of Cliefden Caves Limestone, Licking Hole Creek. 1-2,  $\times 2$ ; 3,  $\times 3$ . 4-5. Small colony SUP 78295,  $\times 2.5$ . 4. Lateral view. 5. Top view showing alveoloid corallites. 6-7. SUP 78294,  $\times 2.5$ . 6. Lateral view showing prominent fine transverse growth lines. 7. Top view exhibiting two to three rows of cylindrical to alveoloid corallites. Figured paratypes are from Quondong Limestone (Bowen Park Group); SUP 78295 from Quondong, and SUP 78294 from Paling Yards Creek.

Figs 8-9. *Aulopora* sp. C. Brachial and anterior views of brachiopod *Holtedahlina* showing silicified encrusting colony, SUP 78291,  $\times 2.5$ . "Island" unit, upper part of Cliefden Caves Limestone, Licking Hole Creek.

Figs 10-13. *Aulopora* sp. B,  $\times 2.5$ , from "Island" unit, upper part of Cliefden Caves Limestone, Licking Hole Creek. 10-11. Top and side views of silicified colony encrusting *Sowerbyites*, SUP 78298. 12. Oblique view of silicified colony, SUP 78297. 13. Top view of silicified colony encrusting brachiopod *Eodinobolus?*, SUP 78296.

## PLATE IX

Figs 1-8. *Adaverina acritos* sp. nov., from limestone, top of Malachi's Hill Beds, north-east of Malachi's Hill; holotype SUP 78214. 1. Transverse section,  $\times 4$ . 2. Longitudinal section,  $\times 4$ . 3. Transverse section,  $\times 7$ . 4. Longitudinal section,  $\times 4$ . 5. Longitudinal section,  $\times 4$ . 6. Longitudinal section,  $\times 4$ . 7. Longitudinal-oblique section,  $\times 4$ . 8. Longitudinal section,  $\times 7$ .

Figs 9-10. *Fletcheria? stipulosa* sp. nov., transverse and longitudinal views of holotype SUP 78215,  $\times 4$ , from Gerybong Limestone Member, Daylesford Limestone (Bowen Park Group), Quondong.

## PLATE X

Figs 1-3, 5. *Catenipora clausa* sp. nov., from limestone breccia, top of the Malachi's Hill Beds, north-east of Malachi's Hill,  $\times 4$ . 1-2. Transverse sections of holotype SUP 75224 (associated with *Grewingkia* sp., SUP 75223). 3. Longitudinal section of paratype SUP 78222. 5. Longitudinal section of holotype SUP 75224.

Fig. 4. *Catenipora* cf. *obliqua* (Fischer-Benzon, 1871) from limestone breccia, top of Malachi's Hill Beds, north-east of Malachi's Hill,  $\times 4$ ; transverse section of SUP 29103.

Figs 6-7. *Catenipora* sp. from limestone breccia near base of Malongulli Formation, "Kurrajongs", Licking Hole Creek, SUP 28207,  $\times 4$ . 6. Transverse section showing large lacunae. 7. Longitudinal section.

Figs 8-9. *Halysites* sp., from limestone lens in Angullong Tuff, Rodds Creek,  $\times 5$ . 8. Transverse section of SUP 78252. 9. Longitudinal section of SUP 78209.



Copies of the PROCEEDINGS OF THE LINNEAN SOCIETY OF NEW SOUTH WALES (with the exception of a few volumes and Parts) may be purchased from the Society, Science Centre, 35-43 Clarence Street, Sydney, N.S.W., 2000.

Current charges for the PROCEEDINGS are :

Volumes—\$16.00 each for 1st Series (Volumes 1-10) ; \$11.00 each for 2nd Series (Volumes 11-20) and all subsequent volumes.

Parts—\$5.00 each for all back parts ; \$4.00 each for current Parts. For volumes of 5 or 6 Parts, \$1.00 each for first and last Parts.

Prices do not include postage.

Subscription to the PROCEEDINGS—\$20.00 per volume, plus \$2.50 postage—\$22.50.

All prices are in Australian currency.

These charges may be revised from time to time, and inquiries should be addressed to The Secretary, Linnean Society of New South Wales, Science Centre, 35-43 Clarence Street, Sydney, N.S.W., 2000, Australia.

The Society's PROCEEDINGS are printed and published for the Society by the Australasian Medical Publishing Co., Ltd., 71-79 Arundel Street, Glebe, N.S.W., 2037.

# Proceedings, Volume 101, Part 3, 1977

## CONTENTS

	Page
ALLEN, GERALD R. A new species of Scorpaenid fish (Scorpaenidae) from Western Australia .. .. .	145
SCHICHA, E. Immature stages of three mite species (Acari : Phytoseiidae) from apple in Australia .. .. .	149
SUDZUKI, MINORU., and TIMMS, B. V. A new species of <i>Brachionus</i> (Rotifera) from the Myall Lakes, New South Wales .. .. .	162
WEBBY, B. D. Upper ordovician tabulate corals from Central- Western New South Wales .. .. .	167

# Proceedings of the Linnean Society of New South Wales

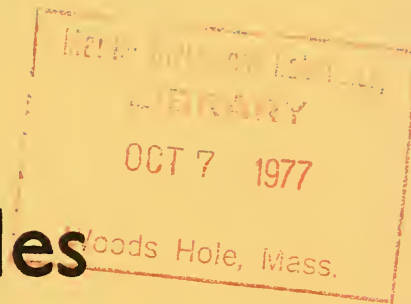

Issued 28th July, 1977

**VOLUME 101**  
**PART 4**  
No. 448

# The Linnean Society of New South Wales

Founded 1874. Incorporated 1884

“ For the cultivation and study of the science of Natural History  
in all its branches ”

## OFFICERS AND COUNCIL, 1976-77

### *President*

Barbara G. Briggs, Ph.D.

### *Vice-Presidents*

H. G. Cogger, M.Sc., Ph.D. ; D. W. Edwards, B.Sc.Agr. ;  
P. J. Stanbury, Ph.D. ; T. G. Vallance, B.Sc., Ph.D.

### *Honorary Treasurer*

Joyce W. Vickery, M.B.E., D.Sc., F.L.S.

### *Secretary*

Ruth J. Inall

### *Council*

Barbara G. Briggs, Ph.D.  
H. G. Cogger, M.Sc., Ph.D.  
D. W. Edwards, B.Sc.Agr.  
L. A. S. Johnson, D.Sc.  
D. McAlpine, M.Sc., Ph.D.  
Helene A. Martin, Ph.D.  
Lynette A. Moffat, B.Sc., Ph.D.  
P. Myerscough, M.A., D. Phil.  
J. Pickard, B.Sc.Agr.  
A. Ritchie, B.Sc., Ph.D.

F. W. E. Rowe, B.Sc., Ph.D., M.I.Biol.,  
F.L.S.  
P. J. Stanbury, Ph.D.  
N. G. Stephenson, M.Sc., Ph.D.  
T. G. Vallance, B.Sc., Ph.D.  
Joyce W. Vickery, M.B.E., D.Sc., F.L.S.  
J. T. Waterhouse, B.Sc., M.Sc. (N.S.W.),  
M.Sc. (R'ding), F.L.S.  
B. D. Webby, M.Sc., Ph.D.  
A. J. T. Wright, B.Sc., Ph.D.

### *Auditors*

W. Sinclair and Company, Chartered Accountants

*Linnean Macleay Lecturer in Microbiology, University of Sydney*

K. Y. Cho, Ph.D.

### *Librarian*

Constance B. McKay, B.A., A.L.A.A.

The Society's Headquarters are in Science Centre, 35-43 Clarence Street, Sydney,  
N.S.W. 2000, Australia



NEW RECORDS AND SPECIES OF *LAELAPS* AND ALLIED GENERA  
FROM AUSTRALASIA (ACARI: DERMANYSIIDAE). PART 2

ROBERT DOMROW\*

[Accepted for publication 21st September 1976]

*Synopsis*

*Andreacarus balanites*, n. sp., figured and described from a bandicoot, *Peroryctes longicauda* (Peramelidae), in New Guinea, is the first extra-Australian member of the *radfordi* species-group.

*Thadeua*, n. nom., is proposed for *Australolaelaps* Womersley, preoccupied by *Australolaelaps* Girault (Hymenoptera). *T. serrata*, n. sp., is figured and described from the swamp wallaby, *Wallabia bicolor* (Macropodidae), in Victoria.

Interesting new host-records and considerable extensions of range are recorded for thirty more species in the following sixteen dermanyssid genera: *Andreacarus*, *Gymnolaelaps*, *Laelapsella*, *Mesolaelaps*, *Haemolaelaps*, *Androlaelaps*, *Laelaps*, *Neolaelaps*, *Domrownyssus*, *Trichosurolaelaps*, *Thadeua*, *Bewsiella*, *Ichoronyssus*, *Macronyssus*, *Ornithonyssus*, and *Pneumonyssus*. Seventeen previously unknown stages (all the seldom seen male and immatures) are figured and described from this material.

INTRODUCTION

Dermanyssid mites have utilized all manner of habitats as free-living predators and parasites, but, despite the resultant structural plasticity, they have retained the stable ontogeny (developmental morphology) that is so characteristic of mesostigmatic mites in general (Evans and Till, 1965).

Short series of parasitic members of the family frequently contain only females, but males, both nymphal stages, and larvae are seldom collected, apparently being nest-dwellers which feed only temporarily, if at all, on the host (Evans and Till, 1965). Consequently, long series of mites from some common small mammals, mostly in eastern Australia, and other recent accessions, have yielded a useful variety of undescribed stages of species largely known only from females. These are studied below, together with new records of related species.

Suprageneric taxa, morphological terms, and setal signatures follow Evans and Till (1965, 1966), except for the tarsi of legs II-IV (Evans, 1969). The term "holotrichous" implies the situation in typical free-living dermanyssids, see Fig. 35. Measurements are in micrometres, each division on the scales representing 100  $\mu$ m. Hosts are given after Laurie and Hill (1954), Leach (1958), and Ride (1970).

GENUS *ANDREACARUS* Radford

*Andreacarus* Radford, 1953, *Parasitology*, 42: 240. Type-species *A. petersi* Radford, 1953.

*Andreacarus balanites*, n. sp.

(Figs 1-2)

*Types.* Holotype ♀ and one paratype ♀ from bandicoot, *Peroryctes longicauda* (Peters and Doria) (Marsupialia: Peramelidae), Uinba, Kubor Range, P.N.G., 19.vi.1963, W. B. Hitchcock. Holotype in Australian National Insect Collection, CSIRO, Canberra; paratype in author's Institute.

*Female.* Basis capituli (Fig. 2) longer than wide, with setae *c* reaching well beyond its sides. Deutosternum with six rows of multiple denticles. Hypostome with setae  $h_3 > h_1 > h_2$ . Labial cornicles small, but fully formed. Labrum narrow, tapered in distal third. Epistome of uncertain outline, but with dendritic

\* Queensland Institute of Medical Research, Brisbane, Queensland 4006.

submarginal texture as in *Haemolaelaps calypso* Domrow, 1966a. Palpi (trochanter-tibia) holotrichous; seta  $al_1$  on genu blunt. Tarsus shown diagrammatically; claw bifid. Chelicerae slender, but fully formed. Movable digit bidentate, apart from tip. Fixed digit edentate, slightly shorter than slender pilus dentilis. Corona weak; setule and pore present.

Idiosoma 765 long when figured, but now 735 due to resumption of more normal contours by well sclerotized body in semiliquid medium. Second specimen with teratological opisthosoma; length unavailable. Dorsal shield holotrichous, similar to that of *A. aegleis* Domrow, 1972, with two exceptions. Firstly, on podonotum, some discal setae ( $j_{4-6}$  and  $z_5$ ) are relatively shorter,

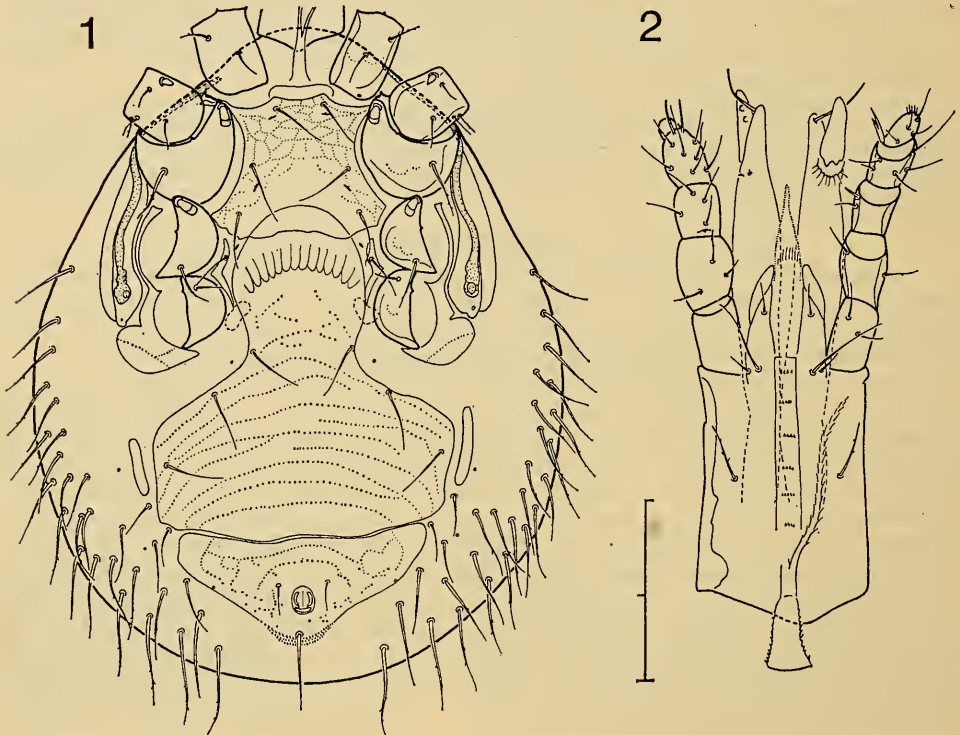

Figs 1-2. *Andreacarus balanites*. 1, Idiosoma in ventral view, ♀. 2, Capitulum in ventral view, with true right palp shown dorsally, ♀.

with interval between  $j_4$  and  $j_5$ , and between  $z_5$  and  $j_6$ , at least twice as long as setae concerned. Secondly, on opisthonotum, some submarginal setae ( $Z_{1-4}$ ) are relatively longer, each extending well beyond body margin and base of succeeding  $S$  seta ( $S_{1-2, 4-5}$ ).

Sternal shield angularly biconvex anteriorly (Fig. 1), and slightly (but irregularly) concave posteriorly; surface reticulate, except midposteriorly. Genitoventral shield with two pairs of usurped ventral setae; third pair free in cuticle near posterolateral angles of shield. Anal shield discrete, but closely applied to genitoventral shield; anus placed slightly behind centre of shield. Postanal seta considerably longer than distance between its insertion and anus, and extending beyond body margin. Cuticle with about 56 setae; extreme posterior pair not decidedly longer than remainder. Venter otherwise as in *A. aegleis*.

Seta *al* on trochanter II spur-like. Anterior seta on coxae II-III expanded, hyaline in distal third. Legs otherwise as in *A. aegleis*, holotrichous, and with setae frequently barbulate (particularly on dorsal surface).

*Notes.* The new species of *Andreacarus* described above is the first member of the *radfordi* species-group to be described from New Guinea, the three previously known species all being Australian (Domrow, 1963a, 1972). The new species is near *A. aegleis*, but separable by the setational differences on the dorsal and anal shields, ventral cuticle, and trochanter II mentioned in the description. The chelicerae provide a further distinction: the digits occupy 17% of the total length in the new species, but only 4.5% in *A. aegleis*.

The specific name is a Greek adjective (*balanites*, acorn-shaped), and refers to the modified anterior seta on coxae II-III.

*Andreacarus radfordi* Domrow

*A. radfordi* Domrow, 1963, *J. Entomol. Soc. Queensl.*, 2 : 9.

*Material.* Four ♀♀ from quoll, *Dasyurus viverrinus* (Shaw) (= *D. quoll* (Zimmermann)) (Marsupialia: Dasyuridae), Golconda, Tas., 6.iv.1973, R. H. Green.

One ♀ from water rat, *Hydromys chrysogaster* Geoffroy (Rodentia: Muridae), Nile, Tas., 8.i.1974, R.H.G.

*Notes.* The first series confirms the original record; the second is a new host-record.

Genus GYMNO LAELAPS Berlese

*Gymnolaelaps* Berlese, 1916, *Redia*, 12 : 170. Type-species *Laelaps myrmecophilus* Berlese, 1892.

*Gymnolaelaps annectans* Womersley

*G. annectans* Womersley, 1955, *Aust. J. Zool.*, 3 : 419.

*Material.* Two ♀♀ from nest of short-tailed shearwater, *Puffinus tenuirostris* (Temminck) (Procellariiformes: Procellariidae), Maatsuyker Island, Tas., 28.i.1975, N. Brothers.

*Notes.* This confirms the original record.

Genus LAELAPSELLA Womersley

*Laelapsella* Womersley, 1955, *Aust. J. Zool.*, 3 : 416. Type-species *L. humi* Womersley, 1955.

*Laelapsella humi* Womersley  
(Fig. 11)

*L. humi* Womersley, 1955, *Aust. J. Zool.*, 3 : 417.

*New host-record.* Twenty-three ♀♀, *Hydromys chrysogaster*, Nile, Tas., 8.i.1974, R.H.G.

*Female.* Epistome sinuous, spiculate, drawn out medially (Fig. 11).

Genus MESOLAELAPS Hirst

*Mesolaelaps* Hirst, 1926, *Proc. Zool. Soc. Lond.*, 1926 : 840. Type-species *Laelaps (M.) anomalus* Hirst, 1926.

*Mesolaelaps bandicoota* (Womersley)  
(Figs 3-4)

*Hypoaspis bandicoota* Womersley, 1956, *J. Linn. Soc.*, 42 : 573.

*Material.* One ♀ from brindled bandicoot, *Isodon macrourus* (Gould) (Marsupialia: Peramelidae), Nambour, S.E.Q., 10.viii.1962, D. Agnew. Two ♀♀ from long-nosed bandicoot, *Perameles nasuta* Geoffroy (Peramelidae), Raven-

shoe, N.Q., 6.ii.1963, G. J. Barrow. Two ♀♀, *P. nasuta*, Nambour, 10.viii.1962, D.A. Twelve ♀♀, *P. nasuta*, Canungra (470 m), S.E.Q., iii and x.1971, R. Domrow and R. W. Campbell.

One ♀ from dusky antechinus, *Antechinus swainsonii* (Waterhouse) (Dasyuridae), Parker River Cove, Vic., 21.vi.1975, J. Wainer.

One ♀ from southern bush-rat, *Rattus fuscipes* (Waterhouse) (Muridae), Palmerston, N.Q., 5.ii.1964, G.J.B. Two ♀♀, *R. fuscipes*, Kirrama, N.Q., 26.viii.1971, W. Dowd. Thirty-five ♀♀, *R. fuscipes*, Canungra (470 m), iii and x.1971, R.D. and R.W.C. Seven ♀♀, *R. fuscipes*, Pearl Beach, N.S.W., 4 and

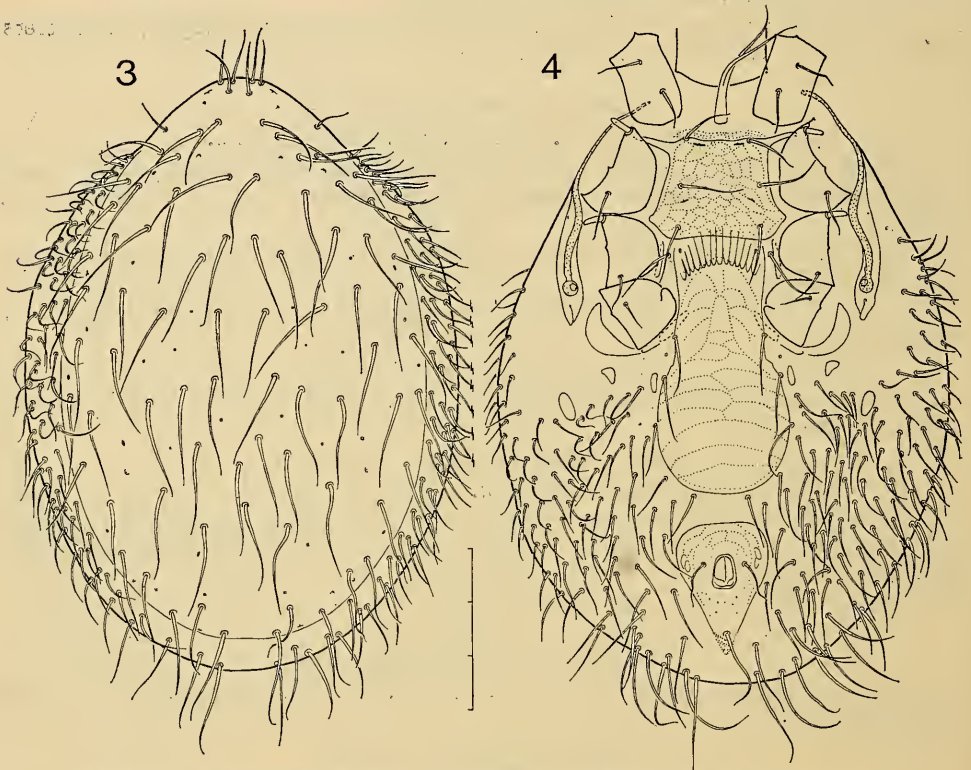

Figs 3-4. *Mesolaelaps bandicoota*. Idiosoma in dorsal and ventral views, ♀ var.

16.iv, 6.v, 27.vii, and 20.viii.1955, B. E. Horner and J. M. Taylor. One ♀, *R. fuscipes*, 10 miles NW of Portland, Vic., 5.x.1963, B.E.H. and J.M.T. Seven ♀♀, *R. fuscipes*, Loch Valley, Vic., 19-22.iii.1963, R. M. Warneke. One ♀ from eastern swamp-rat, *Rattus lutreolus* (Gray), Mount Nebo, S.E.Q., 12.xi.1964, E. H. Derrick. One ♀, *Hydromys chrysogaster*, Tully Falls, N.Q., 16.ii.1965, G.J.B.

*Notes.* The four specimens from Ravenshoe, Palmerston, and Tully Falls in north Queensland are those noted briefly by Domrow (1967). Re-examination of these specimens shows that the anterior seta on coxae II-III is spatulate in the three specimens from *P. nasuta* and *R. fuscipes*, but unmodified in the one specimen from *H. chrysogaster*. The two additional specimens from north Queensland (Kirrama) now recorded (Figs. 3-4) also show this modification.

A second peculiarity of these six specimens is regular hypertrichy on the dorsal shield, all showing, instead of the usual four setae at positions  $J_{3-4}$ , the following counts: 5 once (*Hydromys*), 6 once, 7 twice, and 8 twice.

*M. bandicoota* is commoner in coastal S.E. Australia, but the many specimens from southern localities listed above (and from Tasmania by Domrow, 1963b, 1973) never show the anterior seta on coxae II-III modified, and only two specimens (one each from *R. fuscipes* at Canungra and near Portland) show light hypertrichy at  $J_{3-4}$  (5 and 6 setae, respectively).

Thus hypertrichy at  $J_{3-4}$  seems to be correlated with a modified anterior seta on coxae II-III, and the two modifications together with latitude. Nevertheless, considering the wider setal variation in *M. sminthopsis* (Womersley) (see Domrow, 1963b), even with its restricted host-range (small dasyurids only), I will not name the northern population of *M. bandicoota*.

Lastly, the insertions of one or even two pairs of ventral setae not uncommonly touch upon the genital shield; and, in some specimens from Canungra, the posterior margin of the sternal shield is straight or even slightly convex (normally slightly concave).

*A. swainsonii* is a new host-record.

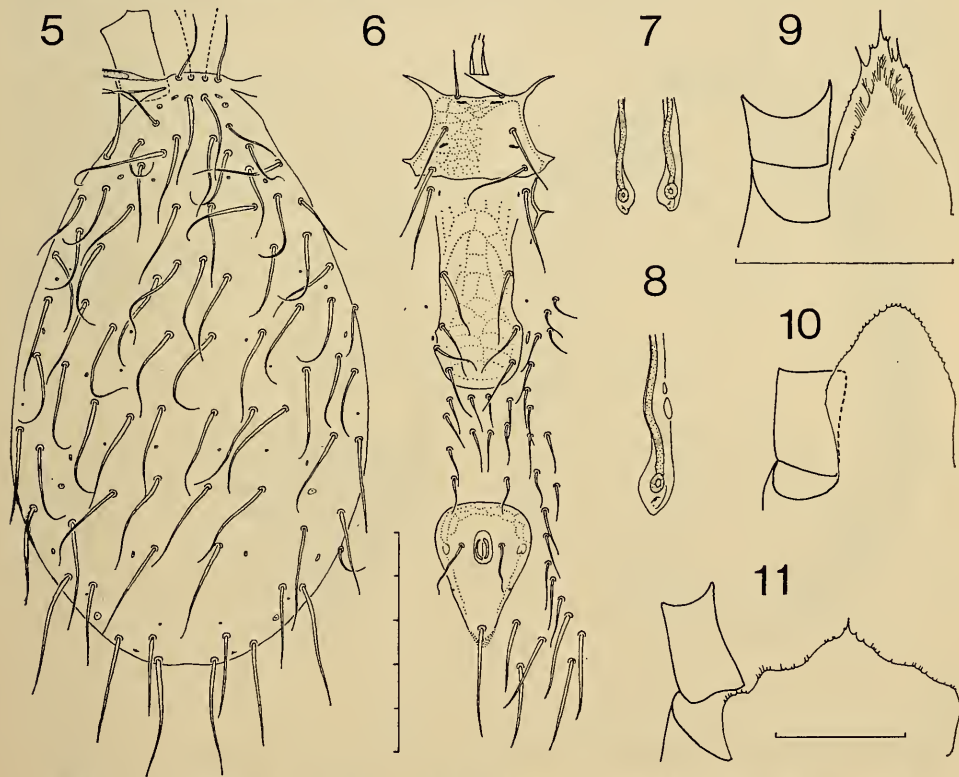

Figs 5-8. *Mesolaelaps anomalus*. 5-6, Idiosoma in dorsal and ventral views, ♀ var. 7, Peritreme, ♀ typ. 8, Peritreme, ♀ var. Fig. 9. *Mesolaelaps antipodianus*. Epistome, deutonymph. Fig. 10. *Haemolaelaps flagellatus*. Epistome, ♀. Fig. 11. *Laelapsella humi*. Epistome, ♀.

*Mesolaelaps anomalus* (Hirst)

(Figs 5-8)

*L. (M.) anomalus* Hirst, 1926, *Proc. Zool. Soc. Lond.*, 1926 : 840.

*Material*. Six ♀♀, *Peroryctes longicauda*, Uinba, Kubor Range, P.N.G., 19.vi.1963, W.B.H. One ♀ from bandicoot, *Echymipera kalubu* (Lesson) (Peramelidae), Upau River, Maprik, P.N.G., 28.xi.1962, K. Keith. Four ♀♀,

*E. kalubu*, Kaminibus, 5 km W of Maprik, 7.vi.1963, K.K. Two ♀♀, *E. kalubu*, Avatip, Sepik River, P.N.G., 13.vi.1963, K.K.

*Notes.* Apart from two of the females from Uinba noted below, this material is typical of Tenorio and Radovsky's (1974) illustrations, except that (1) the peritremes, rather than extending almost to setae  $z_1$  on the dorsal shield, terminate at the level of mid-coxae I; and (2) the peristigmatic portion of the peritrematal shields is usually, but not always (Fig. 7), narrowly continuous externally with the isolated forward lozenge shown by these authors. This blurs the distinction between *M. anomalus* and *M. expansus* Tenorio and Radovsky, and the two females from Uinba noted above are therefore assigned to the older taxon, a choice further supported by the shape of the sternal and anal shields (Fig. 6). They also show extensive peritrematal shields (Fig. 8), but are a third as large again (Fig. 5) as typical *M. anomalus* (dorsal shield  $1,365 \times 835$  vs  $960 \times 620$ ), while the second pair of usurped ventral setae on the genitoventral shield is set nearly as far apart as the first pair, and well forward of the posterior margin.

The first series is a new host-record; the others confirm Domrow (1958).

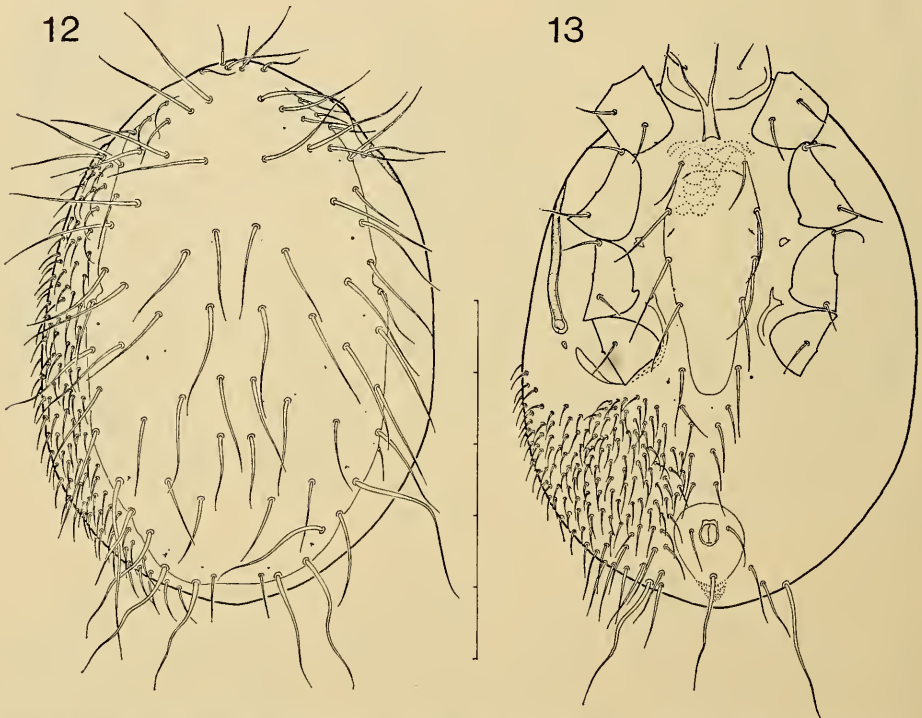

Figs 12-13. *Mesolaelaps antipodianus*. Idiosoma in dorsal and ventral views, deutonymph.

*Mesolaelaps antipodianus* (Hirst)

(Figs 9, 12-13)

*L. (Heterolaelaps) antipodiana* Hirst, 1926, *Proc. Zool. Soc. Lond.*, 1926 : 838.

*Material.* Thirteen ♀♀ and one deutonymph from Gunn's bandicoot, *Perameles gunnii* Gray, Maria Island, Tas., 8.iv.1974, B. L. Munday.

*Deutonymph.* Capitulum 290 long; single specimen available not ideally displayed for illustration, but structure clear and closely resembling that of ♀ of *M. accessorius* Tenorio and Radovsky, 1974, except in following points. Slightly

more delicate because of immaturity. Basis capituli not so distinctly patterned, with setae *c* and *h*<sub>3</sub> barely reaching its sides. Epistome (Fig. 9) more strongly dentate, but not as strongly so as in ♀ of its own species (Tenorio and Radovsky, 1974). Palpal trochanter apparently unarmed ventrally. Setae *al*<sub>1-2</sub> on genu distinctly spatulate. Tarsal claw unenveloped. Chelicerae 180 long, with digits barely occupying 20% of total length.

Idiosoma 750 long, 545 wide (maximum). Dorsal shield (Fig. 12) relatively elongate, 730 × 420, with only slight lateral incisions marking off podonotal and opisthonotal halves; holotrichous, with 39 pairs of setae clearly arranged even marginally, where only one seta has been usurped from hypertrichous cuticle. Setae *Z*<sub>3-5</sub> and *S*<sub>5</sub> larger than remainder on opisthonotal half. Anterior-most pair of setae on cuticle considerably longer than remainder.

Tritosternum undistinguished (Fig. 13); base not clearly spinulose near origins of laciniae. Sternal shield elongate, merging indistinctly along anterior margin with presternal striae; entire surface reticulate; with four pairs of setae (first pair of sternal setae slightly barbate) and three pairs of pores. Pregenital setae free in cuticle; one accompanying pore apparently in form of minute seta. Anal shield rounded anteriorly, with anus set forward of centre. Adanal setae barely reaching insertion of longer postanal seta. Metapodal shields not detected. Endopodal shields III small; IV more extensive, apparently confluent (at least subcuticularly) with exopodal shields IV. Cuticle hypertrichous, with longer setae midventrally between sternal and anal shields (four pairs) and posteriorly (one pair exceptionally so). Peritremes reaching forward to level of anterior margins of coxae II; poststigmatic portion of peritrematal shields free in cuticle.

Legs holotrichous, except tibia I, which bears one additional *v* seta, being (2-6/4-2) rather than (2-6/3-2).<sup>\*</sup> Some setae on leg IV (especially dorsally on tarsus) longer, up to 165.

*Mesolaelaps sminthopsis* (Womersley)

(Figs 14-22)

*L. (L.) sminthopsis* Womersley, 1954, *Rec. South Aust. Mus.*, 11 : 117.

*Material.* One deutonymph from yellow-footed antechinus, *Antechinus flavipes* (Waterhouse), † Crawford's Lookout, Palmerston National Park, Qld, 17.iii.1959, R. D. and J. L. Harrison. One ♂, *A. flavipes*, Landsborough, Vic., 17.vii.1962, R.M.W. Two ♂♂ from brown antechinus, *A. stuartii* Macleay, Tully Falls, Qld, 16.ii.1965, G.J.B. Two ♂♂, *A. stuartii*, Mount Clay, Heathmere Vic., 10.i.1962, R.M.W. One protonymph, *A. stuartii*, Sherbrooke Forest, Vic., 4.vi.1973, I. Beveridge. One ♂, one protonymph (enclosing deutonymph), and two larvae, *A. stuartii*, Powelltown, Vic., vii-viii.1973, I.B. Six ♀♀, *A. swainsonii*, Powelltown, Vic., 5.iii.1974, I.B. One deutonymph from fat-tailed dunnart, *Sminthopsis crassicaudata* (Gould) (Dasyuridae) (laboratory colony), Melbourne, Vic., 20.v.1962, R.M.W. One deutonymph from nesting material of Leadbeater's possum, *Gymnobelideus leadbeateri* McCoy (Marsupialia : Petauridae), Loch Valley, Vic., 29.vii.1963, R.M.W.

*Female.* Dorsal shield holotrichous (Fig. 14).

*Male.* Capitulum 265-285 long, basis 105-130 wide at midlength. Setation on basis and palpal trochanter-tibia holotrichous. Setae *al*<sub>1-2</sub> on genu clavate. Epistome ligulate, minutely serrate (Fig. 18). Chelicerae 195-210 long overall. Fixed digit slender, edentate, and provided with short pilus dentilis. Movable

<sup>\*</sup> The female also shows this additional *v* seta on tibia I.

† See Domrow (1962, 1967) on this identification.

digit also edentate, largely obscured by spermatophore-carrier; latter strongly attenuate at tip. Cheliceral setule, pore, and corona present.

Idiosoma 590–750 long, 305–505 wide at level of coxae III. Dorsal shield holotrichous (Fig. 16), with 39 pairs of setae reasonably clearly arranged except marginally, where hypertrichy occurs due to lateral expansion of shield to take in most of setae (about 60 pairs, of which one or two may encroach beyond *S* series) present on cuticle in ♀ and deutonymph. Setae  $Z_3$  enlarged. Surface of

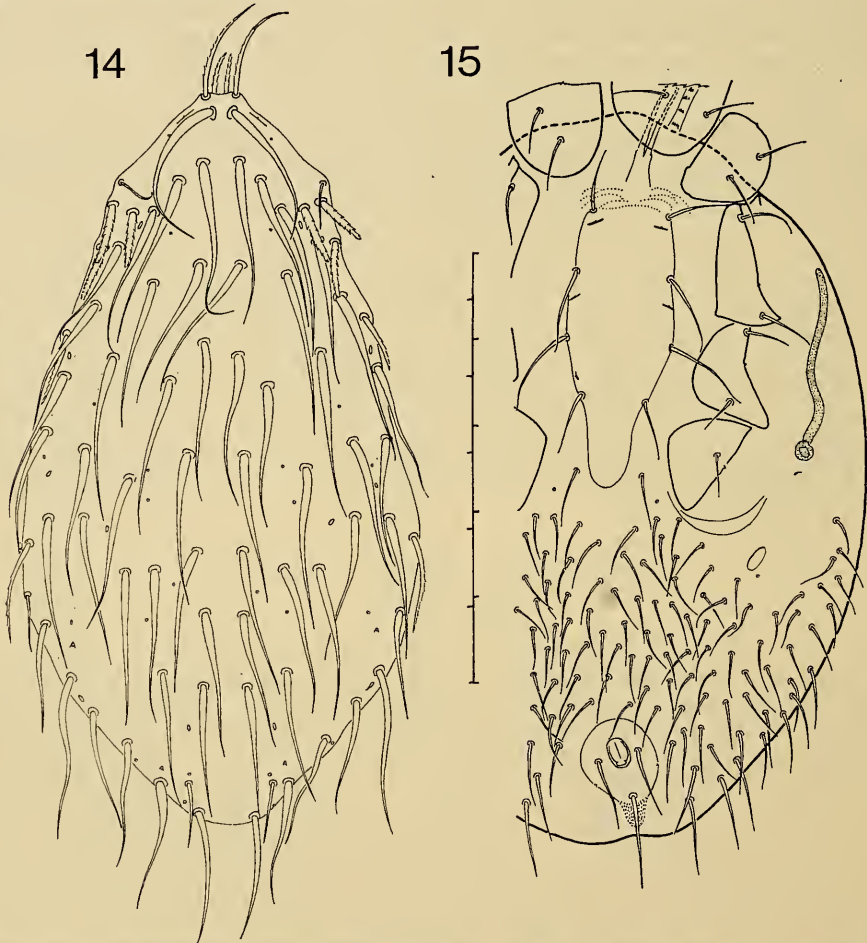

Figs 14–15. *Mesolaelaps sminthopsis*. 14, Dorsal shield, ♀. 15, Idiosoma in ventral view, deutonymph.

shield reticulate (but not so illustrated), and with all 22 pairs of pores shown by Evans and Till (1965), except pair in front of setae  $j_5$ . Marginal cuticle with 30–35 pairs of setae.

Tritosternum 135 long, undistinguished (Fig. 17). Holoventral shield reticulate and entire, but ventral portion with fenestrations and irregular margin. Sternal, metasternal, and genital setae and pores in standard arrangement; about eight pairs of usurped ventral setae present. Anal shield discrete, elongate, with three subequal anal setae; anus set well forward between adanal setae. Cribrum present. Metapodal shields present. Ventral cuticle with 45–50 pairs of setae.



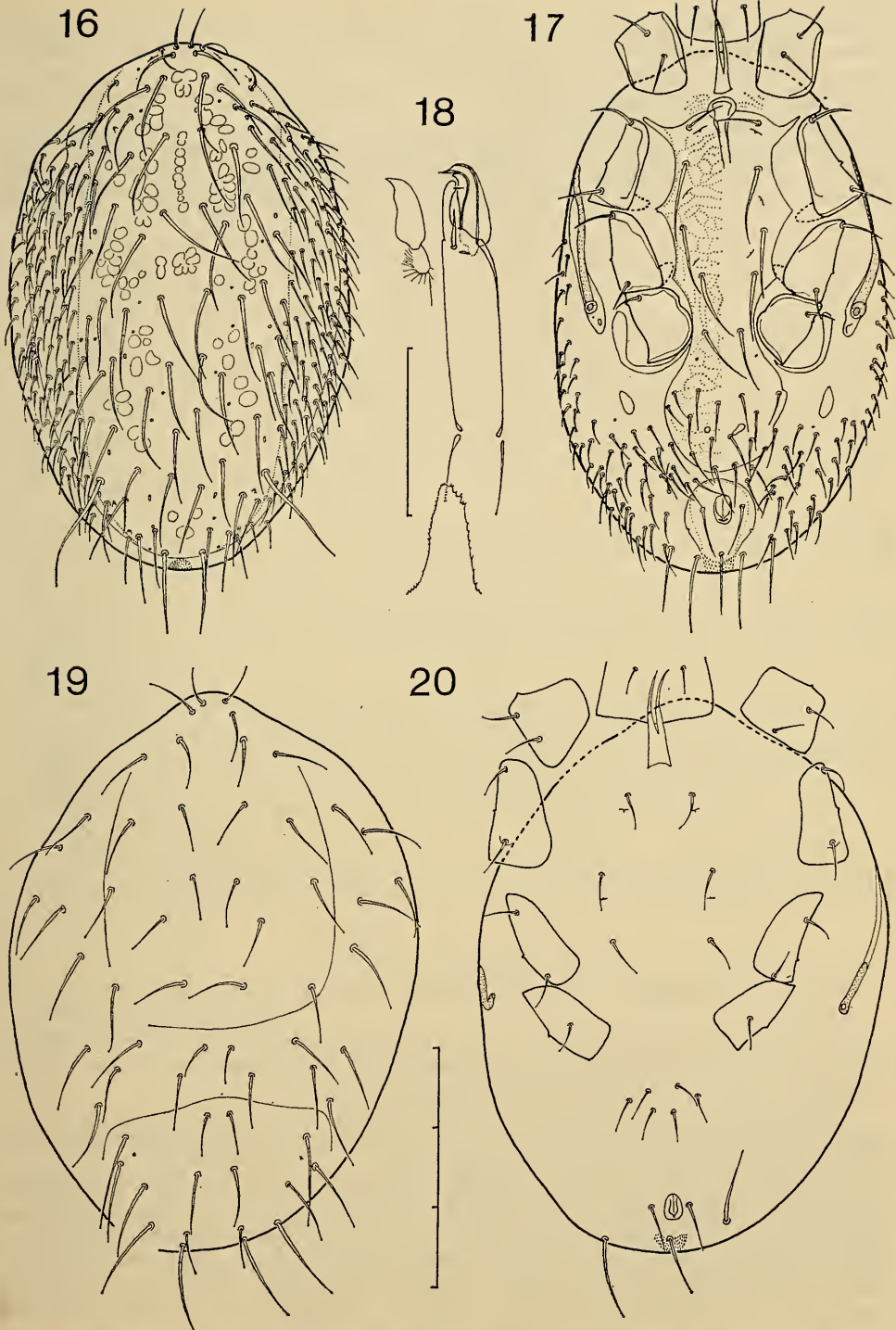

Figs 16–20. *Mesolaelaps sminthopsis*. 16–17, Idiosoma in dorsal and ventral views, ♂. 18, Epistome and right chelicera in external view, with inset of movable digit in internal view, ♂. 19–20, Idiosoma in dorsal and ventral views, protonymph (containing developing deutonymph, and partly reconstructed).

Peritremes extending forward to level of mid-coxae II; peristigmatic shields present (though not clear in specimen illustrated, peritrematal shields narrowly joined to humeral portions of dorsal shield).

Legs holotrichous, except tibia I, which bears one additional *v* seta, being (2-6/4-2) rather than (2-6/3-2).\*

*Deutonymph.* Capitulum 255-295 long, basis 135-165 wide. Basis with setae *c* slender, barbulate, reaching well beyond its sides. Hypostome with setae  $h_{2-3}$  also barbulate, but  $h_1$  apparently simple. Deutosternum with about

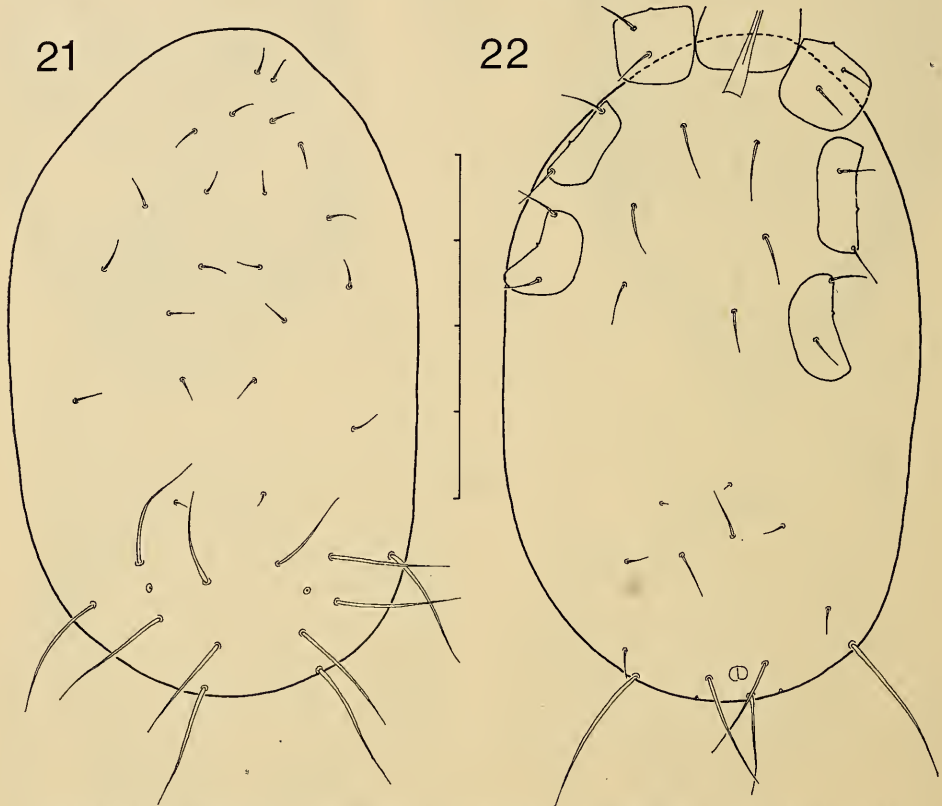

Figs 21-22. *Mesolaelaps sminthopsis*. Idiosoma in dorsal and ventral views, larva.

seven rows of one to four denticles. Palpi holotrichous (tarsal details not clear), with only seta  $v_2$  on trochanter and dorsal setae on femur and genu clearly barbulate; seta  $al_1$  on genu blunt. Chelicerae as in ♀.

Dorsal shield 715-740 long, 310-330 wide (maximum); similar to that of ♂, with setae  $Z_3$  enlarged, holotrichous, but not taking in setae from hypertrichous dorsal cuticle; apparently unincised laterally.

Tritosternal base (Fig. 15) slightly enlarged before division into laciniae (Tenorio and Radovsky, 1974). Sternal shield elongate, narrowed between coxae IV, and carrying four pairs of setae and three pairs of submarginal pores; surface reticulate, but not so figured. Pregenital setae and pores free in cuticle. Anal shield roundly elongate, with adanal setae set near middle of anus and extending well beyond insertion of stronger postanal seta; cribrum present.

\* The female also shows this additional *v* seta on tibia I.

Metapodal and exopodal shields IV present. Ventral cuticle hypertrichous. Peritremes somewhat abbreviated, extending only to mid-coxae II; without distinct poststigmatic shields.

Leg setation not entirely clear, but probably largely holotrichous; crucial segments (tibia I and genu IV) certainly (2-6/4-2) and (2-5/1-1), respectively.

*Protonymph.* Capitulum 280-295 long, basis 130-140 wide at midlength. Setation on basis and palpal trochanter-tibia holotrichous. Seta  $al_1$  on genu clavate. Otherwise as in ♀.

Idiosoma 705 long, 525 wide (enclosing developing deutonymph). Dorsal shields (Fig. 19) holotrichous (30 pairs of setae). Pygidial shield with one pair of pronounced pores.

Tritosternum (Fig. 20) 120 long, undistinguished. Outline of sternal shield not clear; three pairs of sternal setae present, but two pairs of pores not detected. Metasternal complex lacking. Pregenital setae apparently absent. Outline of anal shield not clear, but cribrum present. Anus set between adanal setae, which are subequal to postanal seta. Ventral cuticle with four pairs of setae (first pair subequal to next two pairs, posteriormost pair elongate). Peritremes above coxae III, lacking peristigmatic shields, but with elongate peritrematal shields.

Legs holotrichous.

*Larva.* Capitulum 270-280 long; basis 128-133 wide at midlength. Setation on basis and palpal trochanter-tibia holotrichous. Seta  $al_1$  on genu clavate. Otherwise essentially as in ♀.

Idiosoma 310-315 long, 210 wide at level of coxae III. Dorsal shields lacking (Fig. 21), but podonotum holotrichous (10 pairs of setae). Opisthonotum with seven pairs of setae (one pair short, six pairs elongate), and one pair of pronounced pores.

Tritosternum 116-124 long, undistinguished (Fig. 22). Three pairs of sternal setae present, but shield and pores lacking. Metasternal complex lacking. Outline of anal shield not clear; adanal setae set at level of anus, subequal to postanal seta. Ventral cuticle with five pairs of setae (first pair minute, posteriormost pair elongate). Stigmata and peritremes lacking.

Legs holotrichous.

*Notes.* All stages of this interesting species are now known. It infests a variety of small dasyurid marsupials in eastern Australia, *A. swainsonii* being a new host-record.

#### Genus HAEMOLAEELAPS Berlese

*Haemolaelaps* Berlese, 1910, *Redia*, 6: 261. Type-species *Laelaps (H.) marsupialis* Berlese, 1910.

#### *Haemolaelaps pachyptilae* Zumpt and Till

(Figs 23-26)

*H. pachyptilae* Zumpt and Till, 1956, *Z. Parasitenkd.*, 17: 285.

*New host-records.* One ♂ from nest of fairy penguin, *Eudyptula minor* (Forster) (Sphenisciformes: Spheniscidae), Maatsuyker Island, Tas., 29.i.1975, N.B. Ten ♀♀, two ♂♂, and one deutonymph from nests of *Puffinus tenuirostris*, same data, but 19 and 28.i.1975. Six ♀♀ and two deutonymphs from nests of fairy prion, *Pachyptila turtur* (Kuhl) (Procellariidae), same data, but 19, 25, and 28.i.1975. Two ♀♀ from nest of diving petrel, *Pelecanoides urinatrix* (Gmelin) (Procellariiformes: Pelecanoididae), same data, but 29.i.1975.

*Male.* Capitulum essentially as in ♀, 250-255 long, basis 95 wide. Capitular and hypostomatal setae rather shorter and stouter than in ♀,  $c$  and  $h_3$  barely exceeding sides of basis. Palpi holotrichous, again with setae rather stouter than

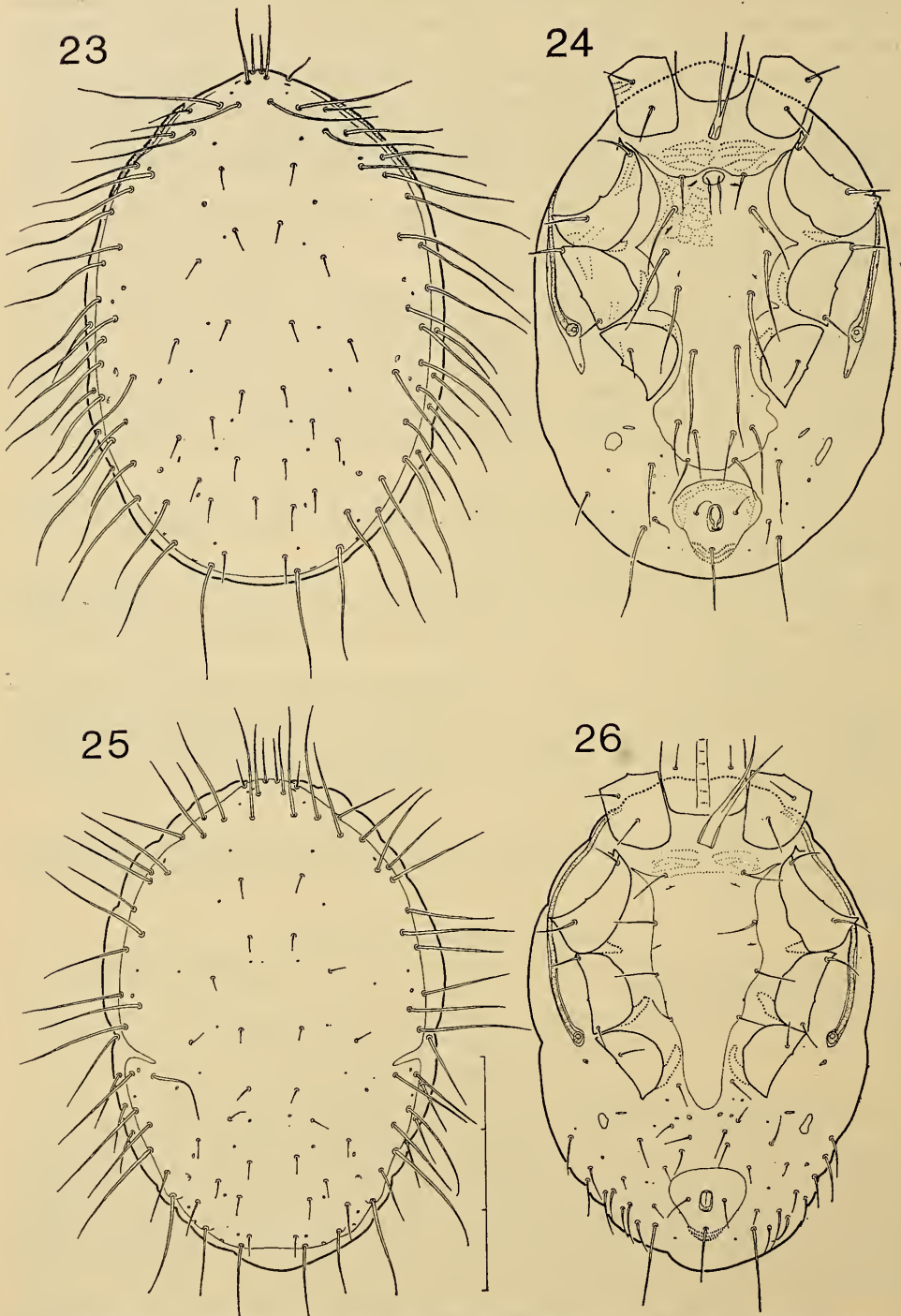

Figs 23-26. *Haemolaelaps pachyptilae*. 23-24, Idiosoma in dorsal and ventral views, ♂. 25-26, Idiosoma in dorsal and ventral views, deutonymph.

in ♀. Setae  $al_{1-2}$  on genu spatulate. Chelicerae 200 long, not well orientated in available specimens, but typical of genus. Fixed digit reduced, narrow, and edentate, but with pilus dentilis in full ♀ form. Movable digit also edentate, barely reaching half-way along, and largely obliterated by, curved spermatophore-carrier (latter occupying almost 45% of total cheliceral length). Corona present. Epistome hyaline, rounded, reaching almost to apices of palpal femora.

Dorsal shield 615–635 × 405–415, parallel-sided, broadly rounded posteriorly, and covering all of dorsum except for narrowest marginal strip of cuticle (Fig. 23). Shield essentially holotrichous (39 pairs of setae), with same 11 pairs of discals ( $j_{4-6}$ ,  $z_{5-6}$ ,  $J_{1-4}$ , and  $px_{2-3}$ ) short as in ♀; marginals elongate (except  $j_1$ ,  $z_1$ ,  $s_1$ , and  $J_5$ ), sinuous, but possibly so, at least in part, as artifact of mounting. Two specimens show slight hypertrichy at  $J_4$  (3 and 4 setae, not usual 2 as in third specimen\*); specimen illustrated also lacks  $z_1$  on one side. Surface of shield reticulate, with distinct muscle insertions and numerous paired pores. Marginal cuticle with up to four pairs of setae.

Tritosternum (Fig. 24) 150 long, base unarmed, 22 long; laciniae divided almost to base, lightly ciliated. Presternal area striate. Sternal, metasternal, genital, and ventral shields fused and well sclerotized with distinct intercoxal projections, especially between coxae I–II. Surface neatly reticulate, with usual five pairs of setae and four pairs of pores in addition to transverse row of four usurped ventral setae. Anal shield broad, rounded anteriorly, and with distinct cribrum. Anus centrally placed, flanked by adanal setae that are rather shorter than postanal seta. Metapodal shields rather variable in shape, elongate-oval to rounded, set outside pair of narrow, transverse shieldlets; ventral cuticle also with evenly arranged, and still smaller, plaques and pores. Cuticle also with four setae in transverse row between ventral and anal shield (of these, 0, 1, or 2 of central pair may be usurped by ventral shield), one short and one long pair of setae flanking anal shield, and (at times) one pair of setae in continuation of row on dorsal cuticle. Peritremes slender, reaching forward to mid-coxae I; post-stigmatic portion of peritrematal shields elongate, with small pore, but free of exopodal shields IV.

Even leg I slightly thickened, II–IV markedly so. Setation holotrichous, except for genu IV, which bears one additional *pl* seta, being 2–5/1–2 rather than 2–5/1–1. Some *d* setae elongate; some *v* setae spinose.

*Deutonymph*. Capitulum essentially as in ♀, 235–245 × 95–105 in two younger, unexpanded specimens, 250 × 110 in expanded specimen.

Dorsum (Fig. 25) predicting form in ♂; dorsal shield incised laterally, 540–550 × 340–365 in two unexpanded specimens, 585 × 380 in expanded specimen. Setation holotrichous, but  $J_4$  displaced in one specimen.

Tritosternum and presternal area (Fig. 26) as in ♂. Sternal shield 270–275 long (from setae  $st_1$ ), 110–120 wide (between  $st_2$ ) in two unexpanded specimens, 290 × 125 in expanded specimen. Anterior margin of shield straight, but weakly defined; lateral margins parallel between coxae II, tapered between coxae III–IV. Surface barely reticulate, with usual four pairs of setae and three pairs of pores. Pregenital setae and pores free in cuticle. Anal and metapodal shields as in ♂. Ventral cuticle with five pairs of setae between sternal and anal shields, one short and one long pair of setae flanking anal shield, and about nine pairs of short setae marginally. Peritremes as in ♂, but peristigmatic portion of peritrematal shields not extended posteriorly to take in pore.

Legs essentially as in ♀, *i.e.* holotrichous, except for one additional *pl* seta on genu IV; no *d* setae unduly long; no *v* setae unduly spinose.

\* Five of 10 females examined also show 3 setae at  $J_4$ ; the other five show 2.

*Notes.* This is a considerable extension of range, the only previous record having been from the dove-prion, *Pachyptila desolata* (Gmelin), on Heard Island. The male and deutonymph were previously unknown.

The male of *H. pachyptilae* shows a discrete anal shield as in *H. centrocarpus* Berlese, *H. hirsti* Keegan, etc., but can be readily separated by the marked disparity of the discal and marginal setae on the dorsal shield. In other congeners, the anal shield is confluent with the ventral shield, the combined holoventral shield behind coxae IV being either unexpanded (e.g. *H. mesopicos* Radford) or expanded (e.g. *H. murinus* (Berlese)). See Till (1963).

In some dermanyssid species (e.g. *Laelaps rothschildi* Hirst below), I suggest that larger deutonymphs are prefemale and smaller ones premale, but the situation is not so simple here, since the deutonymphs described show a mixture of form, their capitulum and legs predicting those of the female, but their dorsal shield that of the male. Thus, I cannot say if the two size ranges noted above are due merely to age or to sex, but I note that while the dorsal shield of one unexpanded female measures only  $645 \times 405$ , it runs to  $670-700 \times 430-460$  in five older, fed, yet not unduly compressed, females.

This material prompted me to re-examine the specimens associated with *E. minor*, *P. tenuirostris*, and *P. turtur*, and identified as *H. fahrenheitzi* (Berlese) (= *H. glasgowi* (Ewing) *vide* Evans and Till, 1966) by Womersley (1955) and Domrow (1973). I confirm that they key out to, and agree closely with, *H. glasgowi* as redescribed by Till (1963), including a similar degree of hypertrichy at setae  $J_{3-4}$  (7-8 setae) and subequal cheliceral digits. The redescription given by Evans and Till (1966) varies somewhat from that of Till (1963), but Tipton, Altman, and Keenan (1966) recognize an even wider range of infraspecific variation. Genu IV bears an additional *pl* seta in all stages present (female, deutonymph, protonymph).

#### *Haemolaelaps flagellatus* Womersley

(Fig. 10)

*H. flagellata* Womersley, 1958, *Proc. Linn. Soc. N.S.W.*, 82 : 300.

*Material.* Seventeen ♀♀ from nests of *Eudypitula minor*, Maatsuyker Island, Tas., 29.i.1975, N.B. Seven ♀♀ from nests of *Puffinus tenuirostris*, same data, but 16 and 19.i.1975. Three ♀♀ from nests of *Pachyptila turtur*, same data, but 25 and 28.i.1975.

Four ♀♀ from Tasmanian devil, *Sarcophilus harrisii* (Boitard) (Dasyuridae), Magg's Mountain, Tas., 14.xi.1974, R.H.G.

*Female.* Epistome rounded, minutely denticulate (Fig. 10).

*Notes.* The specimens from *Puffinus* confirm the original record ; the others are new host-records.

#### *Haemolaelaps telemachus* Domrow

(Figs 27-30)

*H. telemachus* Domrow, 1964, *Proc. Linn. Soc. N.S.W.*, 89 : 160.

*Material.* Several collections comprising numerous adults of both sexes, two deutonymphs, four protonymphs, and two larvae (each enclosing a developing protonymph), *Antechinus stuartii*, Powelltown, Vic., vii-viii.1973, I.B.

*Protonymph.* Capitulum 150-162 long ; basis 77-87 wide at midlength. Setation on basis and palpal trochanter-tibia holotrichous. Seta  $v_1$  on trochanter simple ; seta  $al_1$  on genu blunt. Otherwise essentially as in ♀.

Idiosoma 390-450 long, 263-312 wide (excluding peritremes). Dorsal shields (Fig. 27) holotrichous (30 pairs of setae). Pygidial shield with two pronounced pores.

Tritosternum 93-106 long, undistinguished (Fig. 28). Sternal shield 162-177 long, 95-110 wide at second pair of sternal setae ; biconvex anteriorly, eroded

laterally, and subtriangular posteriorly; virtually textureless, with three pairs of short sternal setae and two pairs of pores. Metasternal complex lacking. Pregenital setae minute. Anal shield 57-64 long, 92-96 wide, with anterior margin almost straight; anus centrally placed, about as long as adanal setae.

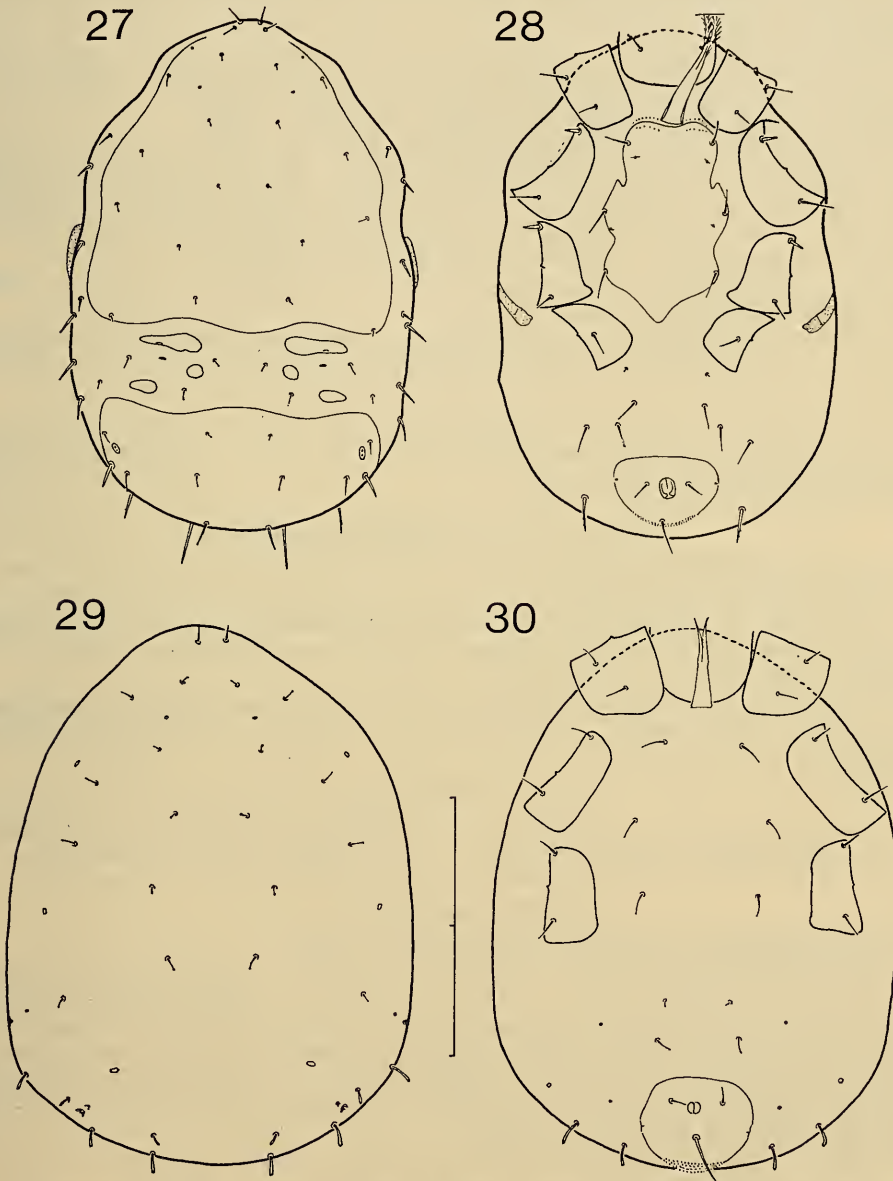

Figs 27-30. *Haemolaelaps telemachus*. 27-28, Idiosoma in dorsal and ventral views, protonymph. 29-30, Idiosoma in dorsal and ventral views, larva.

Postanal seta longer; cribrum present. Ventral cuticle with four pairs of setae (posteriormost pair weakly barbed). Peritremes above coxae III, lacking peristigmatic shields.

Legs holotrichous, except genu IV, which bears one additional *pl* seta, being (1-4/0-1) rather than (1-4/0-0).\* Only seta *al* on coxae II-III clearly expanded and hyaline. Seta *d* on trochanter IV and 2.2.1.2 *d* setae on femora bifid at tip (Domrow, 1961).†

*Larva.* Capitulum 168 long; basis 80 wide at midlength. Setation on basis and palpal trochanter-tibia holotrichous. Seta *al*<sub>1</sub> on genu blunt. Otherwise essentially as in ♀.

Idiosoma 420 long, 310 wide at level of coxae III (Fig. 29). Dorsal shield not detected, but podonotum holotrichous (10 pairs of setae). Opisthonotum with five pairs of clavate setae and several pronounced pores.

Tritosternum 72 long, undistinguished (Fig. 30). Three pairs of sternal setae present, but shield and pores not detected. Metasternal complex absent. Anal shield as in protonymph, but less markedly wider than long; length 72, width 88. Ventral cuticle with four pairs of setae (first pair minute, posterior-most two pairs clavate). Stigmata and peritremes lacking.

Legs holotrichous. Seta *al* coxae II-III not expanded and hyaline. No *d* setae on femora bifid at tips.

*Notes.* All stages of this interesting species are now known; its only known hosts are species of *Antechinus* Macleay in mainland S.E. Australia.

#### Genus ANDROLAELAPS Berlese

*Androlaelaps* Berlese, 1903, *Zool. Anz.*, 27 : 14. Type-species *Laelaps (Iphis) hermaphrodita* Berlese, 1887.

#### *Androlaelaps hermaphroditus* (Berlese)

*L. (I.) hermaphrodita* Berlese, 1887, *Acari, Myriapoda et Scorpiones hucusque in Italia reperta*, 40 : 6. Padua.

*Material.* Numerous adults (both sexes) associated with cattle ticks, *Boophilus microplus* (Canestrini) (Acari: Ixodidae), ovipositing in the field at Amberley, Qld, 1973, J. W. Newman.

*Notes.* This widespread predator is not uncommon on small mammals (Womersley, 1956; Wilson, 1967), but has not previously been recorded from Australia.

#### Genus LAELAPS Koch

*Laelaps* Koch, 1836, *Deutschlands Crustaceen, Myriapoden und Arachniden*, 4 : 19. Regensburg: Herrich-Schäffer. Type-species *L. hilaris* Koch, 1836.

#### *Laelaps nuttalli* Hirst

*L. nuttalli* Hirst, 1915, *Bull. Entomol. Res.*, 6 : 183.

*Material examined.* Two ♂♂ from rat, *Rattus ruber* (Jentink), Korogo, Sepik River, P.N.G., 10.iii.1964, K.K. Three ♀♀, *Rattus* (?) *ruber*, near Rauti Village (3°36'S, 142°15'E), P.N.G., 1973, Aberdeen University New Guinea Expedition. Sixteen ♀♀, 11 ♂♂, and four protonymphs from rat, *Melomys platyops* (Thomas) (Muridae), Maprik, P.N.G., 24-27.ii.1964, K.K. Two ♀♀, *Melomys rufescens* (Alston), Maprik, 25.v.1963, K.K. Three ♀♀, *Melomys littoralis* (Lönnerberg), Mossman Gorge, N.Q., 9.vii.1964, K.K.

*Notes.* All specimens run through Allred's (1969) keys. The two New Guinea species of *Melomys* Thomas are unrecorded hosts.

\* The deutonymph and adult also show an additional *pl* seta on genu IV, being (2-5/1-2) rather than (2-5/1-1).

† The deutonymph and adult also show this pattern, and my original statement is in error—it is not until an ideal plane is assumed that the bifid tip of these setae is at all clear.



*Laelaps assimilis* Womersley

(Figs 31-43)

*L. assimilis* Womersley, 1956, *J. Linn. Soc.*, 42 : 557.

**Material.** Five ♀♀ and one ♂, *Rattus fuscipes*, Shipwreck Creek, Vic., 12.ii.1969, J. H. Seebeck. Five ♀♀ and one ♂, *R. fuscipes*, 32 km S of Albany, W.A., 22.x.1970, J. Martin. Four ♀♀, two deutonymphs, three protonymphs, and two larvae, *Rattus lutreolus*, Wilson's Promontory, Vic., 7.v.1973, R. Shepherd.

**Female.** Deutosternum (Fig. 41) with six rows of denticles, mostly double. Hypostome with setae  $h_1 = h_3 > h_2$ . Labial cornicles small, barely horn-like. Salivary stylets present. Labrum subacute. Epistome trilobed, not dentate, and falling short of distal margins of palpal femora. Palpi (trochanter-tibia) holotrachous. Seta  $v_2$  on trochanter slightly bladed (if seen from suitable angle). Pilus dentilis inflated distally (Fig. 43).

Dorsal shield (Fig. 31) holotrachous (39 pairs of setae, seta  $J_1$  missing on one side of specimen figured).\*

Anal shield (Fig. 32) distinctly longer than wide, with adanal setae barely reaching half way from their insertions to that of postanal seta. Exopodal shields IV and poststigmatic shields present.

Coxa II with small spine on anterodorsal margin. Leg setation holotrachous, except that genu IV has one additional *pl* seta, being (2-5/1-2) rather than (2-5/1-1). Femora I-II with two dorsodistal setae much strengthened; genu I with seta  $pd_3$  strong. Generally speaking, setae set ventrally on distal segments of legs II-IV are stronger, but only  $al_1$  and  $pl_1$  on tarsus II, and  $al_1$  (and perhaps  $al_2$ ) on tarsus III, may be termed spurs.

**Male.** Capitulum essentially as in ♀, except for chelicerae (Fig. 42).

Dorsal shield (Fig. 35) as in ♀ (setae  $r_2$  and  $S_1$  missing each on one side of specimen figured), but with longer marginal setae ( $r_{2-5}$ ,  $s_6$ ,  $S_{1-5}$ ,  $Z_5$ ).

Venter essentially as in ♀, except for details of holovertrantal shield (Fig. 36).

Setal formulae for legs, including genu IV, as in ♀. Setae  $al_1$ ,  $av_1$ ,  $pl_1$ ,  $av_2$ , and  $pv_2$  clearly spurs on tarsi II-III. Setae  $al_1$ ,  $av_1$ ,  $pv_1$ ,  $pl_1$ ,  $pv_2$ , and  $pl_2$  clearly spurs on tarsus IV.

**Deutonymph.** Capitulum, dorsum, and venter essentially as in ♀, except for lateral incisions on dorsal shield (Fig. 33), details of sternal shield (Fig. 34), and absence of poststigmatic shields.

Legs also as in ♀, including genu IV.

**Protonymph.** Capitulum and legs holotrachous, except for additional *pl* seta on genu IV (as in *Haemolaelaps telemachus* above).

Dorsum (Fig. 37) holotrachous (30 pairs of setae). Posterior margin of podonotal shield straight. Pygidial shield transversely oval, with slight convexity on midanterior margin.

Sternal shield (Fig. 38) longer than wide, somewhat irregular in outline posteriorly; with three pairs of setae and two pairs of submarginal pores. Pregenital setae small. Anal shield not as elongate as in ♀, but with adanal setae relatively larger compared to postanal seta. Metapodal shields not detected, but indications of exopodal shields IV present. Ventral cuticle with four pairs of setae. Peritremes above coxae III, preceded by anterolateral precursor of peritrematal shields.

**Larva.** Capitulum and legs holotrachous.

\* The original illustration also shows 39 pairs, but makes good the omission of  $z_1$  by mistaking the distinct pores outside  $j_6$  for an additional pair of setal alveoli. It is sobering to look back, after 20 years, at one's first attempt at scientific illustration, and I make no excuse for presenting supplementary Figs.

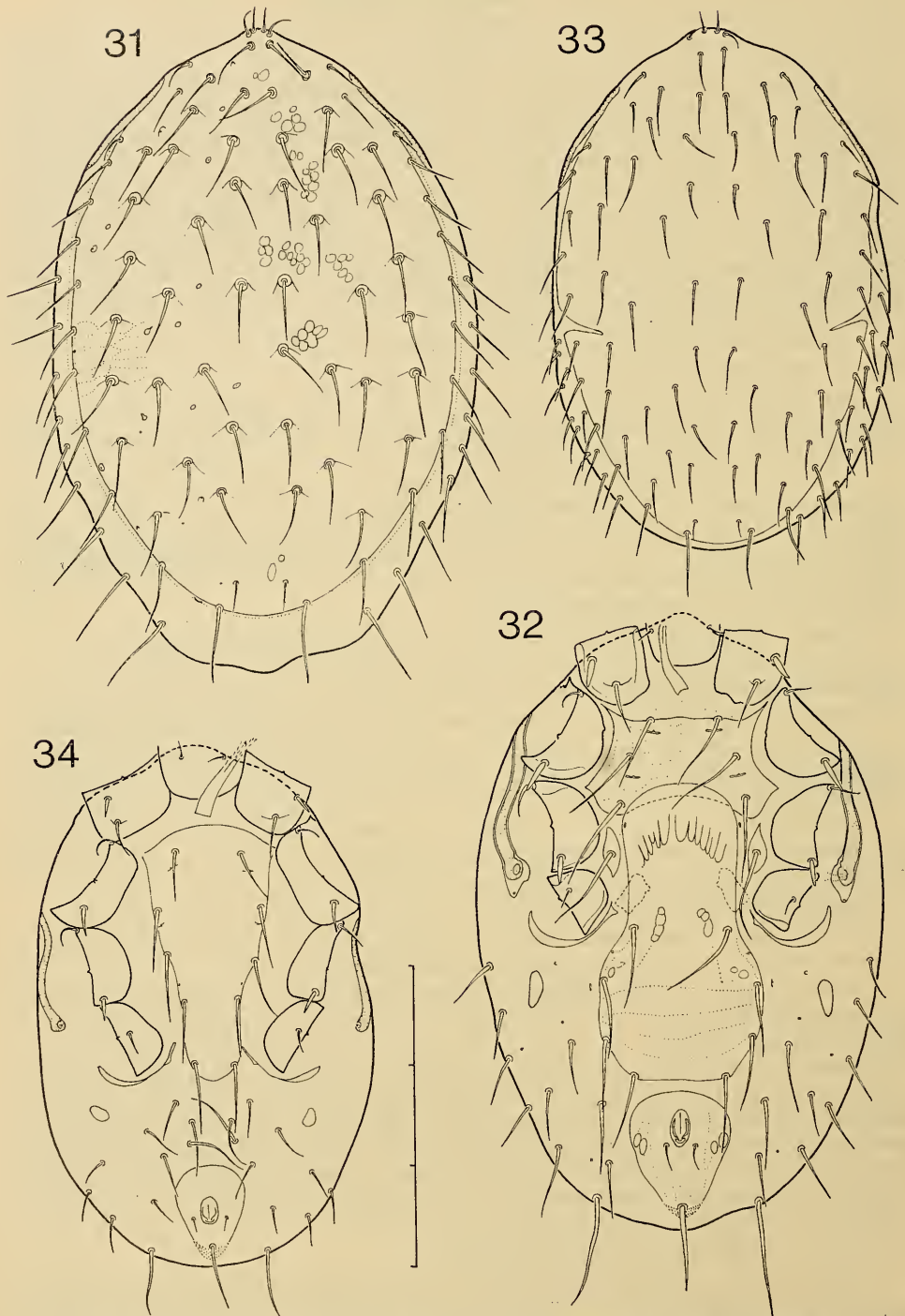

Figs 31-34. *Laelaps assimilis*. 31-32, Idiosoma in dorsal and ventral views, ♀. 33-34, Idiosoma in dorsal and ventral views, deutonymph.

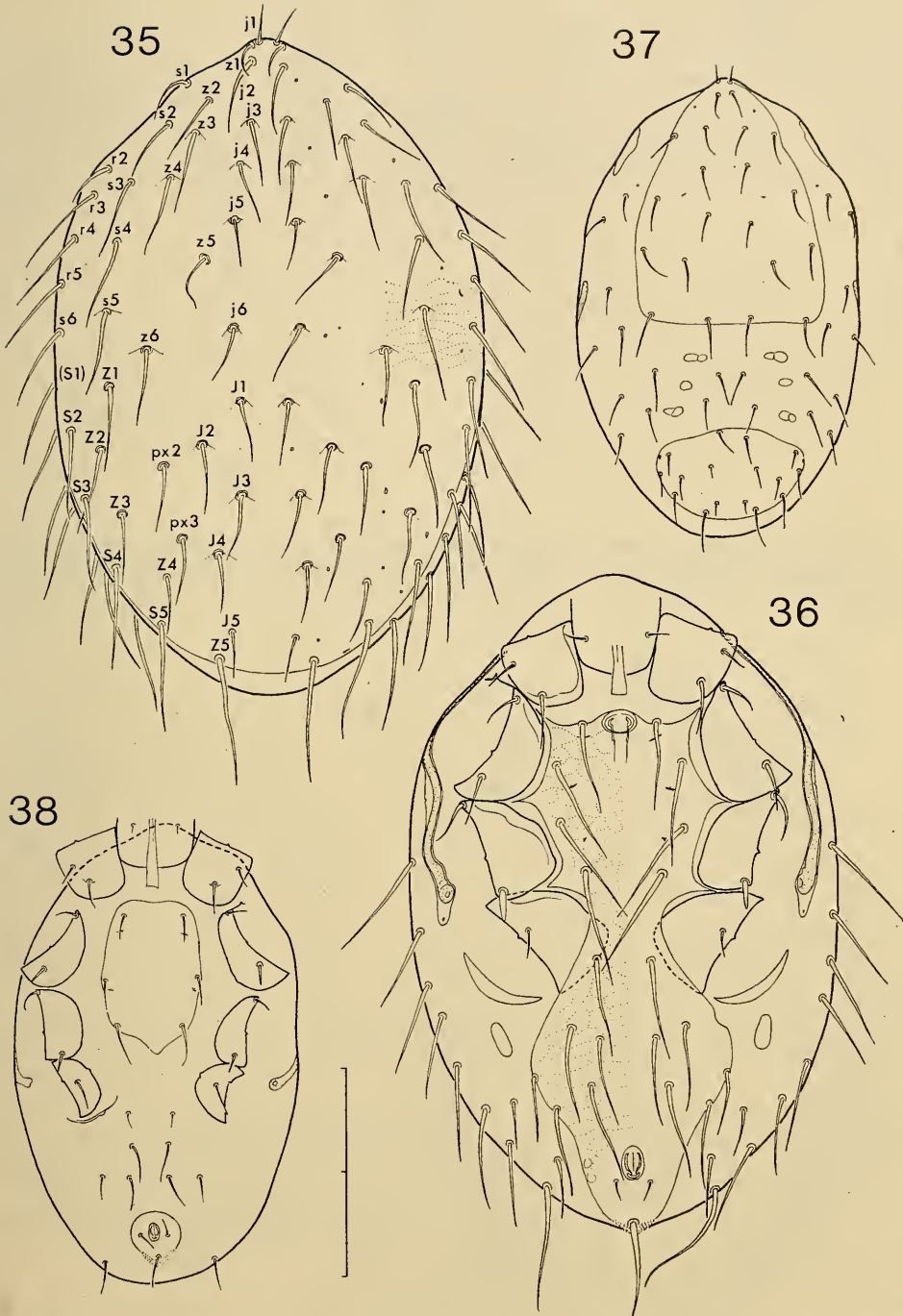

Figs 35-38. *Laelaps assimilis*. 35-36, Idiosoma in dorsal and ventral views, ♂. 37-38, Idiosoma in dorsal and ventral views, protonymph.

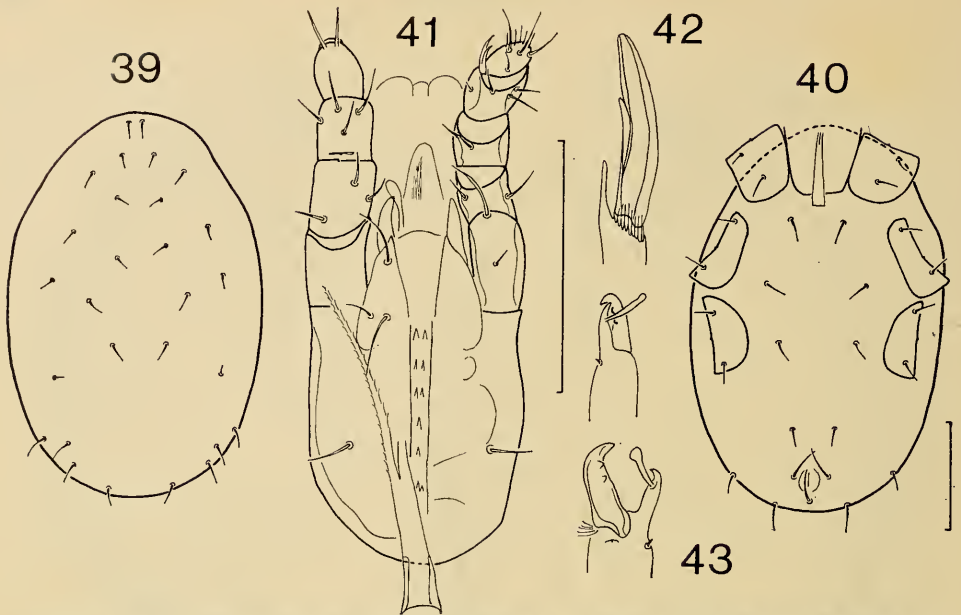

Figs 39-43. *Laelaps assimilis*. 39-40, Idiosoma in dorsal and ventral views, larva. 41, Capitulum in ventral view, with true right palp shown dorsally and inset of tip of epistome, ♀. 42, Chelicera in lateral view, ♂. 43, Chelicera in dorsoexternal view (above) and external view (below), ♀.

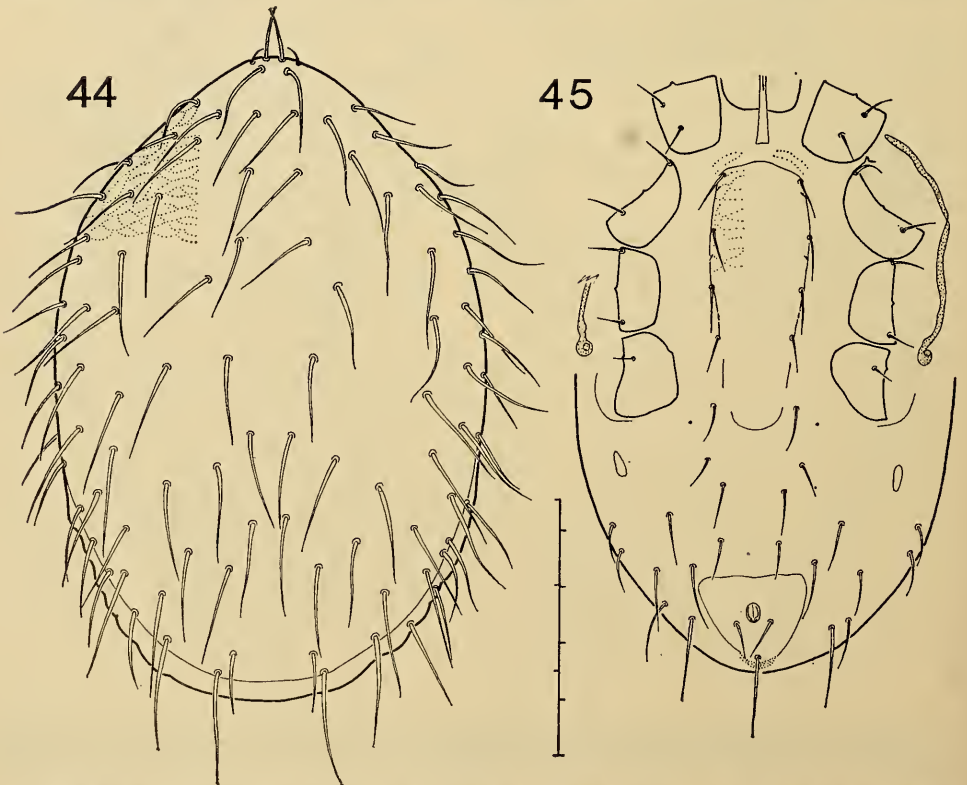

Figs 44-45. *Laelaps rothschildi*. 44, Idiosoma in dorsal view, ♂. 45, Idiosoma in ventral view, prefemale deutonymph.

Podonotum (Fig. 39) holotrichous (10 pairs of setae). Opisthonotum with four pairs of setae.

Three pairs of sternal setae present (Fig. 40). Anal setae subequal. Ventral cuticle with three pairs of setae.

*Notes.* All stages of this common species are now known. Males vary considerably in dimensions, but without the clear-cut division into two size classes shown in *L. dolomydis* Mrciak, 1974.

With the recognition that *R. fuscipes* occurs in Western Australia as well as in the eastern states (Horner and Taylor, 1965), the similar extension of range now recorded for *L. assimilis* is not surprising.

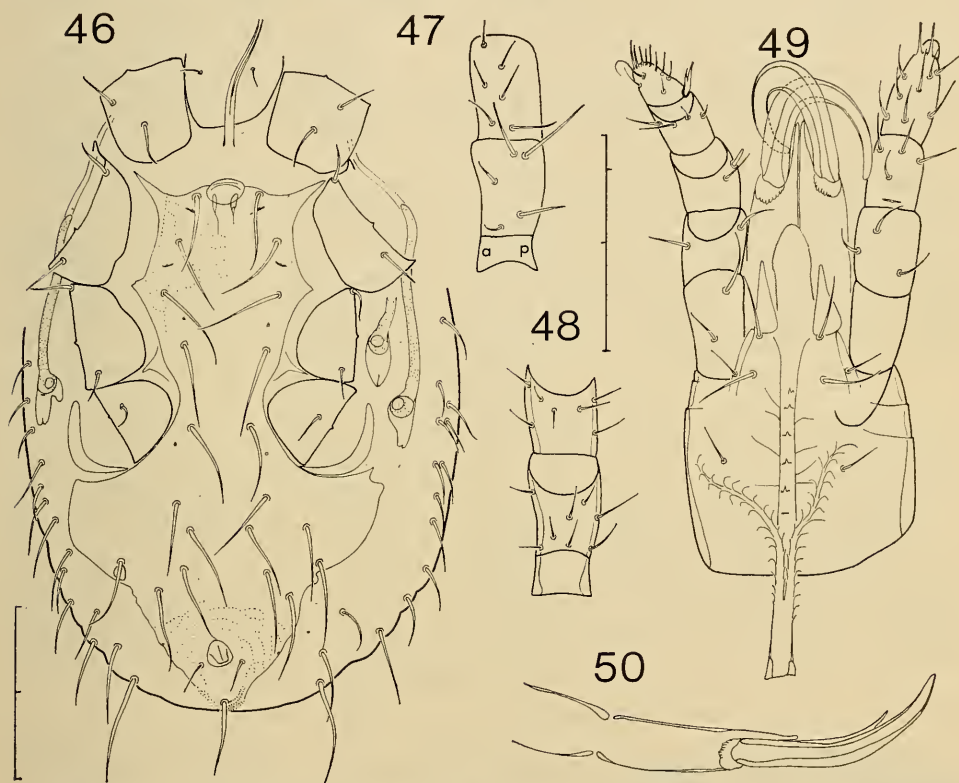

Figs 46–50. *Laelaps rothschildi*. 46, Idiosoma in ventral view, with inset of poststigmatic portion of peritrematal shield, ♂. 47–48, Femur-genu I in dorsal and ventral views, ♂. 49, Capitulum in ventral view, with true left palp shown dorsally, ♂. 50, Left chelicera in ventral view, ♂.

*Laelaps barbarae* Strandtmann and Mitchell

*L. (Echinolaelaps) barbarae* Strandtmann and Mitchell, 1963, *Pacif. Insects*, 5 : 558.

*New host-record.* Eleven ♀♀ from rat, *Rattus verecundus* (Thomas), Kairouk, Madang, P.N.G., vii.1968 and i.1972, W. H. Ewers.

*Laelaps rothschildi* Hirst  
(Figs 44–55)

*L. rothschildi* Hirst, 1914, *Trans. Zool. Soc. London*, 20 : 325.

*Material.* Numerous ♀♀, *Melomys platyops*, Maprik, P.N.G., 24–27.ii.1964, K.K. Six ♀♀, *Melomys rufescens*, Kaminibus, 3 miles W of Maprik, 25.v.1963,

K.K. Nine ♀♀, *M. rufescens*, Luk Luk Island, Chambri Lake, P.N.G., 30.v.1963, K.K. Four ♀♀, *M. rufescens*, Japangai, Sepik River, P.N.G., 14.vi.1963, K.K. Five ♀♀, *M. rufescens*, Bainyik, Sepik River, 22.iii.1964, K.K. Four ♀♀, *Melomys littoralis*, Capsize Creek, 80 km S of Moreton Telegraph Office, N.Q., 19.vii.1964, K.K. Several ♀♀, *M. littoralis*, Shipton's Flat, N.Q., 9 and 12.vii.1964, K.K. Four ♂♂ and one protonymph, *Melomys* sp., Cape Flattery, N of Coen, Qld, 30.xi.1970, J.M. Three deutonymphs and two protonymphs, *Melomys* sp., 32 km S of Townsville, Qld, 31.viii.1970, J.M.

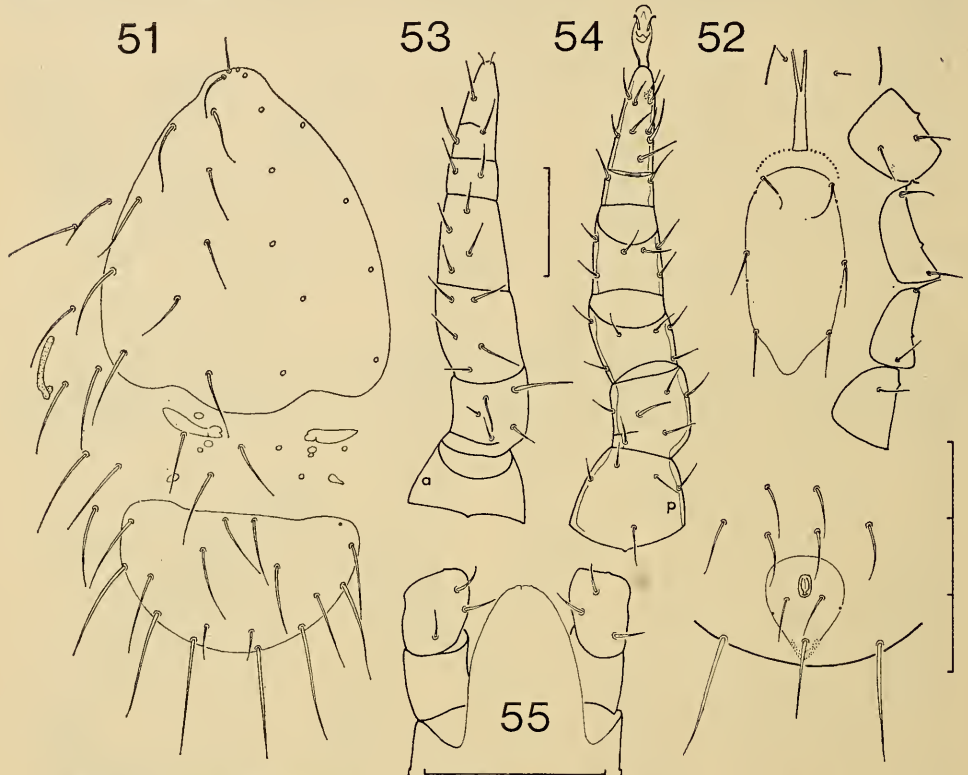

Figs 51-55. *Laelaps rothschildi*. 51-52, Idiosoma in dorsal and ventral views, protonymph (right-hand side of podonotal shield reconstructed). 53-54, Leg II in dorsal and ventral views, ♂. 55, Epistome, ♂.

*Male*. Capitulum (Fig. 49) 300 long; basis 126 wide. Capitular setae weaker than all hypostomatal setae except  $h_2$ . Deutosternum with six rows of denticles in small number. Labial cornices distinct, but not strongly curved and horn-like. Labrum spatulate. Epistome diaphanous (Fig. 55), reaching forward to middle of palpal femora. Palpi (trochanter-tibia) holotrichous. Seta  $al_1$  on genu spatulate. Claws bifid. Chelicerae 230 long (Fig. 50). Fixed digit obsolescent. Movable digit also weak and edentate, largely fused to, and almost obliterated by, strong, upwardly curved spermatophore-carrier. Corona present, but weak.

Idiosoma 753 long, 500 wide. Dorsal shield (Fig. 44) oval, almost entirely covering dorsum; surface reticulate. Shield essentially holotrichous (39 pairs of setae,  $z_6$  lacking on one side of specimen figured), but hypertrichous to extent of six to eight pairs of shorter setae apparently set on extreme margin. Dorsal cuticle accordingly with only about two pairs of setae.

Holoventral shield typical of genus (Fig. 46), with posterolateral margins irregular and sometimes fenestrate; normally with five pairs of usurped ventral setae (but 5·6 on specimen figured). Adanal setae set just behind anus, distinctly shorter than other setae on shield. Exopodal shields IV typical of genus. Ventral cuticle with about 15 pairs of setae of increasing length posteriorly. Peritremes abbreviated, reaching only to mid-coxae II. Poststigmatic shields normally as figured on right-hand side; inset and left-hand side represent individual variations.

Setation of legs holotrichous (Figs 53–54), with one exception, genu IV being (2–5/1–2) rather than (2–5/1–1).\* Some *d* setae on femora-genua I–II slightly stronger (Figs 47–48).

*Deutonymph.* Capitulum, including palpal trochanter-tibia holotrichous; otherwise essentially as in ♀.

Dorsum as in ♂, except for marginal hypertrichy on dorsal shield. Dorsal cuticle accordingly more setose than in ♂. Dorsal shield incised laterally, 990 long, 560 wide in one specimen (prefemale), 745–755 long, 440 wide in other two (premale).

Sternal shield (Fig. 45) elongate, slightly narrower (and weakly defined) in posterior half; surface reticulate; bearing four pairs of setae and three pairs of pores on margin. Pregenital setae and pores free in cuticle. Anal shield subtriangular, equilateral, with anus set slightly in front of centre. Adanal setae reaching insertion of stronger postanal seta; cribrum present. Metapodal shields distinct, but exopodal shields IV only incipient. Ventral cuticle with about 10 pairs of setae of increasing length posteriorly. Peritremes reaching forward to mid-coxae I; poststigmatic shields absent.

Legs as in ♂.

*Protonymph.* Capitulum holotrichous (palpal tarsus not examined); otherwise essentially as in ♀ (Domrow, 1973).

Dorsum holotrichous (Fig. 51). Podonotal shield in specimen figured 450 long and calculated to be 375 wide; opisthonotal shield 180 long, 312 wide.

Sternal shield elongate (Fig. 52), almost textureless, bearing three pairs of setae and two pairs of pores marginally. Pregenital setae absent, but accompanying pores present. Anal shield more elongate than in deutonymph, but position of anus and proportions of anal setae as in that stage. Ventral cuticle with four pairs of setae, posteriormost pair much the strongest. Peritremes above coxae III, without associated shields.

Setation of legs holotrichous, with one exception, genu IV being (1–4/0–1) rather than (1–4/0–0).

*Notes.* The stages now described remove any doubt on the generic placement of this common parasite of mosaic-tailed rats. Only the larva remains unknown.

*M. platyops* and *M. rufescens* are new host-records.

#### Genus NEOLAE LAP S Hirst

*Neolaelaps* Hirst, 1926, *Proc. Zool. Soc. London*, 1926 : 836. Type-species *Liponyssus magnistigmaticus* Vitzthum, 1918.

#### *Neolaelaps palpispinosus* Strandtmann and Garrett

(Figs 56–64, 74–75)

*N. palpispinosus* Strandtmann and Garrett, 1967, *J. med. Ent.*, 4 : 237.

*New host-record.* Four ♀♀ and two deutonymphs from tube-nosed bat, *Nyctimene draconilla* Thomas (Chiroptera : Pteropodidae), near Rautit Village,

\* The same is true of the female (Domrow, 1973).

West Sepik District, P.N.G., 10.viii.1973, Aberdeen University New Guinea Expedition.

*Female.* Palpi (excluding tarsus) holotrichous, except for unidifferent genu ( $al_2$  lacking).

Leg setation holotrichous (Figs 59–60), with four exceptions: genu I (Figs 61–62) unidifferent ventrally (1.1, not 2.1); tibia I with additional seta ventrally (2.2, not 2.1; one specimen shows 1.2 on one side); tibia IV unidifferent both

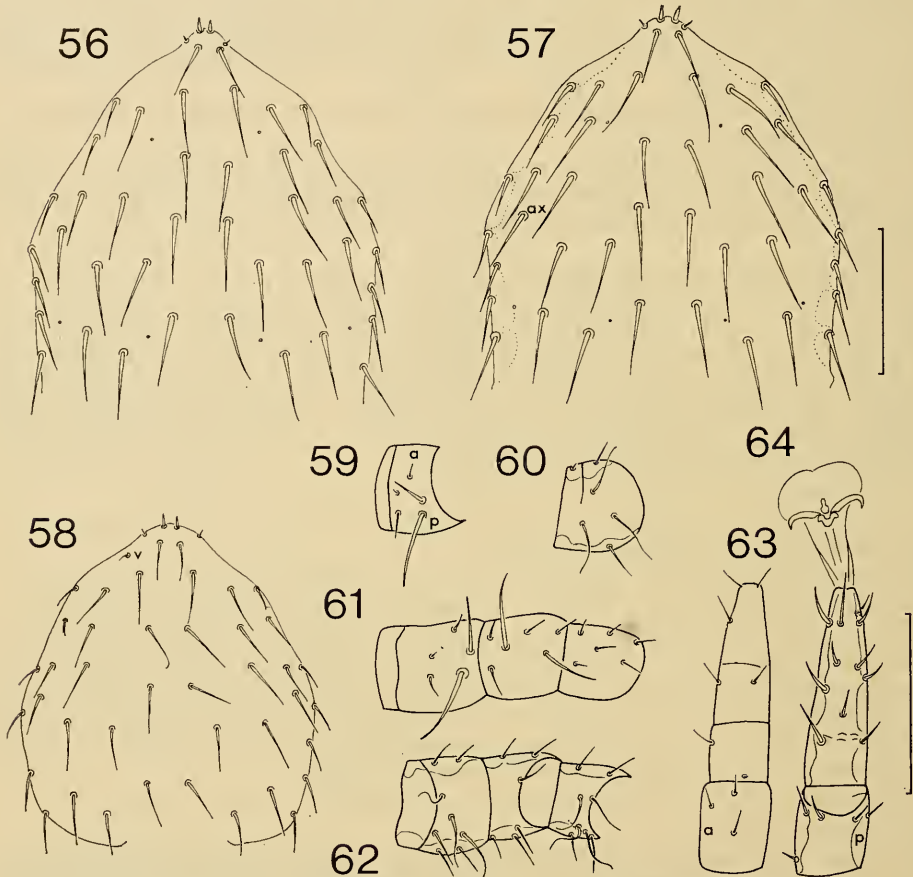

Figs 56–64. *Neolaelaps palpispinosus*. 56–57, Podonotal half of dorsal shield, ♀. 58, Podonotal half of dorsal shield, deutonymph. 59–60, Femur II in dorsal and ventral views, ♀. 61–62, Femur-tibia I in dorsal and ventral views, ♀. 63–64, Tarsus IV in dorsal and ventral views, ♀.

dorsally and posteriorly (1.2–1 as on tibia III, not 1.3–2); basitarsus IV (Figs 63–64) unidifferent ( $pd_4$  lacking).

*Deutonymph.* Capitulum with setae *c*, and palpal trochanter with seta  $v_1$ , filamentous distally. Otherwise as in ♀.

Idiosoma 385–410 long, 255–260 wide at stigmata. Dorsal shield detailed in *Notes*.

Sternal shield (Fig. 75) with four pairs of setae and two pairs of pores, well formed, but tapered posteriorly so that pregenital pair of setae and pores lie free in cuticle. Remainder of venter as in ♀, but reticulations on shields less marked, ventral setae more numerous (about 25 pairs), and peritremes less abruptly attenuated distally.



Both setae on coxa I and posterior seta on coxa II filamentous distally. Setal formulae as in ♀.

*Notes.* The brief descriptive notes above on the female supplement the original text. Apart from minor individual variation, the formulae originally given for the leg setation seem to reflect two real omissions:  $al_2$  and small  $d$  seta set anterobasally on femora I–II, and  $ad_1$  and  $pd_1$  (very fine, and often appressed to ambulacra) on tarsi II–IV. The formulae in the other two known species—*N. vitzthumi* Domrow and *N. spinosus* (Berlese) (see Radovsky, 1967)—are the same as in *N. palpispinosus*, except that basitarsus IV is normal.

More interesting is the setal pattern on the dorsal shield. The lateral incisions marking off the podonotal and opisthonotal halves of this shield in the deutonymph confirm one's impression from the female that the opisthonotal setae comprise 15 pairs:  $J_{1-5}$ ,  $Z_{1-5}$ , and  $S_{1-5}$ , without accessory  $px$ . Little individual variation was noted, positions  $Z_{1-2}$  and  $Z_{3-4}$  being occupied by a single seta on one side of one deutonymph and one female, respectively.

A careful count of the podonotal setae in two females showed 23 pairs arranged as in the left-hand side of both the original illustration and Fig. 57. The other two females showed 23.22, the deficiency being due to the absence of seta  $z_3$  in one case (Fig. 56), and seta  $ax$  in the other (Fig. 57). The original illustration, incidentally, is also 23.22, but a third seta ( $r_3$ ) is involved.

Likewise, although one deutonymph shows 23.23, the count is better expressed 23.22 +1, since the absence of seta  $r_4$  (Fig. 58) is made good only by the presence of an unpaired subvertical seta  $v$  in a position never occupied in females. The unevenness in the other deutonymph (23.23 +1) is also due to an unpaired seta  $v$  (Fig. 74). Ignoring seta  $v$  as an individual variation, acceptance of the normal presence of an accessory seta  $ax$  (Fig. 57) in the position noted by Costa (see Evans and Till, 1965) in some more typical laelapine genera best fits the pattern of 23 (rather than the basic 22) pairs of podonotal setae in *N. palpispinosus*. In the other two species of the genus, the hypertrichy is more extreme, despite the "pressure" exerted by the grossly enlarged peritremes nearby (*N. vitzthumi* 24–25 pairs, *N. spinosus* about 26, see Domrow, 1961, and Radovsky, 1967).

#### Genus DOMROWNYSSUS Evans and Till

*Domrownyssus* Evans and Till, 1969, *Bull. Br. Mus. Nat. Hist.*, 14 : 121. Type-species *Pneumonyssus dentatus* Domrow, 1961.

#### *Domrownyssus dentatus* (Domrow)

*P. dentatus* Domrow, 1961, *Proc. Linn. Soc. N.S.W.*, 86 : 73.

*New host-record.* Numerous protonymphs, nasal cavities, *Antechinus swainsonii*, Kosciusko National Park, N.S.W., 12.vi.1975, D. M. Spratt, and Powelltown, Vic., 5.iii.1974, I.B.

#### Genus TRICHOSUROLAELAPS Womersley

*Trichosurolaelaps* Womersley, 1956, *J. Linn. Soc.*, 42 : 564. Type-species *T. crassipes* Womersley, 1956.

#### *Trichosurolaelaps bakeri* Mitchell and Strandtmann

*T. bakeri* Mitchell and Strandtmann, 1964, *J. Med. Entomol.*, 1 : 126.

*Material.* Two ♀♀ from bandicoot, *Echymipera rufescens* (Peters and Doria), Yambi, 32 km S of Maprik, P.N.G., 23.v.1962, K.K.

*Notes.* This confirms the original host, see Tenorio and Radovsky (1973).\*

\* Presumably the confirmed host identification given by these authors for *T. domrowi* Mitchell and Strandtmann supersedes that supplied to Domrow (1966a).

*Trichosuroaelaps emanuelae* Domrow  
(Figs. 65-70)

*T. emanuelae* Domrow, 1958, *Proc. Linn. Soc. N.S.W.*, 82 : 355.

*Material.* Six ♀♀, one deutonymph, and two larvae, *Echymipera kalubu*, Upau River, Maprik, P.N.G., 28.xi.1962, K.K. Four ♀♀, *E. kalubu*, Kaminibus, 5 km W of Maprik, 7.vi.1963, K.K. Six ♀♀, *E. kalubu*, Maprik, 20.iii.1964, K.K.

*Deutonymph.* Capitulum not conveniently arranged for illustration, but essentially as in ♀ (Fig. 67); 135 long, basis 66 wide at midlength (incipient

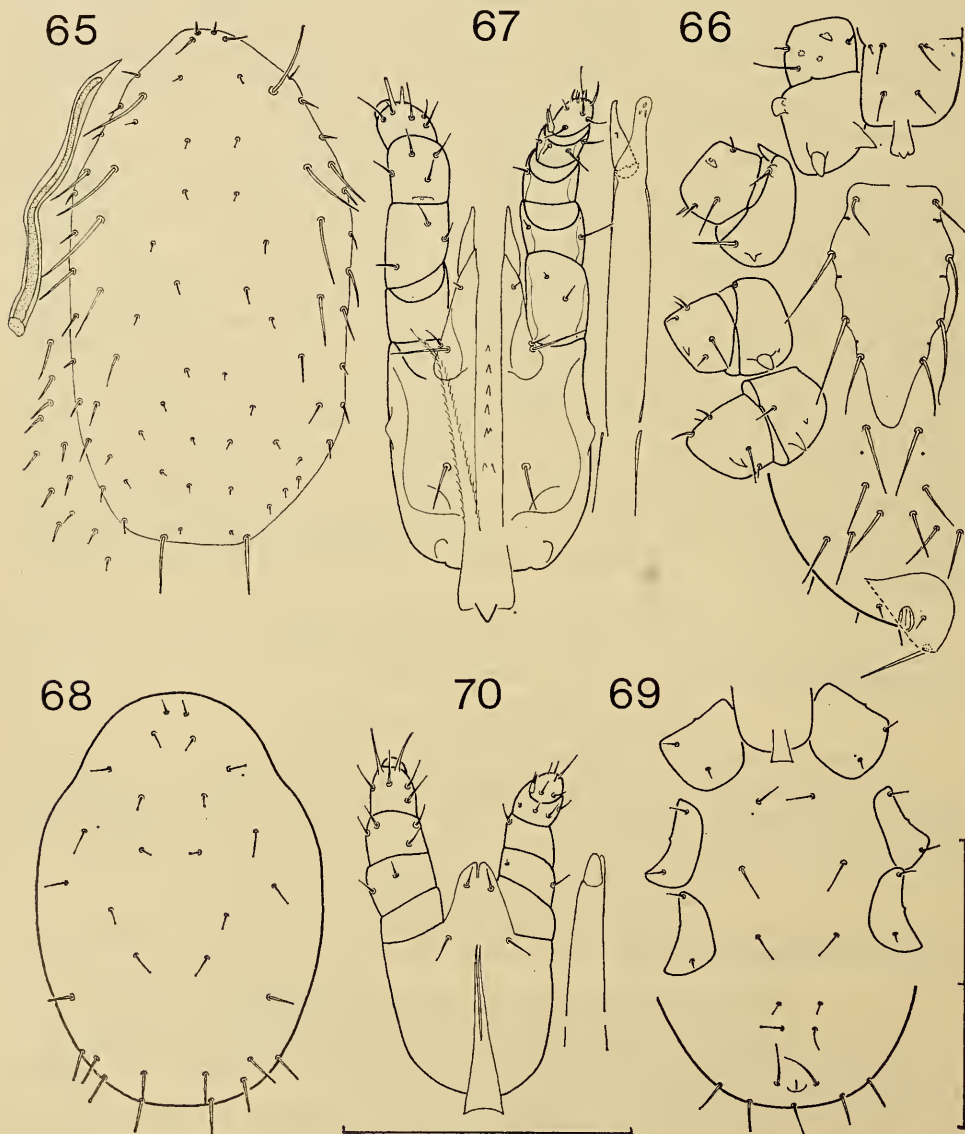

Figs 65-70. *Trichosuroaelaps emanuelae*. 65-66, Idiosoma in dorsal and ventral views, deutonymph. 67, Capitulum in ventral view, with true right palp shown dorsally and inset of chelicera in dorsal view, ♀. 68-69, Idiosoma in dorsal and ventral views, larva. 70, Capitulum in ventral view, with true right palp shown dorsally and inset of chelicera in ventral view, larva.

lateroventral bosses absent). Basis with setae *c* not quite reaching its sides. Deutosternum with about six denticles, mostly in single file. Hypostome with setae  $h_3 > h_2 > h_1$ , lattermost minute. Labial cornicles small, but distinct and well formed. Salivary stylets present. Epistome diaphanous; no ornamental margin detected. Palpal setal formula (trochanter-tibia) 2.5.5.c.11, *i.e.* genu unidifferent ( $al_2$  lacking as in ♀; but note that this segment is holotrichous in preceding species, *T. bakeri*), and tibia lacking about three setae. Chelicerae 110 long; digits 22–24 long. Fixed digit pale and edentate, though with some small sclerotizations distally. Movable digit more strongly sclerotized and well shaped, showing small denticle at midlength in addition to incurved tip.

Idiosomal length unavailable because of fracture, but dorsal shield (Fig. 65) 357 long, 193 wide, unincised laterally. Shield with 38\* pairs of setae as in ♀ (Domrow, 1966a), *i.e.* lacking only  $z_1$  compared with holotrichous condition. Some setae in *z*, *s*, and *r* series enlarged, intermediate in condition between that of ♀ and ♂. One side lacking setae  $z_3$  and  $px_3$ , and also (as far as can be seen) with some irregularity at sites  $S_{4-5}$ . Dorsal cuticle with about 12 pairs of setae of decreasing length posteriorly.

Tritosternum (Fig. 66) with median, posteriorly directed spine on base. Sternal shield elongate, with sinuous lateral margins and distinctly tapered posteriorly; bearing four pairs of setae (second and third pairs longest) and three pairs of pores along margin. Pregenital setae and pores free in cuticle. Anal shield damaged, but postanal seta considerably stronger than adanal setae; cribrum present. Ventral cuticle with eight stronger setae set centrally and eight weaker ones marginally. Stigmata and peritremes anticipating those of ♀.

Coxal and trochanteral armature anticipating that of ♀. Leg setation holotrichous, essentially as in ♀, except that anterior seta on coxae II–III not expanded. Distal seta on coxa I strongly modified into rounded flange. One *v* seta on trochanters I–II, and seta  $av_1$  on tarsi II–III, in form of incipient double spur. One *d* seta on femora-genua I–II distinctly longer.

*Larva.* Capitulum (Fig. 70) 115 long, basis 58 wide at midlength. Capitular setae absent. Deutosternal details not clear, but hardly fully developed. Hypostome with setae  $h_{1-2}$  subequal. Labial cornicles incipient. Salivary stylets present. Epistome not detected. Palpal setal formula (trochanter-tibia) 0.4.5.c.10, *i.e.* tibia lacking about two setae. Chelicerae 66 long; digits stout, subequal, edentate, and 10 long.

Idiosoma 285 long, 200 wide. Podonotum (Fig. 68) holotrichous (10 pairs of setae, posteriormost pair thicker). Opisthonotum with five pairs of thicker setae.

Tritosternum 52 long; base unarmed (Fig. 69). Sternum with three pairs of setae, but pores not detected. Adanal setae stronger than postanal seta. Ventral cuticle with four pairs of setae (posteriormost two pairs thicker). Stigmata and peritremes absent.

Legs holotrichous, undistinguished.

*Notes.* This is the type, and usual host, but no immature stages were previously known in this genus.

#### *Trichosurolaelaps marra* Domrow

*T. marra* Domrow, 1972, *J. Aust. Entomol. Soc.*, 11 : 300.

*New host-record.* Four ♀♀, three ♂♂, and one deutonymph (containing developing adult) from greater glider, *Schoinobates volans* (Kerr) (Petauridae), Stanthorpe, Qld, 1974, G. Wolf.

\* The fifth line of the original description should end "... with 37 pairs of very small setae and one longer pair".

*Notes.* The original series were from two other petaurid genera (*Petaurus* Shaw and Nodder and *Gymnobelideus* McCoy), and *Schoinobates* Lesson itself commonly harbours the following species, *T. fallax* Domrow. However, the present series are not clear examples of museum contamination since, while they were taken from two *S. volans* (QM J3598 and 3600, collected in 1922), a third in the same collection (QM J10090, collected in 1956) yielded only *T. fallax*.

*Trichosurolaelaps fallax* Domrow

*T. fallax* Domrow, 1972, *J. Aust. Entomol. Soc.*, 11 : 302.

*Material.* Nineteen ♀♀, *Schoinobates volans*, near Atherton, Qld, 1974, G.W.

*Notes.* See those on *T. marra*.

Genus THADEUA, n. nom.

*Australaelaps* Womersley, 1956, *J. Linn. Soc.* 42 : 561. Type-species *A. mitchelli* Womersley, 1956.

*Non Australaelaps* Girault, 1925, *Insect. Inscit. menstr.* 13 : 96. Type-species *A. aeneiceps* Girault, 1925 (Hymenoptera).

*Thadeua serrata*, n. sp.

(Figs 71–73)

*Types.* Holotype ♀ and one paratype ♀ from swamp wallaby, *Wallabia bicolor* (Desmarest) (Marsupialia : Macropodidae), Marlo Plains, Vic., 8.iv.1974, I.B. Holotype in Australian National Insect Collection, CSIRO, Canberra ; paratype in author's Institute.

*Female.* Capitulum (Fig. 73) slender, unarmed, and weakly sclerotized, except for posteroventral third of basis ; 132 long, basis 67 wide. Setae *c* and *h*<sub>1–3</sub> as in *T. rosamondae* Domrow, 1973, but former somewhat stronger. Hypostomatal processes not clear, but reaching forward to level of distal ends of palpal genua ; labial cornicles certainly not distinctly horn-like. Deutosternum with five rows of denticles, all single except anteriormost. Epistome not discernible. Palpi of normal proportions, but with hypotrichous setation (probably 2.3.6.8, trochanter-tibia, including dorsodistal tibial rods). Chelicerae not clear, but digits apparently edentate.

Idiosoma 437 long, 261 wide including stigmata. Dorsal shield (Fig. 71) parallel-sided, 405 long, 186 wide ; hypotrichous, with 34 pairs of setae (seta *j*<sub>3</sub> lacking on one side of specimen figured). These comprise 19 podonotal pairs (*z*<sub>1</sub>, *z*<sub>3</sub>, and *r*<sub>4</sub> lacking), and 15 opisthonotal pairs (*px*<sub>2–3</sub> lacking). Setae *j*<sub>1–2</sub> and *s*<sub>1–2</sub> slightly, and *J*<sub>5</sub> considerably, smaller than remainder. Dorsal cuticle with about three pairs of slender, and three pairs of thickened, setae.

Tritosternum (Fig. 72) as in *T. rosamondae*. Sternal shield not sharply demarcated, but roundly triangular and bearing first two pairs of sternal setae. Third pair of sternal setae and metasternal setae free in cuticle ; no pores detected. Genital shield bearing only genital pair of setae. Anal shield well developed, strongly sclerotized laterally ; anus well forward, largely in front of adanal setae ; postanal seta slightly shorter ; cribrum distinct. Metapodal shields not detected. Ventral cuticle with about 23 pairs of setae ; of these, anteriormost (including three pairs flanking genital shield) are short and slender, those at level of anus are long and slender, and those behind anus are short and distinctly thickened (recalling, to some extent, *Dermanyssus quintus* Vitzthum, see Evans and Till, 1966). Stigmata perhaps better described as without peritremes ; complexly chambered.

Apart from obliteration of anterior seta on coxa II by incipient spine (in addition to anterodorsal spine), setation of legs holotrichous, with one exception,

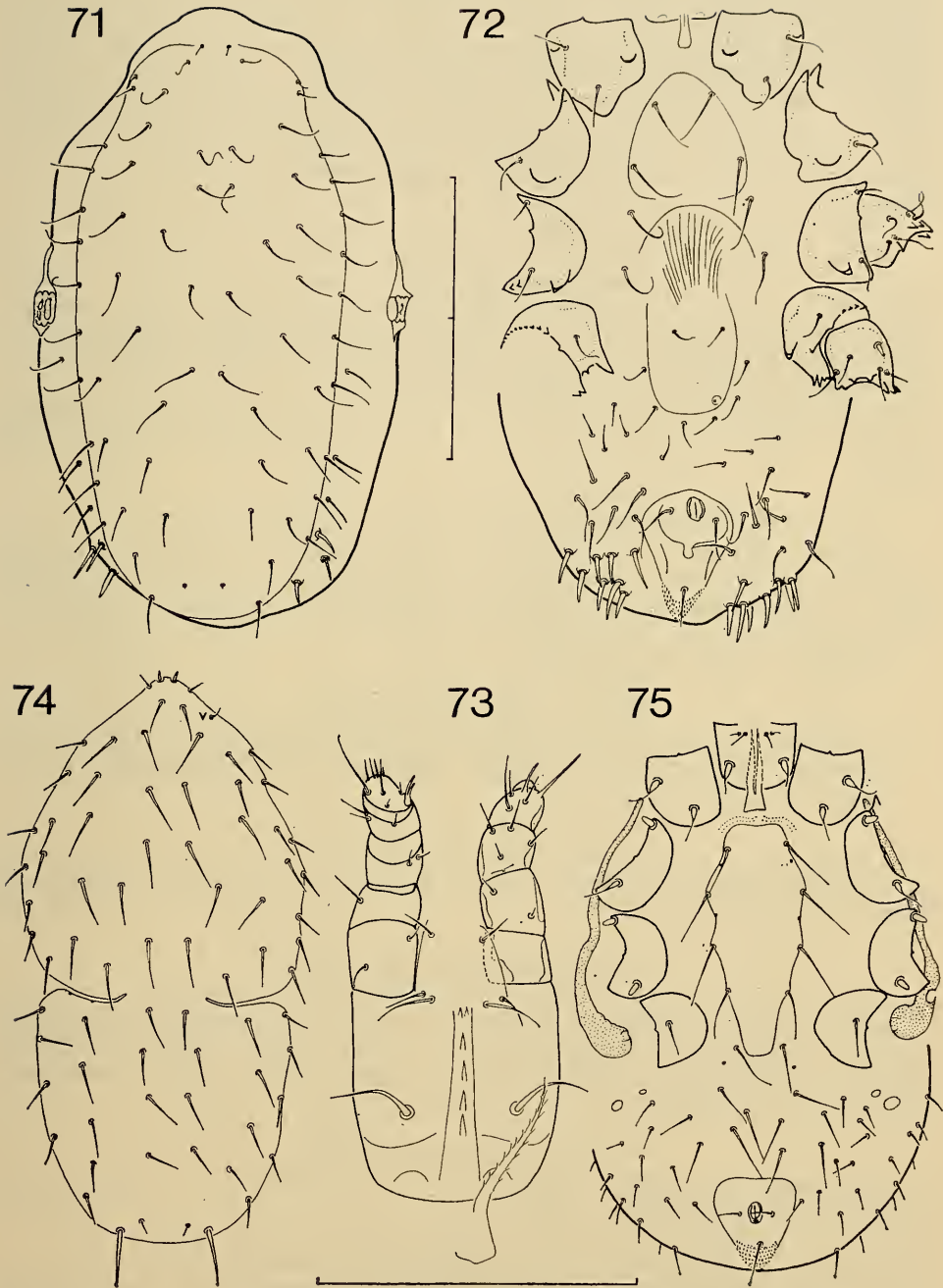

Figs 71-73. *Thadeua serrata*. 71-72, Idiosoma in dorsal and ventral views, ♀. 73, Capitulum in ventral view, with true left palp shown dorsally, ♀. Figs 74-75. *Neolaelaps palpispinosus*. 74, Dorsal shield, deutonymph. 75, Idiosoma in ventral view, deutonymph.

femur II being scored as (2-4/3-1) rather than (2-5/3-1). Apart from occasional minor unidiciencies on femur III, genua I and IV, and tibiae II-III, sole major aberrancy noted was on genu III, viz (1-4/2-0) on one side of one specimen, rather than (2-4/2-1). Seta *al* on trochanter IV, *pl*<sub>1</sub> on genu-tibia I, and two (abnormally one) *pl* setae on tarsus I distinctly spinose. Coxa I with very weak posterior, and weak anterior, boss. Coxae II-IV each with posterior boss or spine, of increasing strength posteriorly. Coxae-trochanters and, to lesser extent, femora-genua III-IV serrate on distal margins. Tarsus II with sub-terminal ventral spine as in known males (but lacking opposed modified seta on femur II).

*Male and immatures.* Unknown.

*Notes.* The only other species of *Thadeua* lacking an enormous hook on coxa II is *T. mitchelli* Womersley, 1956, but *T. serrata* is sharply separable therefrom in showing the following characters: genital shield without usurped ventral setae; opisthosoma with terminal setae distinctly spinose; distal margins of coxae-trochanters III-IV serrate; central segments of legs without retrorse ventral spines; tarsus II with subterminal spine.

As three species of *Thadeua* have now been recorded from the swamp wallaby (Domrow, 1973), I should perhaps add the following (presumably) confirmatory records.

*Thadeua mitchelli* (Womersley)

*Australolaelaps mitchelli* Womersley, 1956, *J. Linn. Soc.*, 42 : 562.

*Material.* Four ♀♀ and one deutonymph from red wallaby, *Macropus rufogriseus* (Desmarest) (Macropodidae), Waterhouse, Tas., 7.x.1973, R.H.G. Five ♀♀, *Wallabia bicolor*, Daylesford, Vic., 9.iii.1972, B. J. Coman. Eleven ♀♀ and two ♂♂, *W. bicolor*, Bemm River, Orbost, Vic., 11.v.1972, P. L. Stevens.

*Notes.* See those on *T. serrata*.

*Thadeua rosamondae* (Domrow)

*Australolaelaps rosamondae* Domrow, 1973, *Proc. Linn. Soc. N.S.W.*, 98 : 80.

*Material.* Two ♀♀, *Wallabia bicolor*, Daylesford, Vic., 9.iii.1972, B.J.C.

*Notes.* See those on *T. serrata*.

Genus BEWSIELLA Domrow

*Bewsiella* Domrow, 1958, *Proc. Linn. Soc. N.S.W.*, 82 : 352. Type-species *B. fledermaus* Domrow, 1958.

*Bewsiella fledermaus* Domrow

*B. fledermaus* Domrow, 1958, *Proc. Linn. Soc. N.S.W.*, 82 : 353.

*New host-record.* Five ♀♀ and five ♂♂ from bat, *Hipposideros calcaratus* (Dobson) (Chiroptera: Hipposideridae), Kukuba Caves (8°55'S, 146°35'E), P.N.G., 31.viii-1.ix.1972, R. L. Vanderwal. Two ♀♀ and one ♂, *H. calcaratus*, same data, but 6.vii.1973, D. E. Moorhouse and G.W.

Genus ICHORONYSSUS Kolenati

*Ichoronyssus* Kolenati, 1858, *Wien. ent. Mschr.*, 2 : 5. Type-species *Dermanissus scutatus* Kolenati, 1856.

*Ichoronyssus miniopteri* (Zumpt and Patterson)

*Neospinolaelaps miniopteri* Zumpt and Patterson, 1952, *J. ent. Soc. sth. Afr.*, 15 : 159.

*New host-record.* Ten ♀♀, seven ♂♂, and four protonymphs from little bent-wing bat, *Miniopterus australis* Tomes (Chiroptera: Vespertilionidae), Rockhampton, Qld, 26.vii.1974, I. Humphery-Smith and M. Tichon.

*Notes.* The protonymph of this species is morphologically inseparable from that of *I. scutatus* (Kolenati) (see Radovsky, 1967), but consistently 25% smaller in dimensions of sclerotized structures, e.g. podonotal shield 177–186 long, 146–155 wide (230 × 210 in *I. scutatus*); interval between setae  $z_3$  (=D3) 84–95 (107–124 in *I. scutatus*). The length of the idiosoma in my unengorged specimens of *I. miniopteri* is 248–278; Radovsky's specimens of *I. scutatus*, slightly engorged to judge from his Fig. 3, measure 390–410.

Genus MACRONYSSUS Kolenati

*Macronyssus* Kolenati, 1858, *Wien. Entomol. Monatsschr.*, 2 : 5. Type-species *Caris longimana* Kolenati, 1856.

*Macronyssus leucippe* (Domrow)

(Figs 76–77)

*Ichoronyssus leucippe* Domrow, 1959, *Proc. Linn. Soc. N.S.W.*, 83 : 227.

*New host-record.* One ♀ and one ♂, *Miniopterus australis*, Rockhampton, Qld, 26.vii.1974, I.H.-S. and M.T.

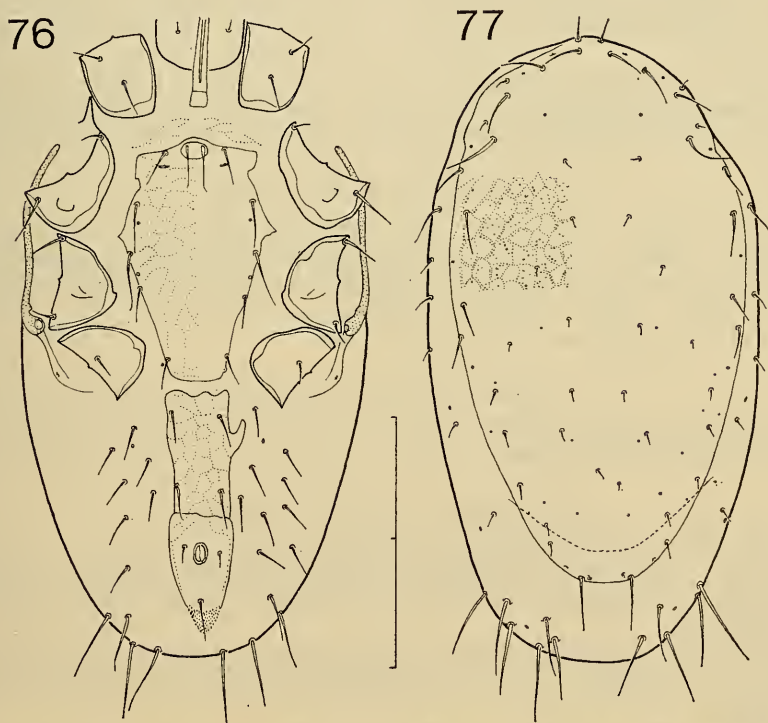

Figs 76–77. *Macronyssus leucippe*. Idiosoma in dorsal and ventral views, ♂.

*Notes.* Setae  $z_6$  on the dorsal shield (present in *M. leucippe*, absent in *M. aristippe*) provide a useful "spot" character. Although both species occur on bats of the genus *Miniopterus* Bonaparte in Australia, the former is much the rarer. Its male was described by Dusbábek (1970), but additional details of the dorsal, and variation in the ventrianal, shield are now illustrated (Figs 76–77). The dorsal shield is free posteriorly (annulate cuticle can be seen under it), but not modified as in the *crobyli* species-group (see Dusbábek and Radovsky, 1972).

*Macronyssus aristippe* (Domrow)

*Ichoronyssus aristippe* Domrow, 1959, *Proc. Linn. Soc. N.S.W.*, 83 : 228.

*Material.* One ♀ and four protonymphs, *Miniopterus australis*, Rockhampton, Qld, 26.vii.1974, I.H.-S. and M.T.

*Notes.* *M. aristippe* has been recorded from this host in New Caledonia (Domrow, 1974), but not in Australia.

## Genus ORNITHONYSSUS Sambon

*Ornithonyssus* Sambon, 1928, *Ann. trop. Med. Hyg.*, 22 : 105. Type-species *Dermanyssus sylviarum* Canestrini and Fanzago, 1877.

*Ornithonyssus bursa* (Berlese)

*Leiognathus bursa* Berlese, 1888, *Boll. Soc. ent. ital.*, 20 : 208.

*New host-records.* Two ♀♀ from rail's nest (probably Lewin water rail, *Rallus pectoralis* Temminck (Gruiformes : Rallidae)), Heron Island, Qld, 21.i.1975, I.H.-S. and L. Conaghan. One ♀ walking on man handling white-capped noddy, *Anous minutus* Boie (Charadriiformes : Laridae), Heron Is., 19.i.1975, I.H.-S. and M.T. Many specimens from nankeen kestrel, *Falco cenchroides* Vigors and Horsfield (Falconiformes : Falconidae), Long Pocket, Brisbane, Qld, 1.vi.1971, D. H. Kemp.

*Notes.* The "several other bird hosts" mentioned by Domrow (1966b) are *F. cenchroides* (confirmed above as a natural host), *Tyto alba*, *Platycercus adscitus*, *Gymnorhina tibicen*, and *Struthidea cinerea* (see Leach, 1958, for systematic position of hosts).

*Ornithonyssus latro* Domrow

*O. latro* Domrow, 1963, *Proc. Linn. Soc. N.S.W.*, 88 : 216.

*Material.* One ♀ and one protonymph from little bat, *Eptesicus pumilus* (Gray) (Vespertilionidae), Carson Escarpment (14°49'S, 126°49'E), W.A., 9-15.viii.1975, I.F.B. Common and M. S. Upton.

*Notes.* This confirms the original record.

## Genus PNEUMONYSSUS Banks

*Pneumonyssus* Banks, 1901, *Geneesk. Tijdschr. Ned.-Indië*, 41 : 334. Type-species *P. simicola* Banks, 1901.

*Pneumonyssus capricorni* Domrow

*P. capricorni* Domrow, 1974, *J. Aust. ent. Soc.*, 13 : 21.

*Material.* One larva from spotted cuscus, *Phalanger maculatus* (Desmarest) (Marsupialia : Phalangeridae), Zoological Gardens, South Perth, W.A., 1975, G. de Chaneet.

*Notes.* This specimen, removed from a faecal extract, could well have been swallowed—the original series was from the trachea of *P. maculatus* in Papua New Guinea.

Sections of lung from a pneumonic scaly-tailed possum, *Wyulda squamicaudata* Alexander (Phalangeridae), also from the Zoological Gardens, South Perth, but housed separately, showed several unidentifiable mites.

## References

- ALLRED, D. M., 1969.—Mites of the genus *Laelaps* of New Guinea (Acari : Mesostigmata : Laelapidae). *J. Med. Entomol.*, 6 : 337-385.  
 Domrow, R., 1958.—New and little known Australasian Laelaptidae (Acarina). *Proc. Linn. Soc. N.S.W.*, 82 : 352-366.  
 ———, 1961.—New and little known Laelaptidae, Trombiculidae and Listrophoridae (Acarina) from Australasian mammals. *Proc. Linn. Soc. N.S.W.*, 86 : 60-95.



- , 1962.—Mammals of Innisfail. II. Their mite parasites. *Aust. J. Zool.*, 10 : 268–306.
- , 1963a.—The genus *Andreacarus* in Australia (Acarina : Laelapidae). *J. Entomol. Soc. Queensl.*, 2 : 9–12.
- , 1963b.—New records and species of Austromalayan laelapid mites. *PROC. LINN. SOC. N.S.W.*, 88 : 199–220.
- , 1966a.—Some laelapid mites of syndactylous marsupials. *PROC. LINN. SOC. N.S.W.*, 90 : 164–175.
- , 1966b.—Some mite parasites of Australian birds. *PROC. LINN. SOC. N.S.W.*, 90 : 190–217.
- , 1967.—Mite parasites of small mammals from scrub typhus foci in Australia. *Aust. J. Zool.*, 15 : 759–798.
- , 1972.—Eight Australian species of *Andreacarus* Radford and *Haemolaelaps* Berlese (Acari : Dermanyssidae). *J. Aust. Entomol. Soc.*, 11 : 105–113.
- , 1973.—New records and species of *Laelaps* and allied genera from Australasia (Acari : Dermanyssidae). *PROC. LINN. SOC. N.S.W.*, 98 : 62–85.
- , 1974.—Miscellaneous mites from Australian vertebrates. 1–48. *PROC. LINN. SOC. N.S.W.*, 99 : 15–35.
- DUSĀBEK, F., 1970.—Mite parasites (Acarina) of bats from Afghanistan. *Folia parasitol., Prague*, 17 : 61–76.
- , and RADOVSKY, 1972.—*Macronyssus heteromorphus* (Acarina : Macronyssidae) a new species from the Kuril Islands. *J. Med. Entomol.*, 9 : 575–579.
- EVANS, G. O., 1969.—Observations on the ontogenetic development of the chaetotaxy of the tarsi of legs II–IV in the Mesostigmata (Acari). *Proc. II Int. Congr. Acarol.* (1967), 195–200.
- , and TILL, W. M., 1965.—Studies on the British Dermanyssidae (Acari : Mesostigmata). Part I. External Morphology. *Bull. Br. Mus. Nat. Hist. (Zool.)*, 13 : 247–294.
- , 1966.—Studies on the British Dermanyssidae (Acari : Mesostigmata). Part II. Classification. *Bull. Br. Mus. Nat. Hist. (Zool.)*, 14 : 107–370.
- HERIN, C. S., 1974.—The taxonomic status of *Hirstionyssus butantanensis* (Fonseca, 1932) (Acari : Mesostigmata). *J. Med. Entomol.*, 11 : 341–346.
- HORNER, B. E., and TAYLOR, J. M., 1965.—Systematic relationships among *Rattus* in southern Australia : evidence from cross-breeding experiments. *CSIRO Wildl. Res.*, 10 : 101–109.
- LAURIE, E. M. O., and HILL, J. E., 1954.—*List of land Mammals of New Guinea, Celebes and adjacent Islands*. 1758–1952. London : British Museum (Natural History).
- LEACH, J. A., revised by MORRISON, P. C., 1958.—*An Australian Bird Book*. Melbourne : Whitcombe and Tombs.
- MRČIAK, M., 1974.—Description of *Laelaps dolomydis* n. sp. (Acarina-Gamasoidea) from *Dolomys bogdanovi* in Yugoslavia. *Annotnes Zool. Bot.*, 90 : 1–13.
- RADOVSKY, F. J., 1967.—The Macronyssidae and Laelapidae (Acarina : Mesostigmata) parasitic on bats. *Univ. Calif., Berkeley, Publ. Entomol.*, 46 : 1–288.
- RIDE, W. D. L., 1970.—*A Guide to the native Mammals of Australia*. Melbourne : Oxford University Press.
- TENORIO, J. M., and RADOVSKY, F. J., 1973.—Two new species of *Trichosuroloaelaps* (Acarina : Laelapidae, Hirstionyssinae) from New Guinea. *J. Med. Entomol.*, 10 : 147–157.
- , 1974.—The genus *Mesolaelaps* (Laelapidae : Mesolaelapinae, n. subfam.) with descriptions of two new species from New Guinea. *J. Med. Entomol.*, 11 : 211–222.
- TILL, W. M., 1963.—Ethiopian mites of the genus *Androlaelaps* Berlese s. lat. (Acari : Mesostigmata). *Bull. Br. Mus. Nat. Hist. (Zool.)*, 10 : 1–104.
- TIPTON, V. J., ALTMAN, R. M., and KEENAN, C. M., 1966.—Mites of the subfamily Laelaptinae in Panama (Acarina : Laelaptidae). In Wenzel, R. L., and Tipton, V. J., (Eds.), *Ectoparasites of Panama*. Chicago : Field Museum of Natural History, 23–81.
- WILSON, N., 1967.—Acarina : Mesostigmata. Dermanyssidae, Laelapidae, Spinturnicidae parasitic on vertebrates. *Insects Micronesia*, 3 : 133–148.
- WOMERSLEY, H., 1955.—The Acarina fauna of mutton birds' nests on a Bass Strait island. *Aust. J. Zool.*, 3 : 412–438.
- , 1956.—On some new Acarina-Mesostigmata from Australia, New Zealand and New Guinea. *J. Linn. Soc. (Zool.)*, 42 : 505–599.

SIR WILLIAM MACLEAY MEMORIAL LECTURE, 1976\*

THE BIOGEOGRAPHIC BASIS OF NATIONAL CULTURES

CHARLES A. FLEMING†

In November 1851, T. H. Huxley wrote to William Macleay in Sydney that he had been working "in all things with a reference to wide views of zoological philosophy" and writing reports to explain his ideas of individuality among the lower animals. He chose this subject for his first public lecture, to the Royal Institution, when he faced a unique audience composed of scientists of several disciplines and of London's high society (Jensen, 1976). Tonight I face a similar challenge, with the additional task of producing, from a lifetime as a New Zealand naturalist, something digestible to a New South Wales audience quite as interdisciplinary and quite as distinguished as a Royal Institution audience of 1851. In the century and a quarter that has passed since then, science has gone through a cycle of increasing specialisation but the generalist is once more in favour, so that we can once again emphasise the unity of nature and aspire to know less and less about more and more.

My theme is not the individuality of animals but the individuality of whole biotas and of cultures and the contribution made to cultural individuality by the differences in the character of the wilderness and its inhabitants on opposite sides of the Tasman Sea, differences that result from their different biogeographic histories. Culture is defined as "the development of those qualities that characterise our humanity", so much of our culture is not national but universal and international.

My text and inspiration come from an essay by the American naturalist Aldo Leopold, printed with his *Sand County Almanac* (1966) "a little cockleshell of a book" (as W. H. Hudson (1915) called *The Natural History of Selborne*) that seems likely to survive the storms of time just as well as Gilbert White's classic.

"Wilderness", wrote Aldo Leopold, "is the raw material out of which man has hammered the artifact called civilization". In different parts of the world "wilderness was very diverse, so the resulting artifacts are very diverse. These differences in the end product are known as cultures. The rich diversity of the world's cultures reflects a corresponding diversity in the wilds that gave them birth".

This statement gives a logical basis for a values concept, and even if only partly true, it may have a contribution to make to a world where the importance of facts is recognised but where value judgements (except for that will-o-the-wisp "truth") tend to be repudiated as subjective.

The indigenous bases of culture have often been obscured by the export of cultural images by dominant nations. This happened with the lion, which once ranged throughout the greater part of Europe, West Asia and Africa, but became progressively restricted before and during the historic period. The mediaeval bestiary fell open at the chapter on the lion, royal beast of virtue which Richard I introduced into British heraldry as an almost legendary animal. In earlier

---

\* Delivered on 12th August 1976 in the Science Centre, Sydney.

† New Zealand Geological Survey, Department of Scientific and Industrial Research, Lower Hutt, New Zealand.

centuries, however, Babylon, Assyria, Mycaenae, Delos, and Asia Minor knew the lion as a wild animal, giving it a prominent place in their sculpture. One small figurine, from Aspendos in Turkey, is carved from calcilutite originally deposited in the Tethys Sea, reminding us that available indigenous raw materials have always played an important part in encouraging or limiting developments in art or technology. For instance, the famous 12th Century chessmen from the Isle of Lewis, Romanesque (and thus derivative) in design, are carved in walrus ivory and thereby identified as a product of northern Europe, since the walrus rarely straggled south of Norway (King, 1964) and its ivory was not traded as extensively as elephant ivory.

As the characteristic ornament of Corinthian capitals, the Greeks reproduced in stone the *Acanthus*, a plant native to the Mediterranean and adjacent regions; it grows well in our New Zealand gardens but has ceased to inspire the sculptor in the Antipodes. One could continue to illustrate the part played by the local wilderness in the art forms or literature of the Old World.

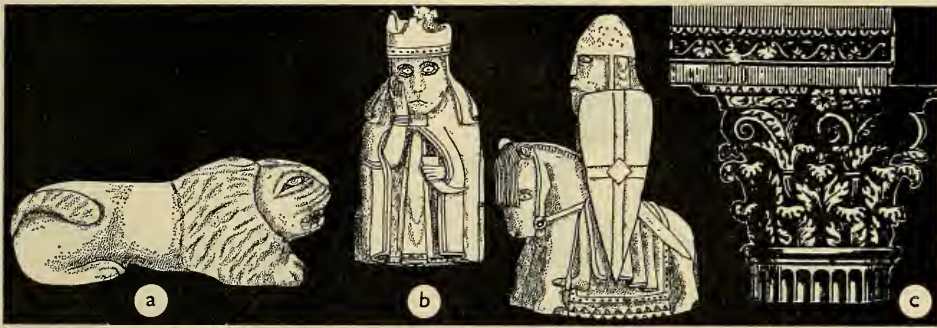

Fig. 1. Lion figurine (125 mm), Aspendos, Turkey (a); Chessmen from the Isle of Lewis, whale ivory, c. 95 mm (British Museum) (b); *Acanthus* ornament on Corinthian capital (c).

Let us come nearer our own time and our own place. All immigrants to our lands brought with them the memory of a voyage and their earlier environment (Holcroft, 1943). In eastern Polynesia the breadfruit (*Artocarpus*) replaced the yam (*Dioscorea*) as the staple source of carbohydrate food. In Polynesian tradition, the migration of the Arawa Canoe to New Zealand was the result of a theft of breadfruit. Te Rangihiroa (Sir Peter Buck), bridge builder between New Zealand's two cultures, records (1974) an ancient dirge: "Sacred tree of Hawaiki, the home land, on the other side of Tahiti Nui, the *kuru* or breadfruit tree that sheltered the house of Uenuku, the high chief". A young man named Tamatekapua and his brother stole its fruit by night and as a result his people were forced to emigrate to New Zealand where the story was handed on. But in a land where the breadfruit did not grow the elders had difficulty in explaining what the *kuru* was and substituted the *poroporo*, two species of *Solanum*, familiar blue-flowered shrubs on both sides of the Tasman with berries sometimes eaten by Maori children. *Te poroporo whakamarumarū o Uenuku*, the sheltering poroporo of Uenuku (*Solanum aviculare* or *S. laciniatum*) now contributes to contemporary culture as a source of a glycoside called solasonine, a most promising raw material for the production of steroid drugs (Lancaster and Mann, 1975) including reproductive hormones increasingly demanded by birth control programmes (Fawcner, 1974).

For new countries, colonised from afar, the relationship between culture and nature has not been easy to accept. In Australia, older and more mature as a

nation than New Zealand, quite an extensive literature has appeared on cultural development, in which national and international phases seemed to alternate. Naturalists on both sides of the Tasman are likely to agree (in my opinion) with A. G. Serle (1973) that: "Culture and everything else begins from scratch in a new country, despite the inheritance of the whole of European and English culture", and "Culture is a highly perishable growth, which, transplanted, cannot bloom as before".

The same west European (mainly British) people brought to Australia and New Zealand memories of Yule logs and Christmas robin redbreasts as inappropriate as hot plum pudding in a southern December, yet the two environments on either side of the Tasman were sufficiently different to ensure different cultural products. To this, differences between Australia and New Zealand in physical geography, climate, and biology have all contributed. But it was not always so.

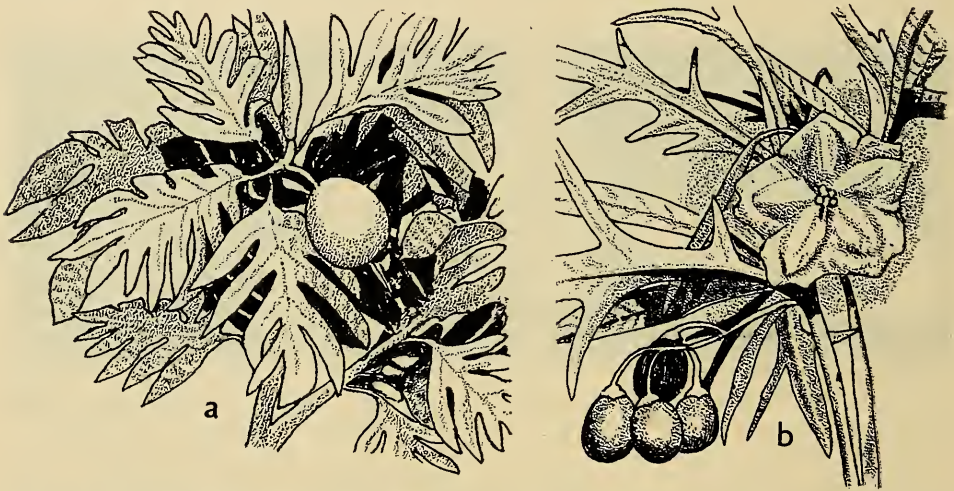

Fig. 2. Breadfruit (*Artocarpus*) (a), and Poroporo (*Solanum laciniatum*), its substitute in the Maori legend of the Arawa Canoe (b).

The concepts of a southern super-continent, Gondwanaland (Suess, 1883–1909), of continental drift (Wegener, 1924) whereby jigsaw pieces of the crust later drifted apart to become the southern lands we know today, of sea floor spreading, and of plate tectonics represent successive stages in our enlightenment, in which the conviction of geologists like S. W. Carey (1958) was confirmed, as new discoveries in sea floor structure overcame the earlier scepticism of geophysicists (see e.g. Heirtzler, 1968 ; Hurley, 1968 ; Hayes and Pitman, 1970). As P. M. S. Blackett (1965) once commented: "in complex subjects a highly simplified model which can explain a large number of facts is invaluable, especially when it suggests new observations" which generally force the researcher to make the model more complicated. Reconstructions of Gondwanaland and histories of its disruption still differ in detail but the degrees of freedom have progressively diminished as detailed analyses and interpretations bring in more and more factors to control the "fit".

From the Permian to the Jurassic, when disruption began, Gondwanaland certainly shared a common biota. Its unity persisted as it changed during the Cretaceous while the early phases of drift took place. Permian *Glossopteris* vegetation gave way to Triassic *Dicroidium* vegetation and then in the Cretaceous

to the forbears of living ferns and conifers—araucarians and podocarps—and soon afterwards to the first angiosperms, including *Nothofagus* southern beeches and an abundance of Proteaceae. The fauna included lungfishes, primitive amphicoelan frogs, the ancestors of monotremes and of ratite birds, dinosaurs and other reptiles such as rhyngocephalians. Perhaps we have exaggerated the uniformity of Gondwanaland, which certainly was at times broken up by epicontinental seas (Teichert, 1974) and was probably quite diverse in climate and vegetation so that not all parts necessarily had precisely the same biota; but what evidence we have indicates substantial uniformity, which is why Suess invented Gondwanaland to begin with. Africa, the first continent to break away, took with it a lungfish, the two-toed ratites (which were subsequently shared with Eurasia), Proteaceae and podocarps, apparently before *Nothofagus* beeches and marsupials had evolved.

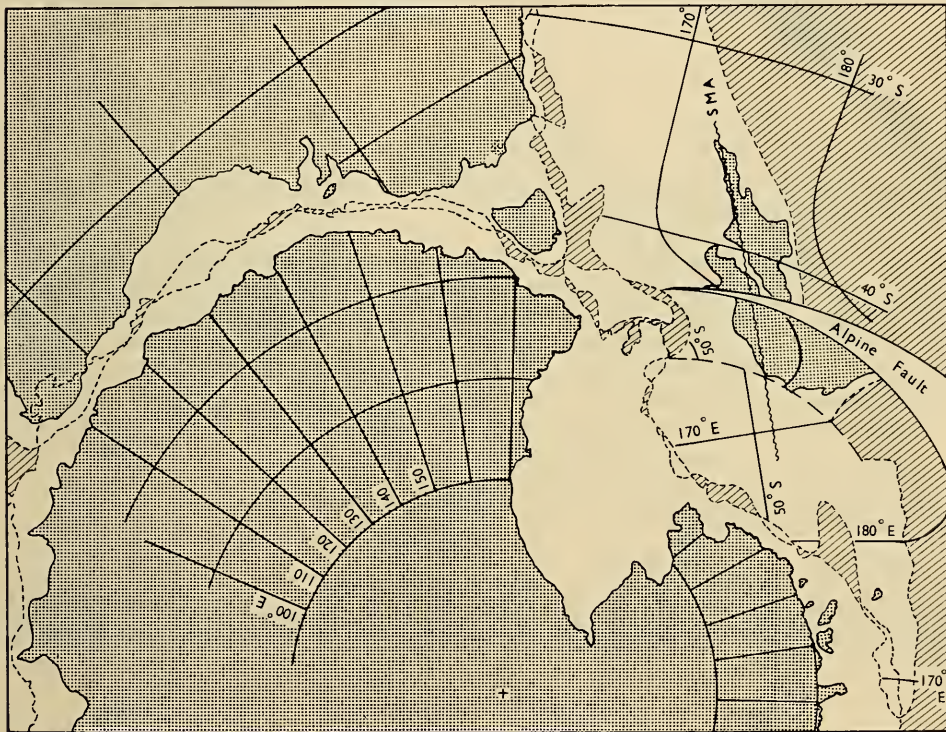

Fig. 3. The Australasian part of Gondwanaland. An assembly by R. A. Cooper (N.Z. Geological Survey) using a reconstruction of New Zealand by H. W. Wellman (1975).

Differentiation of the plants and animals in different Gondwana fragments proceeded as they separated. "Sweepstakes" colonisation across marine barriers brought different colonists to different subcontinents. There was a similar "sweepstakes extinction" that resulted from differences in survival, influenced by diverging geography and climates in the Tertiary. For much of the Tertiary Australia and New Zealand vegetation was similar, warm temperate to subtropical rain forest with dominant *Nothofagus* and podocarps and with many other common elements including araucarians and proteaceous plants and ratites.

Already, before the end of the Mesozoic, some 65 million years ago, plants and animals that contribute to our national cultures were established on either

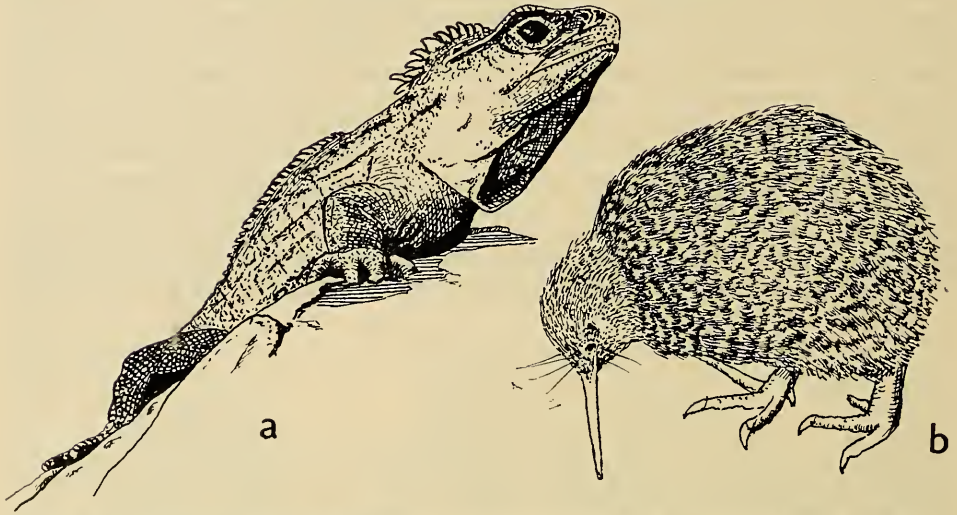

Fig. 4. *Sphenodon*, the Tuatara, last of the Rhyncocephalia (a), and the Kiwi (*Apteryx*) (b) descendants of the Gondwanaland fauna.

side of a Tasman Sea that had just begun to develop, but there were fewer contrasts in climate, vegetation and presumably fauna than there are today. Both countries share some of the Mesozoic tree ferns (mamaku and ponga in New Zealand) which characterise the rain forests on both sides of the Tasman and which inspired the New Zealand poet A. R. D. Fairburn (1966) to write "Conversation in the Bush":

Observe the young and tender frond  
of this punga : shaped and curved  
like the scroll of a fiddle : fit instrument  
to play archaic tunes.

I see  
the shape of a coiled spring.

Australia must have had ancestors of such Proteaceae as *Banksia* and *Macadamia* that have undoubtedly been modified subsequently in adaptation to a drier climate.



Fig. 5. Tree-fern (*Cyathea*) with new frond "curved like the scroll of a fiddle; fit instrument to play archaic tunes" (A. R. D. Fairburn) (a). "The Banksia men make a wicked plot" (after May Gibbs) (b).

As a child in New Zealand, fifty years ago, I was scared by May Gibbs' wicked Banksia men (Gibbs, 1946) in the absence of a local children's literature of our own. New Zealand lost most of its Proteaceae during the late Tertiary cooling, the surviving toru (*Toronia*, Johnson and Briggs, 1975) and rewarewa (*Knightsia*) contributing less to our cultural life than the somewhat fuller complement of late Gondwanaland softwoods, which remained to become the "immense woods of as stout lofty timber as is to be found in any other part of the world" over which Captain Cook enthused in 1769 (Beaglehole, 1965).

Kauri (*Agathis*), totara (*Podocarpus*), and rimu (*Dacrydium*) were the raw materials for buildings, public and domestic, in the colonial period, often encouraging reproduction of stone architectural features in wood, a characteristic well illustrated by the cathedral church of St. Paul in Wellington (Alington, 1965). The development of what we may call "Podocarp Gothic" was fostered by general lack of building stones near New Zealand settlements.



Fig. 6. "Podocarp Gothic" interior of Old St. Paul's, Wellington (1866), drawn by W. H. Alington (a). Pioneer farm house, "Kauri Classical" urban façade, and Selwyn Church (after Juliet Peters) (b).

The history of much of New Zealand landscape also applies to many parts of Australia—the felling and occasional milling of the forest prior to burning, the pioneer house set among gaunt blackened trunks, the wide spectrum of architectural styles, with the Indian verandah imported in response to abundant sunshine. Podocarp Georgian and Kauri Classical façades fronted urban buildings walled in corrugated iron at the back (out of sight) and in New Zealand Bishop Selwyn designed a standard colonial church for country villages. It is all part of a new land's history but how much of this is really national when the forest has gone?

The rich timber resources were squandered as the land was cleared wastefully and often unwisely for pasture, locally on slopes of highly erodable sedimentary rocks, leading to serious sheet and gully erosion (Cumberland, 1947). In both our countries, the "western" idea of a struggle against nature too long prevailed over the still older cult of forests that led to reservation of hunting preserves, the sacred copses of Diana (Frazer, 1922), avenues of Japanese *Cryptomeria*, the temple ginkgos of China, and the tapu groves around Pacific marae (Fosberg, 1975). In both our countries, ignorant or overkeen land use led to land abuse. Destruction of native forests continues today for chipboard and pulp industries. "Are we to assume", asks the New Zealand writer M. H. Holcroft, "that a people which possessed the land in this manner—raping it in the name of progress—can remain untroubled and secure in occupation?". Conservation is more than practical remedies to soil erosion (Allsop, 1973)—it is the symptom of uneasiness, of a growing realisation that a new land cannot be exploited with impunity (Holcroft, 1948).

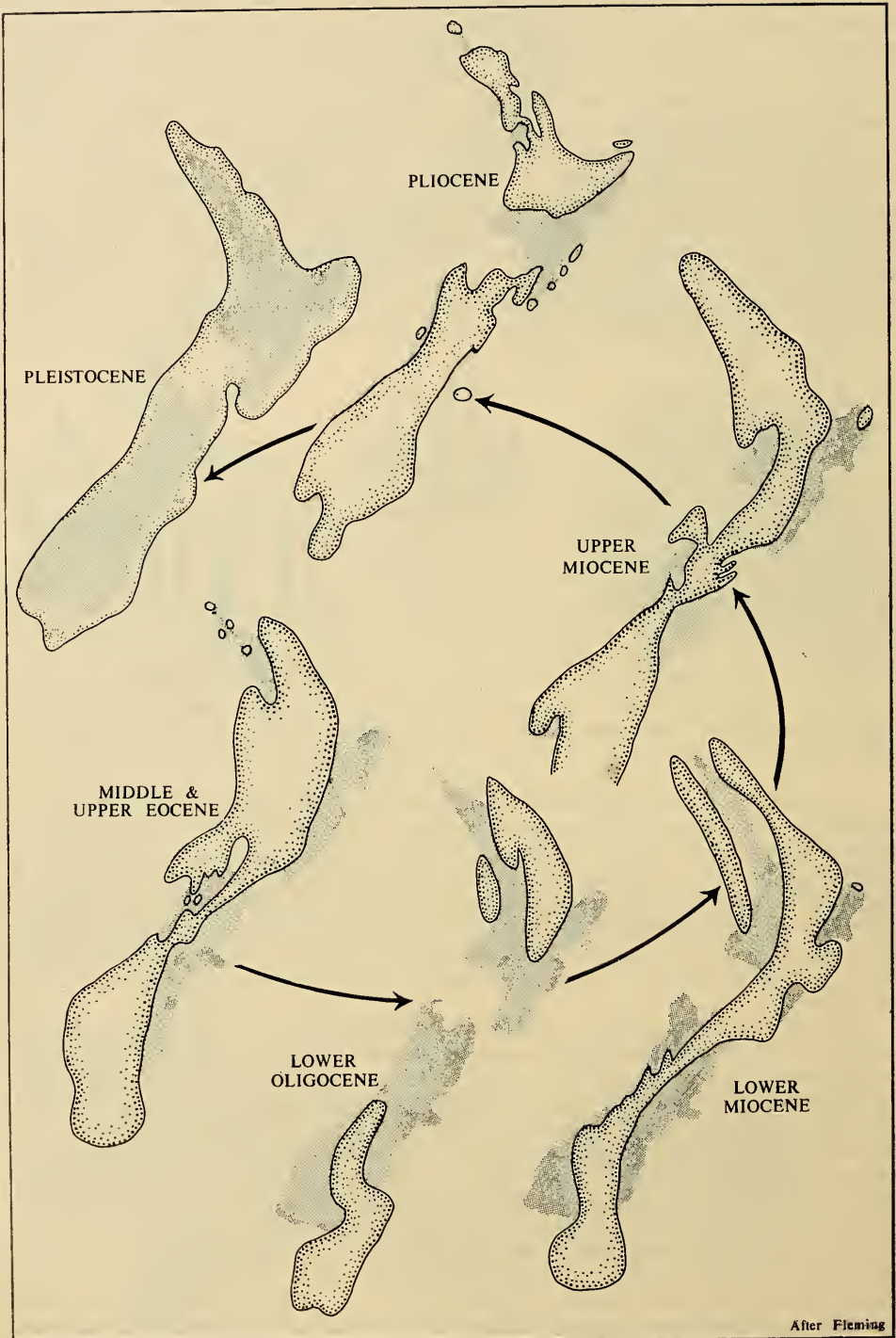

Fig. 7. The changing archipelago of New Zealand during the Cenozoic.



It would accord well with the biogeographic evidence if the Gondwana fragments (apart from Africa) remained linked via a temperate Antarctica, long enough to permit the well documented dispersal of southern beeches of three *Nothofagus* species-groups in the Upper Cretaceous (Couper, 1960) and presumably also of the ratites, but not long enough for New Zealand to receive the doubtful blessing of marsupials and snakes (which have an inadequate fossil record to date their arrival precisely). On the other hand no such juggling with the time-scale can account for the absence from New Zealand of monotremes, which G. G. Simpson (1961) believes reached Australia in late Triassic or Jurassic times.

In the Oligocene New Zealand was reduced to a number of rather small islands (Fleming, 1975). Monotremes (or any other organisms) might then have been eliminated in the almost random extinctions postulated by the theoretical discussion of island populations we owe to McArthur and Wilson (1967), recently confirmed by J. M. Diamond from direct observations (1972, 1973).



Fig. 8. Heraldic lion, Tuatara (*Sphenodon*), and Thylacines in the coats of arms of the Town of Wanganui (a) and the State of Tasmania (b).

Some such random extinction and survival—or at least it often seems random but is probably deterministic—left New Zealand with primitive frogs and *Sphenodon* (the tuatara) but no lungfish or monotremes. Evolutionary divergence and adaptation to contrasting environments resulted in many other differences—for instance among the ratites, the emus, casuaries and extinct dromornithids of Australia and the extinct moas and nocturnal forest-dwelling kiwis of New Zealand (Fleming, 1974).

The zoological interest of the legacies from Gondwanaland is not always matched by their cultural significance, but heraldry delights in rare or imaginary animals. The tuatara is a supporter in the arms of the New Zealand city of Wanganui, sharing the honour with the heraldic lion of mediaeval Europe. Wellington uses the extinct moa, probably imitating the emu as supporter in the Australian arms. Tasmania has a pair of thylacines. I want to make the point that the only nationally distinctive elements in these national, state and civic emblems are the indigenous organisms; the rest are trite relics of mediaeval heraldry. Heraldry itself is trite, if not extinct, succeeded in the modern world by advertising, in which our biological symbols, Australian kangaroo and New Zealand kiwi, still find a role on such diverse products as adhesive labels, boot polish and breakfast cereals.

As our two countries drifted towards their present relationship with each other and the rest of the world, their biotic contrasts increased. Marine transgression in subsiding basins before Australia reached the horse latitudes merely

delayed the onset of savanna and desert climates (Rich, 1975). In New Zealand, however, a rapidly changing archipelago never produced rain-shadow deserts so that closed-canopy forests persisted, their dominant trees varying from podocarps to *Nothofagus* of the *fusca* or of the *brassi* groups, the latter now restricted to Papua New Guinea and New Caledonia. While Australian marsupials, birds and reptiles radiated adaptively to fill diverse ecological niches, in New Zealand ratites (especially moas) and other birds did the same, although few of the products of such radiation have survived until today.

In the absence of mammals, some of the niches normally occupied by mice and voles were filled by the giant wingless Orthoptera (related to those known in Australia as king crickets) which we call wetas. These "invertebrate mice", as H. N. Southern once called them, are nocturnal browsers on foliage which



Fig. 9. Tree Weta (*Hemideina megalcephala*) on *Macropiper* leaf. Woodcut by the late E. Mervyn Taylor (copyright).

have adaptively radiated to occupy diverse habitats in coastal scrub, lowland forest, subalpine meadow and alpine fellfield, retreating to holes in trees, burrows and rock crevices by day, and producing droppings hard to distinguish from those of rodents. The largest have the biomass of a small rat, and I can assure you that they are twice as frightening to a child on actual encounter as May Gibbs' Banksia men.

When Australia began to butt against the arc of Indonesia it gained a more ready access to the biological treasures of the Orient than New Zealand has ever attained. With a very complete fossil record of marine organisms and terrestrial plants (mainly through their pollen), we have built up a register of new appearances, thus presumptive colonisations of New Zealand, through Tertiary time. No one has yet performed the same exercise for Australia. When newcomers are classified according to their probable source area, we find a

Malayo-Pacific tropical element reaching its maximum in the Miocene, together with circumpolar old and young Austral elements. In addition there was always a substantial and sustained influx of Australian colonists. Among birds, which have no fossil record to speak of, the Australian element is represented, for instance, by three endemic genera of honey-eaters, one of which, the New Zealand bellbird, is sufficiently like an Australian *Meliphaga* in behaviour as well as appearance to authenticate its origin.

Bellbird enjoyed the party with other New Zealand forest birds, invited by an English sparrow, who had been exploring New Zealand bush in Mollie Atkinson's classic "Richard Bird in the Bush" ([1944]), "written for Richard, age four, who came from England". This children's book is full of rhyming more memorable than many of last century's sentimental adult verses on the New Zealand bellbird, which were far outdistanced by Kendall's poem on Australian bellbirds.

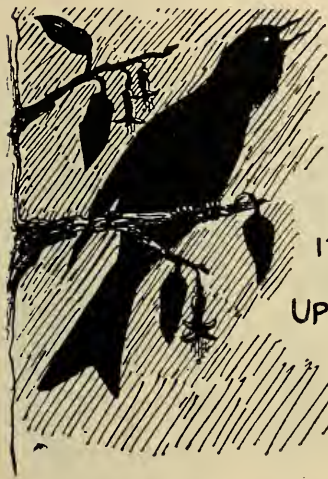

THEN AS THE DARKNESS  
 BEGAN TO FALL,  
 OUT OF THE DISTANCE SOUND-  
 ED A CALL  
 LIQUID, CLEAR, LIKE A GOLDEN BELL,  
 ECHOING OUT OF THE FUCHSIA DELL,  
 IT WAS BELL-BIRD SINGING HIS  
 EVENING HYMN,  
 UP IN THE FOREST, GREEN AND  
 DIM.

Fig. 10. New Zealand Bellbird (*Anthornis melanura*), a representative of Australian Honey-eaters (from Atkinson, 1944).

I suspect the history of Australian life, when the fossil data from Tertiary deposits in Victoria and South Australia are analysed, will be essentially similar to New Zealand's, but since New Zealand projects further south, in the long run it received more Austral circumpolar elements than Australia. Southern Ocean seals, albatrosses and penguins (for instance) may have always meant a little more to New Zealanders, I think, than to most Australians, except in the early days when Sydney was the main port for vessels sealing to the south of New Zealand (and perhaps later when a magazine called *Angry Penguins* was published in Adelaide). Similarly New Zealanders are seldom long out of sight of the sea so perhaps more conscious of it, looking outwards from the sea-shore whereas the Australian looks inwards to the interior. Here is perhaps a reason why the New Zealand Oceanographic Institute published the best compilation I have seen of the bathymetry off the Sydney coast (van der Linden and Herzer, 1975).

On the withdrawal of Tertiary seas from interior basins, Australia's climate eventually became fully continental. Rain forests gave way to savanna and desert as rainfall was reduced. The first recorded fossil *Eucalyptus* seems to be Oligocene (Gill, 1975) and its subsequent adaptive radiation to fill all niches has not yet ended. No other country, let alone continent, has so many of its plant communities dominated by a genus that is so peculiarly its own. Hans Heysen

is said to have made the gum tree the symbol of Australian art, after a period when colonial artists failed to capture its spirit, making the Australian bush (and the New Zealand bush for that matter) look like the Bois de Boulogne, but its cultural influence began with Joseph Banks right in the beginning, and has continued unbroken,

While from a gully down the glen,  
The foliage of the dull-leaved trees  
Rises to view, and the calm air,  
From stillness for a moment waked  
By parakeets' harsh chattering,  
is hushed again.

That was Alexander Bathgate, a New Zealand poet cited in Australian anthologies (e.g. Sladen, 1888), perhaps thanks to the Bank of New South Wales which employed him. A. D. Hope, more recently (1939), wrote of



Fig. 11. Adaptation to contrasting environments. Sturt's Desert Pea (*Cyanthus formosus*, Australia) (a) and Red Parrot's Beak (*Cyanthus puniceus*, New Zealand) (b).

A Nation of trees, drab green and desolate grey  
In the field uniform of modern wars.

*Eucalyptus* could not cross the Tasman, but New Zealand had earlier received several other myrtaceous plants including *Metrosideros*, a rain forest genus of trees and vines as spectacular in its season as the Western Australian flowering gums. The rata and the coastal pohutukawa inspired both Maori and Pakeha. A. R. D. Fairburn (1966) remembered from afar the "summer when the coasts bear crimson bloom, sprinkled like blood on the lintel of the land"

The tiny seeds of *Metrosideros* have reached far flung Pacific volcanic islands, including the subantarctic Auckland Islands in post-glacial time and several tropical islands. Its absence from east Australian forests may perhaps be due to its high palatability. The introduced Brushtailed Possum (*Trichosurus*) is blamed for the defoliation and death of trees in several parts of New Zealand

(Holloway, 1959 ; Pracey, 1969 ; Meads, 1976) and is ranked as a noxious animal, whereas it is protected (and rightly so) as a native species in most states of Australia.

By the end of the Tertiary period, Australian and New Zealand landscape, vegetation and animals showed vivid contrasts due to dissimilar topography and climate and the differing, if overlapping, source areas of biological colonisations. The differences were accentuated in the Pleistocene.

Tectonic movements of the Kaikoura Orogeny produced a "land uplifted high", as Abel Tasman described it, transverse to the wet winds from the west ; "the uplifted structure, Peak and pillar of cloud.—O splendour of desolation !" of Allan Curnow (1942). Young soils, ranging in fertility from the skeletal soils of the mountains to the alluvium of flood plains, cloak a landscape of young surfaces (Gage and Soons, 1974) in contrast to the ancient laterite and silcrete soils of Australia. Such contrasts in soils are reflected directly in land use and indirectly in the biotas they support.

Australia is the flattest continent and the driest, but with greater climatic diversity than New Zealand. In response to these differences the same organic stocks sometime diverged—Sturt's desert pea, reminding us of heroic explorations in the desert, contrasts with the Kowhai ngutukaka or parrot's beak of New Zealand's humid north, a species of the same genus *Chianthus*. Similarly the apostle bird of Australian savannas contrasts with the Kokako, which may be its distant cousin in the New Zealand rain forests (Alexander, 1926).

The onset of glacial climates, alternating with periods of interglacial warmth, affected all temperate lands during the past two million years. Having no escape north of 34°S in New Zealand, many less tolerant organisms (e.g. *Casuarina*) retreated, "walked the plank" and were lost for ever, while in Australia they survived and thrived. Alternating high and low sea levels bridged and then flooded the straits, separating the islands of New Zealand and Bass Strait (Keast, 1961) thus increasing the biotic diversity near the barriers by speciation of separated populations. At roughly the same Pleistocene date "the repeated waxing and waning of the dry centre, due to alternation of dry and pluvial periods" (Serventy and Whittell, 1948 ; Serventy, 1972) led to further diversification.

Division of New Zealand into two or more islands, at a time when glacial conditions first set in, led to ecological differentiation of isolated populations to produce alpine derivatives of forest organisms, plant and animal, such as the alpine Kea Parrot derived from the Kaka of the forests (Fleming, 1974, 1975). This alpine parrot impresses its personality on a mountain-loving nation, especially (in the words of James K. Baxter, 1960) on

. . . those who sleep in close bags fitfully  
Besieged by wind in a snowline bivouac :  
The carrion parrot with red underwing  
Clangs on the roof by night . . .

Mostly the Ice Age events accentuated the differences, but not always. Australian colonisations of New Zealand continued, the colonists transported by the relentless westerlies, replacing some of the autochthones exterminated during the equally relentless glacial ages. More bird species have colonised New Zealand since the Neogene than survived from all earlier colonisations (Fleming, 1962), a statistic emphasising the rapid turnover rate of island biotas. And among plants at least, there was some return traffic, to judge by the occurrence of odd species of dominantly New Zealand genera like *Hebe* (Fleming, 1976) and the alpine *Celmisia* in eastern Australia, posing questions of paleoclimatology to provide satisfactory dispersal mechanisms westwards.

The distinctive pollen grains of *Acacia* have recently been discovered in New Zealand in the Pliocene and early Quaternary (Mildenhall, 1972), at a time when more savanna-like vegetation seems to have replaced the closed-canopy forests, at least locally, perhaps in a cool period, but it did not survive. At least one overseas botanist refused to believe this because it upset his theories, but the evidence includes groups or polyads of characteristic cognate pollen grains still cohering and thus too heavy for aerial transport across the Tasman. Moreover, our palynologists can now predict where they will find *Acacia* pollen in the rocks. The poet James McAuley (1946), in the poem "Terra Australis", has provided an apt if unconscious comment when he wrote "the wattle scatters its pollen on the doubting heart . . .".

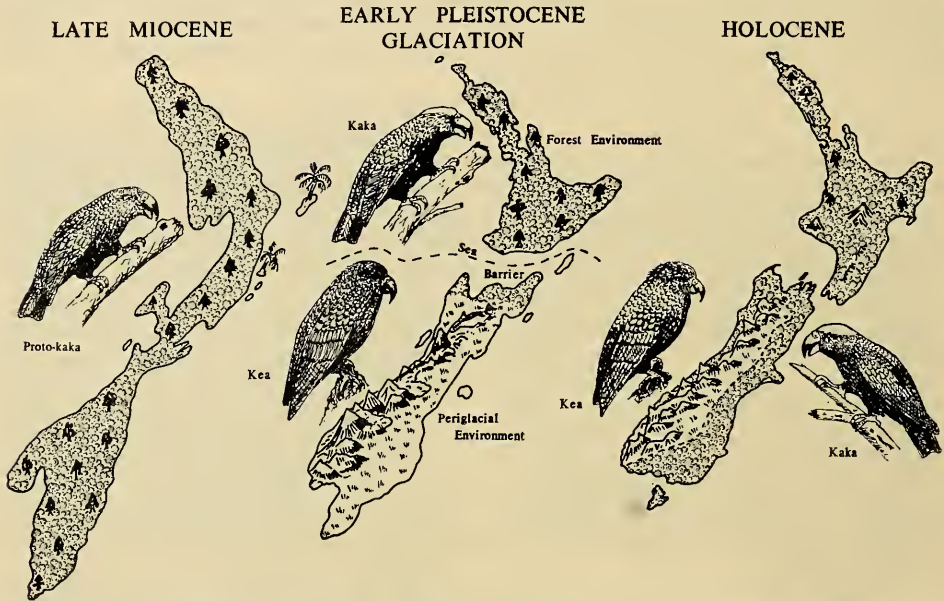

Fig. 12. Speciation in *Nestor* parrots to produce an alpine species, the Kea, living sympatrically with its congener, the Kaka, of lower altitude forests.

In most continents, Pleistocene animals contended not only with ice age climatic fluctuations but with the gradual evolution of one of their members, man, to become an unrivalled competitor and predator. Those animals that survived were invincible. In Australia man came suddenly on the scene across the Timor Strait during the last Ice Age some 30,000 years ago and his traumatic effects on an isolated biota are still not fully appreciated. The ecological changes he initiated with the help of fire almost certainly reduced the area of what would otherwise have become (or remained) continuous woody vegetation to open-canopy savanna, scrub, or grassland in the post-glacial period. He exterminated (although not necessarily by direct action) the Dromornithidae, the flamingo, and many marsupials including *Diprotodon* and *Thylacoleo*, and restricted the distribution of other animals (*Thylacinus*, *Sarcophilus*, *Zaglossus*; see Gill, 1975). As he became adapted to an Australian environment that probably became harsher in post-glacial time, the Aboriginal Australian, with the dingo, unintentionally exterminated fragile evolutionary products of a secluded continent (Blainey, 1975) more easily than modern man with all his science and technology is finding the task of controlling (let alone exterminating) such virile Palaearctic species as the rabbit, rats and red deer which evolved with him.

In New Zealand the fauna was even more unbalanced and fragile, with few predators and no mammals other than bats and seals, when Polynesian man arrived from the Pacific only one thousand years ago with his attendant dogs and rats and his use of fire and a developed hunting technology (Cowan, 1976). The vegetation had barely recovered from the Last Glaciation before it felt man's impact. Dated charcoal in soils shows that large areas of lowland forest were burned and replaced by bracken, scrub and tussock grassland (Molloy, 1969). The faunal losses included an endemic suborder of ratites, the moas (with two families or subfamilies), and sixteen endemic genera. The casualties included some fourteen species of moa, a pelican, a flightless goose, four ducks, two harriers, two eagles, four flightless rail genera, an owlet-nightjar, a crow and a swan that was probably black.

Black swan leaving  
 Your reedy nest  
 To sail on the waters  
 With quiet breast,  
 While you are far  
 The grey rat has come  
 Destroying, despoiling  
 Turn again home.

—James McAuley (1956).

Polynesian rats are capable of killing albatrosses in their nests, but the Australian swans were apparently less vulnerable than New Zealand ones. Many other animals, vertebrate and invertebrate, while not exterminated, were restricted to a portion of their former ranges.

Our first human colonists, like many of the Tertiary immigrants, were Malayo-Pacific or Indo-Pacific elements if we class them in biogeographic categories. They laid the foundations of human culture in these lands. The Europeans who followed them were Palaearctic and soon brought Palaearctic rats, cats, pigs, and foxes or mustellids to press on with the biotic modifications and sound the death knell of an ecology of isolation. Not only predators were imported, of course. In New Zealand we have a varied mosaic of the world's plants and animals: Scotch, Grecian and Maltese thistles, Austrian chamois, Russian knapweed, Manchurian wild rice, Himalayan thar and honeysuckle, Indian myna and turtle dove, Japanese sika deer and wineberry, Cape tulip and Sodom apple from North Africa, Canadian geese and salmon, Californian quail and cypress, Tasmanian ladybirds, Mexican prickly pear, South American *Nasella* tussock, as well as plants, frogs, marsupials and birds from Australia. Many are dominant organisms in our modified landscapes, which indeed would be drab (or drabber) without them (Fleming, 1973), but they are an *international* contribution to our culture, not a *national* one.

J. M. Bechervaise (1967) has listed the carolling of magpies as one of the irreplaceable values that an Australian misses most and speaks about when questioned overseas about his homeland. Yet this quintessence of the Australian outdoors is now diluted by being shared with New Zealanders, one of whom, Denis Glover (1960), has even written a poem called "The Magpies".

When Tom and Elizabeth took the farm  
 The bracken made their bed,  
 And *Quardle oodle ardle wardle doodle*  
 The magpies said . . .  
 Elizabeth is dead now (it's years ago)  
 Old Tom went light in the head:  
 And *Quardle oodle ardle wardle doodle*  
 The magpies said.

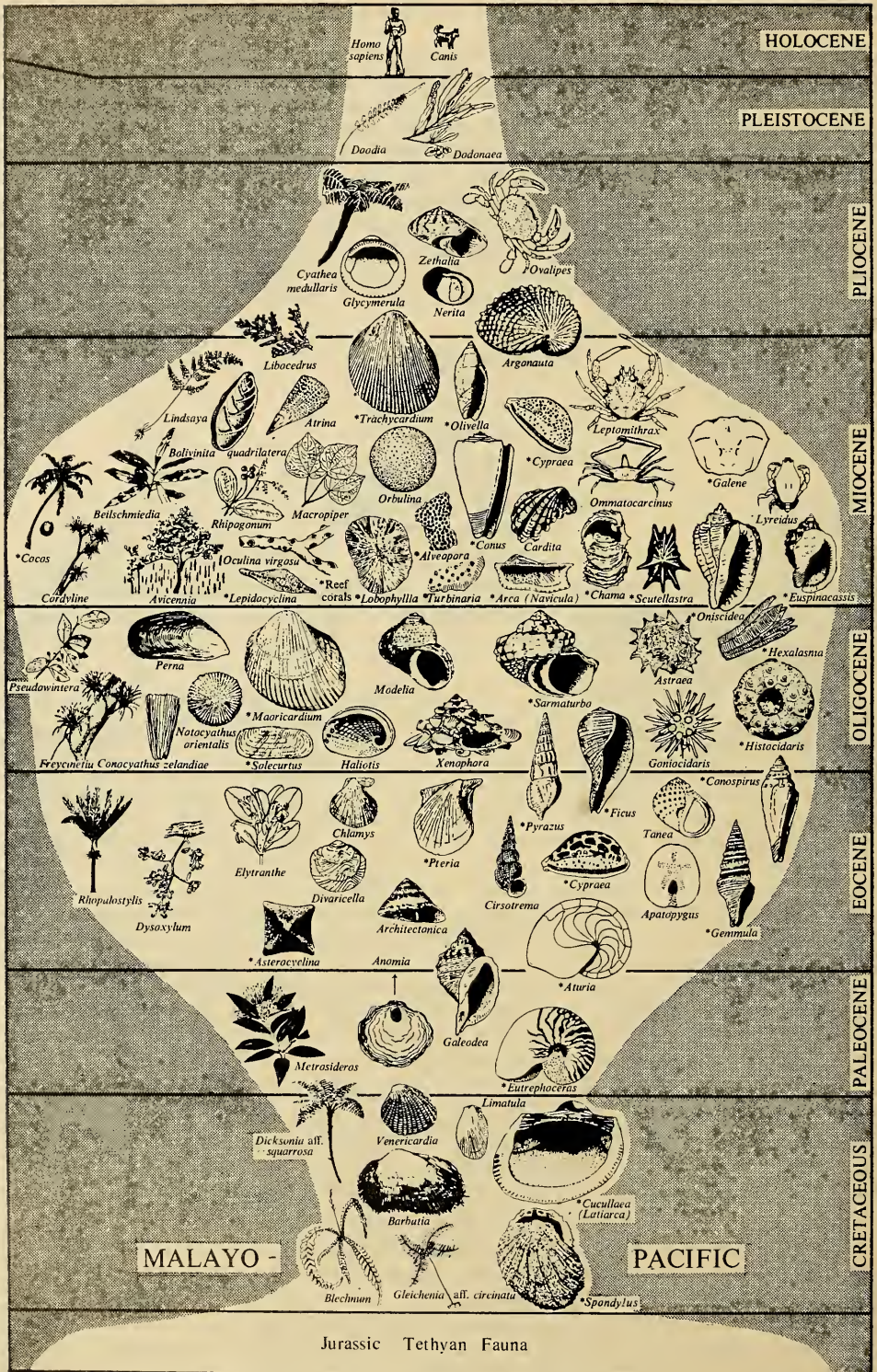

Fig. 13. Diagram illustrating Mid-Tertiary climax of the Malayo-Pacific element among colonists reaching New Zealand, with Polynesian man and his dog shown as late arrivals in the Holocene (from Fleming, 1975).



Sounds of bird or cicada are evocative of memories and emotions but there seems little future (in my opinion) in a music that tries to be national by using the distinctive calls of bush birds, as advocated by Henry Tate (Serle, 1973). Beethoven got away with quails and cuckoo but orchestrated kookaburras and tuis are no substitute for the real thing. Local musicians, however, who "grate on their scranell pipes of wretched straw" depend on the wilderness to provide this raw material. The Maori uses raupo (bulrush) to make his own rhythmic percussion instruments, the *poi*, the "tiny ball on end of string" that an Australian composer, Alfred Hill, celebrated in his *waiata poi*, a song made popular by Peter Dawson. We owe a lot to Australians, from the times of George French Angas (1847), who illustrated the New Zealanders and their clothing in a generation of transition. Bulrush is cosmopolitan, but the main raw material for the textiles worn by Angas's Maori subjects was the endemic New Zealand flax, *Phormium*, basis of the first manufacturing industry, which persisted until quite recent years, providing fibres for wool packs, twine and floor coverings.



Fig. 14. New Zealand Flax (*Phormium*), endemic raw material for Maori textiles and European woolpacks (a), the "poi" used as percussion instruments in Maori dancing (b), and the cosmopolitan bulrush (*Typha*), from which they were generally manufactured (c).

Our New Zealand biota has taken such a battering that we are glad to restore its diversity with magpie, swan and kookaburra, even katydid and mantis, to say nothing of ornamental wattles, bottlebrush and waratahs in our gardens. Horticulturally, if not culturally, New Zealand makes a modest return, with any of a dozen cultivars of the prolific genus *Hebe*, the hedge plant known as taupata or mirror leaf (a species of *Coprosma*), and other garden plants, and maybe we still have unexploited resources like the Poor Knights lily, *Xeronema*. These are as important cultural exchanges as a loan collection of paintings but only in the donor country are they part of the national culture.

Not all culture is based on the wilderness but cultural phenomena not so based seldom begin or persist as national traits. Even physical geography is seldom unique to a nation. The bold coasts of Fiordland, without their New Zealand vegetation, could be mistaken for Norway. My thesis does not deny the beneficial function of international culture in promoting understanding and peace. To quote P. R. Stephensen (1936), "there is a universal concept of humanity and world culture but it does not destroy individuality . . . Cultures remain local in creation and universal in appreciation". If we were

textbook scientists, thoroughly logical, we would accept all the changes brought about by man—extinctions, modifications, introductions—as an interesting continuation of our biogeographic history. We have no option in many cases. But for the first time in the history of life, some changes can now be made subject to human management based on value judgements.

In this lecture, I have implied that indigenous plants and animals are more important as cultural influences than introduced ones and that endemic organisms can be the most important of all if they affect our thoughts and feelings, notwithstanding the links with our own ancestral western traditions and history provided by introduced organisms, many of which are also profitable. Britain and Japan, largely repopulated by plants and animals in the last 10,000 years since the Ice Age wiped the slate clean, have nothing to equal the interest and uniqueness of the venerable (but vulnerable) survivors of Gondwanaland and the earlier years of continental drift. Such organisms have been Australians or New Zealanders for 50 to 100 million years. The distinctive cultural contribution from endemics is a logical basis for decisions on environmental conservation and land use. It also justifies educational policies that give as much (or more) attention to the special and individual geological histories of national territories and biotas as to the universal laws and principles of biology such as mitosis and the genetic code. These things I believe with a quite unscientific fervour.

Not only “from the deserts” do “the prophets come” (A. D. Hope, 1939); on the far side of the Tasman they come from the encircling seas, the waiting hills and primaeval forests (Holcroft, 1948, 1950). But always they come from the wilderness, to which we return, as peoples or as individuals, to charge our batteries when standards begin to disintegrate, when foundations of culture begin to weaken, when we need renewed confidence in a national future.

#### ACKNOWLEDGEMENTS

I am grateful to Dr. Patricia Whitmore (Lower Hutt Library), Miss Jean Luke, Mr. Melvin Day (National Art Gallery, Wellington), Dr. G. W. Mason (Ivon Watkins-Dow Ltd., New Plymouth), and Mr. I. W. Keyes (N.Z. Geological Survey) for help in obtaining publications, and to Professor G. T. S. Baylis (University of Otago), Mr. D. L. Homer and Mr. B. D. Scott (N.Z. Geological Survey), Mr. Phillip Temple, Mrs. P. J. McKinlay, the N.Z. Forest Service and the N.Z. Tourist and Publicity Department for slides to illustrate the lecture. My colleague, Dr. R. A. Cooper allowed me to use his reconstruction of the Australasian sector of Gondwanaland and Dr. R. C. Harrington (National Museums Canada) kindly supplied data on lion and walrus distribution. Mrs. E. M. Taylor, Mr. W. H. Allingham and Messrs. A. H. and A. W. Reed gave permission to publish copyright illustrations.

I owe more to the writings of M. H. Holcroft and A. G. Serle than may be apparent from cited references. I thank my wife and Dr. M. E. Hoare for encouragement in various ways.

#### References

- ALEXANDER, W. B., 1926.—Grey Jumper or Apostlebird. In *The Illustrated Australian Encyclopaedia*. Vol. 1, p. 584. Sydney: Angus and Robertson.
- ALINGTON, M. H., 1965.—*Frederick Thatcher and St. Paul's*. An ecclesiological study. Wellington, New Zealand: Government Printer. 50 pp.
- ALLSOP, F., 1973.—*The Story of Mangatu*. Wellington, New Zealand: Government Printer.
- ANGAS, G. F., 1847.—*The New Zealanders Illustrated*. London: Thomas M'Lean.
- ATKINSON, M. M., [1944].—*Richard Bird in the Bush*. Wellington, New Zealand: A. H. and A. W. Reed.
- BATHGATE, A. W., (1888)—Our Heritage. In Sladen, D. B. W. (ed.), *Australian Ballads and Rhymes*. London: Walter Scott, p. 21.
- BAXTER, J. K., 1960.—Poem in the Matukituki Valley. In Curnow, A. (ed.), *The Penguin Book of New Zealand Verse*. Harmondsworth: Penguin Books, p. 287.

- BEAGLEHOLE, J. C. (ed.), 1955.—*The Journals of Captain James Cook on his Voyages of Discovery*. Vol. I. *The Voyage of the Endeavour 1768–1771*. London : Hakluyt Society.
- BECHERVAISE, J. M., 1967.—*Australia, World of Difference : The Australian Transition*. Adelaide : Rigby.
- BLACKETT, P. M. S., 1965.—A symposium on continental drift. *Philos. Trans. R. Soc. London, Ser. A*, 258 : 322 pp.
- BLAINEY, G., 1975.—*Triumph of the Nomads : A History of Ancient Australia*. South Melbourne : Macmillan.
- BUCK, P., 1974.—*The Coming of the Maori*. Wellington, New Zealand : Whiteornbe and Tombs.
- CAREY, S. W., 1958.—A tectonic approach to continental drift. In Continental Drift, a symposium held in the Geology Department, University of Tasmania, March 1956. Hobart : University of Tasmania, pp. 177–355.
- COUPER, R. A., 1960.—New Zealand Mesozoic and Cainozoic plant microfossils. *N.Z. Geol. Surv. Palaeontol. Bull.*, 32 : 88 pp.
- COWAN, I. M., 1976.—Presidential Address. Biota Pacificia—2000 A.D. In Proceedings of the 13th Pacific Science Congress, Vancouver, 1975, Vol. 2, pp. 41–54.
- CUMBERLAND, K. B., 1947.—*Soil Erosion in New Zealand*. Wellington, New Zealand : Whitcombe and Tombs.
- CURNOW, A., 1942.—Landfall in Unknown Seas. On the three hundredth anniversary of the discovery of New Zealand by Abel Janszoon Tasman, 13th December 1642. Reprinted in Curnow, A. (ed.), *The Penguin Book of New Zealand Verse*. Harmondsworth : Penguin Books (1960).
- DIAMOND, J. M., 1972.—Biogeographic kinetics. *Proc. Natl. Acad. Sci. U.S.A.*, 69 : 3199–3203.
- , 1973.—Distributional ecology of New Guinea birds. *Science*, 179 : 759–769.
- FAIRBURN, A. R. D., 1966.—Conversation in the Bush. Elements. In his *Collected Poems*. Christchurch : Pegasus Press, p. 26 and p. 27.
- FAWKNER, J. J., 1974.—Establishment of *Solanum aviculare* as a field crop for the production of pharmaceutical raw materials. *Proc. Int. Plant Propagation Soc.*, 24 : 331.
- FLEMING, C. A., 1962.—History of the New Zealand land bird fauna. *Notornis*, 9 : 270–274.
- , 1973.—Foreword. In Williams, G. R. (ed.), *The Natural History of New Zealand*. Wellington, New Zealand : A. H. and A. W. Reed.
- , 1974.—The coming of the birds. *New Zealand Nature Heritage*, 1 : 61–68. (Wellington, New Zealand : Paul Hamlyn.)
- , 1975.—The geological history of New Zealand and its biota. In Kuschel, G. (ed.), *Biogeography and Ecology of New Zealand*. The Hague : Junk, p. 1086.
- , 1976.—New Zealand as a minor source of terrestrial plants and animals in the Pacific. *Tuatara*, 22 : 30–37.
- FOSBERG, F. R., 1975.—An overview of natural area preservation in the world. Paper presented to the 13th Pacific Science Congress, Vancouver, 1975.
- FRAZER, J. G., 1922.—*The Golden Bough*. (1967 edition, London, Macmillan.)
- GAGE, M., and SOONS, J., 1974.—The ages of land surfaces with special reference to New Zealand. *Inst. Br. Geogr. Spec. Pub.*, 7 : 99–109.
- GIBBS, M., 1946.—*The complete adventures of Snugglepot and Cuddlepie*. Sydney : Angus and Robertson.
- GILL, E. D., 1975.—Evolution of Australia's unique flora and fauna in relation to plate tectonics theory. *Proc. R. Soc. Victoria*, 87 : 215–234.
- GLOVER, D., 1960.—The Magpies. In Curnow, A. (ed.), *The Penguin Book of New Zealand Verse*. Harmondsworth : Penguin Books. (The complete poem has six stanzas.)
- HAYES, D. E., and PITMAN, W. C., 1970.—Marine geophysics and seafloor spreading in the Pacific-Antarctic area : A review. *Antarct. J. U.S.*, 5 : 70–77.
- HEITZLER, J. R., 1968.—Sea-floor spreading. *Sci. Am.*, 219 (6) : 60–70.
- HOLCROFT, M. H., 1940.—*The Deepening Stream*. Reprinted in his *Discovered Isles. A Trilogy*. Christchurch : Caxton Press (1950).
- , 1943.—The Waiting Hills. Reprinted in his *Discovered Isles. A Trilogy*. Christchurch : Caxton Press (1950).
- , 1948.—*Creative Problems in New Zealand*. Christchurch : Caxton Press.
- , 1950.—*Discovered Isles. A Trilogy*. Christchurch : Caxton Press.
- HOLLOWAY, T. T., 1959.—Noxious animal problems of the South Island alpine watershed. *N.Z. Sci. Rev.*, 17 : 24.
- HOPE, A. D., 1939.—Australia. In his *Collected Poems 1930–1970*. Sydney : Angus and Robertson (1972).
- HUDSON, W. H., 1915.—*Birds and Man*. (New Edition, 1927, London, Duckworth.)
- HURLEY, P. M., 1968.—The confirmation of Continental Drift. *Sci. Am.*, 218 (4) : 53–64.
- JENSEN, J. V., 1976.—Thomas Henry Huxley's baptism into oratory. *Notes Rec. R. Soc. London.*, 30 : 181–207.
- JOHNSON, L. A. S., and BRIGGS, B. G., 1975.—On the Proteaceae—the evolution and classification of a southern family. *Bot. J. Linn Soc.*, 70 : 83–182.
- KEAST, A., 1961.—Bird speciation on the Australian Continent. *Bull. Mus. Comp. Zool. Harv. Univ.*, 123 : 307–495.
- KING, J. E., 1964.—*Seals of the World*. London : British Museum (Natural History).

- LANCASTER, J. E., and MANN, J. D., 1975.—Changes in solasodine content during the development of *Solanum laciniatum* Ait. *N.Z. J. Agric. Res.*, 18 : 139–144.
- LEOPOLD, A., 1966.—*A Sand County Almanak, with other essays on conservation from Round River*. New York : Oxford University Press.
- McARTHUR, R. H., and WILSON, E. O., 1967.—*The Theory of Island Biogeography*. Princeton : Princeton University Press.
- McAULEY, J. J., 1946.—Terra Australis. In his *Under Aldebaran*. Melbourne : Melbourne University Press, p. 51.
- , 1956.—*A Vision of Ceremony : Poems*. Sydney : Angus and Robertson.
- MEADS, M. J., 1976.—Effects of Opossum browsing on northern Rata trees in the Orongorongo Valley, Wellington. *N.Z. J. Zool.*, 31 : 127–139.
- MILDENHALL, D. C., 1972.—Fossil pollen of *Acacia* type from New Zealand. *N.Z. J. Bot.*, 10 : 485–494.
- MOLLOY, B. J. P., 1969.—Recent history of the vegetation. In Knox, G. A. (ed.), *The Natural History of Canterbury*. Wellington, New Zealand : A. H. and A. W. Reed, pp. 340–360.
- PRACEY, L. T., 1969.—In Poole, A. L. (ed.), *Wild Animals in New Zealand*. Wellington, New Zealand : A. H. and A. W. Reed, pp. 107–111.
- RICH, P. V., 1975.—Antarctic dispersal routes. Wandering continents and the origin of Australia's non-passeriform avifauna. *Mem. Natl. Mus. Victoria*, 36 : 63–126.
- SERLE, A. G., 1973.—*From Deserts the Prophets Come. The Creative Spirit in Australia 1788–1972*. Melbourne : Heinemann.
- SERVENTY, D. L., 1972.—Causal ornithology of Australia. In Proceedings of the 15th International Ornithology Congress 1970, pp. 574–584.
- , and WHITTELL, H. M., 1948.—*A Handbook of the Birds of West Australia*. Perth : Patterson's Press.
- SIMPSON, G. G., 1961.—Historical zoogeography of Australian mammals. *Evolution*, 15 : 431–446.
- STEPHENSON, P. R., 1936.—*The Foundations of Culture in Australia*. Sydney : W. J. Miles.
- SUESS, E., 1883–1909.—*Das Antlitz der Erde*. 3 Bde. Prague.
- TEICHERT, C., 1974.—Marine sedimentary environments and their fauna in Gondwanaland area. In Plate Tectonics—Assessments and Reassessments. *Am. Assoc. Pet. Geol. Mem.*, 23 : 361–394.
- VAN DER LINDEN, W. J. M., and HERZER, R. H., 1975.—*Port Jackson Bathymetry*. New Zealand Oceanographic Institute Chart, Oceanic Series 1 : 1,000,000.
- WEGENER, A. L., 1924.—*The Origin of Continents and Oceans*. London : Methuen.
- WELLMAN, H. W., 1975.—New Zealand 60 m.y. ago. *Aust. Soc. Explor. Geophys. Bull.*, 6 : 55–56

# THE FOOD PLANTS OR HOSTS OF SOME FIJIAN INSECTS. V.

WILLIAM GREENWOOD\*

[Accepted for publication 22nd October 1975]

Credit for the various records is given by initials as follows :

W. Greenwood (W.G.), R. Lever (R.L.), R. Paine (R.P.), G. Robinson (G.R.), R. Veitch (R.V.).

## LEPIDOPTERA

Except where otherwise stated, the records for Lepidoptera refer to the feeding habits of the larva.

TORTRICIDAE (TORTRICINAE) : *Adoxophyes fasciculana* (Walker) feeds on leaves of *Camellia sinensis* (L.) Kuntze (Theaceae) (R.L.), *Jasminum sessile* A. C. Smith (Oleaceae) (W.G.) and *Jasminum simplicifolium* Forst. f. (Oleaceae) (W.G.)

TORTRICIDAE (OLETHREUTINAE) : *Cryptophlebia vitiensis* Bradley feeds on seeds of *Albizia procera* (Roxb.) Benth. (Mimosaceae) (W.G.) and *Pithecellobium dulce* (Roxb.) Benth. (Mimosaceae) (W.G.). *Strepsicrates holotephras* (Meyrick) feeds on *Syzygium aromaticum* (L.) Merr. & Perry (W.G.), *Syzygium gracilipes* (A. Gray) Merr. & Perry (W.G.) and *Psidium cattleianum* Sabine (W.G.), and on leaves of *Psidium guajava* L. (R.V.) (Myrtaceae). *Acroclita physalodes* Meyrick feeds on flowers of *Barringtonia racemosa* (L.) Spreng. (Barringtoniaceae) (W.G.).

TINEIDAE : *Decadarchis sisyranthos* Meyrick feeds on leaves of *Pandanus odoratissimus* L.f. (Pandanaeae) (W.G.). *Decadarchis fibrivora* Meyrick feeds on leaves of *Pandanus caricosus* Spreng. (Pandanaeae) (W.G.).

LYONETHIDAE : *Opogona omoscopia* (Meyrick) feeds on seeds of *Tropaeolum majus* L. (Tropaeolaceae) (W.G.).

GRACILLARIIDAE : *Caloptilia xanthopharella* (Meyrick) feeds on leaves of *Glochidion cordatum* (J. Muell.) Seem. (Euphorbiaceae) (W.G.) and *Breynia disticha* Forst. f. (Euphorbiaceae) (W.G.).

HELIODINIDAE : *Hieromantis munerata* Meyrick feeds on flowers of *Melochia vitiensis* A. Gray (Sterculiaceae) (W.G.). *Hieromantis praemiata* Meyrick feeds on flowers of *Koelreuteria elegans* (Seem.) A. C. Smith (Sapindaceae) (W.G.).

EPERMENIIDAE : *Epermenia symmorias* Meyrick feeds on flowers of *Pittosporum brackenridgei* A. Gray (Pittosporaceae) (W.G.).

PYRALIDAE : *Marasmia poeyalis* (Boisduval) feeds on leaves of *Oryza sativa* L. (Poaceae) (R.L.). *Etiella behri* Zell. feeds on pods of *Cajanus cajan* (L.) Millsp. (Fabaceae) (W.G.). *Sylepta derogata* (F.) feeds on leaves of *Abelmoschus esculentus* (L.) Moench (Malvaceae) (W.G.) and *Hibiscus diversifolius* Jacq. (Malvaceae) (W.G.).

SPHINGIDAE : *Hippotion celerio* (L.) feeds on leaves of *Ipomoea batatas* (L.) Lam. (Convolvulaceae) (R.L.). *Gnathothlibus erotus* (Cramer) feeds on leaves of *Pentas lanceolata* (Forsk.) K. Schum. (Rubiaceae) (W.G.).

LYMANTRIIDAE : *Dasychira fidjiensis* Mabille and Vuillot feeds on leaves of *Rhizophora mangle* L. (Rhizophoraceae) (G.R.) and on leaves of *Psidium cattleianum* Sabine (Myrtaceae) (G.R.).

---

\* Died August 1975. Parts I-IV of the work were published in the following volumes of these Proceedings : Volume 46, 1921 ; Volume 49, 1924 ; Volume 54, 1929 ; Volume 65, 1940.

ARCTIIDAE : *Utelheisa clareae* Robinson feeds on leaves of *Messerschmidia argentea* (L.f.) Johnston (Boraginaceae) (G.R.). *Utelheisa pulchelloides* Hampson subsp. *marshallorum* Rothschild feeds on leaves of *Messerschmidia argentea* (L.f.) Johnston (Boraginaceae) (G.R.).

HYPSIDAE : *Argina cribraria* (Clerek) feeds on leaves and flowers of *Sophora tomentosa* L. (Fabaceae) (W.G.).

NOCTUIDAE : *Helicoverpa armigera* (Hübner) subsp. *conferta* (Walker) feeds on pods of *Cajanus cajan* (L.) Millsp. (Fabaceae) (R.L.) and on cobs of *Zea mays* L. (Poaceae) (R.L.). *Plusia (Phytometra) chalcites* (Esper) feeds on leaves of *Coleus scutellarioides* (L.) Benth. (Lamiaceae) (W.G.), *Mentha viridis* L. (Lamiaceae) (W.G.) and *Lathyrus odoratus* L. (Fabaceae) (W.G.). *Othreis fullonia* (Clerek) imago pierces the fruit of *Citrus grandis* (L.) Osbeck (Rutaceae) (R.L.). *Othreis materna* (L.) imago attacks the fruit of *Mangifera indica* L. (Anacardiaceae) (R.L.). *Mythimna (Pseudaletia) separata* (Walker) feeds on unexpanded leaves of *Zea mays* L. (Poaceae) (R.L.).

#### COLEOPTERA

Except where otherwise stated, the records for Coleoptera refer to the feeding habits of the larva.

BOSTRYCHIDAE : *Xylothrips religiosus* Boisd. in timber of *Swietenia macrophylla* King (Meliaceae) (R.L.), *Persea americana* Mill. (Lauraceae) (R.L.), *Maniltoa grandiflora* (A. Gray) Scheff. (Caesalpiniaceae) (R.L.), *Delonix regia* (Boj. ex Hook.) Raf. (Caesalpiniaceae) (W.G.) and *Mangifera indica* L. (Anacardiaceae) (W.G.). *Xylopsocus castanoptera* Frm. feeds in shoots of *Delonix regia* (Boj. ex Hook.) Raf. (Caesalpiniaceae) (W.G.) and *Bauhinia monandra* Kurz (Fabaceae) (W.G.).

HISPIDAE : *Promecotheca reichei* Baly. feeds between leaf surfaces of *Livistona chinensis* (Jacq.) R. Br. ex Mart. (Arecaceae) (W.G.). *Promecotheca bicolor* Maulik feeds on leaves of *Flagellaria indica* L. (Flagellariaceae) (R.P.) and *Metroxylon vitiense* (H. Wendl.) Benth. & Hook. f. (Arecaceae) (R.L.).

RUTELIDAE : *Adoretus versutus* Har. imago eats leaves of *Terminalia catappa* L. (Combretaceae) (W.G.) and *Commersonia bartramia* (L.) Merr. (Sterculiaceae) (W.G.).

CLERIDAE : *Necrobia rufipes* de Geer breeds in drying carcasses of cattle (R.L.). *Necrobia ruficollis* F. breeds in drying carcasses of cattle (R.L.).

BRUCHIDAE : *Bruchus chinensis* L. feeds in seeds of *Lathyrus odoratus* L. (Fabaceae) (W.G.) and *Cajanus cajan* (L.) Millsp. (Fabaceae) (R.L.). *Pachymerus gonager* F. feeds in seeds of *Tamarindus indica* L. (Caesalpiniaceae) (R.L.).

COCCINELIDAE : *Epilachna 28-punctata* F. larva and imago feed on leaves of *Solanum nigrum* L. (s. lat.) (Solanaceae) (R.L.) and *Arachis hypogaea* L. (Fabaceae) (R.L.).

SCOLYTIDAE : *Xyleborus mutilatus* Bldf. bores in stems of *Persea americana* Mill. (Lauraceae) (R.L.). *X. aplanatideclinis* Schedl. feeds in fruits of *Inocarpus fagifer* (Parkinson) Fosberg (Caesalpiniaceae) (R.L.) and in stems of *Persea americana* Mill. (Lauraceae) (R.L.). *X. compactus* Eichh. feeds in shoots of *Clidemia hirta* (L.) D. Don (Melastomataceae) (R.L.). *X. testaceus* Wlk. bores in trunks of *Citrus grandis* (L.) Osbeck (Rutaceae) (R.L.), in twigs of *Hydnocarpus wightianus* Blume (Flacourtiaceae) (R.L.) and in logs of *Endospermum macrophyllum* (J. Muell.) Pax & Hoffm. (Euphorbiaceae) (R.L.). *X. rameus* Schedl. bores in seeds of *Decussocarpus vitiensis* Seem. (Podocarpaceae) (R.L.). *X. fijianus* Schedl. bores in twigs of *Persea americana* Mill. (Lauraceae) (R.L.). *Cryphalus jatrophae* Samps. feeds in stems of *Acalypha wilkesiana* J. Muell. (Euphorbiaceae) (R.L.). *Hypothenemus peritus* Bldf. bores in branches of *Persea americana* Mill. (Lauraceae) (R.L.).

LYCTIDAE : *Minthea rugicollis* Wlk. feeds in stored roots of *Derris elliptica* (Roxb.) Benth. (Fabaceae) (R.L.).

PLATYPIDAE : *Crossotarsus saundersi* Chap. bores in branches of *Persea americana* Mill. (Lauraceae) (R.L.), in trunk of *Citrus grandis* (L.) Osbeck (Rutaceae) (R.L.) and in logs of *Maniltoa grandiflora* (A. Gray) Scheff. (Caesalpiniaceae) (R.L.). *C. externedentatus* Frm. bores in trunk of *Casuarina* sp. (= "*C. nodiflora*" auct. non. G. Forst.) (Casuarinaceae) (R.L.).

CURCULIONIDAE : *Parendymia pilipes* Korsch. bores in timber of *Bruguiera gymnorrhiza* (L.) Lam. (Rhizophoraceae) (R.L.). *Elytroteinus subtruncatus* Frm. imago eats fruits of *Citrus Limon* (L.) Burm. f. (Rutaceae) (R.L.). *Elytrurus smaragdus* Mshll. attacks leaves of *Piper methysticum* Forst. f. (Piperaceae) (R.L.). *Diorycaulus punctatellus* Frm. bred from ripe fruits of *Syzygium neurocalyx* (A. Gray) Christophersen (Myrtaceae) (W.G.). *Rhinoscapha lagopyga* Frm. imago attacks leaves of *Citrus* spp. (Rutaceae) (R.L.). *Calandra linearis* Herbst feeds in seeds of *Tamarindus indica* L. (Caesalpiniaceae) (R.L.).

#### HYMENOPTERA

BRACONIDAE : *Apantales samoana* Fullaway is parasitic on larva of *Cirphis unipuncta* Haw. (Noctuidae) (R.L.). *A. antipoda* Ash. is parasitic on larva of *Anomis flava* F. (Noctuidae) (R.L.). *A. expulsus* Turn. is parasitic on larva of *Phytometra chalcites* Esp. (Noctuidae) (R.L.).

SPHEGIDAE : *Sceliphron caementarius* Drury feeds on spiders (R.L.).

CHALCIDAE : *Brachymeria fijiensis* Ferr. is parasitic on larva of *Nacoleia diemenalis* Gn. (Pyralidae) (R.L.). *Proamatura aquila* Gir. is parasitic on larva of *Minthea rugicollis* Wlk. (Lyctidae) (R.L.).

AGAONIDAE : *Ceratostenes marshalli* Grandi. in fruits of *Ficus pritchardii* Seem. (Moraceae) (W.G.). *Blastophaga browni* Ashm. in fruits of *Ficus storckii* Seem. (Moraceae) (W.G.).

ICHNEUMONIDAE : *Diplazon laetatorius* F. is parasitic on larva of *Syrphus corollae* Fabr. var. *vitiensis* Bezzi (Syrphidae) (R.L.).

EULOPHIDAE : *Hemiptarsenus semialbiclavus* Gir. is parasitic on larva of *Phytomyza spicata* Mall. (Agromyzidae) (R.L.).

#### HEMIPTERA

APHIDAE : *Cerataphis lataniae* Bdv. on leaves of *Cocos nucifera* L. (Arecaceae) (R.L.), *Metroxylon vitiense* (H. Wendl.) Benth. & Hook. f. (Arecaceae) (R.L.). *Aphis gossypii* Glover on leaves of *Colocasia esculenta* (L.) Schott (Araceae) (R.L.) and *Crotalaria mucronata* Desv. (Fabaceae) (R.L.). *Aphis citricidus* Kerk. on shoots of *Citrus* spp. (Rutaceae) (R.L.). *Aphis maidis* Fitch. on leaves and stems of *Zea mays* L. (Poaceae) (R.L.). *Aphis neri* Boyer on leaves of *Asclepias curassavica* L. (Asclepiadaceae) (R.L.). *Rhopalosiphum nymphae* L. on stalks of *Eichhornia crassipes* (Mart.) Solms (Pontederiaceae) (R.L.) and *Oryza sativa* L. (Poaceae) (R.L.).

PSYLLIDAE : *Megatrioza vitiensis* Kirk. nymph feeds in galls in leaves of *Syzygium malaccense* (L.) Merr. & Perry (Myrtaceae) (R.L.). *Psylla compta* Crawf. feeds on young leaves of *Syzygium richii* (A. Gray) Merr. & Perry (Myrtaceae) (W.G.).

DELPHACIDAE : *Megamelus proserpina* Kirk. feeds on *Colocasia esculenta* (L.) Schott (Araceae) (R.L.).

POEKILOPTERIDAE : *Euricania aperiens* Walk. feeds on leaves and stems of *Hernandia peltata* Meisn. (Hernandiaceae) (W.G.) and *Rhizophora mangle* L. (Rhizophoraceae) (W.G.). *Plestia marginata* Montr. feeds on leaves and stems of *Maniltoa grandiflora* (A. Gray) Scheff. (Caesalpiniaceae) (W.G.) and *Cynometra falcata* A. Gray (Caesalpiniaceae) (W.G.).

COCCIDAE : *Leucanium viride* Green on leaves and stems of *Gaillardia pulchella* Foug. (Asteraceae) (W.G.), on leaves and stalks of *Gerbera jamesonii* Bolus (Asteraceae) (W.G.), on leaves of *Lagerstroemia indica* L. (Lythraceae) (W.G.), on leaves and stems of *Gardenia hutchinsoniana* Turrill (Rubiaceae) (W.G.), on leaves and stems of *Chrysanthemum morifolium* Ramat (Asteraceae) (W.G.), on leaves and stems of *Ixora odorata* Hook. (Rubiaceae) (W.G.), on stems of *Caesalpinia pulcherrima* (L.) Sw. (Caesalpiaceae) (W.G.), on stems of *Samanea saman* (Jacq.) Merr. (Mimosaceae) (W.G.) and on leaves and stems of *Pentas lanceolata* (Forsk.) K. Schum. (Rubiaceae) (W.G.). *Leucanium hemisphericum* T.T. on pinnae of *Adiantum hispidulum* Sw. (Adiantaceae) (W.G.). *Icerya seychellarum* Westw. on leaves of *Chrysophyllum cainito* L. (Sapotaceae) (W.G.), on stems of *Cinnamomum camphora* (L.) Nees & Eberm. (Lauraceae) (W.G.), on leaves of *Livistona chinensis* (Jacq.) R. Br. ex Mart. (Arecaceae) (W.G.), on leaves of *Pritchardia pacifica* Seem & H. Wendl. (Arecaceae) (W.G.), on leaves of *Artocarpus altilis* (Parkinson) Fosberg (Moraceae) (R.L.), on leaves of *Tectona grandis* L.f. (Verbenaceae) (R.L.), on leaves and stems of *Mimosa pudica* L. (Mimosaceae) (R.L.). *Aulacaspis pentagona* T.T. on stems and leaves of *Verbena* × *hybrida* Groenl. & Rümpl. (Verbenaceae) (W.G.) and *Triumfetta bartramia* (Tiliaceae) (W.G.), and on stems of *Urena lobata* L. (Malvaceae) (R.L.), *Malvastrum coromandelianum* (L.) Garcke (Malvaceae) (W.G.) and *Hibiscus diversifolius* Jacq. (Malvaceae) (W.G.). *Vinsonia stellifera* Westw. on leaves of *Cycas rumphii* Miq. forma *seemannii* (A. Braun) Kanehira (Cycadaceae) (W.G.) and *Syzygium richii* (A. Gray) Merr. & Perry (Myrtaceae) (W.G.). *Saissetia nigra* Wietn. on leaves and stems of *Mirabilis jalapa* L. (Nyctaginaceae) (W.G.) and stems of *Ruellia graecizans* Backer (Acanthaceae) (W.G.). *Pseudococcus citri* Risso on *Clidemia hirta* (L.) D. Don (Melastomataceae) (R.L.) and *Annona squamosa* L. (Annonaceae) (R.L.).

ALEURODIDAE : *Aleurodes greenwoodii* on underside leaves of *Ficus benjamina* L. (Moraceae) (W.G.).

TETIGONIIDAE : *Nesosteles sanguinescens* Kirk. on inflorescence of *Dichanthium aristatum* (Poir.) Hubbard (Poaceae) (W.G.).

TINGIDAE : *Nesocypselas dieysta* Kirk. on leaves of *Ficus vitiensis* Seem. (Moraceae) (W.G.). *Nesophrestes dreptias* Kirk. on leaves of *Ficus fulvo-pilosa* Summerhayes (Moraceae) (W.G.). *Pamocephala phylloptera* Crawf. on leaves of *Ficus fulvo-pilosa* Summerhayes (Moraceae) (W.G.). *Cicadula euryphaesa* Kirk. on leaves and stems of *Glochidion concolor* J. Muell. (Euphorbiaceae) (W.G.).

CAPSIDAE : *Lygus muiri* Popp. on young shoots of *Solanum melongena* L. (Solanaceae) (R.L.).

LYGAEIDAE : *Graptostethus servus* F. feeds on shoots of *Canavalia maritima* (Aubl.) Thou. (Fabaceae) (W.G.).

PENTATOMIDAE : *Nezara viridula* L. on *Pisum sativum* L. (Fabaceae) (R.L.), on leaves of *Lycopersicum esculentum* Mill. (Solanaceae) (R.L.), on stems of *Nicotiana tabacum* L. (Solanaceae) (R.L.), on leaves of *Lactuca sativa* L. (Asteraceae) (R.L.), on leaves of *Ageratum conyzoides* L. (Asteraceae) (R.L.), on stems of *Vigna sinensis* (L.) Endl. (Fabaceae) (R.L.) and on stems of *Gossypium barbadense* L. (Malvaceae) (R.L.).

#### THYSANOPTERA

THRIPIDAE : *Thrips tabaci* Lindeman feeds on leaves of *Lactuca sativa* L. (Asteraceae) (R.L.). *Heliothrips longiceps* Karny. feeds on inflorescence of *Bothriochloa glabra* (Roxb.) A. Camus (Poaceae) (W.G.). *Haplothrips soror* Schmutz. in flowers of *Dendrobium mohlianum* Reichb. f. (Orchidaceae) (W.G.).



## DIPTERA

PHORIDAE : *Dohrniphora cleghorni* Bigot. bred from larva of *Heliothrips armigera* Hübn. (Noctuidae) (R.L.). *Megascelia scalaris* Low. bred from larva of *Heliothrips armigera* Hübn. (Noctuidae) (R.L.).

TRYPETIDAE : *Dacus passiflorae* Frogg. larva feeds in fruits of *Artocarpus altilis* (Parkinson) Fosberg (Moraceae) (R.L.) and *A. heterophyllus* Lam. (Moraceae) (R.L.), in pods of *Theobroma cacao* L. (Sterculiaceae) (R.L.), and in fruits of *Spondias dulcis* Sol. ex Parkinson (Anacardiaceae) (W.G.), *Garcinia sessilis* (Forst. & Forst. f.) Seem. (Clusiaceae) (W.G.) and *Elaeocarpus chelonimorphus* Gillespie (Elaeocarpaceae) (W.G.). *Dacus xanthodes* Broun. larva feeds in fruits of *Artocarpus altilis* (Parkinson) Fosberg (Moraceae) (R.L.) and *A. heterophyllus* Lam. (Moraceae) (R.L.). *Ensina sororcula* Wied. larva feeds in flower heads of *Gaillardia pulchella* Foug. (Asteraceae) (W.G.), *Wedelia biflora* (L.) DC. (Asteraceae) (W.G.) and *Eleutheranthera ruderalis* (Sw.) Schult. Bip. (Asteraceae) (W.G.).

TACHINIDAE : *Sturmia inconspicua* Bar. bred from larva of *Prodenia litura* F. (Natuidae) (R.L.).

## ACKNOWLEDGEMENTS

The Society gratefully acknowledges the assistance of Dr. G. S. Robinson, Department of Entomology, British Museum (Natural History), and Mr. A. N. Rodd, National Herbarium, Sydney, in the preparation of the paper for publication after the author's death.

# ON THE ADAPTIVE SIGNIFICANCE OF THE LOSS OF AN OVIDUCT IN REPTILES

ALLEN E. GREER\*

[Accepted for publication 22nd September 1976]

## Synopsis

The loss of the left oviduct is reported for the first time in five taxa of scincid lizards and redescrbed in two other scincid taxa. These taxa, along with one other lizard taxon and two snake taxa, are the only reptiles known to have lost an oviduct, and they represent on the most conservative estimate at least ten, or perhaps eleven cases of the independent loss of an oviduct in reptiles.

These taxa can be divided into two subgroups whose morphology and ecology suggest two different adaptive reasons for the loss of the oviduct. One group, which comprises the snakes and the one legless lizard, consists entirely of attenuate burrowers with no specific latitudinal limitations in their distribution. The members of this group appear to have lost an oviduct as an adaptation to alleviate the problem of increased girth that would have resulted from having two oviducts full of eggs side by side. It is conjectured that such an increase in girth would increase the frictional surface of a burrowing form and also limit the number and types of preformed passageway through which it could pass. The second group consists of scincid lizards, all of which are fully limbed forms from diverse habitats and all of which are tropical in distribution. This group appears to have lost an oviduct in conjunction with a reduction in brood size to a constant one and as part of a life history found in many tropical lizards. This strategy involves maturity at an early age and frequent brood production: a life history strategy geared to reproductive efficiency, whereby the energy needed to develop and maintain a "superfluous" oviduct might well be reallocated to other functions.

It would appear that the left oviduct was preferentially lost in all these taxa due to the fact that in squamates it is usually the shorter of the two oviducts, hence its loss is likely to be less disruptive to development. Finally, it is interesting to note that as far as is known the left ovary is still functional in all of the taxa in which the left oviduct has been lost.

## INTRODUCTION

Within reptiles the loss or nearly total reduction of an oviduct has been reported to date only in the following taxa, all of which are squamates: among lizards, the anguid genus *Anniella* (Coe and Kunkle, 1906) and the two distantly related skink taxa *Tribolonotus* (Greer and Parker, 1968a) and *Sphenomorphus schultzei* (Greer and Parker, 1974); among snakes, the scolecophidian genera *Anomalepis*, *Helminthophis*, *Leptotyphlops*, *Typhlina* and *Typhlops* (Robb and Smith, 1966) and certain species of the colubrid genus *Tantilla* (Clark, 1970a). In all these taxa it has invariably been the left oviduct that has been lost, and judging from the most conservative interpretation of phylogenetic relationships these taxa represent no fewer than five different cases of independent oviducal loss.

In this paper I review the skink taxa in which the loss of the left oviduct has previously been reported, and I report for the first time the loss of this structure in five other skink taxa. These taxa bring the minimum number of independent losses of an oviduct in reptiles to ten or eleven. These new observations in conjunction with earlier ones provide the basis for speculation as to the adaptive significance of the loss of an oviduct in reptiles.

## OBSERVATIONS

Gross examination of over 300 of the 800+ species of skinks reveals that the left oviduct is either totally absent or reduced to a nonfunctional vestige in all

---

\* The Australian Museum, 6-8 College Street, Sydney, New South Wales, 2000.

females examined in the following species. These species are arranged in seven groups that would be separated at a generic level in a conservative taxonomic treatment.

*Tribolonotus*. This highly distinctive genus of spiny skinks occurs in New Guinea, the Admiralty Islands, the Bismarck Archipelago and the Solomon Islands (Zweifel, 1966; Greer and Parker, 1968a; and Cogger, 1972). The species are cryptic and are generally found only under surface cover such as rocks, logs and piles of litter. Current work indicates that *Tribolonotus* may be part of the same radiation that gave rise to the Australian Region's well known skink taxa *Corucia*, *Egernia*, and *Tiliqua* (Greer, personal observation), all of which apparently have paired oviducts.

The reproductive tracts of four of the eight species of *Tribolonotus* have been examined (*blanchardi*, *gracilis*, *pseudoponceleti* and *schmidti*) and in all the left oviduct was either absent or vestigial. Due to the fact that these species represent much of the ecological, morphological and geographical diversity in the genus (see references cited above), it is reasonable to assume that the genus as a whole lacks the left oviduct. The mode of reproduction is known for all four species mentioned above: the first three are oviparous; *T. schmidti* is viviparous.

*Sphenomorphus aignanus*, *S. bignelli*, *S. louisiadensis* and *S. minutus*. Despite the fact that these four species of the Papuan-Solomon Islands area are currently placed in the genus *Sphenomorphus*, they bear only a superficial resemblance to the various other groups that make up this extremely diverse assemblage. Phylogenetically they are probably members of the radiation that gave rise to a large number of other well known taxa of the Australian Region such as *Eugongylus*, *Leiolopisma* and *Emoia* (Group II of Greer, 1974), all of which apparently have paired oviducts.

These four species fall into two distinct subgroups on the basis of size and ecology. *Sphenomorphus aignanus* of eastern New Guinea, the D'Entrecasteaux Archipelago and the Louisiade Archipelago, and *S. louisiadensis* of the Louisiade Archipelago, are medium sized skinks which are probably surface dwelling forms judging from their size and limb proportions, whereas *S. minutus* of New Guinea and *S. bignelli* of the Solomon Islands are relatively small and are known to be cryptic inhabitants of the litter (Fred Parker, personal communication). These differences raise the possibility that these two subgroups lost the left oviduct independently of each other. All four species are oviparous.

*Geomyersia glabra*. This small, depressed skink is endemic to the northern Solomon Islands where it inhabits surface litter. The genus is monotypic and appears to have been derived from a small group of east Australian skinks (*Lampropholis*; Greer and Parker, 1968b; and Greer, 1974) all of which have paired oviducts. *Geomyersia glabra* is oviparous.

*Lipinia leptosoma*. This small arboreal species is endemic to the Palau Islands where to date it has only been found in the crowns of screw pine *Pandanus* (Brown and Fehlmann, 1958). The species' congeners are centered over the Philippines and New Guinea (Greer, 1974) and, as far as is known, all have paired oviducts. *L. leptosoma* is viviparous.

*Sphenomorphus schultzei*. This is a small New Guinea member of the *fasciatus* species group of *Sphenomorphus*—a group that has radiated extensively throughout northern Australia, New Guinea, the Bismarck Archipelago and the Solomon Islands (Greer and Parker, 1967 and 1974). *S. schultzei* inhabits dense rain forest in deep valleys where it lives under decaying logs and vegetable matter on the forest floor. As far as is known all other members of the species group have paired oviducts. *S. schultzei* is oviparous.

*Sphenomorphus steerei*. This is a small Philippines endemic whose closest relatives appear to be the other small "*Sphenomorphus*" of the Archipelago (personal observation). *S. steerei* is a relatively common species in the forest where it is found by day both on the surface and beneath surface objects such as rocks, logs and debris (Brown and Alcalá, 1961). The close relatives of this species which have been examined have paired oviducts. *S. steerei* is oviparous.

*Sphenomorphus consobrinus*. This species occurs in the northern Moluccas. Its exact relationships within the vast polyphyletic *Sphenomorphus* assemblage are uncertain. It could be part of the radiation that gave rise to the small "*Sphenomorphus*" of the Philippines and the western end of the Indo-Australian Archipelago, or it could be related to the *fasciatus* species group of *Sphenomorphus* (personal observation). The species does not, however, appear to be related closely enough to either *steerei* among the small Philippine "*Sphenomorphus*" or to *schultzei* of the *fasciatus* species group to have the loss of its oviduct ascribed to close relationship with either of these two taxa. Nothing is known of this species' ecology. It is probably oviparous judging from the texture of the shell surrounding the egg in the one gravid female I examined.

There are three important facts associated with the loss of an oviduct in these skinks. Firstly, anatomical observations reveal that whenever an oviduct has been lost in skinks, it has invariably been the left oviduct and never the right. Secondly, my own phylogenetic studies (references cited above and work in progress) make it fairly clear that this oviduct has been lost at least seven and perhaps eight different times in scincid lizard evolution. And thirdly, a fact that has not been alluded to before but which is nevertheless crucial, is that the skinks which lack the left oviduct are, with only one, or possibly two exceptions, unique among skinks in having a constant brood size of one (personal observation, Table 1).<sup>1</sup> The limbless African burrower *Typhlosaurus garipeensis* is the only well known exception. This species has a brood size of one (N=11; Huey *et al.*, 1974) and appears to have paired oviducts. The only specimens available to me for gross examination had the oviducts in a very regressed state. Another limbless burrower, *Isopachys roulei* of southeast Asia, may also have a litter size of one, although the information available on this point (Taylor, 1963) is ambiguous; it too has paired oviducts (personal observation). All other skinks examined to date (N=300+species), including many of the closest relatives of the skinks with one oviduct, have brood sizes averaging more than one, and they have paired oviducts.

#### DISCUSSION

The reptiles now known to have lost the left oviduct can be divided into two distinct groups on the basis of external morphology, adaptive mode, brood size and distribution. The first group includes the lizard genus *Anniella* and all the snake genera. Members of this group are relatively narrow bodied, attenuate, limbless squamates which are largely restricted to a burrowing habit. Furthermore, they all apparently have variable brood sizes (except for *Tantilla planiceps* which has a brood size of one—Stebbins, 1954; Minton, 1959; and personal observation), and they are distributed in both temperate and tropical areas.

The second group includes the scincid lizards largely described here for the first time. In contrast to the first group, members of this group are fully limbed, pentadactyl squamates which occur in a variety of adaptive zones ranging from

<sup>1</sup> Two species of *Tribolonotus* that are known to have a brood size of one have not been examined for the presence or absence of the left oviduct (*annectens*, N=2 and *novaeguineae*, N=1). It would, however, be remarkable if either of these species retained the oviduct given the fact that the other species of *Tribolonotus* which are known to have lost the oviduct are broadly representative of the genus in terms of morphology, ecology and distribution.

TABLE 1  
 Reproductive data for the scincid lizards which have lost the left oviduct. The species are arranged in their most conservative generic level taxa. Sample sizes are given in parentheses

Taxon	Number of specimens examined for the loss of an oviduct	Number of specimens examined for brood size	Minimum snout-vent length of ♀♀ at maturity (mm)	Frequency of individuals with an oviducal egg or young having, in addition, a yolky egg in either ovary	Frequency of individuals with a yolky ovarian egg having the egg in the left ovary
(1) <i>Tribolonotus blanchardi</i>	13	13	31 (9)	0.00 (3)	0.14 (7)
<i>schmidti</i>	12	12	33 (12)	0.10 (10)	1.00 (1)
<i>pseudoponceleti</i>	58	102	44 (102)	0.21 (38)	0.36 (28)
<i>gracilis</i>	1	4	87 (4)	— (0)	— (0)
(2) "Sphenomorphus"	19	22	31 (21)	— (0)	0.33 (6)
<i>bignelli</i>	1	2	37 (1)	— (0)	0.00 (1)
<i>minutus</i>	2	2	44 (2)	0.00 (1)	0.00 (1)
<i>louisianensis</i>	2	2	61 (5)	0.66 (3)	0.33 (3)
<i>aignanus</i>	5	5			
(3) <i>Geomyersia glabra</i>	2	2	31 (2)	0.00 (1)	— (0)
(4) <i>Lipinia leptosoma</i>	7	7	37 (7)	0.00 (3)	1.00 (1)
(5) "Sphenomorphus" <i>fasciatus</i> species group <i>schultzei</i>	4	4	35 (3)	0.00 (2)	— (0)
(6) "Sphenomorphus" <i>steerei</i>	13	24	27 (20)	0.50 (6)	0.44 (9)
(7) "Sphenomorphus" <i>consobrinus</i>	1	1	38 (1)	1.00 (1)	1.00 (1)

subfossorial to arboreal (see above). All of the members of the group have a constant brood size of one and all occur only on islands in the tropics.

The reasons for the loss of the left oviduct appear to have been different in each of these two groups. Other writers have suggested that the oviduct has been lost in the first group due to the difficulties that a relatively long but narrow bodied form might have in accommodating two parallel oviducts full of eggs in the confines of a subterranean habitat (Fox and Dessauer, 1962; Clark, 1970a). According to this hypothesis it is thought that the increased girth caused by pregnancy would increase the frictional forces encountered in burrowing and would also limit the number and kind of underground pathways available for foraging and escape. This is a reasonable first order hypothesis but it should be borne in mind that the reproductive tracts of many burrowing squamates, especially snakes, have not been examined and that there are many burrowing forms that are definitely known to retain paired oviducts; for example, all amphisbaenians (C. Gans, personal communication) the extremely thin pygopodid *Apraxis striolata* (personal observation), many skinks (personal observation), and the following snakes: *Carphophis* (Clark, 1970b), *Cylindrophis rufus* (Bergman, 1953), *Liotyphlops* (Robb and Smith, 1966), several species of *Tantilla* (Clark, 1970a) and all uropeltids (C. Gans, personal communication). These "exceptional" forms indicate that common above ground methods of filling two oviducts are employed by some burrowers (perhaps due to subtle differences in their ecologies) or, additionally, that there are novel solutions to the packing problem in certain burrowers that have yet to be investigated.

What I believe to be a sound general explanation for the loss of the oviduct in the second group, that is, the skinks, is based on the group's exclusively tropical distribution and unusually low brood size of one, and it is most readily understood as a variation of a reproductive strategy that seems to be characteristic of many tropical lizards. The available evidence for skinks indicates that, as in other lizard species (Tinkle *et al.*, 1970), tropical species seem to mature earlier than temperate species,<sup>2</sup> and, if they are like other lizards (Tinkle *et al.*, 1970) tropical skink species probably also produce more broods per season than temperate species.<sup>3</sup> In other words, the general reproductive strategy in many tropical skinks may be geared to early and repeated reproduction. In this context, species with a brood size of one might become even more reproductively efficient if the energy required for the development and maintenance of the "extra" oviduct were reallocated through selection to other functions.

One problem with this efficiency hypothesis, however, is that it does not seem to apply to other tropical lizards that apparently have a constant brood size of one: the anolines (Smith *et al.*, 1973) among the iguanids; *Aristelliger* (Hecht, 1952), *Gehyra variegata* (Bustard, 1968) and the sphaerodactylines (Kluge, 1967) among the gekkonids; *Gonocephalus nigrigularis* (personal observation) among the agamids; *Proctoporus guntheri* (Uzzell, 1970), *Ecleopopus quadrichaudii* (Uzzell, 1969), *Bachia monodactylus* (Dixon, 1973) among the teiids, and *Chirindia ewerbecki* (Loveridge, 1941) among the amphisbaenians. In contrast to skinks, all of these taxa in which the oviducal anatomy has been examined (the first six

---

<sup>2</sup> Data on age at maturity exist for 20 of the 800+ species of skinks (personal observation). If an age of twelve months is arbitrarily taken as the dividing point between early and late maturity (this follows Tinkle *et al.*, 1970), then early maturity is significantly more characteristic of tropical than temperate species ( $P = .02$ , Fisher Exact Probability Test).

<sup>3</sup> This supposition is supported but not proved for skinks that lack the left oviduct, all of which are tropical, by the fact that where the sample sizes are large enough to provide a fair indication, the females of these species often have both an oviducal egg or embryo and a yolking ovarian egg (Table 1). This suggests at least the potentiality for a quick second brood.

taxa listed) have paired oviducts (personal observation). The difference between the skinks and these other lizard taxa is highlighted by considering the number of times brood size was reduced to one in each of the two groups and the fate of the oviduct with each reduction. In each of the nonscincid taxa listed above, the evolution of a constant brood size of one can be reasonably interpreted as an independent event, and in none of the six taxa in which the oviducal anatomy has been examined has the reduction in brood size been accompanied by the loss of an oviduct. In the tropical skinks, on the other hand, a constant brood size of one has evolved independently at least seven, and perhaps eight times (depending on whether group 2 above is mono or diphyletic with regard to the evolution of brood size), and in each case the reduction was accompanied by the loss of the left oviduct. This indicates that in tropical skinks the loss of the left oviduct is closely correlated with a reduction in brood size to one. The only possible exception to this generalization is the Southeast Asian *Isopachys roulei* which, as discussed above, may have a brood size of one but definitely has paired oviducts.

There is no obvious explanation for this difference between these two groups of lizards. A hypothesis that is appealing due to its generality, but difficult to test, is that skinks are under greater duress to conserve the energy that would otherwise go into development and maintenance of an oviduct than are the other lizards, perhaps because they are in more competitive or predator-ridden habitats (see below).

It is interesting to compare the reproductive aspects of the life history that has been inferred above for those skinks which have a brood size of one and only one oviduct, with the well known life history of *Typhlosaurus garipeensis* which has a brood size of one (Huey *et al.*, 1974) but retains both oviducts (personal observation). The most significant difference between these two groups, as it relates to the hypothesis that the skinks with one oviduct have found it selectively advantageous to rechannel the energy required to develop and maintain the second oviduct into other functions, is that *T. garipeensis*, like other temperate lizards, has a relatively lengthy age to maturity (one and two-thirds year) and reproduces infrequently (one brood per year, (Huey *et al.*, 1974)) whereas the other skinks, like other tropical lizards, are inferred to have a relatively short age to maturity and to reproduce frequently. Given this relatively longer age to maturity and lower reproductive rate, the energy *T. garipeensis* might save by eliminating the second oviduct may not be enough to offset the benefit of retaining the oviduct for some long term use, for example, in producing two young per brood in an exceptionally "favourable" year or at an older age.

It remains to be seen whether the tropical Southeast Asian limbless, burrowing skink *Isopachys roulei* has a brood size of one. However, if it does, it would be exceptional among tropical skinks with a similar brood size in retaining paired oviducts.

Although a reduction in brood size to one appears to be a key factor in the loss of an oviduct in skinks, one might reasonably wish to ask why brood size has been reduced to one in these species. This problem is related in part to the general trend, observed in other lizards as well as in skinks, for tropical species to have smaller brood sizes than temperate species.<sup>4</sup> Although the reasons for this trend are not obvious, two hypotheses have recently been suggested. Tinkle *et al.* (1970) have suggested that tropical species live in a highly competitive environment and may have increased egg size at the expense of brood size thereby

<sup>4</sup> For skinks this statement is based on a comparison of the overall average brood size of 70 tropical species ( $\bar{X}=2.69$ ,  $s^2=2.16$ ) and 22 temperate species ( $\bar{X}=4.79$ ,  $s^2=5.41$ ), each species being represented by an average brood size derived from a sample of five or more broods ( $t'=3.99$ ,  $P<.001$ ; Snedecor and Cochran, 1967: 114-116; Greer, unpublished data).

increasing the size and hence the competitiveness of the young. Andrews and Rand (1974), however, think that tropical species are more stressed by predation than competition and have emphasized brood frequency at the expense of brood size thereby maximizing their reproductive contribution prior to their almost certain early death, the presumption being that the shorter life expectancy makes it too risky to spend a great deal of time yolkng a large brood. It is debatable which of these two hypotheses is nearer to the truth for the tropical skinks with only one oviduct, but the operative factor in either hypothesis, that is, increased competition or increased predation, could provide the ultimate selective force for reallocating the energy that would otherwise go into the development and maintenance of one of the two oviducts in these skinks.

Finally, as pointed out above, in each of the seven or eight skink lineages in which the oviduct has been lost independently, it has always been the left oviduct which has been lost and not the right. This is also true of all the other squamate lines which have lost an oviduct. The reason for this seems fairly clear. In most squamates the left member of normally paired organs, such as lungs and oviducts, is generally smaller than the right member—perhaps due to the fact that other unpaired organs, such as the stomach, lie on the left side—and hence the loss of this smaller member is presumably proportionately less disruptive to developmental processes. Amphisbaenians are an exception to this generalization due to the fact that they have reduced or lost the right lung instead of the left (Butler, 1895).

It is significant, however, that as far as is known, all of the skinks that have lost the left oviduct have retained a functional left ovary (Table 1), and as far as is known this is also true of the other squamate lines that have lost the oviduct. This indicates that, although selection has presumably mediated the loss of one of the two bilateral conduits for transporting the eggs and young to the outside world, it has left intact the bilateral machinery for producing the eggs. It is interesting to note that prior to ovulation the left ovary generally shifts over to the right side in skinks (personal observation).

#### ACKNOWLEDGEMENTS

Most of the material that I have examined during the course of this study is in the Museum of Comparative Zoology at Harvard College under the curatorial care of Professor Ernest Williams. Needless to say Professor Williams' generosity and encouragement have been vital to this work. Two other curators have also been helpful in supplying crucial material, namely, Dr. W. D. Haacke of the Transvaal Museum for supplying female *Typhlosaurus garipeensis* and Mr. Hymen Marx of the Field Museum for providing female *Isopachys roulei*. I have also benefited greatly from Professor Carl Gans' generous summaries of amphisbaenian and uropeltid anatomy. Finally, the following readers have aided me substantially by providing criticisms of various drafts of this paper: Dr. Harold Cogger, Ms. Bonnie Dalzell, Dr. Raymond Huey, Ms. Phylp Greer, Dr. Lynette Moffat, and Mr. Peter Rankin.

#### References

- ANDREWS, R. and RAND, A. S., 1974.—Reproductive effort in anoline lizards. *Ecology*, 55 : 1317–1327.
- BERGMAN, R. A. M., 1953.—The anatomy of *Cylindrophis rufus*. *Proc. K. Ned. Akad. Wet. Amsterdam, Ser. C.*, 56 (5) : 650–712.
- BROWN, W. C. and ALCALA, A. C., 1961.—Populations of amphibians and reptiles in the submontane and montane forests of Cuernos de Negros, Philippine Islands. *Ecology* 42 (4) : 628–636.
- BROWN, W. C. and FEHLMANN, A., 1958.—A new genus and species of arboreal scincid lizards from the Palau Islands. *Occ. Pap. Nat. Hist. Mus. Stanford Univ.*, No. 6, 7 pp.
- BUSTARD, H. R., 1968.—The reptiles of Merriwindi State Forest, Pilliga West, northern New South Wales, Australia. *Herpetologica* 24 (2) : 131–140.



- BUTLER, G. W., 1895.—On the complete or partial suppression of the right lung in the Amphisbaenidae or of the left lung in snakes and snake-like lizards and amphibians. *Proc. Zool. Soc. London*, 1895 : 691-712.
- CLARK, D. R. JR., 1970a.—Loss of the left oviduct in the colubrid snake genus *Tantilla*. *Herpetologica* 26 (1) : 130-133.
- , 1970b.—Ecological study of the Worm Snake *Carphophis vermis* (Kennicott). *Univ. Kans. Publ. Mus. Nat. Hist.* 19 (2) : 85-194.
- COE, W. R. and KUNKEL, B. W., 1906.—Studies on the California limbless lizard, *Anniella*. *Trans. Conn. Acad.* 12 (1) : 1-55.
- COGGER, H. G., 1972.—A new scincid lizard of the genus *Tribolonotus* from Manus Island, New Guinea. *Zool. Meded. Rijks Mus. Nat. Hist. Leiden*, 47 : 202-210.
- DIXON, J. R., 1973.—A systematic review of the teiid lizards, genus *Bachia*, with remarks on *Hcterodactylus* and *Anotosaura*. *Univ. Kans. Mus. Nat. Hist. Misc. Publ.*, No. 57, 47 pp.
- FOX, W. and DESSAUER, H. C., 1962.—The single right oviduct and other urogenital structures of female *Typhlops* and *Leptotyphlops*. *Copeia* 1962 (3) : 590-597.
- GREER, A. E., 1974.—The generic relationships of the scincid lizard genus *Leiolopisma* and its relatives. *Aust. J. Zool.*, Suppl. Ser., No. 31, 67 pp.
- and PARKER, F., 1967.—A new scincid lizard from the northern Solomon Islands. *Breviora* No. 275, 20 pp.
- , 1968a.—A new species of *Tribolonotus* (Lacertilia : Scincidae) from Bougainville and Buka, Solomon Islands, with comments on the biology of the genus. *Breviora* No. 291, 23 pp.
- , 1968b.—*Geomyersia glabra*, a new genus and species of scincid lizard from Bougainville, Solomon Islands, with comments on the relationships of some lygosomine genera. *Breviora* No. 302, 17 pp.
- , 1974.—The *fasciatus* species group of *Sphenomorphus* (Lacertilia : Scincidae) : notes on eight previously described species and descriptions of three new species. *Papua New Guinea Sci. Soc. Proc.*, 25 : 31-61.
- HECHT, M. K., 1952.—Natural selection in the lizard genus *Aristelliger*. *Evolution*, 6 : 112-124.
- HUEY, R., PIANKA, E. R., EGAN, M. E and COONS, L. W. 1974.—Ecological shifts in sympatry : Kalahari fossorial lizards (*Typhlosaurus*). *Ecology* 55 (2) : 304-316.
- KLUGE, A. G., 1967.—Higher taxonomic categories of gekkonid lizards and their evolution. *Bull. Am. Mus. Nat. Hist.* 135 (1) : 1-60.
- LOVERIDGE, A., 1941.—Revision of the African lizards of the family Amphisbaenidae. *Bull. Mus. Comp. Zool.*, 87 (5) : 353-451.
- MINTON, S. A. JR., 1959.—Observations on amphibians and reptiles of the Big Bend region of Texas. *Southwest. Nat.*, 3 : 28-54.
- ROBB, J. and SMITH, H. M., 1966.—The systematic position of the group of snake genera allied to *Anomalopis*. *Nat. Hist. Misc.*, No. 184, 8 pp.
- SMITH, H. M., SINELENIK, G., FAWCETT, J. D., and JONES, R. E., 1973.—A survey of the chronology of ovulation in suoline lizard genera. *Trans. Kans. Acad. Sci.*, 75 (2) : 107-120.
- SNEDECOR, G. W., and COCHRAN, W. G., 1967.—*Statistical Methods*. Iowa State Univ. Press, Ames, Iowa ; 593 pp.
- STEBBINS, R. C., 1954.—*Amphibians and Reptiles of Western North America*. McGraw-Hill Book Co., Inc., New York ; 528 pp.
- TAYLOR, E. H., 1963.—The lizards of Thailand. *Univ. Kans. Sci. Bull.*, 44 (14) : 687-1077.
- TINKLE, D. W., WILBUR, H. M., and TILLEY, S. G., 1970.—Evolutionary strategies in lizard reproduction. *Evolution*, 24 (1) : 55-74.
- UZZELL, T., 1969.—The status of the genera *Ecleopopus*, *Arthroseps* and *Aspidolaemus* (Sauria, Teiidae). *Postilla*, No. 135, 23 pp.
- , 1970.—Teiid lizards of the genus *Proctoporus* from Bolivia and Peru. *Postilla*, No. 142, 39 pp.
- ZWEIFEL, R. G., 1966.—A new lizard of the genus *Tribolonotus* (Scincidae) from New Britain. *Am. Mus. Novit.*, No. 2264, 12 pp.

# FOUR-WINGED DIPTERA FROM THE UPPER PERMIAN OF AUSTRALIA

E. F. RIEK\*

(Plate XI)

[Accepted for publication 21st July 1976]

## Synopsis

A complete specimen of *Choristotanyderus nanus* Riek shows that the species had four wings and that the hind wing was about two-thirds as long as the fore wing. The fore wing has the characteristic kink in the stem of R that is diagnostic of the Diptera. The species differs from Mecoptera, also, in having R straight at the origin of Rs in the fore wing. The species retains the plesiomorphic characters of a large pterostigma, 4-branched Rs and M, distinct CuP widely separated from CuA, and at least two long anal veins and very probably a distinct third anal. The fore wing is similar to that of *Permotanyderus*, which very probably had a hind wing as large as the fore wing. The family Permotanyderidae, embracing only *Permotanyderus* and *Choristotanyderus*, is referred to the Diptera and placed in a new suborder Perrisoptera. The suborder cannot be defined phylogenetically but is used for convenience to accommodate Diptera with four wings.

## INTRODUCTION

Riek (1953) described the fore wing (considered doubtfully as a hind wing) of *Choristotanyderus nanus* and placed the species in the Permotanyderidae because, although the basal stem of R with the kink diagnostic of the Diptera had not been preserved, as it is in *Permotanyderus ableptus* Riek (1953), the origin of Rs from R was similar to that in *Permotanyderus* and differed from that typical of Mecoptera, in which the stem of R is distinctly curved (concave) at the origin of Rs. The stem of R is straight at the origin of Rs in *Permotanyderus* and *Choristotanyderus*, as in Diptera. Riek placed the Permotanyderidae in Mecoptera, suborder Protodiptera because it seemed probable that the species had four wings. He restricted the order Diptera to species known to have only two wings.

The limits and affinities of the Protodiptera have varied. Crampton included the Paratrachoptera in the Protodiptera whereas Martynova (1962), while adopting much the same limits for the group, used the term Paratrachoptera. Tillyard (1937) distinguished between these two orders and relegated them to suborder status within an enlarged order Mecoptera. Riek (1953) adopted the classification proposed by Tillyard. Tillyard (1937) figured, but did not name, a species from the Upper Permian of Belmont (including the Warner's Bay area), Australia, that he referred to the Protodiptera because it had four wings, each of which was said to resemble those of Diptera. The species was subsequently named *Robinjohnia tillyardi* by Martynova (1948), and referred to a separate family that she considered ancestral to Neorthophlebiidae (Eumecoptera). Later (1961) she synonymised the Robinjohniidae with the Permotipulidae and (1962) referred the Permotipulidae to the Paratrachoptera (including Protodiptera). Tillyard (1929) described *Permotipula patricia* from a single wing, also from the Upper Permian of Belmont, and placed the family Permotipulidae in the superfamily Tipuloidea (Diptera), because of similarity in venation to that of Recent Tipulidae, from which it differed in the slight degree of petiolation, the short 2A and the elongate median cell. The affinities of the species remain obscure since the type is lost. It cannot be referred to the Diptera because it does not have the

---

\* CSIRO Division of Entomology, P.O. Box 1700, Canberra City, ACT, 2601.

diagnostic kink in the stem of R, R is curved at the origin of Rs and Rs arises relatively close to the wing base. The species would be surprisingly specialised for a primitive dipteran because Rs is only 3-branched, CuP obsolete and 2A very reduced and 3A apparently absent. Therefore, it is preferable to recognise the family Robinjohniidae as distinct from the Permotipulidae. However, Riek (1968) referred *Robinjohnia tillyardi* to the Nannochoristidae (Mecoptera) because the species lacks the kink in R diagnostic of the Diptera and the venation and body form are similar to those of both Upper Permian and Recent species of the family in which the venation is reduced and M and CuA are characteristically anastomosed for a considerable distance. Thus, the Permotipulidae, the affinities of which were obscure, remained the only family referred to the Protodiptera whether this be considered a separate suborder or a subordinate group within the suborder Paratrachoptera of the Mecoptera.

Riek (1970, p. 185) was of the opinion that the Permotanyderidae (*Permotanyderus* and *Choristotanyderus*), which he had originally referred to the Mecoptera, should very probably be referred to the Diptera because of the structure of R in the fore wing, but remarked that it might be necessary to establish a separate group within the order for the family should they prove to have had four wings. This indication of the possibility of four wings was deduced from the shape of the fore wing in *Choristotanyderus nanus* in which the hind margin was slightly concave in the middle and slightly widened at the apex of CuA. The hind margin of the wing was unknown for *Permotanyderus ableptus*.

Re-examination of the holotype of *Choristotanyderus nanus*, to check the male terminalia, showed that there is a faintly preserved hind wing that was overlooked in the original description. However, this information was not published although an illustration of the hind wing was prepared.

Subsequently, examination of the Australian Upper Permian insects in the British Museum (Natural History) brought to light a number of specimens of Permotanyderidae, and more detailed examination revealed that a completely preserved specimen, B.M. (N.H.) In. 45444, was referable to *Choristotanyderus nanus*. All four wings are at least partly preserved in this specimen and the stem of R is preserved in one fore wing. This shows the kink in the stem of R near its base that is diagnostic of the Diptera.

Another specimen, B.M. (N.H.) In. 45378, referable to *Permotanyderus ableptus*, but slightly larger than the holotype, shows the complete fore wing. The anal area is large and there are three distinct anal veins similar to those in Mecoptera. The wing is similar in shape to that of the small Mecoptera (*Prochoristella*) from the same horizon and, as there were four fully developed wings in the Mecoptera, it is more probable that there were four fully developed wings in *Permotanyderus* than that the hind wings were reduced or absent.

Thus, although the fore wings of *Permotanyderus* and *Choristotanyderus* differ in shape, they have similar basic venation, including the character diagnostic of the Diptera, and four wings were known to be present in *Choristotanyderus* and were probably present in *Permotanyderus*.

Although there were four wings in the Permotanyderidae, the family is referred to the Diptera because of unique apomorphic characters of the stem of R in the fore wing that I consider diagnostic of the order. However, the family is referred to a distinct suborder. Because of the lack of clear definition in the concept of the Protodiptera this name has been rejected, and a new name established for the archaic suborder of Diptera with four wings, at present based on the Permotanyderidae.

#### Order DIPTERA

*Diagnosis.* Fore wing with a distinct kink in R towards its base, and the vein straight at the origin of Rs.

Suborder **Perrisoptera**

*Diagnosis.* Diptera with four wings, hind wing sometimes slightly reduced both in size and venation. Stem of M distinct to or close to wing base, close to but distinct from R at the kink in that vein.

In the suborder Eudiptera the stem of M is fused with R basally so that M appears to arise abruptly, and transversely, from R: it is also aligned with MP which appears as a cross vein between M (=MA) and CuA.

One included family.

## Family PERMOTANYDERIDAE

Permotanyderidae Riek 1953, p. 75.

*Diagnosis.* Fore wing with well developed pterostigma. CuP distinct, widely separated from CuA. Three well developed anal veins in the fore wing at least in some species. Both Rs and M 4-branched in the fore wing of the known species.

Two included genera, *Permotanyderus* and *Choristotanyderus*, from the Upper Permian of Belmont, Australia. A well defined pterostigma is present in only a few Recent Diptera, notably Bibionidae and, in less defined form, in some Blephariceridae.

## Genus PERMOTANYDERUS Riek

*Permotanyderus* Riek 1953, p. 75.

*Type species.* *Permotanyderus ableptus* Riek 1953, p. 75.

*Diagnosis.* Only fore wing known. Wing of regular shape. Sc extending well towards apex of wing. Three well developed anal veins.

*Permotanyderus ableptus* Riek

Fig. 1; Plate XI, fig. 1

The species is known from the holotype F 40675 in the Australian Museum and a second, slightly larger and more complete fore wing (length 6 mm: holotype 5 mm), In. 45378 in the British Museum (Natural History) (figured). This second specimen shows two well defined nygmata between Rs and M, and a gradate series of cross veins in the distal part of the wing.

## Genus CHORISTOTANYDERUS Riek

*Choristotanyderus* Riek 1953, p. 76.

*Type species.* *Choristotanyderus nanus* Riek 1953, p. 76.

*Diagnosis.* Small Nematocera-like Diptera with long thin legs and head with multi-articulated antennae, and apparently stylate mouthparts. Fore wing tapering on both anterior and posterior margins to a rather pointed apex. Sc extending only slightly beyond the middle of the wing. Third anal vein, if present as is almost certain, short, but probably longer than in Recent Tipulidae. Hind wing reduced both in size and venation but more than half as long as fore wing: R distinctly curved at the origin of Rs.

*Choristotanyderus nanus* Riek

Figs 2,3; Plate XI, figs 2,3

The species is known from two specimens both of which preserve body structures. The holotype, F. 39964, Australian Museum, shows clearly the male terminalia whereas the second specimen, In. 45444 British Museum (Natural History), is almost certainly a female. As the second specimen preserves details



PLATE XI

Fig. 1. *Permotanyderus ableptus* Riek. B.M. (N.H.) In. 45378.

Figs 2-3. *Choristotanyderus nanus* Riek. B.M. (N.H.) In. 45444. Normal and reversed lighting to show details of the body structure.



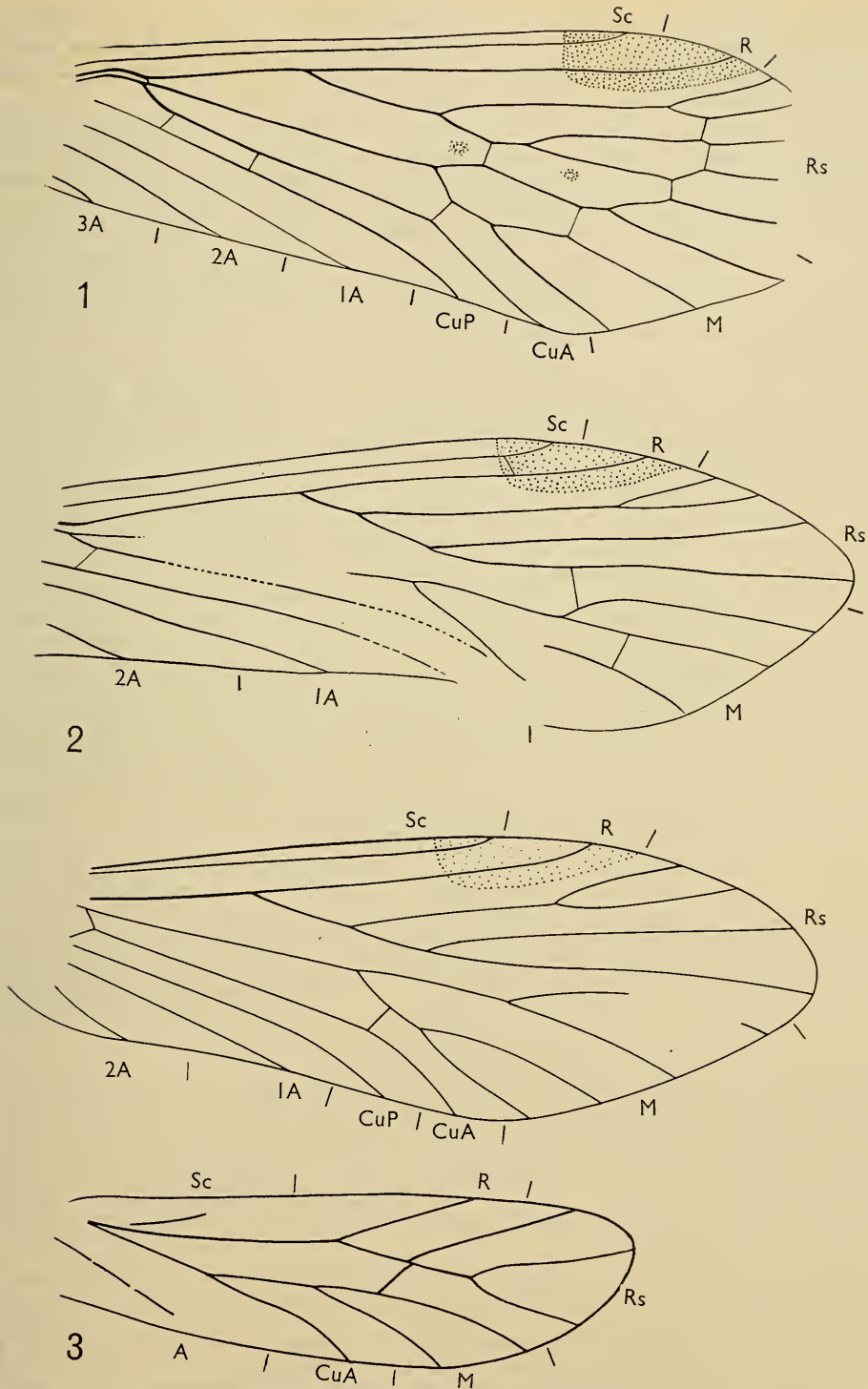

Fig. 1. *Permotanyderus ableptus* Riek. B.M. (N.H.) In. 45378.

Figs 2,3. *Choristotanyderus nanus* Riek. 2. Fore wing, B.M. (N.H.) In. 45444. 3. Wings of holotype, F. 39964.

not discernible in the holotype, a detailed description of the specimen follows. (Specimen figured, also venation of the holotype.) British Museum (Natural History) specimen In. 45444. Lateral view of an almost complete insect. Length c. 5 mm. Fore wing (extreme base not preserved) c. 5 mm.

*Head.* Lateral view. Similar in shape and structure of preserved parts to that of Blephariceridae. Eye large, subrounded, occupying most of the lateral head except for the produced lower head that is about one-third of eye length. Lower margin of clypeus apparently somewhat angular laterally. Labrum, apparently seen in dorsal view due to some distortion of this part of the head, stout, heavily sclerotized, stiletto-like, about as long as eye. Antenna with at least seven subequal, subquadrate articles; with basal article slightly enlarged but not clearly preserved; pedicel not differentiated. Labium (?) ill-defined but wider than labrum, preserved obliquely between labrum and antennae. Maxillary palp (?) with first segment long and thin.

*Thorax.* Large, convex dorsally. Structure of the lateral thorax difficult to interpret because of confusion between endoskeleton and the exoskeleton of both sides of the body but resembling that of Tipulidae of short stocky build, except that the metathorax is large. Laterally, thorax at least as deep as long. Sternopleuron of mesothorax of only moderate size so that the fore and middle legs are only moderately separated. Propleuron small, mesopleuron and metapleuron large. Pronotum relatively large, with distinctly defined dorsum level with anterior margin of mesonotum and with a median transverse sulcus dividing it into subequal anterior and posterior portions. Mesonotum large, upper surface distinctly convex in lateral view; scutellum small, subrounded; parapsides large, divided by distinct mesonotal "suture"; anterior part of scutum smaller than parapsis. Pteropleuron of mesothorax apparently about half as large as sternopleuron. Metanotum large, more than half as long as mesonotum, not as strongly raised as mesonotum and without distinctly defined scutellum or other sub-divisions. Metapleuron similar to that of mesothorax with clearly defined pleural "suture" but smaller, with sternopleuron larger than pteropleuron.

*Legs.* Long and very thin, at least as long as length of body, but preservation not distinct enough to indicate relative proportions.

*Abdomen.* Distinctly shorter than wings, very distended over middle segments, apex not exposed. Efforts had been made in the past to expose the hidden apex but this was not done very professionally so that it is now risky to proceed further to expose the area that may cover the apex of the abdomen. However, from the very markedly bulged abdomen tapering to apex one can infer that the specimen was almost certainly a female. The basal section of first abdominal segment apparently fused with metathorax (as in Recent Diptera, Mecoptera and other holometabolous orders) but level with remainder of abdomen; basal section narrow; apical section widely separated from basal, apparently not disrupted but connected by only lightly sclerotized membrane; apical part about twice as long as basal, but transverse. Second segment much longer, longer than the first as preserved. Third to fifth segments subequal to second, sixth slightly shorter, seventh not completely visible. Abdomen tapering towards apex from fifth segment. Sterna very faintly preserved, without heavily sclerotized plates, at least as broad as terga on segments 2 and 3, slightly narrower on 4, and decreasing on 5-7.

*Wings.* Parts of all four wings preserved, but hind wings not as complete as in one hind wing of holotype and the more complete fore wing crumpled in area of M.

*Fore wing.* Wide at base, widening regularly to beyond middle, rather pointed at apex with fore margin tapering beyond the pterostigma almost as much as hind margin (as in Psychodidae). Hind margin slightly concave in the middle, before apex of CuA. Anal area large, with wing broad at base. Pterostigma



large, extending well below R almost to Rs 1+2. Sc extending well into pterostigma and ending on the costal margin, with an oblique connection to R at base of pterostigma but extending into it. R distinctly kinked towards base, ending well before apex of the wing. Rs arising slightly before middle of wing, 4-branched, with Rs 1+2 forking much more distally than Rs 3+4, with Rs 4 ending at wing apex. M 4-branched, with both forks deep but M 3+4 branching well before M 1+2. Stem of M continued towards base below the stem of R at the kink and cross connection from near base of M to CuA oblique, strong, continuing the line of the base of M so that CuA almost appears to arise from the wing base. CuA strong, distinctly downcurved towards wing margin. CuP and stem of Cu weak but defined, with CuP well separated from CuA. 1A strong, parallel to CuP, about as distant from CuP as CuP is from CuA. 2A widely separated from 1A and much shorter, base not preserved. There appear to be three anals in this more completely preserved wing but the vein in the middle is actually the fore margin of the hind wing. Hind margin of wing continued straight more basally than the apex of 2A so that a short 3A was probably present, as in some Recent Diptera (in which it is extremely short). Cross veins few, clearly defined between Rs 4 and M 1 (the r-m cross vein), and between M 1+2 and M 3 to enclose a discoidal cell. (The m-cu cross vein from M 3+4 to CuA is preserved in the holotype.) There may have been a cross vein from R to Rs 1+2 but, if so, it is obscured by the pterostigma.

*Hind wing.* About two-thirds as long as fore wing. Base not preserved. Venation reduced. R distinctly curved (concave) at the origin of Rs. Rs 3-branched, arising well beyond the middle of R, with Rs 1+2 simple. Sc not clearly preserved. Combined costal and subcostal spaces wide. (Structures of hind wing more clearly preserved in the holotype. Wing slightly pointed at apex but with fore margin almost straight to apex. Sc apparently short, not entirely preserved. M 2-branched, appearing to arise from CuA about its middle. CuA appearing to arise from R close to the base. CuP and stem of Cu not visible. One anal vein partly preserved.) At least fore and apical margins of both fore and hind wings with fine setae, often indicated only by the setal insertions. Setae of the order of 30-40 between the branches of the veins, less between Rs 1 and Rs 2. The setae on the costal margin are dense and irregular.

#### ACKNOWLEDGEMENTS

I am grateful to John Green for the photographs and Mrs. Sybil Monteith for the final line drawings. I also wish to thank Dr. H. W. Ball, Keeper of Palaeontology, British Museum (Natural History) for the loan of the specimens on which this study was based.

#### References

- MARTYNOVA, O. M., 1948.—Materials on the evolution of the Mecoptera. *Tr. Paleontol. Inst. Akad. Nauk SSSR*, 14 (1) : 1-76. [In Russian].
- , 1961.—In, Rohdendorf, B. B., Becker-Migdisova, E. E., Martynova, O. M. and Sharov A. G. Palaeozoic insects of the Kuznetsk Basin. *Tr. Paleontol. Inst. Akad. Nauk SSSR*, 85 : 1-705. [In Russian].
- , 1962.—In, Rohdendorf, B. B. (Editor). Arthropoda. Insecta. In, *Bases of Palaeontology* : 29-374. Moscow. [In Russian].
- RIEK, E. F., 1953.—Fossil mecopteroid insects from the Upper Permian of New South Wales. *Rec. Aust. Mus.*, 23 : 55-87.
- , 1968.—*Robinjohnia tillyardi* Martynova, a mecopteroid from the Upper Permian of Belmont, New South Wales. *Rec. Aust. Mus.*, 27 : 299-302.
- , 1970.—Fossil history [of the insects]. In, *Insects of Australia*. Melbourne : CSIRO. 1029 pp.
- TILLYARD, R. J., 1929.—Permian Diptera from Warner's Bay, New South Wales. *Nature, Lond.*, 123 : 778-81.
- , 1937.—The ancestors of the Diptera. *Nature, Lond.*, 139 : 66-7.

## GILBERT PERCY WHITLEY, 1903-1975

(*Memorial Series No. 23*)

Gilbert Whitley, president of the Linnean Society of New South Wales 1963-64, a councillor since 1961 and a member for 49 years, died suddenly on July 18, 1975. He had that day been discharged from hospital following treatment for a heart-attack suffered during a customary walk to the harbour-side from his house in Mosman, Sydney. The first signs that all was not well came in April when he was laid up while on a family visit to Athens. He had intended to continue on a working tour of European museums and libraries but, instead, was forced to return home. Back at our council table in June he seemed cheerful though disappointed by what he termed lightly the ravages of old-age. On the day before the next meeting we were called to his funeral.

His passing closes a chapter in the record of Australian science, a chapter to which he and a small group of dedicated friends at the Australian Museum in Sydney made notable contributions. One thinks of Anthony Musgrave (1895-1959), Tom Iredale (1880-1972) and Ellis Troughton (1893-1974)—another of our past-presidents—as likewise of that band. Few in our time came nearer to maintaining the broad concern for natural history expressed by the founders of the Linnean Society than these. Few responded more enthusiastically to exploring the faunal variety of the Australian region.

Gilbert Percy Whitley was born June 9, 1903, at Swathling near Southampton and received grammar school training in his native Hampshire to the Cambridge Junior Certificate. While still at school he had found fascination in nature out-of-doors. At every opportunity he would be off in the countryside with sketch-book and collecting-net. Butterflies and moths were then his favourites and if later they had to compete for attention with other creatures the youthful enthusiasm for work in the field never disappeared.

In 1921 his parents removed to Australia with their son and two younger daughters. The family settled in Sydney where for nearly a year Gilbert worked in a warehouse. In his spare time he continued to sketch, so competently it would seem that Gilbert's father, a lace buyer, was urged by one of the warehouse staff to encourage his son's creative talent. A congenial opportunity soon came and on April 18, 1922, Gilbert Whitley joined the staff of the Australian Museum as cadet in the Department of Fishes, then the charge of Allan Riverstone McCulloch. There could have been no better teacher from whom to learn the business, but the association was sadly short; Gilbert had to acquire much of his ichthyology untutored. During that first year McCulloch was away in New Guinea and the young cadet spent part of the time attending E. A. Briggs's zoology course at the Sydney Technical College. In 1924 he gained Distinction and first place in the 2nd Year Zoology examinations at the University of Sydney but, being unmatriculated, a full degree course lay beyond his reach. In any case, duties at the Museum were increasingly demanding. McCulloch's health gave way and he died at Honolulu in September 1925 while on recuperative leave. By 1926 Whitley was Ichthyologist in charge of the department, a post from which he retired in August 1964 to devote his time to research, maintaining his connection with the Museum as an Honorary Associate.

One of the first tasks confronting the new curator was the editing for publication of his predecessor's *A Check List of the Fishes Recorded from Australia*. As Memoir no. 5 of the Museum it appeared in 1929-30, by which time the number of his own publications was growing apace. His pen scarcely rested. Were there

truth in the dictum "publish or perish" Gilbert Whitley ought to have been practically immortal! At the close of his career the list of his published writings runs to well over 500 titles—research papers and monographs, contributions to encyclopaedias and the like, as well as popular natural history pieces in magazines and newspapers—and some of his writings are only now being printed. The sheer magnitude of the list precludes its addition to this memorial where only a few samples can be mentioned. One wonders when he found time for letter-writing though he very clearly did. Many friends and colleagues about the world must treasure spontaneous notes from him that are gems of mixed wisdom and whimsy.

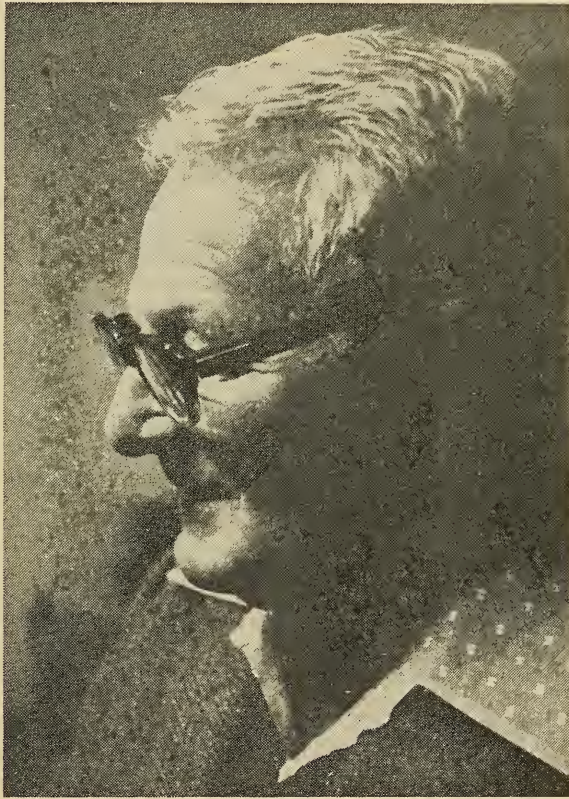

The compiler of a complete Whitley bibliography will face a daunting task, not because of the mass of his own pieces, for he was meticulous in keeping his census up-to-date, but because he became a sort of resident sage, albeit a most modest one, on matters relating to Australian fishes. Anything unusual found at the Sydney Fish Markets or by fishermen along the coast, reports of sharks and so forth, would be referred to him by journalists. In the popular view he was *the authority* to be consulted, and quoted.

This writer lacks the expertise to comment on the quality of the ichthyological work but is certainly impressed by the quantity. Some 340 of Whitley's published works deal with the subject! If one consults the census of fish species recorded from Australia to the year 1964 (*Proc. Linn. Soc. N.S.W.*, 89, 1964, pp. 32-60) it will be found that of the 2,447 names more than 320 of them were introduced by Gilbert Whitley.

No doubt many of those new names were fixed on material collected during his own travels. Travel was an activity vastly to Gilbert's taste and much of it he managed in his own time and at his own expense. Naturally gregarious, he enjoyed science congresses and excursions and made it his business to secure what came his way for the Museum collections. His first annual holidays in 1923 were spent at Lord Howe Island gathering insects with Anthony Musgrave. With longer periods of leave he ventured further—to Europe and the United States, to Japan and Asia, to Polynesia and so forth. The omission of Africa was corrected when he joined a safari tour in his years of so-called retirement. Back with him from these journeys came funds of stories, scientific, scholarly, aesthetic or simply bizarre. One recalls lively accounts of dog-eating in Tahiti, or dining out on poisonous fish in Tokyo, of Hitler's Berlin in 1937, and many more, less vivid perhaps but no less captivating.

Travel came also through invitations to join scientific expeditions, among the last being an American-Australian venture in the Tasman Sea during 1973. Back in 1928 he had spent three months with the British Great Barrier Reef Expedition led by C. M. (later, Sir Maurice) Yonge. Whitley's report on the fishes of the Low Isles appeared as one of the expedition papers issued by the British Museum (Natural History) in 1932. The 1929 visit of the Danish research vessel *Dana* brought an opportunity to sail as a guest-worker with Professor Johannes Schmidt. Again, in 1951 he worked with Anton Bruun aboard *Galathea*, for which efforts he was awarded a silver medal by the King of Denmark.

Early in 1942, with the approval of the Museum trustees, Gilbert joined the CSIR (now CSIRO) Division of Fisheries to assist in the elucidation of problems relating to edible fish—what and where they are. In a time of war the search for additional sources of food was a matter of priority. The secondment lasted until 1946 and involved much work at sea in Australian and New Guinea waters. His bulletin on *Poisonous and Harmful Fishes*, issued by the CSIR, dates from this period. Further investigations in the New Guinea region occupied another secondment to CSIR in 1948.

Not all his voyages were quite so nicely managed. One in particular, that of April–May 1936, might have ended tragically. Norman Wallis, a Sydney yachtsman, had purchased salvage rights to a wreck on Middleton Reef in the Coral Sea and organised an expedition to inspect the locality, then little known. High seas plagued the voyage and at one stage Wallis and two sailor-companions were washed overboard leaving, in Gilbert's own words, 'a very seasick naturalist for a short time in sole possession of the ship'. His story is woven into an article 'Graveyards of the Pacific' printed in the *Australian Museum Magazine* for 1936. There, with characteristic relish, he reported that by taking possession of Elizabeth and Middleton Reefs in the name of the Crown, the party had made the first territorial additions to the empire of King Edward VIII!

In July of the year before Gilbert ventured north to the Cumberland Group, off the Queensland coast, in search of the Devil Ray (*Daenomanta alfredi*). The first recorded specimen of this strange creature had been caught in Sydney Harbour in 1868. An anonymous author, whom Whitley identified as Gerard Krefft, sometime Curator of the Australian Museum, described it in local newspapers of the time. The name honoured H.R.H. Prince Alfred who had just escaped assassination here. Gilbert delighted to resurrect such details and to remind his readers of the work done by our forbears. It is beyond estimating the hours he spent at the Mitchell and other libraries poring through files of old newspapers and documents in search of material on Australian natural history and those who contributed to our knowledge and collections. His notes, laboriously copied in longhand in the days before xerox, were ever at the service of enquirers.

This attraction to history is not surprising. After all, he worked in Australia's oldest museum. Robert Etheridge, director from 1895 until 1920, had shown the way. His successor, Charles Anderson, also evinced historical sympathies. Both directors in their historical work were concerned particularly with documentation, with bringing together the facts of historical record, rather than interpretation and method. Such, too, was the preference of Gilbert Whitley and his friends Iredale and Musgrave. Indeed, the trio became dedicated bibliographers. Whitley and Iredale were founder-members (1936) of the Society for the Bibliography of Natural History, London, first presided over by that splendid character Dr. C. Davies Sherborn, a fertile influence on the Sydney friends.

Whitley's published bibliographical work consists chiefly in the appendices to his presidential address (*A Survey of Australian Ichthyology*) to this society in 1964 and to his many biographical studies. The choice of subjects for these latter is revealing. They include, of course, friends like Tom Iredale, whom he regarded as the Australian Linnaeus though some may feel that honour should be shared. Others less well-remembered also appear. He enjoyed seeking justice for the underdogs. Gerard Krefft, not generously treated by the trustees of the Australian Museum, is a case in point. John Lhotsky, another naturalist who had more than his share of rough treatment in this country, is another. A monograph on this forgotten visitor, his work and works will appear in 1977; to it Gilbert contributed an article and part of the bibliography. If belated credit comes to Lhotsky's reputation it will be in large measure through the efforts of this unmilitant crusader. Nearer the society's interests perhaps is the study and catalogue of our collection of paintings by Dr. James Stuart, a collection now deposited for safe-keeping in the Mitchell Library. That work, by Musgrave, Iredale and Whitley, appeared in the *Australian Zoologist* in 1955.

In addition to these studies of individuals, there are more general historical works that deserve mention. The paper *Some Early Naturalists and Collectors in Australia* issued by the Royal Australian Historical Society (of which he was long a member and for a time a councillor) in its journal for 1933, remains a valuable review. To celebrate Sydney's sesqui-centenary in 1938 came a study on the naturalists of the First Fleet in the *Australian Museum Magazine*. There ten years later appeared his article on some founders of Australian fish science. His last words on the early history of Australian zoology are to be found in two monographs published 1970 and 1975 by the Royal Zoological Society of New South Wales. The later work is an elaboration of an address delivered on completion of his third term (1973-75) as president of that society, a society whose fellowship (F.R.Z.S.) he had enjoyed since 1934 and which he served as editor for the period 1947-1971.

A history of the Australian Museum, the fruits of his many years' honorary work as Historian and Archivist, remains unpublished. One may hope that in this 150th year of the Museum efforts will be made to bring it out of the shadows, if only in an edited version. Failure to find a sponsor to publish the history had been a disappointment for Gilbert, the more so as the cost of printing was quite beyond his own resources. That must be said for, in fact, many of his works were printed with the aid of handsome subsidies from his own pocket. In the case of his grandfather's African journal (*Nathan Whitley's Journal*, Sydney, 1972) he met the whole cost himself. It is a work, incidentally, expressing something of the close family attachments that remained such a strength to Gilbert. He found riches enough there and with his friends and his work. Never ambitious of worldly wealth, he lived a bachelor in modest but hospitable comfort that left him sufficient means to travel occasionally and for private acts of generosity, not least of which were donations to societies like our own troubled by escalating costs for printing.

That may seem a solemn view of this most un-solemn man. He long enjoyed the unofficial title of Museum Bard, awarded in recognition of his 'Pomes' composed for special occasions such as a farewell party for a staff member. Many examples survive, characteristically light-hearted pieces full of puns and tortured rhymes, that set up the foibles of their subjects. The compliment was returned, of course. With apologies to W. S. Gilbert, his friend Anthony Musgrave made him "... the very model of a modern ichthyologist ...". Another colleague waxed lyrical in *The Prisoner's Song* celebrating Gilbert's arrest one Sunday in 1939 for (inadvertent) trespass on the military reserve at North Head—while collecting butterflies. Gilbert, in fact, was keenly interested in all the arts. He was a regular concert- and theatre-goer; he missed few good films and art exhibitions. He had a considerable knowledge of music and found much enjoyment playing the piano.

Gilbert's long connections with our society, with the Royal Zoological Society of N.S.W. and with the Royal Australian Historical Society have been mentioned. Many others will remember him. For a time he served as councillor in the Anthropological Society of N.S.W. and in 1972 was president of the Australian Society of Fish Biology. Work on behalf of ANZAAS and the Australian Great Barrier Reef Committee call for record. He sought no rewards, much preferring to work without fuss, but two major honours came his way—and when they did he alone was surprised. In 1967 there was the Australian Natural History Medallion. Three years later the Royal Society of N.S.W. bestowed on him its Clarke Medal. For that occasion his friend Oliver Chalmers prepared a splendid citation (printed anonymously, *J. Proc. R. Soc. N.S.W.*, 104, 1971, pp. 106-7) giving many details of a long and notable career of service to Australian natural history that are not repeated here. We remember Gilbert Whitley with affection and pride.

"The sweetest canticle is *Nunc Dimittis*, when a man hath achieved worthy ends".

[Warm thanks are extended to Mrs. Marjorie Frewer, Gilbert's sister, and his friend Mr. R. O. Chalmers for help and advice in the preparation of this memorial.]

T. G. VALLANCE

# Index

Vol. 101

Page	Page
Adaptive significance of the loss of an oviduct in reptiles . . . . .	242
Allen, G. R., A new species of Scorpaenid fish (Scorpaenidae) from Western Australia . . . . .	145
<i>Andreacarus balanites</i> , new species . . . . .	186
Annual General Meeting . . . . .	1
<i>Anopheles punctulatus</i> complex, biometrics and behaviour patterns of, in the D'Entrecasteaux Islands, Papua . . . . .	120
Atopomelidae (Acari); <i>Campylochirus</i> Trouessart and <i>Campylochiropsis</i> Fain . . . . .	27
<i>Australolaelaps</i> Womersley, new name <i>Thadeua</i> proposed . . . . .	186
Balance Sheets . . . . .	7
<i>Banksia serratifolia</i> , <i>aspleniifolia</i> and <i>ericifolia</i> . . . . .	38
Barkas, J. P., Early Devonian igneous activity and some stratigraphic correlations in the Tumut region . . . . .	13
Barley, rye and grasses, their role in the 1973-74 wheat stem rust epiphytotic in southern and eastern Australia . . . . .	65
Biogeographic basis of national cultures . . . . .	218
<i>Brachionus baylyi</i> , new species . . . . .	162
<i>Campylochiropsis</i> Fain, parasite of phalangeroid marsupials in Australasia . . . . .	27
<i>Campylochirus</i> Trouessart, parasite of phalangeroid marsupials in Australasia . . . . .	27
Carolyn, R. C., see Siddiqi, M. Y.	
Coastal heath in New South Wales, ecology of. The effects of water supply and phosphorus uptake on the growth of <i>Banksia serratifolia</i> , <i>B. aspleniifolia</i> and <i>B. ericifolia</i> . . . . .	38
Coastal heath in New South Wales, ecology of. Regrowth of vegetation after fire . . . . .	53
Corals, Upper Ordovician tabulate, from central-western New South Wales . . . . .	167
Culicidae, <i>anopheles punctulatus</i> complex, in the D'Entrecasteaux Islands, Papua . . . . .	120
Dermanyssidae . . . . .	186
Devonian, early, igneous activity in the Tumut region . . . . .	13
Domrow, R., New records and species of <i>Laelaps</i> and allied genera from Australasia (Acari: Dermanyssidae) . . . . .	186
Domrow, R., <i>Campylochirus</i> Trouessart etc., see Fain, A.	
Elytini, final-instar larvae of . . . . .	114
Fain, A., and Domrow, R., The genera <i>Campylochirus</i> Trouessart and <i>Campylochiropsis</i> Fain (Acari: Atopomelidae), parasites of phalangeroid marsupials in Australasia . . . . .	27
Fijian insects, food plants or hosts of . . . . .	237
Fleming, C. A., The biogeographic basis of national cultures, (Sir William Macleay Memorial Lecture 1976) . . . . .	218
Four-winged Diptera from the Upper Permian of Australia . . . . .	250
Gould, R. E., see Retallack, G.	
Greenwood, W., The food plants or hosts of some Fijian insects. V. . . . .	237
Greer, A. E., On the adaptive significance of the loss of an oviduct in reptiles . . . . .	242
Isotopic dating of a middle Triassic megafossil . . . . .	77
<i>Laelaps</i> and allied genera, new records and species of, from Australasia . . . . .	186
Luig, N. H., and Watson, I. A., The role of barley, rye and grasses in the 1973-74 wheat stem rust epiphytotic in southern and eastern Australia . . . . .	65
Macleay, Sir William, Memorial Lecture 1976 . . . . .	218
Megafossil flora, middle Triassic, isotopic dating of . . . . .	77
Memorial Series No. 23, Gilbert Percy Whitley, 1903-1975 . . . . .	256
Myerscough, P. J., see Siddiqi, M. Y.	
Oviduct, adaptive significance of loss of in reptiles . . . . .	242
Parasites on phalangeroid marsupials, <i>Campylochirus</i> Trouessart and <i>Campylochiropsis</i> Fain (Acari: Atopomelidae) . . . . .	27
Permotanyderidae, placed in new suborder . . . . .	250
Perrisoptera, a new suborder of Diptera . . . . .	250
Phytodietini, final-instar larvae of . . . . .	114
Phytoseiidae, immature stages of three mite species of . . . . .	149
Regrowth of vegetation after fire in coastal heath . . . . .	53
Report on the Affairs of the Society for the year . . . . .	1
Retallack, G., Gould, R. E., and Runnegar, B., Isotopic dating of a middle Triassic megafossil flora from near Nymboida, northeastern New South Wales . . . . .	77
Riek, E. F., Four-winged Diptera from the Upper Permian of Australia . . . . .	250
Runnegar, B., see Retallack, G.	
Schicha, E., Immature stages of three mite species (Acari: Phytoseiidae) from apple in Australia . . . . .	149
<i>Scorpaenodes steenei</i> , new species . . . . .	145
Short, J. R. T., A description and classification of some final-instar larvae of the Phytodietini and Elytini (Hymenoptera, Ichneumonidae, Tryphoninae) . . . . .	114

	Page		Page
Siddiqi, M. Y., and Carolin, R. C., Studies in the ecology of coastal heath in New South Wales. II. The effects of water supply and phosphorus uptake on the growth of <i>Banksia serratifolia</i> , <i>B. aspleniifolia</i> and <i>B. ericifolia</i> . . . . .	38	Tabulate corals, Upper Ordovician, from central-western New South Wales . .	167
Siddiqi, M. Y., Carolin, R. C., and Myerscough, P. J., Studies in the ecology of coastal heath in New South Wales. III. Regrowth of vegetation after fire . . . . .	53	<i>Thadeua</i> , new name proposed for <i>Australolaelaps</i> Womersley . . . . .	186
Spencer, M., Bionomics and behaviour patterns of the <i>Anopheles punctulatus</i> complex (Diptera: Culicidae) in the D'Entrecasteaux Islands, Papua . .	120	<i>Thadeua serrata</i> , new species . . . .	186
Stratigraphy of Tumut region, New South Wales . . . . .	13	Timms, B. V., see Sudzuki, M.	
Sudzuki, M., and Timms, B. V., A new species of <i>Brachionus</i> (Rotifera) from the Myall Lakes, New South Wales . .	162	Triassic megafossil flora, isotopic dating of . . . . .	77
		Tumut, New South Wales, early Devonian igneous activity and stratigraphic correlations in the region . . . . .	13
		Upper Ordovician tabulate corals of central-western New South Wales . .	167
		Watson, I. A., see Luig, N. H.	
		Webby, B. D., Upper Ordovician tabulate corals from central-western New South Wales . . . . .	167
		Wheat stem rust epiphytotic in southern and eastern Australia . . . . .	65
		Whitley, Gilbert Percy, 1903-1975, Memorial Series No. 23 . . . . .	256



Proceedings of the  
Linnean Society  
of New South Wales

VOLUME 101

Nos. 445-448



# CONTENTS OF PROCEEDINGS, VOLUME 101

## PART 1 (No. 445)

(Issued 9th September, 1976)

### CONTENTS

	Page
Annual General Meeting :	
Report on the Affairs of the Society for the Year .. .. .	1
Balance Sheets .. .. .	7
BARKAS, J. P. Early Devonian igneous activity and some stratigraphic correlations in the Tumut region, New South Wales .. .. .	13
FAIN, A., and DOMROW, R. The genera <i>Campylochirus</i> Trouessart and <i>Campylochiropsis</i> Fain (Acari: Atopomelidae), parasites of phalangeroid marsupials in Australasia .. .. .	27
SIDDIQI, M. Y., and CAROLIN, R. C. Studies in the ecology of coastal heath in New South Wales. II. The effects of water supply and phosphorus uptake on the growth of <i>Banksia serratifolia</i> , <i>B. asplenifolia</i> and <i>B. ericifolia</i> .. .. .	38
SIDDIQI, M. Y., CAROLIN, R. C., and MYERSCOUGH, P. J. Studies in the ecology of coastal heath in New South Wales. III. Regrowth of vegetation after fire .. .. .	53

## PART 2 (No. 446)

(Issued 16th March, 1977)

### CONTENTS

	Page
LUIG, N. H., and WATSON, I. A. The role of barley, rye and grasses in the 1973-74 wheat stem rust epiphytotic in southern and eastern Australia .. .. .	65
RETALLACK, G., GOULD, R. E., and RUNNEGAR, B. Isotopic dating of a middle Triassic megafossil flora from near Nymboida, northeastern New South Wales .. .. .	77
SHORT, J. R. T. A description and classification of some final-instar larvae of the Phytodietini and Eclytini (Hymenoptera, Ichneumonidae, Tryphoninae) .. .. .	114
SPENCER, M. Bionomics and behaviour patterns of the <i>Anopheles punctulatus</i> complex (Diptera: Culicidae) in the D'Entrecasteaux Islands, Papua. .. .. .	120

PART 3 (No. 447)

(Issued 6th April, 1977)

CONTENTS

	Page
ALLEN, G. R. A new species of scorpaenid fish (Scorpaenidae) from Western Australia .. .. .	145
SCHICHA, E. Immature stages of three mite species (Acari : Phytoseiidae) from apple in Australia .. .. .	149
SUDZUKI, M., and TIMMS, B. V. A new species of <i>Brachionus</i> (Rotifera) from the Myall Lakes, New South Wales .. .. .	162
WEBBY, B. D. Upper Ordovician tabulate corals from central-western New South Wales .. .. .	167

PART 4 (No. 448)

(Issued 28th July, 1977)

CONTENTS

	Page
DOMROW, R. New records and species of <i>Laelaps</i> and allied genera from Australasia (Acari : Dermanyssidae). Part 2 .. .. .	185
FLEMING, C. A. The biogeographic basis of national cultures. (Sir William Macleay Memorial Lecture 1976) .. .. .	218
GREENWOOD, W. The food plants or hosts of some Fijian insects. V. ..	237
GREER, A. E. On the adaptive significance of the loss of an oviduct in reptiles .. .. .	242
RIEK, E. F. Four-winged Diptera from the Upper Permian of Australia	250
Gilbert Percy Whitley, 1903-1975 (Memorial Series No. 23) .. ..	256
Index .. .. .	261
Notes and instructions for authors .. .. .	267

The *Proceedings of the Linnean Society of New South Wales* contain original papers relative to "the Science of Natural History in all its branches", and reports of business transacted at the meetings of the Society.

#### NOTES AND INSTRUCTIONS FOR AUTHORS

Original papers may be submitted for consideration for publication in the Society's Proceedings. Submission of a manuscript must imply that the contents are original and have not been published previously in the same, similar, or abbreviated form, and that no similar paper is being or will be submitted for publication elsewhere until it has been either (a) not accepted for publication by the Society or (b) withdrawn by the author.

Papers submitted should embody the results of a significant piece of work. Interim reports, serialized studies and student theses should not be submitted.

Papers are accepted for publication (or otherwise) by the Council of the Society after taking into consideration advice received from at least one referee. The decision of Council is final.

Once accepted for publication a paper becomes the property of the Society, and copyright is vested in the Society. Reproduction of the author's synopsis in abstracting journals is authorized.

A paper may be withdrawn by the author at any time prior to acceptance.

Papers may be submitted by members or non-members of the Society but a paper submitted by a non-member must be communicated by a member of the Society, and will not ordinarily be considered for acceptance before July in each calendar year.

#### SUBMISSION OF MANUSCRIPTS

Manuscripts should be forwarded to the Secretary, The Linnean Society of New South Wales, Science Centre, 35-43 Clarence Street, Sydney, N.S.W. 2000.

Text and illustrations must be submitted in duplicate. The illustrations may be duplicated by any acceptable clear method and the duplicate set need not necessarily be identical in size with the originals. The author should retain a third copy for checking proofs. If a paper is not accepted for publication, the original copy of the typescript and illustrations will be returned to the author, but the duplicate copy may be retained by the Society.

Owing to the ever growing costs of publication, authors are requested to write their papers clearly and concisely and exercise all reasonable economy in the number and form of illustrations and tables.

Grants towards the cost of publication should be secured wherever possible from the author's own institution or elsewhere; contributions from authors, especially non-member authors, may be requested at Council's discretion, particularly in the case of lengthy papers, or those with numerous illustrations or tables.

Manuscripts must be submitted in final, fully corrected form. Authors may be liable for the cost of proof corrections (if allowed) if the number of alterations and corrections is considerable. Authors are urged to submit their paper to a colleague for constructive criticism prior to final typing and submission for publication.

#### MANUSCRIPTS

Papers should be typewritten, double spacing throughout, on one side of quarto or foolscap paper, with at least one-inch margins all round. The desired position of all text-figures, maps and tables may be indicated in the margin. All pages should be numbered serially and securely fastened together. Papers should conform to the following general layout as far as practicable or appropriate:

(a) *Title*.—The title should be concise but informative. The name(s) of the author(s) and the name of the institution where the work was carried out should follow the title. The name of a new taxon of plants or animals should not be included in the title. A short title appropriate for the running heading of subsequent pages may be suggested. The title, etc., should be on a *separate page* at the commencement of the typescript.

(b) *Synopsis*.—A concise abstract (without abbreviations), preferably consisting of not more than about 200 words, should be supplied on a *separate sheet* and in *triplicate*. It should be complete in itself and indicate the scope of the work. It will be printed below the title of the paper; it will be available for reprinting by abstracting journals.

(c) *Table of Contents*.—This should give the complete hierarchy of headings and sub-headings used in the subject-matter of the paper. It should be supplied on a *separate sheet* for guidance of the editor and will not ordinarily be printed.

(d) *Introduction*, followed by the *Subject Matter* of the paper. Papers may be divided into sections described by short headings.

(e) *Discussion, Conclusions or Summary* (if necessary).—This should summarize the conclusions reached rather than be a précis of the paper as a whole (cf. Synopsis).

(f) *Acknowledgements*, if any.

(g) *References*.—The author, who is alone responsible for their accuracy, should carefully check all references against the text, to ensure especially that :

- (i) The spelling of authors' names is consistent, and the dates, volume numbers and page numbers are correct.
- (ii) All authors quoted in the text are included in the list of references.

References should be cited in the text by the author's name and date, e.g., Bullough (1939) or (Bullough, 1939) according to context, and listed alphabetically under References thus :

Bullough, W. S., 1939.—A study of the reproductive cycle of the minnow in relation to the environment. *Proc. Zool. Soc. Lond., Ser. A*, 109 : 79-108.

If more than one reference by the same author(s) published in the same year is cited, use a, b, etc., after the year in both text and list, e.g., Bullough (1939a).

Titles of books must be given in full together with the place of publication, name of publisher and indication of edition if other than the first.

*Latin names* of plants and animals (genera, species and their subdivisions) should be underlined to indicate italics. An initial capital letter must be used for Latin names of orders, families and similar names, but these should not be underlined.

*Abbreviations*.—Only standard abbreviations should be used ; authors should refer to the British Standard 1991 : Part 1, 1976. Recommendations for Letter symbols, signs and abbreviations. The abbreviations of names of periodicals should conform to the International Code for the Abbreviation of Titles of Periodicals (ISO Standard, ISO 4—1972).

*Footnotes* should be avoided as far as possible.

*Codes of Nomenclature*.—The Botanical and Zoological Codes of Nomenclature must be strictly followed. If a new taxon is described, the institution in which the type material is deposited must be indicated.

*Language*.—Papers in languages other than English are unlikely to be accepted for publication. Foreign authors are urged to seek assistance, if necessary, in rendering the paper in fluent English prior to submission.

*Measurements* must be expressed in the metric system as far as practicable, and exclusively in scientific description.

#### ILLUSTRATIONS AND TABLES

The maximum dimensions available for either text-figures or plates are  $20 \times 12.5$  cm.

*Black and white drawings and diagrams* for text-figures should be in Indian ink on smooth white card such as Bristol board, the lines cleanly drawn, and due attention paid to the consequences of reduction. Graphs should similarly be in Indian ink on white card, or on faint blue-lined co-ordinate paper. Maps should be in Indian ink on white card or tracing linen ; if the latter the linen should not be folded. Maps should be of a size and scale that can be conveniently reduced to the size of a single page.

It is desirable that all black and white illustrations should be drawn  $1\frac{1}{2}$ -2 times the size that they will appear in print.

*Photographs* for half-tone plates should be the size required for final reproduction or slightly larger, printed on glossy paper, of good contrast and best quality. A number of small photographs can be arranged to form one plate.

Illustrations for colour reproduction cannot be accepted unless the author meets the difference in cost between black and white and colour reproduction.

Illustrations of all kinds should bear the author's name and the number of each, lightly pencilled on the back, and their required orientation clearly indicated.

*Legends* for illustrations should be typed on separate sheets at the end of the manuscript. Great care should be taken in stating magnifications of illustrations, making it clear whether numbers quoted refer to before or after reduction.

*Tables*.—Tables should be numbered consecutively and referred to specifically in the text by number. Each table, together with a heading descriptive of its contents, should be submitted on a separate sheet. Elaborate tables should be avoided.

#### GENERAL

*Proofs*.—A set of galley proofs will be forwarded to the author who should correct and return them promptly to the Secretary.

*Reprints*.—Twenty-five reprints are supplied free to authors who are members of the Society. Additional reprints may be ordered at the authors' expense, if desired. No free reprints are supplied to non-members, who may order the number required at their own expense. Orders for reprints should be placed with the Secretary immediately after the paper has been accepted for publication. Orders received after the paper has been printed may not be accepted.

*Joint Authorship*.—In the case of papers by more than one author, one of them must accept responsibility for all correspondence with the Society regarding the paper.

Copies of the PROCEEDINGS OF THE LINNEAN SOCIETY OF NEW SOUTH WALES (with the exception of a few volumes and Parts) may be purchased from the Society, Science Centre, 35-43 Clarence Street, Sydney, N.S.W., 2000.

Current charges for the PROCEEDINGS are :

Volumes—\$16.00 each for 1st Series (Volumes 1-10); \$11.00 each for 2nd Series (Volumes 11-20) and all subsequent volumes.

Parts—\$5.00 each for all back Parts; \$4.00 each for current Parts. For volumes of 5 or 6 Parts, \$1.00 each for first and last Parts.

Prices do not include postage.

Subscription to the PROCEEDINGS—\$20.00 per volume, plus \$2.50 postage—\$22.50.

All prices are in Australian currency.

These charges may be revised from time to time, and inquiries should be addressed to The Secretary, Linnean Society of New South Wales, Science Centre, 35-43 Clarence Street, Sydney, N.S.W., 2000, Australia.

The Society's PROCEEDINGS are printed and published for the Society by the Australasian Medical Publishing Co., Ltd., 71-79 Arundel Street, Glebe, N.S.W. 2037.

# Proceedings, Volume 101, Part 4, 1977

## CONTENTS

	Page
DOMBROW, R. New records and species of <i>Laelaps</i> and allied genera from Australasia (Acari : Dermanyssidae). Part 2 .. .. .	185
FLEMING, C. A. The biogeographic basis of national cultures. (Sir William Macleay Memorial Lecture 1976) .. .. .	218
GREENWOOD, W. The food plants or hosts of some Fijian insects. V ..	237
GREER, A. E. On the adaptive significance of the loss of an oviduct in reptiles .. .. .	242
RIEK, E. F. Four-winged Diptera from the Upper Permian of Australia	250
Gilbert Percy Whitley, 1903-1975 (Memorial Series No. 23) .. ..	256
Index .. .. .	261
Notes and instructions for authors .. .. .	267





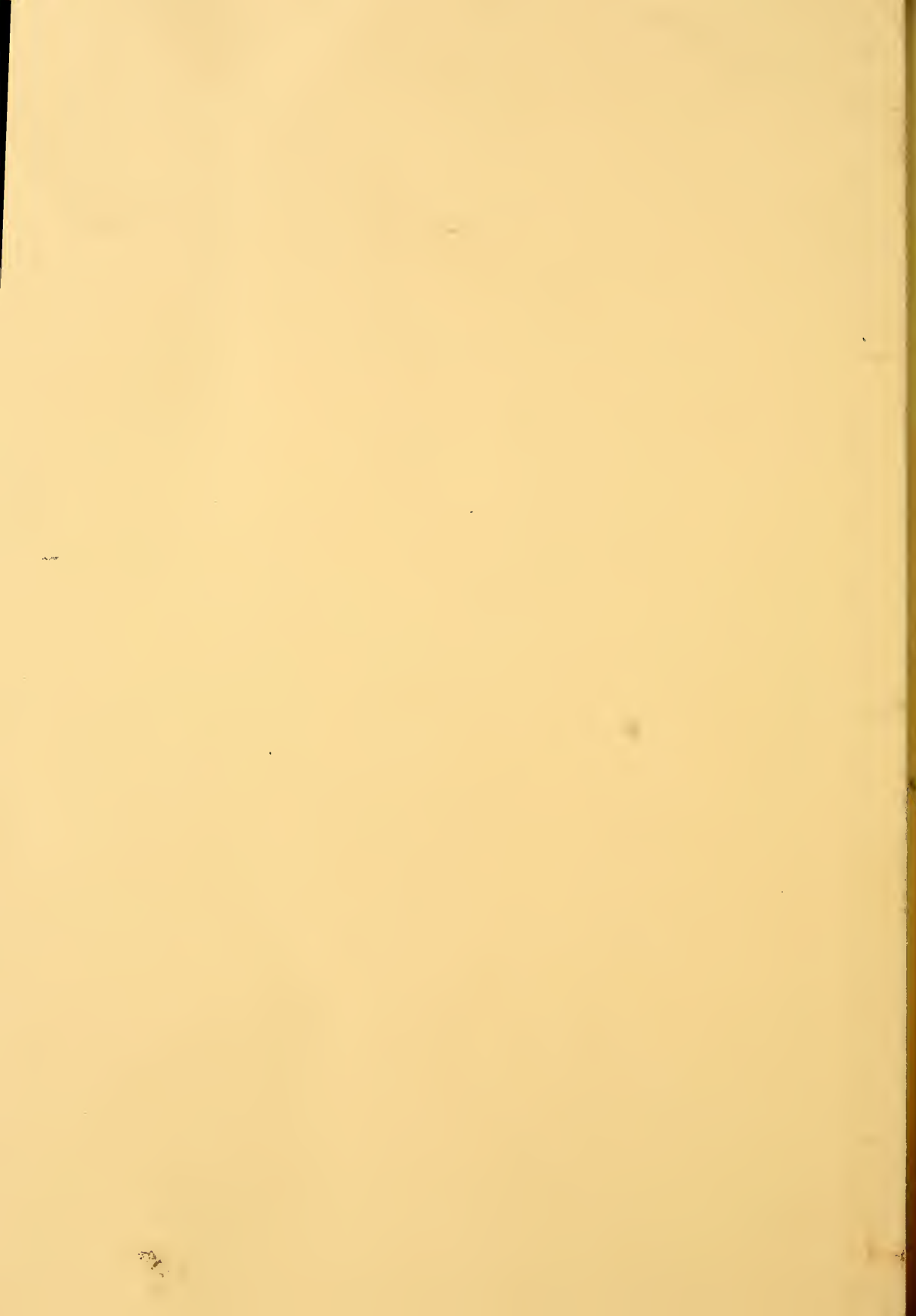





MBL/WHOI LIBRARY

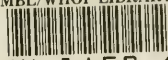

WH 1AES 6

