

TS 2301
.T7 K8
Copy 1

AMERICAN SCHOOL TOYS

C. A. KUNOU





Class TS 2.301

Book .T7 K8

Copyright N^o _____

COPYRIGHT DEPOSIT.

AMERICAN SCHOOL TOYS

AND USEFUL NOVELTIES IN WOOD

By

CHARLES A. KUNOU
Supervisor of Manual Training
LOS ANGELES, CALIF.



THE BRUCE PUBLISHING COMPANY
MILWAUKEE, WISCONSIN

T 2301
TK8

Copyright, 1920
The Bruce Publishing Company

70-26563

MAY -6 1920

© CL A570770

Dedicated to
Dr. James P. Haney

TABLE OF CONTENTS

Introductory Notes.....	5-6		
American School Toys—Educational Influence—The Bazaar Idea—In What Grade Taught—Americanization of Toys—Originality—Purpose of Teaching—Types of Toys—How to Pick Motifs—Fitting the Design to the Material—Transferring Patterns to Wood—Cutting Toys—Making Bases—Assembling—Painting—Coloring—Enameling—Mass and Dot Painting—Other Methods of Coloring and Finishing Toys—Color Schemes—How to Make Tints.....	7-16		
DESIGNS FOR TOYS—			
Plate 1: Position of Boy in Using Coping Saw.....	10	Plate 21: Duck Cart.....	40
Plate 2: Simple Bases for Toys.....	19	Plate 22: Horse	41
Plate 3: Complex Bases for Toys.....	20	Plate 23: Bear on Wheels.....	42
Plate 4: Horse	21	Plate 24: Elephant on Wheels.....	43
Plate 5: Tiger	22	Plate 25: Swan Cart.....	44
Plate 6: Tiger	23	Plate 26: Chicken Cart.....	45
Plate 7: Mountain Goat.....	24	Plate 27: Bear Cart.....	46
Plate 8: Mountain Goat.....	25	Plate 28: Swan on Wheels.....	47
Plate 9: Dog	26	Plate 29: Cart	48
Plate 10: Clown	27	Plate 30: Lion on Wheels.....	49
Plate 11: Assembly of Clown and Chicken on Wheels.....	28	Plate 31: Express Wagon.....	50
Plate 12: Ostrich	29	Plate 32: Automobile	51
Plate 13: Indian	30	Plate 33: Hobby Horse.....	52
Plate 14: Toy Bed Stead.....	31	Plate 34: Locomotive	53
Plate 15: Toy Chair.....	32	Plate 35: Traveling Tumbling Clown.....	54
Plate 16: Toy Rocker.....	33	Plate 36: Tumbling Clown.....	55
Plate 17: Toy Table.....	34	Plate 37: Camel	56
Plate 18: Soldier and Red Cross Nurse.....	35	Plate 38: Dog	57
Plate 19: Rocking Cat and Pig.....	36	Plate 39: Duck Paper Weight.....	58
Plate 20: Rocking Hen and Rooster.....	37	Plate 40: Paper Weights.....	59
Plate 20: Swan Rocker.....	38	Plate 41: Policeman Candle Holder.....	60
Plate 21: Swan Rocker.....	39	Plate 42: Clown Sconce.....	61
		Plate 43: Turkey Paper Weight.....	62
		Plate 44: Cat Paper Weight.....	63
		Plate 45: Candle Holder or Flag Staff.....	64
		Plate 46: Savings Bank.....	65
		Plate 47: Savings Bank.....	66
		Plate 48: Flag Staff.....	67
		Plate 49: Flag Staff.....	68
		Plate 50: Spool and Scissors Holder.....	69
		Plate 51: Detail of Scissors Holder.....	70
		Plate 52: Match Stands.....	71

INTRODUCTORY NOTES

Statement by the Superintendent of Schools:

Immediately after the declaration of war in 1917 the various heads of departments and principals of the Los Angeles schools met in conference with the Superintendent to make such reorganization in curriculum and administration as seemed necessary to meet the new conditions. It was recognized that the schools should not in any way cease their normal function of educating the children, but rather that these new adjustments might provide an education more interesting and more significant.

Those who followed the relation of education in city school systems to the demands of war are familiar with the work done by the schools. The members of the supervisory and teaching force have since expressed a decided opinion that the changes then made in the school organization redounded greatly to the benefit of the pupils. A new motive to instruction was provided. The novelty of the demands created extraordinary initiative among the learners. The pupils of the public schools were conscious that they were not merely spectators of the war, but sharers therein, that they had become contributors to their country's welfare.

The work of the Manual Training Department attracted much favorable notice. The problem set before the mind of the pupil was the planning and construction of some project which he was to fashion after his own idea and which he was then to turn over for sale, the proceeds to be devoted to the Junior Red Cross. No attempt was to be made at multiplying the same product by individual children. The shops also did a great deal of what may be termed "factory work" in supplying material for camps, hospitals, etc., on urgent demand. But, the projects discussed in this report were differently conceived. The endeavor always was to have the work made by each pupil follow the traditions of good craftsmanship. The thing he made was to be his own creation, both in design and construction.

The most popular activity among the younger children was the making of toys. Their introduction made a distinct sensation in the shops. The School Department was able to maintain one center of

its own which was visited by many citizens of Los Angeles who bought generously. The exhibits of the schools in this and other places were not confined to toys, but toys constituted the major part of the material sold from the Department of Manual Training.

No educational consideration was sacrificed. On the contrary, there were distinct gains for education. The enthusiasm and freedom in the workrooms elicited comment from every visitor. Under the direction of the Supervisor, the members of the Manual Training Department worked out the program. Not only for the material results obtained, but for the educational values accruing to children in making them, all the members of this department are deserving of the greatest praise.

ALBERT SHIELDS.

Statement by the Assistant Supervisor:

The problem of toy making forms a part of a large industrial activity that will rapidly increase in the next few years. There are great opportunities open to the schools these days for the modeling of ideas of culture and design in the minds of the growing children and the parents as well, in the kind of toys made in the schools and played with in the homes. The toys will be "American Made." We should strive to interest good designers and inventors in the betterment of toys.

There are many features of this industry that are very broad outside the constructive process. The color must be chosen that will attract buyers, the surfaces must be painted so as to give a finished appearance, and this applies, not only to toymaking, but to all commercial output from the other great industries. The more one studies the problems of toymaking, the more he will realize that there is a great future for the industry and that we must have a great part in it. This is one example of what we mean by keeping up with the progress of industrial life in our educational outlook.

The work in toy making started in the Los Angeles schools some eight or ten years ago, and although we did not dream of such developments, the work has been steadily growing, and with the teachers

co-operating, many creditable toys of commercial value have been produced.

Special problems appear in the manual training rooms that are different from the regular factory operations, such as, handling paints in small quantities and various colors, kinds of brushes, their use, cleaning and general care, simplicity of mixing colors, and many other problems that have been considered during the last few years.

Mr. Kunou has successfully striven to organize the toy making in the same careful way the general bench work has been developed; he has drawn charts, conducted teachers' classes for instruction, in which actual work was presented and carried out, all, to further the plan for the good of the children of our city.

After fourteen years in the Manual Training office with Mr. Kunou, I am glad to make these statements regarding this valuable addition to the manual training work.

CHAS. M. MILLER
Ass't Supervisor Manual Training
Los Angeles City Schools

Los Angeles, Calif., 1919.

Statement by the Author:

The educational and practical value of toys and useful novelties as parts of manual training courses in the schools has engaged the attention of the author for many years. During the war it became necessary to enlist the schools in the service of the country. For this purpose the Superintendent of Schools instituted the reorganization of the courses of study in the schools of Los Angeles which had for its aim the introduction of features of work that would meet material needs without sacrificing educational values in the schools. It was this reorganization that inspired the larger efforts which demonstrated the possibilities and values of the kind of manual training work herein presented. It is now a matter of national record how the largest production of school-made toys and other articles ever attempted was successfully carried out in 1917 and 1918. The Bazaar at which these articles were sold yielded a large sum which was turned over to the local Red Cross Chapter. But above all, it was the discovery of new values in manual training work which is the inheritance of these war work efforts. The author acknowledges the services of Manual Training Teachers and Pupils, whose patriotism and skill made the work herein described possible.

C. A. KUNOU.

AMERICAN SCHOOL TOYS

The educational influence of toys upon the children is at present not so generally appreciated as might be expected. There is a time coming soon, however, when people will endeavor to give toys to children for a far more comprehensive purpose than mere amusement. It is a question whether the happiness, contentment and interest displayed by the child in the possession of, and activities with his toys, is really a state of play or amusement, in the sense the word play is at present accepted; or whether it is a state of actuation in which motives and habits of impelling force are being formed to function later in the child's life.

If the sense of this question is clear, is it not worth while to call attention to the significance and true meaning of toys and their influence upon children's lives? In this connection other questions present themselves concerning the kind of toys, their character and purpose, whether they are artistically or poorly made. Not the least important question is whether children should be taught to make toys, when they are old enough to do so.

The answers to all these questions ought surely no longer be left solely to money-getting manufacturers of cheap and questionable toys. The schools will undoubtedly realize their responsibilities along this line and recognize the potential nature of toys as means of education. They will take hold of this important feature of child activity and thus seek to bring to light the truth about toys. It is safe to say that toys should be made not so much for the purpose of furnishing undirected occupation and mere amusement to children for "keeping them quiet" and "out of mischief, etc.," but rather for the purpose of affording instruction and development. It is also proper to state that in their "make up" and in their instructive and play qualities, toys should express and emphasize national ideals.

Viewed in this light, toy making seems to be a matter of no mean importance, and one which presents an unlimited field for practical and educational explorations and discoveries. This is the author's conviction, and to this end he desires to contribute his share.

The Bazaar Idea

In some European cities permanent expositions of handwork made by school children are maintained. At the Bazaars—as these displays are sometimes called—the children's products are on sale. These Bazaars are very popular places and are patronized by the best people. When the articles are sold, part of the price paid is deducted for the upkeep of the place and for sales services. The remainder is remitted to the children who made the articles. These Bazaars are part of the scheme of the practical art education of the people, and exert an inspiring influence in raising the standard of children's handwork to the point of being marketable. If this is a good practice in these older communities, is it not worth while to adopt the Bazaar idea in the United States? Cannot it be made the means by which the latent talent among the American school children may be discovered and unfolded in a practical way, especially now that there is a general need for domestic-trained designers in the industrial arts? Many of the efforts in the schools during the war were along these lines and they were surely successful and effective.

In what grades can this work be successfully done?

During the past ten or twelve years, toy making has been a successful and interesting part of the manual training course in the Los Angeles schools. The work has been a considerable factor in the attainment of educational and practical results. The simpler projects have been started in the four-a and fifth grades, and the more difficult and complex designs and color schemes have been worked out by sixth and seventh grade pupils.

Rockers, chairs, tables, etc., and novelties for use in the nursery are excellent problems for seventh and eighth grades. Girls and boys alike can do this work well, for the reason that it calls into play their imagination as nothing else will.

Americanization of Toys

Every toy and article made in the schools should be stamped or labeled. In Los Angeles rubber stamps are used and the toys bear the legend "Made in Los Angeles School" or "Made in America."



A Class of Toy Makers at Work.

Claim of Originality

The making of toys is not new. The author, however, claims without RESERVE, that he originated the kind of toy making herein described in the schools of Los Angeles, and so far as he knows in schools anywhere. The first charts for teachers' instructions drawn by him were presented to the manual training teachers of Los Angeles city schools at a meeting during the school year 1907-1908.

General Purposes

The purposes of toy making are as follows:

First:—To practicalize manual training work in the schools by raising the educational and artistic qualities of articles made in the shops to marketable standards.

Second:—To enable every child to make toys and other things of

salable quality, "learning and earning" both in school and at home and thereby fostering a national industry.

Toys are practical articles. "Vogue" articles, or useful novelties, are not toys, but they are objects which have various practical uses. The designs of these toys and articles are characterized by a freedom from adherence to accepted styles. If properly and freely designed, these toys and articles revive national art instincts; they express freedom in design and color and embody humor, caricature, quaintness, individuality, joy and art.

The field from which to design such toys and articles is infinite. The educational possibilities and practical results are equally not calculable. The American people possess just the qualities which enable them to find endless expression in this kind of work.

The material provided in the plates in this book consists of: First, Painted Wood Toys; Second, Painted novelties, or "Vogue" articles of wood.

The Painted Wood Toys are of two classes:



Africa—Asia—Europe—Toy Makers All.

Types of Toys

1. Stationary Toys made by combining two or more pieces of material glued, nailed and screwed together, and pleasingly colored or painted.

2. Mechanical Toys. In this class are the toys which "go" and which are built upon some mechanical principle. This is exemplified in rockers and in the carts with wheel and axle, which have been evolved from the stationary toys.

How to Pick Motifs

The toys may be "drawn freehand." Any pictorial or linear design from books, magazines or posters may be used. The motif may be cut out from the book or may be traced on tracing paper, which is transparent. This gives the exact copy of the NATURAL motif, for in most cases such motifs are natural. But the natural motif is not desirable as such. It must be changed to fit the material. The change is called conventionalization.

To Fit the Design to the Material

This process of conventionalization consists in simplifying and squaring the outlines of the motif in order that the design may express the characteristic of the material in which it is executed. Man-



Corner in a Red Cross Toy Shop.



A School Toy Bazaar.

ual training teachers will find this kind of procedure one of the secrets in successful modern manual training work. It is not the cubist method. Motifs for stationary toys may be used for moving toys, and practically any stationary or statuary toy may be made into a moving toy, by attaching wheels to its base, or otherwise making it GO. The conventionalizing of toy designs and the selection of color schemes give splendid opportunity for closely correlating drawing and manual training. Children produce readily motifs for their own conventionalized drawings and also color schemes.

Transferring Pattern to Wood

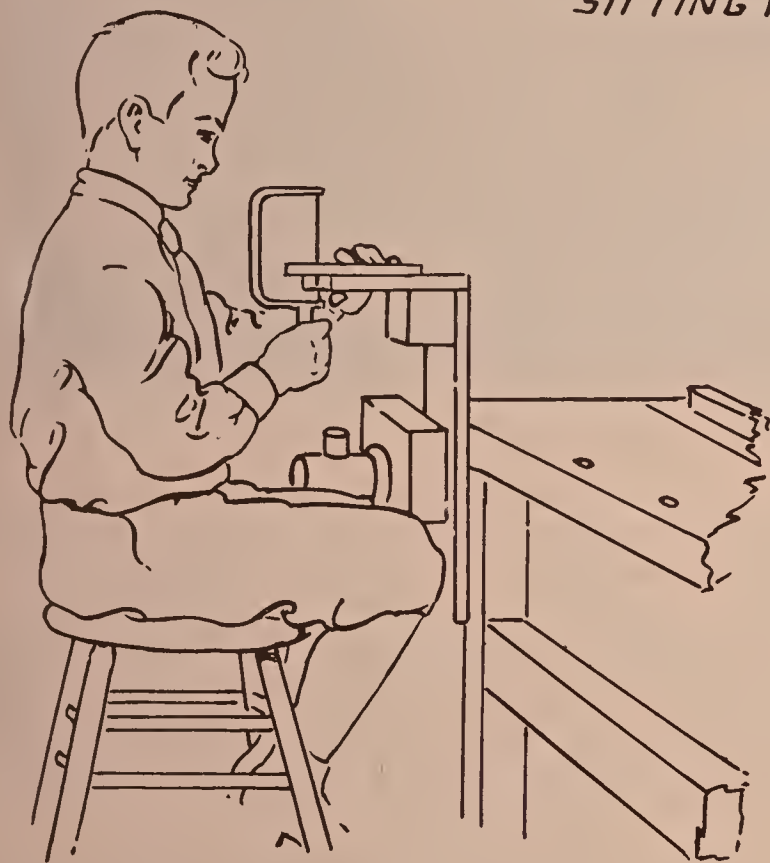
The pattern may be transferred to the wood by any one of the following three methods:

1. Place carbon paper on the wood, and the pattern on top of the carbon paper, fastening it with thumb tacks. Then trace the outline with a pencil.

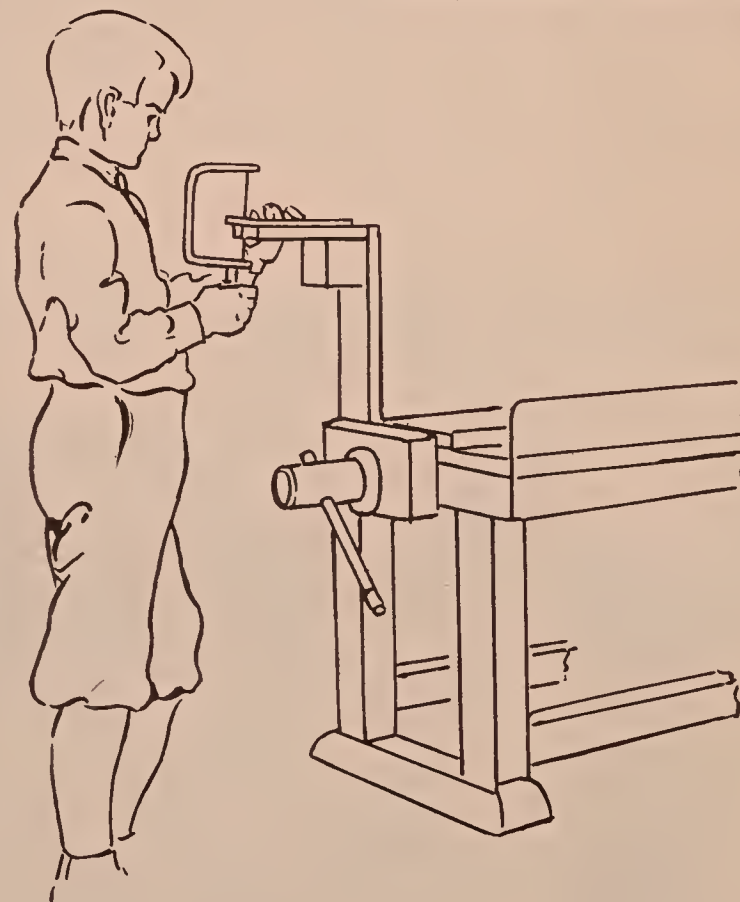
COPING OR SCROLL SAWING

SKETCHES SHOWING POSITION OF COPING SAW AND COPING SAWTABLE WHILE CUTTING OUT
TOY
IN EACH SKETCH THE PUPIL'S CHIN IS ABOUT 6" OR 8" ABOVE THE WORK ENABLING THE WORKER
TO BLOW OFF DUST TO CLEAR THE LINE

SITTING POSITION



STANDING POSITION

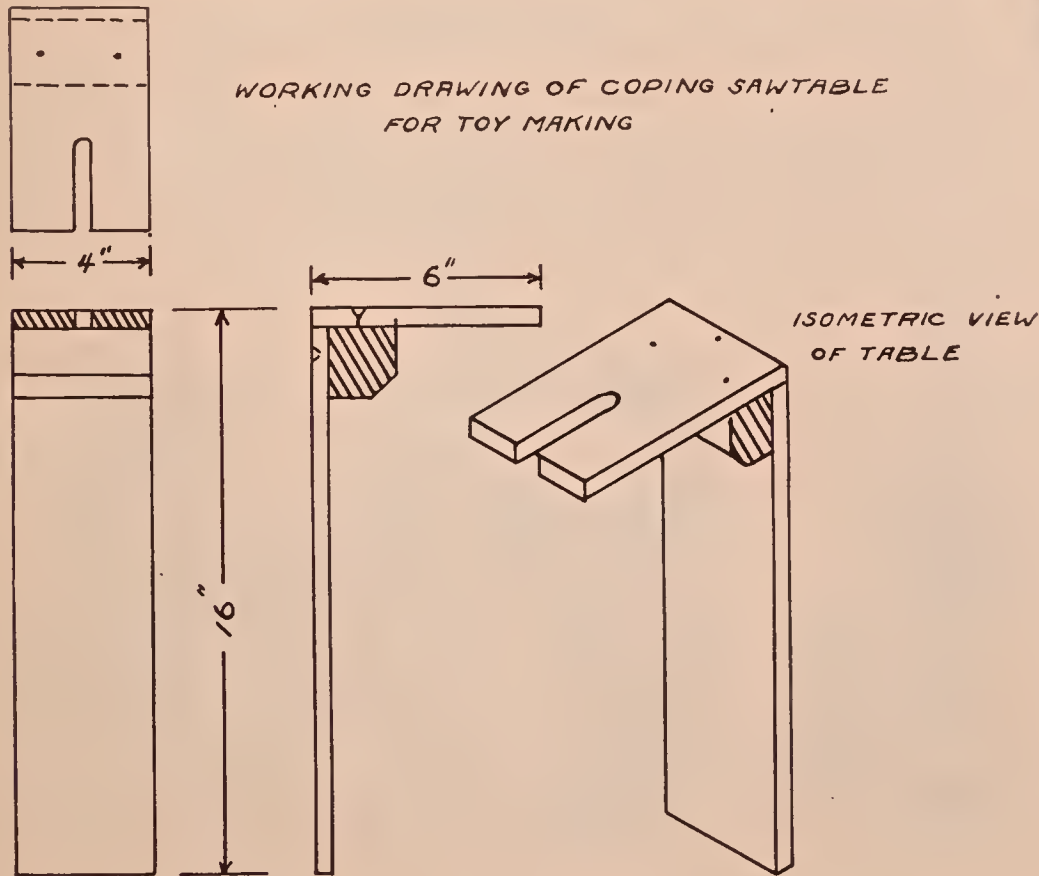


2. Paste the picture or pattern on the wood. When dry cut out the figures.

3. Trace on thick paper and cut out a template, then trace with a pencil around the edges of the template. These templates, if correctly made, are permanent patterns and may be used for a long time before they are worn out. This is the best method for schoolwork because it is practical under all usual school conditions.

How to Cut out Toys

The toys are cut out with coping saws. For working comfortably and effectively, each child must have a saw jack or an adjustable saw table. The adjustable saw table is placed in the bench vise. The child may sit or stand as he prefers. In either case the saw table should be adjusted so that the pupil's position is comfortable and natural. The piece of work should not be more than six inches below his chin. This insures a restful position in which the pupil does not



Details of Saw Table.



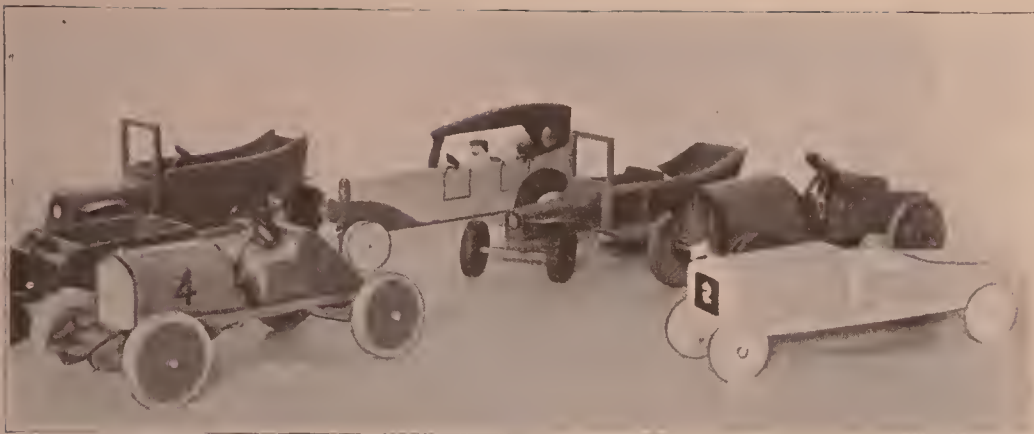
Typical Animal Toys.

tire quickly. Fatigue is the main cause of breaking pieces. The pupil is also enabled to "blow off" the saw dust to keep the line "clear."

Making Bases

The design and construction of bases is important because a poor base spoils the toy. The bases should be stationary in design, for statuary toys. A base is made of at least two pieces, one overlapping the other. It should be square, oblong or round, as the case requires or personal preference dictates. Strips of $\frac{1}{4}$ " , $\frac{1}{2}$ " and $\frac{7}{8}$ " stock are prepared and from these the required lengths are cut. This sawing off is done with the back saw in small mitre boxes made for the purpose. The dimensions of these mitre boxes are 1" deep, 2" wide inside, and 12" long. It is essential to have "fresh" cuts in the mitre box, insuring "square cuts" and cut "to line" and "to finish." There should be no planing or filing.

The upper piece of the base is usually thinner than the lower. For small toys $\frac{1}{4}$ " stock is used for upper and $\frac{1}{2}$ " stock for lower part. Larger toys require a combination of $\frac{1}{4}$ " and $\frac{7}{8}$ " stock respectively for upper and lower parts to make a more substantial base of massive effect. The extension of the lower piece is equal to the thickness of the upper piece. The observance of this rule gives a certain character to the work.



Suggestions for Automobile Toys.

Assembling Toys

After the toy and base pieces have been cut, the assembling process logically follows. First, place the toy in a vise, "feet up," and put glue on the contact points. Second, nail the upper piece of the base to the body of the toy, using $\frac{3}{4}$ " or 1" brads as required. Third, then turn over, apply glue and nail the toy to the thick base, using escutcheon pins, one pin in each end. Sandpaper the rough parts and the woodwork is finished.

Hew to the Line

In cutting out the contours of figures with the coping saw "cut on the line" and "cut to finish." Do no filing on the edge work. In cutting off base pieces in the mitre box, cut on the side of line and "cut to finish." There should be no block planing.

Painting

Painting, including enameling, is one of the most valuable topics to teach in manual training courses. It belongs there. It is easy to teach and is fascinating, educational and practical. By it pupils can be taught plain and practical color schemes, such as are used and accepted in the industrial arts everywhere.

The promiscuous use of all sorts of color by pupils in their work is an error that should not be tolerated. The right teaching of color reveals the laws and principles of color and demonstrates to the pupils that their work must be done accordingly. Then comes the revelation that "it works" and presently the problems "take." And this is the secret underlying success in all manual training teaching.

Coloring the Toys

The coloring of toys consists of two parts: 1. The giving of a first or undercoat; 2. The enameling.

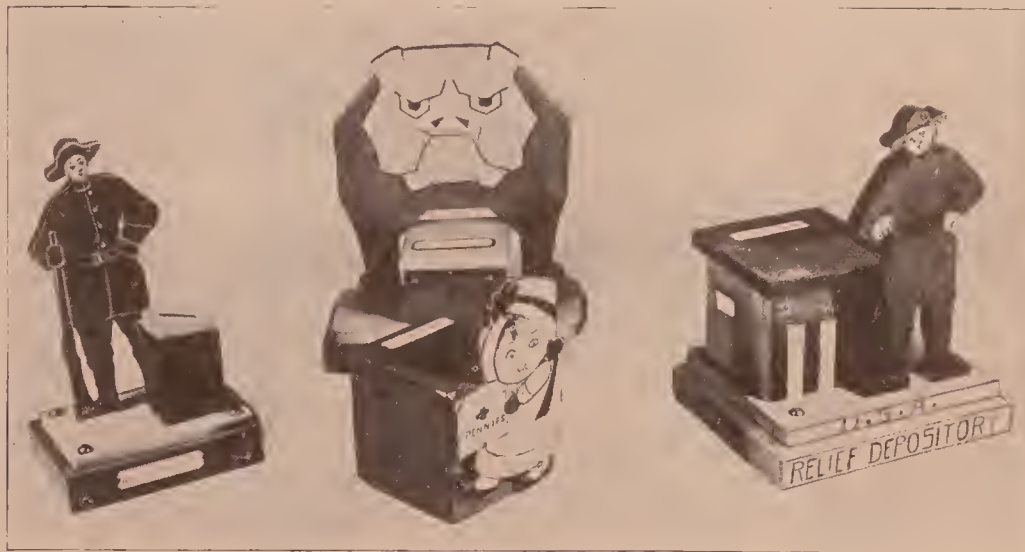
The Primer or First Coat

All toys must be given a first coat of paint called the primer or undercoat. When a large number of toys is made, the dipping process is the quickest. This, however, requires more paint than the brushing method. The best method for ordinary school work is to paint the toys. For the first coat use ready-made white lead or a white flat paint. Brush it on with a flat sash tool brush, not less than 1" wide. After the first coat has been applied, stand up the toys and let them dry. At the end of the drying period, sand the "roughs" with No. $\frac{1}{2}$ or No. 0 sandpaper. The flat tone surface will be found smooth and the toy is now ready for coloring.

The Enameling

The coloring of the toys is done with colored enamel. Toy enamel is made by mixing small portions of colors ground in oil, in white enamel, turning the white enamel into colored enamel or enamloid. The following typical operation will illustrate the best process:

First, pour a teaspoonful of white enamel into a water color cup, such as are used in drawing and art work.



Savings Banks.

Second, using a whittled wood spade, put a "speck" of say brown (color ground in oil) in the enamel. Stir and mix well until the white enamel has a very light tint. Put in another "speck" of brown and the enamel will become darker in shade.

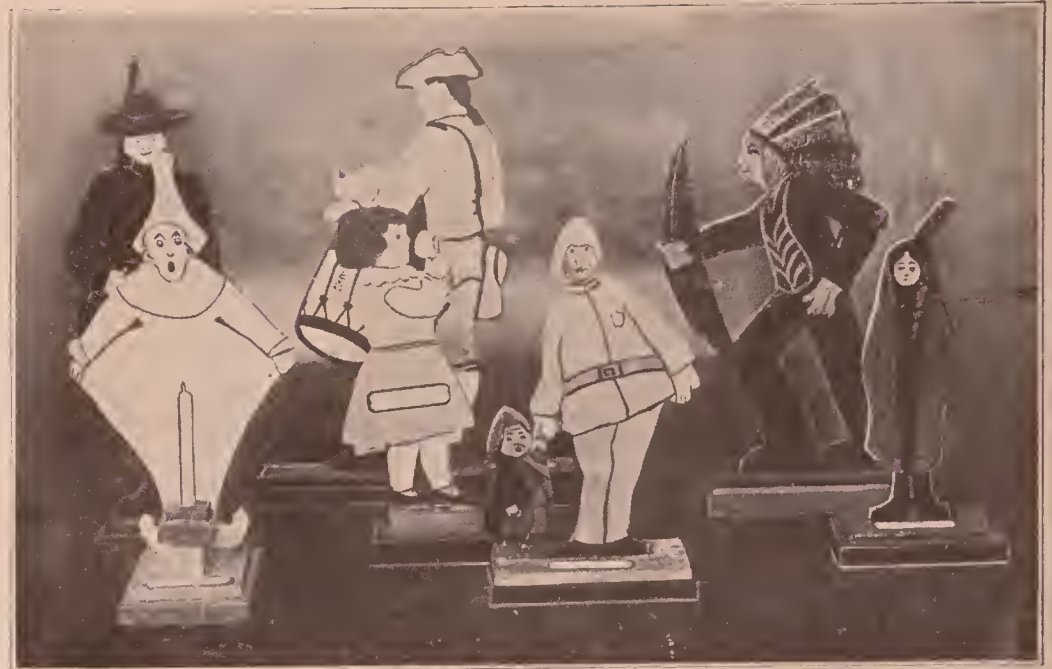
Third. Now apply to a trial stick and keep mixing and trying until the desired tint or shade has been obtained. Then apply to the toy. Proceed in the same way with any color.

Fourth. For drying let the toy stand at least 24 hours. The toy now shows a smooth, pleasant, glossy, colored surface.

This is the typical process and is the same for whatever color used. It is the best method for children and beginners and yields good results. It may be used for finishing one toy or a hundred toys.

Mass and Dot Painting

Natural details and linear effects should be avoided. Conventionalize the eyes, ears, mouths, etc., using the point of a small brush or a toothpick for "picking up" color and "dotting" it on.



Stationary Toys.

For features on small toys, use artists' No. 10 flat brushes and artists' No. 3 Round Sabre. For surface work use larger brushes.

Another Method of Painting Toys

Give the toys a first coat with flat tone. Then instead of using enamel for coloring, use lead colors ground in oil and mix the colors as before described. The toy so painted presents a dull or mat finish. The mat finish is considered artistic, but is not any more so than the enameled finish. If a gloss finish is desired on a toy painted with oil colors, apply a coat of varnish over the dull color and a bright finish will result.

Still Another Method of Coloring and Finishing Toys

Toys and "vogue" articles may be stained with wood dyes, water stain or water color. The finishing in this case is done by applying coats of shellac over the water stain. Should a better finish be desired, apply a coat of varnish over the shellac and a more glossy and permanent surface is obtained. Shellac often affects water color.

Yet Another Method

Use colored enamels (ready made) and apply two coats. Colored enamels are more expensive and their use prevents the teaching of



Some Useful Novelties.

color mixing. The author does not ordinarily approve of the use of ready made stains in finishing, nor the use of colored enamels in toy-work because the children should be taught to mix the colors.

Color Schemes

There are many color schemes. The dominant harmony herein described is not only easily applicable, but it is also a fundamental color scheme. It is used and accepted in the industrial arts everywhere. Frequently it is called two-tone or three-tone color. Thus there are two-tone and three-tone rugs in the market. It is the name applied to the use of TINTS and SHADES of ONE color. The skilled use of delicate and related tints and shades of one color is a high attainment in industrial art.

In color language, color is called HUE. STANDARD COLOR paints are those which are manufactured to resemble, so nearly as possible, the theoretical spectral colors. They are violet, blue, green, yellow, orange and red. There is light, medium and dark of each. In paints these colors are seldom used in their original strength and purity. There is a process to go through, the process of mixing and shading:

First:—When a hue, different from any of the standard colors is desired, it is obtained by mixing two or more different paints.

Second:—Black and white paints are used to make TINTS and SHADES of colors. White is used more frequently than black.



Girls Can Make Toys as Successfully as Boys.



Corner in a School Bazaar.

The list of colors, pigments and proportions presented in the table below, serves to illustrate how to obtain colors or hues by mixtures of paints. The production of a given shade of color is not due to chance trials, nor does it depend altogether upon the artistic color sense of the painter. It depends more upon a law of proportions of mixtures. For example, dark brown, is obtained by mixing red with yellow, and shading with black. Assuming that this shade of brown has been obtained by mixing three parts of red, two parts of yellow and one part of black, the same shade will always be obtained by these proportions, provided the same kinds of standard paints, or pigments, are used.

But if a hundred pupils mix paint, each using different proportions, many shades of brown are obtained and while the principle is the same, the shades of brown vary according to the color sense of the individuals. To arrive at this state in which each pupil can "try out" with different proportions to obtain tints and shades of color, begin by teaching the principle—the law—that underlies the process. This is a revelatory method. In mixing paints, no matter

how dark the shade desired, it must not be shaded **TOO DARK** or be made **MUDDY**. The color of it must show—a rule that may not be violated.

How To Make Tint

To continue the illustration, suppose the shade of brown has been obtained. The next step is the making of tints. **TINT** is the **SHADE** attenuated with white paint. In color language it is the addition of light to the color. The process is this: In a small quantity of white paint or enamel, as the case may require, put a speck of the brown. The white is now affected by the brown and is a **NEUTRAL TINT** of that color. By putting in more brown, a darker **TINT** or **SHADE** is obtained. In this way many tints of the same color may be obtained.

The rule is: First, To make a **TINT**, put white into the color. Second, To make a **SHADE**, put color into the white paint or into white enamel.

All tints and shades being of the same basic color, are related, and differ only in a ratio of light and dark; and when properly balanced in their application, result always in plain, correct, harmonious and pleasing color schemes.

This is considered the typical process in the use of any color, in the production of a two-tone or three-tone color scheme for toys.

Proportions and pigments used in mixing color

No.	Color	Mixtures and Proportions
1	Terra Cotta (Red)	1 yellow, 1 dark red, 2 white.
2	Terra Cotta (Brown)	1 yellow, 1 burnt sienna, 2 white.
3	Olive Green	Yellow shades with black.
4	Dark Green	5 chr. green, 1 black, 1 B. umber.
5	Dark Brown	1 red, 2 yellow, 1 black.
6	Chocolate Brown	Vermilion, shaded with B. umber.
7	Citrine	Red and yellow shaded with green.
8	Wine Red	Vermilion, shaded with black.
9	Gray (Bluish)	1 blue, 1 black, 9 white.
10	Drab (Soldier)	1 B. sienna, 1 yellow, 2 green, 1 white.
11	Purple	3 red, 2 blue, 3 white.
12	Violet	2 red, 3 blue, 3 white.
13	Gray	2 red, 3 green, add white.
14	Russet	3 red, 2 yellow, 1 blue.
15	Light Orange	2 yellow, 1 red, tone with white enamel.
16	Dark Violet	2 cobalt blue, 1 vermilion, add varnish.
17	Blue Green	1 cobalt blue, 1 Chr. green, M., add varnish.



Three of a Kind.

There are many other colors, other mixtures and proportions than the few enumerated in this list. In fact, the color field has no limitations. This list is presented for the purpose of showing the process of mixing paints to obtain colors.

Color Balance on Toys

In a two-tone or three-tone color scheme, (dominant harmony) balance is secured by proper proportions of tints and shades as applied on the objects.

The following rules will prove helpful:

First, There must be neutral background surface on the toy.

Second, There must be decorative elements or features standing out by contrast either in light or dark of same color on the background. The determinate method of application of the colored enamel is:

- Apply the neutral tint over the whole toy, including the base. Let dry.
- Paint eyes, ears, wings, feet, etc., in a dark shade. Let dry.
- "COME BACK" and paint the base of the toy in the dark shade of the same color. This gives contrast and makes the base and

other features stand out from the background. The base should, as a rule, be painted last so that the toy can be handled while being painted. Thus, properly proportioned, these spots and masses of dark shade balance, and result in a harmoniously and correctly painted toy.

Following is a method of using **ONLY ONE** undercoat and only **ONE** coat of colored enamel over it, without producing **STREAKINESS**:

If white undercoat is used and only one coat of colored enamel is applied over it, the surface is likely to be **STREAKY**. The appli-

cation of a second coat of colored enamel would remedy this; but that means more enamel, more work and an increase of cost. Therefore, determine the color scheme beforehand and put some of the color in the undercoat. In other words, if the color of the toy is to be bluish, put blue in the undercoat. Because of the agreement between the enamel and the undercoat, no **STREAKS** will show, if only one coat of colored enamel is applied. In the production of higher class ware, more than one coat of enamel is, of course, necessary. But while the work here described is of an elementary character, yet the process is typical and fundamental.

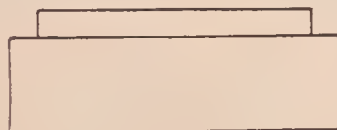
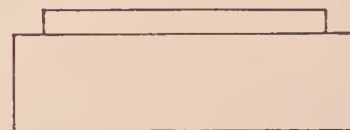
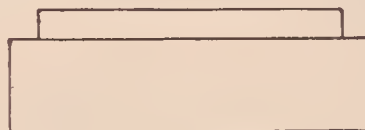
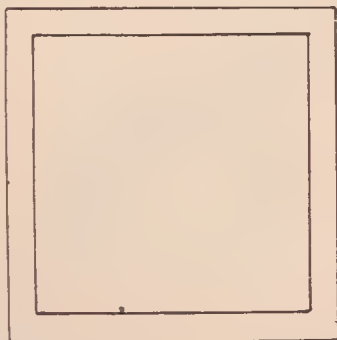
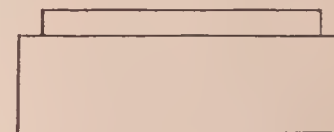
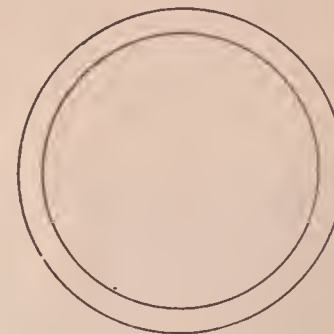
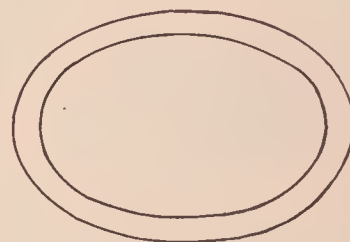
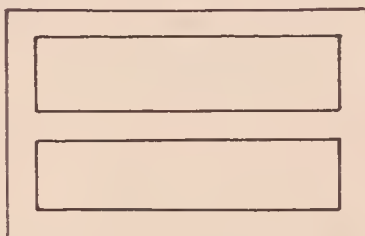
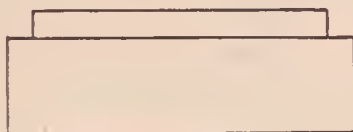
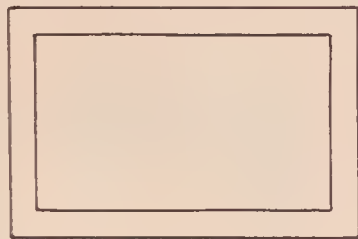


Some Toy Ships.

Designs for

AMERICAN SCHOOL TOYS

TYPES OF BASES FOR TOYS

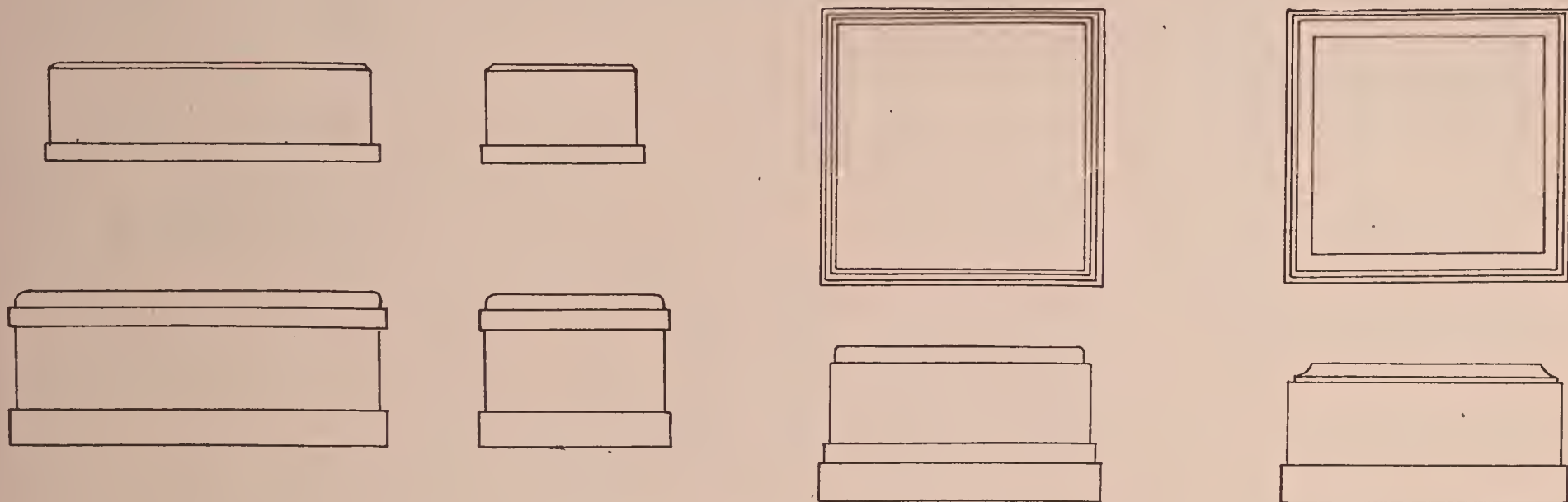


 = 1/16"



Plate 2. Simple Bases. (One-half Scale.)

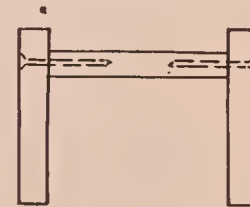
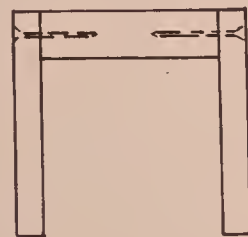
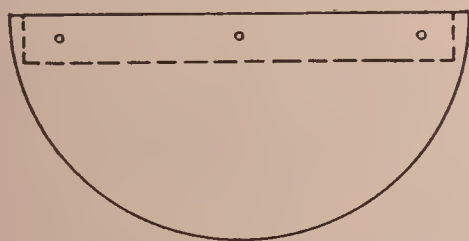
TYPES OF BASES FOR TOYS



ROCKING BASES

ACCELERATED MOTION

RETARDED MOTION



▬ = 1 in.

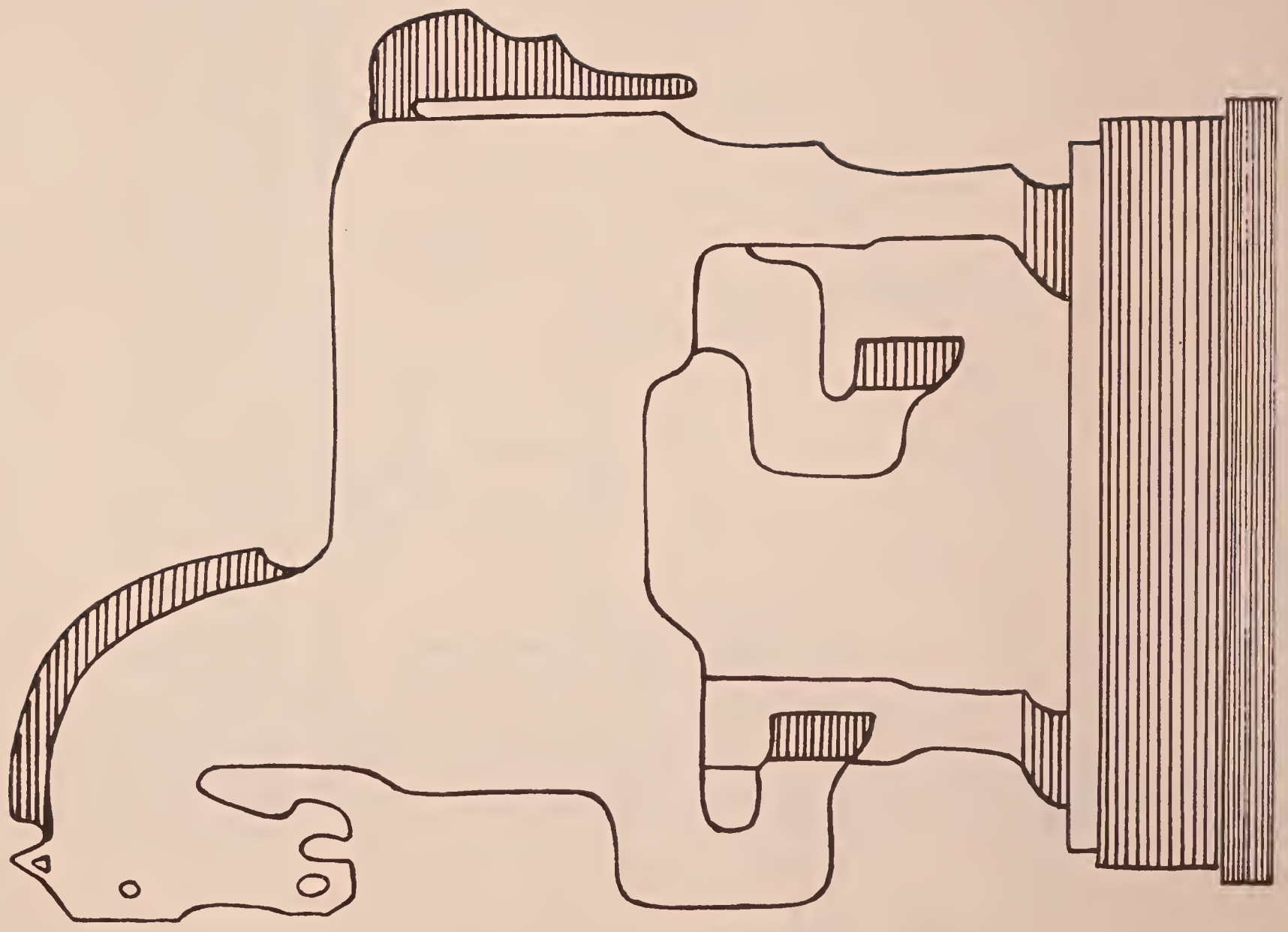


Plate 4. Horse.

TIGER

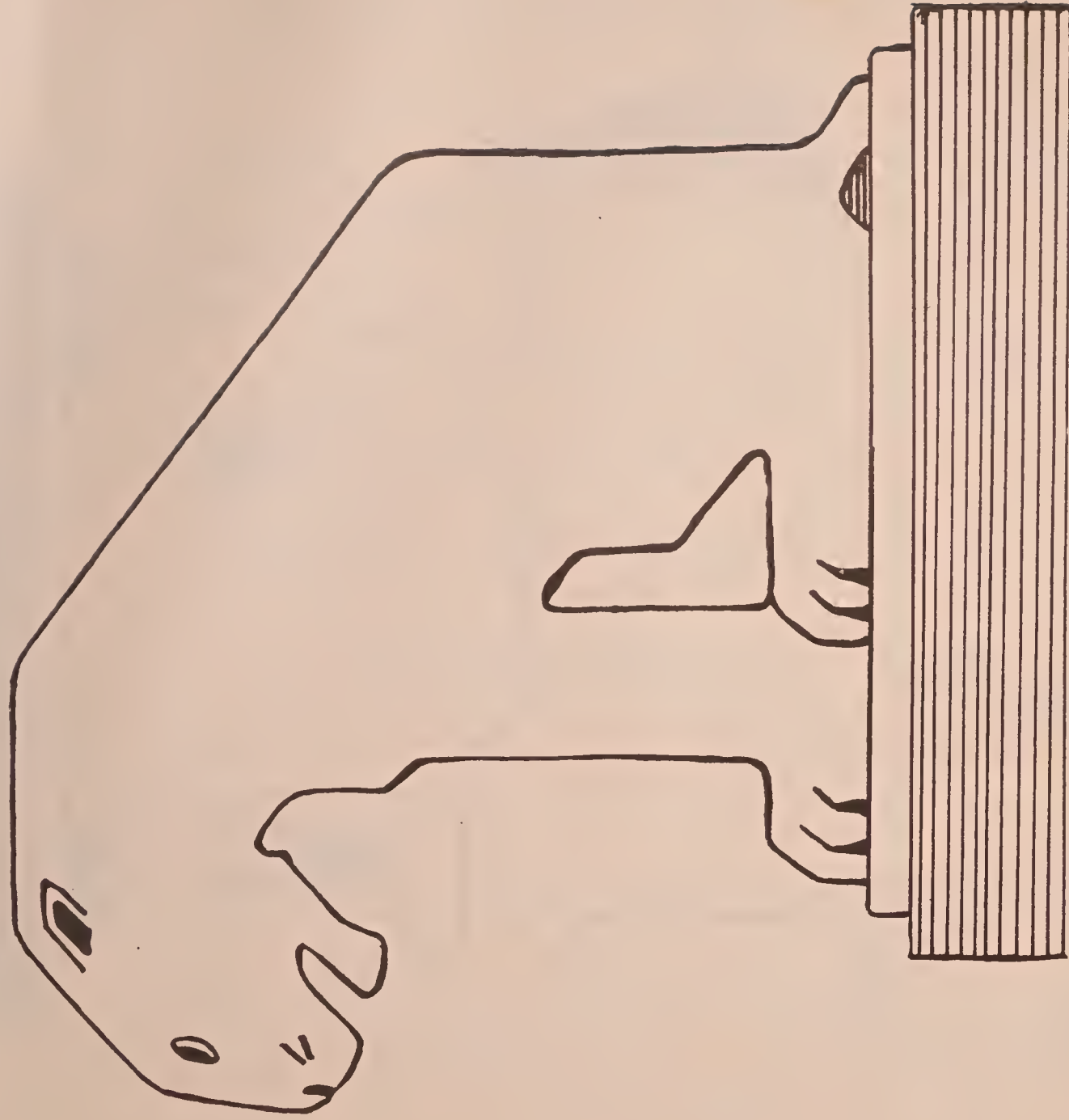


Plate 5. Tiger.

TIGER



Plate 6. Tiger.

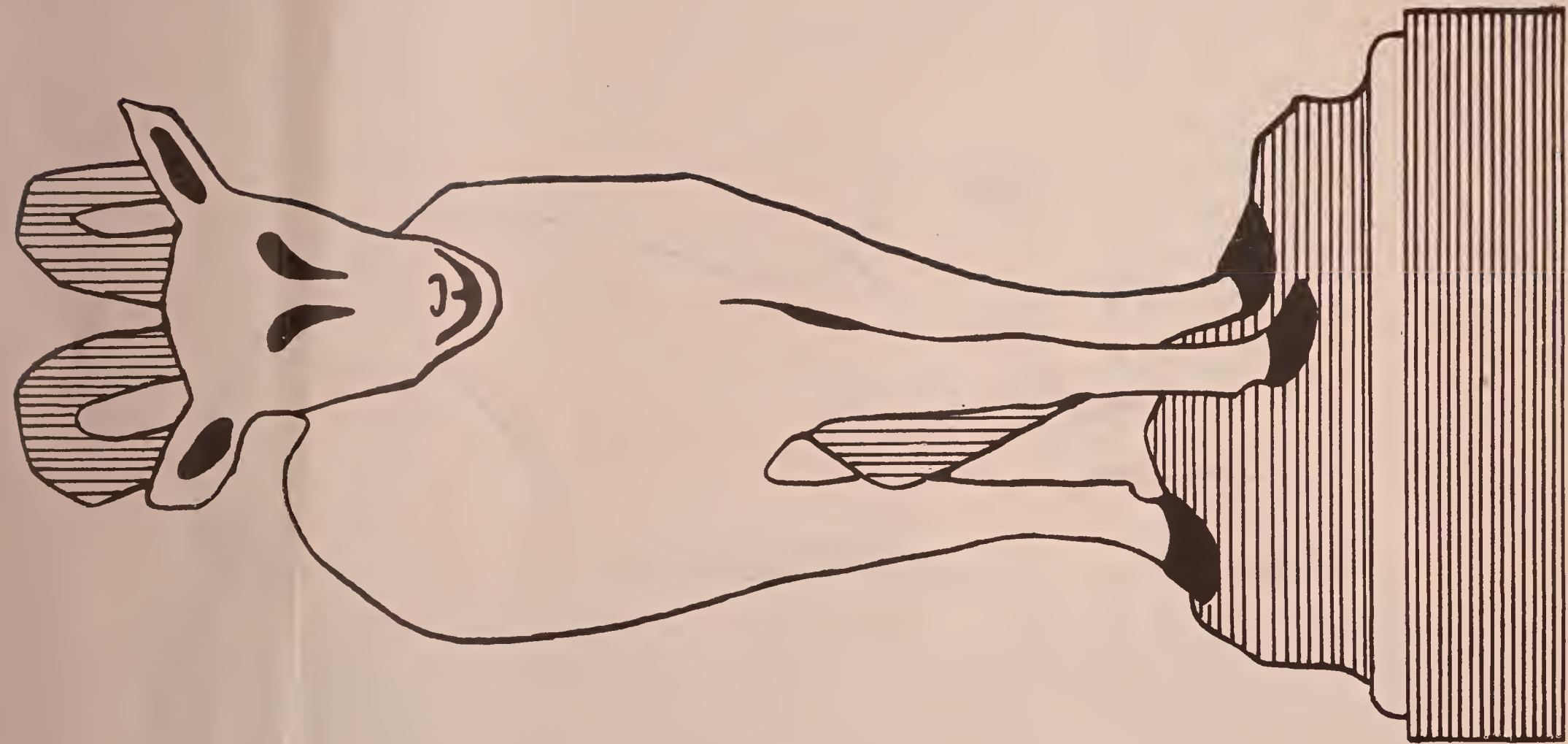


Plate 7. Mountain Goat (Front View).

PAPER WEIGHT
THREE QUARTER VIEW
THREE TONES

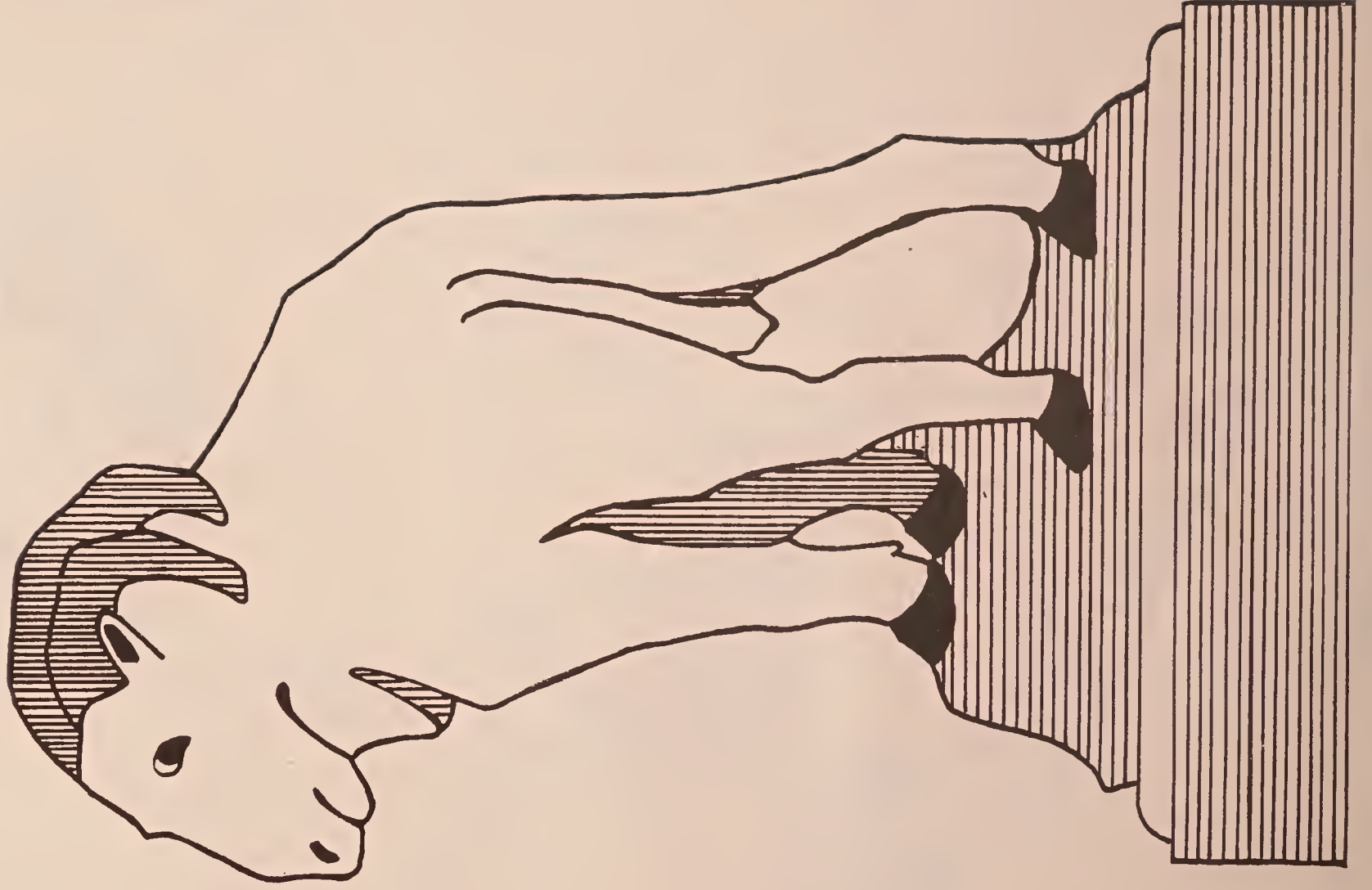


Plate 8. Mountain Goat.

DOG

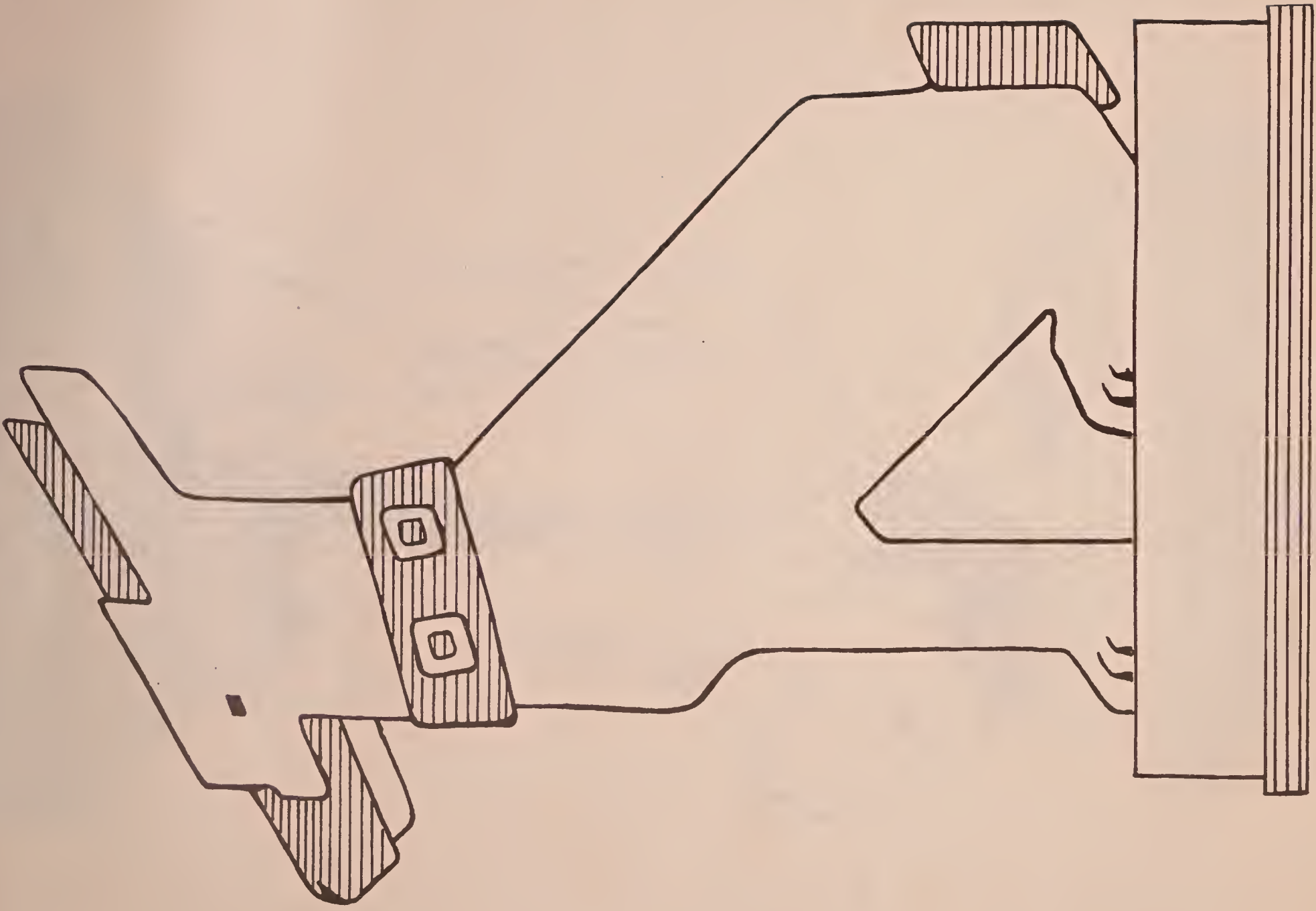


Plate 9. Dog.

CLOWN
AND CHICKEN

FRONT VIEW
OF CLOWN

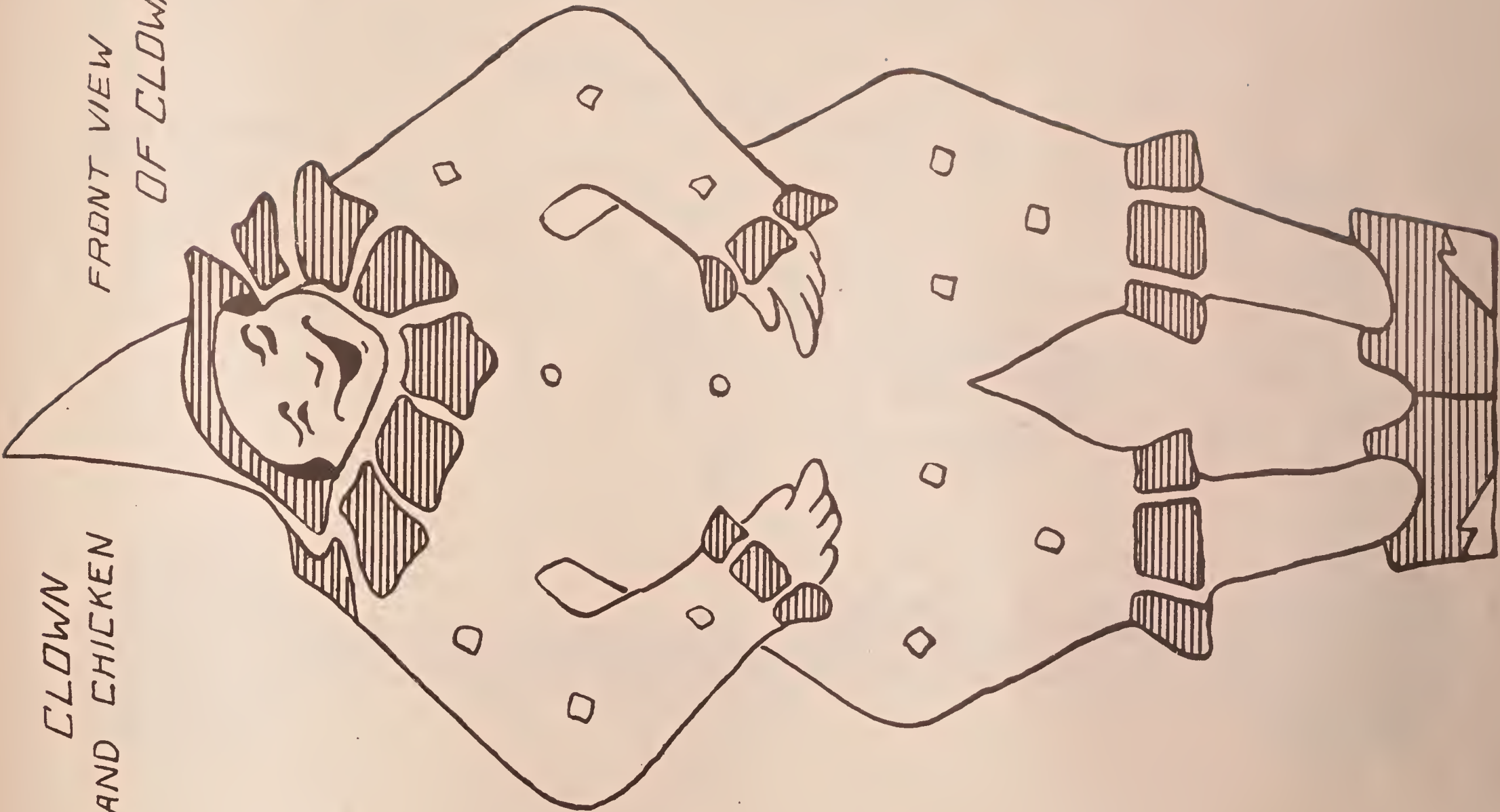


Plate 10. Clown.

CLOWN AND CHICKEN

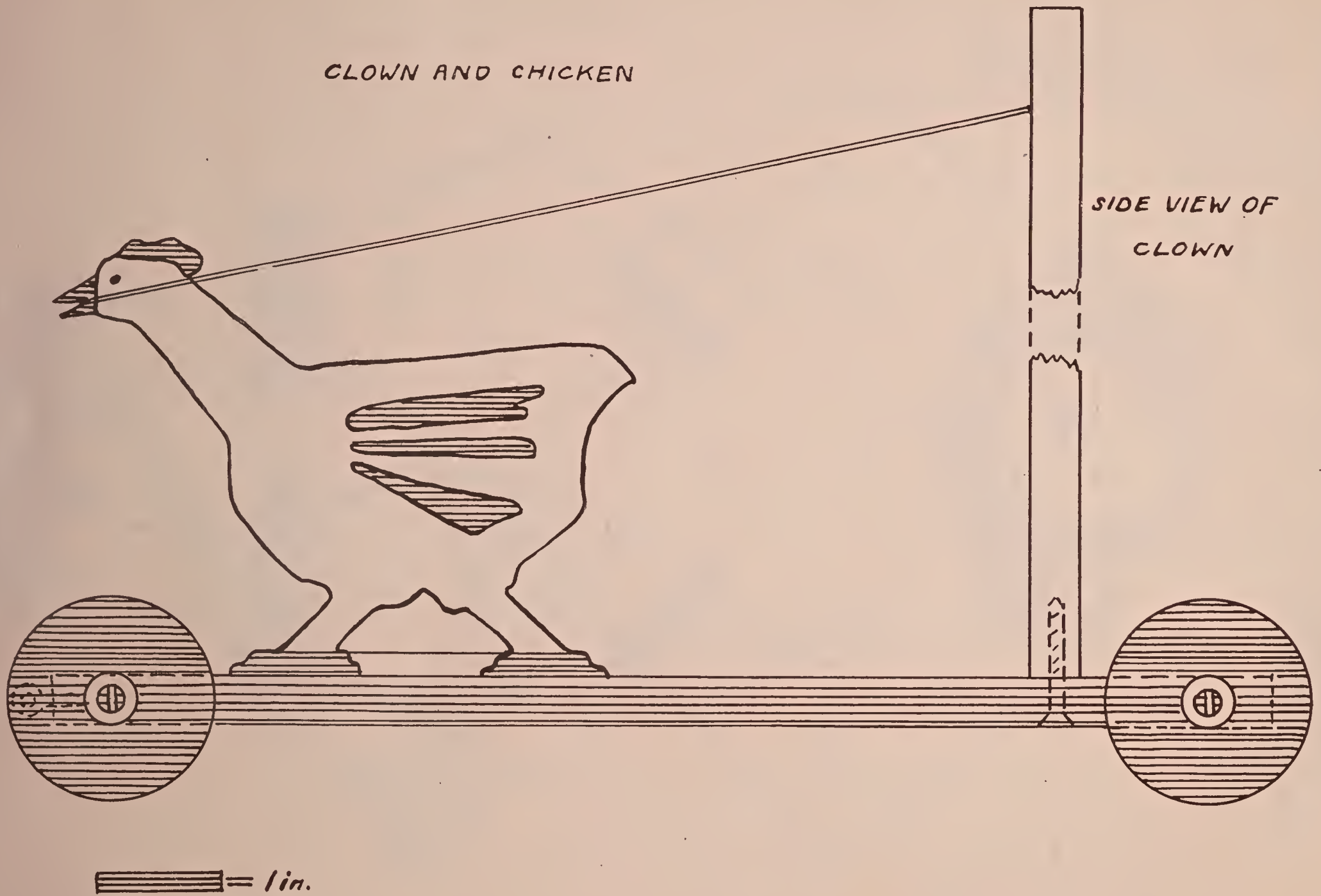


Plate 11. Assembly of Clown and Chicken on Wheels.

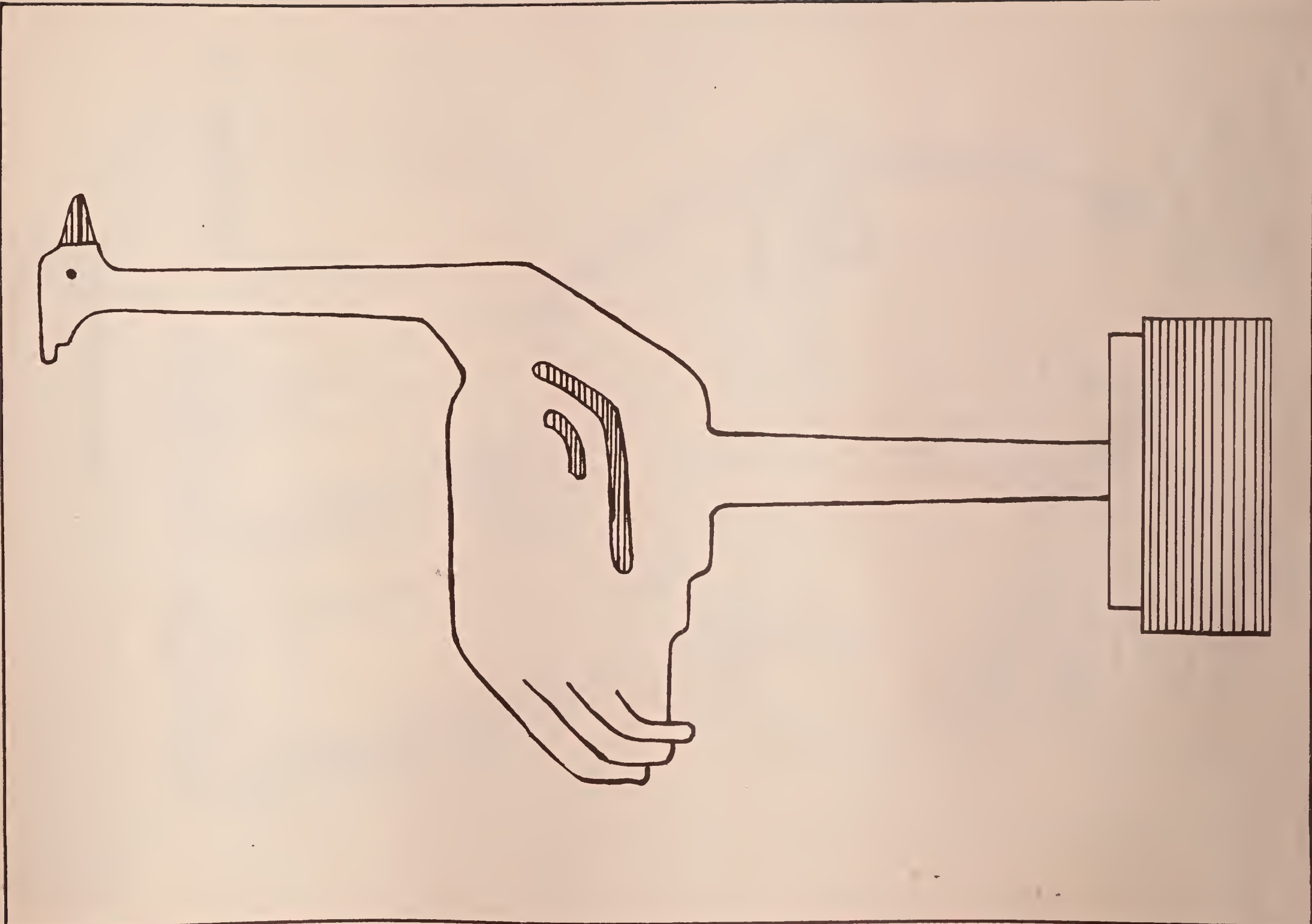


Plate 12 Ostrich.

BOW MADE OF NO 4 REED.
BORE HOLE THRU
HAND AND INSERT BOW
TIE STRING TO IT.

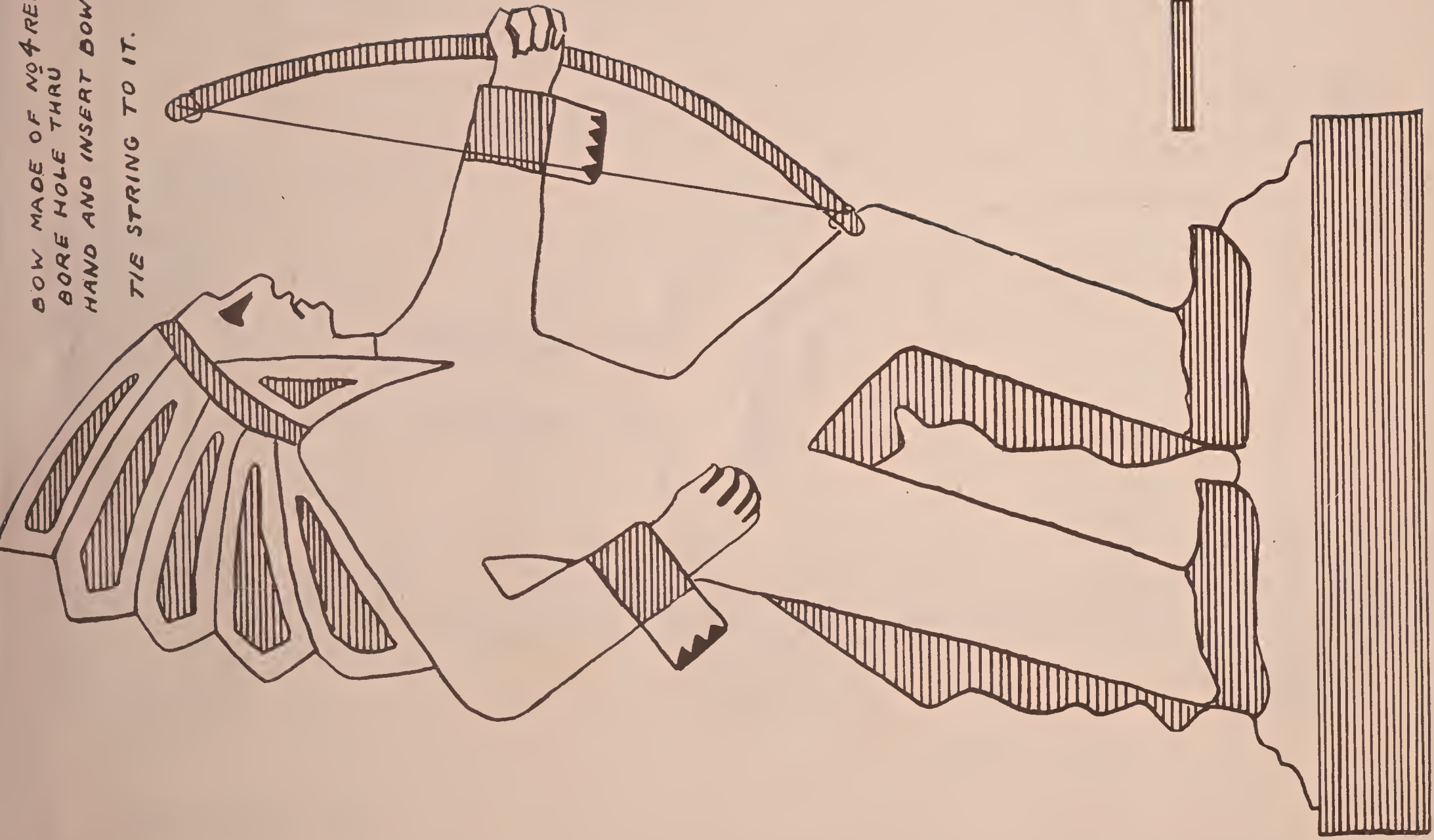
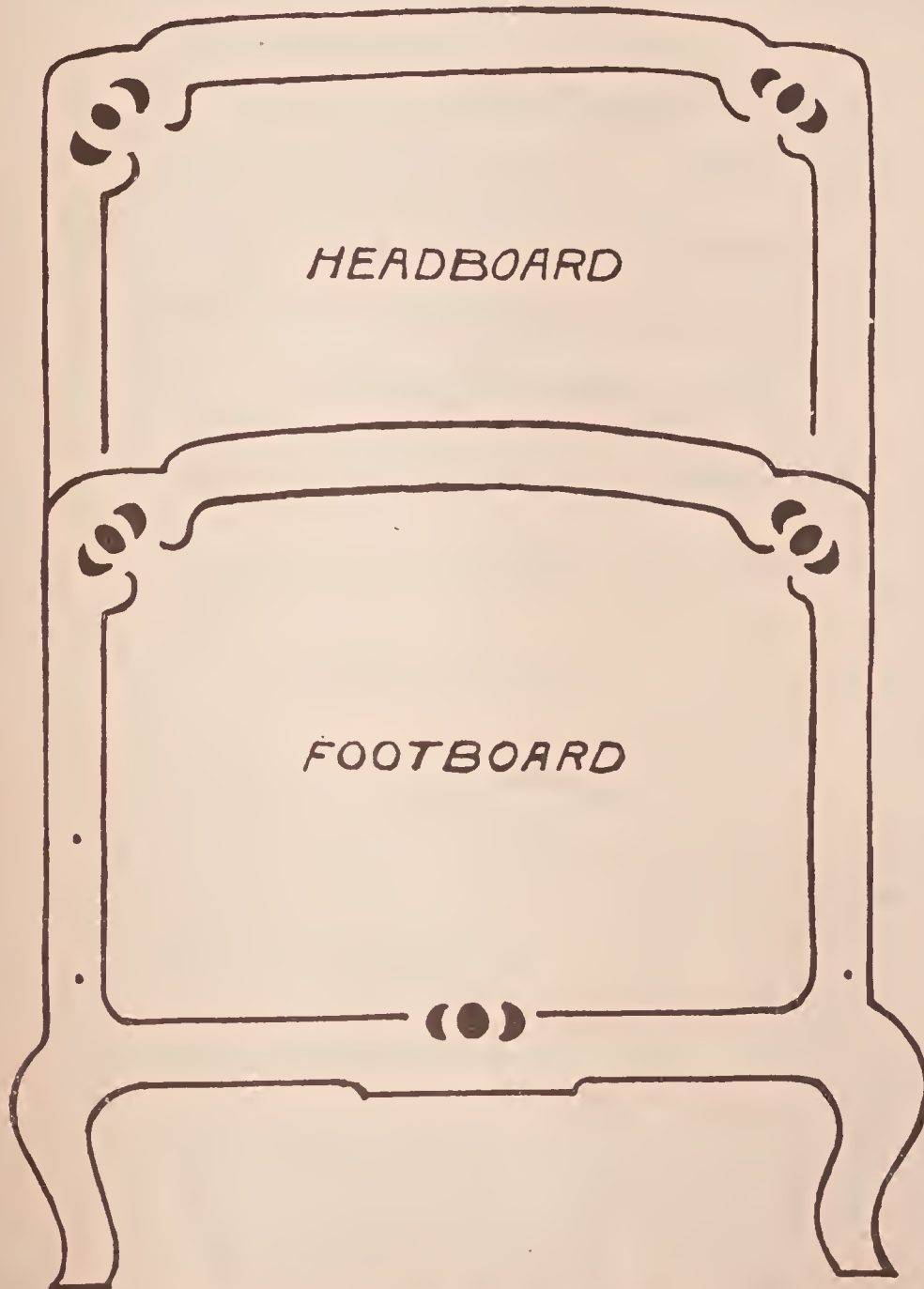


Plate 13. Indian.

TOY FURNITURE

BED



SPECIFICATION

MAKE TWO RAIL PIECES

MAKE ONE BOTTOM PIECE

$\frac{1}{4}$ " STOCK - SOFT WOOD

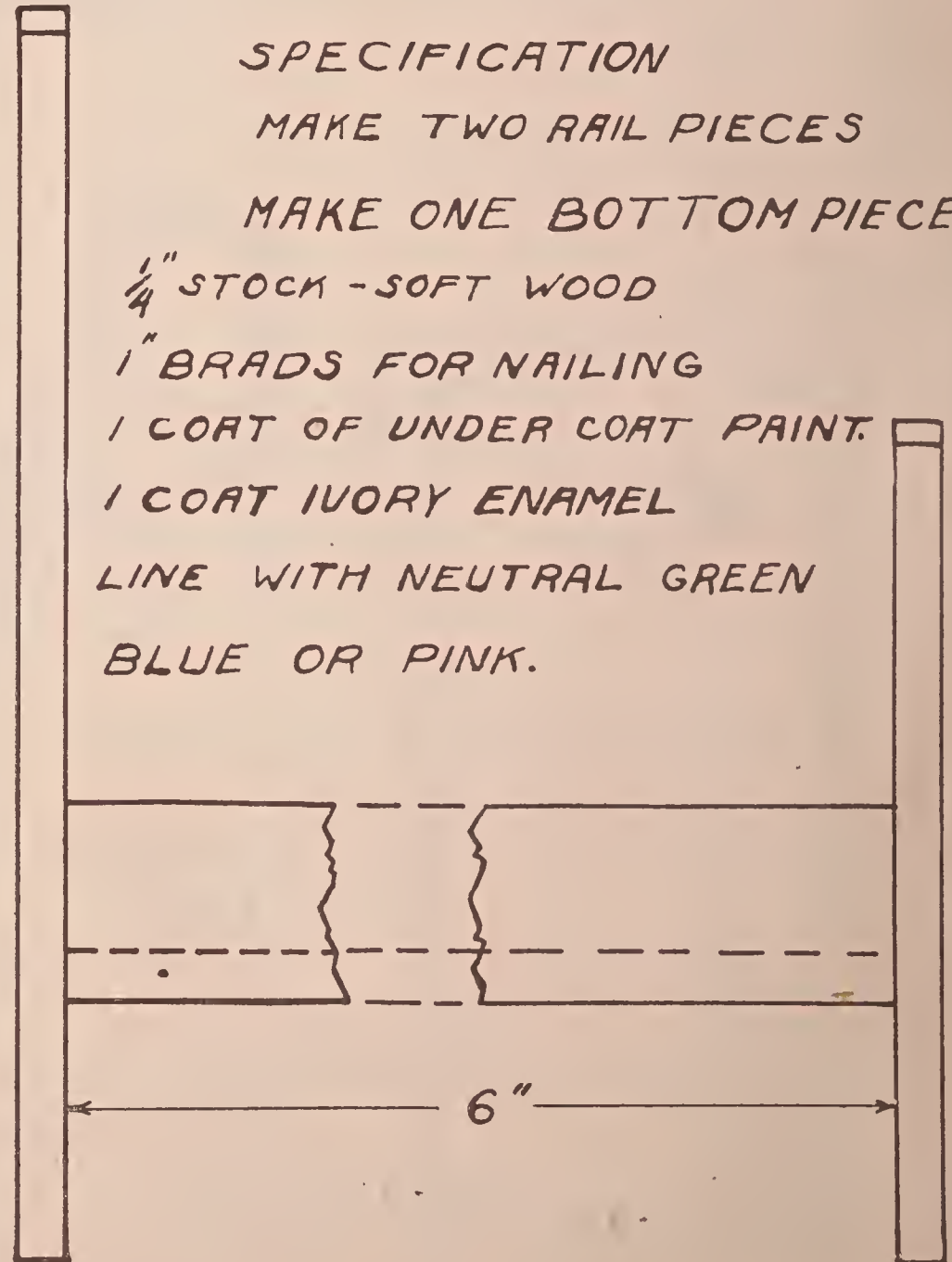
1" BRADS FOR NAILING

1 COAT OF UNDER COAT PAINT.

1 COAT IVORY ENAMEL

LINE WITH NEUTRAL GREEN

BLUE OR PINK.



TOY FURNITURE SET
CHAIR

SPECIFICATION

$\frac{1}{4}$ " STOCK - SOFT WOOD

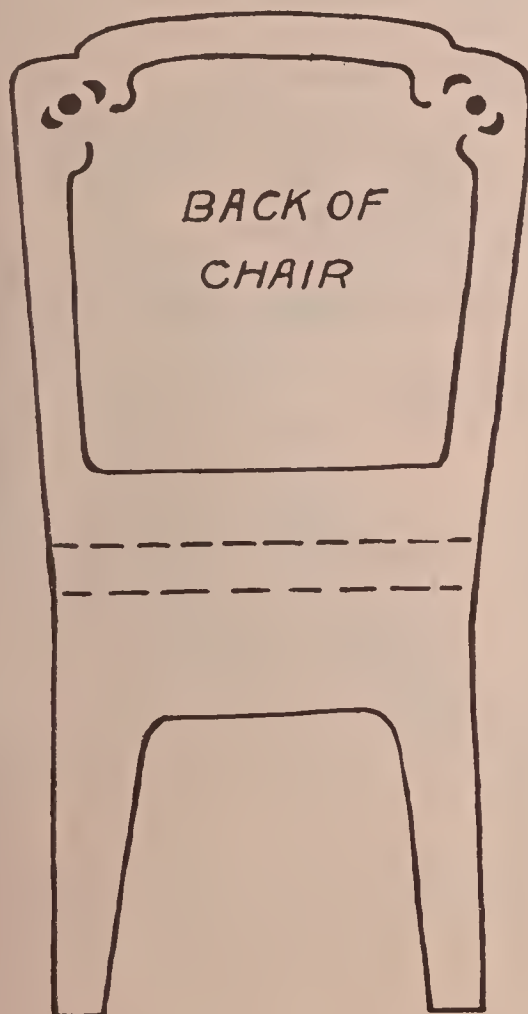
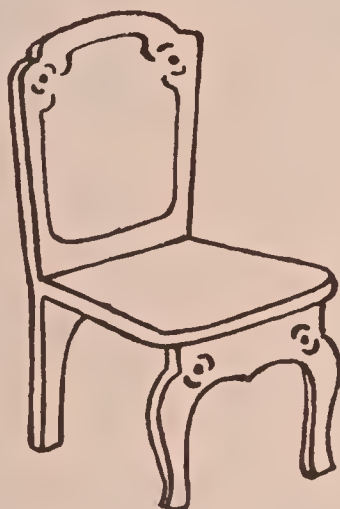
$\frac{3}{4}$ " BRADS FOR NAILING

1 COAT OF UNDERCOAT PAINT

1 COAT IVORY ENAMEL

LINE WITH NEUTRAL GREEN,

BLUE OR PINK



TOY FURNITURE ROCKER

- SPECIFICATION -

$\frac{1}{4}$ " STOCK - SOFT WOOD.

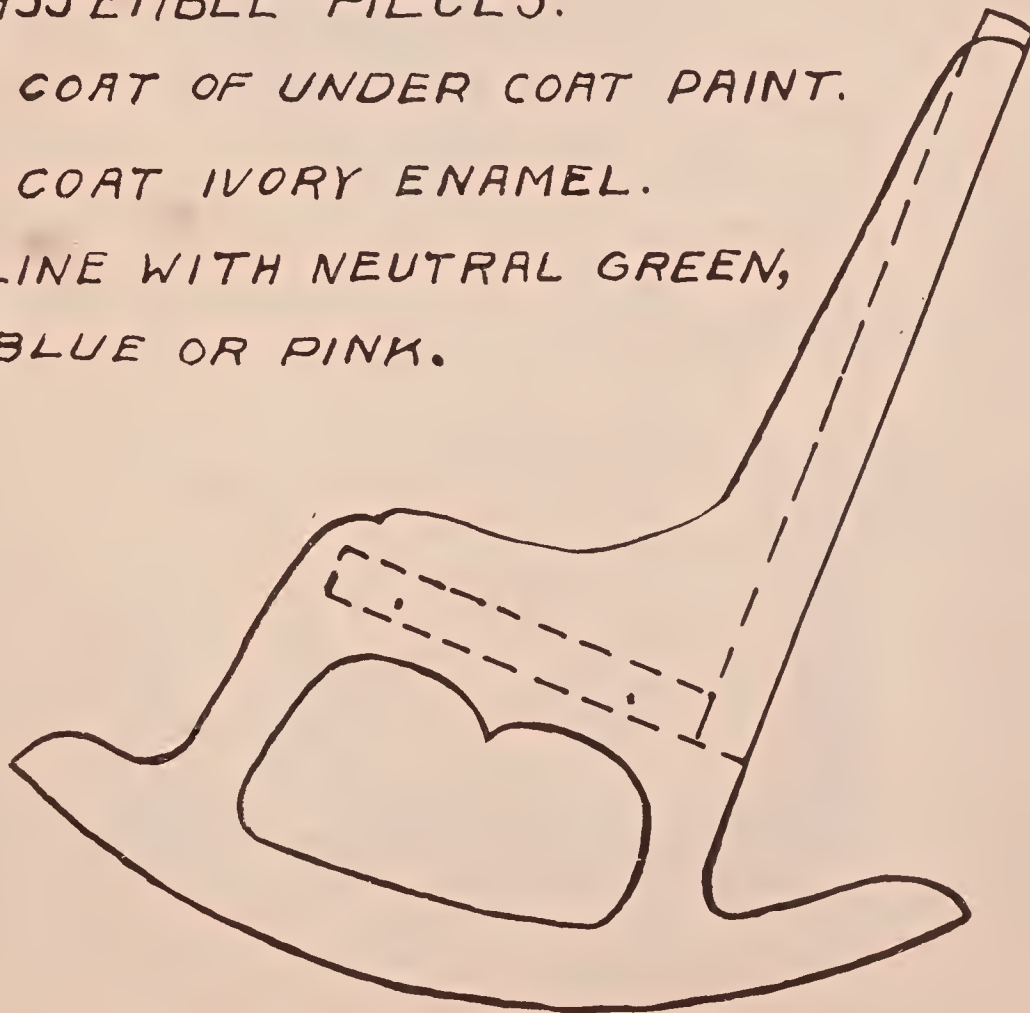
$\frac{3}{4}$ " BRADS.

ASSEMBLE PIECES.

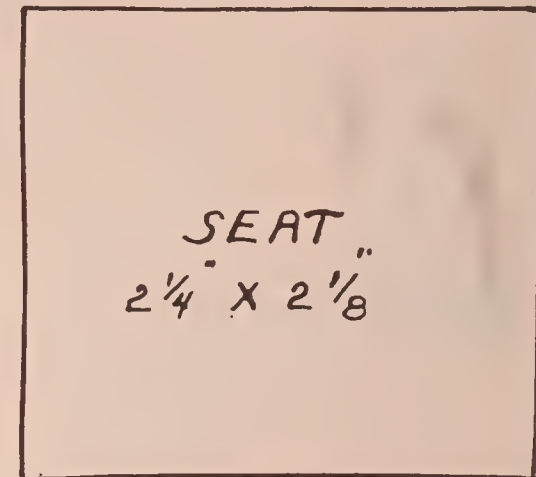
1 COAT OF UNDER COAT PAINT.

1 COAT IVORY ENAMEL.

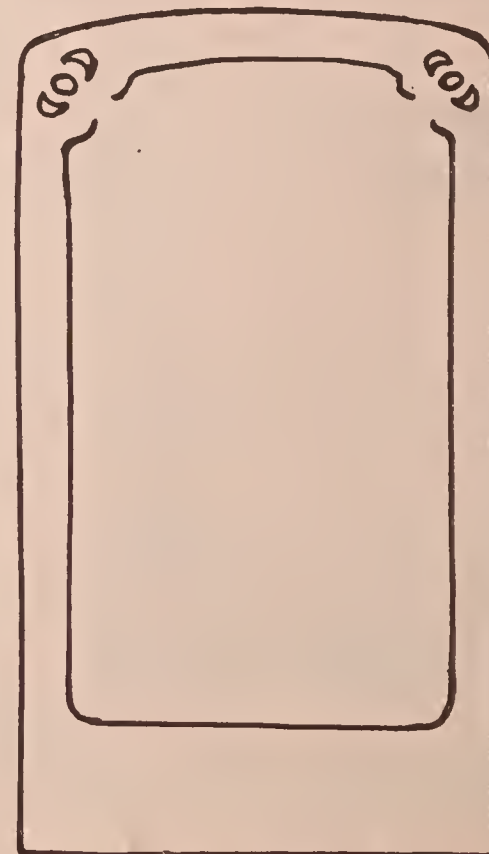
LINE WITH NEUTRAL GREEN,
BLUE OR PINK.



SIDE OF ROCKER
MAKE TWO OF THIS



SEAT
 $2\frac{1}{4}$ X $2\frac{1}{8}$



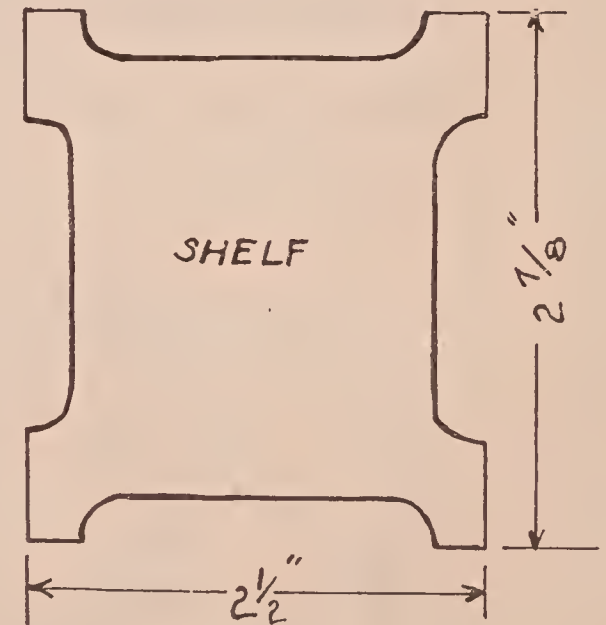
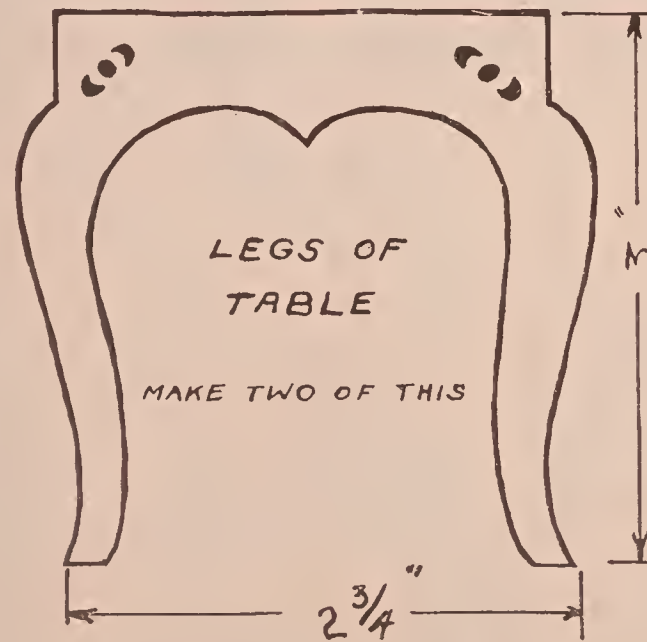
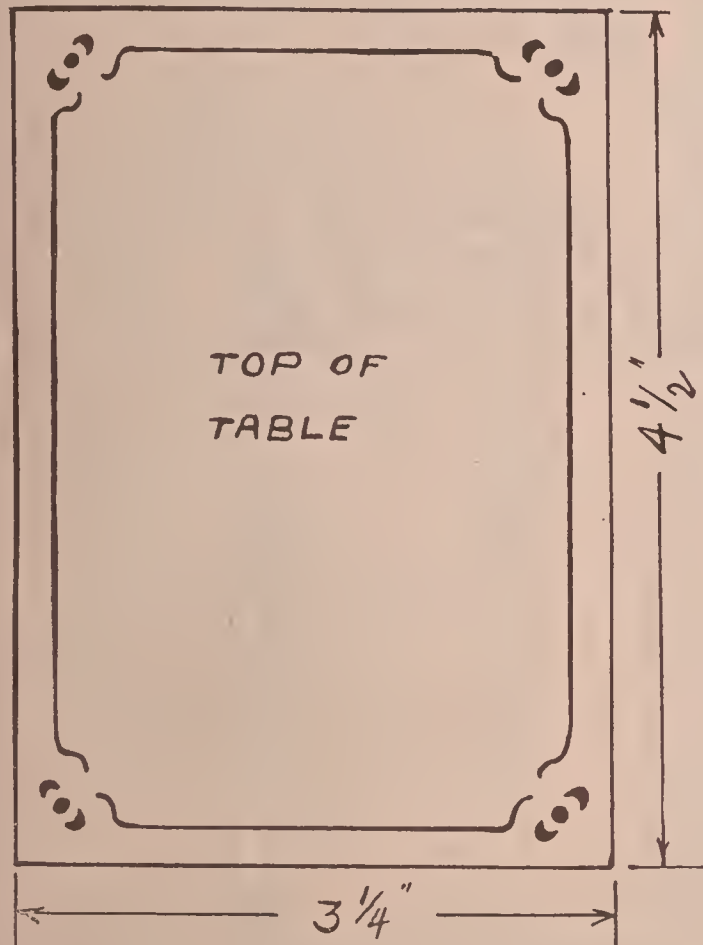
BACK OF ROCKER.

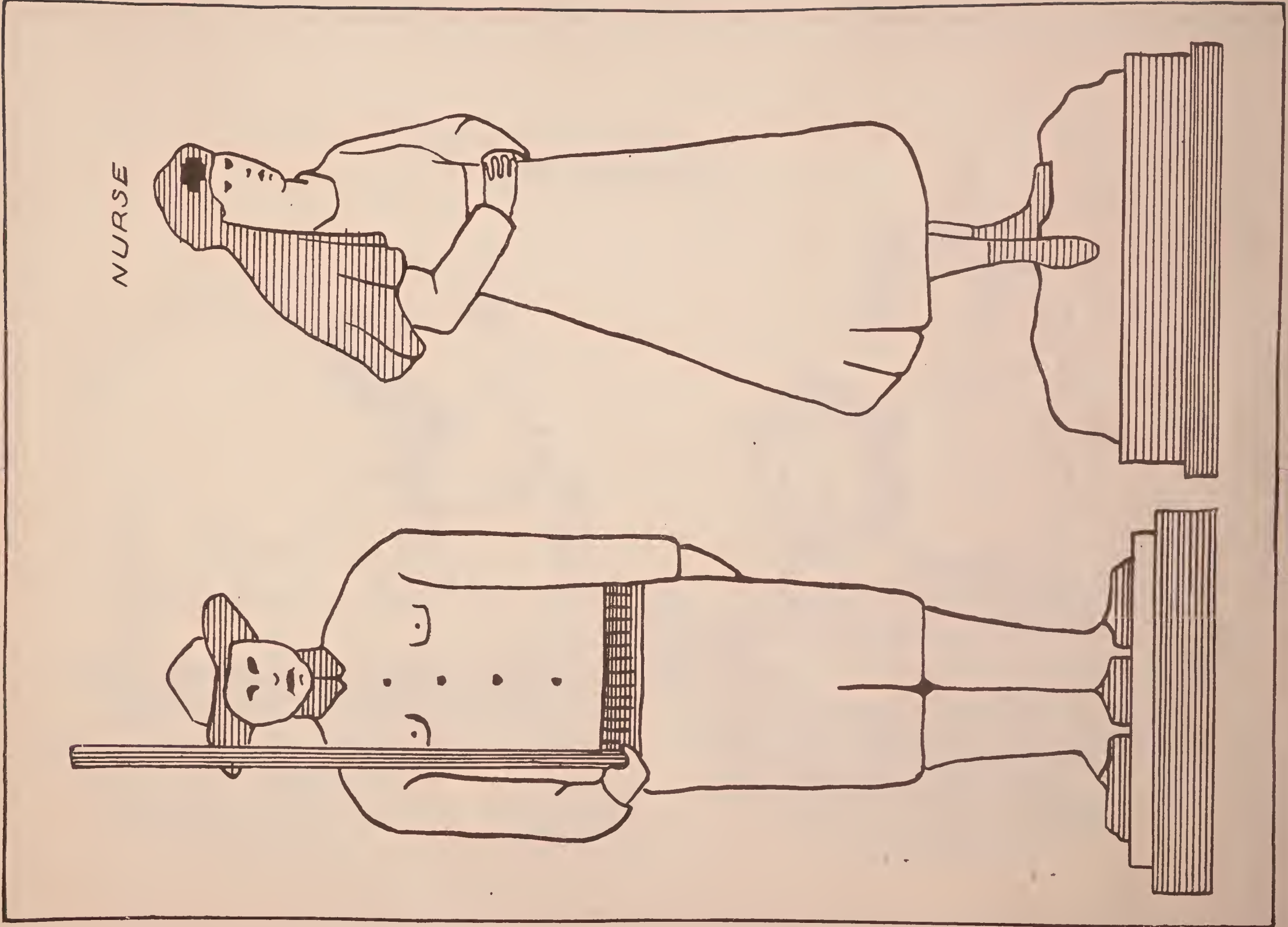
TOY FURNITURE SET
TABLE

SPECIFICATION

$\frac{1}{4}$ " STOCK - SOFT WOOD

1 COAT OF UNDERCOAT PAINT
1 COAT IVORY ENAMEL
LINE WITH NEUTRAL GREEN
BLUE OR PINK.





NURSE

Plate 18. Soldier—Red Cross Nurse.

ROCKING TOYS

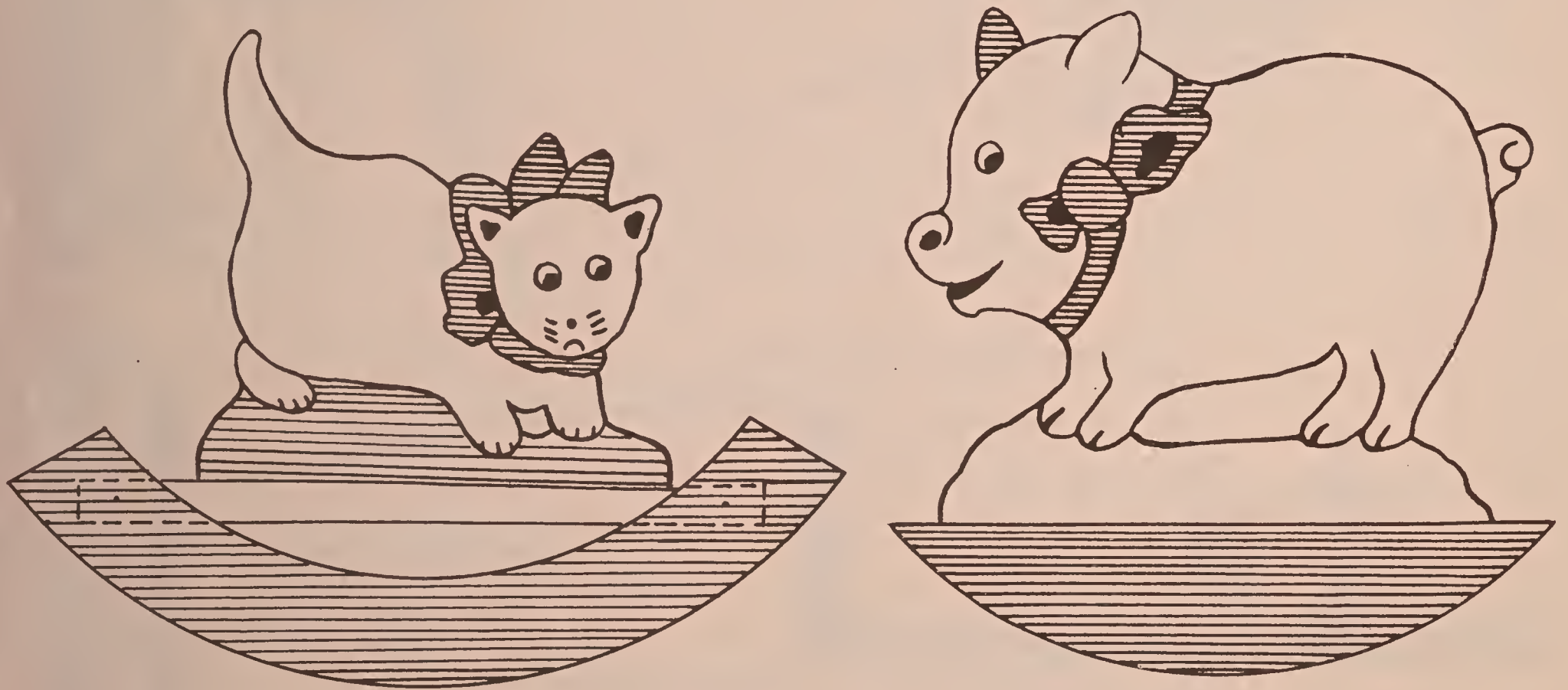


Plate 19. Rocking Cat and Pig.

ROCKING TOYS

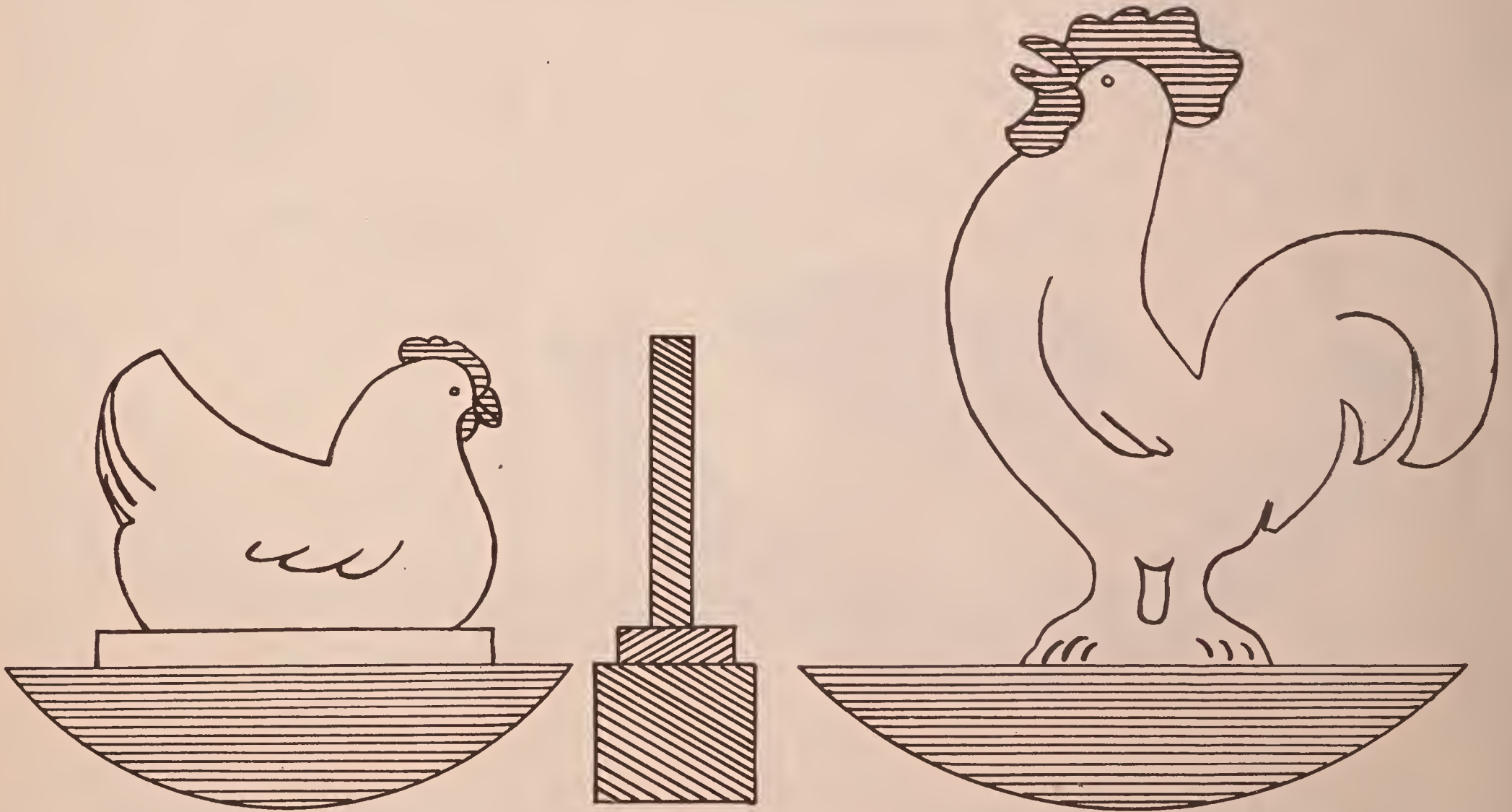
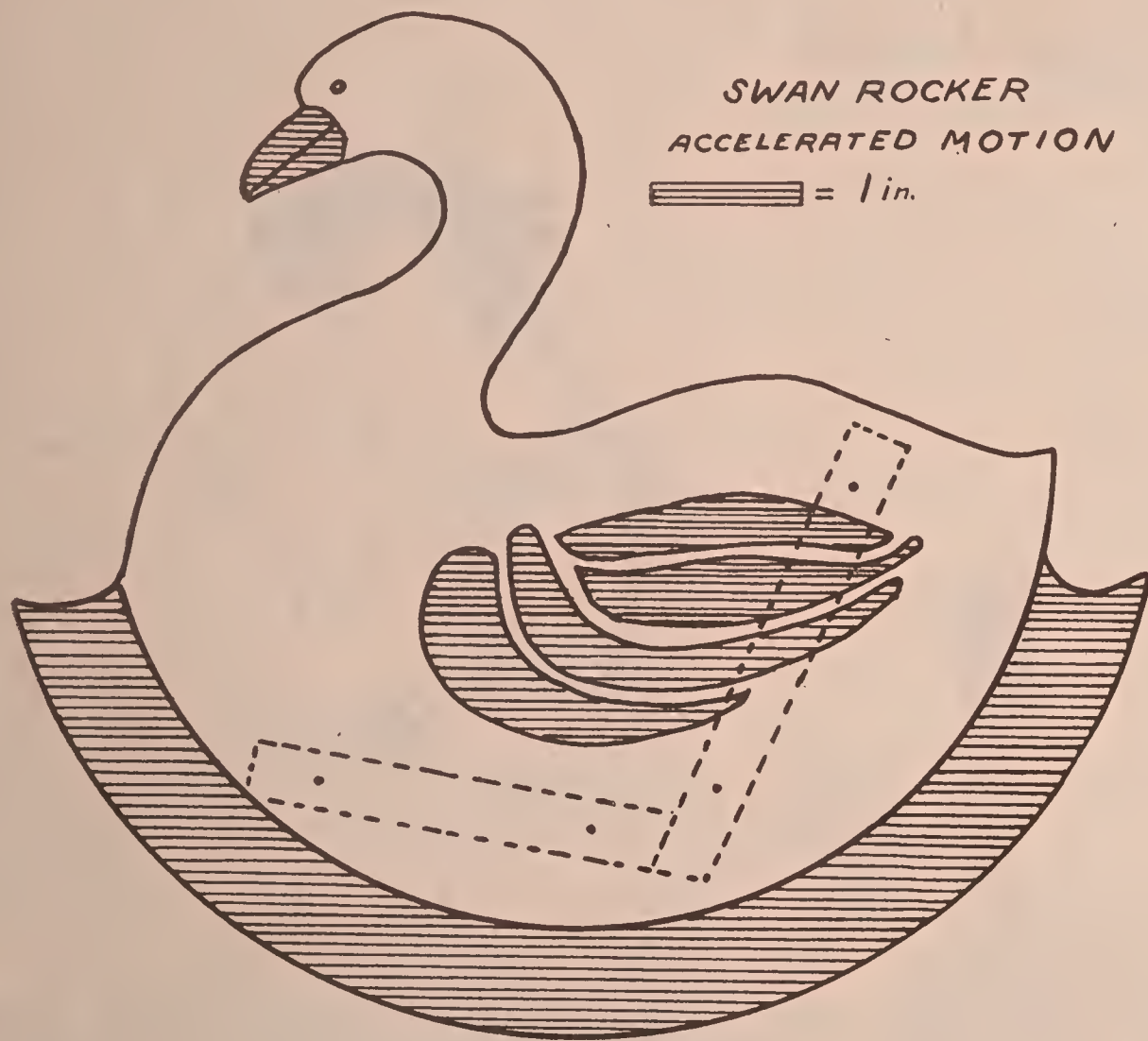
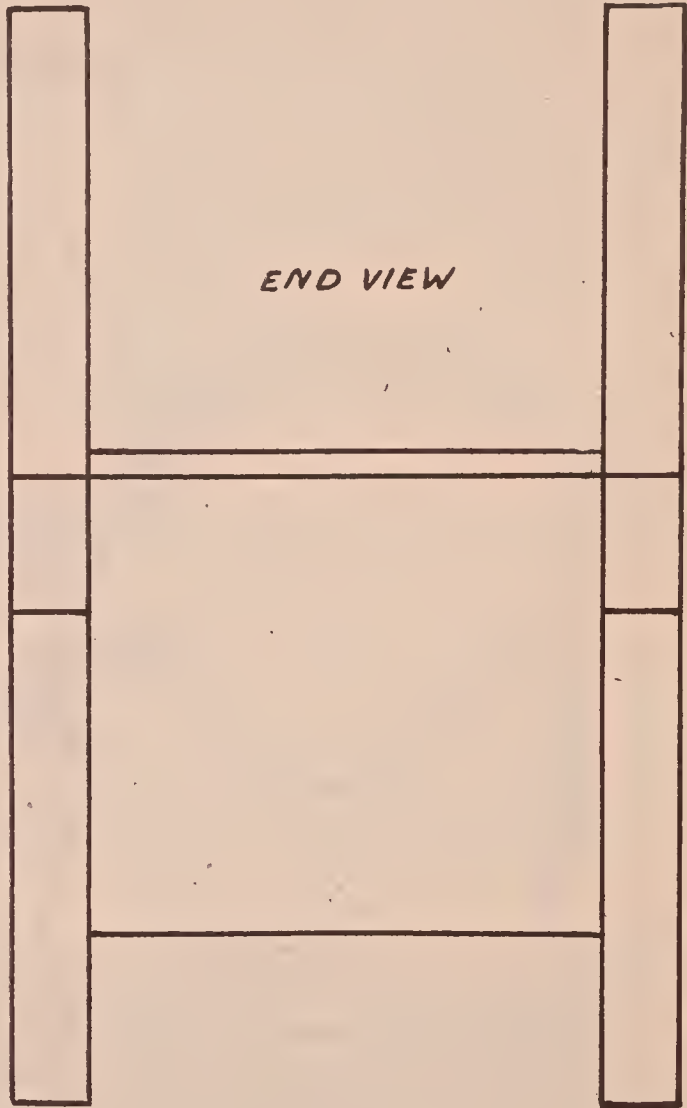


Plate 20. Rocking Hen and Rooster.



SWAN ROCKER
ACCELERATED MOTION

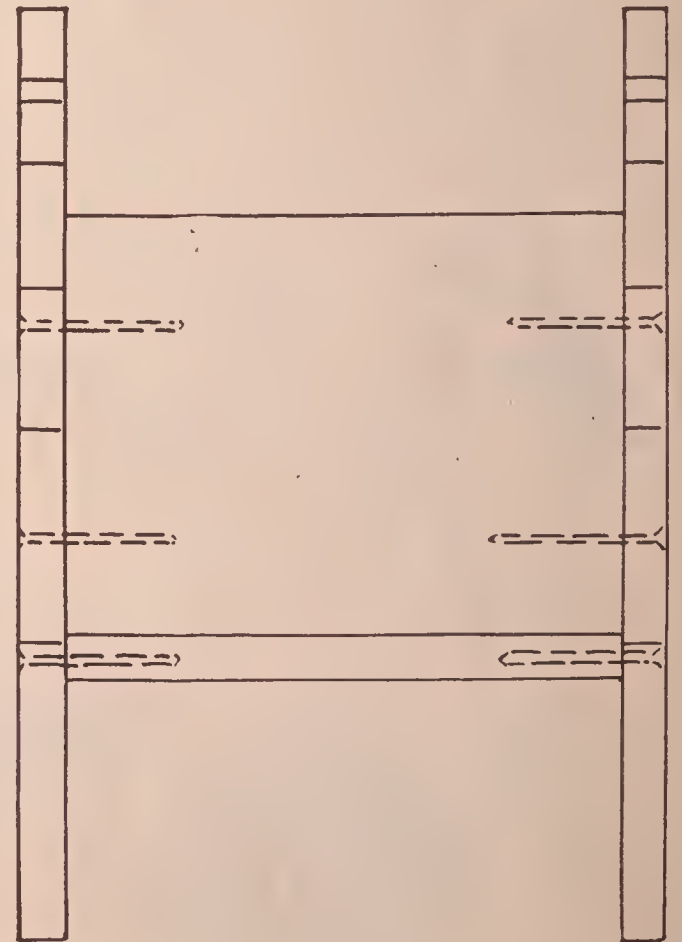
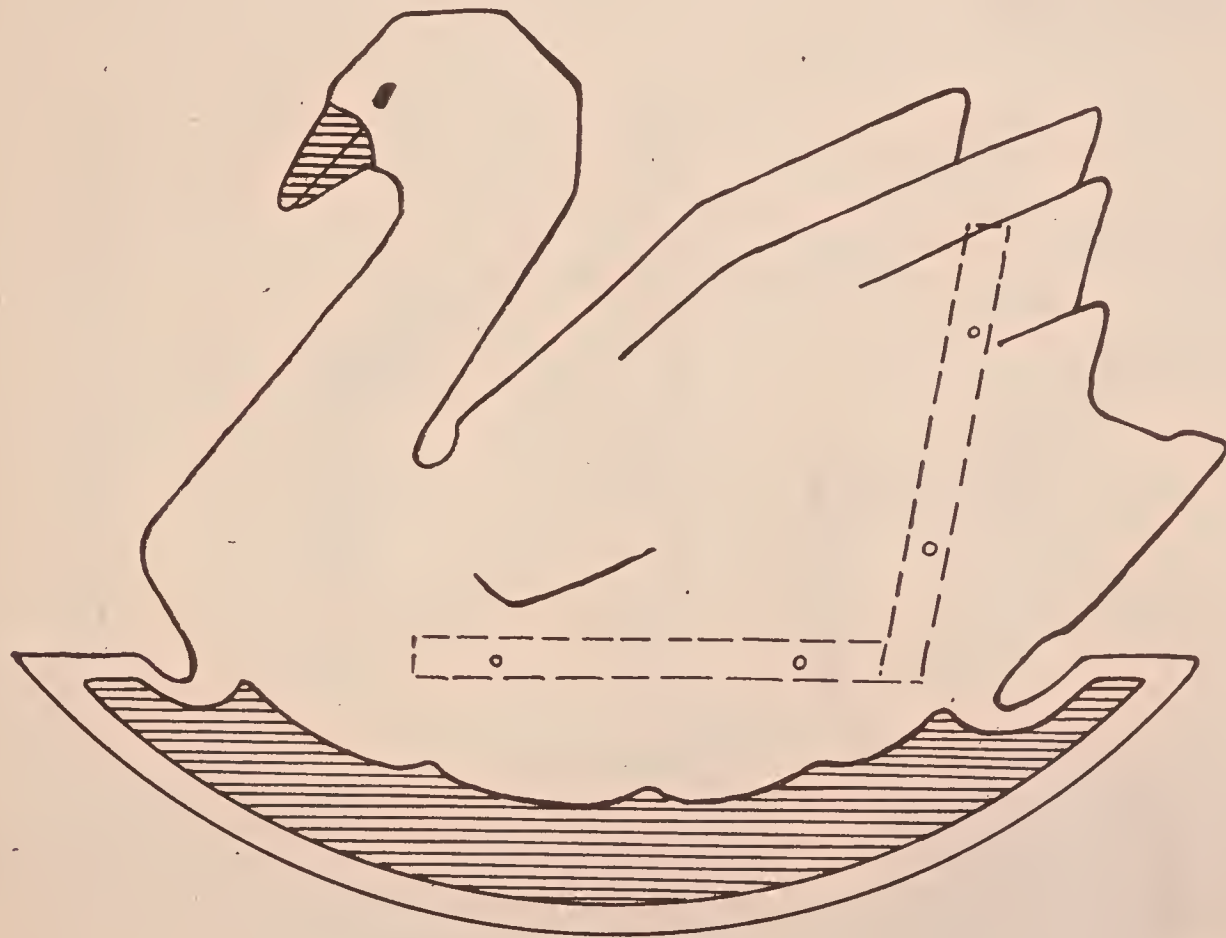
▬▬▬ = 1 in.



END VIEW

Plate 20a. Swan Rocker.

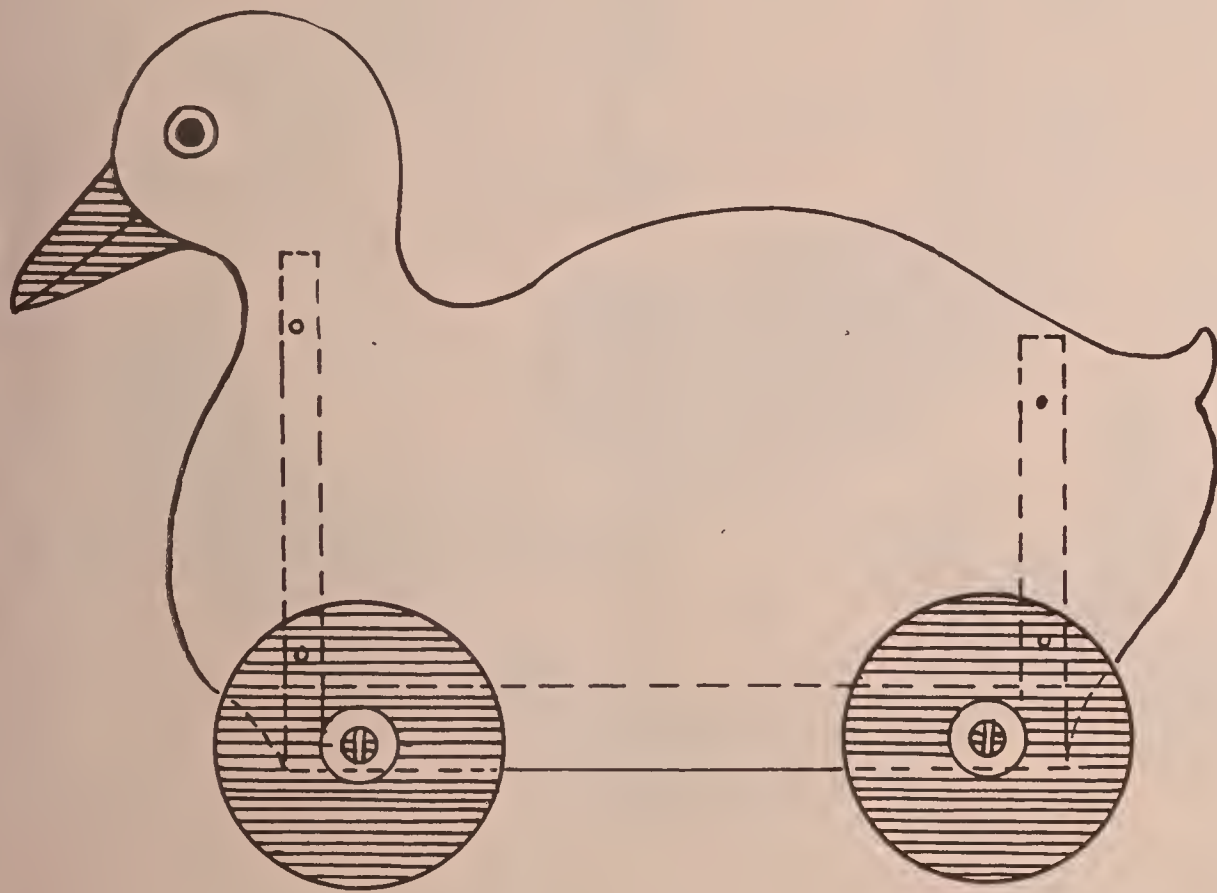
SWAN ROCKER



 = 1 in.

Plate 20b. Swan Rocker.

DUCK CART



— = 1 in.

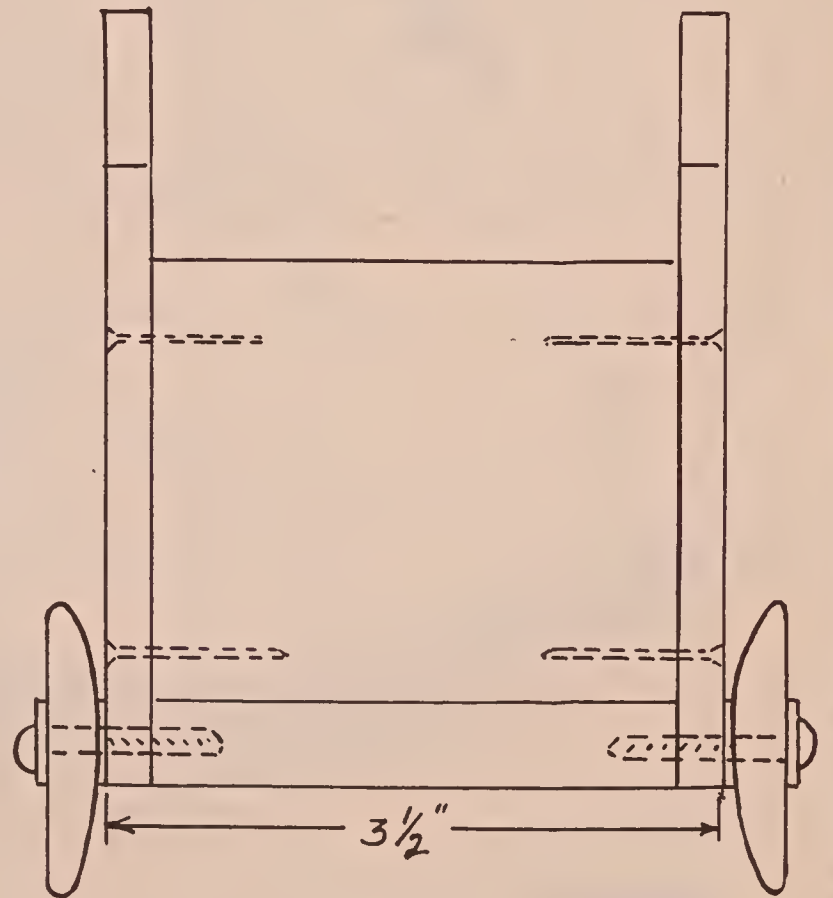
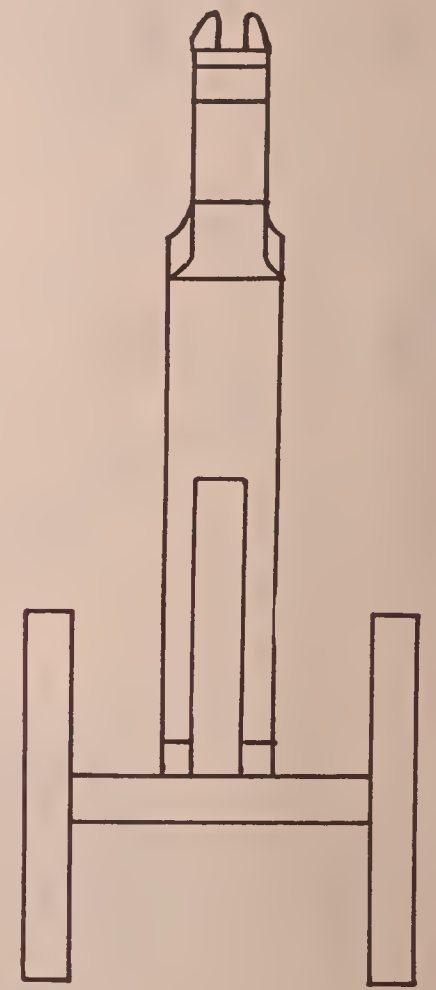
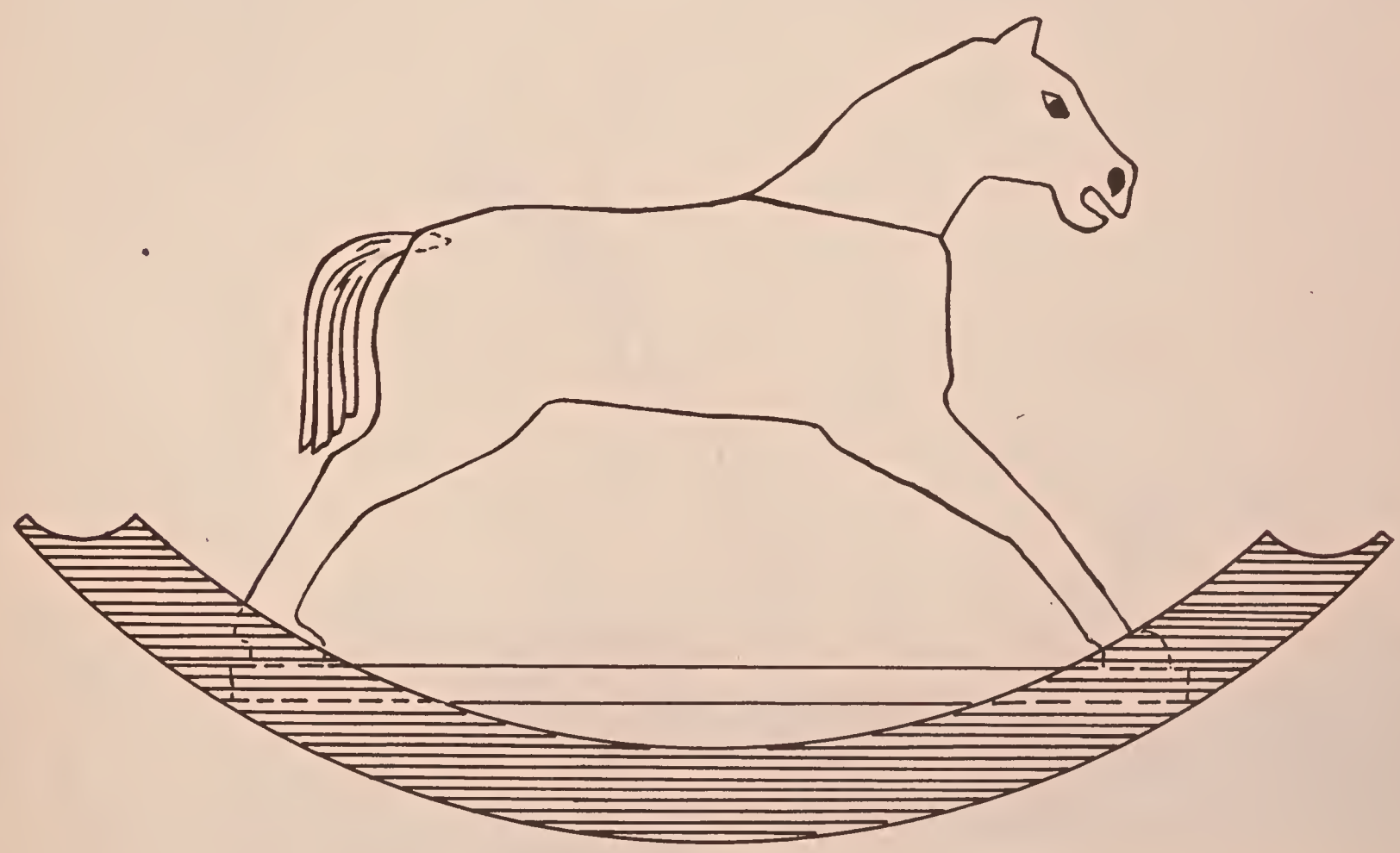


Plate 21. Duck Cart.

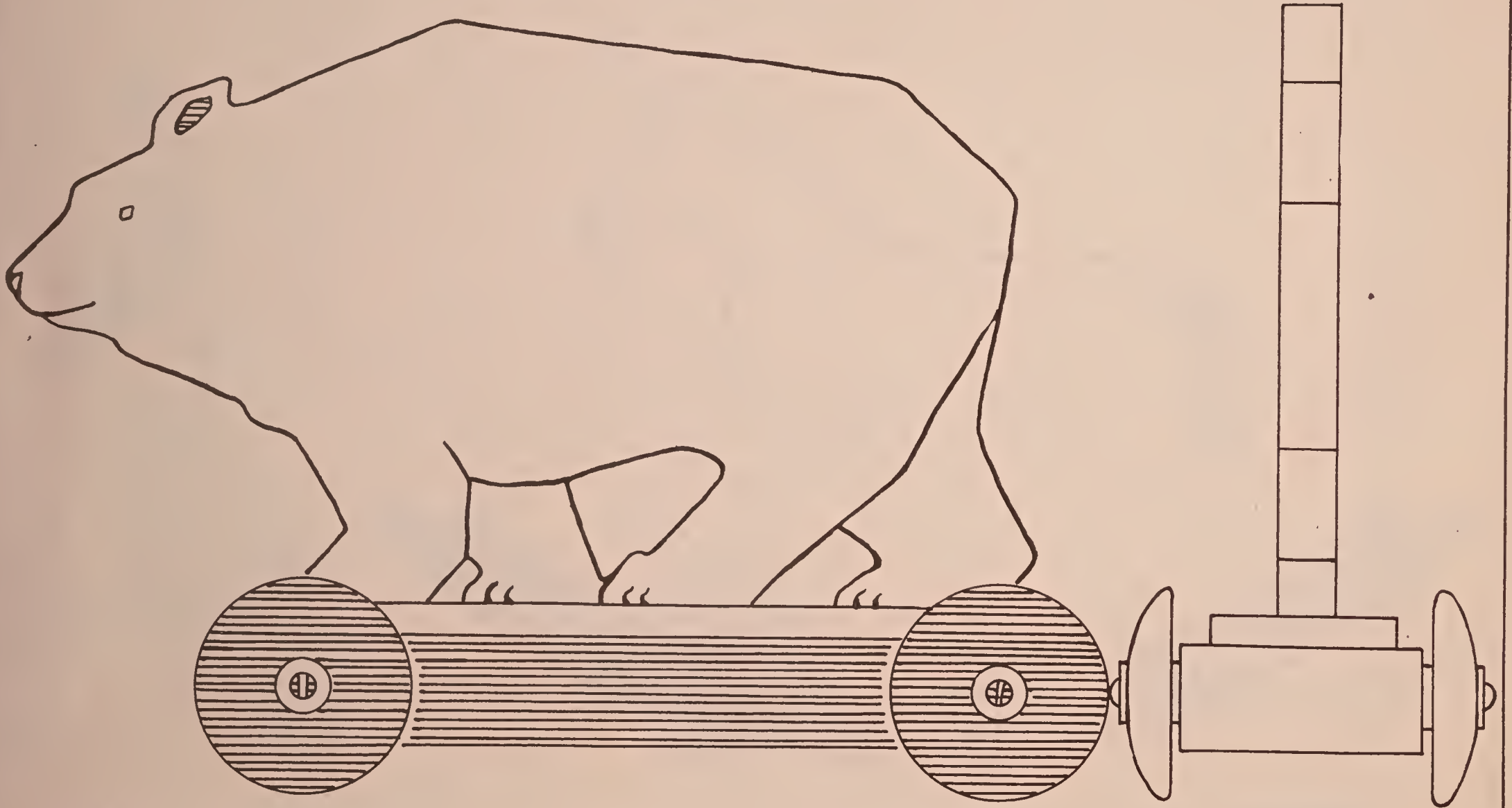
ROCKING HORSE



≡ = 1 in.

Plate 22. Horse.

BEAR ON WHEELS



≡ = 1 in.

Plate 23. Bear.

*ELEPHANT
ON WHEELS*

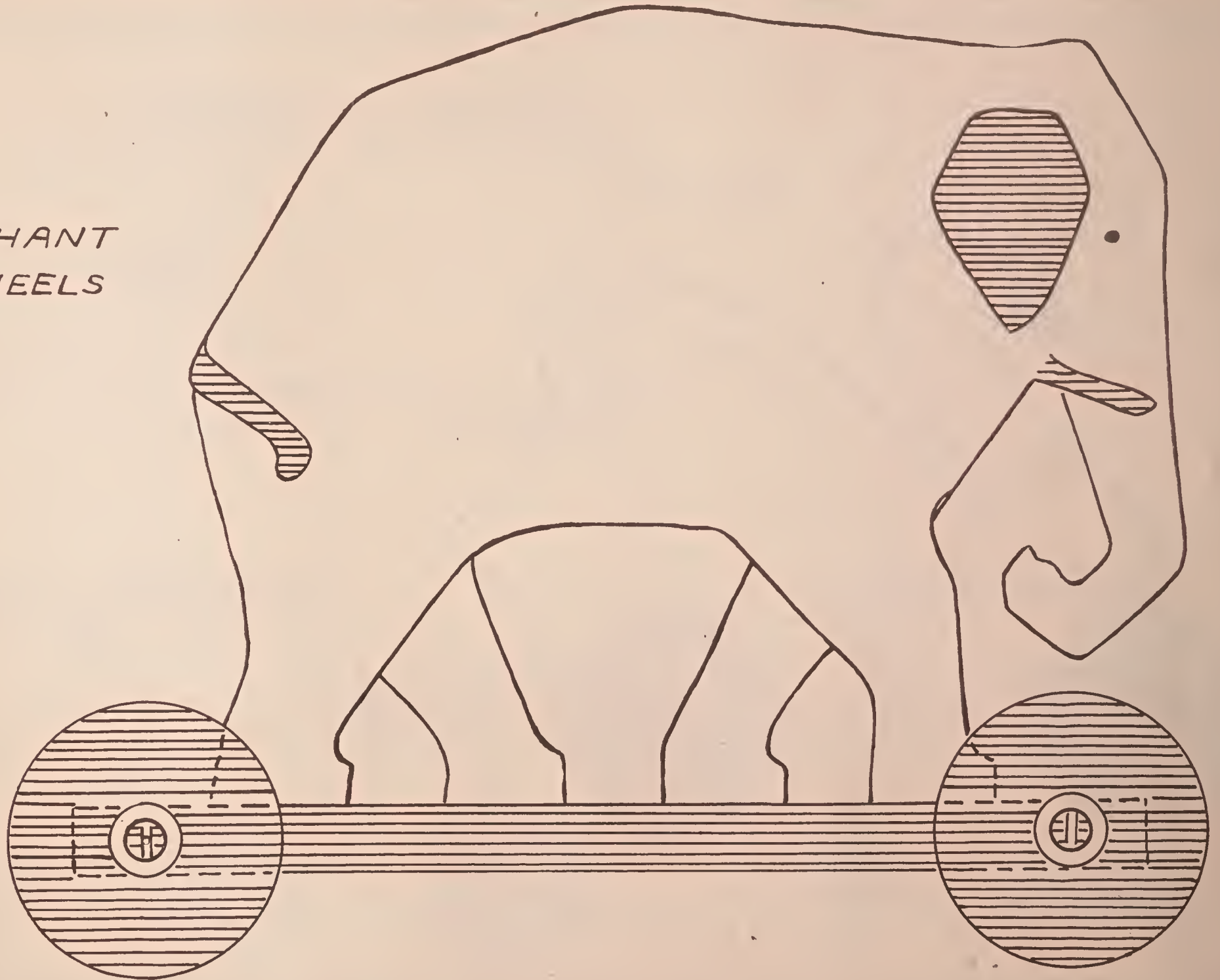
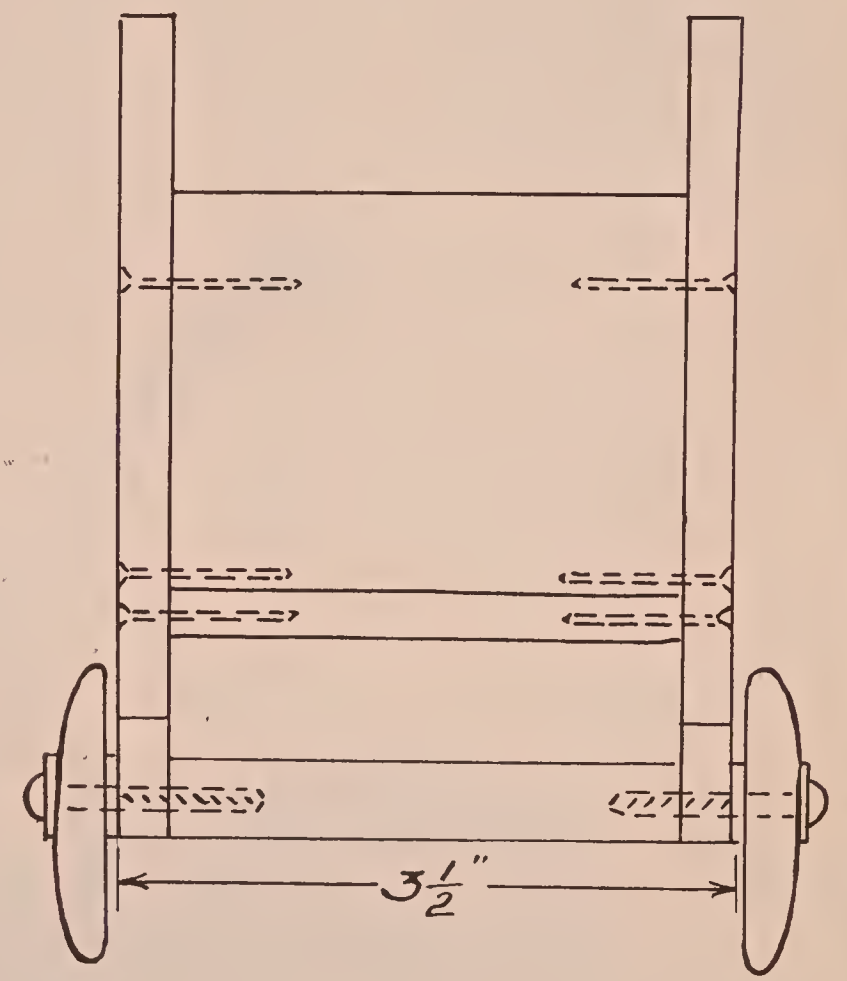
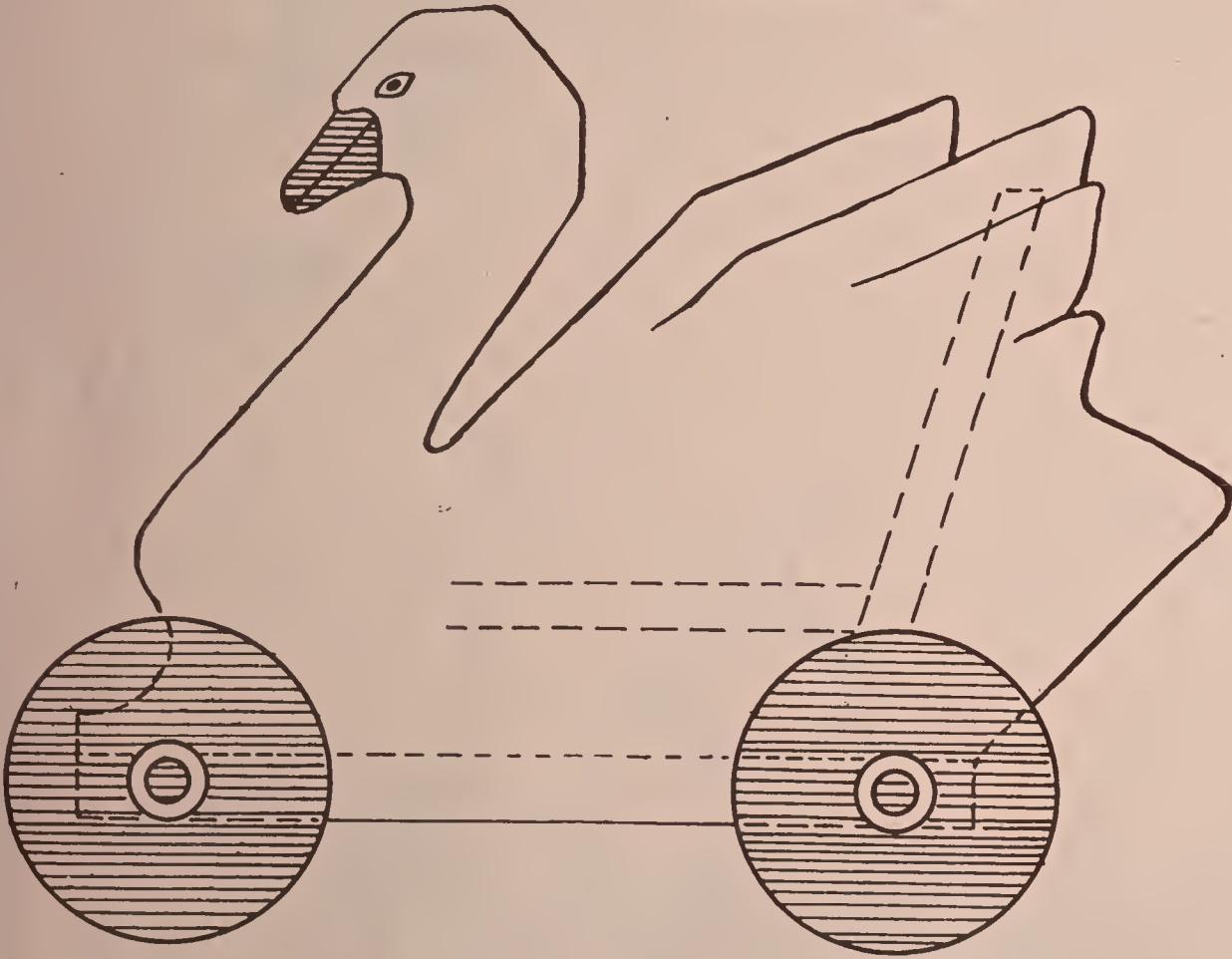


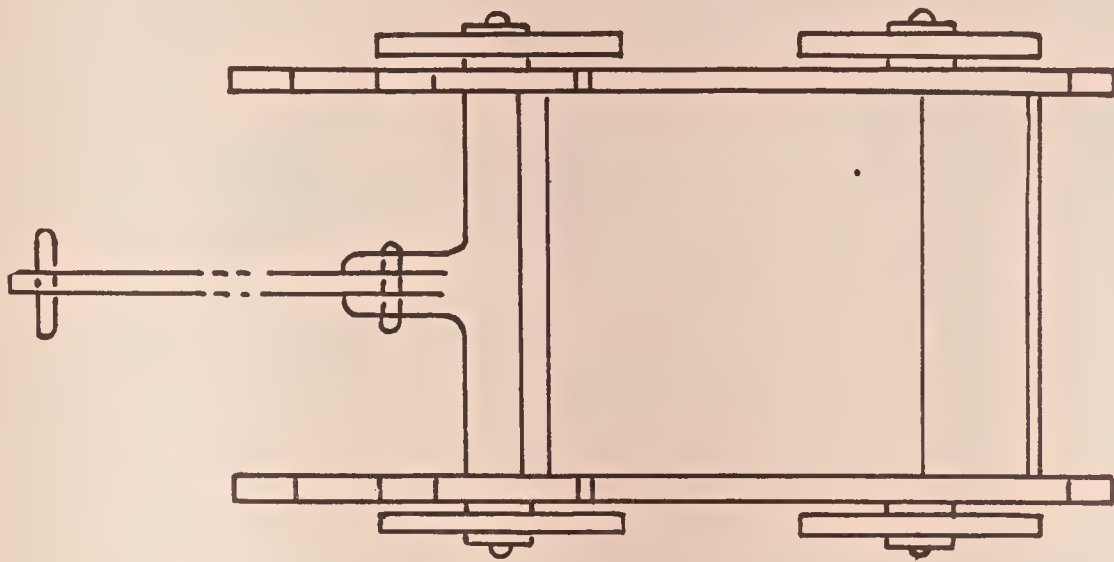
Plate 24. Elephant on Wheels.

SWAN CART



▬▬▬ = 1 in.

Plate 25. Swan Cart.



CHICKEN CART

1/4 SCALE

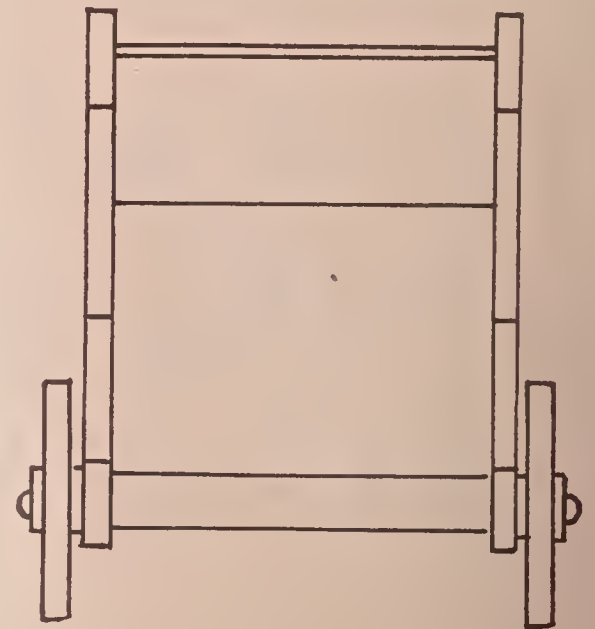
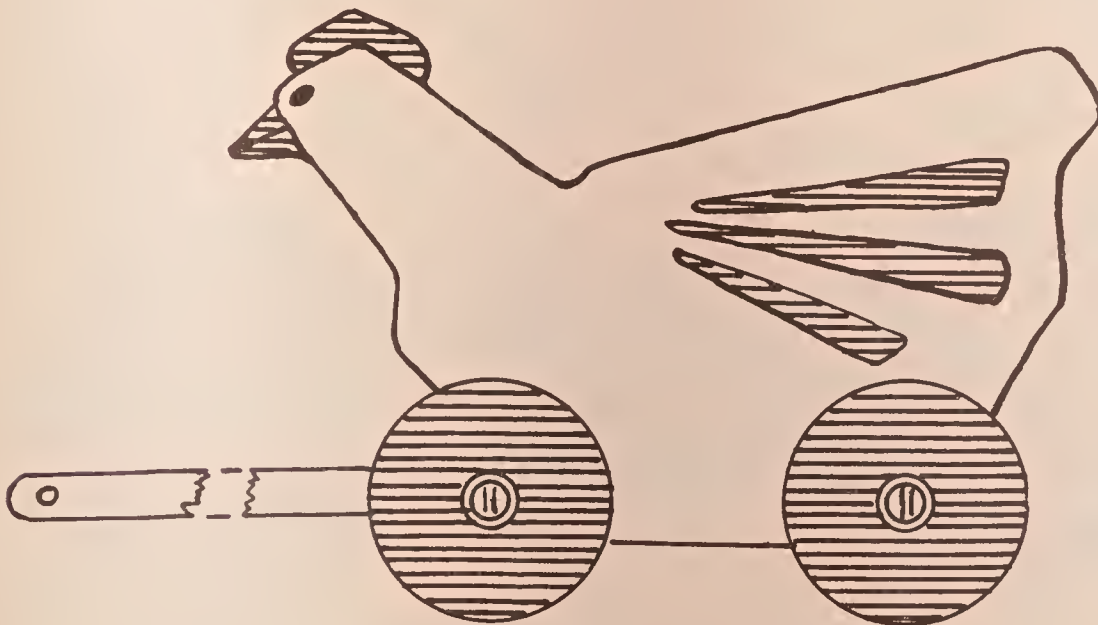
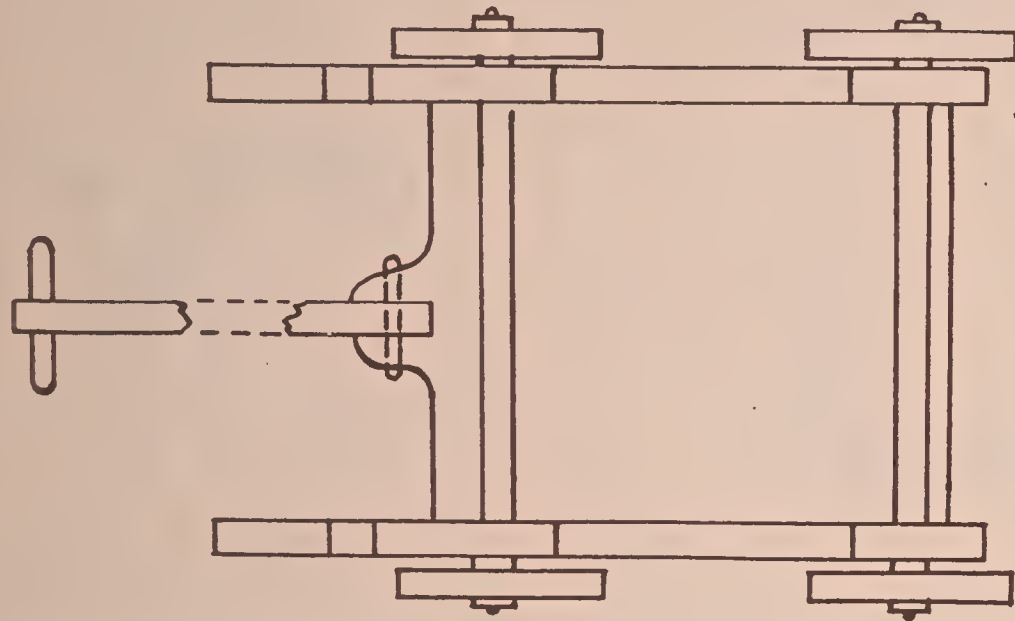


Plate 26. Chicken Cart.



BEAR CART

$\frac{1}{4}$ " SCALE

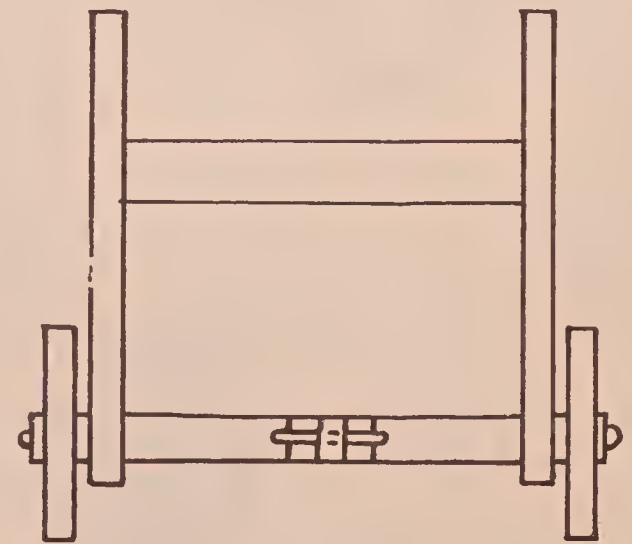
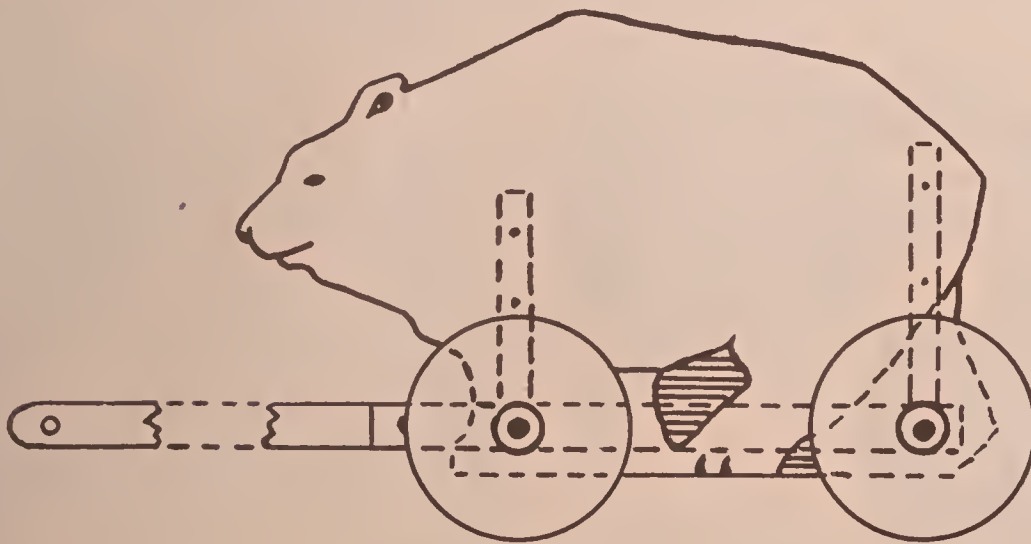


Plate 27. Bear Cart.

SWAN ON WHEELS

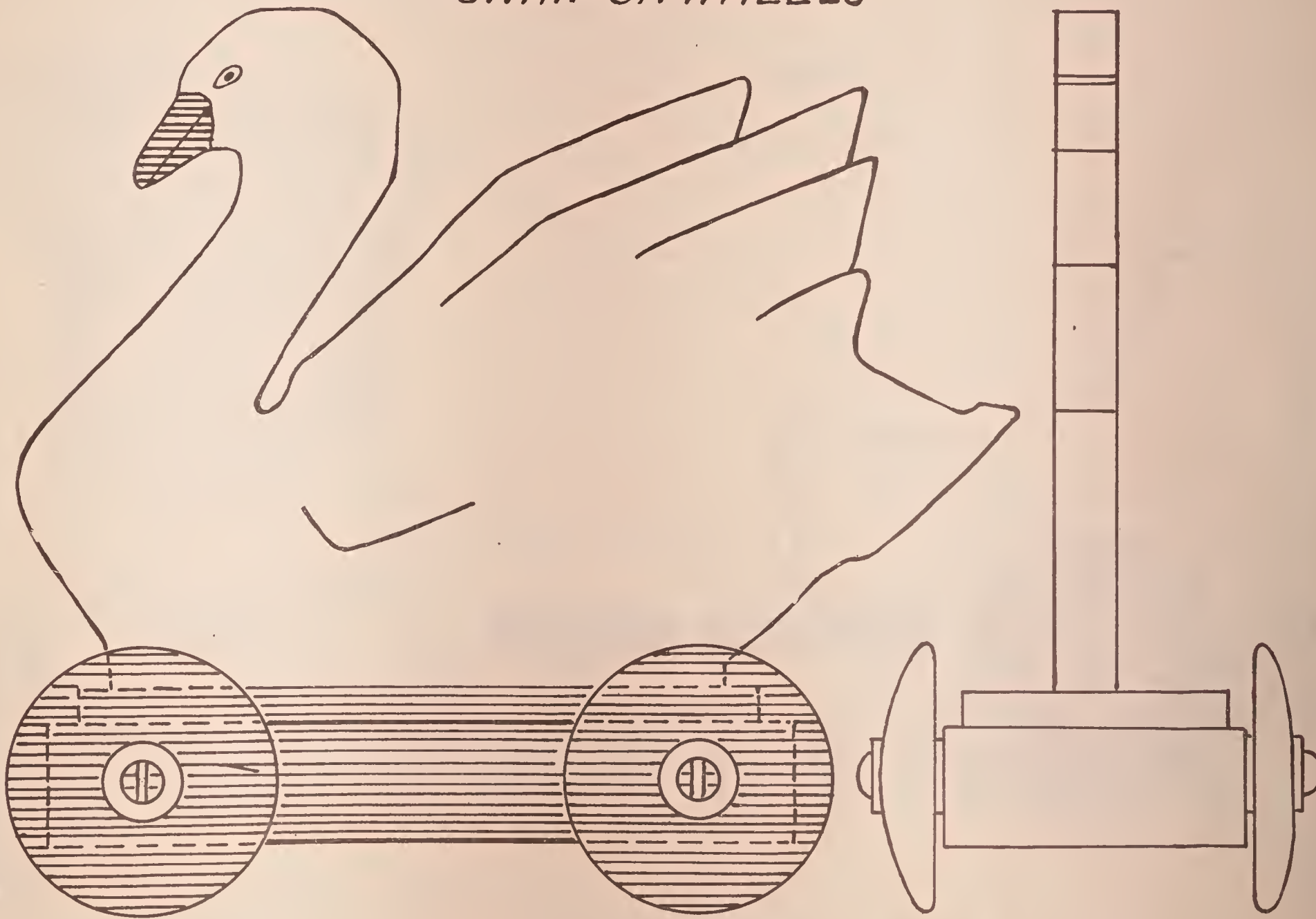
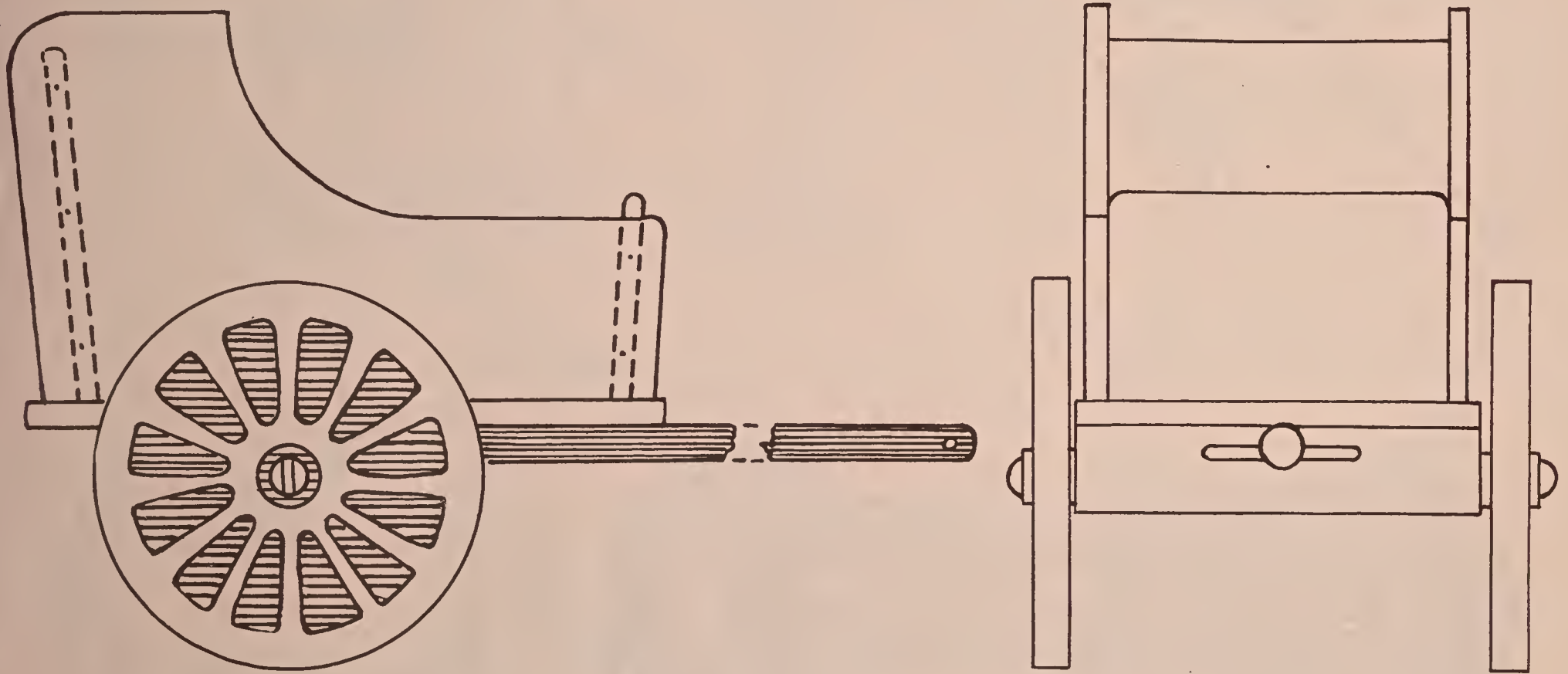


Plate 28. Swan on Wheels.

CART
HALF SIZE



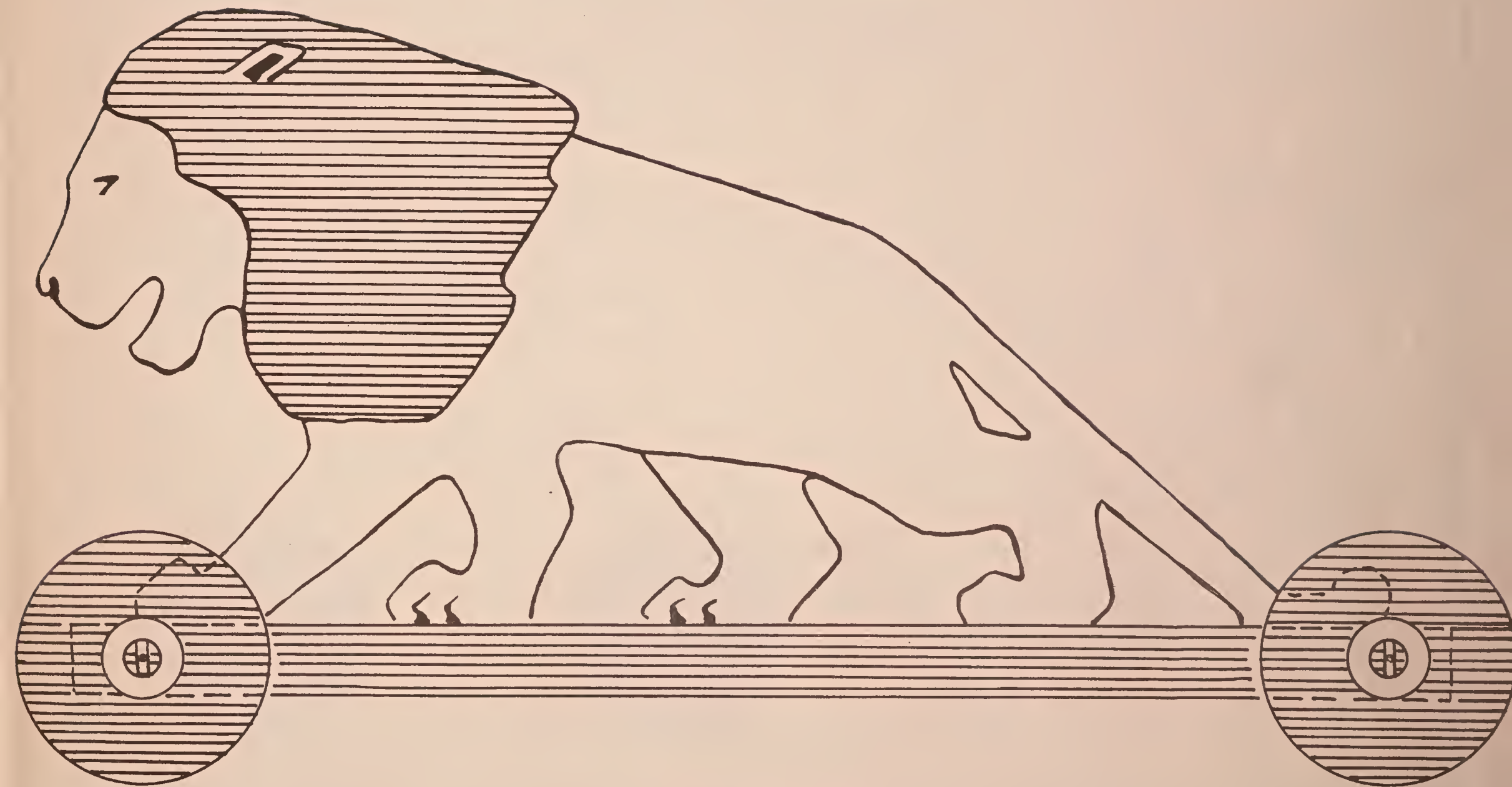
LION ON WHEELS

Plate 30. Lion on Wheels.

EXPRESS WAGON

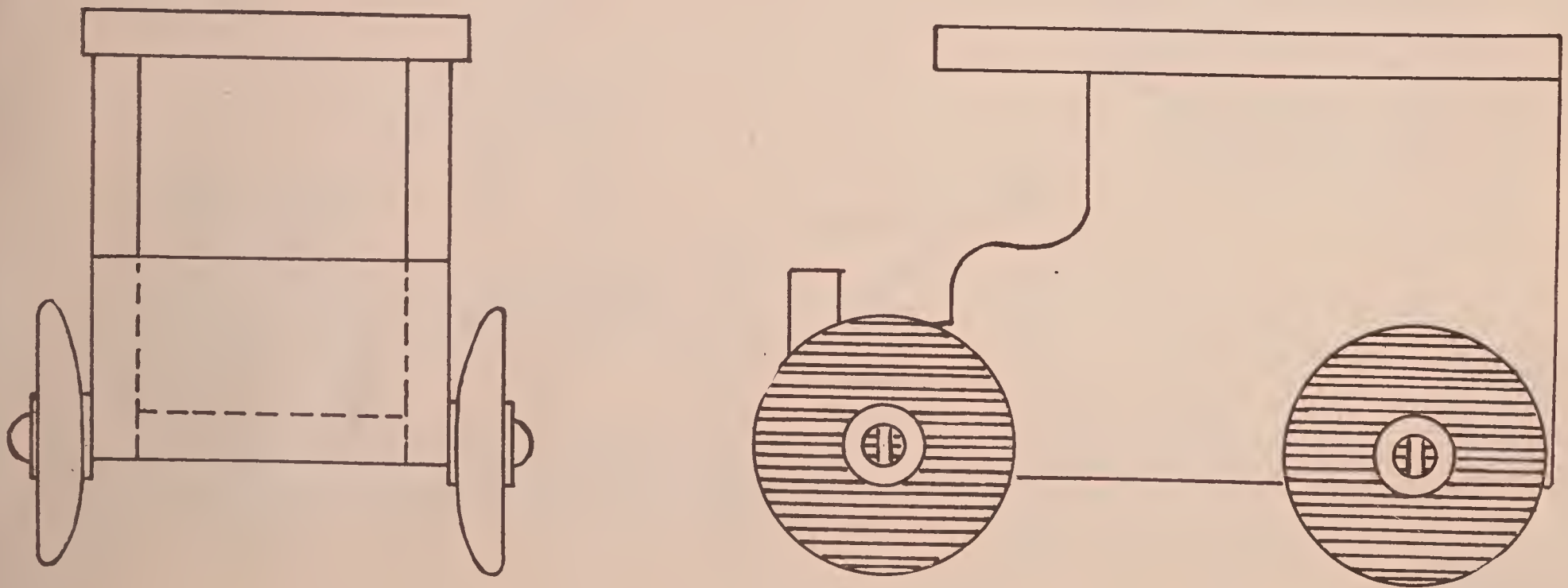
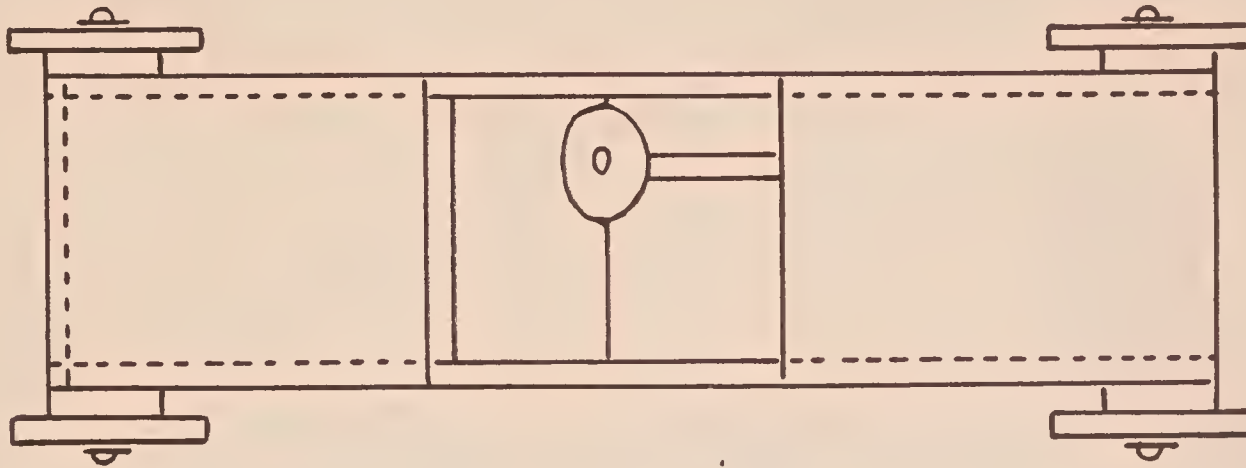


Plate 31. Express Wagon.



AUTOMOBILE
 $\frac{1}{2}$ SIZE

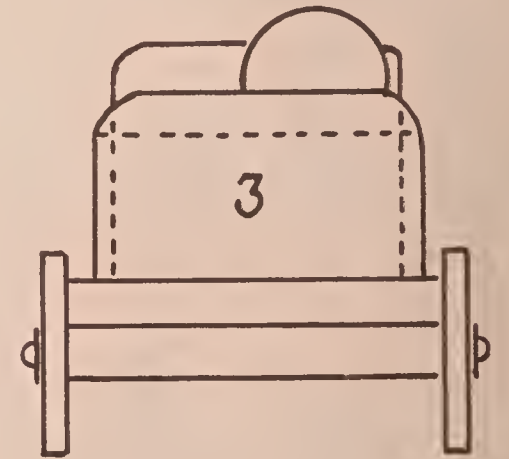
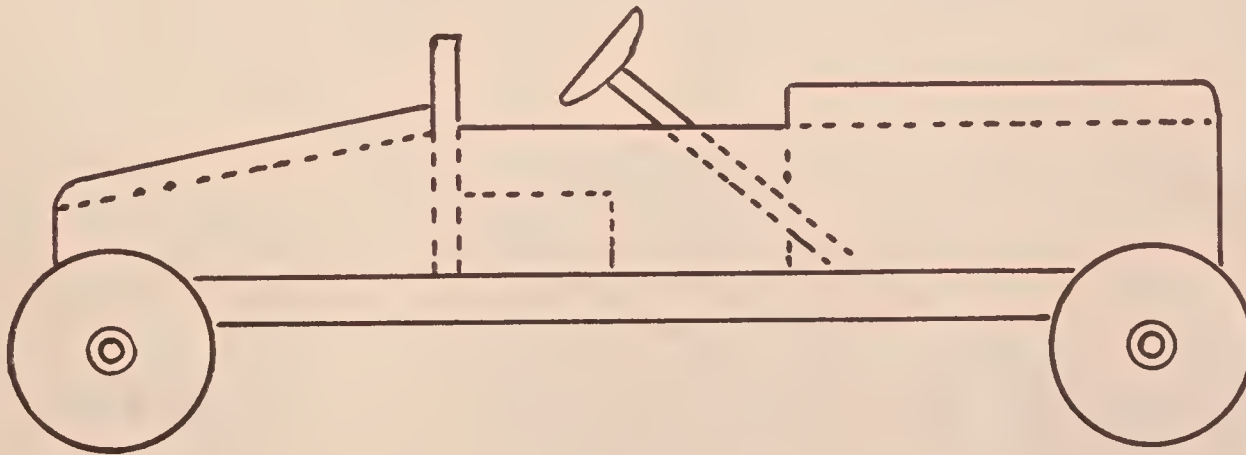
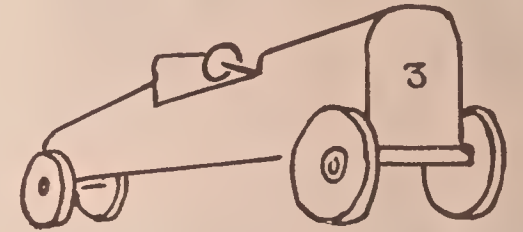
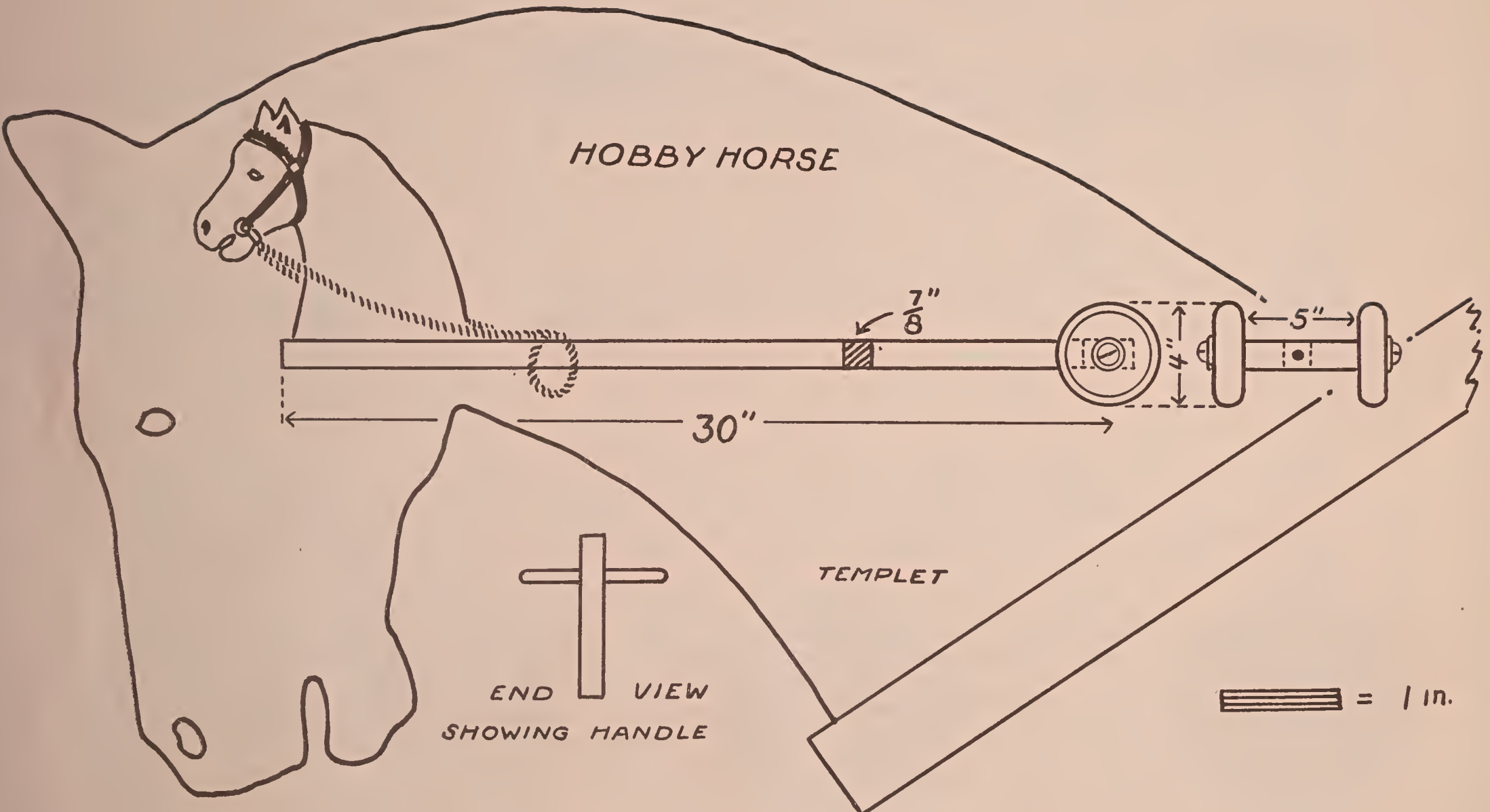


Plate 32. Automobile.



HOBBY HORSE

7/8"

30"

5"

4"

TEMPLET

END VIEW
SHOWING HANDLE

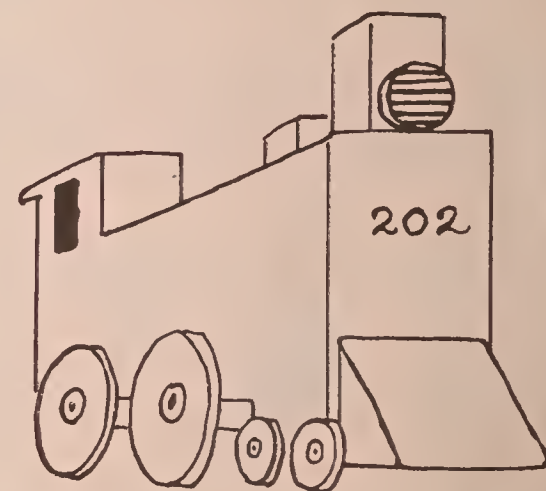
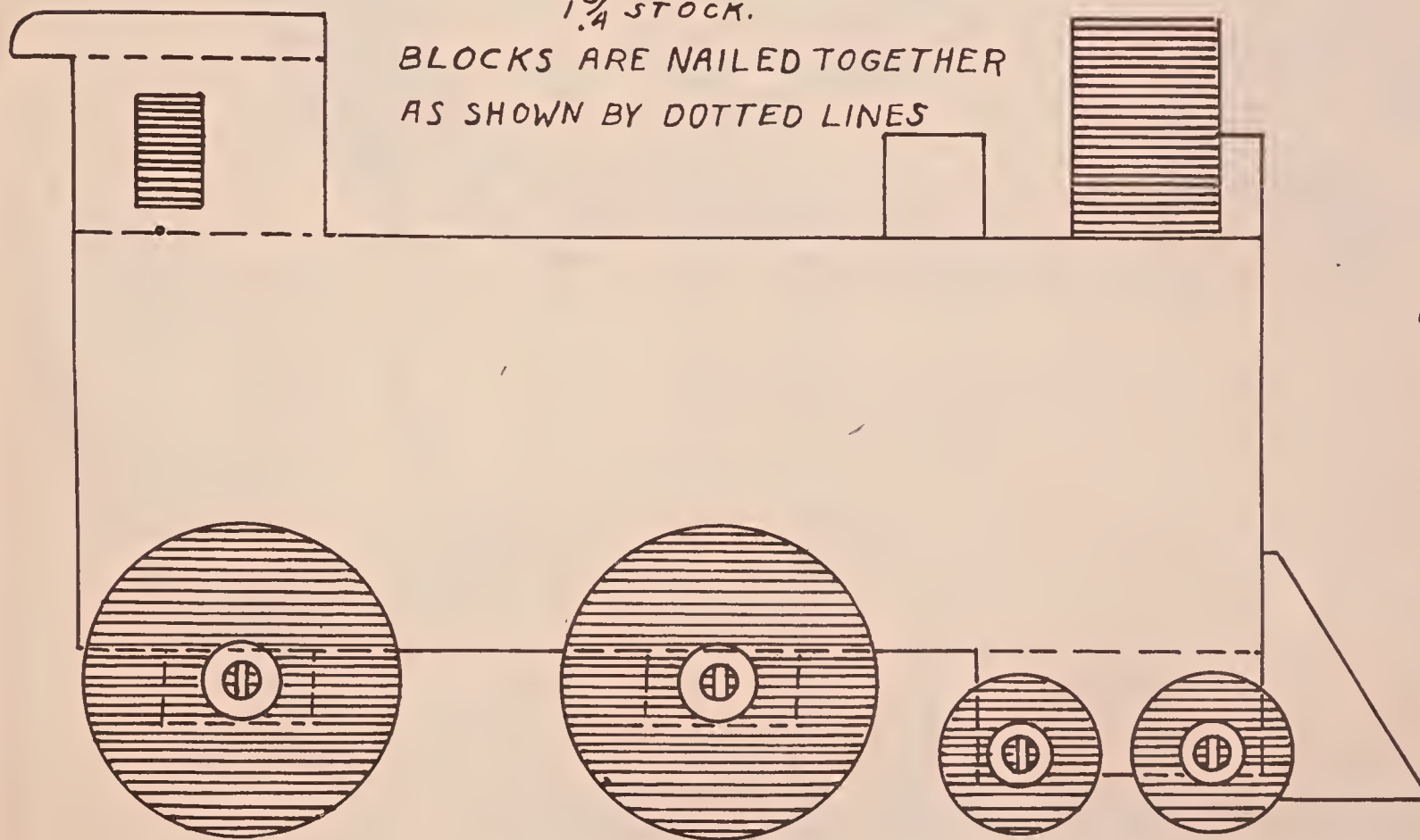
≡ = 1 in.

Plate 33. Hobby Horse.

MECHANICAL TOY

LOCOMOTIVE.

MAKE BODY OF ENGINE FROM
 $1\frac{3}{4}$ " STOCK.
BLOCKS ARE NAILED TOGETHER
AS SHOWN BY DOTTED LINES



 = 1 in.

Plate 34. Locomotive.

REVOLVING TOY

SCALE $\frac{1}{2}'' = 1''$

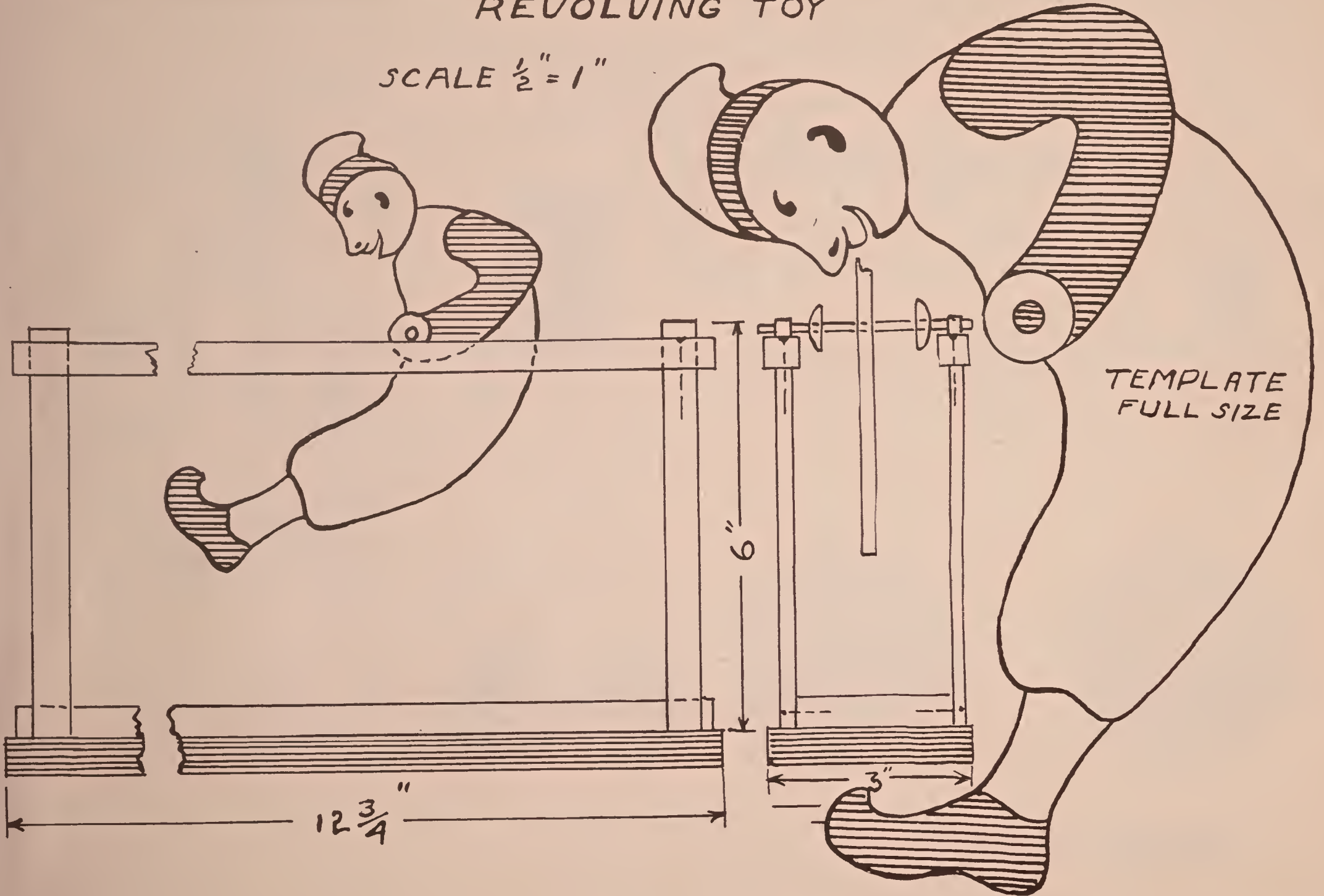


Plate 35. Traveling Tumbling Clown.

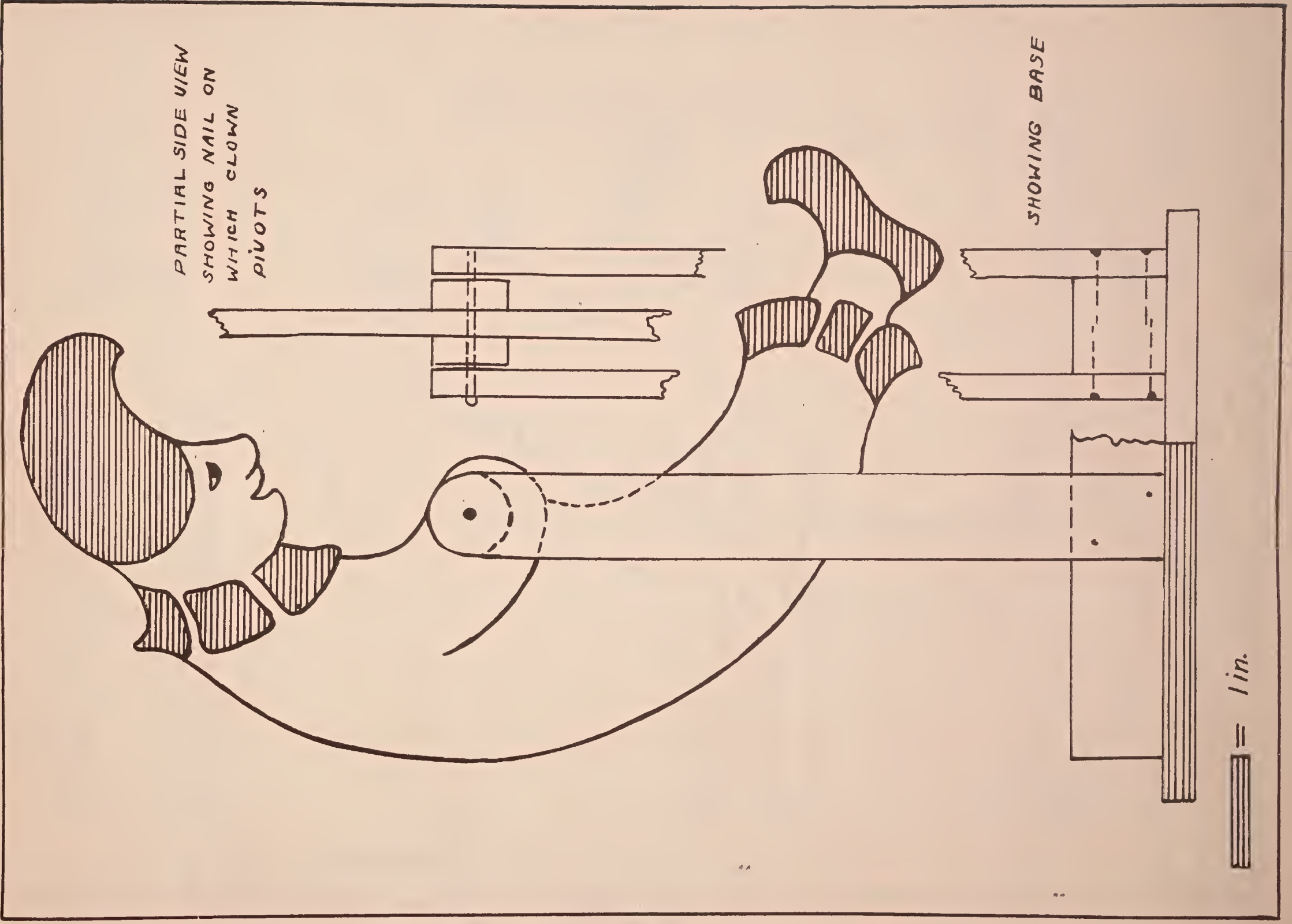
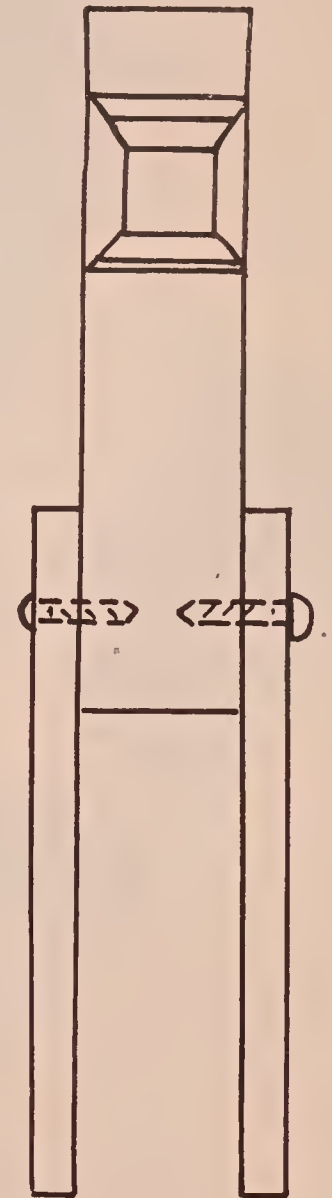
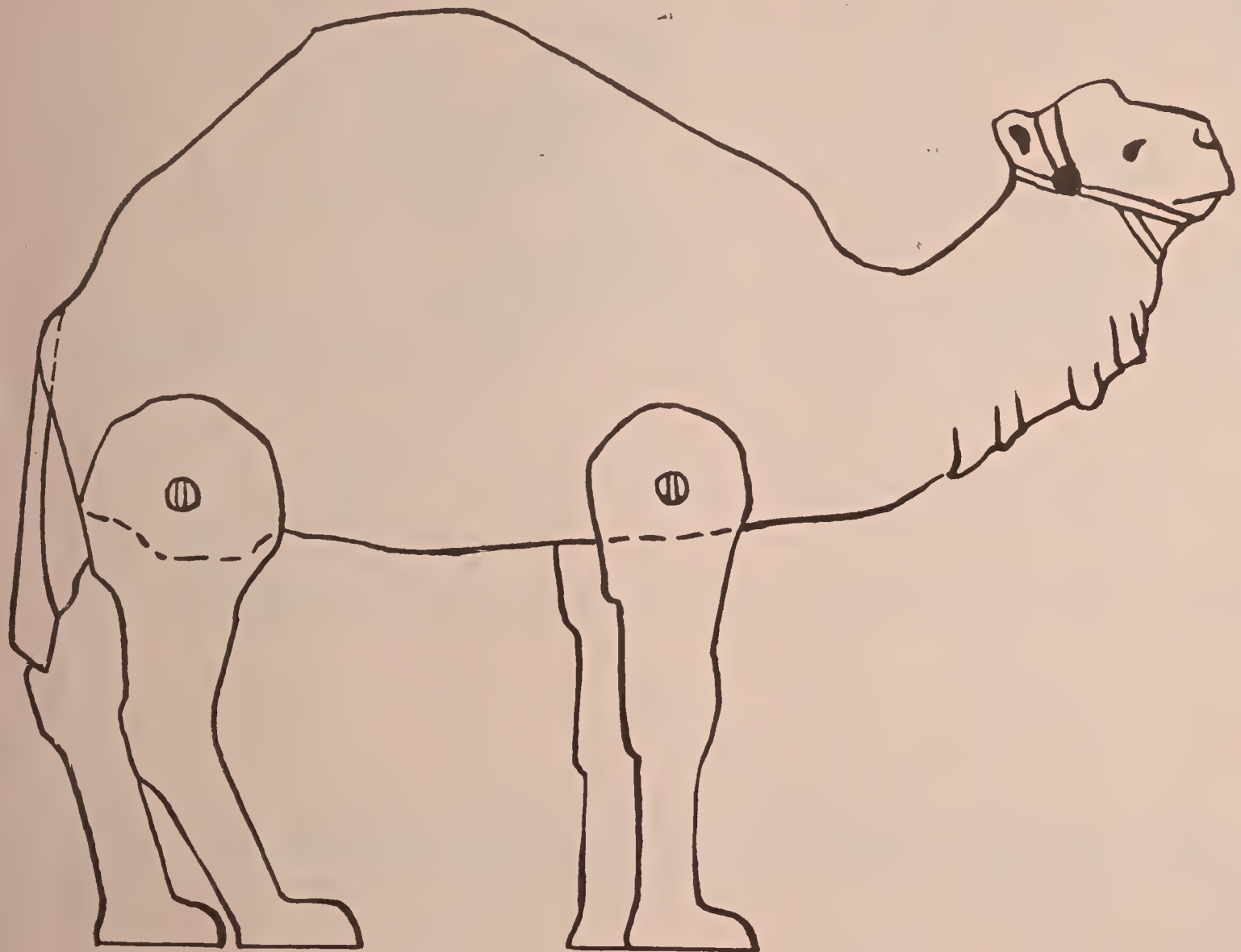


Plate 36. Tumbling Clown.

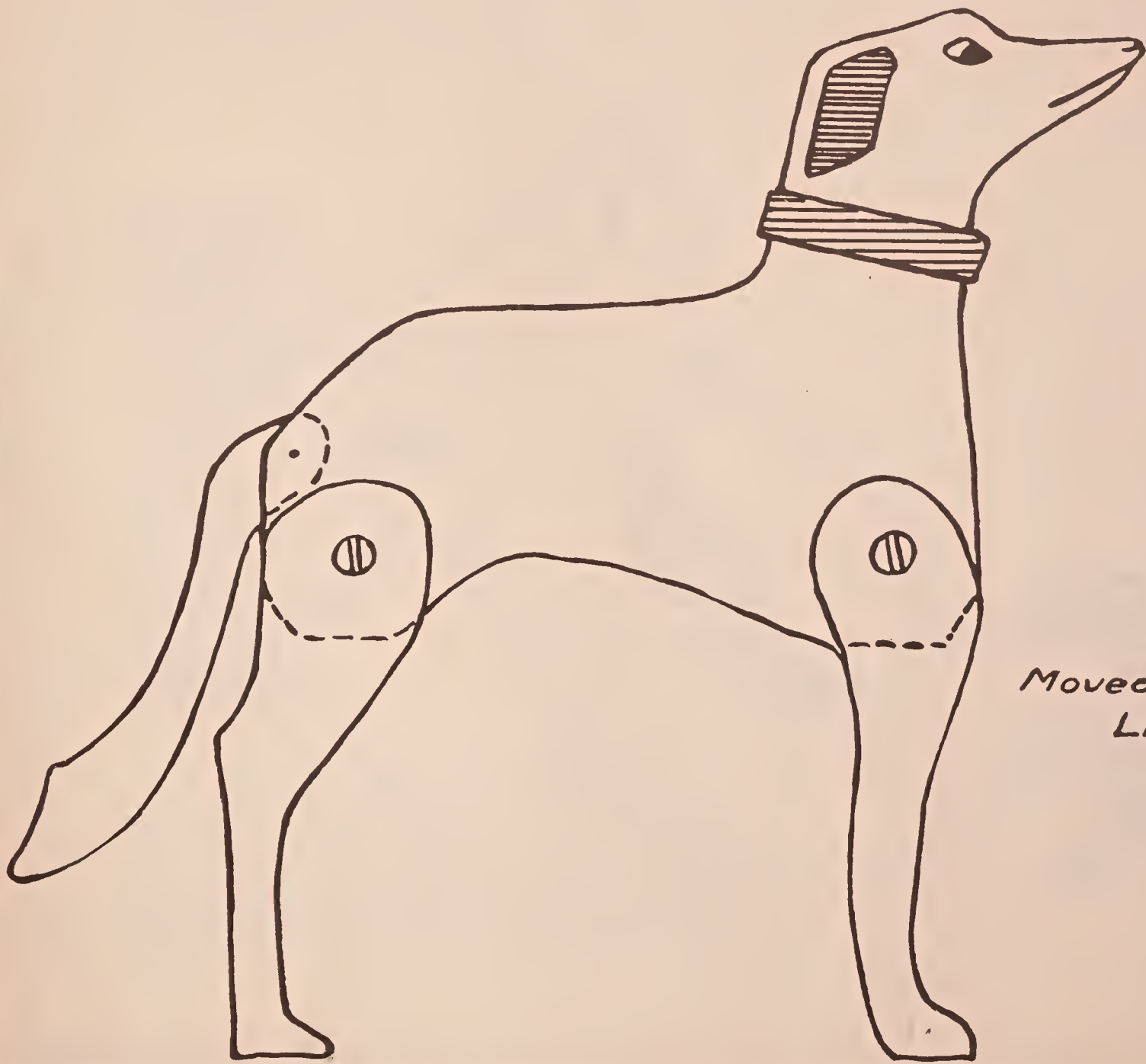
ANIMAL TOY
MOVEABLE LIMBS



 = 1 in.

Plate 37. Camel.

ANIMAL TOY



Moveable
Limbs

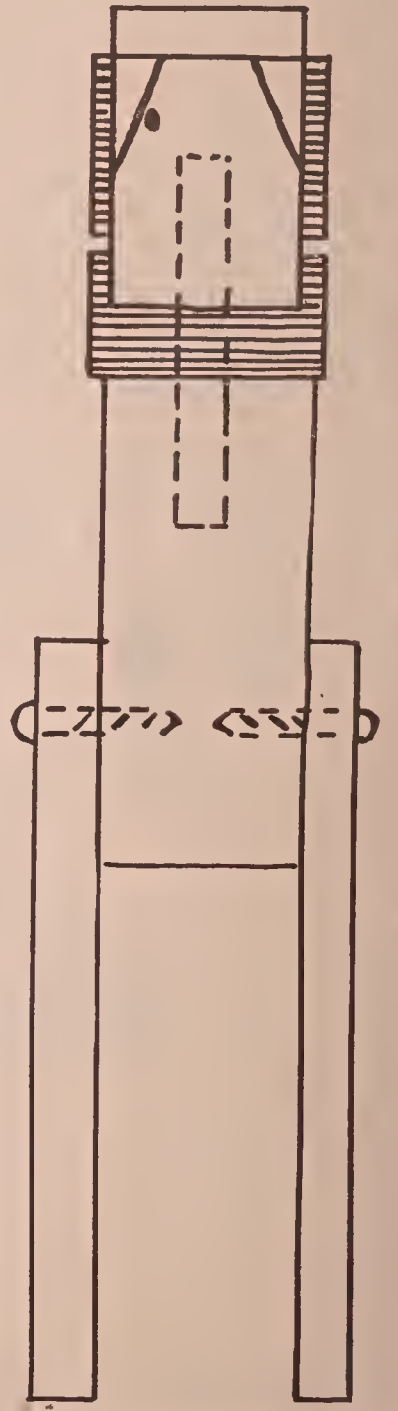


Plate 38. Dog.

-DUCK-
PAPER WEIGHT



Plate 39. Duck Paper Weight.

*RED CROSS DOG
PAPERWEIGHT*

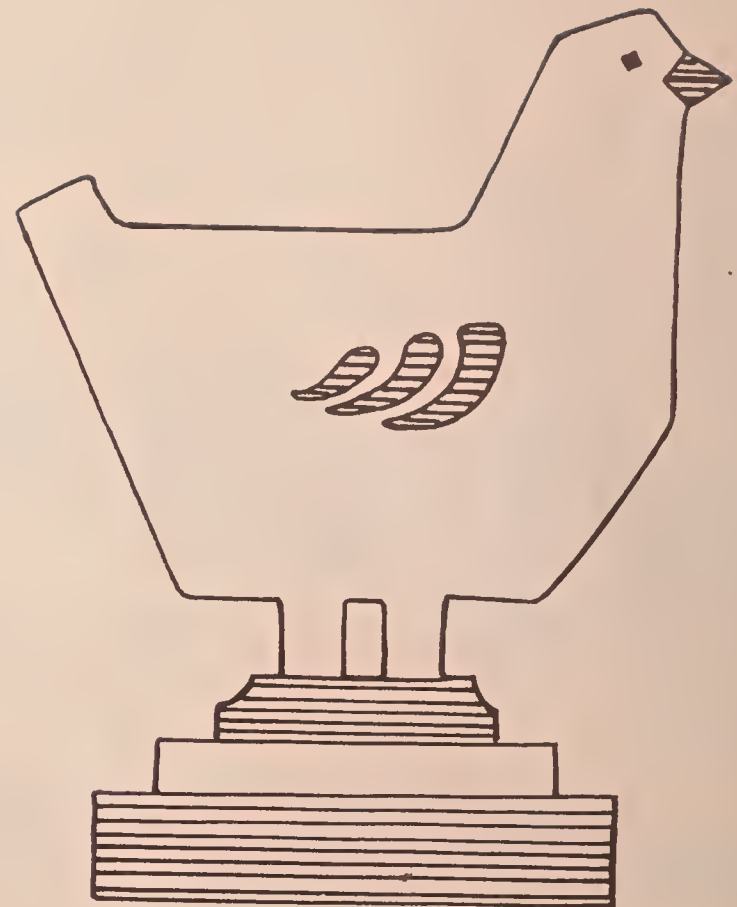
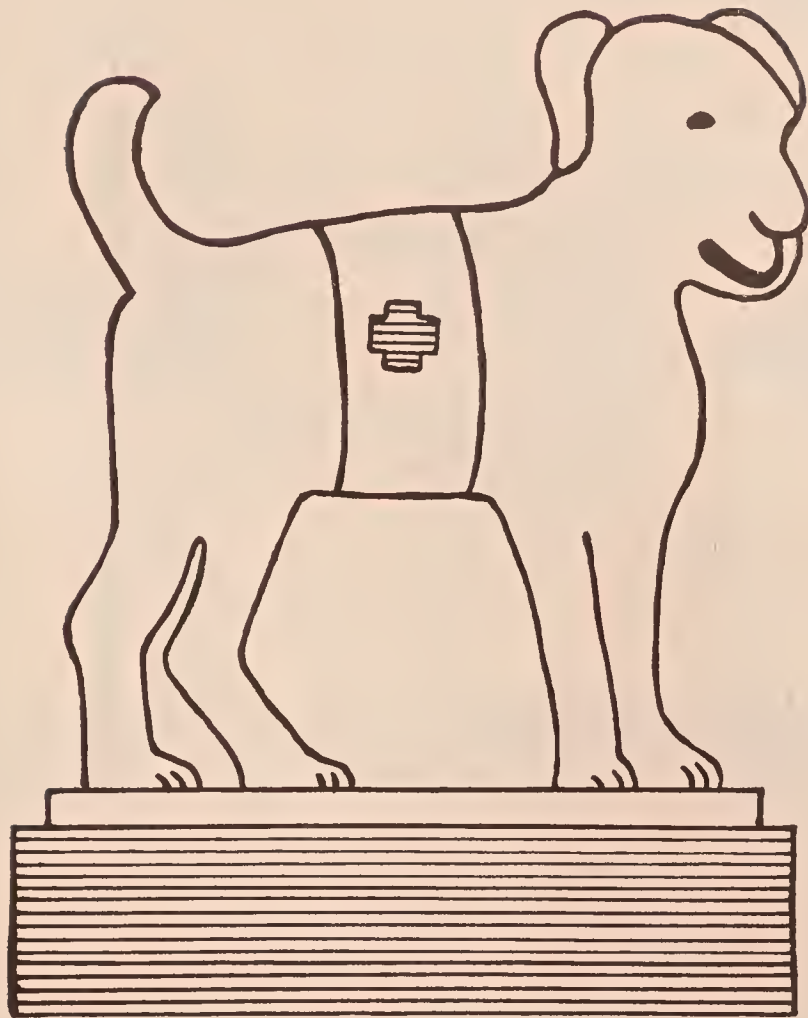
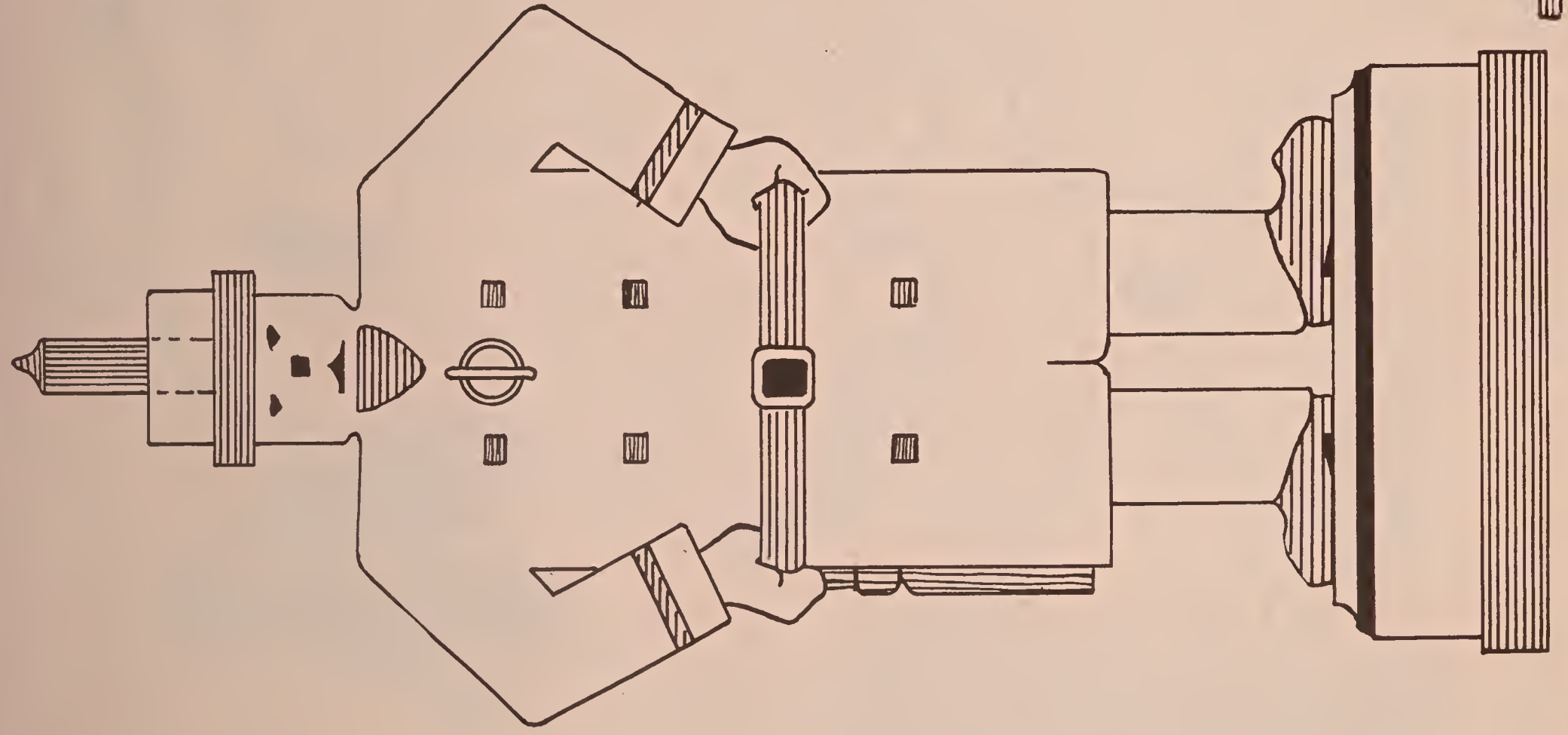


Plate 40. Paper Weights.

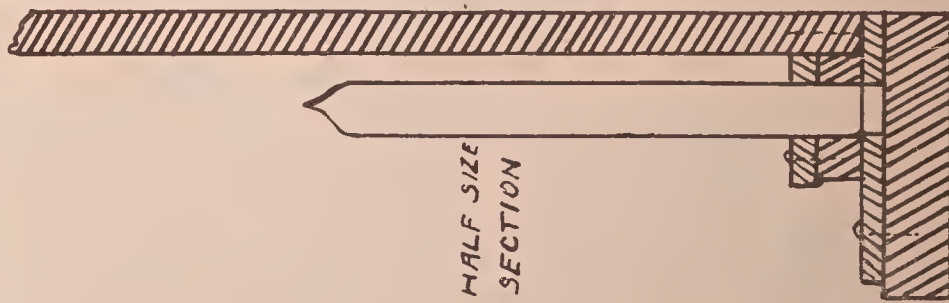
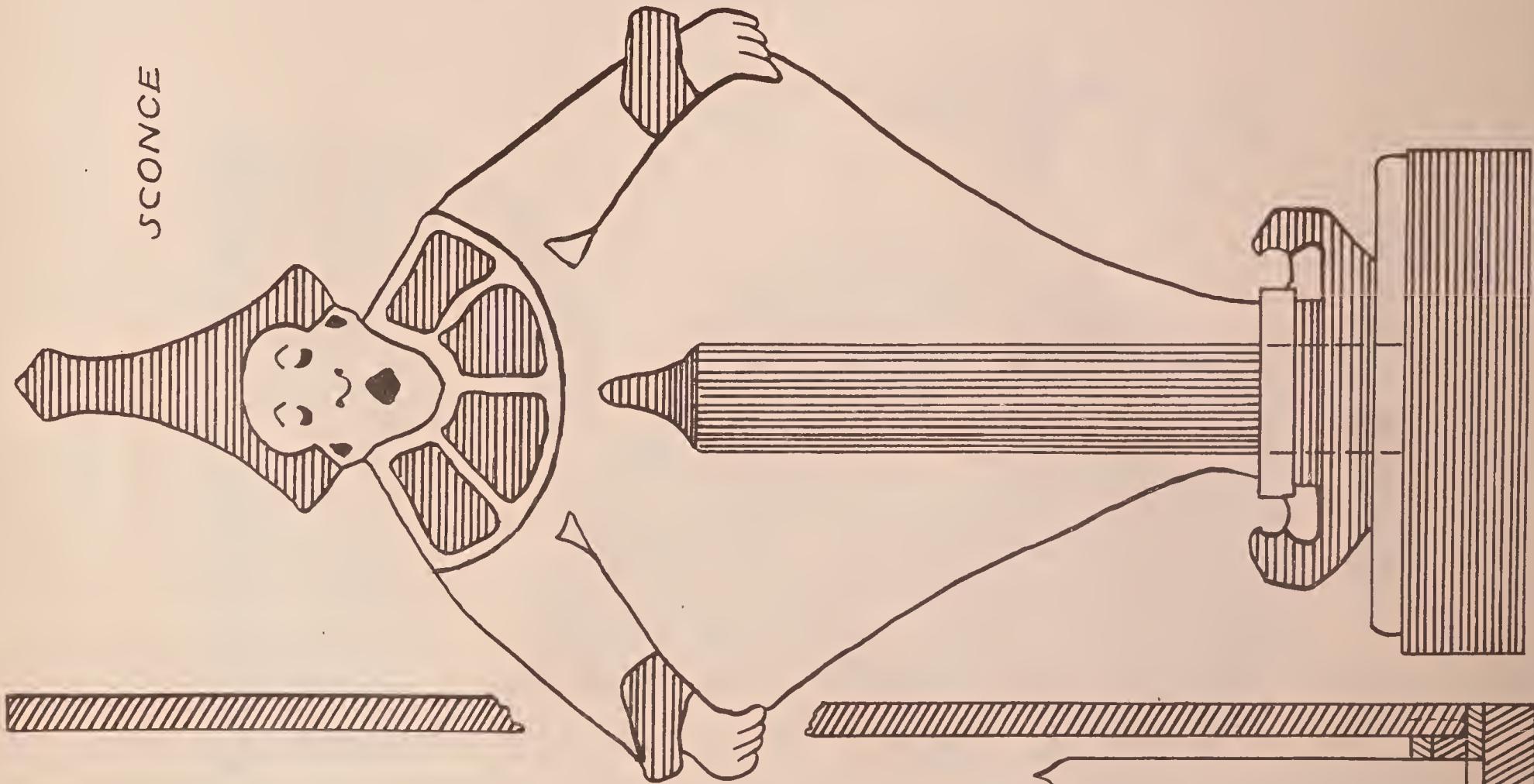
NIGHT WATCHMAN



1 in

Plate 41. Policeman Candle Holder.

SCONCE



HALF SIZE SECTION

1/2" = 1 in.

Plate 42. Clown Sconce.

PAPER WEIGHT

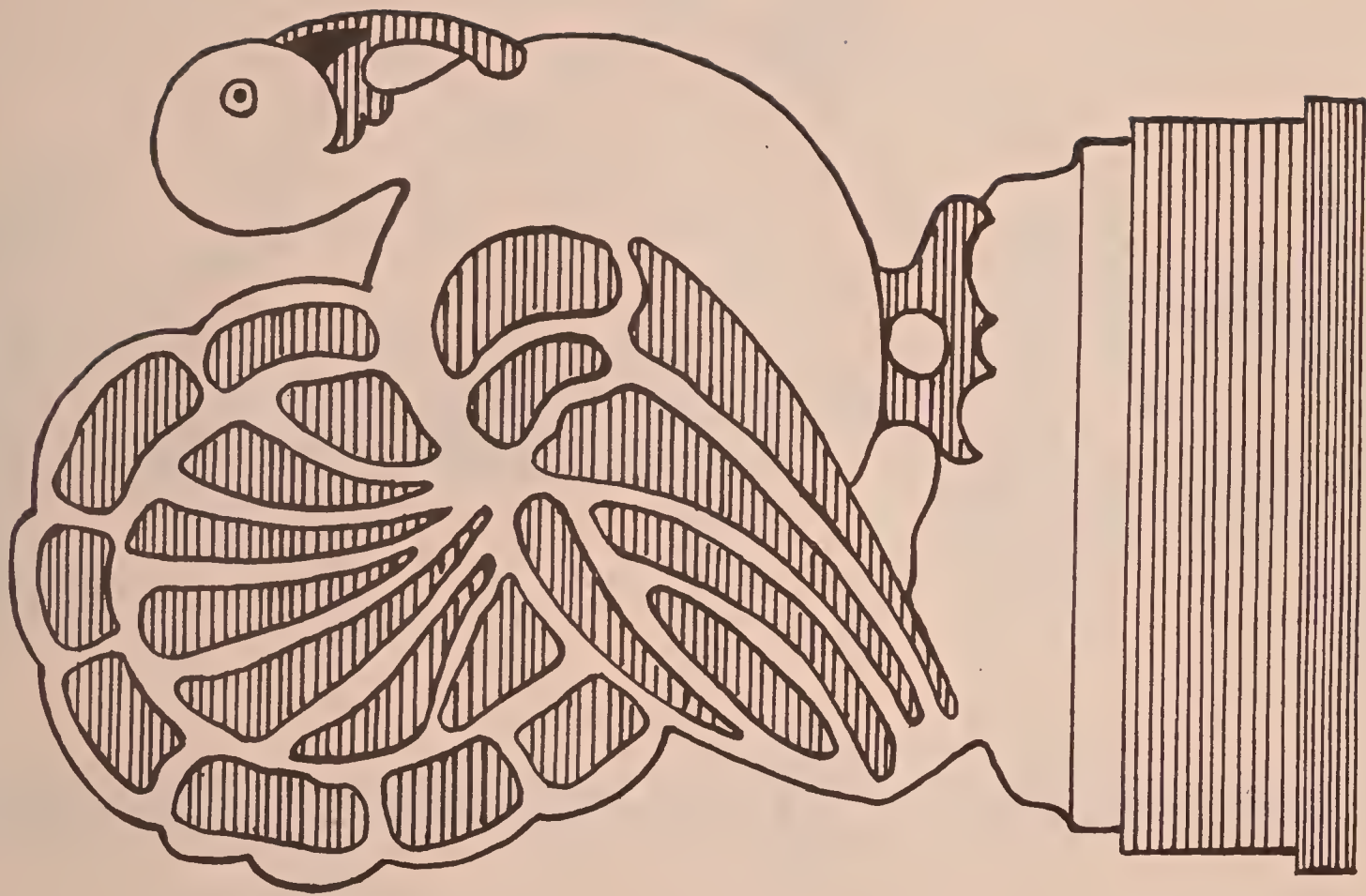
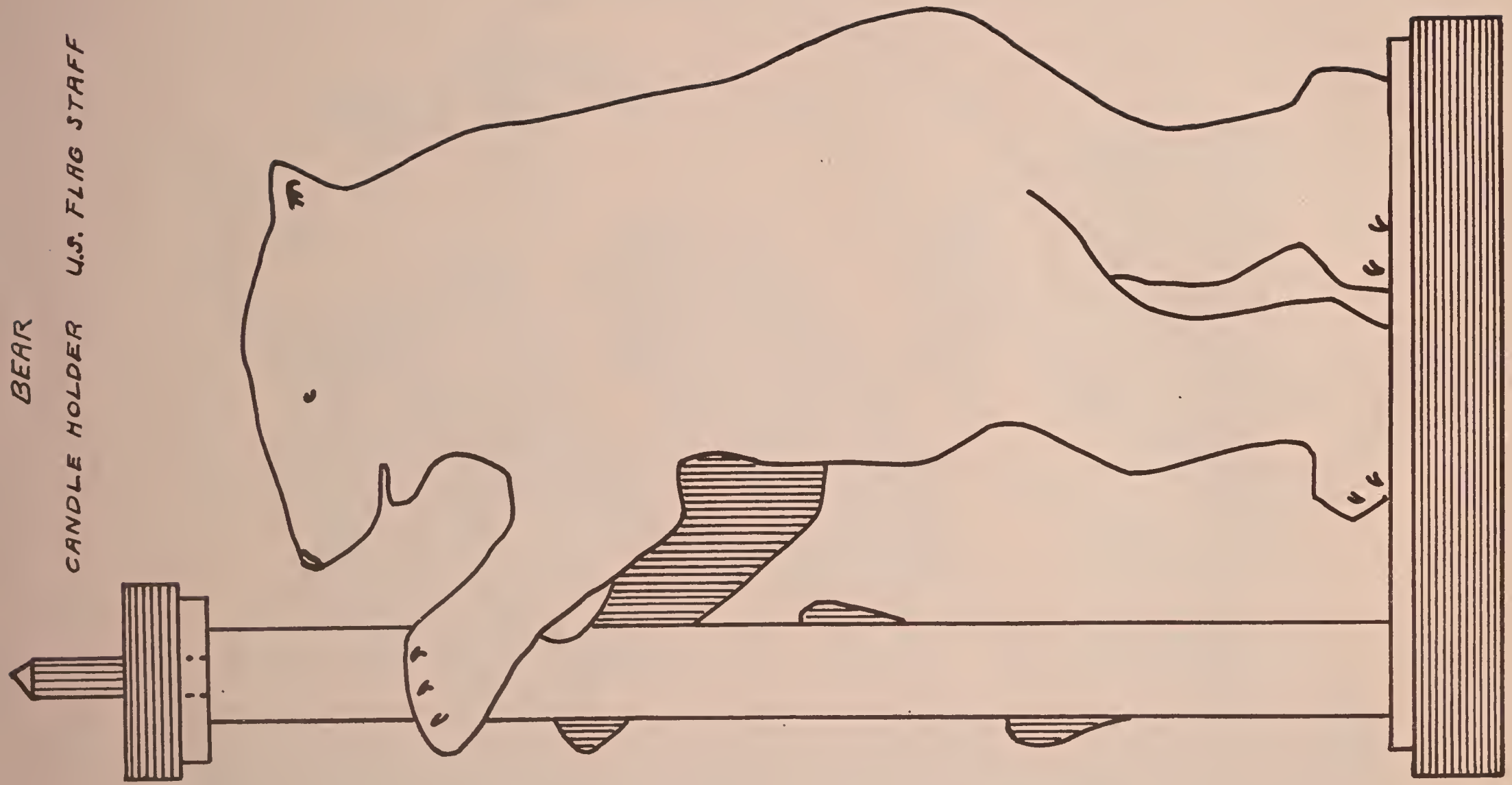


Plate 43. Turkey Paper Weight.

PAPER WEIGHT



Plate 44. Cat Paper Weight.

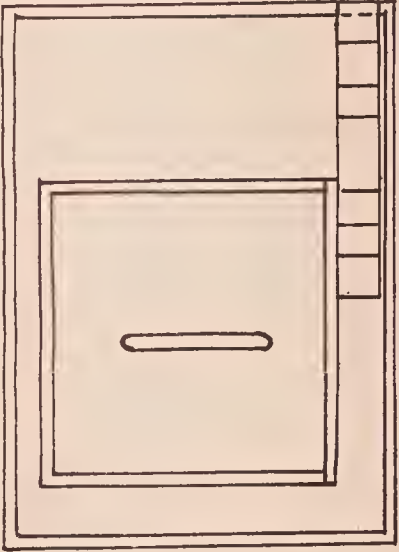


BEAR

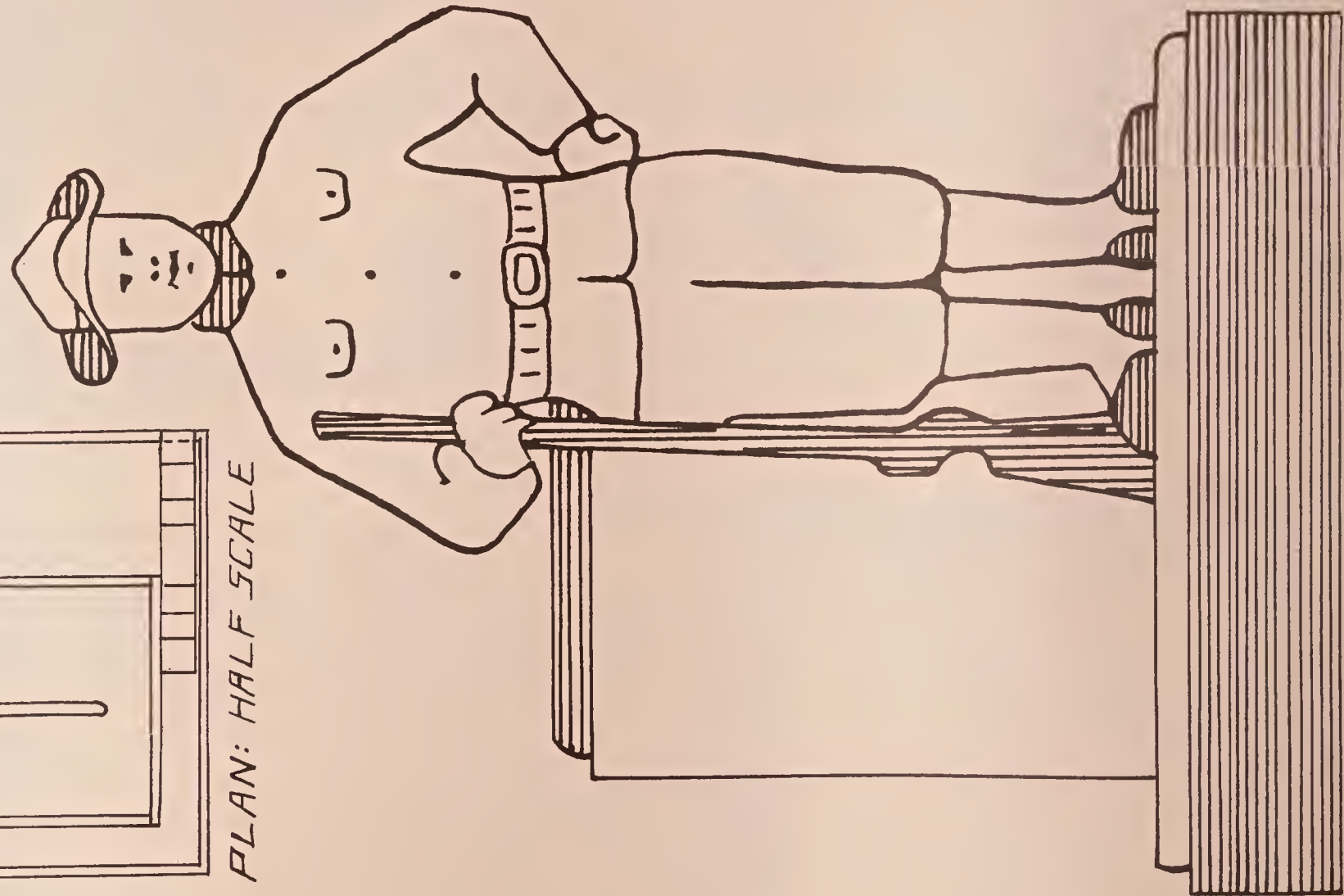
CANDLE HOLDER U.S. FLAG STAFF

Plate 45. Candle Holder or Flag Staff.

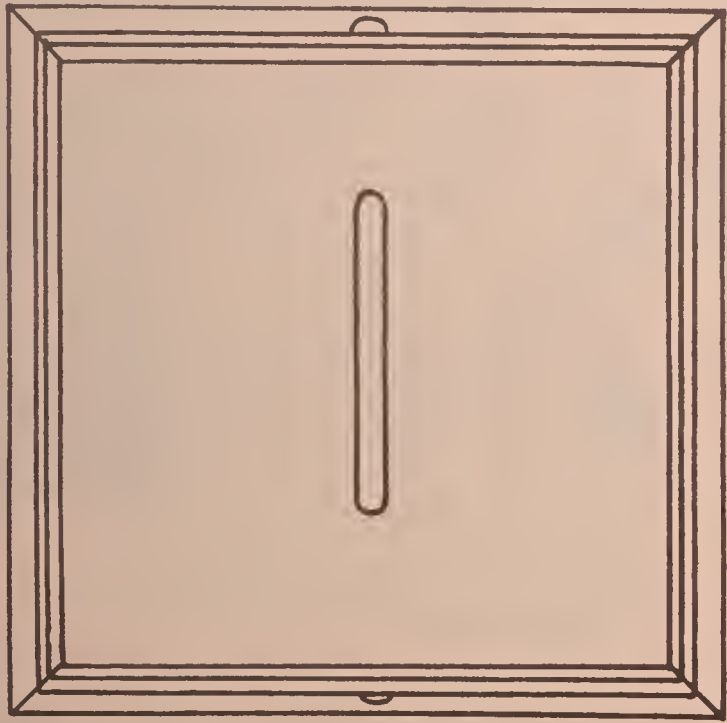
SAVINGS DEPOSITORY



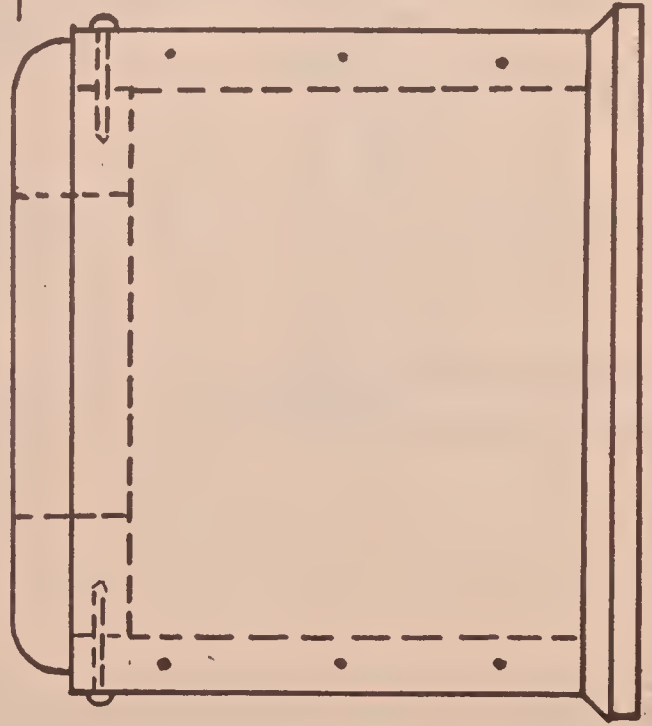
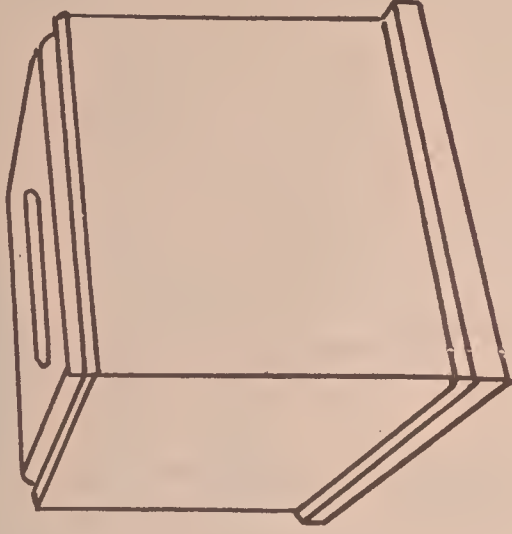
PLAN: HALF SCALE



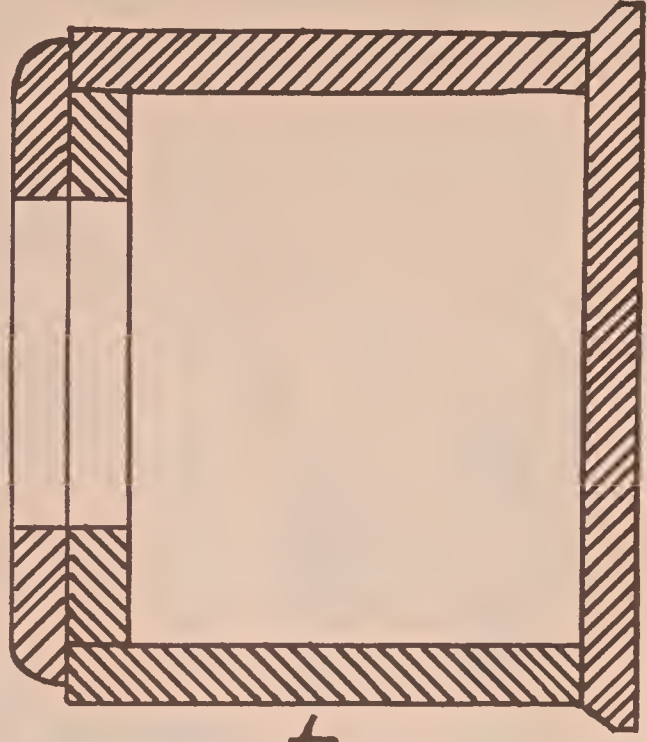
-BANK-



$3\frac{1}{8}$ "



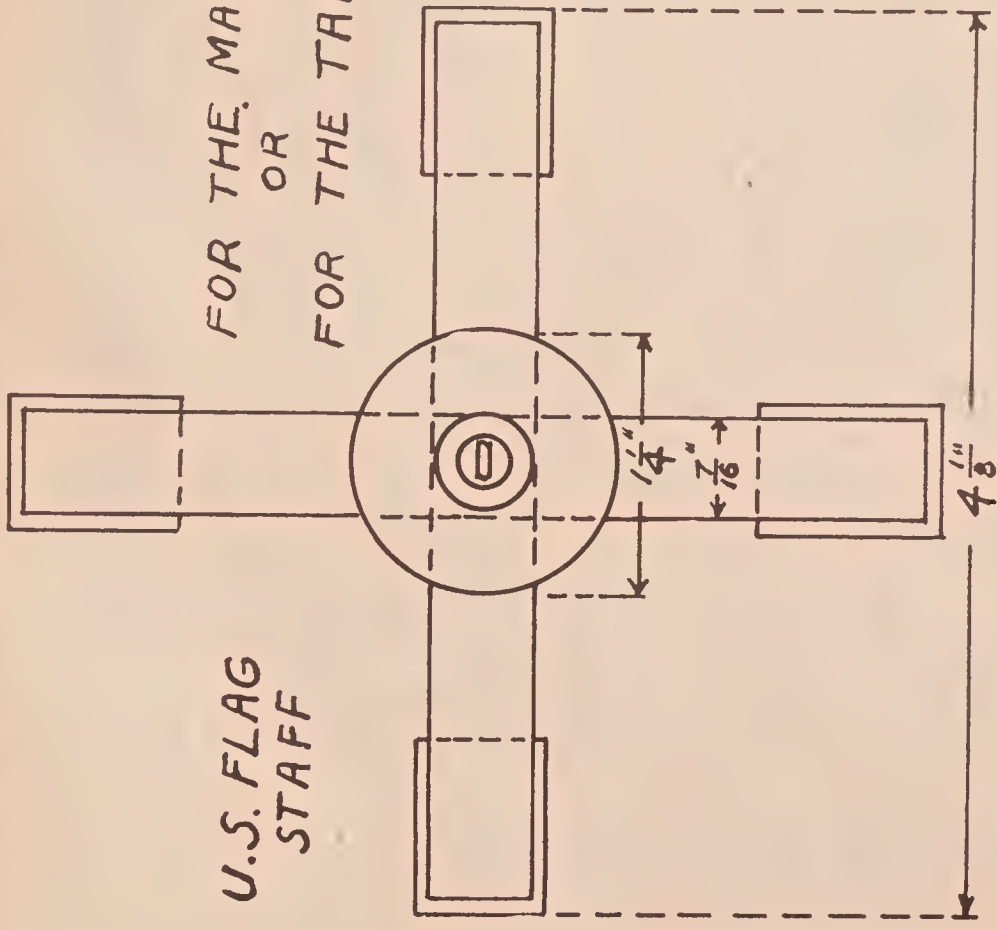
$2\frac{3}{4}$ "



$2\frac{1}{4}$ "

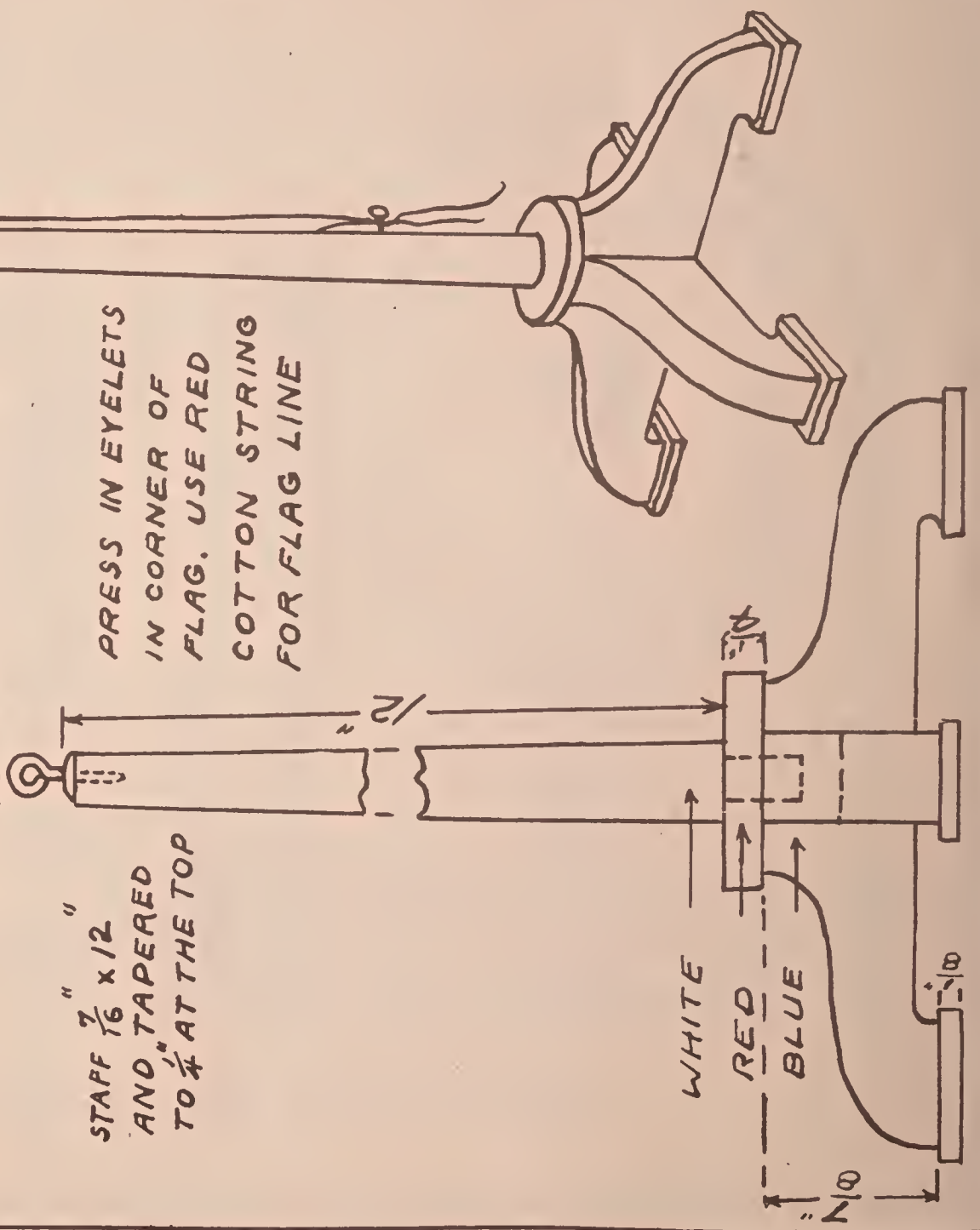
U.S. FLAG
STAFF

FOR THE MANTLE
OR
FOR THE TABLE



STAFF $\frac{7}{16}$ " x 12"
AND TAPERED
TO $\frac{1}{4}$ " AT THE TOP

PRESS IN EYELETS
IN CORNER OF
FLAG. USE RED
COTTON STRING
FOR FLAG LINE

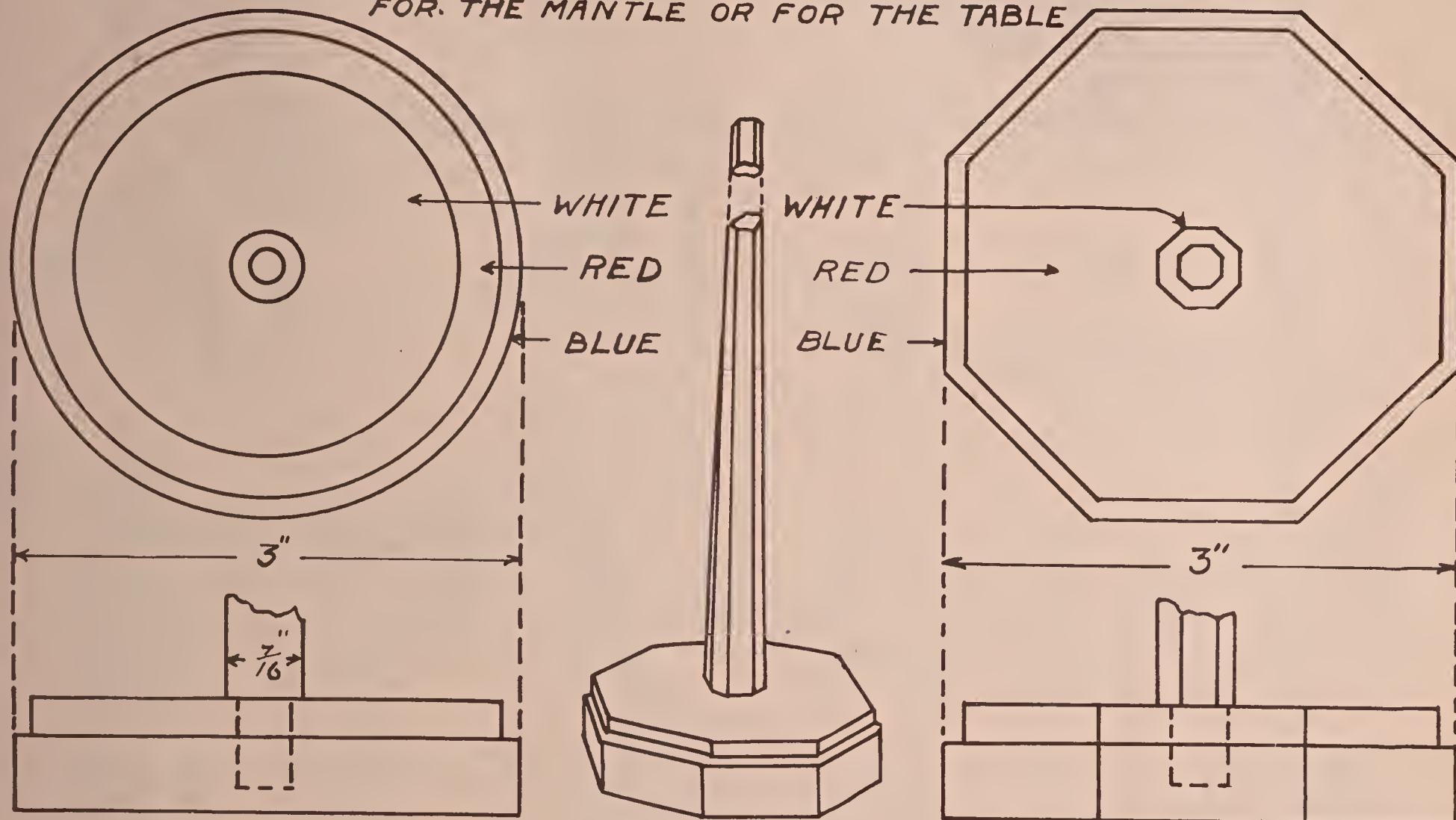


WHITE

RED

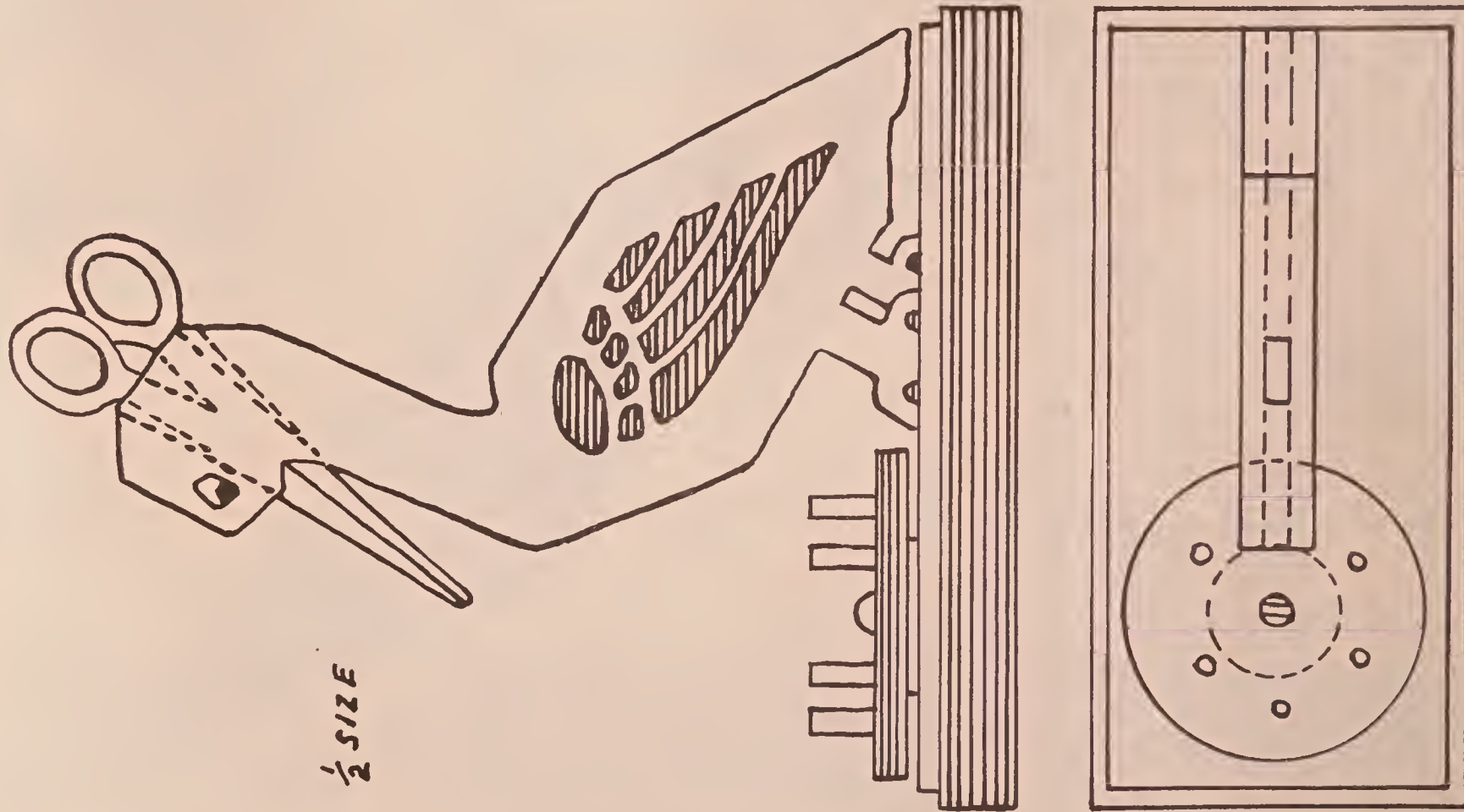
BLUE

- U. S. FLAG STAFFS -
FOR THE MANTLE OR FOR THE TABLE

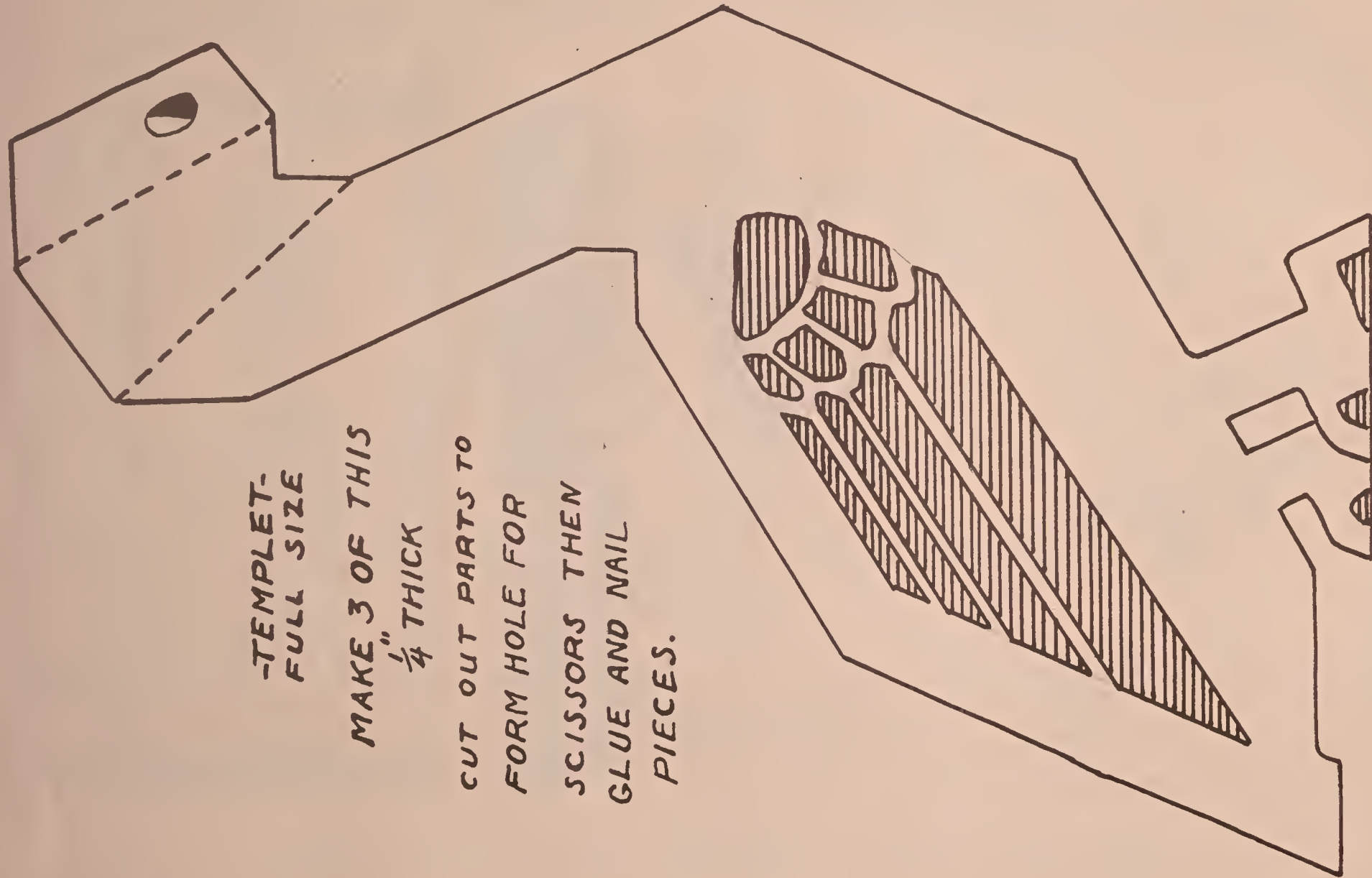


STAFFS $\frac{1}{2}$ " x 12" AND TAPERED TO $\frac{1}{4}$ " AT THE TOP

SEWING COMBINATION



1/2 SIZE



- MATCH STANDS -

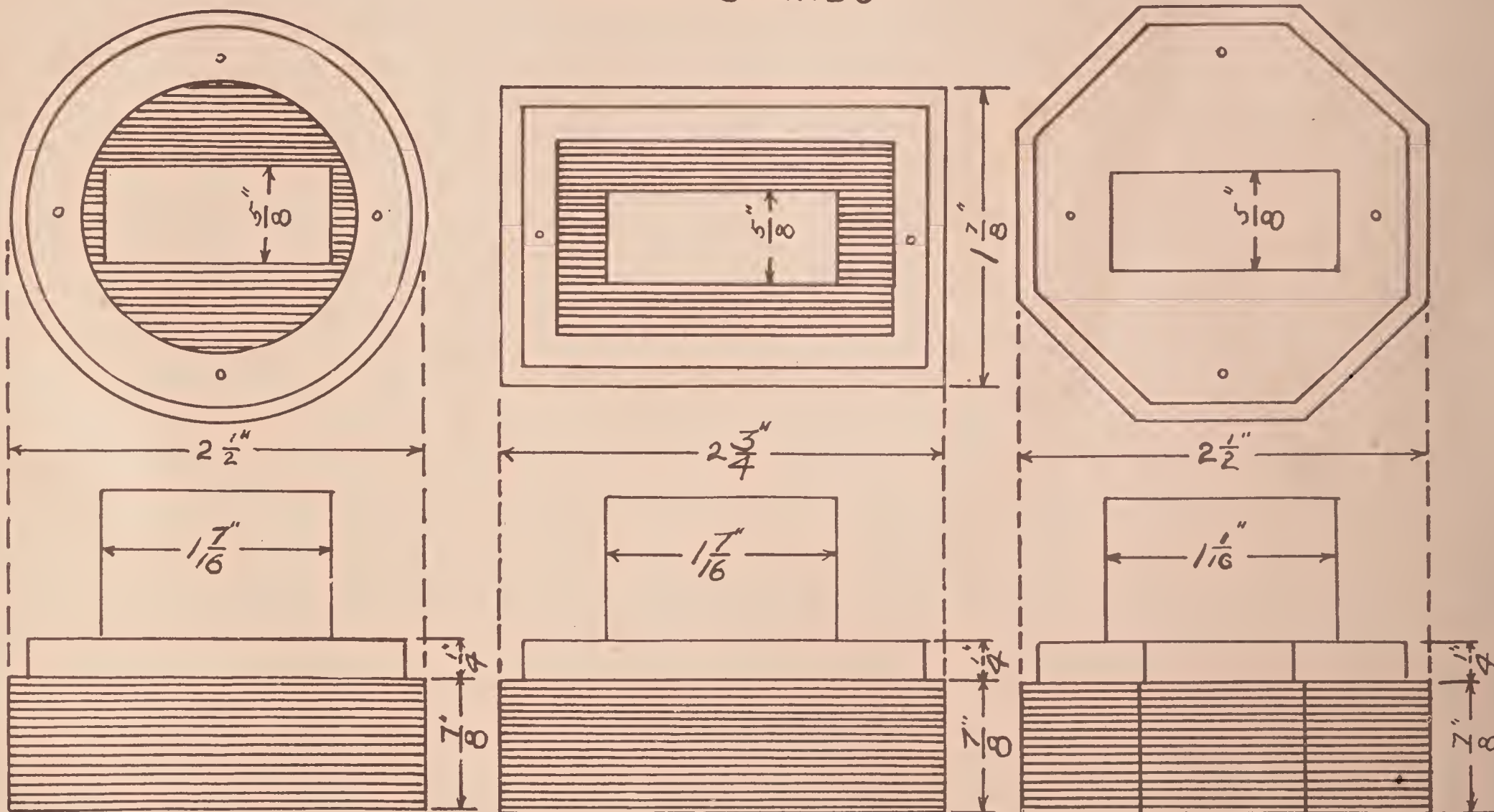


Plate 52. Match Stands.

LIBRARY OF CONGRESS



0 019 344 366 7