

小學勞作叢書

手工藝類

新法摺紙玩具

陸松安編著

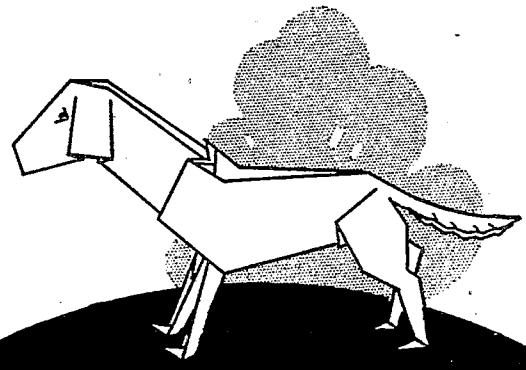

KBC
1
523.75
3

443

372.5
7443

(1) 新法摺紙玩具目次

1. 基本形摺法	2
2. 獅的摺法	3
3. 象的摺法	6
4. 馬的摺法	8
5. 牛的摺法	10
6. 鹿的摺法	12
7. 狗的摺法	14
8. 狐的摺法	16
9. 松鼠的摺法	16
10. 老鼠的摺法	19
11. 兔的摺法	21
12. 鵝的摺法	23
13. 孔雀的摺法	25
14. 鷹的摺法	27
15. 燕的摺法	29
16. 草蟲的摺法	31

8309

MG
67623.71
18

新法摺紙玩具

說明

本書應用製作材料：祇要用白報紙或韌皮紙一方，這種紙不必很厚，但求質地堅韌，能耐折疊便可。

本書應用工具：祇須竹尺，剪刀，鉛筆，已經够用。

製作方法 先拿白報紙或韌皮紙一方，切成正方形，再如下面基本形摺法 1. 2. 3. 4 各圖次序摺疊：(下面各種製作物形，初步摺法完全相同，茲為節省篇幅起見，所以稱為基本形摺法如圖一)。

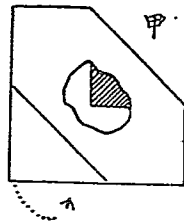

製作時應注意的摺線記號：

1. 實線——是向外摺的記號，如圖例甲。

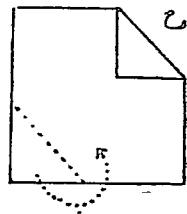

3 1761 8303 0

一 基本形摺法

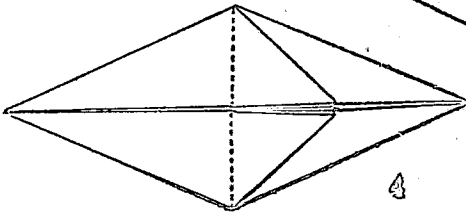
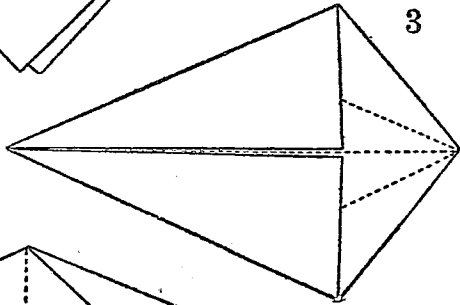
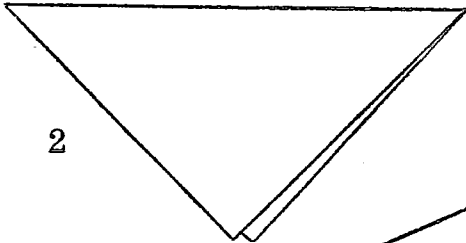
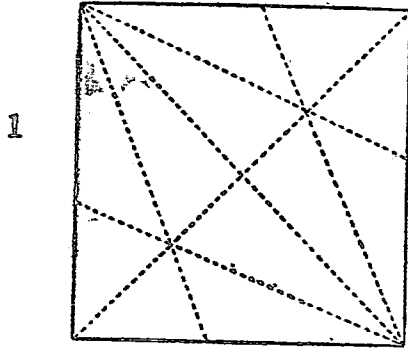

2. 虛線……是向內摺的記號，如圖例乙。
3. 粗黑線——是剪切記號，如圖例丙。
4. 粗黑陰線///是剪去部分，如圖例丁戊。

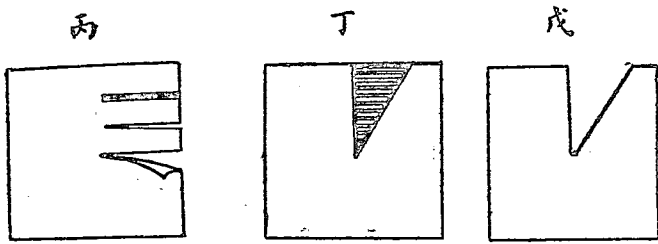

着色：摺成的東西，還可以着色，如鹿和孔雀，繪以美麗斑點，獅和牛，可着棕色，餘依此類推。着法可用水繪顏料薄塗淡彩便可。

二 獅的摺法

1 寫生圖

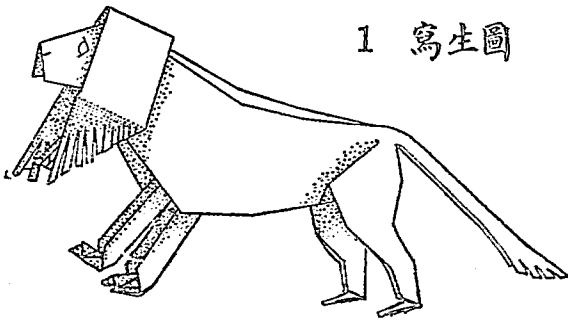

摺法順序

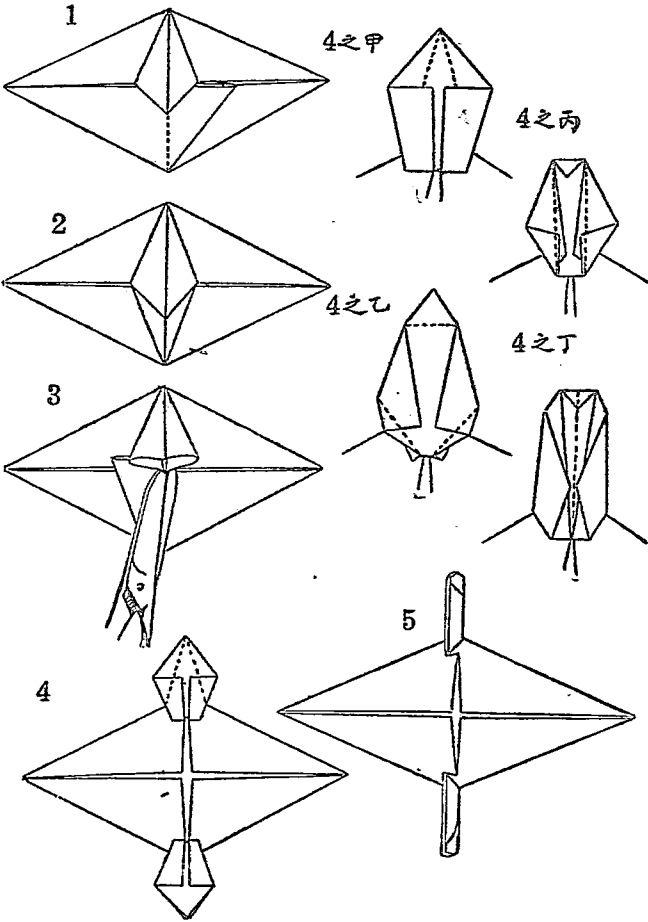

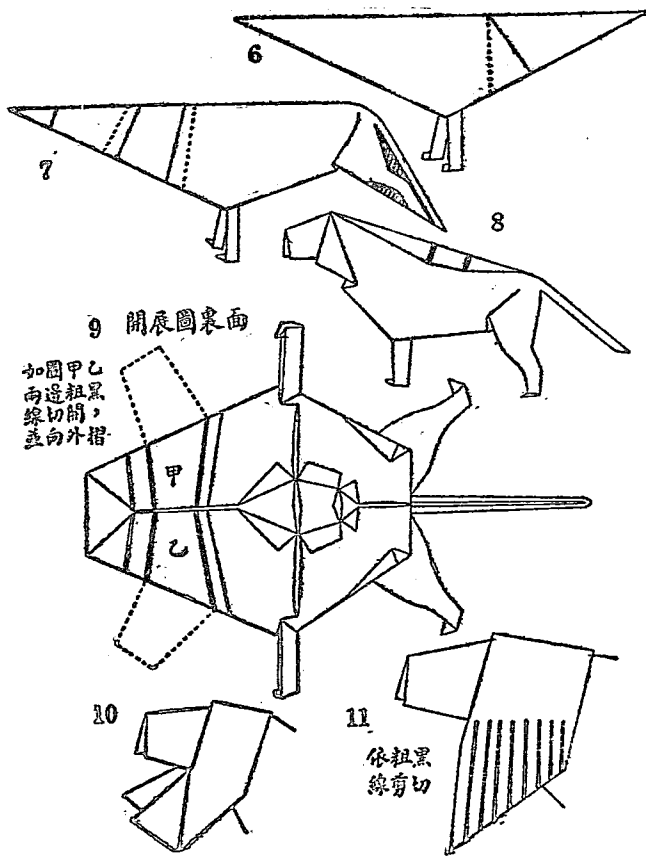

9 開展圖裏面
 如圖甲乙黑粗線切開，並向外摺

11 依粗黑線剪切

三 象的摺法

1 寫生圖

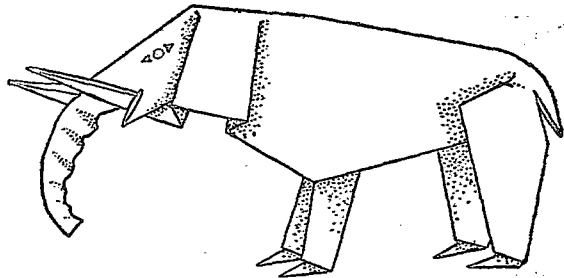

摺法順序

先照基本形摺法 1 2 3 4 摺好，
再如獅的摺法順序 1 2 3 4 各圖
摺疊，後照下列順序摺成。

前足摺法
圖例甲

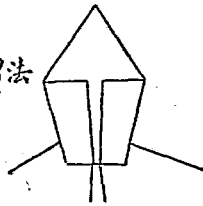

前足摺法
圖例乙

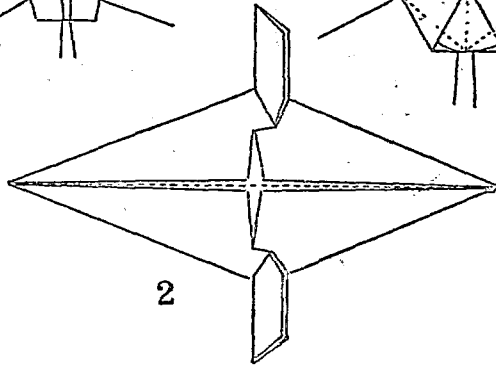
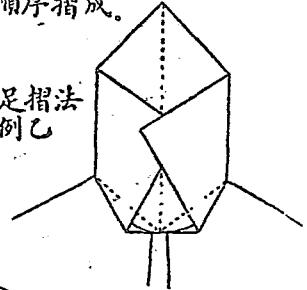

2

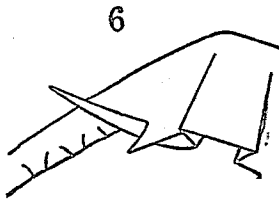
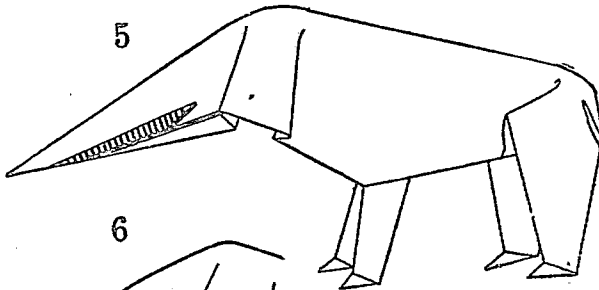
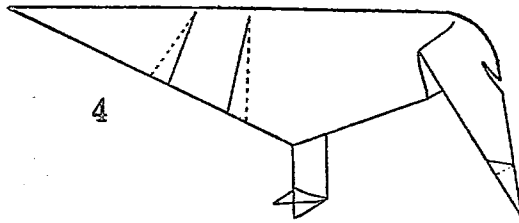
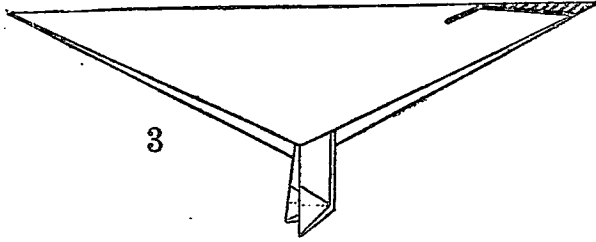

四 馬的摺法

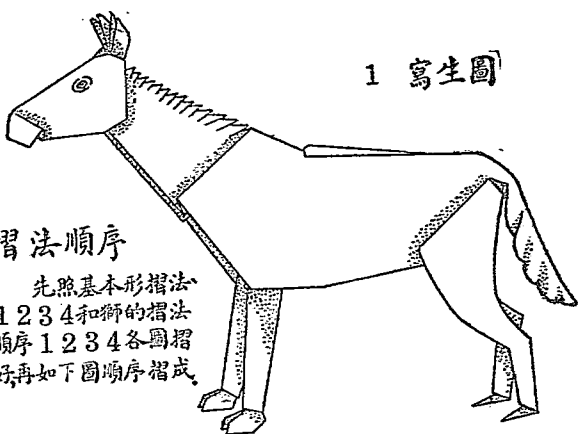

摺法順序

先照基本形摺法
 1 2 3 4和獅的摺法
 順序 1 2 3 4各圖摺
 好再如下圖順序摺成。

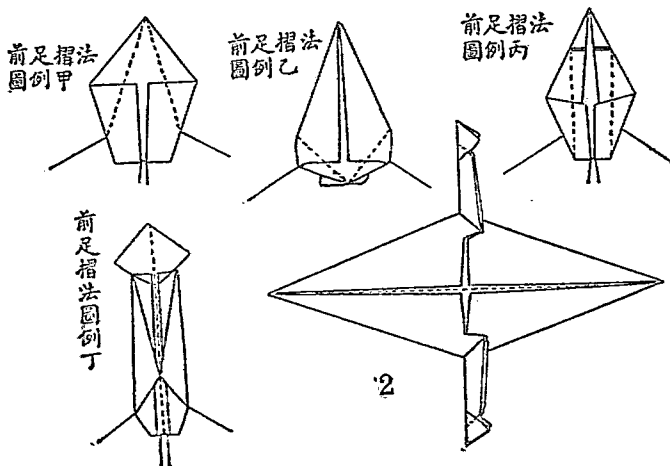

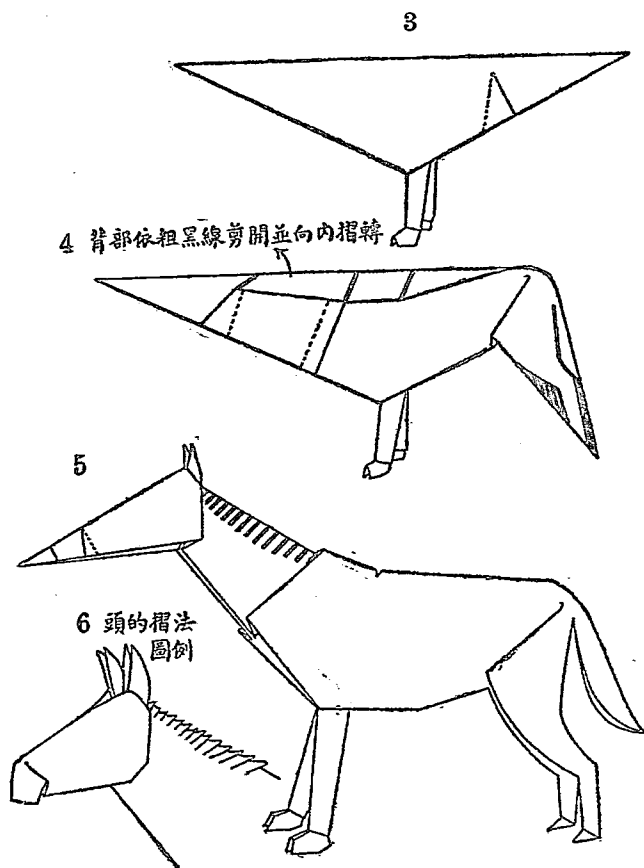

五 牛的摺法

1 寫生圖

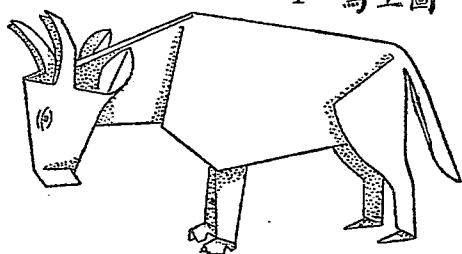

摺法順序

先照基本形摺法 1 2 3 4 和
獅的摺法順序 1 2 3 4 各圖摺好，再依下圖順序摺成。

前足摺法
圖例甲

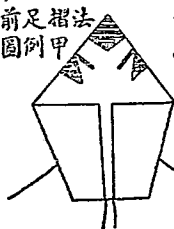

前足摺法
圖例乙

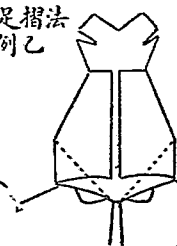

前足摺法
圖例丙

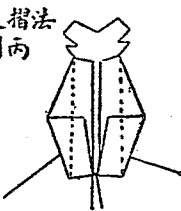

前足摺法
圖例丁

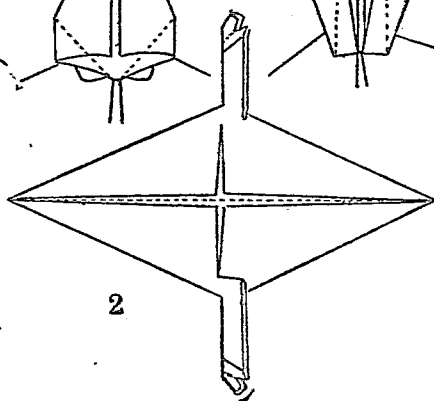
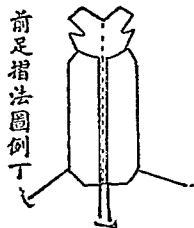

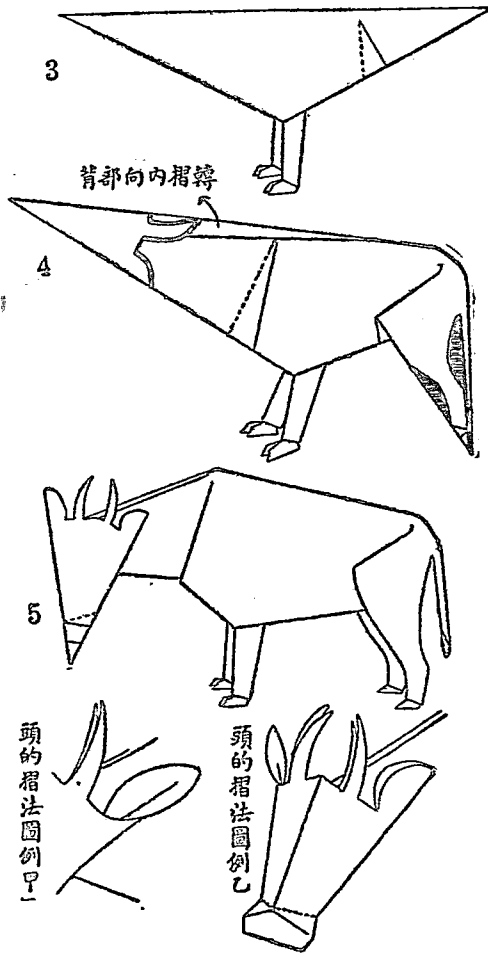

六 鹿的摺法

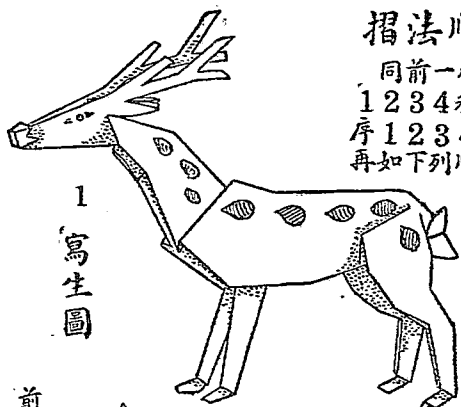

摺法順序
 同前一樣照基本摺法
 1 2 3 4 和獅的摺法順
 序 1 2 3 4 各圖先摺好
 再如下列順序圖摺成。

前足摺法圖例甲

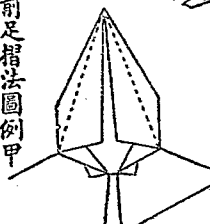

前足摺法圖例乙

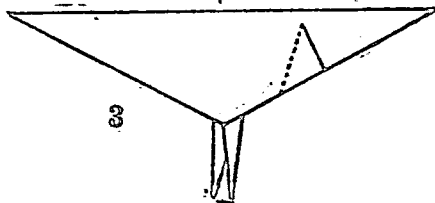
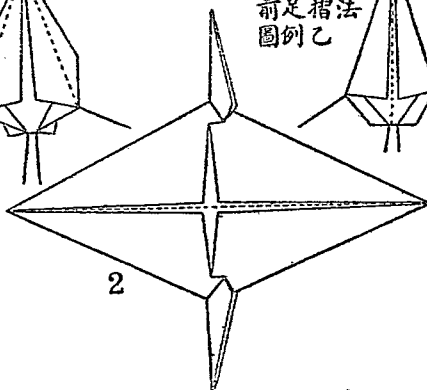
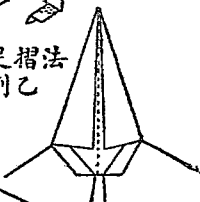

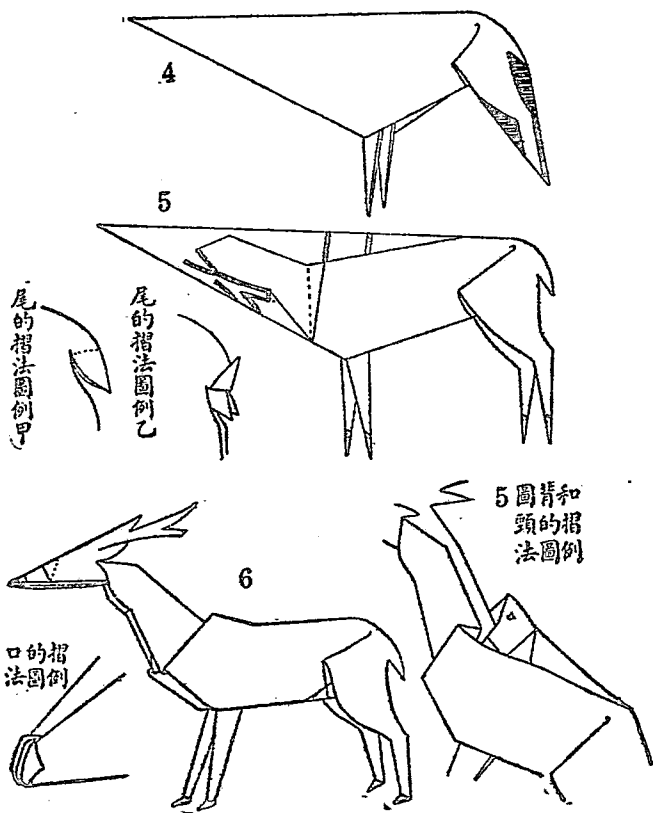

七 狗的摺法

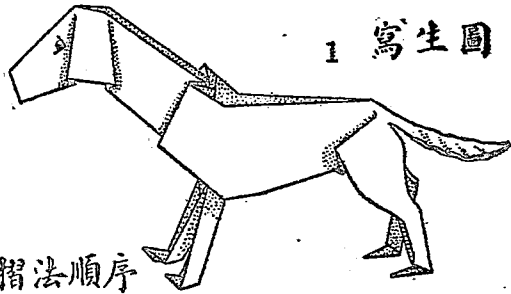

摺法順序

如前法一樣照基本摺法和獅的摺法順序
1 2 3 4 各圖先摺好再如下圖順序摺成。

前足摺法圖例甲

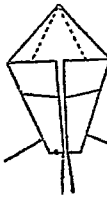

前足摺法圖例乙



前足摺法圖例丙



前足摺法圖例丁

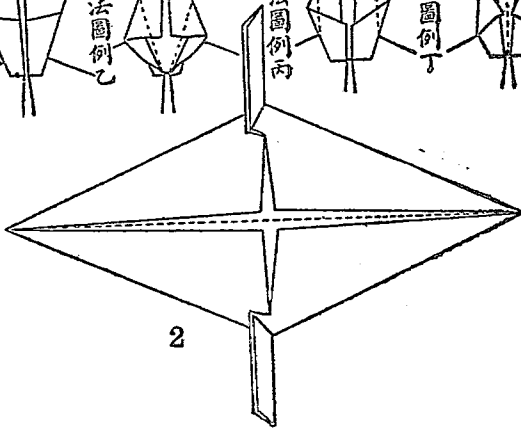
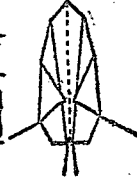

2

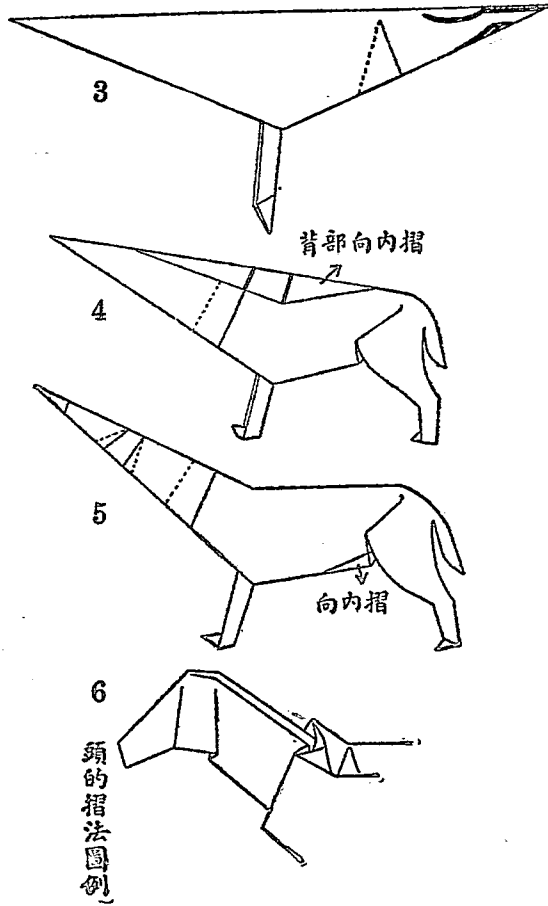

八 狐的摺法

摺法同狗的摺法順序一樣，摺至第三圖，再依下面圖例剪摺頭背尾各部便成。

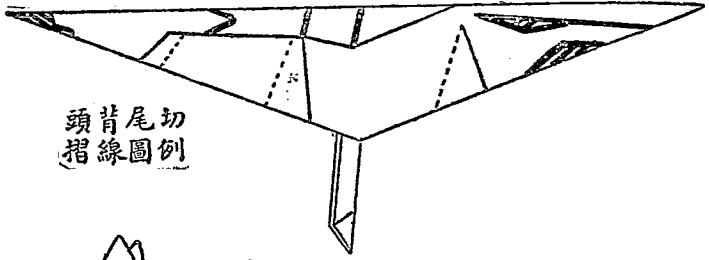

頭背尾切
摺線圖例

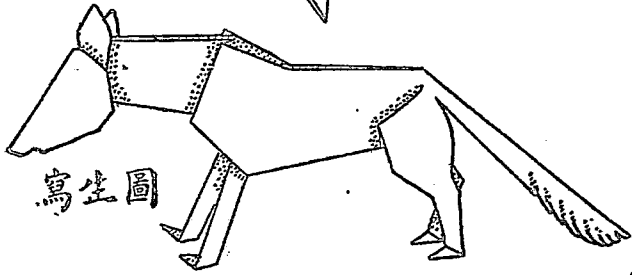

寫生圖

九 松鼠的摺法

摺法順序

先照基本摺法 1 2
3 4 各圖摺好，再依
下面的順序圖摺成。



1 寫生圖

2

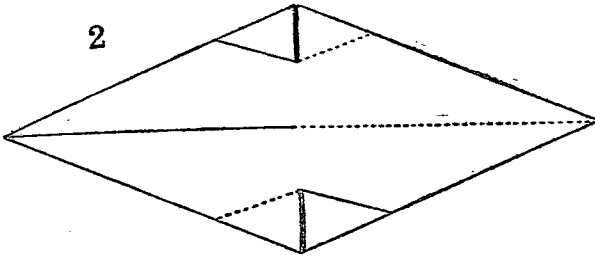

3

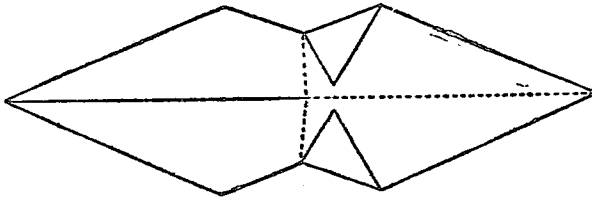

4

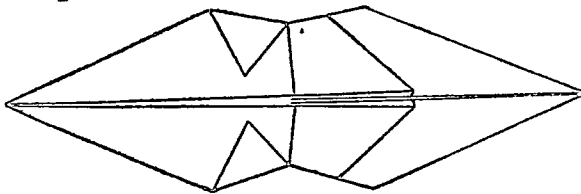

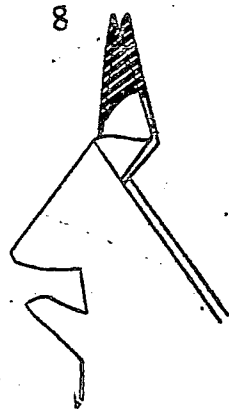
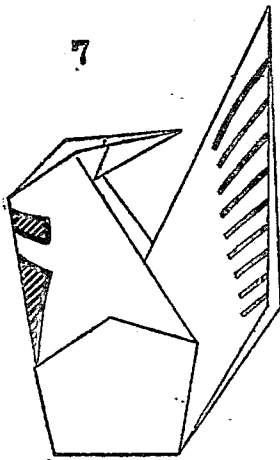
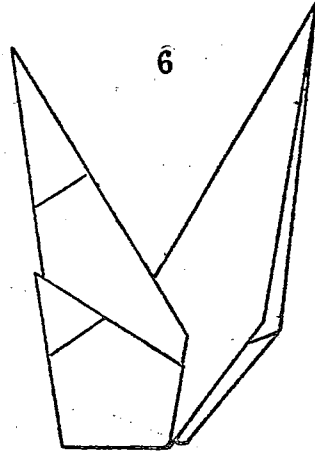
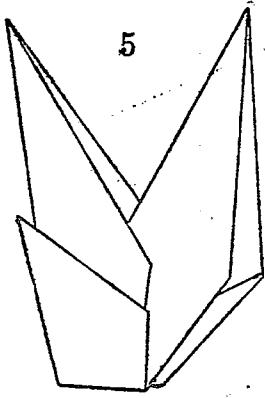

十 老鼠的摺法

寫生圖

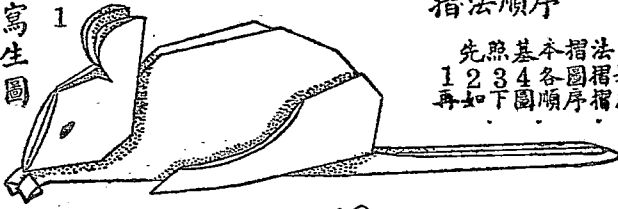

摺法順序

先照基本摺法
1 2 3 4 各圖摺好
再如下圖順序摺成

2

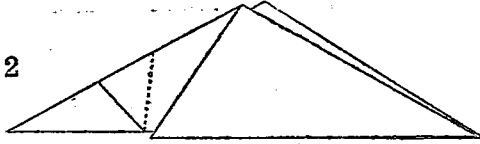

3

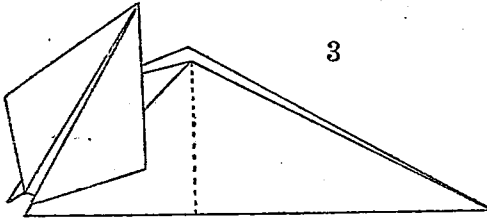

5

頸的摺法圖例

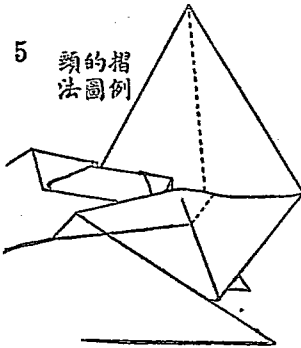

4

頭的反面摺痕圖例

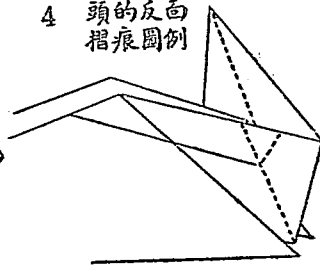

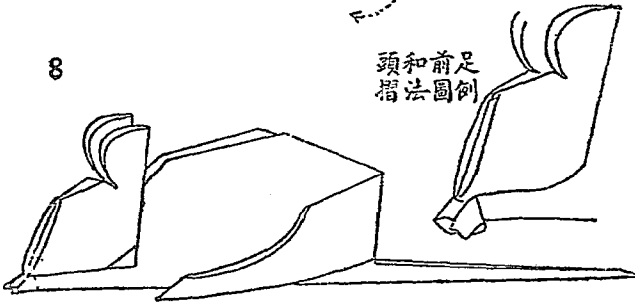
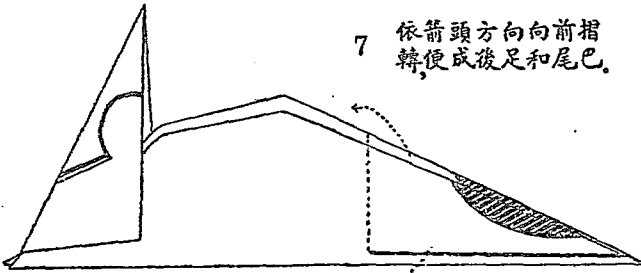
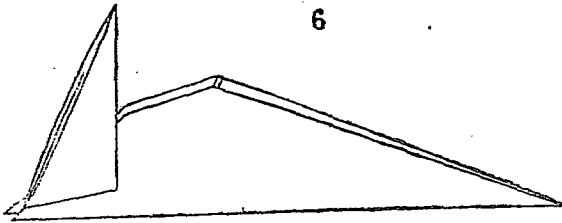

十一 兔的摺法

1 寫生圖

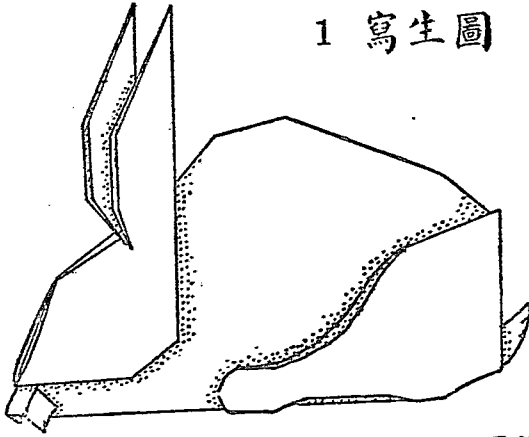

摺法順序 先照基本摺法 1 2 3 4 各圖摺好,再如下圖順序摺成。

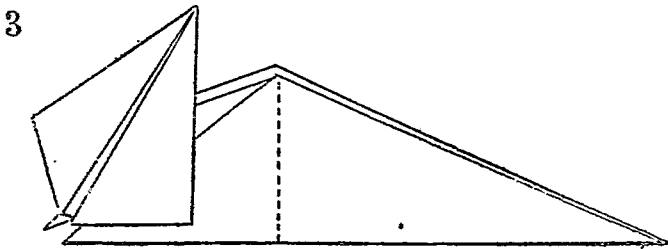
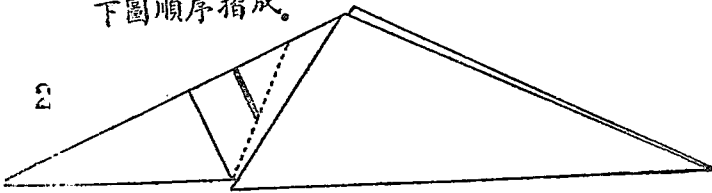

4 頸向內摺

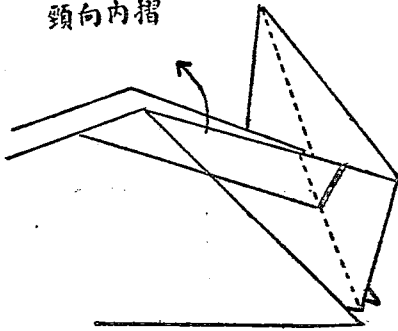

5

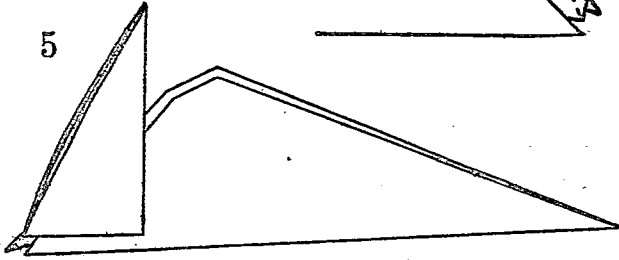

6 後足向前方向摺

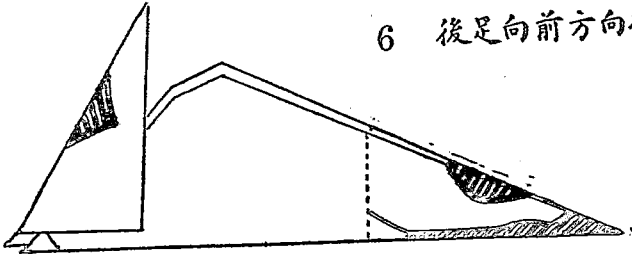

7

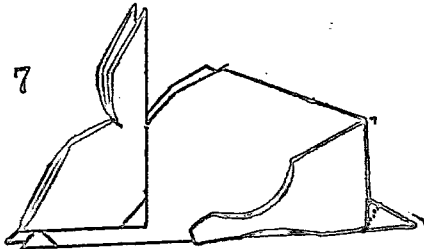

十二 鵝的摺法

摺法順序
 先照基本摺
 法1234各
 圖摺好再如
 圖順序摺成

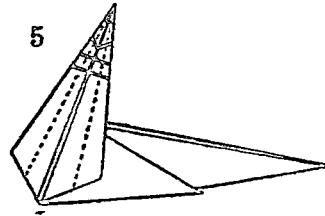
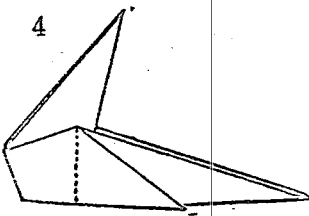
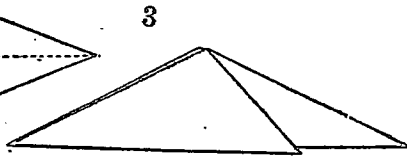
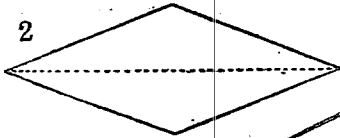
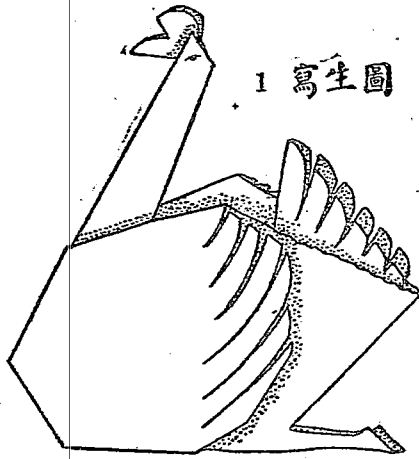

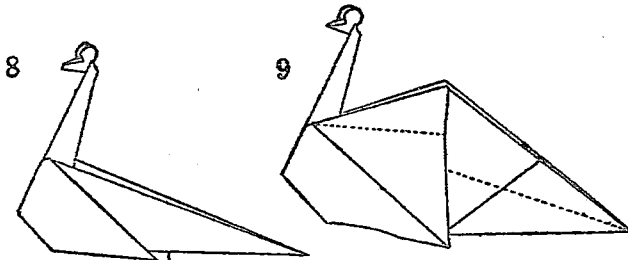
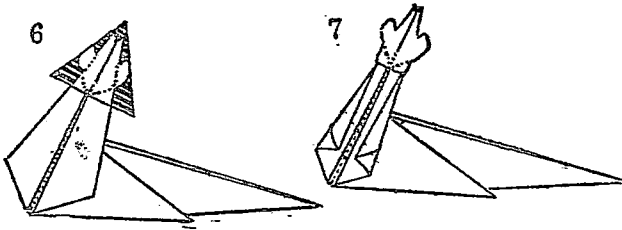

將內層紙
向外展出
便如9圖

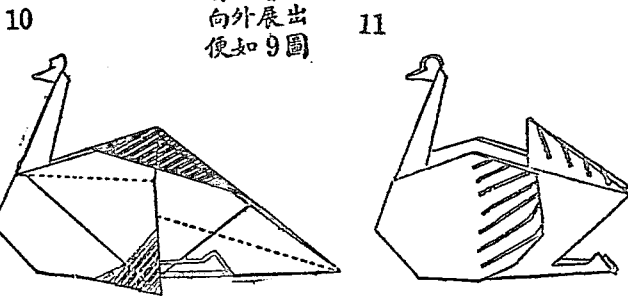

十三 孔雀的摺法

摺法順序

先照基本摺法1
2 3 4各圖摺好再
如下圖順序摺成。

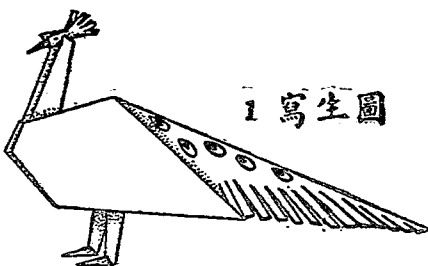

2

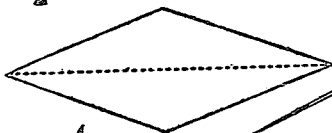

3



4

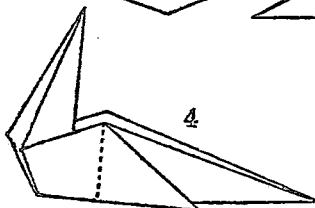

5

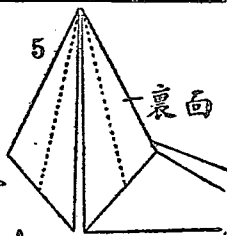

6

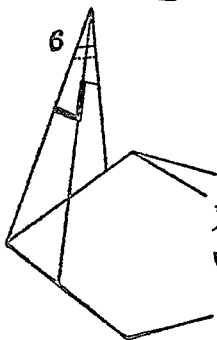

7

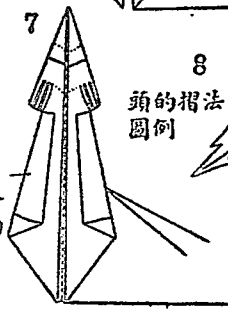

8

頭的摺法
圖例



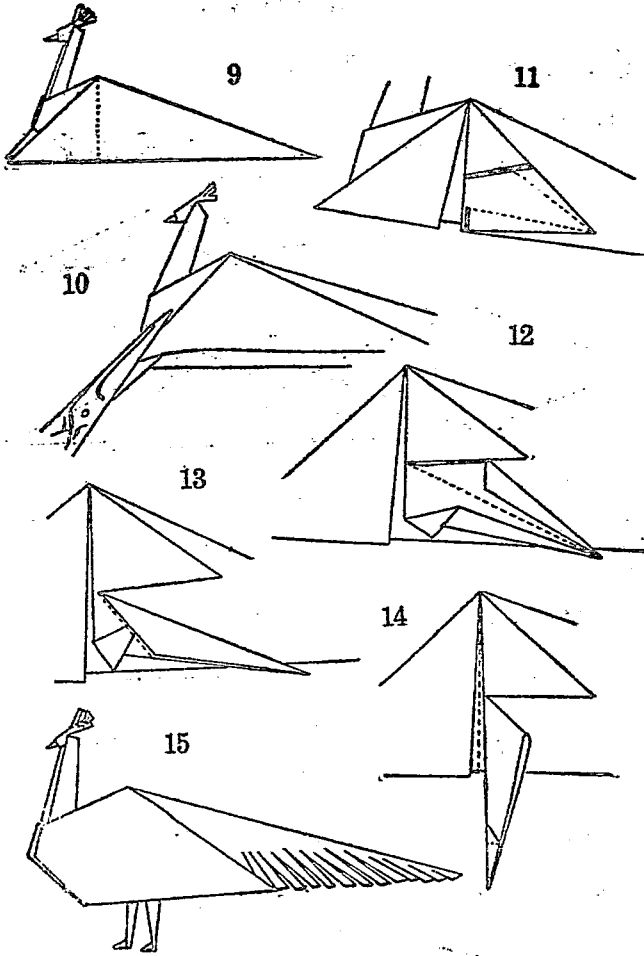

十四 鷹的摺法

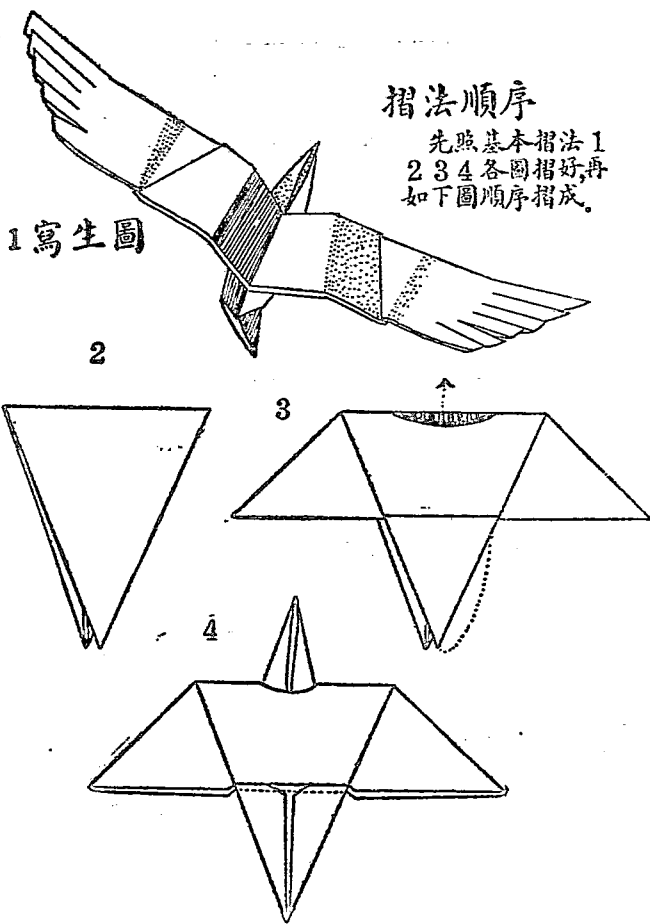

5

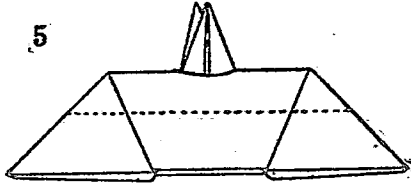

6

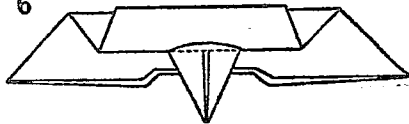

7

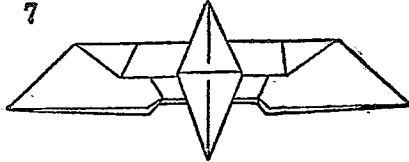

8

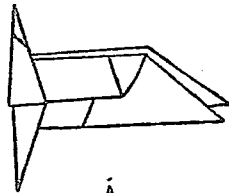

9

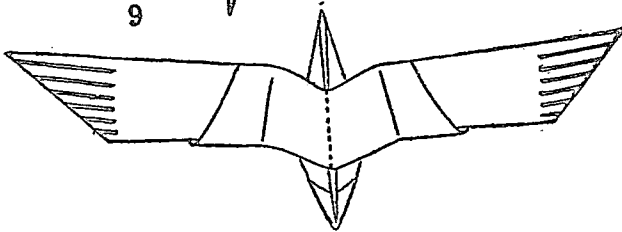

十五 燕的摺法

1. 寫生圖

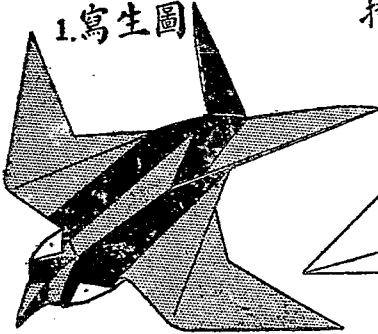

摺法順序

先照基本摺法 1 2
 3 4 各圖摺好，再
 如下圖順序摺成。

2

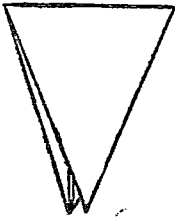

3

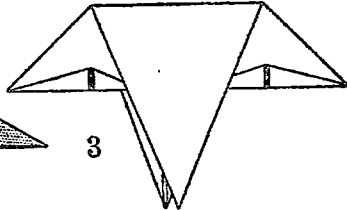

5

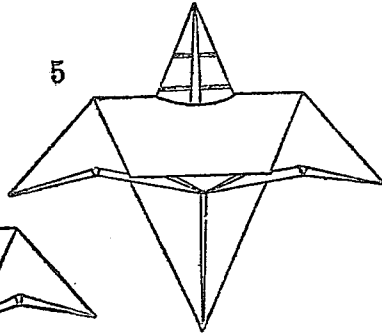

4

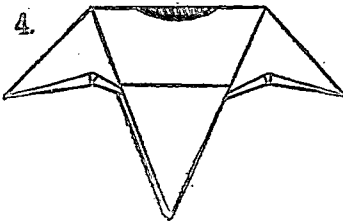

頭的摺法圖例甲

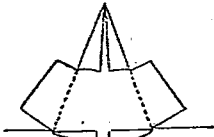

頭的摺法圖例乙

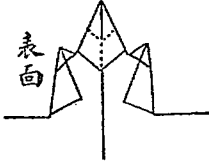

頭的摺法圖例丙

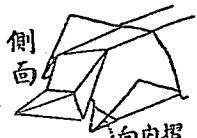

頭的摺法圖例丁

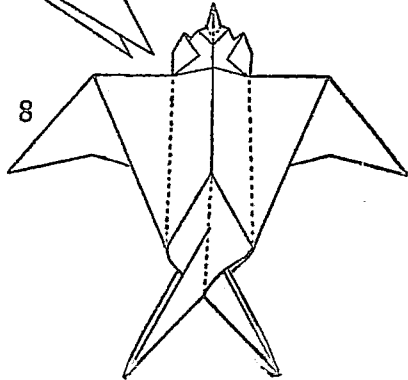
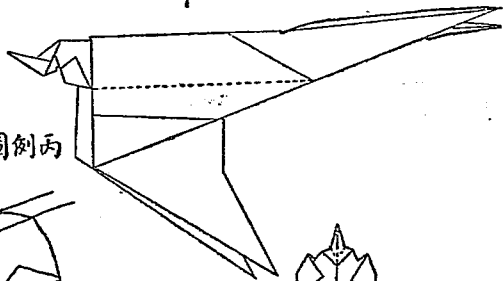
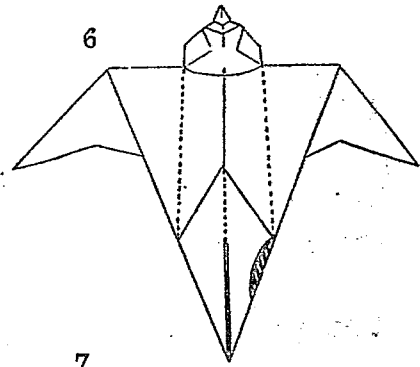
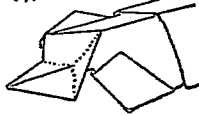

十六 草蟲的摺法

摺法順序 先照基本
形摺法 1 2 3 4 各圖摺
好，再如下圖順序摺成。

1
寫
生
圖

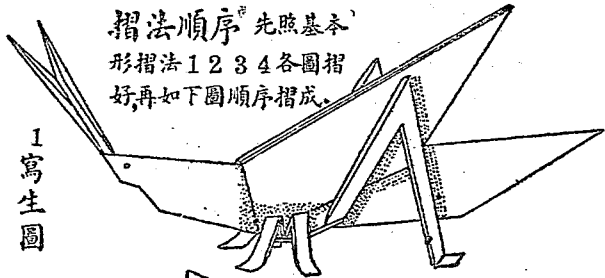

2

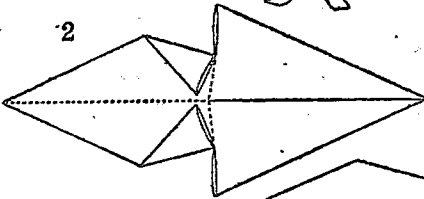

3

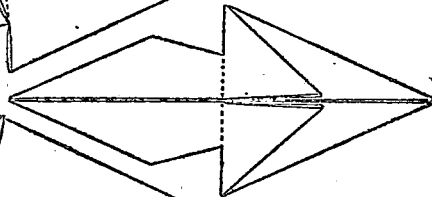

4

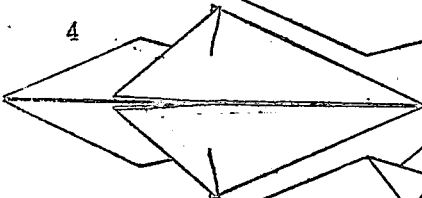

5

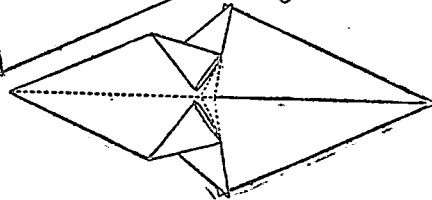

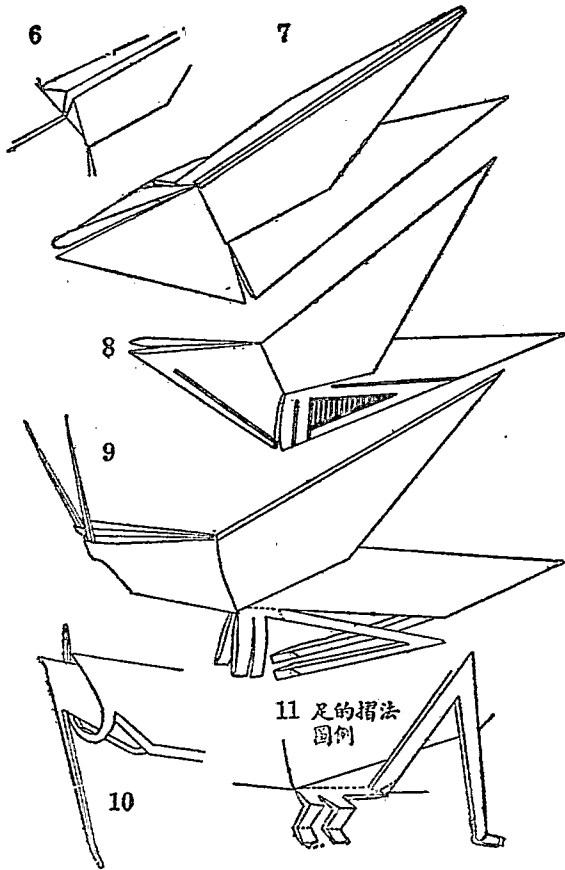

中華民國二十七年七月初版

◎◎◎◎◎◎◎◎◎◎◎◎
◎ 有 所 權 版 ◎
◎ 究 必 印 翻 ◎
◎◎◎◎◎◎◎◎◎◎◎◎

小學勞作叢書 (CROSS)
(工藝類) 新法摺紙玩具一冊

每冊實價國幣壹角貳分

外埠酌加運費匯費

編著者 陸 崧 安

發行人 王 雲 五
長沙南正路

印刷所 商 務 印 書 館
長沙南正路

發行所 商 務 印 書 館
各埠

(本書校對者潘同會)

F二九五三上

